

2021 FORD BRONCO Owner's Manual



Preproduction model with optional and aftermarket equipment shown.



The information contained in this publication was correct at the time of going to print. In the interest of continuous development, we reserve the right to change specifications, design or equipment at any time without notice or obligation. No part of this publication may be reproduced, transmitted, stored in a retrieval system or translated into any language in any form by any means without our written permission. Errors and omissions excepted.

© Ford Motor Company 2021

All rights reserved.

Part Number: 202101 20210412183626

California Proposition 65



WARNING: Operating, servicing and maintaining a passenger vehicle or off-highway motor vehicle can expose you to chemicals including engine exhaust, carbon monoxide, phthalates, and lead, which are known to the State of California to cause cancer and birth defects or other reproductive harm. To minimize exposure, avoid breathing exhaust, do not idle the engine except as necessary, service your vehicle in a well-ventilated area and wear gloves or wash your hands frequently when servicing your vehicle. For more information go to www.P65Warnings.ca.gov/passenger-vehicle.



WARNING: Battery posts, terminals and related accessories contain lead and lead compounds, chemicals known to the State of California to cause cancer and reproductive harm.
Wash your hands after handling.

Table of Contents

Contacting Us

Contacting Us	15
---------------------	----

Introduction

About This Publication	17
Using This Publication	18

Symbols Glossary

Symbols Used on Your Vehicle	19
------------------------------------	----

Data Privacy

Data Privacy	22
Service Data	23
Event Data	23
Settings Data	24
Connected Vehicle Data	24
Mobile Device Data	25
Emergency Call System Data	25

Visual Search

Steering Wheel - Vehicles With: Cruise Control, Vehicles Without: Lane Keeping Aid	26
Steering Wheel - Vehicles With: Adaptive Cruise Control	27
Steering Wheel - Vehicles With: Cruise Control/Lane Keeping Aid	28
Instrument Panel	29
Center Console - Manual Transmission	30
Center Console - Automatic Transmission	31
Vehicle Interior - 2-Door	32
Vehicle Interior - 4-Door	33
Front Exterior - 2-Door	34
Front Exterior - 4-Door, Vehicles With: Hard Top	35
Front Exterior - 4-Door, Vehicles With: Soft Top	36
Rear Exterior - 2-Door	37

Rear Exterior - 4-Door, Vehicles With: Hard Top	38
Rear Exterior - 4-Door, Vehicles With: Soft Top	39

Child Safety

Child Safety Precautions	40
Child Restraint Anchor Points	41
Child Restraints	42
Installing Child Restraints	44
Booster Seats	48
Child Safety Locks	50

Seatbelts

Seatbelt Precautions	52
Fastening and Unfastening the Seatbelts	53
Sensitive Locking Mode	53
Automatic Locking Mode	54
Adjusting the Seatbelts During Pregnancy	54
Seatbelt Reminder	54
Checking the Seatbelts	56
Seatbelt Extensions	57

Personal Safety System™

What Is the Personal Safety System	58
How Does the Personal Safety System Work	58
Personal Safety System Components	58

Airbags

How Do the Front Airbags Work	59
How Do the Side Airbags Work	59
How Does the Safety Canopy™ Work	60
Airbag Precautions	61
Properly Adjusting the Driver and Front Passenger Seats	62
Children and Airbags	62

Table of Contents

Front Passenger Sensing System	63
Crash Sensors and Airbag Indicator	66
Disposing of Airbags	67

911 Assist

What Is 911 Assist	68
Emergency Call Requirements	68
Emergency Call Limitations	68

Keys and Remote Controls

Remote Control Limitations	69
Using the Remote Control	69
Removing the Key Blade	70
Sounding the Panic Alarm	70
Locating Your Vehicle	70
Changing the Remote Control Battery	70
Replacing a Lost Key or Remote Control	71
Programming the Remote Control	72
Keys and Remote Controls – Troubleshooting	73

MyKey™

What Is MyKey	74
MyKey Settings	74
Creating a MyKey	75
Programming a MyKey	75
Clearing All MyKeys	75
Checking MyKey System Status	76
Using MyKey With Remote Start Systems	76
MyKey – Troubleshooting	76

Doors and Locks

Operating the Doors From Outside Your Vehicle	78
Operating the Doors From Inside Your Vehicle	78
Autounlock	78
Autolock	79

Mislock	79
Doors and Locks – Troubleshooting	79

Keyless Entry

Keyless Entry Limitations	82
Keyless Entry Settings	82
Using Keyless Entry	82
Keyless Entry – Troubleshooting	83

Tailgate

Opening the Tailgate	84
Closing the Tailgate	84
Locking and Unlocking the Tailgate	84
Tailgate – Troubleshooting	86

Security

Passive Anti-Theft System	87
Security – Troubleshooting	87

Steering Wheel

Adjusting the Steering Wheel	89
Horn	89
Switching the Heated Steering Wheel On and Off	89

Wipers and Washers

Wipers	90
Switching the Rear Window Wiper On and Off	90
Reverse Wipe	90
Checking the Wiper Blades	91
Replacing the Front Wiper Blades	91
Replacing the Rear Wiper Blades	92
Washers	92
Wipers and Washers – Troubleshooting	93

Exterior Lighting

Exterior Lighting Control	94
---------------------------------	----

Table of Contents

Headlamps	94	Fuel Gauge	106
Headlamps – Troubleshooting	94	What Is the Engine Coolant Temperature Gauge	107
Autolamps	95	What Is the Transmission Fluid Temperature Gauge	107
Exterior Lamps	95	What Is the Turbo Boost Gauge – 2.3L EcoBoost™	107
Exterior Zone Lighting	97	What Is the Information Bar	107
Automatic High Beam Control	98	What Are the Instrument Cluster Warning Lamps	107
Automatic High Beam Control – Troubleshooting	100	Instrument Cluster Warning Lamps	108
Interior Lighting		What Are the Instrument Cluster Indicators	109
Switching All of the Interior Lamps On and Off	101	Instrument Cluster Indicators	109
Switching the Front Interior Lamps On and Off	101	Instrument Cluster Display	
Switching the Rear Interior Lamps On and Off	101	Using the Instrument Cluster Display Controls	112
Interior Lamp Function	101	Instrument Cluster Display Main Menu	112
Adjusting the Instrument Panel Lighting Brightness	102	Trip Computer	113
Ambient Lighting	102	Personalized Settings	113
Interior Lighting – Troubleshooting	102		
Windows		Remote Start	
Opening and Closing the Windows	103	What Is Remote Start	114
Window Bounce-Back	103	Remote Start Precautions	114
Locking the Rear Window Controls	103	Remote Start Limitations	114
Interior Mirror		Enabling Remote Start	114
Interior Mirror Precautions	104	Remotely Starting and Stopping the Vehicle	114
Manually Dimming the Interior Mirror	104	Remote Start Remote Control Indicators	115
Auto-Dimming Interior Mirror	104	Remote Start Settings	115
Exterior Mirrors		Climate Control - Vehicles With: Automatic Temperature Control	
Adjusting the Exterior Mirrors	105	Identifying the Climate Control Unit	117
Folding the Exterior Mirrors	105	Switching Climate Control On and Off	117
Instrument Cluster		Switching Recirculated Air On and Off	117
Instrument Cluster Overview	106		
What Is the Tachometer	106		
What Is the Speedometer	106		

Table of Contents

Switching Air Conditioning On and Off	117
Switching Maximum Defrost On and Off	117
Switching Maximum Cooling On and Off	117
Switching the Heated Rear Window On and Off	118
Switching the Heated Mirrors On and Off	118
Setting the Blower Motor Speed	118
Setting the Temperature	118
Directing the Flow of Air	118
Auto Mode	119
Climate Control Hints	120

Climate Control - Vehicles With: Manual Temperature Control

Identifying the Climate Control Unit	122
Switching Climate Control On and Off	122
Switching Recirculated Air On and Off	122
Switching Air Conditioning On and Off	122
Switching Maximum Defrost On and Off	122
Switching Maximum Cooling On and Off	122
Switching the Heated Rear Window On and Off	122
Switching the Heated Mirrors On and Off	123
Setting the Blower Motor Speed	123
Setting the Temperature	123
Directing the Flow of Air	123
Climate Control Hints	124

Interior Air Quality

What Is the Cabin Air Filter	125
Replacing the Cabin Air Filter	125

Front Seats

Front Seat Precautions	126
Sitting in the Correct Position	126
Manual Seats	127
Power Seats	129
Heated Seats	132

Rear Seats

Manual Seats	133
--------------------	-----

Rear Occupant Alert System

What is the Rear Occupant Alert System	136
How Does the Rear Occupant Alert System Work	136
Rear Occupant Alert System Precautions	136
Rear Occupant Alert System Limitations	136
Switching Rear Occupant Alert System On and Off	136
Rear Occupant Alert System Indicators	137
Rear Occupant Alert System Audible Warnings	137

Garage Door Opener

What Is the Garage Door Opener	138
How Does the Garage Door Opener Work	138
Garage Door Opener Precautions	138
Garage Door Opener Limitations	138
Programming the Garage Door Opener to Your Hand-Held Transmitter	139
Programming the Garage Door Opener to Your Garage Door Opener Motor	139
Programming the Garage Door Opener to Your Gate Opener Motor	140
Clearing the Garage Door Opener	140

Table of Contents

Reprogramming the Garage Door Opener	141
Garage Door Opener Radio Frequencies	141

USB Ports

Locating the USB Ports	142
Playing Media Using the USB Port	142
Charging a Device	143

Power Outlet - Vehicles With: 120V Power Outlet

What Is the Power Outlet	144
Power Outlet Precautions	144
Locating the Power Outlet	144
Power Outlet Indicators	144

Power Outlet - Vehicles With: 12V Power Outlet

What Is the Power Outlet	146
Power Outlet Precautions	146
Locating the Power Outlet	146

Wireless Accessory Charger

What Is the Wireless Accessory Charger	147
Wireless Accessory Charger Precautions	147
Locating the Wireless Accessory Charger	147
Charging a Wireless Device	148
Wireless Accessory Charger – Troubleshooting	148

Storage

Glove Compartment	149
Center Console	149
Under Floor Storage	150
Glasses Holder	150
Map Pocket	150

Starting and Stopping the Engine

Starting and Stopping the Engine – Precautions	151
Push Button Ignition Switch	151
Starting the Engine	152
Engine Block Heater	153
Stopping the Engine	154
Automatic Engine Stop	155
Accessing the Passive Key Backup Position	156
Starting and Stopping the Engine – Troubleshooting	156

Start in Gear - Manual Transmission

What Is Start in Gear	159
Start in Gear Precautions	159
Start in Gear Limitations	159
Using Start in Gear	159
Start in Gear – Troubleshooting	160

Auto-Start-Stop

What Is Auto-Start-Stop	161
Auto-Start-Stop Precautions - Manual Transmission	161
Auto-Start-Stop Precautions - Automatic Transmission	161
Switching Auto-Start-Stop On and Off	161
Stopping the Engine - Manual Transmission	161
Stopping the Engine - Automatic Transmission	162
Restarting the Engine - Manual Transmission	162
Restarting the Engine - Automatic Transmission	163
Auto-Start-Stop Indicators	163
Auto-Start-Stop – Troubleshooting	163

Table of Contents

Fuel and Refueling

Fuel and Refueling Precautions	166
Fuel Quality	167
Locating the Fuel Filler Funnel	167
Running Out of Fuel	168
Refueling	169
Fuel Tank Capacity	171
Fuel and Refueling – Troubleshooting	171

Catalytic Converter

What Is the Catalytic Converter	173
Catalytic Converter Precautions	173
Catalytic Converter – Troubleshooting	173

Manual Transmission

Manual Transmission Precautions	174
Shifting Into Reverse	174
Crawler Gear	174
Recommended Shift Speeds	175
Checking the Manual Transmission Fluid Level	176
Checking the Clutch Fluid Level	176
Manual Transmission Fluid Capacity and Specification	176
Clutch Fluid Capacity and Specification	176
Manual Transmission – Troubleshooting	177

Automatic Transmission

Automatic Transmission Precautions	178
Automatic Transmission Positions	178
Shifting Your Vehicle Into Gear	179
Automatic Transmission Position Indicators	179
Manually Shifting Gears	180
Brake Shift Interlock	180

Automatic Transmission Audible Warnings	181
---	-----

Four-Wheel Drive

How Does Four-Wheel Drive Work - 4x4 with Part Time Engagement	182
How Does Four-Wheel Drive Work - Advanced 4x4 with 4A Mode	182
Four-Wheel Drive Precautions	182
Four-Wheel Drive Limitations	183
Switching Four-Wheel Drive On and Off	184
Selecting a Four-Wheel Drive Mode - 4x4 with Part Time Engagement	185
Selecting a Four-Wheel Drive Mode - Advanced 4x4 with 4A Mode	186
Four-Wheel Drive Modes	186
Four-Wheel Drive Indicators	187
Transfer Case Fluid Capacity and Specification	187
Four-Wheel Drive – Troubleshooting	187

Electronic Locking Differential

What Is the Electronic Locking Differential	190
Switching the Electronic Locking Differential On and Off	190
Electronic Locking Differential Indicators	191
Electronic Locking Differential – Troubleshooting	192

Brakes

Brake Precautions	194
Anti-Lock Braking System	194
Brake Over Accelerator	194
Locating the Brake Fluid Reservoir - 2.3L EcoBoost™	194
Locating the Brake Fluid Reservoir - 2.7L EcoBoost™	194
Checking the Brake Fluid	194

Table of Contents

Brake Fluid Specification	195	Stability Control Indicator	206
Brakes – Troubleshooting	195		
Electric Parking Brake		Trail Control	
What Is the Electric Parking Brake	198	What Is Trail Control	207
Applying the Electric Parking Brake	198	Trail Control Limitations	207
Applying the Electric Parking Brake in an Emergency	198	Switching Trail Control On and Off	207
Manually Releasing the Electric Parking Brake	198	Setting the Trail Control Speed	207
Automatically Releasing the Electric Parking Brake	198	Canceling the Set Speed	208
Electric Parking Brake Audible Warning	199	Trail Control Indicators	208
Releasing the Electric Parking Brake if the Vehicle Battery Has Run Out of Charge	199	Trail One Pedal Drive	208
Electric Parking Brake – Troubleshooting	199	Trail One Pedal Drive – Troubleshooting	210
		Trail Control – Troubleshooting	211
Hill Start Assist		Trail Turn Assist	
What Is Hill Start Assist	201	What Is Trail Turn Assist	212
How Does Hill Start Assist Work	201	Trail Turn Assist Precautions	212
Hill Start Assist Precautions	201	Trail Turn Assist Limitations	212
Switching Hill Start Assist On and Off - Manual Transmission	201	Switching Trail Turn Assist On and Off	212
Switching Hill Start Assist On and Off - Automatic Transmission	201	Trail Turn Assist Indicators	212
Hill Start Assist – Troubleshooting	201	Trail Turn Assist – Troubleshooting	213
		Stabilizer Bar Disconnect	
Traction Control		What Is the Stabilizer Bar Disconnect	214
What Is Traction Control	202	Stabilizer Bar Disconnect Precautions	214
How Does Traction Control Work	202	Switching the Stabilizer Bar Disconnect On and Off	214
Switching Traction Control On and Off	202	Stabilizer Bar Disconnect Indicators	215
Traction Control Indicator	202	Stabilizer Bar Disconnect – Troubleshooting	215
Traction Control – Troubleshooting	203		
		Hill Descent Control - Manual Transmission	
Stability Control		What Is Hill Descent Control	217
How Does Stability Control Work	204	How Does Hill Descent Control Work	217
Switching Stability Control On and Off	205	Hill Descent Control Precautions	217

Table of Contents

Switching Hill Descent Control On and Off	217
Setting the Hill Descent Speed	217
Hill Descent Control Indicator	217
Hill Descent Control – Troubleshooting	218

Steering

Electric Power Steering	219
Steering – Troubleshooting	220

Parking Aids

Parking Aid Precautions	222
Switching Parking Aid On and Off	222
Rear Parking Aid	223
Front Parking Aid	223
Parking Aid Indicators	225
Parking Aids – Troubleshooting	225

Rear View Camera

What Is the Rear View Camera	226
Rear View Camera Precautions	226
Locating the Rear View Camera	226
Rear View Camera Guide Lines	226
Rear View Camera Object Distance Indicators	227
Rear View Camera Settings	227

360 Degree Camera

What Is the 360 Degree Camera	229
How Does the 360 Degree Camera Work	229
360 Degree Camera Precautions	229
360 Degree Camera Limitations	229
Locating the 360 Degree Cameras	230
360 Degree Camera Guide Lines	230
360 Degree Camera Settings	231

Cruise Control

What Is Cruise Control	232
------------------------------	-----

Switching Cruise Control On and Off	232
Setting the Cruise Control Speed	232
Canceling the Set Speed	233
Resuming the Set Speed	233
Cruise Control Indicators	233

Adaptive Cruise Control

How Does Adaptive Cruise Control Work	234
Adaptive Cruise Control Precautions	234
Adaptive Cruise Control Limitations	235
Switching Adaptive Cruise Control On and Off	237
Setting the Adaptive Cruise Control Speed	237
Setting the Adaptive Cruise Control Gap	238
Canceling the Set Speed	239
Resuming the Set Speed	239
Overriding the Set Speed	239
Adaptive Cruise Control Indicators	240
Switching From Adaptive Cruise Control to Cruise Control	240
Adaptive Cruise Control – Troubleshooting	240

G.O.A.T. Mode Control

What Is G.O.A.T. Mode Control	242
How Does G.O.A.T. Mode Control Work	242
Selecting a G.O.A.T. Mode	242
G.O.A.T. Modes	243
G.O.A.T. Mode Control – Troubleshooting	246

Lane Keeping System

What Is the Lane Keeping System	249
How Does the Lane Keeping System Work	249

Table of Contents

Lane Keeping System Precautions	249	Switching Cross Traffic Alert On and Off	259
Lane Keeping System Limitations	249	Locating the Cross Traffic Alert Sensors	260
Switching the Lane Keeping System On and Off	250	Cross Traffic Alert Indicators	260
Switching the Lane Keeping System Mode	250	Cross Traffic Alert – Troubleshooting	261
Alert Mode	250		
Aid Mode	251		
Alert and Aid Mode	251		
Lane Keeping System Indicators	252		
Lane Keeping System – Troubleshooting	253		
Blind Spot Information System		Pre-Collision Assist	
What Is Blind Spot Information System	256	What Is Pre-Collision Assist	262
How Does Blind Spot Information System Work	256	How Does Pre-Collision Assist Work	262
Blind Spot Information System Precautions	256	Pre-Collision Assist Precautions	262
Blind Spot Information System Limitations	256	Pre-Collision Assist Limitations	263
Blind Spot Information System Requirements - Manual Transmission	256	Switching Pre-Collision Assist On and Off	264
Blind Spot Information System Requirements - Automatic Transmission	257	Locating the Pre-Collision Assist Sensors	264
Switching Blind Spot Information System On and Off	257	Distance Indication	264
Locating the Blind Spot Information System Sensors	257	Automatic Emergency Braking	266
Blind Spot Information System Indicators	258	Evasive Steering Assist	266
Blind Spot Information System – Troubleshooting	258	Pre-Collision Assist – Troubleshooting	267
Cross Traffic Alert		Driver Alert	
What Is Cross Traffic Alert	259	What Is Driver Alert	269
How Does Cross Traffic Alert Work	259	How Does Driver Alert Work	269
Cross Traffic Alert Precautions	259	Driver Alert Precautions	269
Cross Traffic Alert Limitations	259	Driver Alert Limitations	269
		Switching Driver Alert On and Off	270
		Driver Alert Indicators	270
		Driver Alert – Troubleshooting	270
		Load Carrying	
		Load Carrying Precautions	271
		Locating the Safety Compliance Certification Labels	272
		What Is the Gross Axle Weight Rating	272
		What Is the Gross Vehicle Weight Rating	272

Table of Contents

What Is the Maximum Loaded Trailer Weight	272
What Is the Gross Combined Weight Rating	272
Calculating Payload	274
Calculating the Load Limit	274
Roof Rack	276
Fender Anchor Points	279

Rear Cargo Area

Rear Cargo Area Anchor Points	280
-------------------------------------	-----

Connecting a Trailer

Connecting a Trailer Precautions	281
Connecting a Trailer	281
Connecting a Trailer – Troubleshooting	282

Towing a Trailer

Towing a Trailer Precautions	283
Trailer Brake Precautions	283
Towing a Trailer Limitations	284
Loading Your Trailer	284
Trailer Towing Hints	284
Launching or Retrieving a Boat or Personal Watercraft	285
Towing Weights and Dimensions	286
Towing a Trailer – Troubleshooting	287

Trailer Sway Control

How Does Trailer Sway Control Work	288
Trailer Sway Control Precautions	288
Switching Trailer Sway Control On and Off	288

Driving Hints

Off-Road Driving	289
Cold Weather Precautions	297
Breaking-In	297
Driving Economically	297

Floor Mats	298
------------------	-----

Crash and Breakdown Information

Roadside Assistance	299
Switching the Hazard Flashers On and Off	300
Jump Starting the Vehicle	300
Post-Crash Alert System	302
Automatic Crash Shutoff	302
Recovery Towing	303
Transporting the Vehicle	305

Towing Your Vehicle

Towing Your Vehicle Precautions	306
Recreationally Towing Your Vehicle - Manual Transmission	306
Recreationally Towing Your Vehicle - Automatic Transmission	307
Emergency Towing	309
Towing Your Vehicle – Troubleshooting	309

Fuses

Fuse Precautions	310
Under Hood Fuse Box	310
Body Control Module Fuse Box	314
Identifying Fuse Types	317
Fuses – Troubleshooting	317

Maintenance

Maintenance Precautions	318
Opening and Closing the Hood	318
Under Hood Overview - 2.3L EcoBoost™	319
Under Hood Overview - 2.7L EcoBoost™	320
Engine Oil	321
Checking the Coolant	322
Changing the Engine Air Filter	326
Changing the Fuel Filter	326

Table of Contents

Changing the 12V Battery	326
Adjusting the Headlamps	329
Exterior Bulbs	330
Interior Bulbs	332
Drive Belt Routing - 2.3L EcoBoost™	332
Drive Belt Routing - 2.7L EcoBoost™	333

Removable Vehicle Components

Removable Windows	334
Removable Doors	339
Removable Roof Panels	343
Removable Hard Top	347
Removable Soft Top	348
Removable Fenders	351
Storing the Doors and the Roof Panels - 4-Door	352
Storing the Roof Panels - 2-Door	359

Vehicle Care

Cleaning Products	360
Cleaning the Exterior	360
Cleaning the Interior	362
Repairing Minor Paint Damage	364
Waxing Your Vehicle	364

Storing Your Vehicle

Preparing Your Vehicle for Storage	366
Removing Your Vehicle From Storage	367

Wheel and Tire Information

Locating the Tire label	368
Department of Transportation Uniform Tire Quality Grades	368
Information on the Tire Sidewall	369
Glossary of Tire Terminology	374
Tire Replacement Requirements	375
Using Snow Chains	377

Tire Care

Checking the Tire Pressures	379
Inflating the Tires	379
Inspecting the Tire for Wear	380
Inspecting the Tire for Damage	380
Inspecting the Wheel Valve Stems	381
Tire Rotation	381

Tire Pressure Monitoring System

What Is the Tire Pressure Monitoring System	383
Tire Pressure Monitoring System Overview	383
Tire Pressure Monitoring System Precautions	384
Tire Pressure Monitoring System Limitations	384
Wiring the Tire Pressures	385
Tire Pressure Monitoring System - Troubleshooting	385

Changing a Road Wheel

Changing a Flat Tire	387
Wheel Nuts	392

Capacities and Specifications

Engine Specifications - 2.3L EcoBoost™	393
Engine Specifications - 2.7L EcoBoost™	394
Motorcraft Parts - 2.3L EcoBoost™	395
Motorcraft Parts - 2.7L EcoBoost™	396
Engine Oil Capacity and Specification - 2.3L EcoBoost™	397
Engine Oil Capacity and Specification - 2.7L EcoBoost™	398
Cooling System Capacity and Specification - 2.3L EcoBoost™	400
Cooling System Capacity and Specification - 2.7L EcoBoost™	401

Table of Contents

Fuel Tank Capacity	401	Playing or Pausing the Audio Source	414
Air Conditioning System Capacity and Specification	402	Adjusting the Volume	414
Washer Fluid Specification	402	Switching Shuffle Mode On and Off	415
Manual Transmission Fluid Capacity and Specification	403	Switching Repeat Mode On and Off	415
Clutch Fluid Capacity and Specification	403	Setting a Memory Preset	415
Automatic Transmission Fluid Capacity and Specification	403	Muting the Audio	415
Brake Fluid Specification	404	Adjusting the Sound Settings	415
Transfer Case Fluid Capacity and Specification	405	Setting the Clock and Date	415
Front Axle Fluid Capacity and Specification	405	AM/FM Radio	416
Rear Axle Fluid Capacity and Specification	406	Switching the Display On and Off	417
Vehicle Identification		Digital Radio	417
Vehicle Identification Number	408	Satellite Radio	418
Connected Vehicle		Audio System – Troubleshooting	421
What Is a Connected Vehicle	409	Identifying the Audio Unit	424
Connected Vehicle Requirements	409	Center Display Overview	
Connected Vehicle Limitations	409	Center Display Precautions	425
Connecting the Vehicle to a Mobile Network	409	Center Display Limitations	425
Connecting the Vehicle to a Wi-Fi Network	409	Status Bar	425
Connected Vehicle – Troubleshooting	410	Feature Bar	426
Vehicle Wi-Fi Hotspot		Information On Demand Screen - Vehicles With: 12.3 Inch Screen	427
Creating a Vehicle Wi-Fi Hotspot	412	Voice Interaction	
Changing the Vehicle Wi-Fi Hotspot Name or Password	412	What is Voice Interaction	428
Audio System		Setting the Wake Word	428
Audio System Precautions	414	Beginning a Voice Interaction	428
Switching the Audio Unit On and Off	414	Voice Interaction Examples	428
Selecting the Audio Source	414	Phone	
		Phone Precautions	431
		Connecting Your Phone	431
		Phone Menu	431
		Making and Receiving a Phone Call	433
		Sending and Receiving a Text Message	434
		Switching Text Message Notification On and Off	435

Table of Contents

Bluetooth®

Connecting a Bluetooth® Device	436
Playing Media Using Bluetooth®	436

Apps

App Precautions	437
App Requirements	437
Accessing Apps	437
Enabling Apps on an iOS Device	437
Enabling Apps on an Android Device	437
Switching Apple CarPlay On and Off	438
Switching Android Auto On and Off	438

Navigation

Accessing Navigation	440
Navigation Map Updates	440
Adjusting the Map	440
Live Traffic	440
Setting a Destination	440
Waypoints	441
Route Guidance	441

Vehicle System Updates

Updating the Vehicle Systems Wirelessly	443
Performing a Master Reset	444

Accessories

Accessories	445
-------------------	-----

Auxiliary Switches

What Are the Auxiliary Switches	447
Locating the Auxiliary Switches	447
Locating the Auxiliary Switch Wiring	447
Identifying the Auxiliary Switch Wiring	449

Ford Protect

What Is Ford Protect	450
----------------------------	-----

Scheduled Maintenance

General Maintenance Information	452
Normal Scheduled Maintenance	455
Special Operating Conditions Scheduled Maintenance	457

Customer Information

Rollover Warning	461
Our Sustainability Report	461
The Better Business Bureau Auto Line Program - United States of America	461
The Mediation and Arbitration Program - Canada	462
Ordering a Canadian French Owner's Manual	462
Reporting Safety Defects in the United States	463
Reporting Safety Defects in Canada	463
Radio Frequency Certification Labels	464
California Proposition 65 - United States of America	494
Perchlorate	495
Replacement Parts Recommendation	495
Mobile Communications Equipment	496
End User License Agreement	496
Emission Law	521
Export Unique Options	522

Appendices

Electromagnetic Compatibility	524
-------------------------------------	-----

Contacting Us

If you require assistance or clarification on policies or procedures, please contact the customer relationship center.

United States

Ford Motor Company
Customer Relationship Center
PO Box 6248
Dearborn, MI 48126
1-800-392-3673 (FORD)
(TDD for the hearing impaired:
1-888-658-6805
www.ford.com/help/contact/

Canada

Customer Relationship Center
Ford Motor Company of Canada Limited
P.O. Box 2000
Oakville, Ontario L6J 5E4
1-800-565-3673 (FORD)
www.ford.ca
Facebook: FordServiceCA (English),
FordServiceQC (Français)

Europe

Telephone: 02035644444
E-mail: UKCRC1@ford.com
Twitter: @forduk

Australia

Ford Motor Company
Attention: Customer Relationship Centre
Private Mail Bag 5
Fairlane Business Park #3
Campbellfield, Victoria, 3061
Telephone: 13 3673 (FORD)
E-mail: foacust1@ford.com

New Zealand

Ford Motor Company
Attention: Customer Relationship Centre
Private Bag 76912
Manukau City 2241
Telephone: 0800 367 369 (FORDNZ)
E-mail: fnzcust@ford.com

China - Imported Vehicle

Customer Relationship Center
Telephone: 400-690-1886
Website: <https://www.ford.com.cn/>

China - Chang'An Ford

Customer Relationship Center
Telephone: 800-810-8168
Mobile: 400-887-7766
Website: <https://www.ford.com.cn/>

Asia Pacific

E-mail: expcac@ford.com

Caribbean, Central America and Israel

Ford Motor Company
Ford Export Operations
Attention: Owner Relations
1555 Fairlane Drive
Fairlane Business Park #3
Allen Park, MI 48101
Fax: (313) 390-0804
Telephone: (313) 594-4857
E-mail: expcac@ford.com

U.S. Virgin Islands and Puerto Rico

Ford Motor Company
Ford Export Operations
Attention: Owner Relations
1555 Fairlane Drive
Fairlane Business Park #3
Allen Park, MI 48101
Telephone: (800) 841-3673
E-mail: prcac@ford.com

Argentina

Telephone: 0800-888-3673

Brazil

www.ford.com.br

Contacting Us

North Africa

E-mail: nafcrc@ford.com

Sub-Saharan Africa

E-mail: ssacrc@ford.com

Puerto Rico

Ford International Business Development,
Inc.
P.O. Box 11957
Caparra Heights Station
San Juan, PR 00922-1957
1-800-392-3673 (FORD)
Fax: (313) 390-0804
E-mail: prcac@ford.com
www.ford.com.pr

Middle East

Ford Middle East Customer Relationship
Center
P.O. Box 21740
Dubai, United Arab Emirates
Telephone: 80004441066
Toll-free number for the Kingdom of Saudi
Arabia: 8008443673
Mobily and Zain cell phone users in Saudi
Arabia: 800850078
Kuwait: 22280384
Local telephone number for Kuwait: +965
1 898900
Fax: +971 4 3327266
E-mail: menacac@ford.com
www.me.ford.com

South Korea

Telephone: +82-02-1600-6003
E-mail: infokr1@ford.com

Ford Credit - US Only

Ford Credit offers a full range of financing and lease plans to help you acquire your vehicle. If you have financed or leased your vehicle through Ford Credit, thank you for your business.

For assistance call 1-800-727-7000, or for more information about Ford Credit and access to an account manager, visit www.ford.com/finance.

Introduction

ABOUT THIS PUBLICATION



WARNING: Driving while distracted can result in loss of vehicle control, crash and injury. We strongly recommend that you use extreme caution when using any device that may take your focus off the road. Your primary responsibility is the safe operation of your vehicle. We recommend against the use of any hand-held device while driving and encourage the use of voice-operated systems when possible. Make sure you are aware of all applicable local laws that may affect the use of electronic devices while driving.



WARNING: You risk death, fire, or serious injury to yourself and others if you do not follow the instruction highlighted by the warning symbol.

Thank you for choosing Ford. We recommend that you take some time to get to know your vehicle in order to benefit from greater safety and pleasure from driving it. Use this publication to familiarize yourself with the basics and then read the digital version, that is available in your vehicle. You can also view the comprehensive manual through the FordPass app and through the local Ford website.

Note: To download the FordPass app, visit your device's app store.

Note: To find the local Ford website, visit <https://corporate.ford.com/operations/locations/global-links.html>.

Note: Use and operate your vehicle in line with all applicable laws and regulations.

Note: Pass on all printed owner's information when selling this vehicle.

Our digital resources include a comprehensive digital Owner's Manual dynamically created according to the features on your vehicle by using the vehicle identification number. See **Locating the Vehicle Identification Number** (page 408). The digital Owner's Manual includes visual and full text search functions so that you can quickly locate the information you are looking for. It also includes links to a number of how-to videos created to help you understand some of the advanced technologies on your vehicle.

Features and Options

This publication describes product features and options available throughout the range of available models, sometimes even before they are generally available. It could describe options that are not available on the vehicle you have purchased.

Illustrations

Some of the illustrations in this publication could show features as used in different models, so they could appear different to you on your vehicle.

Location of Components

This manual may qualify the location of a component as left-hand side or right-hand side. The side is determined when facing forward in the seat.

Introduction



- A Right-hand side.
- B Left-hand side.



























USING THIS PUBLICATION

To quickly locate information about your vehicle, use the word search within the Owner's Manual application.

Symbols Glossary

SYMBOLS USED ON YOUR VEHICLE

These are some of the symbols you may see on your vehicle.

	Air conditioning system		Child seat tether anchor
	Air conditioning system lubricant type		Cruise control
	Anti-lock braking system		Do not open when hot
	Avoid smoking, flames or sparks		Electric Parking brake
	Battery		Engine air filter
	Battery acid		Engine coolant
	Brake fluid - non petroleum based		Engine coolant temperature
	Brake system		Engine oil
BRAKE	Brake system		Explosive gas
	Cabin air filter		Fan warning
	Check fuel cap		Fasten seatbelt
	Child safety door lock or unlock		Flammable
	Child seat lower anchor		Airbag
			Front fog lamps
			Fuel pump reset

Symbols Glossary



Fuse compartment



Hazard flashers



Heated rear window



Windshield defrosting system



Interior luggage compartment release



Jack



Keep out of reach of children



Lighting control



Low tire pressure warning



Maintain correct fluid level



Note operating instructions



Horn control



Panic alarm



Parking aid



Passenger airbag activated



Passenger airbag deactivated



Power steering fluid



Power windows front/rear



Power window lockout



Requires registered technician



Safety alert



See Owner's Manual



See Service Manual



Malfunction Indicator Lamp (MIL)



Side airbag



Shield the eyes



Stability control



Hill descent control



Trail control



Windshield wiping system

Symbols Glossary



Windshield wash and wipe

Data Privacy



WARNING: Do not connect wireless plug-in devices to the data link connector. Unauthorized third parties could gain access to vehicle data and impair the performance of safety related systems. Only allow repair facilities that follow our service and repair instructions to connect their equipment to the data link connector.

We respect your privacy and are committed to protecting it. The information contained in this manual was correct at the time of publication, but as technology rapidly changes, we recommend that you visit the local Ford website for the latest information.

Your vehicle has electronic control units that have data recording functionality and the ability to permanently or temporarily store data. This data could include information on the condition and status of your vehicle, vehicle maintenance requirements, events and malfunctions. The types of data that can be recorded are described in this section. Some of the data recorded is stored in event logs or error logs.

Note: *Error logs are reset following a service or repair.*

Note: *We may provide information in response to requests from law enforcement, other government authorities and third parties acting with lawful authority or through a legal process. Such information could be used by them in legal proceedings.*

Data recorded includes, for example:

- Operating states of system components, for example fuel level, tire pressure and battery charge level.
- Vehicle and component status, for example wheel speed, deceleration, lateral acceleration and seatbelt status.

- Events or errors in essential systems, for example headlamps and brakes.
- System responses to driving situations, for example airbag deployment and stability control.
- Environmental conditions, for example temperature.

Some of this data, when used in combination with other information, for example an accident report, damage to a vehicle or eyewitness statements, could be associated with a specific person.

Services That We Provide

If you use our services, we collect and use data, for example account information, vehicle location and driving characteristics, that could identify you. We transmit this data through a dedicated, protected connection. We only collect and use data to enable your use of our services to which you have subscribed, with your consent or where permitted by law. For additional information, see the terms and conditions of the services to which you have subscribed.

For additional information about our privacy policy, refer to the local Ford website.

Services That Third Parties Provide

We recommend that you review the terms and conditions and data privacy information for any services equipped with your vehicle or to which you subscribe. We take no responsibility for services that third parties provide.

Data Privacy

SERVICE DATA

Service data recorders in your vehicle are capable of collecting and storing diagnostic information about your vehicle. This potentially includes information about the performance or status of various systems and modules in the vehicle, such as engine, throttle, steering or brake systems. In order to properly diagnose and service your vehicle, Ford Motor Company (Ford of Canada in Canada), and service and repair facilities may access or share among them vehicle diagnostic information received through a direct connection to your vehicle when diagnosing or servicing your vehicle. Additionally, Ford Motor Company (Ford of Canada, in Canada) may, where permitted by law, use vehicle diagnostic information for vehicle improvement or with other information we may have about you, for example, your contact information, to offer you products or services that may interest you. Data may be provided to our service providers such as part suppliers that may help diagnose malfunctions, and who are similarly obligated to protect data. We retain this data only as long as necessary to perform these functions or to comply with law. We may provide information where required in response to official requests to law enforcement or other government authorities or third parties acting with lawful authority or court order, and such information may be used in legal proceedings. For U.S. only (if equipped), if you choose to use connected apps and services, you consent that certain diagnostic information may also be accessed electronically by Ford Motor Company and Ford authorized service facilities, and that the diagnostic information may be used to provide services to you, personalizing your experience, troubleshoot, and to improve products and services and offer you products and services that may interest

you, where permitted by law. For Canada only, for more information, please review the Ford of Canada privacy policy at www.ford.ca, including our U.S. data storage and use of service providers in other jurisdictions who may be subject to legal requirements in Canada, the United States and other countries applicable to them, for example, lawful requirements to disclose personal information to governmental authorities in those countries.

EVENT DATA

This vehicle is equipped with an event data recorder. The main purpose of an event data recorder is to record, in certain crash or near crash-like situations, such as an airbag deployment or hitting a road obstacle; this data will assist in understanding how a vehicle's systems performed. The event data recorder is designed to record data related to vehicle dynamics and safety systems for a short period of time, typically 30 seconds or less.

The event data recorder in this vehicle is designed to record such data as:

- How various systems in your vehicle were operating.
- Whether or not the driver and passenger seatbelts were buckled/fastened.
- How far (if at all) the driver was depressing the accelerator and/or the brake pedal.
- How fast the vehicle was traveling.
- Where the driver was positioning the steering wheel.

This data can help provide a better understanding of the circumstances in which crashes and injuries occur.

Data Privacy

Note: *Event data recorder data is recorded by your vehicle only if a non-trivial crash situation occurs; no data is recorded by the event data recorder under normal driving conditions and no personal data or information (for example name, gender, age, and crash location) is recorded. However, parties, such as law enforcement, could combine the event data recorder data with the type of personally identifying data routinely acquired during a crash investigation.*

To read data recorded by an event data recorder, special equipment is required, and access to the vehicle or the event data recorder is needed. In addition to the vehicle manufacturer, other parties, such as law enforcement, that have such special equipment, can read the information if they have access to the vehicle or the event data recorder.

SETTINGS DATA

Your vehicle has electronic control units that have the ability to store data based on your personalized settings. The data is stored locally in the vehicle or on devices that you connect to it, for example, a USB drive or digital music player. You can delete some of this data and also choose whether to share it through the services to which you subscribe.

Comfort and Convenience Data

Data recorded includes, for example:

- Seat and steering wheel position.
- Climate control settings.
- Radio presets.

Entertainment Data

Data recorded includes, for example:

- Music, videos or album art.
- Contacts and corresponding address book entries.
- Navigation destinations.

CONNECTED VEHICLE DATA



The modem has a SIM. The modem was enabled when your vehicle was built and periodically sends messages to stay connected to the cell phone network, receive automatic software updates and send vehicle-related information to us, for example diagnostic information. These messages could include information that identifies your vehicle, the SIM and the electronic serial number of the modem. Cell phone network service providers could have access to additional information, for example cell phone network tower identification. For additional information about our privacy policy, visit www.FordConnected.com or refer to your local Ford website.

Note: *The modem continues to send this information unless you disable the modem or stop the modem from sharing vehicle data by changing the modem settings. See **Connected Vehicle** (page 409).*

Note: *The service can be unavailable or interrupted for a number of reasons, for example environmental or topographical conditions and data plan coverage.*

Note: *To find out if your vehicle has a modem, visit www.FordConnected.com.*

Data Privacy

MOBILE DEVICE DATA

If you connect a mobile device to your vehicle, you can display data from your device on the touchscreen for example, music and album art. You can share your vehicle data with mobile apps on your device through the system. See **App Requirements** (page 437).

The mobile apps function operates by your connected device sending data to us in the United States. The data is encrypted and includes, for example, the vehicle identification number of your vehicle, the SYNC module serial number, odometer, enabled apps, usage statistics and debugging information. We retain it only as long as necessary to provide the service, to troubleshoot, for continuous improvement and to offer you products and services that may be of interest to you according to your preferences and where allowed by law.

If you connect a cell phone to the system, the system creates a profile that links to that cell phone. The cell phone profile enables more mobile features and efficient operation. The profile contains, for example data from your phonebook, read and unread text messages and call history, including history of calls when your cell phone was not connected to the system.

If you connect a media device, the system creates and retains a media device index of supported media content. The system also records a short diagnostic log of approximately 10 minutes of all recent system activity.

The cell phone profile, media device index and diagnostic log remain in your vehicle unless you delete them and are generally accessible only in your vehicle when you connect your cell phone or media device. If you no longer plan to use the system or your vehicle, we recommend you use the master reset function to erase the stored information. See **Performing a Master Reset** (page 444).

System data cannot be accessed without special equipment and access to your vehicle's module.

For additional information about our privacy policy, refer to the local Ford website.

Note: *To find out if your vehicle has connectivity technology, visit www.FordConnected.com.*

EMERGENCY CALL SYSTEM DATA

When the emergency call system is active, it may disclose to emergency services that your vehicle has been in a crash involving the deployment of an airbag or activation of the fuel pump shut-off. Certain versions or updates to the emergency call system may also be capable of electronically or verbally disclosing to emergency services operators your vehicle location or other details about your vehicle or crash to assist emergency services operators to provide the most appropriate emergency services. If you do not want to disclose this information, do not activate the emergency call system.

Note: *You cannot deactivate emergency call systems that are required by law.*

Visual Search

STEERING WHEEL - VEHICLES WITH: CRUISE CONTROL, VEHICLES WITHOUT: LANE KEEPING AID

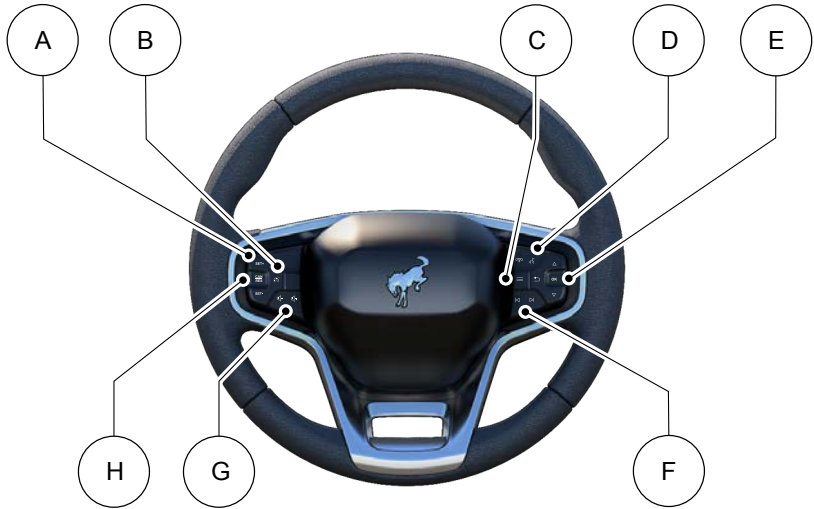

- A See **Setting the Cruise Control Speed** (page 232).
- B See **Switching Cruise Control On and Off** (page 232).
- C See **Using the Instrument Cluster Display Controls** (page 112).
- D See **What is Voice Interaction** (page 428).
- E See **Using the Instrument Cluster Display Controls** (page 112).
- F See **Playing or Pausing the Audio Source** (page 414).
- G See **Adjusting the Volume** (page 414).
- H See **Resuming the Set Speed** (page 233).

Visual Search

STEERING WHEEL - VEHICLES WITH: ADAPTIVE CRUISE CONTROL

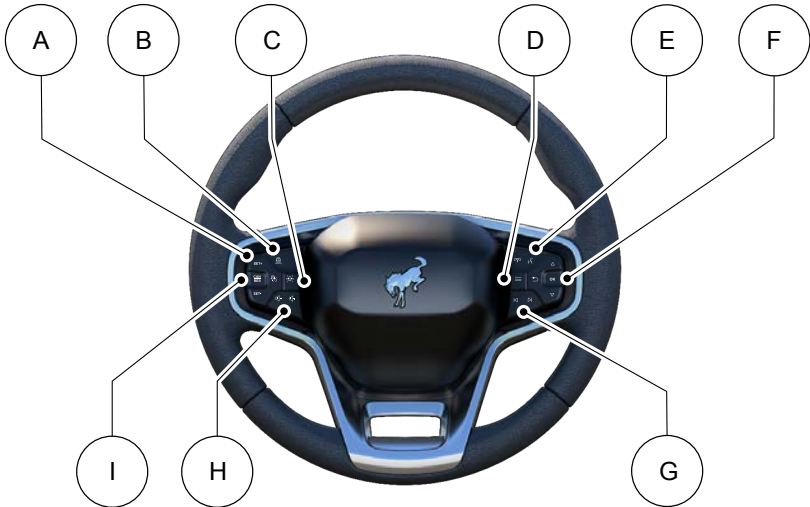

- A See **Setting the Adaptive Cruise Control Speed** (page 237).
- B See **Setting the Adaptive Cruise Control Gap** (page 238).
- C See **Switching the Lane Keeping System On and Off** (page 250).
- D See **Using the Instrument Cluster Display Controls** (page 112).
- E See **What is Voice Interaction** (page 428).
- F See **Using the Instrument Cluster Display Controls** (page 112).
- G See **Playing or Pausing the Audio Source** (page 414).
- H See **Adjusting the Volume** (page 414).
- I See **Resuming the Set Speed** (page 239).

Visual Search

STEERING WHEEL - VEHICLES WITH: CRUISE CONTROL/LANE KEEPING AID

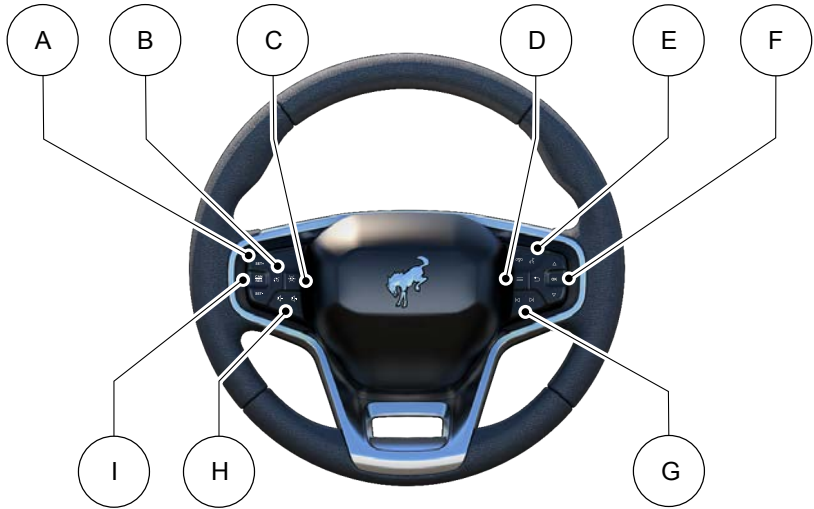

- A See **Setting the Cruise Control Speed** (page 232).
- B See **Switching Cruise Control On and Off** (page 232).
- C See **Switching the Lane Keeping System On and Off** (page 250).
- D See **Using the Instrument Cluster Display Controls** (page 112).
- E See **What is Voice Interaction** (page 428).
- F See **Using the Instrument Cluster Display Controls** (page 112).
- G See **Playing or Pausing the Audio Source** (page 414).
- H See **Adjusting the Volume** (page 414).
- I See **Resuming the Set Speed** (page 233).

Visual Search

INSTRUMENT PANEL

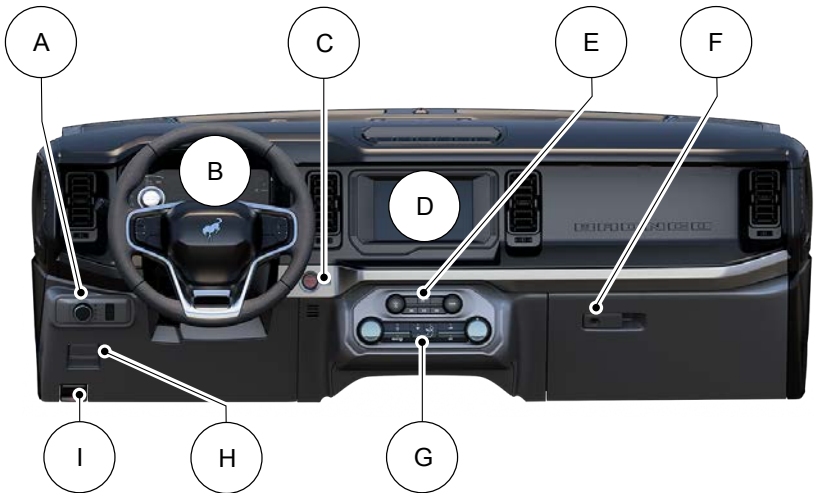

- A See **Exterior Lighting Control** (page 94).
- B See **Instrument Cluster Overview** (page 106).
- C See **Starting a Gasoline Engine** (page 152). See **Starting a Gasoline Engine** (page 152).
- D See **Feature Bar** (page 426).
- E See **Switching the Audio Unit On and Off** (page 414).
- F See **Opening the Glove Compartment** (page 149).
- G See **Identifying the Climate Control Unit** (page 117).
- H See **Applying the Electric Parking Brake** (page 198).
- I See **Opening and Closing the Hood** (page 318).

Visual Search

CENTER CONSOLE - MANUAL TRANSMISSION

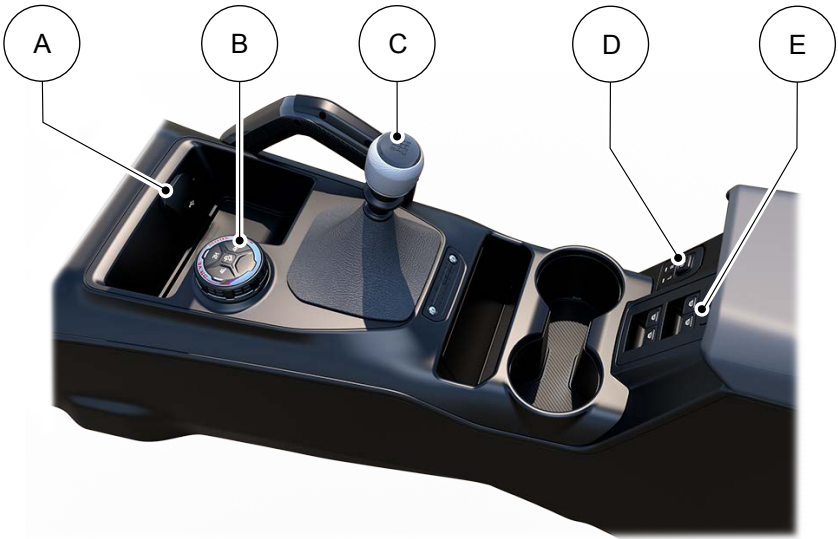

- A See **Locating the Power Outlet** (page 146).
- B See **Selecting a Four-Wheel Drive Mode** (page 185).
- C See **Shifting Into Reverse** (page 174).
- D See **Adjusting the Exterior Mirrors** (page 105).
- E See **Opening and Closing the Windows** (page 103).

Visual Search

CENTER CONSOLE - AUTOMATIC TRANSMISSION

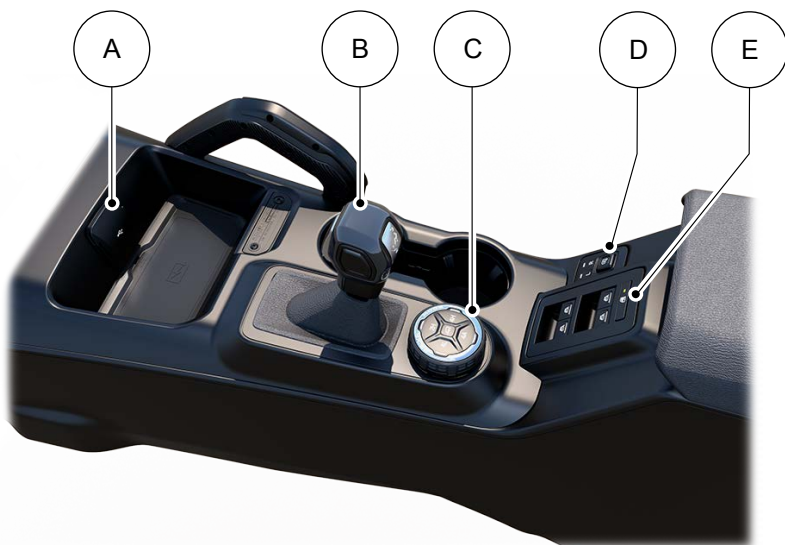

- A See **Locating the Power Outlet** (page 146).
- B See **Shifting Your Vehicle Into Gear** (page 179).
- C See **Selecting a Four-Wheel Drive Mode** (page 185).
- D See **Adjusting the Exterior Mirrors** (page 105).
- E See **Opening and Closing the Windows** (page 103).

Visual Search

VEHICLE INTERIOR - 2-DOOR

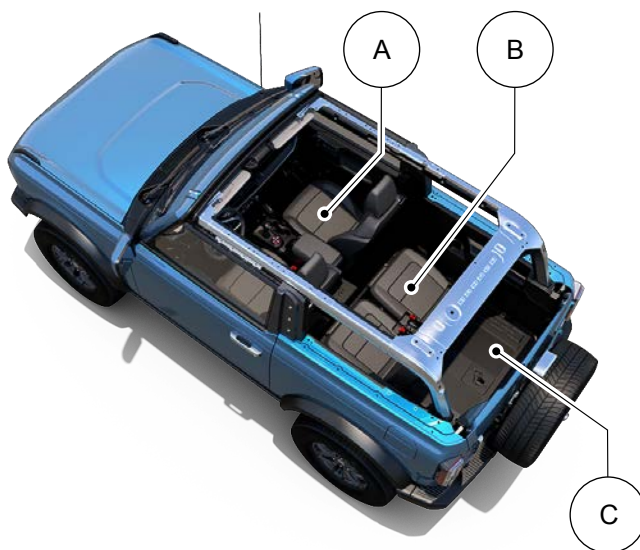

- A See **Moving the Seat Backward and Forward** (page 128).
- B See **Folding the Seats** (page 134).
- C See **Locating the Rear Cargo Area Anchor Points** (page 280).

Visual Search

VEHICLE INTERIOR - 4-DOOR

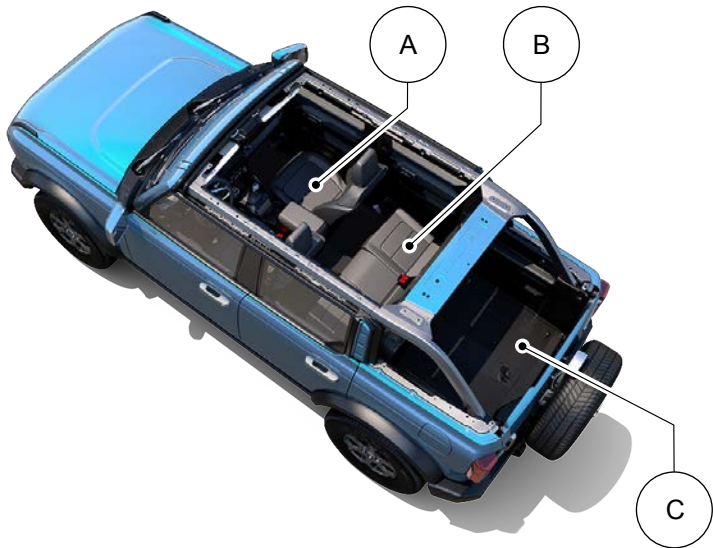

- A See **Moving the Seat Backward and Forward** (page 128).
- B See **Adjusting the Seat Backrest** (page 134).
- C See **Locating the Rear Cargo Area Anchor Points** (page 280).

Visual Search

FRONT EXTERIOR - 2-DOOR

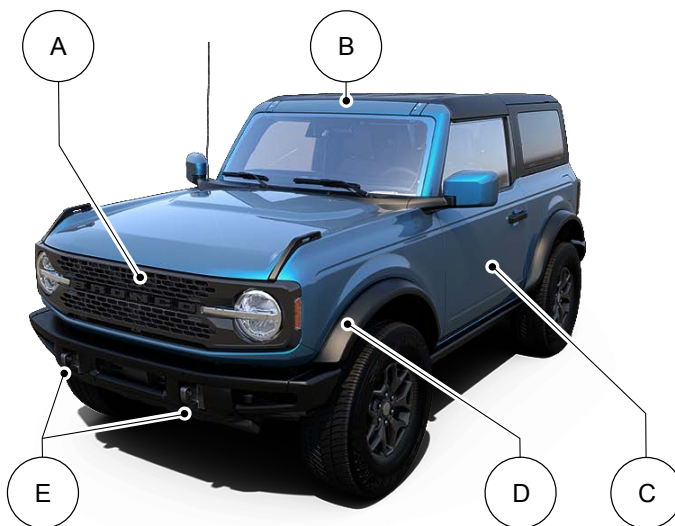

- A See **Locating the 360 Degree Cameras** (page 230).
- B See **Removing and Installing the Front Roof Panel** (page 343).
- C See **Removing and Installing the Doors** (page 339).
- D See **Removing the Fender Flares** (page 351).
- E See **Accessing the Front Towing Point** (page 303).

Visual Search

FRONT EXTERIOR - 4-DOOR, VEHICLES WITH: HARD TOP

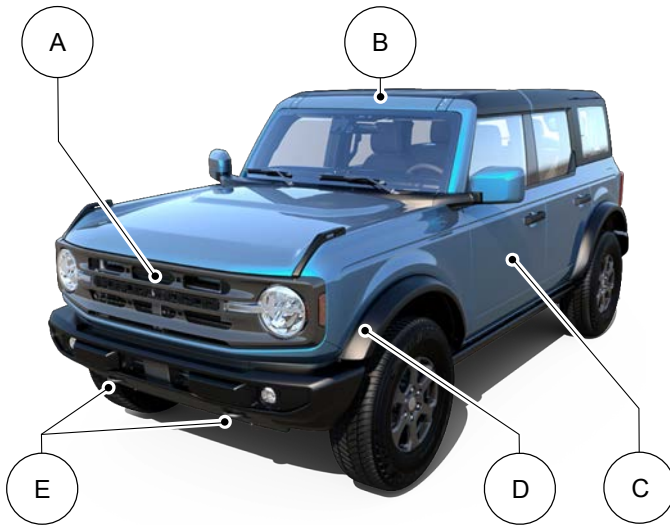

- A See **Locating the 360 Degree Cameras** (page 230).
- B See **Removing and Installing the Front Roof Panel** (page 343).
- C See **Removing and Installing the Doors** (page 339).
- D See **Removing the Fender Flares** (page 351).
- E See **Accessing the Front Towing Point** (page 303).

Visual Search

FRONT EXTERIOR - 4-DOOR, VEHICLES WITH: SOFT TOP

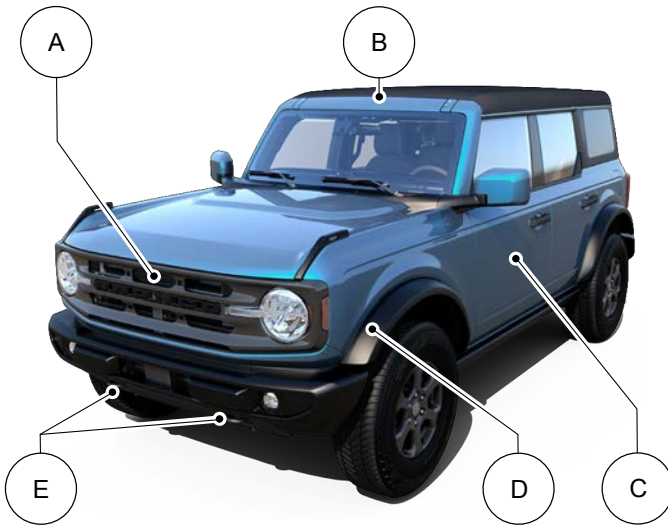

- A See **Locating the 360 Degree Cameras** (page 230).
- B See **Opening and Closing the Soft Top** (page 348).
- C See **Removing and Installing the Doors** (page 339).
- D See **Removing the Fender Flares** (page 351).
- E See **Accessing the Front Towing Point** (page 303).

Visual Search

REAR EXTERIOR - 2-DOOR

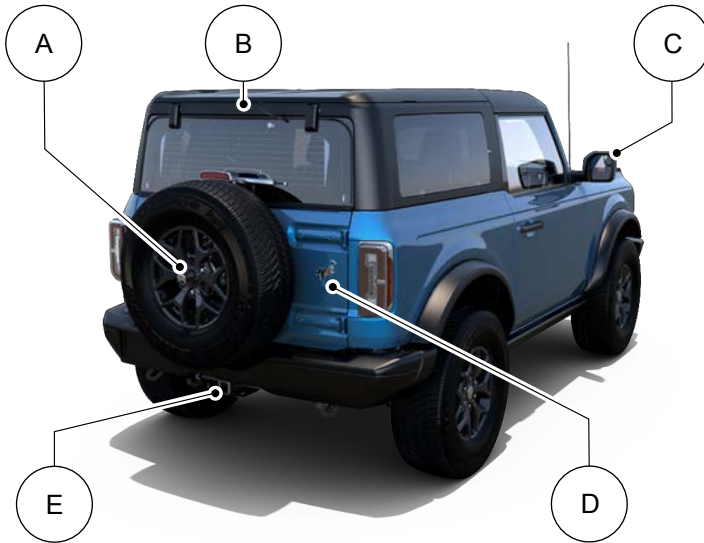

- A See **Changing a Flat Tire** (page 387).
- B See **Removing and Installing the Rear Roof Panel** (page 344).
- C See **Adjusting the Exterior Mirrors** (page 105).
- D See **Storing the Roof Panels** (page 359).
- E See **Recommended Towing Weights** (page 286).

Visual Search

REAR EXTERIOR - 4-DOOR, VEHICLES WITH: HARD TOP

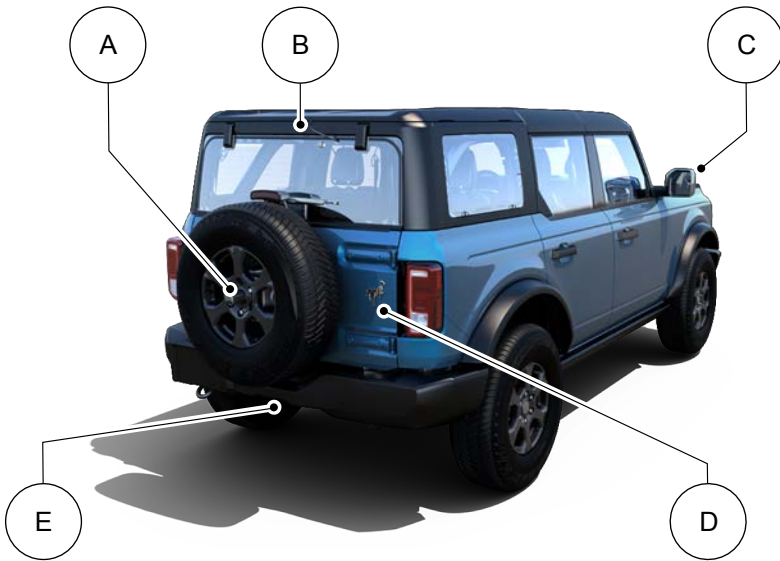

- A See **Changing a Flat Tire** (page 387).
- B See **Removing and Installing the Rear Roof Panel** (page 346).
- C See **Adjusting the Exterior Mirrors** (page 105).
- D See **Storing the Doors and the Roof Panels** (page 352).
- E See **Recommended Towing Weights** (page 286).

Visual Search

REAR EXTERIOR - 4-DOOR, VEHICLES WITH: SOFT TOP

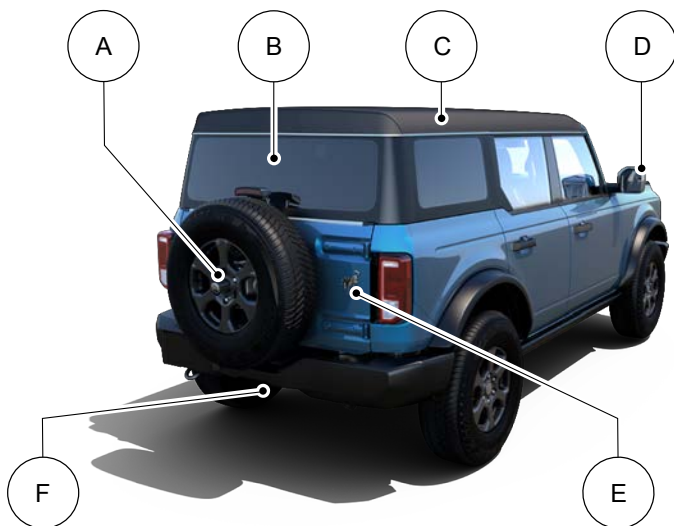

- A See **Changing a Flat Tire** (page 387).
- B See **Removing and Installing the Rear Window** (page 337).
- C See **Removing and Installing the Soft Top** (page 350).
- D See **Adjusting the Exterior Mirrors** (page 105).
- E See **Storing the Doors and the Roof Panels** (page 352).
- F See **Recommended Towing Weights** (page 286).

Child Safety

CHILD SAFETY PRECAUTIONS



WARNING: Always make sure your child is secured properly in a device that is appropriate for their height, age and weight. Child safety restraints must be bought separately from your vehicle. Failure to follow these instructions and guidelines may result in an increased risk of serious injury or death to your child.



WARNING: All children are shaped differently. The National Highway Traffic Safety Administration and other safety organizations, base their recommendations for child restraints on probable child height, age and weight thresholds, or on the minimum requirements of the law. We recommend that you check with a NHTSA Certified Child Passenger Safety Technician (CPST) to make sure that you properly install the child restraint in your vehicle and that you consult your pediatrician to make sure you have a child restraint appropriate for your child. To locate a child restraint fitting station and CPST, contact NHTSA toll free at 1-888-327-4236 or go to www.nhtsa.dot.gov. In Canada, contact Transport Canada toll free at 1-800-333-0371 or go to www.tc.gc.ca to find a Child Car Seat Clinic in your area. Failure to properly restrain children in child restraints made especially for their height, age and weight, may result in an increased risk of serious injury or death to your child.



WARNING: On hot days, the temperature inside the vehicle can rise very quickly. Exposure of people or animals to these high temperatures for even a short time can cause death or serious heat related injuries, including brain damage. Small children are particularly at risk.



WARNING: Do not place a rearward facing child restraint in front of an active airbag. Failure to follow this instruction could result in personal injury or death.



WARNING: Properly secure children 12 years old and under in a rear seating position whenever possible. If you are unable to properly secure all children in a rear seating position, properly secure the largest child on the front seat. If you must use a forward facing child restraint on the front seat, move the seat as far back as possible. Failure to follow these instructions could result in personal injury or death.



WARNING: Always carefully follow the instructions and warnings provided by the manufacturer of any child restraint to determine if the restraint device is appropriate for your child's size, height, weight, or age. Follow the child restraint manufacturer's instructions and warnings provided for installation and use in conjunction with the instructions and warnings provided by your vehicle manufacturer. A safety seat that is improperly installed or utilized, is inappropriate for your child's height, age, or weight or does not properly fit the child may increase the risk of serious injury or death.

Child Safety

WARNING: Do not allow a passenger to hold a child on their lap when your vehicle is moving. Failure to follow this instruction could result in personal injury or death in the event of a sudden stop or crash.

WARNING: Do not use pillows, books or towels to boost your child's height. Failure to follow this instruction could result in personal injury or death.

WARNING: Properly secure child restraints or booster seats when they are not in use. They could become projectiles in a sudden stop or crash. Failure to follow this instruction could result in personal injury or death.

WARNING: Do not put the shoulder section of the seatbelt or allow the child to put the shoulder section of the seatbelt under their arm or behind their back. Failure to follow this instruction could reduce the effectiveness of the seatbelt and increase the risk of injury or death in a crash.

WARNING: Do not leave children or pets unattended in your vehicle. Failure to follow this instruction could result in personal injury or death.

When installing a child restraint with seatbelts:

- Place the vehicle seat in the upright position before you install the child restraint.
- Use the correct seatbelt buckle for that seating position.
- Insert the belt tongue into the buckle. Make sure the tongue is securely fastened in the buckle.

- Keep the buckle release button pointing up and away from the child restraint, with the tongue between the child restraint and the release button, to prevent accidental unbuckling.
- Put the seatbelt in the automatic locking mode.

CHILD RESTRAINT ANCHOR POINTS

WHAT ARE THE CHILD RESTRAINT ANCHOR POINTS

Anchor points allow you to quickly and safely install a child restraint.

LOCATING THE CHILD RESTRAINT LOWER ANCHOR POINTS

2-Door

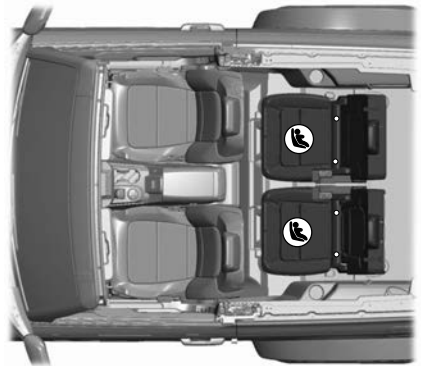

Child Safety

4-Door

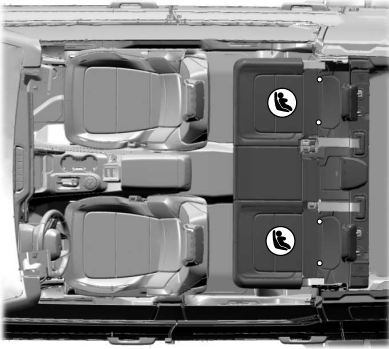

4-Door

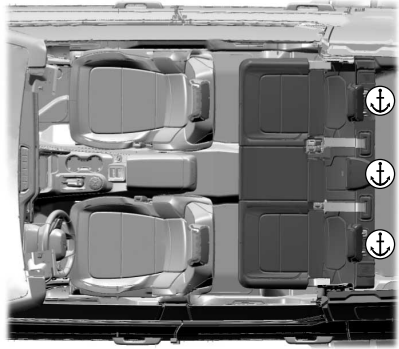

LOCATING THE CHILD RESTRAINT TOP TETHER ANCHOR POINTS

2-Door

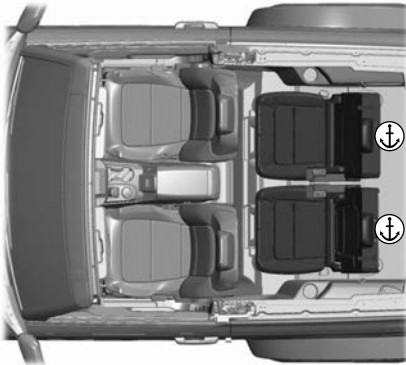

CHILD RESTRAINTS

CHILD RESTRAINT POSITION INFORMATION

Install the child restraint tightly against the vehicle seat. It may be necessary to lift or remove the head restraint.

Rear Facing Child Restraints

Combined Weight of Child and Child Restraint	LATCH (Lower Anchors Only)	Seatbelt Only
Up to 65 lb (29 kg)	X	X
Over 65 lb (29 kg)		X

Child Safety

Forward Facing Child Restraints

Combined Weight of Child and Child Restraint	LATCH (Lower Anchors and Top Tether Anchor)	Seatbelt and Top Tether Anchor	Seatbelt and LATCH (Lower Anchors and Top Tether Anchor)
Up to 65 lb (29 kg)	X	X	X
Over 65 lb (29 kg)		X	X

Child Safety

CHILD RESTRAINTS RECOMMENDATION

Child Size, Height, Weight, or Age	Recommended Restraint Type
Children weighing 40 lb (18 kg) or less (generally age four or younger).	Use a child restraint (sometimes called an infant carrier, convertible seat, or toddler seat).
Children who have outgrown or no longer properly fit in a child restraint (generally children who are less than 57 in (1.45 m) tall, are greater than age four and less than age 12, and between 40 lb (18 kg) and 80 lb (36 kg) and upward to 100 lb (45 kg) if recommended by your child restraint manufacturer).	Use a belt-positioning booster seat.
Children who have outgrown or no longer properly fit in a belt-positioning booster seat (generally children who are at least 57 in (1.45 m) tall or greater than 80 lb (36 kg) or 100 lb (45 kg) if recommended by child restraint manufacturer).	Use a vehicle seatbelt having the lap belt snug and low across the hips, shoulder belt centered across the shoulder and chest, and seat backrest upright.

You are required by law to properly use child restraints for infants and toddlers in the United States, Canada and Mexico.

Many states and provinces require that small children use approved booster seats until they reach age eight, a height of 57 in (1.45 m) tall, or 80 lb (36 kg). Check your local and state or provincial laws for specific requirements about the safety of children in your vehicle.

When possible, properly restrain children 12 years of age and under in a rear seating position of your vehicle. Accident statistics suggest that children are safer when properly restrained in the rear seating positions than in a front seating position.

When installing a rear facing child restraint, adjust the vehicle seats to avoid interference between the child restraint and the vehicle seat in front of the child restraint.

INSTALLING CHILD RESTRAINTS

USING SEATBELTS



WARNING: Depending on where you secure a child restraint, and depending on the child restraint design, you may block access to certain seatbelt buckle assemblies and LATCH lower anchors, rendering those features potentially unusable. To avoid risk of injury, make sure occupants only use seating positions where they are able to be properly restrained.

Note: *Although the child restraint illustrated is a forward facing child restraint, the steps are the same for installing a rear facing child restraint.*

Perform the following steps when installing a child restraint with seatbelts.

Child Safety

1. Position the child restraint in a seat with a seatbelt.



2. Pull down on the shoulder belt and then grasp the shoulder belt and lap belt together.



3. While holding the shoulder and lap belt portions together, route the tongue through the child restraint according to the child restraint manufacturer's instructions. Make sure you did not twist the belt webbing.

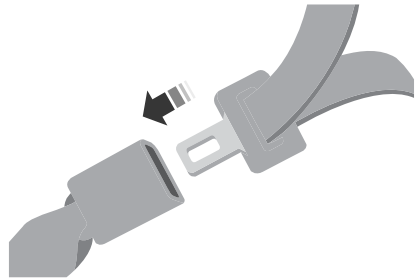

4. Insert the belt tongue into the proper buckle for that seating position until the latch engages. Make sure the tongue is latched securely by pulling on it.



5. To put the retractor in the automatic locking mode, grasp the shoulder portion of the belt and pull downward until you pull all of the seatbelt out.

Note: *The automatic locking mode is available on the front passenger and rear seats. This vehicle does not require the use of a locking clip.*

6. Allow the belt to retract to remove slack. The seatbelt clicks as it retracts to indicate it is in the automatic locking mode.

Child Safety

7. Pull the seatbelt out of the retractor to make sure the retractor is in the automatic locking mode. You should not be able to pull more belt out. If the retractor is not locked, unbuckle the belt and repeat Steps 5 and 6.



8. Remove remaining slack from the belt. Force the seat down with extra weight, for example, by pressing down or kneeling on the child restraint while pulling up on the shoulder belt in order to force slack from the belt. This is necessary to remove the remaining slack that exists once you add the extra weight of the child to the child restraint. It also helps to achieve the proper snugness of the child restraint to your vehicle. Sometimes, a slight lean toward the buckle helps to remove remaining slack from the belt.
9. If the child restraint has a tether strap, attach it.

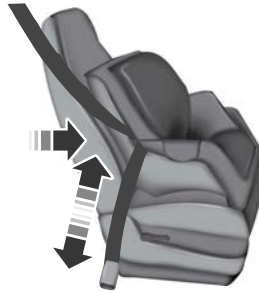

10. Before placing the child in the seat, forcibly move the seat forward and back to make sure the seat is securely held in place.

To check this, grab the seat at the belt path and attempt to move it side to side and forward and back. There should be no more than 1 in (2.5 cm) of movement.

We recommend checking with a NHTSA Certified Child Passenger Safety Technician to make certain the child restraint is properly installed. In Canada, check with Transport Canada for referral to a Child Car Seat Clinic.

USING LOWER ANCHORS AND TETHERS FOR CHILDREN



WARNING: Do not attach two child safety restraints to the same anchor. In a crash, one anchor may not be strong enough to hold two child safety restraint attachments and may break, causing serious injury or death.

Child Safety



WARNING: Depending on where you secure a child restraint, and depending on the child restraint design, you may block access to certain seatbelt buckle assemblies and LATCH lower anchors, rendering those features potentially unusable. To avoid risk of injury, make sure occupants only use seating positions where they are able to be properly restrained.

The Lower Anchors and Tethers for CHildren (LATCH) system has three vehicle anchor points:

- Two lower anchors where the vehicle seat backrest and seat cushion meet, called the seat bight.
- One top tether anchor behind that seating position.

LATCH compatible child restraints have two rigid or webbing mounted attachments. These attachments connect to the two lower anchors at the LATCH equipped seating positions in your vehicle. This type of attachment method eliminates the need to use seatbelts to attach the child restraint.

However, you can still use the seatbelt to attach the child restraint if the lower anchors are not used. For forward facing child restraints, you must also attach the top tether strap to the proper top tether anchor if a top tether strap has been provided with your child restraint.

Follow the instructions later in this chapter on attaching child restraints with tether straps.

INSTALLING A CHILD RESTRAINT IN A CENTER SEAT



WARNING: The standardized spacing for LATCH lower anchors is 11 in (280 mm) center to center. Do not use LATCH lower anchors for the center seating position unless the child restraint manufacturer's instructions permit and specify using anchors spaced at least as far apart as those in this vehicle.

You cannot install a child restraint with rigid LATCH attachments at the center seating position. You can only use LATCH compatible child restraints, with attachments on belt webbing, at this seating position provided that the child restraint manufacturer's instructions permit use with the anchor spacing stated. Do not attach a child restraint to any lower anchor if another child restraint is attached to that anchor.

Each time you use the child restraint, check that the seat is properly attached to the lower anchors and tether anchor, if applicable. Tug the child restraint from side to side and forward and back where it is secured to the vehicle. The seat should move less than 1 in (2.5 cm).

If you did not properly anchor the child restraint, the risk of a child being injured in a crash greatly increases.

COMBINING THE SEATBELT AND LOWER ANCHORS FOR ATTACHING CHILD RESTRAINTS

When used in combination, you may attach the seatbelt or the LATCH lower anchors first, provided a proper installation is achieved. Attach the tether strap afterward, if it is included with the child restraint.

Child Safety

USING TETHER STRAPS

Many forward-facing child restraints include a tether strap which extends from the back of the child restraint and hooks to an anchoring point called the top tether anchor. Tether straps are available as an accessory for many older child restraints.

Contact the manufacturer of your child restraint for information about ordering a tether strap, or to obtain a longer tether strap if the tether strap on your child restraint does not reach the appropriate top tether anchor in your vehicle.

Attach the tether strap only to the appropriate tether anchor. The tether strap may not work properly if attached somewhere other than the correct tether anchor.

Note: *If you install a child restraint with rigid LATCH attachments, do not tighten the tether strap enough to lift the child restraint off the vehicle seat cushion when the child is seated in it. Keep the tether strap just snug without lifting the front of the child restraint. Keeping the child restraint just touching the vehicle seat gives the best protection in a severe crash.*

Once you have installed the child restraint using either the seatbelt, the lower anchors of the LATCH system, or both, you can attach the top tether strap.

1. Route the child restraint tether strap over the back of the seat. For the outermost seating positions, route the tether strap under the head restraint and between the head restraint posts. For vehicles with a center seating position, route the tether strap over the top of the head restraint. If needed, you can also remove the head restraints.

Note: *The head restraints are not removable on 2-door vehicles.*

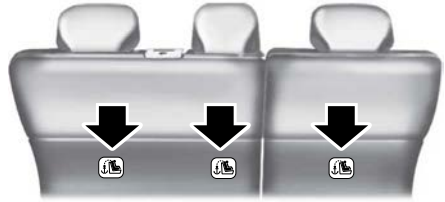

2. Locate the correct anchor behind the gap cover for the selected seating position.



3. Clip the tether strap to the anchor as shown.
4. Tighten the child restraint tether strap according to the manufacturer's instructions.

If your child restraint system has a tether strap, and the child restraint manufacturer recommends its use, we also recommend its use.

BOOSTER SEATS

Use a belt-positioning booster seat for children who have outgrown or no longer properly fit in a child restraint and meet the following criteria.

Child Safety

- Generally children who are less than 57 in (1.45 m) tall.
- Are greater than age four (4) and less than age twelve (12).
- Are between 40 lb (18 kg) and 80 lb (36 kg) and upward to 100 lb (45 kg).

Many state and provincial laws require that children use approved booster seats until they reach age eight, a height of 57 in (1.45 m) tall, or 80 lb (36 kg).

Booster seats should be used until you can answer yes to all of these questions when seated without a booster seat:

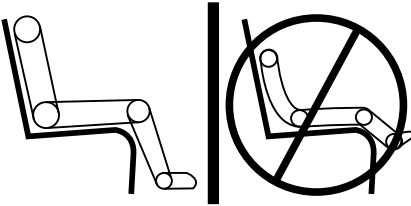

- Can the child sit all the way back against their vehicle seat backrest with knees bent comfortably at the edge of the seat cushion?
- Can the child sit without slouching?
- Does the lap belt rest low across the hips?
- Is the shoulder belt centered on the shoulder and chest?
- Can the child stay seated like this for the whole trip?

Always use booster seats in conjunction with your vehicle lap and shoulder belt.

Types of Booster Seats



- Backless booster seats

If your backless booster seat has a removable shield, remove the shield.

If a vehicle seating position has a low seat backrest or no head restraint, a backless booster seat may place your child's head, as measured at the tops of the ears, above the top of the seat. In this case, move the backless booster to another seating position with a higher seat backrest or head restraint and lap and shoulder belts, or consider using a high-back booster seat.



- High-back booster seats

If, with a backless booster seat, you cannot find a seating position that adequately supports your child's head, a high-back booster seat would be a better choice.

Child Safety

Children and booster seats vary in size and shape. Choose a booster that keeps the lap belt low and snug across the hips, never up across the stomach, and lets you adjust the shoulder belt to cross the chest and rest snugly near the center of the shoulder.

The following drawings compare the ideal fit to a shoulder belt uncomfortably close to the neck and a shoulder belt that could slip off the shoulder. The drawings also show how the lap belt should be low and snug across the child's hips.



If the booster seat slides on the vehicle seat upon which it is being used, placing a rubberized mesh sold as shelf or carpet liner under the booster seat may improve this condition. Do not use any item thicker than this under the booster seat. Check with the booster seat manufacturer's instructions.

CHILD SAFETY LOCKS (IF EQUIPPED)



WARNING: You cannot open the rear doors from inside if you have put the child safety locks on.

Child Safety



A child safety lock is on the rear edge of each rear door. Switch the child safety lock separately on each door.

Left-Hand Side

Turn the key clockwise to switch the child lock on and counterclockwise to switch it off.

Right-Hand Side

Turn the key counterclockwise to switch the child lock on and clockwise to switch it off.

Seatbelts

SEATBELT PRECAUTIONS



WARNING: Always drive and ride with your seatback upright and the lap belt snug and low across the hips.



WARNING: Children must always be properly restrained.



WARNING: Do not allow a passenger to hold a child on their lap when your vehicle is moving. Failure to follow this instruction could result in personal injury or death in the event of a sudden stop or crash.



WARNING: All occupants of your vehicle, including the driver, should always properly wear their seatbelts, even when an airbag supplemental restraint system is provided. Failure to properly wear your seatbelt could seriously increase the risk of injury or death.



WARNING: It is extremely dangerous to ride in a cargo area, inside or outside of a vehicle. In a crash, people riding in these areas are more likely to be seriously injured or killed. Do not allow people to ride in any area of your vehicle that is not equipped with seats and seatbelts. Make sure everyone in your vehicle is in a seat and properly using a seatbelt. Failure to follow this warning could result in serious personal injury or death.



WARNING: In a rollover crash, an unbelted person is significantly more likely to die than a person wearing a seatbelt.



WARNING: Each seating position in your vehicle has a specific seatbelt assembly made up of one buckle and one tongue designed to be used as a pair. Use the shoulder belt on the outside shoulder only. Never wear the shoulder belt under the arm. Never use a single seatbelt for more than one person.



WARNING: Even with advanced restraints systems, properly restrain children 12 and under in a rear seating position. Failure to follow this could seriously increase the risk of injury or death.



WARNING: Seatbelts and seats may be hot in a vehicle that is in the sunshine. The hot seatbelts or seats may burn a small child. Check seat covers and buckles before you place a child anywhere near them.



WARNING: If your vehicle is involved in a crash, have the seatbelts and associated components inspected as soon as possible. Failure to follow this instruction could result in personal injury or death.

All seating positions in this vehicle have lap and shoulder seatbelts. All occupants of the vehicle should properly wear their seatbelts, even when an airbag supplemental restraint system is provided.

The seatbelt system consists of:

- Lap and shoulder seatbelts.
- A shoulder seatbelt with automatic locking mode, except driver seatbelt.
- Seatbelt pretensioners at the front outermost and rear outermost seating positions.



• A seatbelt warning light and chime.

Seatbelts



Crash sensors and monitoring system with readiness indicator.

The seatbelt pretensioners are designed to tighten the seatbelts when activated. In frontal and near-frontal crashes, the seatbelt pretensioners may be activated alone or, if the crash is of sufficient severity, together with the front airbags. In side crashes and rollovers, the pretensioners will be activated when the Safety Canopy is activated.

FASTENING AND UNFASTENING THE SEATBELTS

All seatbelts in your vehicle are a three-point combination lap and shoulder seatbelt.

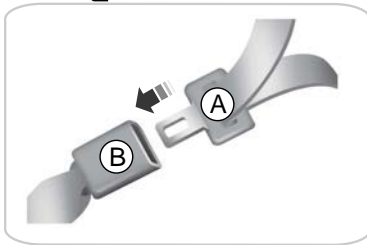

- A Seatbelt tongue.
- B Seatbelt buckle.

1. Pull the seatbelt out steadily.

Note: It may lock if you pull it sharply or if the vehicle is on a slope.

2. Insert the tongue into the buckle.
3. Pull the seatbelt tight to remove any slack.

Unfastening the Seatbelts

1. Press the red button on the buckle to release the seatbelt.
2. Hold the seatbelt tongue and let it retract completely and smoothly to its stowed position.

SENSITIVE LOCKING MODE

WHAT IS SENSITIVE LOCKING MODE

Sensitive locking mode is a seatbelt retractor feature that allows shoulder belt length adjustment according to your movements and locking in response to vehicle movement.

HOW DOES SENSITIVE LOCKING MODE WORK

If the driver suddenly brakes, turns a corner sharply, or the vehicle receives an impact of about 5 mph (8 km/h) or more, the seatbelts lock to help reduce forward movement of the driver and passengers.

In addition, the seatbelt retractor locks if you pull the seatbelt webbing out too quickly. If the retractor does not unlock, pull the seatbelt out slowly then feed a small length of webbing back toward the stowed position.

Note: When driving off-road or at a severe angle, the seatbelt mechanism locks. It does not allow you to pull the seatbelt webbing out until your vehicle is on nearly level ground.

Seatbelts

AUTOMATIC LOCKING MODE

WHAT IS AUTOMATIC LOCKING MODE

This is a safety feature built into the seatbelt retractors that keeps the seatbelts pre-locked.

ENGAGING AUTOMATIC LOCKING MODE



1. Fasten the combination lap and shoulder belt.
2. Grasp the shoulder portion and pull downward until you pull the entire belt out.
3. Allow the belt to retract. As the belt retracts, you will hear a clicking sound. This indicates the seatbelt is now in the automatic locking mode.

DISENGAGING AUTOMATIC LOCKING MODE

Unbuckle the combination lap and shoulder belt and allow it to retract completely to disengage the automatic locking mode and activate the vehicle sensitive locking mode.

ADJUSTING THE SEATBELTS DURING PREGNANCY



WARNING: Always ride and drive with your seatback upright and properly fasten your seatbelt. Fit the lap portion of the seatbelt snugly and low across the hips. Position the shoulder portion of the seatbelt across your chest. Pregnant women must follow this practice. See the following figure.

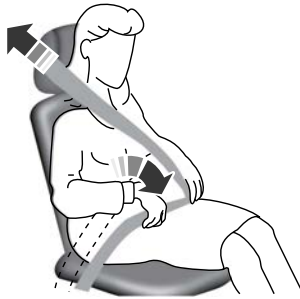

Pregnant women should always wear their seatbelt. Position the lap belt portion of a combination lap and shoulder belt low across the hips below the belly and worn as tight as comfort allows. Position the shoulder belt to cross the middle of the shoulder and the center of the chest.

SEATBELT REMINDER

HOW DOES THE SEATBELT REMINDER WORK



WARNING: The system will only provide protection when you use the seatbelt correctly.

Seatbelts

This system monitors all seating positions and provides audio and graphic feedback.

SEATBELT REMINDER INDICATORS



This lamp illuminates if you do not fasten your seatbelt when you switch the ignition on. The lamp switches off when you fasten your seatbelt or about one minute has elapsed.

When the initial warning expires for the driver, more warnings are provided for the driver and front passenger. This lamp illuminates if you or your front passenger do not fasten the seatbelt buckle and the vehicle speed exceeds 6 mph (9.7 km/h).

Note: To avoid inadvertent warnings, do not place large objects on the seat.



This lamp illuminates when you switch the ignition on, identifying the number of seating positions with fastened buckles. It illuminates again when a seating position changes from unfastened to fastened.



This warning displays if an occupant unfastens the rear seatbelt buckle or it becomes unfastened.

Note: Seatbelt reminder indicators may vary between 2-door and 4-door vehicles. Vehicle system updates could change the functionality.

Note: If a rear seat is unoccupied, or an occupant never fastens the seatbelt buckle to begin with, the warning will not display.

Note: Front seating positions appear in this warning display. Warnings for unfastened front seatbelt buckles appear in the initial warning lamp.

Note: Vehicles with two doors do not have a rear center seating position.

Seatbelt Status

To view the seatbelt status, use the information display controls on the steering wheel.

Seatbelts

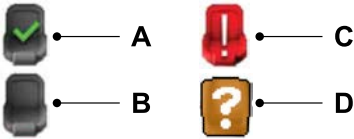
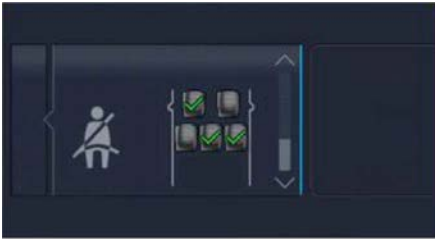

- A Seatbelt fastened.
- B Seatbelt not fastened.
- C Seatbelt recently unfastened.
- D Fault.

SWITCHING THE SEATBELT REMINDER ON AND OFF



WARNING: While the system allows you to deactivate it, this system is designed to improve your chances of being safely belted and surviving an accident. We recommend you leave the system activated for yourself and others who may use the vehicle.

Note: The driver and front passenger warnings switch off independently. When you perform this procedure for one seating position, do not buckle the other position as this cancels the process.

Note: If you are using MyKey, you cannot disable the seatbelt reminder. Also, if the seatbelt reminder has been previously disabled, it will be re-enabled during the use of MyKey. See **MyKey™** (page 74).

Read Steps 1 - 4 before proceeding with the programming procedure.

Make sure that:

- The parking brake is set.
 - The transmission is in park (P).
 - The ignition is off.
 - The driver and front passenger seatbelts are unfastened.
1. Switch the ignition on. Do not start the engine.
 2. After Step 1, wait an additional five seconds before proceeding with Step 3. Once you start Step 3, you must complete the procedure within 30 seconds.
 3. For the seating position you are switching off, buckle then unbuckle the seatbelt four times at a moderate speed, ending in the unbuckled state. After Step 3, the seatbelt warning light switches on.
 4. When the seatbelt warning light is on, buckle then unbuckle the seatbelt. After Step 4, the seatbelt warning light flashes for confirmation.

This switches the feature off for that seating position if it is currently on.

This switches the feature on for that seating position if it is currently off.

CHECKING THE SEATBELTS

Check the seatbelts and child restraints periodically to make sure they work properly and are not damaged. Make sure there are no nicks, tears or cuts. Replace if necessary.

Seatbelts

Check all of the following seatbelt assemblies after a crash.

- Retractors.
- Buckles.
- Front seatbelt buckle assemblies.
- Buckle support assemblies.
- Child restraint LATCH and tether anchors.
- Attaching hardware.

Read the child restraint manufacturer's instructions for additional inspection and maintenance information specific to the child restraint.

We recommend that all seatbelt assemblies in use in vehicles involved in a crash be replaced. However, if the crash was minor and an authorized dealer finds that the belts do not show damage and continue to operate properly, they do not need to be replaced. Seatbelt assemblies not in use during a crash should also be checked and replaced if either damage or improper operation is noted.

Properly care for seatbelts. See **Cleaning the Interior** (page 364).

SEATBELT EXTENSIONS



WARNING: Persons who fit into the vehicle's seatbelt should not use an extension. Unnecessary use could result in serious personal injury in the event of a crash.



WARNING: Only use extensions provided free of charge by our dealers. The dealer will provide an extension designed specifically for this vehicle, model year and seating position. The use of an extension intended for another vehicle, model year or seating position may not offer you the full protection of your vehicle's seatbelt restraint system.



WARNING: Never use seatbelt extensions to install child restraints.



WARNING: Do not use extensions to change the way the seatbelt fits across the torso, over the lap or to make the seatbelt buckle easier to reach.

If, because of body size or driving position, it is not possible to properly fasten the seatbelt over your lap and shoulder, an extension that is compatible with the seatbelts is available free of charge from our dealers. Only use our seatbelt extensions made by the original equipment seatbelt manufacturer with our seatbelts. Ask your authorized dealer if your extension is compatible with your vehicle restraint system.

Personal Safety System™

WHAT IS THE PERSONAL SAFETY SYSTEM

An advanced safety system that protects occupants in frontal crashes.

HOW DOES THE PERSONAL SAFETY SYSTEM WORK

This system provides an improved level of frontal crash protection to front seat occupants and is designed to reduce the risk of airbag-related injuries. The system analyzes occupant conditions and crash severity before activating the appropriate safety devices. During a crash, the restraints control module may deploy the seatbelt pretensioners, and one or both stages of the dual-stage airbags based on crash severity and occupant conditions.

PERSONAL SAFETY SYSTEM COMPONENTS

- Restraint system warning light and tone.
 - The electrical wiring for the airbags, crash sensors, seatbelt pretensioners, front seatbelt usage sensors, front passenger sensing system and indicator lights.
- Driver and passenger dual-stage airbag supplemental restraints.
 - Front seat outermost seatbelts with pretensioners, energy management retractors and seatbelt usage sensors.
 - Driver seat position sensor.
 - Passenger seat position sensor.
 - Front passenger sensing system.
 - Passenger airbag off and on indicators.
 - Front crash severity sensors.
 - Restraints control module with impact and safing sensors.

Airbags

HOW DO THE FRONT AIRBAGS WORK

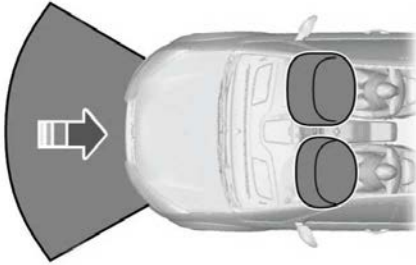

The driver and front passenger airbags deploy during significant frontal and near frontal crashes.

The driver and passenger front airbag system consists of:

- Driver and passenger airbag modules.
- Front passenger sensing system.
- Crash sensors and monitoring system with readiness indicator. See **Crash Sensors and Airbag Indicator** (page 66).

The airbags are a supplemental restraint system and are designed to work with the seatbelts to help protect the driver and right front passenger from certain upper body injuries. Airbags do not inflate slowly; there is a risk of injury from a deploying airbag.

Note: *You will hear a loud bang and see a cloud of harmless powdery residue if an airbag deploys. This is normal.*

The airbags inflate and deflate rapidly upon activation. After airbag deployment, it is normal to notice a smoke-like, powdery residue or smell the burnt propellant. This may consist of cornstarch, talcum powder (to lubricate the bag) or sodium

compounds (for example, baking soda) that result from the combustion process that inflates the airbag. Small amounts of sodium hydroxide may be present which may irritate the skin and eyes, but none of the residue is toxic.

Contact with a deploying airbag may cause abrasions or swelling. Temporary hearing loss is also a possibility as a result of the noise associated with a deploying airbag.

Because airbags must inflate rapidly and with considerable force, there is the risk of death or serious injuries such as fractures, facial and eye injuries or internal injuries, particularly to occupants who are not properly restrained or are otherwise out of position at the time of airbag deployment. Thus, it is extremely important that occupants be properly restrained as far away from the airbag module as possible while maintaining vehicle control.

Routine maintenance of the airbags is not required.

HOW DO THE SIDE AIRBAGS WORK



WARNING: Do not place objects or mount equipment on or near the airbag cover, on the side of the front seat backrests, or in areas that may come into contact with a deploying airbag. Failure to follow this instruction could result in personal injury or death.



WARNING: Accessory seat covers not released by Ford Motor Company could prevent the deployment of the airbags and increase the risk of injuries in a crash.

Airbags



WARNING: Do not lean your head on the door. The side airbag could injure you as it deploys from the side of the seatback.

The side airbags are on the outermost side of the seat backrests of the front seats. In certain sideways crashes or rollovers, the airbags will be inflated. The airbag was designed to inflate between the door panel and occupant to further enhance the protection provided to occupants in side impact crashes.



The system consists of the following:

- A label or embossed side panel indicating that side airbags are fitted to your vehicle.
- Side airbags inside the driver and front passenger seat backrests.
- Crash sensors and monitoring system with readiness indicator. See **Crash Sensors and Airbag Indicator** (page 66).

HOW DOES THE SAFETY CANOPY™ WORK



WARNING: Do not lean your head on the door. The curtain airbag could injure you as it deploys from the side rail trim or A-pillar. Failure to follow this instruction could result in personal injury or death.



WARNING: To reduce risk of injury, do not obstruct or place objects in the deployment path of the airbag.

The Safety Canopy deploys during significant side crashes or when a certain likelihood of a rollover event is detected by the rollover sensor. The Safety Canopy is mounted to the roof side rail sheet metal, behind the side rail trim, above each row of seats. In certain sideways crashes or rollover events, the Safety Canopy will be activated, regardless of which seats are occupied. The Safety Canopy inflates between the side window area and occupants to further enhance protection provided in side impact crashes and rollover events.

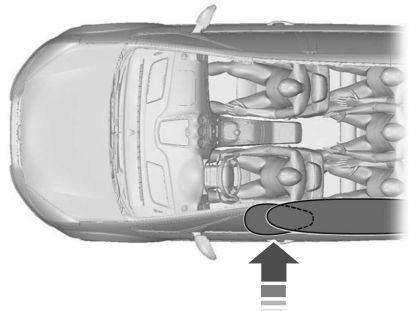

Airbags

The system consists of the following:

- Safety Canopy curtain airbags above the trim panels over the front and rear side windows identified by a label or wording on the side rail trim or the roof-pillar trim.
- Side rail trim which opens above the side doors to allow air curtain deployment



• Crash sensors and monitoring system with a readiness indicator. See **Crash Sensors and Airbag Indicator** (page 66).

Properly restrain children 12 years old and under in the rear seats. The Safety Canopy will not interfere with children restrained using a properly installed child or booster seat because it is designed to inflate downward from the side rail trim above the doors along the side window opening.



WARNING: Do not place objects or mount equipment on or near the side rail trim or A-pillar that may come into contact with a deploying curtain airbag. Failure to follow this instruction could result in personal injury or death.

4-Door

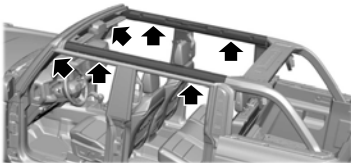

2-Door

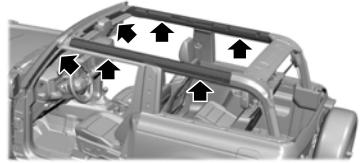

AIRBAG PRECAUTIONS



WARNING: Airbags do not inflate slowly or gently, and the risk of injury from a deploying airbag is the greatest close to the trim covering the airbag module.



WARNING: All occupants of your vehicle, including the driver, should always properly wear their seatbelts, even when an airbag supplemental restraint system is provided. Failure to properly wear your seatbelt could seriously increase the risk of injury or death.





WARNING: Properly secure children 12 years old and under in a rear seating position whenever possible. If you are unable to properly secure all children in a rear seating position, properly secure the largest child on the front seat. If you must use a forward facing child restraint on the front seat, move the seat as far back as possible. Failure to follow these instructions could result in personal injury or death.





WARNING: Do not place your arms on the airbag cover or through the steering wheel. Failure to follow this instruction could result in personal injury.

Airbags

 **WARNING:** Keep the areas in front of the airbags free from obstruction. Do not affix anything to or over the airbag covers. Objects could become projectiles during airbag deployment. Failure to follow this instruction could result in personal injury or death.

 **WARNING:** To reduce risk of injury, do not obstruct or place objects in the deployment path of the airbag.

 **WARNING:** Do not place a rearward facing child restraint in front of an active airbag. Failure to follow this instruction could result in personal injury or death.

 **WARNING:** Do not attempt to service, repair, or modify the supplementary restraint system or associated components. Failure to follow this instruction could result in personal injury or death.

 **WARNING:** Several airbag system components get hot after inflation. To reduce the risk of injury, do not touch them after inflation.

 **WARNING:** If a supplementary restraint system component has deployed, it will not function again. Have the system and associated components inspected as soon as possible. Failure to follow this instruction could result in personal injury or death.

PROPERLY ADJUSTING THE DRIVER AND FRONT PASSENGER SEATS

 **WARNING:** National Highway Traffic Safety Administration (NHTSA) recommends a minimum distance of at least 10 in (25 cm) between an occupant's chest and the driver airbag module.

To properly position yourself away from the airbag:

- Move your seat to the rear as far as you can while still reaching the pedals comfortably.
- Recline the seat slightly one or two degrees from the upright position.

After all occupants have adjusted their seats and put on seatbelts, it is very important that they continue to sit properly. Properly seated occupants sit upright, lean against the seat backrest, and center themselves on the seat cushion, with their feet comfortably extended on the floor. Sitting improperly can increase the chance of injury in a crash event. For example, if an occupant slouches, lies down, turns sideways, sits forward, leans forward or sideways, or puts one or both feet up, the chance of injury during a crash greatly increases.

CHILDREN AND AIRBAGS

 **WARNING:** Do not place a rearward facing child restraint in front of an active airbag. Failure to follow this instruction could result in personal injury or death.

Airbags



Children must always be properly restrained. Accident statistics suggest that children are safer when properly restrained in the rear seating positions than in the front seating position. Failure to follow these instructions may increase the risk of injury in a crash.

FRONT PASSENGER SENSING SYSTEM

WHAT IS THE FRONT PASSENGER SENSING SYSTEM

This system detects a properly seated occupant and determines if the front passenger airbag should be enabled.

HOW DOES THE FRONT PASSENGER SENSING SYSTEM WORK

The system uses a passenger airbag status indicator which illuminates indicating that the front passenger frontal airbag is either enabled or disabled.

Note: *When you first switch the ignition on, the passenger airbag status indicator off and on lamps illuminate for a short period to confirm they are functional.*



The indicator lamps are in the center stack of the instrument panel.

The front passenger sensing system is designed to disable the front passenger frontal airbag under these conditions:

- The front passenger seat is unoccupied.
- The system determines an infant is present in a child restraint.
- A passenger takes their weight off of the seat for a period of time.
- If there is a problem with the airbag system or the passenger sensing system.

Even with this technology, parents are strongly encouraged to always properly restrain children in the rear seat.

- When the front passenger sensing system disables the front passenger frontal airbag, the passenger airbag status indicator illuminates the off lamp.
- If you have installed the child restraint and the passenger airbag status indicator illuminates the on lamp, switch your vehicle off, remove the child restraint from your vehicle and reinstall the restraint following the child restraint manufacturer's instructions.

The front passenger sensing system works with sensors that are part of the front passenger seat and seatbelt. The sensors are designed to detect the presence of a properly seated occupant and determine if the front passenger frontal airbag should be enabled.

Airbags

- When the front passenger sensing system enables the front passenger frontal airbag, the passenger airbag status indicator illuminates the on lamp.

If a person of adult size is sitting in the front passenger seat, but the passenger airbag status indicator off lamp is illuminated, it is possible that the person is not sitting properly in the seat. If this happens:

- Switch your vehicle off and ask the person to place the seat backrest in an upright position.
- Have the person sit upright in the seat, centered on the seat cushion, with the person's legs comfortably extended.
- Restart your vehicle and have the person remain in this position for about two minutes. This allows the system to detect that person and enable the passenger frontal airbag.
- If the indicator off lamp remains illuminated even after this, you should advise the person to ride in the rear seat.

After all occupants have adjusted their seats and put on seatbelts, it is very important that they continue to sit upright, leaning against the seat backrest, and centered on the seat cushion, with their feet comfortably extended on the floor.

Sitting improperly can increase the chance of injury in a crash event. For example, if an occupant slouches, lies down, turns sideways, sits forward, leans forward or sideways, or puts one or both feet up, the chance of injury during a crash greatly increases.

If you think that the state of the passenger airbag status indicator lamp is incorrect, check for the following:

- Objects lodged underneath the seat.
- Objects between the seat cushion and the center console.

- Objects hanging off the seat backrest.
- Objects stowed in the seat backrest map pocket.
- Objects placed on the occupant's lap.
- Cargo interference with the seat
- Other passengers pushing or pulling on the seat.
- Rear passenger feet and knees resting or pushing on the seat.

The listed conditions could cause the weight of a properly seated occupant to be incorrectly interpreted by the front passenger sensing system. The person in the front passenger seat could appear heavier or lighter due to the conditions listed.



Make sure the front passenger sensing system is operating properly. See **Crash Sensors and Airbag Indicator** (page 66).

If the airbag readiness light is on, do the following:

- Pull your vehicle over.
- Switch your vehicle off.
- Check for any objects lodged underneath the front passenger seat or cargo interfering with the seat.
- Remove the obstruction if found.
- Restart your vehicle.
- Wait at least two minutes and verify that the airbag readiness light in the instrument cluster is no longer illuminated.
- If the airbag readiness light in the instrument cluster remains illuminated, there may be a problem due to the front passenger sensing system.

Do not attempt to repair or service the system. Take your vehicle in for service immediately.

Airbags

If it is necessary to modify an advanced front airbag system to accommodate a person with disabilities, contact your Customer Relationship Center. See **Contacting Us** (page 15).

FRONT PASSENGER SENSING SYSTEM PRECAUTIONS



WARNING: Sitting improperly, out of position or with the seatback reclined too far can take weight off the seat cushion and affect the decision of the passenger sensing system, resulting in serious injury or death in the event of a crash. Always sit upright against your seat back, with your feet on the floor.



WARNING: Any alteration or modification to the front passenger seat may affect the performance of the front passenger sensing system. This could seriously increase the risk of injury or death.

FRONT PASSENGER SENSING SYSTEM INDICATORS

Occupant	Passenger Airbag Status Indicator	Passenger Airbag
Empty	OFF: Illuminated	Disabled
	ON: Not Illuminated	
Child	OFF: Illuminated	Disabled
	ON: Not Illuminated	
Adult	OFF: Not Illuminated	Enabled
	ON: Illuminated	

Airbags

CRASH SENSORS AND AIRBAG INDICATOR



WARNING: Modifying or adding equipment to the front end of your vehicle (including hood, bumper system, frame, front end body structure, tow hooks and hood pins) may affect the performance of the airbag system, increasing the risk of injury. Do not modify or add equipment to the front end of your vehicle.

Your vehicle has a collection of crash and occupant sensors. These sensors provide information to the restraints control module which activates the following:

- Front and rear seatbelt pretensioners.
- Driver airbag.
- Passenger airbag.
- Seat mounted side airbags.
- Safety Canopy.

Based on the type of crash, the restraints control module deploys the appropriate safety devices.

The restraints control module also monitors the readiness of the above safety devices plus the crash and occupant sensors. The readiness of the safety system is indicated by a warning indicator light in the instrument cluster or by a backup tone if the warning light is not working. Routine maintenance of the airbag is not required.

A difficulty with the system is indicated by one or more of the following:



The readiness light will not illuminate immediately after you switch the ignition on.

- The readiness light either flashes or stays on.
- You hear a series of five tones. The tone pattern repeats periodically until the problem, the light or both are repaired.

If any of these things happen, even intermittently, have the supplemental restraint system serviced immediately. Unless serviced, the system may not function properly in the event of a crash.

The fact that the seatbelt pretensioners or front airbags did not activate for both front seat occupants in a crash does not mean that something is wrong with the system. Rather, it means the restraints control module determined the accident conditions (crash severity, seatbelt usage) were not appropriate to activate these safety devices.

- The front airbags activate only in frontal and near-frontal crashes. Front airbags may activate in rollovers, side impacts or rear impacts if the crash causes sufficient frontal deceleration.
- The seatbelt pretensioners activate in frontal, near-frontal and side crashes, and in rollovers.
- The side airbags inflate in certain side impact crashes or rollover events. Side airbags may activate in other types of crashes if the vehicle experiences sufficient sideways motion or deformation.
- The Safety Canopy inflates in certain side impact crashes or rollover events. The Safety Canopy may activate in other types of crashes if the vehicle experiences sufficient sideways motion or deformation, or a certain likelihood of rollover.

Airbags

DISPOSING OF AIRBAGS

Contact your authorized dealer as soon as possible. Airbags must be disposed of by qualified personnel.

911 Assist

WHAT IS 911 ASSIST

911 Assist is a SYNC system feature that can call for help.

For more information, visit www.owner.ford.com.

EMERGENCY CALL REQUIREMENTS



WARNING: Do not wait for 911 Assist to make an emergency call if you can do it yourself. Dial emergency services immediately to avoid delayed response time which could increase the risk of serious injury or death after a crash. If you do not hear 911 Assist within five seconds of the crash, the system or phone may be damaged or non-functional.



WARNING: Always place your phone in a secure location in your vehicle so it does not become a projectile or get damaged in a crash. Failure to do so may cause serious injury to someone or damage the phone which could prevent 911 Assist from working properly.



WARNING: Unless the 911 Assist setting is set on before a crash, the system will not dial for help which could delay response time, potentially increasing the risk of serious injury or death after a crash.

- SYNC is powered and working properly at the time of the incident and throughout feature activation and use.
- The 911 Assist feature must be set on before the incident.
- You must pair and connect a **Bluetooth®** enabled and compatible cell phone to SYNC.

- A connected **Bluetooth®** enabled phone must have the ability to make and maintain an outgoing call at the time of the incident.
- A connected **Bluetooth®** enabled phone must have adequate network coverage, battery power and signal strength.
- The vehicle must have battery power and be located in the U.S., Canada or in a territory in which 911 is the emergency number.

Note: *If any user sets 911 Assist to on or off, that setting applies for all paired phones. If 911 Assist is off and the phone connected to SYNC, an icon displays on the status bar.*

Note: *Every phone operates differently. While SYNC 911 Assist works with most cellular phones, some may have trouble using this feature.*

EMERGENCY CALL LIMITATIONS

The SYNC 911 Assist feature only operates in the U.S., Canada or in a territory in which 911 is the emergency number. The following are limitations of this feature:

- Your cellular phone or 911 Assist hardware sustains damage in a crash.
- The vehicle's battery or the SYNC system has no power.
- The phone(s) thrown from your vehicle are the ones paired and connected to the system.

Keys and Remote Controls

REMOTE CONTROL LIMITATIONS



WARNING: Changes or modifications not expressly approved by the party responsible for compliance could void the user's authority to operate the equipment. The term "IC:" before the radio certification number only signifies that Industry Canada technical specifications were met.

This device complies with Part 15 of the FCC Rules and with Industry Canada license-exempt RSS standard(s). Operation is subject to the following two conditions: (1) This device may not cause harmful interference, and (2) This device must accept any interference received, including interference that may cause undesired operation.

Make sure a valid remote control is within 5 ft (1.5 m) from the front door handles and rear of vehicle.

The system may not function if:

- The remote control remains stationary for about a minute.
- The vehicle battery has no charge.
- The remote control battery has no charge.
- There is interference causing issues with the remote control frequencies.
- The remote control is too close to metal objects or electronic devices, for example keys or a cell phone.

USING THE REMOTE CONTROL

Use your remote control to access various vehicle systems.

Note: *The buttons on your remote may vary depending on the vehicle region or options.*

Unlock



Press the button to unlock all doors. See **Unlocking and Locking the Doors Using the Remote Control** (page 78).

Lock



Press the button to lock all doors. See **Unlocking and Locking the Doors Using the Remote Control** (page 78).

Remote Start (If Equipped)



Press the button to remote start. See **Remotely Starting and Stopping the Vehicle** (page 114).

Panic Alarm (If Equipped)



Press the button to sound the panic alarm. See **Sounding the Panic Alarm** (page 70).

Keys and Remote Controls

REMOVING THE KEY BLADE



Push the release button on your passive key and pull the key blade out.

SOUNDING THE PANIC ALARM



Press the button to sound the panic alarm. Press the button again or switch the ignition on to turn it off.

Note: *The panic alarm only operates when the ignition is off.*

LOCATING YOUR VEHICLE



Press the lock button twice within three seconds. The turn signal lamps flash. We recommend you use this method to locate your vehicle.

CHANGING THE REMOTE CONTROL BATTERY



WARNING: Keep batteries away from children to prevent ingestion. Failure to follow this instruction could result in personal injury or death. If ingested, immediately seek medical attention.



WARNING: If the battery compartment does not securely close, stop using the remote control and replace it as soon as possible. In the meantime, keep the remote control away from children. Failure to follow this instruction could result in personal injury or death.

The remote control uses one coin-type 3-volt lithium battery CR2450 or equivalent.



1. Push the release button and pull the key blade out.

Keys and Remote Controls

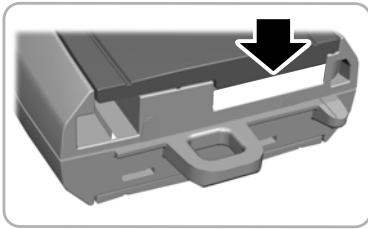

2. Twist a thin coin under the tab hidden behind the key blade head to remove the battery cover.
-
- A diagram showing the transmitter housing with the battery cover being lifted away. A white arrow points up from the cover, and a black arrow points down from the housing, indicating the removal process.

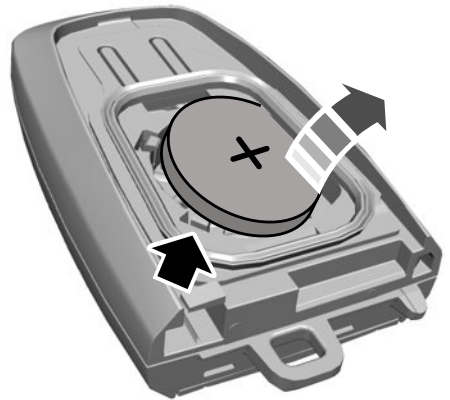

3. Insert a screwdriver, and carefully remove the battery.
4. Install a new battery with the + facing upward.
5. Reinstall the battery housing cover onto the transmitter and install the key blade.



Dispose of old batteries in an environmentally friendly way. Seek advice from your local authority about recycling old batteries.

Note: Do not wipe off any grease on the battery terminals or on the back surface of the circuit board.

Note: Replacing the battery does not erase the programmed key from your vehicle. The remote control should operate normally.

REPLACING A LOST KEY OR REMOTE CONTROL

You can purchase replacement keys or remote controls from an authorized dealer. Authorized dealers can program remote controls for your vehicle.

Keys and Remote Controls

PROGRAMMING THE REMOTE CONTROL

You must have two previously programmed remote controls inside your vehicle and the new, unprogrammed remote controls readily accessible. Contact an authorized dealer to have the spare remote control programmed if two previously programmed remote controls are not available. Make sure that your vehicle is off before beginning this procedure.

Make sure that you close all the doors before beginning and that they remain closed throughout the procedure. Perform all steps within 30 seconds of starting the sequence. Stop and wait for at least one minute before starting again if you perform any steps out of sequence.

Note: You can program a maximum of four remote controls to your vehicle.

Note: If your programmed remote controls get lost or stolen and you do not have an extra coded remote, you need to have your vehicle towed to an authorized dealer. Store an extra programmed remote away from your vehicle in a safe place to help prevent any inconvenience. Contact an authorized dealer to purchase additional spare or replacement remote controls.

Read and understand the entire procedure before you begin.

Programming Backup Location

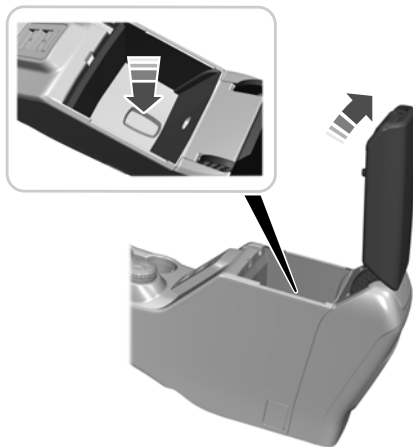

1. Place the first programmed remote in the backup slot inside the center console. With your foot off the brake pedal, press and release the push button ignition switch.
2. Wait five seconds and then press and release the push button ignition switch again.
3. Remove the remote control.
4. Within 10 seconds, place a second programmed remote control in the backup slot. Press and release the push button ignition switch.
5. Wait five seconds and then press and release the push button ignition switch again. Keep the ignition on for at least 3 seconds, but no more than 10 seconds.
6. Remove the remote control.
7. Place the unprogrammed remote control in the backup slot and press and release the push button ignition switch.

Keys and Remote Controls

Programming is now complete. With your foot on the brake pedal, press the push button ignition switch to verify the remote control functions operate and your vehicle starts with the new remote control.

If programming was not successful, wait 10 seconds and repeat Steps 1 through 7. If you are still unsuccessful, take your vehicle to an authorized dealer.

KEYS AND REMOTE CONTROLS – TROUBLESHOOTING

KEYS AND REMOTE CONTROLS – INFORMATION MESSAGES

Message	Action
Key Battery Low Replace Soon	Displays when the remote control battery requires replacing.

WHAT IS MYKEY

MyKey allows you to program keys with restricted driving modes to promote good driving habits.

MYKEY SETTINGS

NON-CONFIGURABLE MYKEY SETTINGS

Seatbelt Reminder or Belt-Minder™

MyKey mutes the audio system until the front seat passengers buckle the front seat belts.

Note: *If your vehicle includes an AM/FM radio or a very basic audio system, then the radio may not mute.*

Satellite Radio (If Equipped)

Some Satellite radio channels have restricted access to adult radio content.

Early Low Fuel

The low fuel level warning lamp turns on earlier.

Driving and Parking Aids

You cannot configure settings for parking aids, blind spot information system, and cross traffic alert. These systems turn on when the vehicle turns on, and you cannot switch them off with a MyKey.

You cannot configure settings for pre-collision assist and lane keeping. These systems turn on when the vehicle turns on, but you can switch them off with a MyKey.

A new destination in the navigation system can only be set using voice commands when using a MyKey, and with your vehicle moving.

Note: *MyKey drivers may be able to switch the lane departure warning feature off, but this feature turns back on automatically with every new key cycle.*

CONFIGURABLE MYKEY SETTINGS

You can configure the following settings after creating a MyKey. See **Creating a MyKey** (page 75).

Speed Limit



WARNING: Do not set MyKey maximum speed limit to a limit that will prevent the driver from maintaining a safe speed considering posted speed limits and prevailing road conditions. The driver is always responsible to drive in accordance with local laws and prevailing conditions. Failure to do so could result in accident or injury.

You can set a speed limit for your vehicle. Warning messages appear in the information display and a tone sounds if your vehicle reaches the set speed. You cannot override the set speed when using a MyKey.

Speed Minder

You can set a speed reminder for your vehicle. Warning messages appear in the information display and a tone sounds if your vehicle exceeds the set speed.

Audio System Volume Limit

The audio system maximum volume reduces. A message appears in the information display if you attempt to exceed the volume limit. Automatic volume control turns off.

Emergency Assistance

If you set emergency assistance to always on, you cannot switch it off with a MyKey.

Do Not Disturb

If you set do not disturb to always on, you cannot switch it off with a MyKey.

Note: *If a phone is connected using Apple CarPlay or Android Auto while driving with a MyKey, the driver can receive phone calls and text messages even if the do not disturb restriction is on, and if the vehicle comes with satellite radio, there is no restriction on the adult content.*

Traction and Stability Control

If you set traction control or stability control to always on, you cannot switch it off with a MyKey.

CREATING A MYKEY

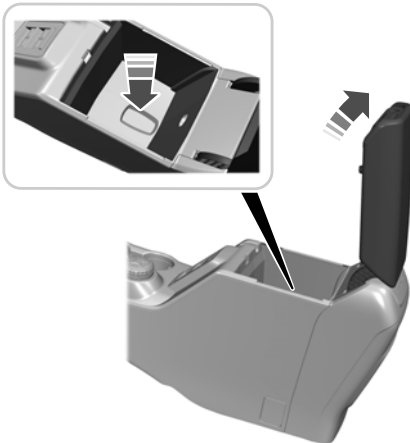

1. Raise the console storage compartment lid.

2. Place the intelligent access key in the position shown.
3. Switch the ignition on.
4. Using your touchscreen, press **Menu**.
5. Press **Settings**.
6. Press **Vehicle**.
7. Press **MyKey**.
8. Press **Create MyKey**.
9. Press **Yes** if you want to create the key as a MyKey. A confirmation message appears on the screen.
10. Switch the ignition off.

Note: *We recommend that you label this key.*

PROGRAMMING A MYKEY

You can program any remote control to become a restricted MyKey, but you must leave one unmodified as an admin key.

1. Switch the ignition on using an admin key.
2. Press **Settings** on the touchscreen.
3. Press **Vehicle Settings**.
4. Press **MyKey**.
5. Select a setting and press the **OK** button.
6. Configure the setting

CLEARING ALL MYKEYS

When you clear all MyKeys, you remove all restrictions and return all MyKeys to their original admin key status.

1. Switch the ignition on using an admin key.
2. Press **Settings** on the touchscreen.
3. Press **Vehicle Settings**.
4. Press **MyKey**.

5. Press **Clear All MyKeys**.
6. Press **Yes**.

3. Press **Vehicle Settings**.
4. Press **MyKey**.
5. Press **MyKey Information**.

CHECKING MYKEY SYSTEM STATUS

You can find information about the distance traveled using a MyKey, and the number of admin keys and MyKeys created for your vehicle.

1. Switch the ignition on.
2. Press **Settings** on the touchscreen.

USING MYKEY WITH REMOTE START SYSTEMS

MyKey is not compatible with unapproved, aftermarket remote start systems. If you choose to install a remote start system, see an authorized dealer for an approved remote start system.

MYKEY – TROUBLESHOOTING

MYKEY – INFORMATION MESSAGES

Message	Description
Place Key in Backup Location	Displays when trying to create a MyKey and the admin key is not placed in the backup position. See Creating a MyKey (page 75).
Key is Already a MyKey	Displays when trying to create a MyKey with a key already designated as a MyKey.
This Key restricted at Next Key Cycle. Label Key as MyKey	Displays to confirm that the key is restricted after you switch the ignition off.

MYKEY – FREQUENTLY ASKED QUESTIONS

What is an admin key?

An admin key is a key that you have not created as a MyKey. See **Creating a MyKey** (page 75).

Why am I not able to create a MyKey?

You have not placed the admin key in the backup position. See **Creating a MyKey** (page 75). The key used to switch the ignition on is not an admin key. The key used to switch the ignition on is the only admin key. There has to be at least one admin key. You did not switch the ignition off after creating the last MyKey.

Why am I not able to program a MyKey?

The admin key is not inside your vehicle. The key used to switch the ignition on is not an admin key. You have not created any MyKeys. See **Creating a MyKey** (page 75).

Why am I not able to clear the MyKeys?

The admin key is not inside your vehicle. The key used to switch the ignition on is not an admin key. You have not created any MyKeys. See **Creating a MyKey** (page 75).

Why is the MyKey distance not accumulating?

The key used to start the engine is an admin key. An admin key and a MyKey are inside your vehicle. You have not created any MyKeys. See **Creating a MyKey** (page 75). You have cleared the MyKeys. See **Clearing All MyKeys** (page 75).

Why am I not able to start the engine with a MyKey?

An admin key and a MyKey are inside your vehicle. The system recognizes only the admin key when both are present.

Doors and Locks

OPERATING THE DOORS FROM OUTSIDE YOUR VEHICLE

UNLOCKING AND LOCKING THE DOORS USING THE REMOTE CONTROL

You can only use the remote control when your vehicle is stationary.

Unlocking the Doors



Press the button to unlock all doors.

Locking the Doors



Press the button to lock all doors. One short flash of the turn signal lamps confirms that your vehicle has locked.

Note: For more information on operating the doors from outside your vehicle See *Keyless Entry* (page 82).

OPERATING THE DOORS FROM INSIDE YOUR VEHICLE

UNLOCKING AND LOCKING THE DOORS USING THE CENTRAL LOCKING

The power door lock control is on the driver door.



Press the button to unlock all doors.



Press the button to lock all doors.

Note: The central locking only operates if the front doors are fully closed.

INDIVIDUALLY UNLOCKING AND LOCKING THE DOORS USING THE LOCKING BUTTON

The power door lock control is on the driver and front passenger door panels.

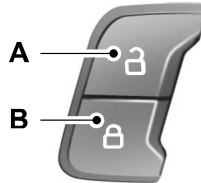

- A Unlock.
- B Lock.

AUTOUNLOCK

WHAT IS AUTOUNLOCK

Autounlock is an unlocking feature that unlocks the vehicle doors when your vehicle comes to a stop.

AUTOUNLOCK REQUIREMENTS

Autounlock unlocks all the doors when all of the following occur:

- The ignition is on, all the doors are closed and your vehicle is moving at a speed greater than 12 mph (20 km/h).
- Your vehicle comes to a stop.
- You open the driver door within 10 minutes of switching the ignition off or to the accessory position.

Doors and Locks

SWITCHING AUTOLOCK ON AND OFF

1. Press the menu button on the steering wheel to enter the information display main menu.
2. Select **Settings**.
3. Select **Vehicle**.
4. Select **Locks**.
5. Switch **Autolock** on or off.

AUTOLOCK

WHAT IS AUTOLOCK

Autolock is a locking feature that locks your vehicle doors when you start driving.

AUTOLOCK REQUIREMENTS

Autolock locks all the doors when all of the following occur:

- All doors are closed.
- The ignition is on.
- Your vehicle reaches a speed greater than 12 mph (20 km/h).

MISLOCK

WHAT IS MISLOCK

Mislock is a locking feature that warns you if your vehicle has not locked.

MISLOCK LIMITATIONS

When you press the lock button once, the direction indicators do not flash if:

- Any door or the tailgate is open.
- The hood is open.

If you switch mislock off, the horn does not sound if you press the lock button on the remote control when a door is open.

SWITCHING MISLOCK ON AND OFF

1. Press the menu button on the steering wheel to enter the information display main menu.
2. Select **Settings**.
3. Select **Vehicle**.
4. Select **Locks**.
5. Switch **Mislock Chirp** on or off.

DOORS AND LOCKS – TROUBLESHOOTING

DOORS AND LOCKS – WARNING LAMPS

Door Ajar Warning Lamp



It illuminates when you switch the ignition on and remains on if any door or the hood is open.

Doors and Locks

DOORS AND LOCKS – INFORMATION MESSAGES

Message	Action
Driver Door Ajar	Displays if a door is open. Fully close the door.
Passenger Door Ajar	
Rear Left Door Ajar	
Rear Right Door Ajar	

Doors and Locks

DOORS AND LOCKS – FREQUENTLY ASKED QUESTIONS

Can accessories such as steps or handles be used with the latch assembly?

Do not use the door latch assembly to attach any accessory, such as handles or steps, as this can cause damage to your vehicle.

Keyless Entry

KEYLESS ENTRY LIMITATIONS

Make sure your remote control is within 3 ft (1 m) from the front door handles and the tailgate.

The system could not function if:

- The remote control remains stationary for about a minute.
- The vehicle battery has no charge.
- The remote control battery has no charge.
- There is interference causing issues with the remote control frequencies.
- The remote control is too close to metal objects or electronic devices, for example keys or a cell phone.

KEYLESS ENTRY SETTINGS

Switching Keyless Entry On and Off

1. Switch the ignition on using an original key that has not been created as a MyKey.
2. Press **Settings** on the touchscreen.
3. Press **Vehicle Settings**.
4. Press **Locks**.

Reprogramming the Unlocking Function

You can enable two-stage unlocking function allowing you to unlock only the driver door when you touch the unlock sensor.

Press and hold both the lock and unlock buttons on the remote control for four seconds to disable or enable two-stage unlocking.

If you program the unlocking function so that only the driver door unlocks, you can unlock all of the other doors from inside your vehicle using the power door lock control. You can unlock individual doors by pulling the interior door handles on those doors.

USING KEYLESS ENTRY

Unlocking the Doors



With your passive key within 5 ft (1.5 m) of your vehicle, touch the unlock sensor on the back of the door handle for a brief period and then pull on the door handle to unlock, being careful not to touch the lock sensor at the same time or pull on the door handle too quickly. The intelligent access system requires a brief delay to authenticate your passive key.

Locking the Doors



With your passive key within 3 ft (1 m) of your vehicle, touch the outer door handle lock sensor for approximately one second to lock, being careful not to touch the unlock sensor on the back of the door handle at the same time. After locking, you can immediately pull on the door handle to confirm locking occurred without inadvertently unlocking.

Keyless Entry

KEYLESS ENTRY – TROUBLESHOOTING

KEYLESS ENTRY – FREQUENTLY ASKED QUESTIONS

Why does the keyless entry system not function?

If the system does not function it may be limited. See **Keyless Entry Limitations** (page 82). If the system still does not function use the remote control or the key blade to lock and unlock your vehicle.

Why can I not lock my vehicle?

If you electronically lock your vehicle with a rear door or the tailgate open, the system searches for a passive key inside your vehicle after you close the last door. If the system detects a key, all doors unlock indicating that a key is inside. Your vehicle locks if another passive key is within the detection range after you close the last door.

Why does the passive key not work?

The system deactivates passive keys left inside your vehicle when you lock it. You cannot switch the ignition on using a deactivated passive key. Press the unlock button on the remote control to reactivate a passive key.

Tailgate

OPENING THE TAILGATE

OPENING THE TAILGATE FROM OUTSIDE YOUR VEHICLE

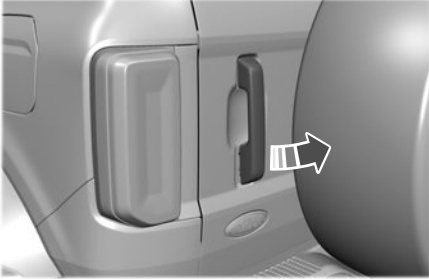

1. Unlock the vehicle with the remote control or power door unlock control.

Note: *If a passive key is within 3 ft (1 m) of the tailgate, the tailgate unlocks when you touch the inside of the tailgate handle.*

2. Pull the handle to release the tailgate.

CLOSING THE TAILGATE

CLOSING THE TAILGATE FROM OUTSIDE YOUR VEHICLE

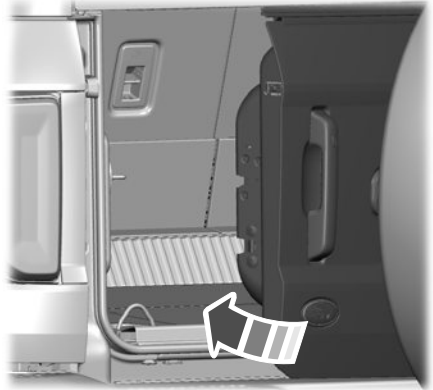

Push the tailgate until fully closed.

LOCKING AND UNLOCKING THE TAILGATE

You can lock or unlock your vehicle with the remote control or power door lock control.

Locking

If a passive key is within 3 ft (1 m) of the tailgate, touch the lock button on the tailgate handle to lock.

Tailgate

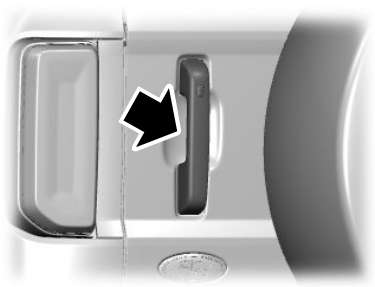
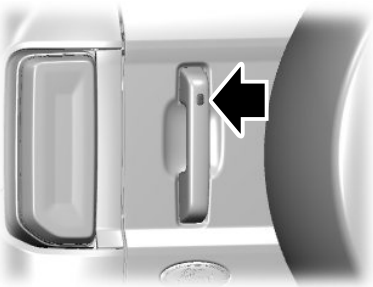

Emergency Locking

If there is a power door lock fault you can use the key blade to lock the tailgate door.

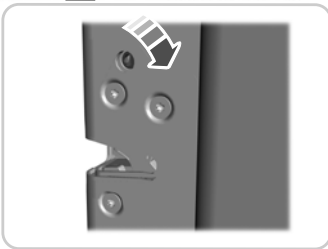
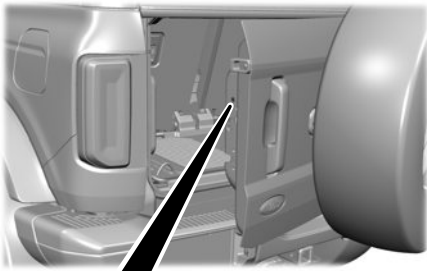

Emergency Unlocking

If there is a power door lock fault you can use the release lever to unlock the tailgate door.

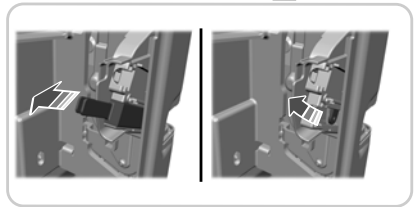
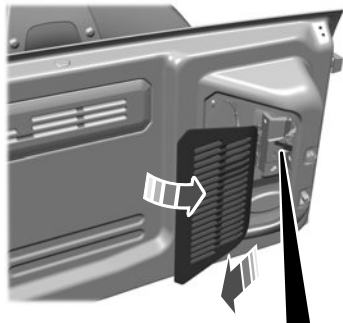

Unlocking

If a passive key is within 3 ft (1 m) of the tailgate, touch the back of the tailgate handle to unlock.

1. Remove the tailgate trim panel.
2. Remove the inside release lever cover.
3. Using a small tool, pull the release lever to open the tailgate.

Tailgate

TAILGATE – TROUBLESHOOTING

TAILGATE – WARNING LAMPS



Illuminates when the tailgate is not completely closed.

TAILGATE – INFORMATION MESSAGES

Tailgate

Message	Details
Tailgate Ajar	The tailgate is not completely closed.

Security

PASSIVE ANTI-THEFT SYSTEM

WHAT IS THE PASSIVE ANTI-THEFT SYSTEM

The passive anti-theft system prevents someone from starting the vehicle with an incorrectly coded key.

Note: Do not leave a duplicate coded key in your vehicle. Always take the keys and lock all the doors when leaving your vehicle.

HOW DOES THE PASSIVE ANTI-THEFT SYSTEM WORK

The passive anti-theft system arms when you switch the ignition off.

It disarms when the ignition is switched on with a correctly coded key.

Note: The system is not compatible with non-Ford aftermarket remote start systems.

Note: Do not leave a duplicate coded key in your vehicle. Always take the keys and lock all doors when leaving your vehicle.

SECURITY – TROUBLESHOOTING

SECURITY – INFORMATION MESSAGES

Message	Action
No Key Detected	The system has not detected a correctly coded key.
Starting System Fault	The system has malfunctioned. Have your vehicle checked as soon as possible.
Vehicle Alarm To Stop Alarm, Start Vehicle.	Displays when the alarm has been triggered due to unauthorized entry.
Alarm Announcement	

Security

SECURITY – FREQUENTLY ASKED QUESTIONS

What should I do if there is any potential alarm problem with my vehicle?

Take all remote controls to an authorized dealer if there is any potential alarm problem with your vehicle.

What should I do if the vehicle is unable to start with a correctly coded key?

Have your vehicle checked as soon as possible.

Steering Wheel

ADJUSTING THE STEERING WHEEL



WARNING: Do not adjust the steering wheel when your vehicle is moving.

Note: Make sure that you are sitting in the correct position. See **Sitting in the Correct Position** (page 126).

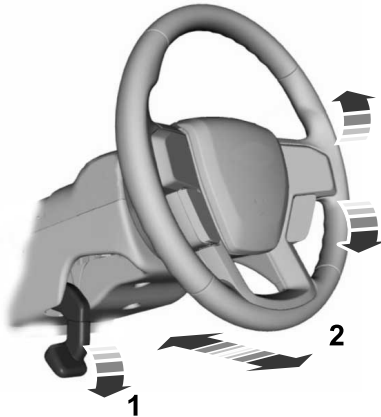

1. Unlock the steering column.
2. Adjust the steering wheel to the position you prefer.
3. Lock the steering column.

HORN



Press on the center of the steering wheel near the horn icon to activate the horn.

SWITCHING THE HEATED STEERING WHEEL ON AND OFF

(IF EQUIPPED)



To activate the heated steering wheel, press the button on the climate control unit.

On some vehicles, an indicator on the button illuminates when the heated steering wheel is on.

Note: A sensor regulates the temperature of the steering wheel.

Wipers and Washers

WIPERS

WIPER PRECAUTIONS

Do not operate the wipers on a dry windshield. This could scratch the glass or damage the wiper blades. Use the windshield washers before wiping a dry windshield.

Fully defrost the windshield before you switch the windshield wipers on.

Switch the windshield wipers off before entering a car wash.

SWITCHING WINDSHIELD WIPERS ON AND OFF

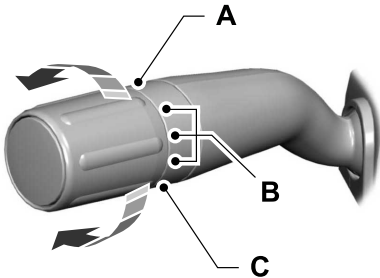

- A High-speed wipe.
- B Intermittent wipe.
- C Off.



Use the rotary control.

SWITCHING THE REAR WINDOW WIPER ON AND OFF



Rotate the control away from you for a long wipe interval.

Rotate the control toward you for a short wipe interval.

REVERSE WIPE

WHAT IS REVERSE WIPE

Reverse wipe turns on the rear window wiper when you shift into reverse (R) and the windshield wipers are on.

REVERSE WIPE SETTINGS

1. Press **Settings** on the touchscreen.
2. Press **Vehicle Settings**.
3. Press **Wipers**.
4. Switch **Rear Wiper On (when in Reverse)** on or off.

Wipers and Washers

CHECKING THE WIPER BLADES



Run the tip of your fingers over the edge of the blade to check for roughness.

REPLACING THE FRONT WIPER BLADES



1. Pull the wiper blade and arm away from the glass.

Note: Do not hold the wiper blade to lift the wiper arm.

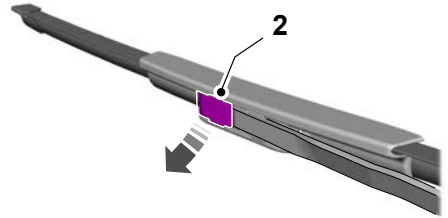

2. Lift the wiper blade primary locking clip.

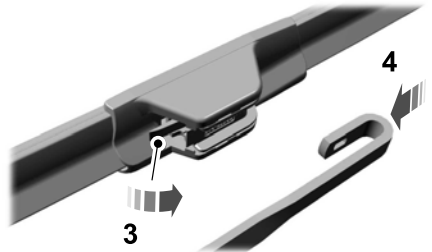

3. Press the wiper blade secondary locking clip.
4. Remove the wiper blade.

Note: Make sure that the wiper arm does not spring back against the glass when the wiper blade is not attached.

5. To install, reverse the removal procedure.

Note: Make sure that the wiper blade locks into place.

Wipers and Washers

REPLACING THE REAR WIPER BLADES

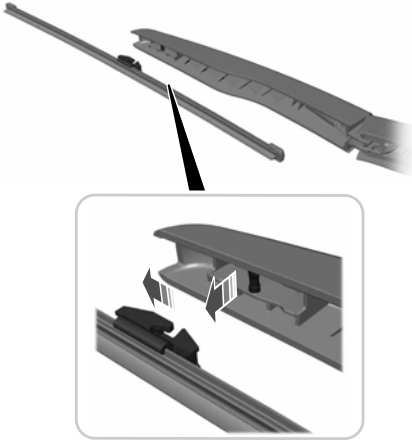

1. Lift the wiper arm.

Note: Do not hold the wiper blade to lift the wiper arm.

2. Remove the wiper blade.

Note: Make sure that the wiper arm does not spring back against the glass when the wiper blade is not attached.

3. To install, reverse the removal procedure.

Note: Make sure that the wiper blade locks into place.

WASHERS

WASHER PRECAUTIONS



WARNING: If you operate your vehicle in temperatures below 41°F (5°C), use washer fluid with antifreeze protection. Failure to use washer fluid with antifreeze protection in cold weather could result in impaired windshield vision and increase the risk of injury or accident.

Do not operate the washers when the washer reservoir is empty. This could cause the washer pump to overheat.

Keep the outside of the windshield clean. The rain sensor is very sensitive and the wipers may operate if dirt, mist or insects hit the windshield.

USING THE WINDSHIELD WASHER

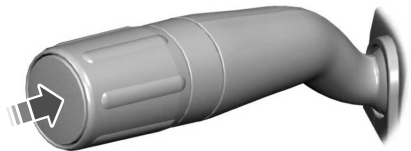

Press and hold the button at the end of the lever to operate the windshield washer.

Note: A courtesy wipe occurs a short time after the wipers stop to clear any remaining washer fluid when switched on. See **Switching the Courtesy Wipe On and Off** (page 93).

Wipers and Washers

SWITCHING THE COURTESY WIPE ON AND OFF

1. Press **Settings** on the touchscreen.
2. Press **Vehicle Settings**.
3. Press **Wipers**.
4. Switch **Courtesy Wipe** on or off.

USING THE REAR WINDOW WASHER



Rotate the control to the top or bottom position and hold it to operate the rear window washer.

Note: A courtesy wipe occurs a short time after the wipers stop to clear any remaining washer fluid when switched on. See **Switching the Courtesy Wipe On and Off** (page 93).

ADDING WASHER FLUID

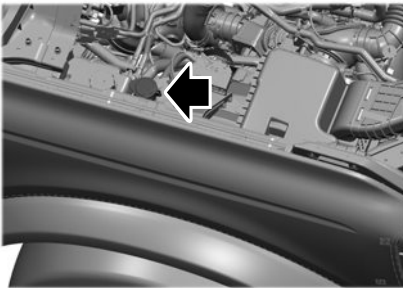

WASHER FLUID SPECIFICATION

See **Washer Fluid Specification** (page 402).

WIPERS AND WASHERS – TROUBLESHOOTING

WIPERS AND WASHERS – WARNING LAMPS



Illuminates when the windshield washer fluid is low.

WIPERS AND WASHERS – FREQUENTLY ASKED QUESTIONS

Why are there streaks and smears on the windshield?

The wiper blades could be dirty, worn or damaged. Check the wiper blades. See **Checking the Wiper Blades** (page 91). If the wiper blades are dirty, clean them with washer fluid or water applied with a soft sponge or cloth. If the wiper blades are worn or damaged, install new ones. See **Replacing the Front Wiper Blades** (page 91).

Exterior Lighting

EXTERIOR LIGHTING CONTROL

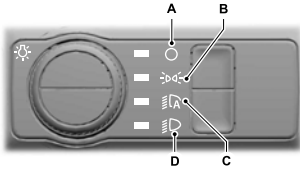

- A Lamps off.
- B Parking lamps on.
- C Autolamps on.
- D Headlamps on.

Rotate the control to make a selection.

Note: The lighting control defaults to autolamps every time you switch your vehicle on.

HEADLAMPS

USING THE HIGH BEAM HEADLAMPS

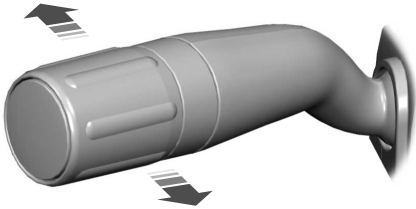

 Push the lever away from you to switch the high beam on.

Push the lever forward again or pull the lever toward you to switch the high beams off.

Slightly pull the lever toward you and release it to flash the headlamps.

HEADLAMP INDICATORS

Lamps On



Illuminates when you switch the low beam headlamps or the parking lamps on.

Headlamp High Beam



Illuminates when you switch the high beam headlamps on.

HEADLAMPS – TROUBLESHOOTING

HEADLAMPS – FREQUENTLY ASKED QUESTIONS

Why is there condensation in the headlamps?

Headlamps have vents to accommodate normal changes in air pressure. Condensation can be a natural by-product of this design. When moist air enters the lamp assembly through the vents, there is a possibility that condensation can occur when the temperature is cold. When normal condensation occurs, a fine mist can form on the interior of the lens. The fine mist eventually clears and exits through the vents during normal operation.

How much condensation is acceptable?

The presence of a fine mist, for example no streaks, drip marks or large droplets. A fine mist covers less than 50% of the lens.

Exterior Lighting

How long may it take for the acceptable condensation to be cleared?

Clearing time may take as long as 48 hours under dry weather conditions.

How much condensation is unacceptable?

A water puddle inside the lamp. Streaks, drip marks or large droplets present on the interior of the lens.

What should I do if unacceptable condensation is present?

Have your vehicle checked as soon as possible.

Why do my headlamps turn off when I have them switched on when I switch my vehicle off?

The battery saver turns the headlamps off after a short period of time after you switch your vehicle off.

AUTOLAMPS

WHAT ARE AUTOLAMPS



WARNING: The system does not relieve you of your responsibility to drive with due care and attention. You may need to override the system if it does not turn the headlamps on in low visibility conditions, for example daytime fog.

Autolamps turn the headlamps on in low light situations or when the windshield wipers operate.

AUTOLAMP SETTINGS

1. Press **Settings** on the touchscreen.
2. Press **Vehicle Settings**.
3. Press **Lighting**.

4. Press **Autolamp Delay**.
5. Press a setting.

EXTERIOR LAMPS

SWITCHING THE TURN SIGNAL LAMPS ON AND OFF

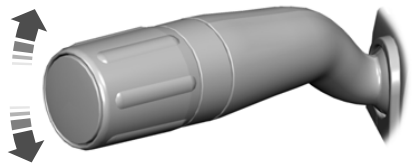

Push the lever up or down to switch the turn signal lamps on.

Set the lever to the middle position to switch the turn signal lamps off.

Note: Tap the lever up or down to make the turn signal lamps flash three times.

SWITCHING THE DAYTIME RUNNING LAMPS ON AND OFF - VEHICLES WITH: CONFIGURABLE DAYTIME RUNNING LAMPS



WARNING: The daytime running lamps system does not activate the rear lamps and may not provide adequate lighting during low visibility driving conditions. Make sure you switch the headlamps on, as appropriate, during all low visibility conditions. Failure to do so may result in a crash.

1. Press **Settings** on the touchscreen.

Exterior Lighting

2. Press **Vehicle Settings**.
3. Press **Lighting**.
4. Switch **Daytime Running Lights** on or off.

The daytime running lamps turn on when all of the following occur:

- You switch the system on.
- You switch your vehicle on.
- The transmission is not in park (P) for vehicles with automatic transmissions or you release the parking brake for vehicles with manual transmissions.
- The lighting control is in the autolamps position.
- The headlamps are off.

Note: Other lighting control positions do not turn on the daytime running lamps.

SWITCHING THE DAYTIME RUNNING LAMPS ON AND OFF - VEHICLES WITH: DAYTIME RUNNING LAMPS (DRL)



WARNING: The daytime running lamps system does not activate the rear lamps and may not provide adequate lighting during low visibility driving conditions. Make sure you switch the headlamps on, as appropriate, during all low visibility conditions. Failure to do so may result in a crash.

Daytime running lamps are always on unless you switch on the headlamps or your vehicle is in park (P).

SWITCHING THE FRONT FOG LAMPS ON AND OFF (If Equipped)

The front fog lamp button is on the lighting control.



Press the button to switch the front fog lamps on or off.

Note: Only switch the front fog lamps on during reduced visibility.

Note: The brightness of the daytime running lamps may decrease when the front fog lamps are switched on.

Note: When the lighting control is in the autolamps position, you cannot switch the fog lamps on unless the headlamps are on.

SWITCHING THE SPOT LAMPS ON AND OFF (If Equipped)

The spot lamp buttons are near the lighting control.



Press the button to switch on the left-hand spot lamp.



Press the button to switch on the right-hand spot lamp.

Move the position of the exterior mirrors to adjust the aim.

Note: The lighting control must be set to the parking lamp position.

Note: The spot lamps illuminate the area in front of and to the side of your vehicle.

EXTERIOR LAMP INDICATORS

Front Fog Lamp



It illuminates when you switch the front fog lamps on.

Turn Signal Lamp



It flashes when you switch the turn signal lamps on.

Note: An increase in the rate of flashing warns of a failed turn signal lamp.

Exterior Lighting

EXTERIOR LAMP AUDIBLE WARNING

Exterior Lamps On

Sounds when you open the driver door and the exterior lamps are on.

EXTERIOR ZONE LIGHTING (IF EQUIPPED)

WHAT IS EXTERIOR ZONE LIGHTING

Exterior zone lighting divides the exterior lighting into zones and allows you to switch them on and off to provide lighting around the perimeter of your vehicle.

USING THE EXTERIOR ZONE LIGHTING

1. Press **Features** on the touchscreen.
2. Press **Zone Lighting**.

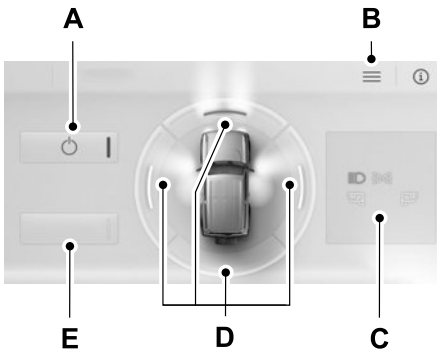

- A On and off button.
- B Settings menu.
- C Exterior lamp indicators.

- D Individual zones on and off.
- E All zones on and off.

You can use zone lighting when your vehicle is on or off. When it is off, the lighting turns off after a certain period of time.

You can also use individual zone controls to switch on each zone.

Note: Make sure to remove exterior lighting covers when using zone lighting.

Note: When your vehicle is off and the timer has one minute remaining, the turn signals flash six times.

Note: Indicators on the touchscreen illuminate when the lights outside of the zone lighting control are on.

Note: You can remotely control the zone lighting using the FordPass app.

EXTERIOR ZONE LIGHTING SETTINGS

When you access zone lighting for the first time, you can choose to allow zone lighting to override the autolamps when zone lighting is on.

You can change this setting at any time in the zone lighting settings menu.

1. Press **Features** on the touchscreen.
2. Press **Zone Lighting**.
3. Press the settings menu in the upper right-hand corner.
4. Press a setting.

Exterior Lighting

AUTOMATIC HIGH BEAM CONTROL

HOW DOES AUTOMATIC HIGH BEAM CONTROL WORK

Automatic high beam control turns the high beams on if it is dark enough and no other traffic is present. If it detects an approaching vehicle's headlamps or tail lamps, or street lighting ahead, the system turns the high beams off.

A camera sensor, centrally mounted behind the windshield of your vehicle, continuously monitors conditions to turn the high beams on and off.

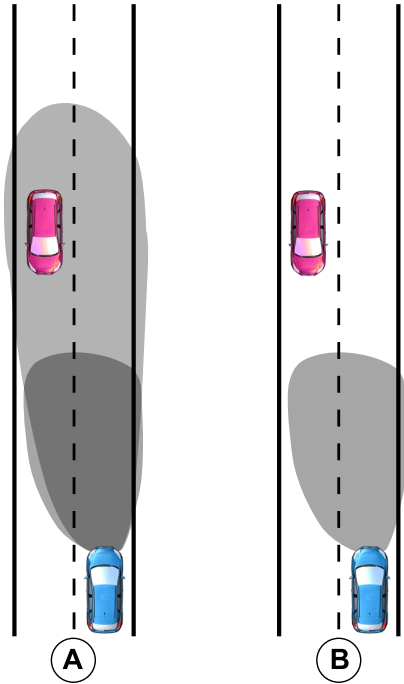

- A Without automatic high beam control.
- B With automatic high beam control.

AUTOMATIC HIGH BEAM CONTROL PRECAUTIONS



WARNING: The system does not relieve you of your responsibility to drive with due care and attention. You may need to override the system if it does not turn the high beams on or off.

Exterior Lighting



WARNING: Do not use the system in poor visibility, for example fog, heavy rain, spray or snow.



WARNING: You may need to override the system when approaching other road users.



WARNING: You may need to override the system during inclement weather.

AUTOMATIC HIGH BEAM CONTROL REQUIREMENTS

The system turns the high beams on if all of the following occur:

- You switch the system on.
- You set the lighting control to the autolamps position.
- The ambient light level is low enough that you require high beams.
- There is no traffic in front of your vehicle.
- The vehicle speed is greater than approximately 32 mph (52 km/h).

AUTOMATIC HIGH BEAM CONTROL LIMITATIONS

The system turns the high beams off if any of the following occur:

- You switch the system off.
- You set the lighting control to any position except autolamps.
- The ambient light level is high enough that you do not require high beams.
- The system detects an approaching vehicle's headlamps or rear lamps.
- The system detects severe rain, snow or fog.

- The system detects street lighting.
- The camera has reduced visibility.
- The vehicle speed falls below approximately 27 mph (44 km/h).

SWITCHING AUTOMATIC HIGH BEAM CONTROL ON AND OFF

1. Press **Settings** on the touchscreen.
2. Press **Vehicle Settings**.
3. Press **Lighting**.
4. Switch **Auto Highbeam** on or off.

AUTOMATIC HIGH BEAM CONTROL INDICATORS



Illuminates to confirm when the system is ready to assist.

OVERRIDING AUTOMATIC HIGH BEAM CONTROL

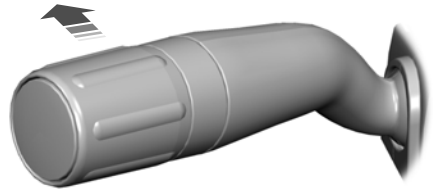

Push the lever away from you to switch the high beams on.

Push the lever away from you again to switch the high beams off.

Push the lever away from you for a third time to switch automatic high beam control back on.

Exterior Lighting

AUTOMATIC HIGH BEAM CONTROL – TROUBLESHOOTING

AUTOMATIC HIGH BEAM CONTROL – INFORMATION MESSAGES

Message	Description
Front Camera Low Visibility Clean Screen	The camera has reduced visibility. Clean the windshield. If the message continues to appear, have your vehicle checked as soon as possible.
Front Camera Temporarily Not Available	The camera has malfunctioned. Wait a short period of time for the camera to cool down. If the message continues to appear, have your vehicle checked as soon as possible.
Front Camera Malfunction Service Required	The camera has malfunctioned. Have your vehicle checked as soon as possible.

Interior Lighting

SWITCHING ALL OF THE INTERIOR LAMPS ON AND OFF

The lamps turn on under the following conditions:

- You open any door.
- You press a button on the remote control.
- You press the all lamps on button on the overhead console.



Press to switch all interior lamps on or off.

SWITCHING THE FRONT INTERIOR LAMPS ON AND OFF



The front interior lamp switches are on the overhead console.

Note: The position of each button on the overhead console depends on your vehicle.

Individual Map Lamps



Press to switch the left-hand individual dome lamp on and off.



Press to switch the right-hand individual dome lamp on and off.

SWITCHING THE REAR INTERIOR LAMPS ON AND OFF



The rear interior lamps may be above the rear seat or above the rear windows.



Press to switch the lamps on or off.

Note: If you switch the rear lamps on through the overhead console, you cannot switch them off with the rear lamp switch.

INTERIOR LAMP FUNCTION

WHAT IS THE INTERIOR LAMP FUNCTION

The interior lamp function switches the courtesy and door lamps on or off.

SWITCHING THE INTERIOR LAMP FUNCTION ON AND OFF



Press to switch the interior lamp function on and off.

Note: The indicator lamp illuminates amber when the door function is off.

Interior Lighting

ADJUSTING THE INSTRUMENT PANEL LIGHTING BRIGHTNESS

The instrument lighting dimmer buttons are on the lighting control.



Repeatedly press one of the buttons to adjust the brightness.



AMBIENT LIGHTING (IF EQUIPPED)

SWITCHING AMBIENT LIGHTING ON AND OFF

1. Press **Settings** on the touchscreen.
2. Press **Vehicle Settings**.
3. Press **Ambient Light**.
4. Switch **Ambient Light** on or off.

ADJUSTING AMBIENT LIGHTING

Drag the slider left or right.

INTERIOR LIGHTING – TROUBLESHOOTING

INTERIOR LIGHTING – FREQUENTLY ASKED QUESTIONS

Why do my courtesy lamps or interior lamps turn off when I have them switched on when I switch my vehicle off?

The battery saver turns the courtesy lamps and interior lamps off after a short period of time after you switch your vehicle off.

Windows

OPENING AND CLOSING THE WINDOWS



WARNING: Do not leave children unattended in your vehicle and do not let them play with the power windows. Failure to follow this instruction could result in personal injury.



WARNING: When closing the power windows, verify they are free of obstruction and make sure that children and pets are not in the proximity of the window openings.



Press the control to open the window. Lift the control to close the window.

Note: *The power windows operate with the ignition on, and for several minutes after you switch the ignition off or until you open a front door.*

To reduce wind noise or pulsing noise when one window is open, slightly open the opposite window.

Tailgate Window

To open the window, do the following:

1. Open the tailgate. See **Opening the Tailgate From Outside Your Vehicle** (page 84).
2. Lift the window.

To close the window, do the following:

1. Push the window down.
2. Close the tailgate. See **Closing the Tailgate From Outside Your Vehicle** (page 84).

WINDOW BOUNCE-BACK

WHAT IS WINDOW BOUNCE-BACK

The window stops and reverses if it detects an obstruction when closing.

OVERRIDING WINDOW BOUNCE-BACK



WARNING: If you override bounce-back, the window does not reverse if it detects an obstacle. Take care when closing the windows to avoid personal injury or damage to your vehicle.

1. Close the window until it reaches the point of resistance and let it reverse.
2. Lift and hold the window control switch within two seconds to override bounce-back and close the window. Bounce-back is now disabled and you can close the window manually.

Note: *The window goes past the point of resistance and you can fully close it.*

Note: *If the window does not close, have your vehicle checked as soon as possible.*

LOCKING THE REAR WINDOW CONTROLS



Press the window control switch to lock or unlock the rear window controls. It illuminates when you lock the rear window controls.

Interior Mirror

INTERIOR MIRROR PRECAUTIONS



WARNING: Do not adjust the mirrors when your vehicle is moving. This could result in the loss of control of your vehicle, serious personal injury or death.

Note: Do not clean the mirror housing or glass with harsh abrasives, fuel or other petroleum-based cleaning products.

MANUALLY DIMMING THE INTERIOR MIRROR

Pull the tab below the mirror toward you to reduce glare at night.

AUTO-DIMMING INTERIOR MIRROR (IF EQUIPPED)

WHAT IS THE AUTO-DIMMING INTERIOR MIRROR

The mirror dims to reduce the effect of bright light from behind. It returns to normal when the bright light from behind is no longer present or if you shift into reverse (R), to make sure you have a clear view when backing up.

AUTO-DIMMING INTERIOR MIRROR LIMITATIONS

Do not block the sensors on the front and back of the mirror.

Note: A rear center passenger or raised rear center head restraint could prevent light from reaching the sensor.

Exterior Mirrors

ADJUSTING THE EXTERIOR MIRRORS



WARNING: Do not adjust the mirrors when your vehicle is moving. This could result in the loss of control of your vehicle, serious personal injury or death.

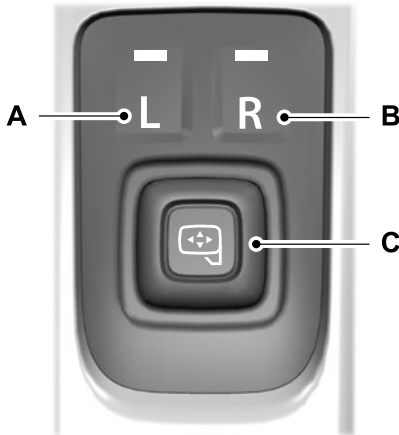

- A Left-hand mirror.
- B Right-hand mirror.
- C Adjustment control.

To adjust your mirrors, switch your vehicle on, with the ignition in accessory mode or the engine running.

1. Select the mirror you want to adjust. The control light turns on.
2. Use the adjustment control to adjust the position of the mirror.
3. Press the mirror control again. The control light turns off.

FOLDING THE EXTERIOR MIRRORS

Push the mirror toward the door window glass. Make sure that you fully engage the mirror in its support when returning it to its original position.

Instrument Cluster

INSTRUMENT CLUSTER OVERVIEW

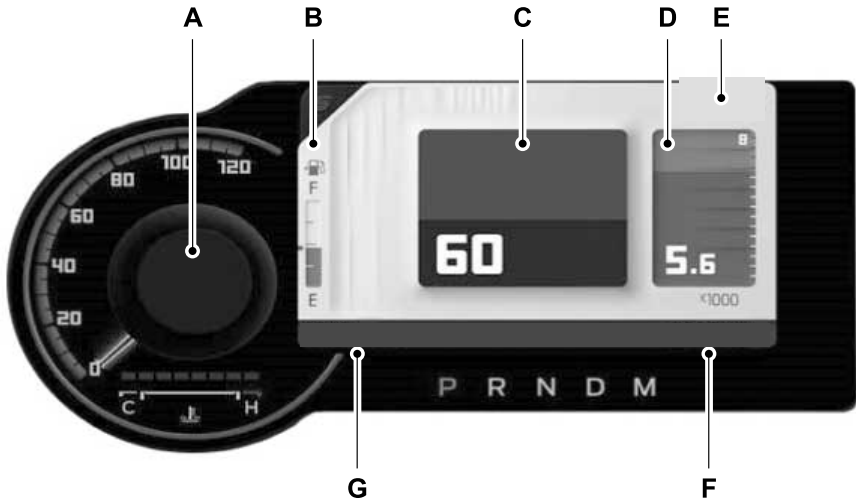

- A Speedometer.
- B Fuel gauge.
- C Digital speedometer.
- D Tachometer.
- E Compass and ambient temperature.
- F Odometer.
- G Distance to empty.

WHAT IS THE TACHOMETER

Indicates the engine speed.

WHAT IS THE SPEEDOMETER

Indicates the vehicle speed.

FUEL GAUGE

WHAT IS THE FUEL GAUGE

Indicates approximately how much fuel is in the fuel tank.

Instrument Cluster

FUEL GAUGE LIMITATIONS

The fuel gauge may not provide an accurate reading when your vehicle is on an incline.

LOCATING THE FUEL FILLER DOOR

The arrow adjacent to the fuel pump symbol indicates on which side of your vehicle the fuel filler door is located.

WHAT IS THE LOW FUEL REMINDER

A low fuel level reminder displays and sounds when the distance to empty reaches 75 mi (120 km) to empty for MyKey, and at 50 mi (80 km), 25 mi (40 km), 12 mi (20 km) and 0 mi (0 km) for all vehicle keys.

Note: *The low fuel reminder can appear at different fuel gauge positions depending on fuel economy conditions. This variation is normal.*

WHAT IS DISTANCE TO EMPTY

Indicates the approximate distance your vehicle can travel on the fuel remaining in the tank. Changes in driving pattern can cause the value to not only decrease but also increase or stay constant for periods of time.

WHAT IS THE ENGINE COOLANT TEMPERATURE GAUGE

Indicates the engine coolant temperature.

WHAT IS THE TRANSMISSION FLUID TEMPERATURE GAUGE

Indicates the transmission fluid temperature.

Special operating conditions can cause higher than normal operating temperatures. See **Special Operating Conditions Scheduled Maintenance** (page 457).

Note: *This is a configurable gauge.*

WHAT IS THE TURBO BOOST GAUGE - 2.3L ECOBOOST™

Indicates the amount of manifold air pressure in the engine.

Note: *This is a configurable gauge.*

WHAT IS THE INFORMATION BAR

Displays information for navigation, outside air temperature, odometer and distance to empty.

WHAT ARE THE INSTRUMENT CLUSTER WARNING LAMPS

Warning lamps alert you to a vehicle condition that could become serious. Some lamps illuminate when you start your vehicle to make sure they work. If any lamps remain on after starting your vehicle, refer to the respective system warning lamp for further information.

Instrument Cluster

INSTRUMENT CLUSTER WARNING LAMPS

Anti-Lock Brake System



If it illuminates when you are driving, this indicates a malfunction. Your vehicle continues to have normal braking without the anti-lock brake system function. Have your vehicle checked as soon as possible.

Battery



It illuminates when you switch the ignition on.

If it illuminates when the engine is running this indicates a malfunction. Have your vehicle checked as soon as possible.

Brake System Warning Lamp



It illuminates when you apply the parking brake and the ignition is on. If it illuminates when your



vehicle is moving, make sure the parking brake is released. If the parking brake is released, this

indicates low brake fluid level or the brake system requires service. Have your vehicle checked as soon as possible.

Note: Indicators may vary depending on region.

Door Ajar



It illuminates when you switch the ignition on and remains on if any door is open.

Electric Park Brake



It illuminates or flashes when the electric parking brake requires service.

Note: Indicators may vary depending on region.

Engine Coolant Temperature



If it illuminates, safely stop your vehicle and switch your vehicle off.

Fasten Seatbelt



It illuminates and a tone sounds until you fasten the seatbelts.

Hood Ajar



It illuminates when the ignition is on and the hood is not completely closed.

Low Beam Warning



It illuminates when the low beam headlamp bulb requires service. Have the system checked as soon as possible.

Low Fuel Level



It illuminates when the fuel level is low.

Low Tire Pressure



It illuminates when your tire pressure is low. If illuminated, check your tire pressure as soon as possible. If it begins to flash at anytime, have the system checked as soon as possible.

Instrument Cluster

Low Washer Fluid Level



It illuminates when the washer fluid is low.

Malfunction Indicator Lamp



It illuminates when the ignition is on and the engine is off, this is normal operation. If it illuminates when the engine is on this indicates that the emission control system requires service. If it flashes, have your vehicle checked immediately. See **Emission Law** (page 521).

Oil Pressure



It illuminates when the engine oil pressure is low.

Powertrain Malfunction



Illuminates when the powertrain requires service. Have the system checked as soon as possible.

Tailgate Ajar



It illuminates when the ignition is on and the tailgate is not completely closed.

WHAT ARE THE INSTRUMENT CLUSTER INDICATORS

Indicators notify you of various features that are active on your vehicle.

INSTRUMENT CLUSTER INDICATORS

Adaptive Cruise Control



See **Adaptive Cruise Control** (page 234).

Automatic Headlamp High Beam



See **Automatic High Beam Control** (page 98).

Auto-Start-Stop



See **Auto-Start-Stop** (page 161).

Blind Spot Monitor



See **Blind Spot Information System** (page 256).

Cruise Control



See **Cruise Control** (page 232).

Differential Lock



See **Electronic Locking Differential** (page 190).



Instrument Cluster

Drive Modes



See **G.O.A.T. Mode Control** (page 242).



Four-Wheel Drive



See **Four-Wheel Drive** (page 182).



Note: Some indicators will appear different depending on vehicle options.

Front Airbag



See **Airbags** (page 59).

Front Fog Lamp



See **Switching the Front Fog Lamps On and Off** (page 96).

Headlamp High Beam



See **Using the High Beam Headlamps** (page 94).

Hill Descent



See **Hill Descent Control** (page 217).

Lane Keeping System



See **Lane Keeping System** (page 249).

One Pedal Drive



See **Trail One Pedal Drive** (page 208).

Parking Lamps



See **Exterior Lighting** (page 94).

Pre-Collision Assist



See **Pre-Collision Assist** (page 262).



Instrument Cluster

Stability Control and Traction Control



See **Stability Control** (page 204). See **Traction Control** (page 202).



Stabilizer Bar Disconnect



See **Stabilizer Bar Disconnect** (page 214).

Trail Control



See **Trail Control** (page 207).

Trail Turn Assist



See **Trail Turn Assist** (page 212).



Tow Haul



See **Towing a Trailer** (page 283).

Turn Signal Lamps



See **Exterior Lamps** (page 95).

Instrument Cluster Display

USING THE INSTRUMENT CLUSTER DISPLAY CONTROLS



WARNING: Driving while distracted can result in loss of vehicle control, crash and injury. We strongly recommend that you use extreme caution when using any device that may take your focus off the road. Your primary responsibility is the safe operation of your vehicle. We recommend against the use of any hand-held device while driving and encourage the use of voice-operated systems when possible. Make sure you are aware of all applicable local laws that may affect the use of electronic devices while driving.

The controls are on the steering wheel.

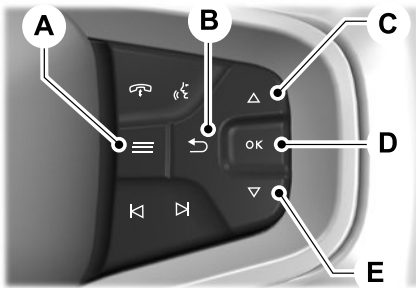

- A Menu button.
- B Return button.
- C Up button.
- D OK toggle button.
- E Down toggle button.

Return Button

Press to go back or to exit a menu.

OK Button

Press to make a selection. Press the toggle button up or down to scroll through menu items.

Menu Button

Press to display the submenus.

Toggle Buttons

Used to navigate the menus.

Status Indicator



Menu items with a check box indicates a feature's status. A check in the box indicates the feature is on, and unchecked indicates the feature is off.

INSTRUMENT CLUSTER DISPLAY MAIN MENU

Depending on your vehicle options, some menu items may appear different or not at all.

Note: For your safety, some features are speed-dependent and could be unavailable when your vehicle is above a certain speed.

Menu Item
MyView
Trip/Fuel
Off-Road
Navigation
Phone
Audio
Settings

Instrument Cluster Display

TRIP COMPUTER

ACCESSING THE TRIP COMPUTER

1. Select **Trip/Fuel**.
2. Select **Fuel Economy, Trip 1** or **Trip 2**.

RESETTING THE TRIP COMPUTER

1. Select **Trip/Fuel**.
2. Press and hold the **OK** button for a few seconds.

RESETTING THE INDIVIDUAL TRIP VALUES

1. Select **Trip/Fuel**.
2. Select **Trip 1** or **Trip 2**.
3. Press and hold the **OK** button for a few seconds.

PERSONALIZED SETTINGS

CHANGING THE INSTRUMENT CLUSTER DISPLAY LANGUAGE

Note: Available languages vary by region.

1. Press **Settings** on the touchscreen.
2. Press **General**.
3. Press **Language**.
4. Select a language.

CHANGING THE MEASURE UNIT

1. Press **Settings** on the touchscreen.
2. Press **General**.
3. Press **Measure Units**.
4. Select a measurement unit.

CHANGING THE TEMPERATURE UNIT

1. Press **Settings** on the touchscreen.
2. Press **General**.
3. Press **Temperature Units**.
4. Select **Fahrenheit** or **Celsius**.

CHANGING THE TIRE PRESSURE UNIT

1. Press **Settings** on the touchscreen.
2. Press **General**.
3. Press **Tire Pressure Units**.
4. Select a pressure unit.

Remote Start (If Equipped)

WHAT IS REMOTE START

The system allows you to remotely start your vehicle and to adjust the interior temperature according to the settings that you chose.

REMOTE START PRECAUTIONS



WARNING: Do not start the engine in a closed garage or in other enclosed areas. Exhaust fumes are toxic. Always open the garage door before you start the engine. Failure to follow this instruction could result in personal injury or death.

REMOTE START LIMITATIONS

Remote start does not work under the following conditions:

- The perimeter alarm is sounding.
- The hood is open.
- The transmission is not in park (P).
- The ignition is on.
- The check engine light is on.
- The battery voltage is below the minimum operating voltage.

Note: Do not use remote start if your fuel level is low.

Note: To use remote start with the Ford Pass or Phone as a Key, enable the modem. See **Connecting the Vehicle to a Wi-Fi Network** (page 409).

ENABLING REMOTE START

1. Press **Settings** on the touchscreen.
2. Press **Vehicle Settings**.

3. Press **Remote Start Setup**.
4. Switch **Remote Start** on or off.

Note: To remote start with FordPass, make sure that the modem is enabled. See **Connecting FordPass to the Modem** (page 409).

REMOTELY STARTING AND STOPPING THE VEHICLE

Remotely Starting the Vehicle



Press the button on the remote control.



Within three seconds, press the button on the remote control.

Within three seconds, press the button again.

Note: You can also use FordPass to start the vehicle.

Note: The turn signal lamps flash twice.

Note: The parking lamps turn on when the vehicle is running.

Note: The horn sounds if the system fails to start.

Note: All other vehicle systems remain off when you have remotely started the vehicle.

Note: The vehicle remains secured when you have remotely started the vehicle. A valid key must be inside your vehicle to switch the ignition on and drive your vehicle.

Remotely Stopping the Vehicle



Within three seconds, press the button on the remote control.

Within three seconds, press the button again.

Remote Start (If Equipped)

REMOTE START REMOTE CONTROL INDICATORS (IF

EQUIPPED)

Remote Control Feedback

An LED on the remote control provides status feedback of remote start or stop commands.

LED	Status
Solid green.	Remote start successful.
Solid red.	Remote stop successful.
Blinking red.	Request failed or status not received.
Blinking green.	Status incomplete.

REMOTE START SETTINGS

SWITCHING CLIMATE CONTROL AUTO MODE ON AND OFF

- Using the information display controls on the steering wheel, select **Settings**.
- Select **Vehicle**.
- Select **Remote Start**.
- Select **Climate Control**.
- Switch **Auto** on or off.

Note: If you switch the auto mode on, the system attempts to heat or cool the interior to 72°F (22°C).

Note: When you switch the ignition on, the climate control system returns to the last used settings.

Note: The heated windshield, heated rear window, heated mirrors, heated seats and heated steering wheel could turn on in cold weather.

SWITCHING CLIMATE CONTROL LAST SETTINGS ON AND OFF

- Using the information display controls on the steering wheel, select **Settings**.
- Select **Vehicle**.
- Select **Remote Start**.
- Select **Climate Control**.
- Switch **Last Settings** on or off.

Note: If you switch the last settings on, the system remembers the last used settings.

SWITCHING THE HEATED SEAT SETTINGS ON AND OFF

- Using the information display controls on the steering wheel, select **Settings**.
- Select **Vehicle**.
- Select **Remote Start**.
- Select **Front Seats**.
- Select **Auto** or **Off**.

Note: If you switch the heated seat settings on, the heated seats turn on during cold weather.

Note: You cannot adjust the heated seat settings when you have remotely started the engine.

SWITCHING THE HEATED STEERING WHEEL SETTINGS ON AND OFF

- Using the information display controls on the steering wheel, select **Settings**.
- Select **Vehicle**.
- Select **Remote Start**.
- Select **Front Seats & Wheel**.
- Select **Auto** or **Off**.

Note: If you switch the heated steering wheel settings on, the heated steering wheel turns on during cold weather.

Remote Start (If Equipped)

Note: *You cannot adjust the heated steering wheel settings when you have remotely started the engine.*

SETTING THE REMOTE START DURATION

You can set a duration for the vehicle to run.

Note: *Wait a few seconds before remotely starting the engine after the engine stops running.*

1. Using the information display controls on the steering wheel, select **Settings**.
2. Select **Vehicle**.
3. Select **Remote Start**.
4. Select **Duration**.

Climate Control - Vehicles With: Automatic Temperature Control

IDENTIFYING THE CLIMATE CONTROL UNIT



Depending on your vehicle options, the controls could look different than what you see here.

SWITCHING CLIMATE CONTROL ON AND OFF



Press the button.

SWITCHING RECIRCULATED AIR ON AND OFF



Press the button to recirculate air currently in the passenger compartment.

Note: *Recirculated air may turn off automatically, or prevent you from switching on in all air flow modes except MAX A/C to reduce the risk of fogging. Recirculation may also turn on and off automatically in various air distribution control combinations to improve heating or cooling efficiency.*

SWITCHING AIR CONDITIONING ON AND OFF



Press the button.

Note: *Under certain conditions, the air conditioning compressor could continue to operate after you switch air conditioning off.*

SWITCHING MAXIMUM DEFROST ON AND OFF



Press the button.

Air flows through the windshield air vents, the temperature is set to the highest setting, and the blower motor adjusts to the highest speed.

You can also use this setting to defog and clear the windshield of a thin covering of ice.

Note: *To prevent window fogging, you cannot select recirculated air when maximum defrost is on.*

Note: *The heated rear window and heated mirrors also turn on when you select maximum defrost.*

SWITCHING MAXIMUM COOLING ON AND OFF



Press the button.

Air flows through the instrument panel air vents, the temperature is set to the lowest setting, and the blower motor adjusts to the highest speed.

Note: *When you switch maximum cooling off, air conditioning remains on.*

Climate Control - Vehicles With: Automatic Temperature Control

SWITCHING THE HEATED REAR WINDOW ON AND OFF (IF

EQUIPPED)



Press the button to clear the rear window of thin ice and fog. The heated rear window turns off after a short period of time.

Note: This button also activates the heated mirrors.

Note: Do not use harsh chemicals, razor blades or other sharp objects to clean or remove decals from the inside of the heated rear window as this could cause damage to the heated rear window grid lines not covered by the vehicle Warranty.

SWITCHING THE HEATED MIRRORS ON AND OFF



Press the button.

SETTING THE BLOWER MOTOR SPEED



Press up or down on the control to select the blower motor speed.

SETTING THE TEMPERATURE

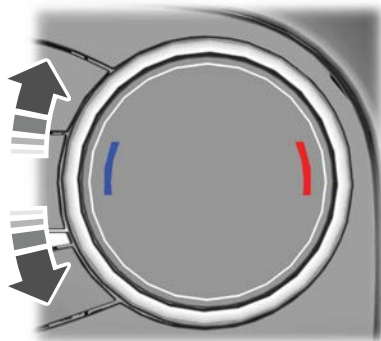

Turn the control on the left-hand side of the climate control to set the left-hand temperature.

Note: This control also sets the right-hand side temperature when you switch off dual zone mode.

Turn the control on the right-hand side of the climate control to set the right-hand temperature.

DIRECTING THE FLOW OF AIR

Directing Air to the Windshield Air Vents



Press the button to activate the selection screen.



Press the button on the touchscreen.

Directing Air to the Instrument Panel Air Vents



Press the button to activate the selection screen.

Climate Control - Vehicles With: Automatic Temperature Control



Press the button on the touchscreen.

Directing Air to the Footwell Air Vents



Press the button to activate the selection screen.



Press the button on the touchscreen.

AUTO MODE

SWITCHING AUTO MODE ON AND OFF



Press the button to switch auto mode on. Repeatedly press the button to adjust auto mode.

Note: When you switch auto mode on, lights on the blower motor control do not illuminate to indicate the blower motor speed.

Adjust the blower motor control or air distribution control to switch auto mode off.

AUTO MODE INDICATORS

The indicators are on the Auto Mode button.

Auto Mode Indicator Status	Description
One indicator illuminated.	The blower motor speed is reduced. Use this setting to minimize the amount of noise from the blower motor. This setting increases the time taken to cool the interior.
Two indicators illuminated.	The blower motor speed is moderate.
Three indicators illuminated.	The blower motor speed is increased. Use this setting to reduce the time taken to cool the interior. This setting increases the amount of noise from the blower motor.

Climate Control - Vehicles With: Automatic Temperature Control

SWITCHING DUAL MODE ON AND OFF



Press the button.

CLIMATE CONTROL HINTS

General Hints

- Prolonged use of recirculated air may cause the windows to fog up.
- You may feel a small amount of air from the footwell air vents regardless of the air distribution setting.
- To reduce humidity build-up inside your vehicle, do not drive with the system switched off or with recirculated air always switched on.
- Do not place objects under the front seats as this may interfere with the airflow to the rear seats.
- Remove any snow, ice or leaves from the air intake area at the base of the windshield.
- To improve the time to reach a comfortable temperature in hot weather, drive with the windows open until you feel cold air through the air vents.

Automatic Climate Control

- Adjusting the settings when your vehicle interior is extremely hot or cold is not necessary. Automatic mode is best recommended to maintain set temperature.
- The system adjusts to heat or cool the interior to the temperature you select as quickly as possible.
- For the system to function efficiently, the instrument panel and side air vents should be fully open.

- If you press **AUTO** during cold outside temperatures, the system directs air flow to the windshield and side window air vents. In addition, the blower motor may run at a slower speed until the engine warms up.
- If you press **AUTO** during hot temperatures and the inside of the vehicle is hot, the system uses recirculated air to maximize interior cooling. Blower motor speed may also reduce until the air cools.

Quickly Heating the Interior

1. Press **AUTO**.
2. Adjust the temperature function to the setting you prefer.

Recommended Settings for Heating

1. Press **AUTO**.
2. Adjust the temperature function to the setting you prefer. Use 72°F (22°C) as a starting point, then adjust the setting as necessary.

Quickly Cooling the Interior

Press **MAX A/C**.

Recommended Settings for Cooling

1. Press **AUTO**.
2. Adjust the temperature function to the setting you prefer. Use 72°F (22°C) as a starting point, then adjust the setting as necessary.

Defogging the Side Windows in Cold Weather

1. Press and release defrost or maximum defrost.

Climate Control - Vehicles With: Automatic Temperature Control

2. Adjust the temperature control to the setting you prefer. Use 72°F (22°C) as a starting point, then adjust the setting as necessary.

Climate Control - Vehicles With: Manual Temperature Control

IDENTIFYING THE CLIMATE CONTROL UNIT



Depending on your vehicle options, the controls could look different than what you see here.

SWITCHING CLIMATE CONTROL ON AND OFF



Press the button.

SWITCHING RECIRCULATED AIR ON AND OFF



Press the button to recirculate air currently in the passenger compartment.

Note: Recirculated air may turn off automatically, or prevent you from switching on in all air flow modes except MAX A/C to reduce the risk of fogging. Recirculation may also turn on and off automatically in various air distribution control combinations to improve heating or cooling efficiency.

SWITCHING AIR CONDITIONING ON AND OFF



Press the button.

Note: Under certain conditions, the air conditioning compressor could continue to operate after you switch air conditioning off.

SWITCHING MAXIMUM DEFROST ON AND OFF



Turn the temperature control clockwise past the highest setting to maximize defrosting.

Note: The temperature control springs back to the highest setting.

Air flows through the windshield air vents, and the blower motor adjusts to the highest speed.

Note: To prevent window fogging, you cannot select recirculated air when maximum defrost is on.

Note: The heated rear window also turns on when you select maximum defrost.

SWITCHING MAXIMUM COOLING ON AND OFF



Turn the temperature control counterclockwise past the lowest setting to maximize cooling.

Note: The temperature control springs back to the lowest setting.

Note: When you switch maximum cooling off, air conditioning remains on.

SWITCHING THE HEATED REAR WINDOW ON AND OFF



Press the button to clear the rear window of thin ice and fog. The heated rear window turns off after a short period of time.

Climate Control - Vehicles With: Manual Temperature Control

Note: Do not use harsh chemicals, razor blades or other sharp objects to clean or remove decals from the inside of the heated rear window as this could cause damage to the heated rear window grid lines not covered by the vehicle Warranty.

SWITCHING THE HEATED MIRRORS ON AND OFF



Press the button.

SETTING THE BLOWER MOTOR SPEED



Turn the blower motor control counterclockwise for a lower blower setting.

Turn the blower motor control clockwise for a higher blower setting.

Note: Lights on the control illuminate to indicate the blower motor speed.

Note: When you switch the blower motor off, air conditioning turns off and the windows could fog up.

SETTING THE TEMPERATURE

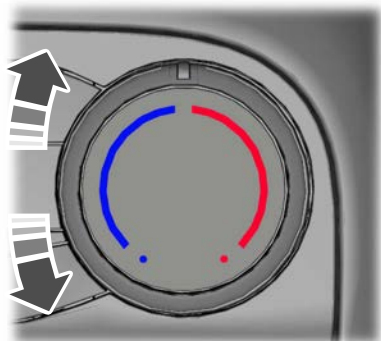

Turn the temperature control counterclockwise for cooler temperature settings.

Turn the temperature control clockwise for warmer temperature settings.

DIRECTING THE FLOW OF AIR

Directing Air to the Windshield Air Vents



Press the button.

Directing Air to the Instrument Panel Air Vents



Press the button.

Directing Air to the Footwell Air Vents



Press the button.

Climate Control - Vehicles With: Manual Temperature Control

CLIMATE CONTROL HINTS

General Hints

- Prolonged use of recirculated air may cause the windows to fog up.
- You may feel a small amount of air from the footwell air vents regardless of the air distribution setting.
- To reduce humidity build-up inside your vehicle, do not drive with the system switched off or with recirculated air always switched on.
- Do not place objects under the front seats as this may interfere with the airflow to the rear seats.
- Remove any snow, ice or leaves from the air intake area at the base of the windshield.
- To improve the time to reach a comfortable temperature in hot weather, drive with the windows open until you feel cold air through the air vents.

Quickly Heating the Interior

1. Adjust the blower motor speed to the highest speed setting.
2. Adjust the temperature control to the highest setting.
3. Direct air to the footwell air vents.

Recommended Settings for Heating

1. Adjust the blower motor speed to the center setting.
2. Adjust the temperature control to the midway point of the hot settings.
3. Direct air to the footwell air vents.

Quickly Cooling the Interior

1. Press **MAX A/C**.

2. Drive with the windows open for a short period of time.

Recommended Settings for Cooling

1. Adjust the blower motor speed to the center setting.
2. Adjust the temperature control to the midway point of the cold settings.
3. Direct air to the instrument panel air vents.

Defogging the Side Windows in Cold Weather

1. Direct air to the instrument panel and windshield air vents.
2. Press and release **A/C**.
3. Adjust the temperature control to the setting you prefer.
4. Adjust the blower motor speed to the highest setting.
5. Direct air toward the side windows.
6. Close the instrument panel air vents.

Interior Air Quality

WHAT IS THE CABIN AIR FILTER

The cabin air filter improves the quality of air in your vehicle by trapping dust, pollen and other particles.

REPLACING THE CABIN AIR FILTER

Replace the filter at regular intervals.

Note: *Make sure you have a cabin air filter installed at all times. This prevents foreign objects from entering the system. Running the system without a filter in place could result in degradation or damage to the system.*

Note: *Using an aftermarket cabin air filter could reduce cabin air filtration and climate control performance.*

Front Seats

FRONT SEAT PRECAUTIONS



WARNING: Sitting improperly, out of position or with the seatback reclined too far can take weight off the seat cushion and affect the decision of the passenger sensing system, resulting in serious injury or death in the event of a crash. Always sit upright against your seat back, with your feet on the floor.



WARNING: Do not recline the seat backrest too far as this can cause the occupant to slide under the seatbelt, resulting in personal injury in the event of a crash.



WARNING: Do not place objects higher than the top of the seat backrest. Failure to follow this instruction could result in personal injury or death in the event of a sudden stop or crash.



WARNING: Do not adjust the driver seat or seat backrest when your vehicle is moving. This may result in sudden seat movement, causing the loss of control of your vehicle.

SITTING IN THE CORRECT POSITION

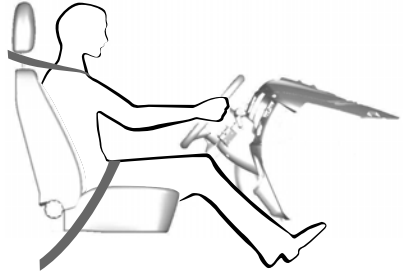

When you use them properly, the seat, head restraint, seatbelt and airbags will provide optimum protection in the event of a crash.

We recommend that you follow these guidelines:

- Sit in an upright position with the base of your spine as far back as possible.
- Do not recline the seat backrest so that your torso is more than 30 degrees from the upright position.
- Adjust the head restraint so that the top of it is level with the top of your head and as far forward as possible. Make sure that you remain comfortable.
- Keep sufficient distance between yourself and the steering wheel. We recommend a minimum of 10 in (25 cm) between your breastbone and the airbag cover.
- Hold the steering wheel with your arms slightly bent.

Front Seats

- Bend your legs slightly so that you can press the pedals fully.
- Position the shoulder strap of the seatbelt over the center of your shoulder and position the lap strap tightly across your hips.

Make sure that your driving position is comfortable and that you can maintain full control of your vehicle.

MANUAL SEATS

HEADRESTRAINT COMPONENTS

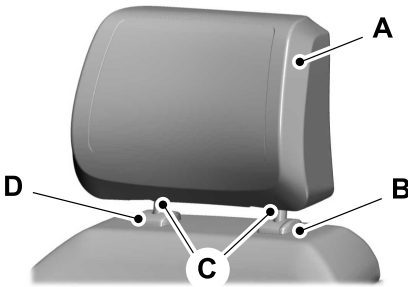

The head restraints consist of:

- A An energy absorbing head restraint.
- B Guide sleeve adjust and release button.
- C Two steel stems.
- D Guide sleeve unlock and remove button (If equipped).

ADJUSTING THE HEAD RESTRAINT

WARNING: Fully adjust the head restraint before you sit in or operate your vehicle. This will help minimize the risk of neck injury in the event of a crash. Do not adjust the head restraint when your vehicle is moving.

WARNING: The head restraint is a safety device. Whenever possible it should be installed and properly adjusted when the seat is occupied. Failure to adjust the head restraint properly could reduce its effectiveness during certain impacts.

WARNING: Adjust the head restraints for all passengers before you drive your vehicle. This will help minimize the risk of neck injury in the event of a crash. Do not adjust the head restraints when your vehicle is moving.

Note: Adjust the seat backrest to an upright driving position before adjusting the head restraint. Adjust the head restraint so that the top of it is level with the top of your head and as far forward as possible. Make sure that you remain comfortable. If you are extremely tall, adjust the head restraint to its highest position.

Pull the head restraint up to raise it.

To lower the head restraint:

1. Press and hold the adjust and release button.
2. Push the head restraint down.

Front Seats



For vehicles with tilting head restraints:

1. Adjust the seat backrest to an upright driving or riding position.
2. Pivot the head restraint forward toward your head to the preferred position.

After the head restraint reaches the forward-most tilt position, pivot it forward again to release it to the rearward, untilted position.

Note: Do not attempt to force the head restraint backward after it is tilted. Instead, continue tilting it forward until the head restraint releases to the upright position.

REMOVING THE HEAD RESTRAINT

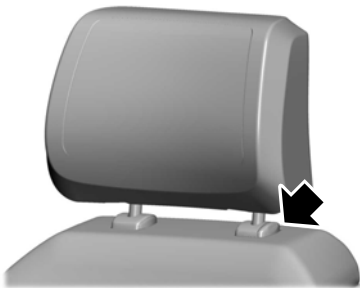

1. Pull up the head restraint until it reaches the highest adjustment position.
2. Press and hold the button.
3. Pull up the head restraint.

Note: You cannot remove head restraints that have audio system speakers.

INSTALLING THE HEAD RESTRAINT

Align the steel stems into the guide sleeves and push the head restraint down until it locks.

MOVING THE SEAT BACKWARD AND FORWARD



WARNING: Make sure the seat fully locks into place by rocking it backward and forward. Not securing the seat into the locked position can be dangerous in a crash and could cause serious personal injury or death.



Front Seats

ADJUSTING THE SEAT BACKREST



WARNING: Always drive and ride with your seatback upright and the lap belt snug and low across the hips.



WARNING: Do not place cargo or any objects behind the seat backrest before returning it to the original position. Pull on the seat backrest to make sure that it has fully latched after returning the seat backrest to its original position. An unlatched seat may become dangerous if you stop suddenly or have a crash.



POWER SEATS

HEADRESTRAINT COMPONENTS

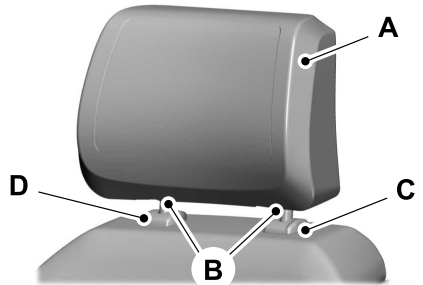

The head restraints consist of:

- A An energy absorbing head restraint.
- B Two steel stems.
- C Guide sleeve adjust and release button.
- D Guide sleeve unlock and remove button (If equipped).

ADJUSTING THE HEAD RESTRAINT



WARNING: Fully adjust the head restraint before you sit in or operate your vehicle. This will help minimize the risk of neck injury in the event of a crash. Do not adjust the head restraint when your vehicle is moving.

Front Seats



WARNING: The head restraint is a safety device. Whenever possible it should be installed and properly adjusted when the seat is occupied. Failure to adjust the head restraint properly could reduce its effectiveness during certain impacts.



WARNING: Adjust the head restraints for all passengers before you drive your vehicle. This will help minimize the risk of neck injury in the event of a crash. Do not adjust the head restraints when your vehicle is moving.

To raise the head restraint, pull the head restraint up.

To lower the head restraint:

1. Press and hold the adjust and release button.
2. Push the head restraint down.

To tilt the head restraint:



1. Adjust the seat backrest to an upright driving or riding position.
2. Pivot the head restraint forward toward your head to the preferred position.

After the head restraint reaches the forward-most tilt position, pivot it forward again to release it to the rearward, untilted position.

Note: Do not attempt to force the head restraint backward after it is tilted. Instead, continue tilting it forward until the head restraint releases to the upright position.

REMOVING THE HEADRESTRAINT

1. Pull up the head restraint until it reaches its highest position.
2. Press and hold the adjust and release button.
3. Pull up the head restraint.

Note: You cannot remove head restraints that have audio system speakers.

INSTALLING THE HEAD RESTRAINT

Align the steel stems into the guide sleeves and push the head restraint down until it locks.

MOVING THE SEAT BACKWARD AND FORWARD

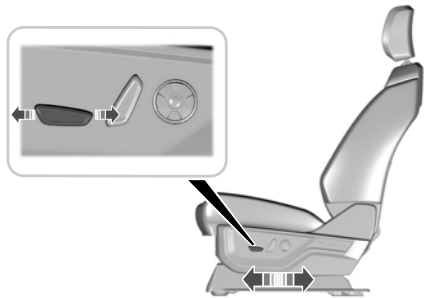

Front Seats

ADJUSTING THE SEAT CUSHION

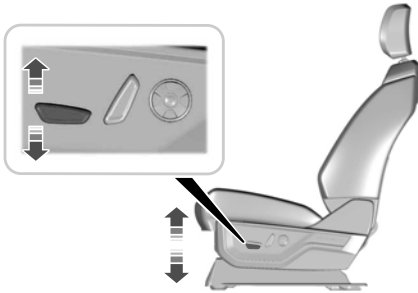

ADJUSTING THE SEAT HEIGHT

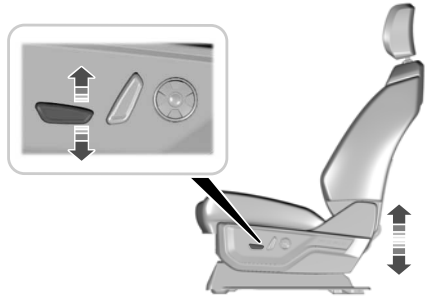

ADJUSTING THE SEAT BACKREST

WARNING: Do not place cargo or any objects behind the seatback before returning it to the original position.

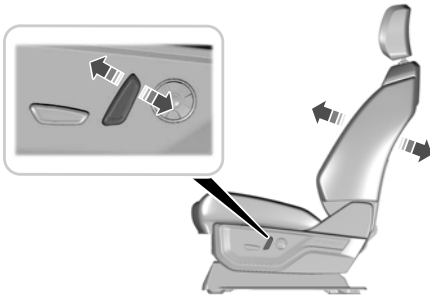

ADJUSTING THE LUMBAR SUPPORT

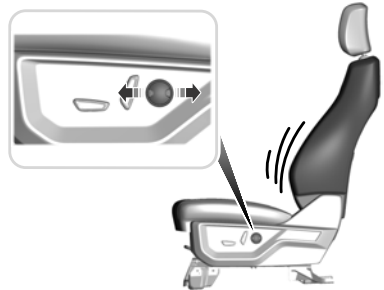

Front Seats

HEATED SEATS (IF EQUIPPED)

HEATED SEAT PRECAUTIONS



WARNING: Use caution when using the heated seat if you are unable to feel pain to your skin because of advanced age, chronic illness, diabetes, spinal cord injury, medication, alcohol use, exhaustion or other physical conditions. The heated seat could cause burns even at low temperatures, especially if used for long periods of time. Failure to follow this instruction could result in personal injury.



WARNING: Do not poke sharp objects into the seat cushion or seat backrest. This could damage the heated seat element and cause it to overheat. Failure to follow this instruction could result in personal injury.



WARNING: Do not place anything on the seat that blocks the heat, for example a seat cover or a cushion. This could cause the seat to overheat. Failure to follow this instruction could result in personal injury.

Do not:

- Place heavy objects on the seat.
- Operate the heated seat if water or any other liquid spills on the seat. Allow the seat to dry.

SWITCHING THE HEATED SEATS ON AND OFF

The vehicle must be running to use this feature.

Press the heated seat symbol to cycle through the various heat settings and off. The more indicators that display, the warmer the temperature of the seat.

Note: *The heated seats may remain on after you remote start your vehicle, based on your remote start settings. The heated seats may also turn on when you start your vehicle if they were on when you switched your vehicle off.*

Rear Seats

MANUAL SEATS

HEADRESTRAINT COMPONENTS

Rear Seat Outermost Head Restraints (4-Door)

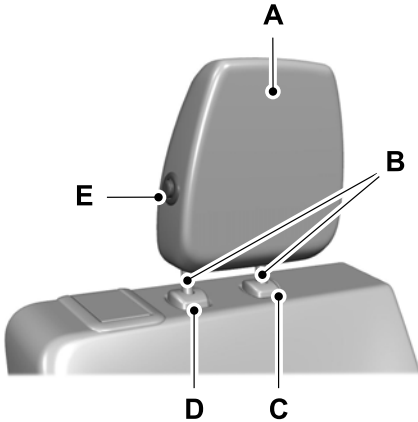

- C Guide sleeve adjust and release button.
- D Guide sleeve unlock and remove button (If equipped).
- E Fold button (If equipped).

Rear Seat Outermost Head Restraints (2-Door)

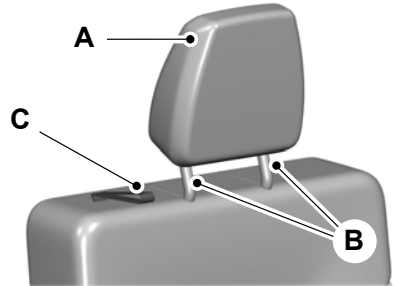

The head restraints consist of:

- A An energy absorbing head restraint.
- B Two steel stems.
- C Fold strap.

Rear Seat Center Head Restraint (4-Door)

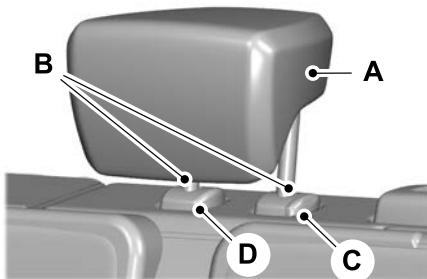

The head restraints consist of:

- A An energy absorbing head restraint.
- B Two steel stems.

ADJUSTING THE HEAD RESTRAINT

4-Door

Pull the head restraint up to raise it.

To lower the head restraint:

1. Press and hold the adjust and release button.
2. Push the head restraint down.

Press the fold button to fold the head restraint.

Rear Seats

2-Door

Pull the strap to fold the head restraint rearward.

REMOVING THE HEAD RESTRAINT

1. Pull up the head restraint until it reaches its highest position.
2. Press and hold the adjust and release button and the unlock and remove button.
3. Pull up the head restraint.

Note: *The head restraints are not removable on 2-door vehicles.*

INSTALLING THE HEAD RESTRAINT

Align the steel stems into the guide sleeves and push the head restraint down until it locks.

ADJUSTING THE SEAT BACKREST



WARNING: Do not place cargo or any objects behind the seat backrest before returning it to the original position. Pull on the seat backrest to make sure that it has fully latched after returning the seat backrest to its original position. An unlatched seat may become dangerous if you stop suddenly or have a crash.

Note: *The rear seats are not adjustable on 2-door vehicles.*

4-Door

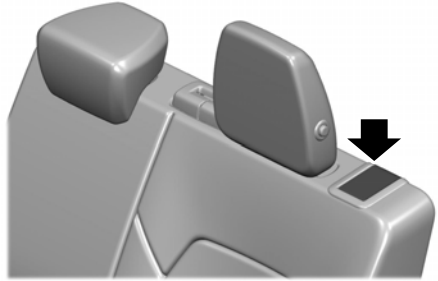

Pull the lever up to fold the seat backrest fully forward.

Note: *Make sure that the area under the seat is free of objects before folding the backrest.*

To return the seat backrest to the upright position, rotate it up until it locks.

Note: *To store the removable doors, the seat backrest must be in the upright position.*

To recline the seat backrest to the optimal seating position, pull the lever up and push the backrest rearward.

FOLDING THE SEATS



WARNING: Do not drive your vehicle with a seat that is unlatched or in the folded position. Failure to follow this instruction could result in personal injury or death in the event of a sudden stop or crash.



WARNING: Do not adjust a seat or release a seat floor latch when the vehicle is moving. Failure to follow this instruction could result in personal injury or death in a sudden stop or crash.

Rear Seats

2-Door



1. Pull the strap at the front of the seat cushion. Then, flip the seat cushion up to the vertical position.

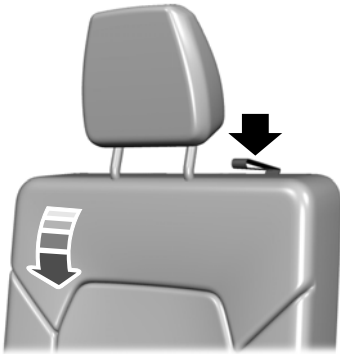

2. Pull the strap on the top of the seat backrest to fold it forward.

UNFOLDING THE SEATS



WARNING: Make sure that cargo and other objects are not trapped under the seat cushion and that you return the seat cushion to the full-down position. Failure to do so may prevent the seat from operating properly, which could increase the risk of serious injury in a crash.

For 2-door vehicles, rotate the seat backrest upright until it locks in the seating position. Then, move the seat cushion back to the seating position.

Rear Occupant Alert System (If Equipped)

WHAT IS THE REAR OCCUPANT ALERT SYSTEM

The rear occupant alert system monitors vehicle conditions and notifies you to check for rear seat occupants when you switch the ignition off.

HOW DOES THE REAR OCCUPANT ALERT SYSTEM WORK

The system monitors when rear doors have been opened and closed to indicate the potential presence of an occupant in the rear seat.

A message displays in the information and entertainment display screen and an audible warning sounds when you switch the ignition off after any of the following conditions have been met:

- A rear door is opened or closed while the ignition is on.
- You switch the ignition on within 15 minutes of a rear door opening and closing.
- You switch the ignition on within 15 minutes of the alert having displayed or sounded.

REAR OCCUPANT ALERT SYSTEM PRECAUTIONS



WARNING: On hot days, the temperature inside the vehicle can rise very quickly. Exposure of people or animals to these high temperatures for even a short time can cause death or serious heat related injuries, including brain damage. Small children are particularly at risk.



WARNING: Do not leave children or pets unattended in your vehicle. Failure to follow this instruction could result in personal injury or death.

REAR OCCUPANT ALERT SYSTEM LIMITATIONS

The system does not function if any door is removed.

The system does not detect the presence of objects or passengers in the rear seat. It monitors when rear doors are opened and closed.

Note: *It is possible to receive an alert when there is no rear seat occupant, but alert conditions are met.*

Note: *It is possible to receive no alert when there is an occupant in the rear seat, if alert conditions are not met. For example, if a rear seat occupant does not enter the vehicle through a rear door.*

Note: *The audible warning does not sound when the front door is opened before you switch the ignition off.*

SWITCHING REAR OCCUPANT ALERT SYSTEM ON AND OFF

1. Press **Settings** on the touchscreen.
2. Press **Vehicle**.
3. Switch **Rear Occupant Alert** on or off.

Note: *The default setting is on.*

Note: *Performing a master reset causes the system to switch on again.*

Rear Occupant Alert System (If Equipped)

Semiannual Reminder (If Equipped)

When you switch the system off, a message appears every six months as a reminder that the system is off. You can switch the system back on or leave it off.

REAR OCCUPANT ALERT SYSTEM INDICATORS



Message
Check rear seats for occupants.

Displays when you switch your vehicle off after the alert conditions are met.

The message displays for a short period of time. Press **Close** to acknowledge and remove the message.

Note: Depending on your SYNC version, the graphic may look different from what you see here.

REAR OCCUPANT ALERT SYSTEM AUDIBLE WARNINGS

Sounds when you switch your vehicle off after the alert conditions are met.

The warning sounds for a short period of time.

Garage Door Opener (If Equipped)

WHAT IS THE GARAGE DOOR OPENER

HomeLink Wireless Control System



The universal garage door opener replaces the common hand-held garage door opener with a three-button transmitter integrated into the driver's sun visor.

HOW DOES THE GARAGE DOOR OPENER WORK

The system includes two primary features, a garage door opener and a platform for remote activation of devices within the home. You can program garage doors as well as entry gate operators, security systems, entry door locks and home or office lighting.

Additional system information can be found online at www.homelink.com or by calling the toll-free help line at 1-800-355-3515.

Note: You can program a maximum of three devices. To change or replace any of the three devices after it has been initially programmed, you must first erase the current settings. See **Clearing the Garage Door Opener** (page 140).

GARAGE DOOR OPENER PRECAUTIONS



WARNING: Do not use the system with any garage door opener that does not have the safety stop and reverse feature as required by U.S. Federal Safety Standards (this includes any garage door opener manufactured before April 1, 1982). A garage door opener which cannot detect an object, signaling the door to stop and reverse, does not meet current federal safety standards. Using a garage door opener without these features increases the risk of serious injury or death.

Note: Make sure that the garage door and security device are free from obstruction when you are programming. Do not program the system with your vehicle in the garage.

Note: Make sure you keep the original remote control transmitter for use in other vehicles as well as for future system programming.

Note: We recommend that upon the sale or lease termination of your vehicle, you erase the programmed function buttons for security reasons. See **Clearing the Garage Door Opener** (page 140).

GARAGE DOOR OPENER LIMITATIONS

Canadian radio-frequency laws require transmitter signals to time-out (or quit) after several seconds – which may not be long enough for HomeLink to pick up the signal.

U.S. gate operators time-out in the same manner.

Garage Door Opener (If Equipped)

Note: If programming a garage door opener or gate operator, it is advised to unplug the device during the “cycling” process to prevent possible overheating.

PROGRAMMING THE GARAGE DOOR OPENER TO YOUR HAND-HELD TRANSMITTER

This process is to program your in-vehicle HomeLink function button with your hand-held transmitter.

Note: The programming steps below assume you will be programming HomeLink that was not previously programmed. If your HomeLink was previously programmed, you may need to erase your HomeLink buttons. See **Clearing the Garage Door Opener** (page 140).

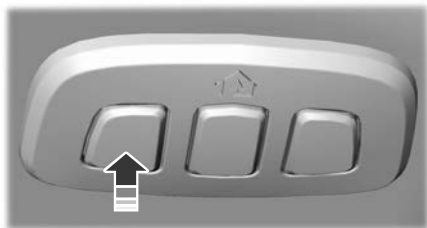

1. With your vehicle parked outside of the garage, switch your ignition to the on position, but do not start your vehicle.
2. Press and release one of the three HomeLink function buttons that you would like to program.
3. Hold your hand-held garage door transmitter 1–3 in (2–8 cm) away from the HomeLink button you want to program.

4. Press and hold the hand-held transmitter button you want to program while watching the indicator light on HomeLink. Continue to hold the hand-held button until the HomeLink indicator light flashes rapidly or is continuously on.

Note: You may need to use a different method if you live in Canada or have difficulties programming your gate operator or garage door opener. See **Programming the Garage Door Opener to Your Gate Opener Motor** (page 140).

5. Press and hold the HomeLink button you programmed for two seconds, then release. You may need to do this twice to activate the door.

Note: If the indicator light stays on, the programming is complete.

Note: If the HomeLink indicator flashes rapidly, repeat step 5.

Note: If your device still does not operate, you must program your garage door. See **Programming the Garage Door Opener to Your Garage Door Opener Motor** (page 139).

6. To program additional buttons, repeat Steps 1 – 4.

PROGRAMMING THE GARAGE DOOR OPENER TO YOUR GARAGE DOOR OPENER MOTOR



Garage Door Opener (If Equipped)

1. Press the learn button on the garage door opener motor, you have 30 seconds to complete the next two steps.
2. Return to your vehicle.

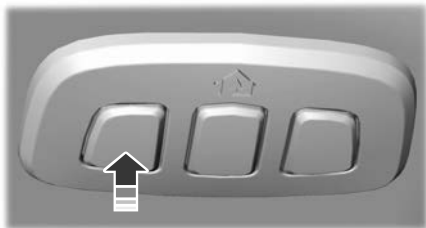

3. Press and hold one of the three HomeLink function buttons you want to program for two seconds, then release. Repeat this step. Depending on your brand of garage door opener, you may need to repeat this sequence a third time.

PROGRAMMING THE GARAGE DOOR OPENER TO YOUR GATE OPENER MOTOR

Gate Operator / Canadian Programming

Canadian radio-frequency laws require transmitter signals to “time-out” (or quit) after several seconds of transmission – which may not be long enough for HomeLink to pick up the signal during programming. Similar to this Canadian law, some U.S. gate operators “time-out” in the same manner.

Note: If programming a garage door opener or gate operator, it is advised to unplug the device during the “cycling” process to prevent possible overheating.

1. Press and release, every two seconds, your hand-held transmitter until the HomeLink indicator light changes to a rapidly blinking or continuously on light.
2. Release the hand-held transmitter button.
3. Press and hold the HomeLink function button you want to program for two seconds, then release. You may need to do this twice to activate the door.

Note: If the indicator light stays on, the programming is complete.

Note: If the HomeLink indicator flashes rapidly, repeat Step 3.

Note: If your device still does not operate, you must program your garage door. See **Programming the Garage Door Opener to Your Garage Door Opener Motor** (page 139).

4. To program additional buttons, repeat Steps 1 – 4.

CLEARING THE GARAGE DOOR OPENER

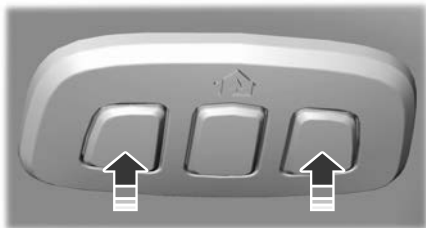

1. Press and hold the outer two function buttons simultaneously for approximately 10 seconds until the indicator light above the buttons flashes rapidly.

Garage Door Opener (If Equipped)

2. When the indicator light flashes, release the buttons.

Note: *You cannot erase individual buttons.*

REPROGRAMMING THE GARAGE DOOR OPENER

To program a device to a previously trained button, follow these steps:

1. Press and hold the desired button. Do NOT release the button.
2. The indicator light begins to flash after 20 seconds. Without releasing the button, follow programming steps.

GARAGE DOOR OPENER RADIO FREQUENCIES

FCC and RSS-210 Industry Canada Compliance



WARNING: Changes or modifications not expressly approved by the party responsible for compliance could void the user's authority to operate the equipment. The term "IC:" before the radio certification number only signifies that Industry Canada technical specifications were met.

This device complies with Part 15 of the FCC Rules and with RSS-210 of Industry Canada. Operation is subject to the following two conditions: (1) this device may not cause harmful interference, and (2) this device must accept any interference received, including interference that could cause undesired operation.

This equipment complies with FCC radiation exposure limits set forth for an uncontrolled environment. End Users must follow the specific operating instructions for satisfying RF exposure compliance. This transmitter must be at least 8 in (20 cm) from the user and must not be co-located or operating in conjunction with any other antenna or transmitter.

USB Ports

LOCATING THE USB PORTS

Data Transfer USB Ports



The USB Ports could be in the following locations:

- On the lower instrument panel.
- Inside the media bin.
- Inside the center console.

Note: *These USB ports can also charge devices.*

Note: *Not all USB ports in your vehicle have data transfer capabilities.*

Note: *We recommend using only USB-IF certified cables and adapters. Non-certified cables and adapters may not work.*

Charge Only USB Ports



The USB ports could be in the following locations:

- On the lower instrument panel.
- On the upper instrument panel.
- Inside the media bin.
- Inside the center console.
- On the rear of the center console.
- In the cargo area.

PLAYING MEDIA USING THE USB PORT



WARNING: Driving while distracted can result in loss of vehicle control, crash and injury. We strongly recommend that you use extreme caution when using any device that may take your focus off the road. Your primary responsibility is the safe operation of your vehicle. We recommend against the use of any hand-held device while driving and encourage the use of voice-operated systems when possible. Make sure you are aware of all applicable local laws that may affect the use of electronic devices while driving.

Connect your device to the USB port.



Press the audio button on the feature bar.

Select **Sources**.



Select the USB option.



Press the button to play a track. Press the button again to pause the track.



Press the button to skip to the next track.

Press and hold the button to fast forward through the track.



Press the button once to return to the beginning of a track. Repeatedly press the button to return to previous tracks.

Press and hold the button to fast rewind.

USB Ports

CHARGING A DEVICE

Connect your device to the USB port.

You can use the charger when the vehicle is in accessory mode, when the vehicle is running, or when SYNC is on.

Power Outlet - Vehicles With: 120V Power Outlet

WHAT IS THE POWER OUTLET

The power outlet can power devices that use a household plug.

POWER OUTLET PRECAUTIONS



WARNING: Do not keep electrical devices plugged in the power point whenever the device is not in use. Do not use any extension cord with the 110 volt AC power point, since it will defeat the safety protection design. Doing so may cause the power point to overload due to powering multiple devices that can reach beyond the 400 watt load limit and could result in fire or serious injury.

Note: *The vehicle provides up to 400 watts when in park and up to 300 watts when in drive mode. This wattage is divided between multiple outlets when in use at the same time.*

LOCATING THE POWER OUTLET

The power outlet is on the rear of the center console.

Rear of the Center Console



POWER OUTLET INDICATORS

The power outlet indicator illuminates to let you know the status of the system.

Indicator Status	Description
On	The power point is working, the ignition is on, or the vehicle is in accessory mode.
Off	The power point is off, the ignition is off, or the vehicle is not in accessory mode.
Flashing	The power point is in fault mode.

Note: *Due to different technologies used on its construction, some devices may exceed the capacity shown on its label when they are initially plugged in.*

Power Outlet - Vehicles With: 120V Power Outlet

Note: *The power outlet temporarily turns off power when in fault mode if the device exceeds the Watt limit. Unplug your device and switch the ignition off. Switch the ignition back on, but do not plug your device back in. Let the system cool off and switch the ignition off to reset the fault mode. Switch the ignition back on and make sure the indicator light remains on.*

Power Outlet - Vehicles With: 12V Power Outlet

WHAT IS THE POWER OUTLET

The power outlet can power devices using a 12 V outlet adapter.

POWER OUTLET PRECAUTIONS

When you switch the vehicle on, you can use the socket to power 12 V appliances with a maximum current rating of 20 A. Do not use the power point over the vehicle capacity of 12 V DC 240 W or a fuse could blow. Do not plug in any device that supplies power to the vehicle through the power points. This could result in damage to vehicle systems. Do not hang any accessory from the accessory plug. Always keep the power point caps closed when not in use. Do not insert objects other than an accessory plug into the power point.

To prevent the battery from running out of charge:

- Do not use the power point longer than necessary when the vehicle is off.
- Do not leave devices plugged in overnight or when you park your vehicle for extended periods.

LOCATING THE POWER OUTLET

Power outlets may be in the following locations:

- On the lower instrument panel.
- Inside the center console.
- On the front of the center console.
- On the rear of the center console.
- In the cargo area.
- On the passenger side floor panel.
- 3rd row on the quarter trim panels.

Wireless Accessory Charger (If Equipped)

WHAT IS THE WIRELESS ACCESSORY CHARGER

The wireless accessory charger allows you to charge one compatible Qi wireless charging device on the charging area.

WIRELESS ACCESSORY CHARGER PRECAUTIONS



WARNING: Wireless charging devices can affect the operation of implanted medical devices, including cardiac pacemakers. If you have any implanted medical devices, we recommend that you consult with your physician.

Tests on this equipment show that it complies with part 18 of the FCC Rules.

- This equipment generates, uses and can radiate radio frequency energy and may cause harmful interference to radio communications. There is no guarantee that the interference will not occur in a particular installation. If this equipment does cause harmful interference to radio or television reception, please consult the dealer.
- This product is not end-user serviceable.



WARNING: Changes or modifications not expressly approved by the party responsible for compliance could void the user's authority to operate the equipment. The term "IC:" before the radio certification number only signifies that Industry Canada technical specifications were met.

This device complies with Industry Canada licence-exempt RSS standard(s).

Operation is subject to:

- This device may not cause interference.
- This device must accept any interference, including interference that may cause undesired operation of the device.

Keep the charging area clean and remove foreign objects prior to charging a device.

Do not place items with a magnetic strip, for example passports, parking tickets or credit cards, near the charging area when charging a device. Damage may occur to the magnetic strip.

Do not place metal objects, for example remote controls, coins and candy wrappers, on or near the charging area when charging a device. Metal objects may heat up and degrade the charging performance, in addition to causing error messages and interruptions in charging.

Note: *The rate of charge, or charging power, is controlled by the device. During charging, the device and the charger could heat up, this is normal. If the battery gets hotter than usual, the device may stop charging.*

Note: *If the system detects a foreign object or if the device is misaligned on the charging area, a message appears on the display.*

LOCATING THE WIRELESS ACCESSORY CHARGER



The charging area is on the center console or in the media bin below the instrument panel.

Wireless Accessory Charger (If Equipped)

CHARGING A WIRELESS DEVICE

Place the device on the center of the charging surface with the charging side down. The charging stops after your device reaches a full charge.

You can use the charger when the vehicle is in accessory mode, when the vehicle is running, or when SYNC is on.



Displays on the status bar when wireless charging is in progress.

Note: *The charging performance may be affected if your device is in a case. It may be necessary to remove the case to wirelessly charge your device.*

Note: *Software and firmware updates may affect device compatibility, including the use of unofficial software or firmware. Customers should verify charging functionality with their specific devices in-vehicle.*

WIRELESS ACCESSORY CHARGER – TROUBLESHOOTING

WIRELESS ACCESSORY CHARGER – INFORMATION MESSAGES

Message	Behavior	Description
Phone misaligned or object between phone and charger detected. Correct the condition to resume charging.	Pop-up window.	The system stops charging your device if the system detects the phone is misaligned, or a foreign metal object is on the charging surface.

Storage

GLOVE COMPARTMENT

OPENING THE GLOVE COMPARTMENT



Pull the latch to the left to open.

LOCKING THE GLOVE COMPARTMENT

The lower glove compartment may be locked using the key.

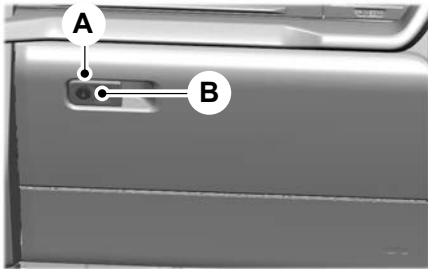

- A Unlock.
- B Lock.

CENTER CONSOLE

OPENING THE CENTER CONSOLE



Push the latch to open the center console.

LOCKING THE CENTER CONSOLE



You can lock the center console using the key.

Storage

UNDER FLOOR STORAGE

LOCATING THE LUGGAGE COMPARTMENT UNDER FLOOR STORAGE

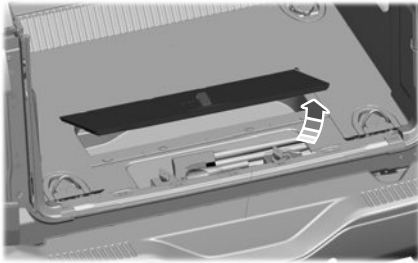

Lift the strap to access the under floor storage in the luggage compartment.

GLASSES HOLDER

LOCATING THE GLASSES HOLDER



The glasses holder is in the overhead console.

Press near the rear edge of the door to open it.

MAP POCKET

LOCATING THE MAP POCKET

A map pocket and optional hook and MOLLE system are on the backs of the front seats.

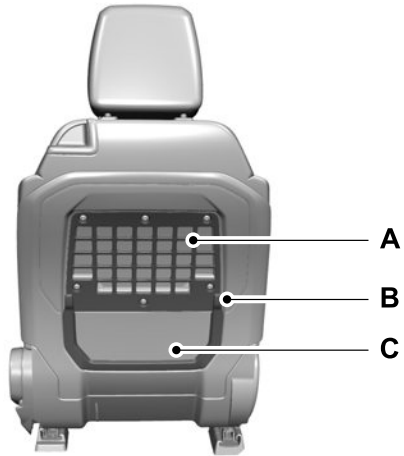

- A. MOLLE system (if equipped).
- B. Hooks (if equipped).
- C. Map pocket.

Note: The recommended weight limit for this system is 7 lb (3 kg).

Starting and Stopping the Engine

STARTING AND STOPPING THE ENGINE – PRECAUTIONS

WARNING: Extended idling at high engine speeds can produce very high temperatures in the engine and exhaust system, creating the risk of fire or other damage.

WARNING: Do not park, idle or drive your vehicle on dry grass or other dry ground cover. The emission system heats up the engine compartment and exhaust system, creating the risk of fire.

WARNING: Do not start the engine in a closed garage or in other enclosed areas. Exhaust fumes are toxic. Always open the garage door before you start the engine. Failure to follow this instruction could result in personal injury or death.

WARNING: Exhaust leaks may result in entry of harmful and potentially lethal fumes into the passenger compartment. If you smell exhaust fumes inside your vehicle, have your vehicle inspected immediately. Do not drive if you smell exhaust fumes.

The powertrain control system meets all Canadian interference-causing equipment standard requirements regulating the impulse electrical field or radio noise.

If you stop your vehicle and leave the engine idling for long periods, we recommend that you do one of the following:

- Open the windows at least 1 in (2.5 cm).
- Set your climate control to outside air.

PUSH BUTTON IGNITION SWITCH

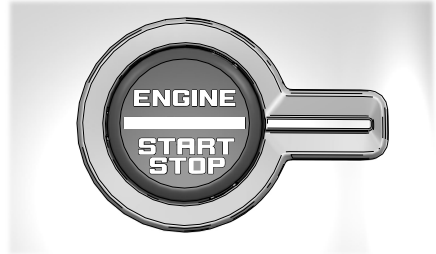

Switching the Ignition Off

When the ignition is on or in accessory mode, press the push button ignition switch once without your foot on the brake pedal.

Switching the Ignition to Accessory Mode

When the ignition is off, press the push button ignition switch once without your foot on the brake pedal.

All electrical circuits and accessories are operational and the warning lamps and indicators illuminate.

Note: *Your vehicle has a battery saver feature that shuts your vehicle off when it detects a certain amount of battery drain, or after about 30 minutes of inactivity in accessory mode.*

Starting the Engine

With the transmission in park (P), press the brake pedal and press the push button ignition switch. An indicator light on the button illuminates when then ignition is on and when the engine starts.

Starting and Stopping the Engine

Note: The system may not function if the passive key is close to metal objects or electronic devices, for example keys or a cell phone.

Note: A valid key must be inside your vehicle to switch the ignition on and start the engine.

STARTING THE ENGINE

STARTING A GASOLINE ENGINE - MANUAL TRANSMISSION

Before starting your vehicle, check the following:

- Make sure that the headlamps and electrical accessories are off.
- Make sure that the parking brake is on.
- Make sure the transmission is in neutral.

1. Fully press the clutch pedal.

Note: Do not touch the accelerator pedal.

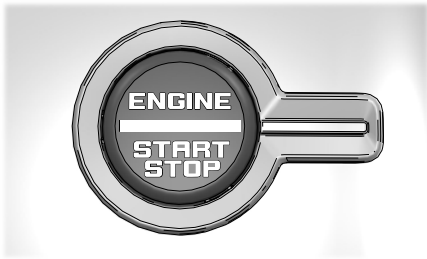

2. Press the push button ignition switch.

Note: The engine may continue cranking for up to 15 seconds or until it starts.

Note: The engine takes longer to start at lower temperatures. It may crank for several seconds when very cold.

STARTING A GASOLINE ENGINE - AUTOMATIC TRANSMISSION

Before starting your vehicle, check the following:

- Make sure that the headlamps and electrical accessories are off.
- Make sure that the parking brake is on.
- Make sure that the transmission is in park (P).

1. Fully press the brake pedal.

Note: Do not touch the accelerator pedal.

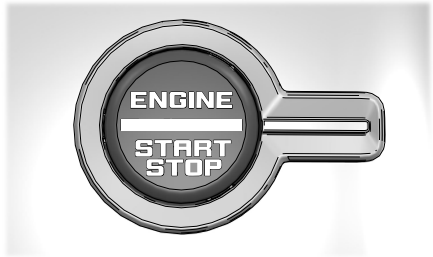

2. Press the push button ignition switch.

Note: The engine may continue cranking for up to 15 seconds or until it starts.

Note: The engine takes longer to start at lower temperatures. It may crank for several seconds when very cold.

RESTARTING THE ENGINE AFTER STOPPING IT

The system allows you to start the engine within 10 seconds of switching it off, even if it does not detect a valid passive key.

Within 10 seconds of switching the engine off, fully press the brake or clutch pedal and press the push button ignition switch. After 10 seconds, you can no longer start the engine if the system does not detect a valid passive key.

Starting and Stopping the Engine

When you start the engine, it remains running until you press the push button ignition switch, even if your vehicle does not detect a valid passive key. If you open and close a door when the engine is running, the system searches for a valid passive key.

ENGINE BLOCK HEATER (IF

EQUIPPED)

ENGINE BLOCK HEATER PRECAUTIONS



WARNING: Failure to follow engine block heater instructions could result in property damage or serious personal injury.



WARNING: Do not use your heater with ungrounded electrical systems or two-pronged adapters. There is a risk of electrical shock.



WARNING: Do not fully close the hood, or allow it to drop under its own weight when using the engine block heater. This could damage the power cable and may cause an electrical short resulting in fire, injury and property damage.

We recommend that you do the following for a safe and correct operation:

- Use a 16-gauge outdoor extension cord that is product certified by Underwriter's Laboratory (UL) or Canadian Standards Association (CSA). This extension cord must be suitable for use outdoors, in cold

temperatures, and be clearly marked Suitable for Use with Outdoor Appliances. Do not use an indoor extension cord outdoors. This could result in an electric shock or become a fire hazard.

- Use as short an extension cord as possible.
- Do not use multiple extension cords.
- Make sure that when in operation, the extension cord plug and heater cord plug connections are free and clear of water. This could cause an electric shock or fire.
- If the block heater cord is under the hood, do not remove the wiring from its original location. Do not close the hood on the extension wiring.
- Make sure your vehicle is parked in a clean area, clear of combustibles.
- Make sure the heater, heater cord and extension cord are firmly connected.
- Check for heat anywhere in the electrical hookup once the system has been operating for about 30 minutes.
- Make sure the system is unplugged and properly stowed before starting and driving your vehicle. Make sure the protective cover seals the prongs of the block heater cord plug when not in use.
- Make sure the heater system is checked for proper operation before winter.

HOW DOES THE ENGINE BLOCK HEATER WORK

The engine block heater warms the engine coolant. This allows the climate control system to quickly respond. The equipment includes a heater element installed in the engine block and a wire harness. You can connect the system to a grounded 220-240 volt AC electrical source.

Starting and Stopping the Engine

Note: The heater is most effective when outdoor temperatures are below 0°F (-18°C).

USING THE ENGINE BLOCK HEATER

Make sure the receptacle terminals are clean and dry prior to use. Clean them with a dry cloth if necessary.

The heater uses 0.4 to 1.0 kilowatt-hours of energy per hour of use. The system does not have a thermostat. It achieves maximum temperature after approximately three hours of operation. Using the heater longer than three hours does not improve system performance and unnecessarily uses electricity.

STOPPING THE ENGINE

STOPPING THE ENGINE WHEN YOUR VEHICLE IS STATIONARY - MANUAL TRANSMISSION

1. Shift into neutral.
2. Apply the parking brake.
3. Wait until the engine reaches idle speed.

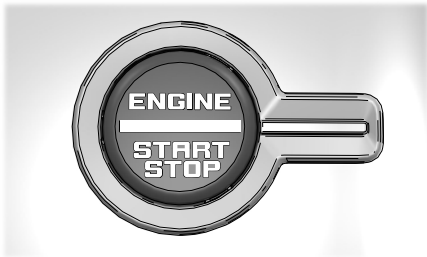

4. Press the push button ignition switch.

STOPPING THE ENGINE WHEN YOUR VEHICLE IS STATIONARY - AUTOMATIC TRANSMISSION

1. Shift into park (P).
2. Apply the parking brake.
3. Wait until the engine reaches idle speed.

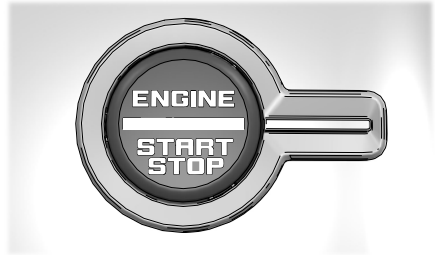

4. Press the push button ignition switch.

STOPPING THE ENGINE WHEN YOUR VEHICLE IS MOVING - MANUAL TRANSMISSION



WARNING: Switching off the engine when your vehicle is still moving results in a significant decrease in braking assistance. Higher effort is required to apply the brakes and to stop your vehicle. A significant decrease in steering assistance could also occur. The steering does not lock, but higher effort could be required to steer your vehicle. When you switch the ignition off, some electrical circuits, for example airbags, also turn off. If you unintentionally switch the ignition off, shift into neutral (N) and restart the engine.

Starting and Stopping the Engine

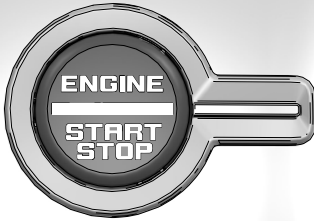

1. Press and hold the push button ignition switch until the engine stops, or press it three times within two seconds.
2. Shift into neutral and use the brakes to bring your vehicle to a safe stop.
3. Apply the parking brake.

STOPPING THE ENGINE WHEN YOUR VEHICLE IS MOVING - AUTOMATIC TRANSMISSION



WARNING: Switching off the engine when your vehicle is still moving results in a significant decrease in braking assistance. Higher effort is required to apply the brakes and to stop your vehicle. A significant decrease in steering assistance could also occur. The steering does not lock, but higher effort could be required to steer your vehicle. When you switch the ignition off, some electrical circuits, for example airbags, also turn off. If you unintentionally switch the ignition off, shift into neutral (N) and restart the engine.

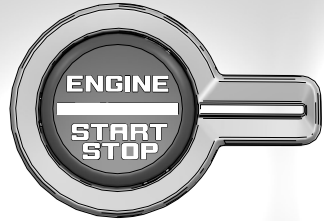

1. Press and hold the push button ignition switch until the engine stops, or press it three times within two seconds.
2. Shift into neutral and use the brakes to bring your vehicle to a safe stop.
3. Shift into park (P).
4. Apply the parking brake.

AUTOMATIC ENGINE STOP

WHAT IS AUTOMATIC ENGINE STOP

Automatic engine stop switches the engine off if it has been idling for an extended period to help you save fuel.

HOW DOES AUTOMATIC ENGINE STOP WORK

Automatic engine stop turns the engine off. The ignition also turns off in order to save battery power. Before the engine shuts down, a message appears in the information display showing a timer counting down. If you do not intervene within 30 seconds, the engine shuts down. Another message appears in the information display to inform you that the engine has shut down in order to save fuel. Start your vehicle as you normally do.

Starting and Stopping the Engine

SWITCHING AUTOMATIC ENGINE STOP ON AND OFF

1. Press **Settings** on the touchscreen.
2. Press **Vehicle Settings**.
3. Switch **30min Max Idle** on or off.

Note: You cannot permanently switch off the automatic shutdown. If you switch it off, it turns on each time you switch the ignition on.

OVERRIDING AUTOMATIC ENGINE STOP

Note: You cannot permanently switch off the automatic engine stop feature. When you switch it off temporarily, it turns on at the next ignition cycle.

You can stop the engine shutdown, or reset the timer, at any point before the 30-second countdown has expired by doing any of the following:

- Pressing the brake pedal or accelerator pedal.
- Pressing the **OK** or **RESET** button during the countdown.

ACCESSING THE PASSIVE KEY BACKUP POSITION

If you are unable to start the engine, do the following:

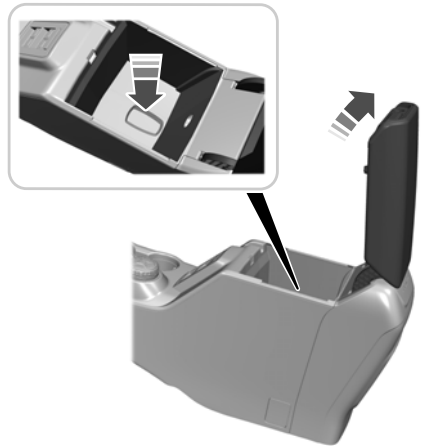

1. Open the floor console storage compartment lid.
2. With the buttons facing upward and the unlock button facing the front of your vehicle, place the passive key into the backup slot.
3. With the key in this position, press the brake pedal then press the push button ignition switch to switch the ignition on and start your vehicle.

STARTING AND STOPPING THE ENGINE – TROUBLESHOOTING

STARTING AND STOPPING THE ENGINE – WARNING LAMPS

Malfunction Indicator Lamp



If it illuminates when the engine is running, the on-board diagnostics system is detecting a malfunction of the vehicle emission control system.

Starting and Stopping the Engine

If it flashes, engine misfire could be occurring. Increased exhaust gas temperatures could damage the catalytic converter or other vehicle components. Avoid heavy acceleration and deceleration, and have your vehicle checked as soon as possible.

Powertrain Warning Lamp



If it illuminates when the engine is running, this indicates a powertrain or four-wheel drive fault. If it flashes when you are driving, immediately reduce the vehicle speed. Avoid heavy acceleration and deceleration, and have your vehicle checked as soon as possible.

If both lamps illuminate when the engine is running, stop your vehicle as soon as it is safe to do so. Continuing to drive your vehicle could cause reduced power or the engine to stop. Switch the ignition off and attempt to restart the engine. Have your vehicle checked as soon as possible.

STARTING AND STOPPING THE ENGINE – INFORMATION MESSAGES

Message	Action
Cranking Time Exceeded	Displays if you exceed the starting time limit. You cannot attempt to start the engine for 15 minutes. If you cannot start the engine after 15 minutes passes, have your vehicle immediately checked.
Starting System Fault	Displays if you are unable to start your vehicle with a correctly coded key. The system has detected a fault that requires service. Have your vehicle checked as soon as possible.
No Key Detected	Displays if the system does not detect a valid passive key.

Starting and Stopping the Engine

STARTING AND STOPPING THE ENGINE – FREQUENTLY ASKED QUESTIONS

Why is the engine idle speed high when I am starting the engine?

The speed at which the engine idles immediately after starting is optimized to minimize vehicle emissions and maximize cabin comfort and fuel economy.

Why does the engine not crank?

You can only attempt to start the engine for a limited amount of time before the starting system temporarily disables. If you exceed the starting time limit, a message may appear and you cannot attempt to start the engine for at least 15 minutes.

Why do I experience different driving characteristics?

If you disconnect the battery, your vehicle may exhibit some unusual driving characteristics for about 5 mi (8 km) after you reconnect it. This is because the engine management system must realign itself with the engine. You can disregard any unusual driving characteristics during this period.

Why can I not start the engine?

If you cannot start the engine after three attempts, wait 10 seconds and do the following:

1. Fully press the brake pedal or the clutch pedal.

Note: Make sure that the parking brake is applied.

Note: Make sure that the transmission is in park (P) or neutral (N).

2. Fully press the accelerator pedal and hold it there.
3. Press the push button ignition switch.

Note: The engine cranks for a short period of time and then it stops.

4. Release the accelerator pedal.

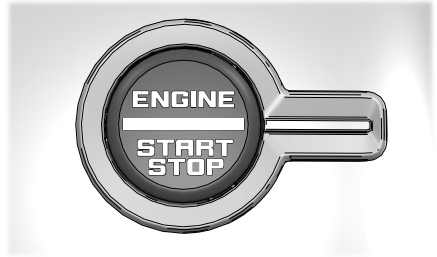

5. Press the push button ignition switch.

Why does the system not detect a passive key?

If the system does not detect a passive key and you are unable to start the engine, insert the passive key into the backup position and press the push button ignition switch to start the engine. See **Accessing the Passive Key Backup Position** (page 156).

Start in Gear - Manual Transmission

WHAT IS START IN GEAR

Crank in gear allows the driver to restart the engine and launch the vehicle after stalling in four-wheel drive low (4L). Use the information displayed on the cluster to direct you when to apply the brake and start button. While driving off road, it is possible to stall the engine trying to maneuver terrains. Trying to restart your vehicle by using the clutch or shifting into neutral to restart the engine can be difficult and cause potential roll back situations when driving uphill.

Note: *Crank in gear is an alternate name for the feature.*

2. Firmly press the brake pedal when in gear and press and hold the **Start** button.
3. When the engine starts and your vehicle begins to move, release the brake pedal.

START IN GEAR PRECAUTIONS

Always press the brake pedal when starting the vehicle to prevent unwanted vehicle movement, and release after starting to drive away. Start in gear is only possible with the brake pedal pressed.

START IN GEAR LIMITATIONS

You can only use start in gear in four-wheel drive low (L).

USING START IN GEAR

When driving difficult terrains in four-wheel drive low (4L), it is possible to stall the engine when your vehicle is not able to maintain speed. To easily start the engine and launch your vehicle, perform the following steps:

1. After the vehicle stalls an information message displays in the cluster, **To start in gear select YES and press OK.**

Start in Gear - Manual Transmission

START IN GEAR – TROUBLESHOOTING

START IN GEAR – INFORMATION MESSAGES

Message	Action
Do you want to start in gear?	After stalling your vehicle, a message can display prompting you start in gear is now available.
Press Brake and Hold Start Button to Start in Gear	For use with push button vehicles, press the brake pedal and press the push to start button to begin start in gear.
Start in Gear Canceled	After stalling in four-wheel drive low, if your vehicle does not meet all the requirements or you make any other inputs, a message can display in the cluster.
Start in Gear Limit Reached Normal Start Available	After stalling in four-wheel drive low, a message can display if you have incorrectly attempted a start in gear situation or have attempted to many times.

START IN GEAR – FREQUENTLY ASKED QUESTIONS

Can I use start in gear in reverse?

You can use start in gear in any forward or reverse gear.

Will this start my vehicle?

Upon following the maneuvers, the engine starts, runs and launches the vehicle in gear.

If my vehicle stalls, do I have to use start in gear?

After your vehicle stalls in four-wheel drive low, you do not have to use start in gear. You can still start your vehicle normally with use of the clutch.

How hard does the brake need pressing for start in gear?

The brake requires a hard press at the time you press the push button, and then you need to release it to allow the vehicle to move.

Auto-Start-Stop

WHAT IS AUTO-START-STOP

The system is designed to help reduce fuel consumption and CO₂ emissions by stopping the engine when it is idling, for example at traffic lights.

AUTO-START-STOP PRECAUTIONS - MANUAL TRANSMISSION



WARNING: Apply the parking brake, shift into neutral, switch the ignition off and remove the key before you leave your vehicle. Failure to follow this instruction could result in personal injury or death.



WARNING: Apply the parking brake, shift into neutral, switch the ignition off and remove the key before you open the hood or have any service or repair work completed. If you do not switch the ignition off, the engine could restart at any time. Failure to follow this instruction could result in personal injury or death.

AUTO-START-STOP PRECAUTIONS - AUTOMATIC TRANSMISSION



WARNING: Apply the parking brake, shift into park (P), switch the ignition off and remove the key before you leave your vehicle. Failure to follow this instruction could result in personal injury or death.



WARNING: Apply the parking brake, shift into park (P), switch the ignition off and remove the key before you open the hood or have any service or repair work completed. If you do not switch the ignition off, the engine could restart at any time. Failure to follow this instruction could result in personal injury or death.

SWITCHING AUTO-START- STOP ON AND OFF

The system turns on when you switch the ignition on.



Press the button to switch the system off.

Note: *OFF* illuminates in the switch.

Note: *Deactivating the system using the button lasts only one key cycle.*

Press the button again to switch the system back on.

Note: *The system turns off if it detects a malfunction. If the system malfunctions, have your vehicle checked as soon as possible.*

STOPPING THE ENGINE - MANUAL TRANSMISSION

1. Stop your vehicle.
2. Shift into neutral.
3. Release the clutch pedal and the accelerator pedal.

Note: *To obtain maximum benefit from the system, shift into neutral and release the clutch pedal whenever you stop your vehicle for more than three seconds.*

Note: *Power assist steering turns off when the engine stops.*

Auto-Start-Stop

STOPPING THE ENGINE - AUTOMATIC TRANSMISSION

Stop your vehicle, keep your foot on the brake pedal and the transmission in drive (D).

Note: *Power assist steering turns off when the engine stops.*

RESTARTING THE ENGINE - MANUAL TRANSMISSION

Press the clutch pedal.

A message appears in the information display if the system requires you to take action.

Message	Condition	Action
Auto StartStop Press a Pedal to Start Engine	The system needs to restart the engine but requires your confirmation.	Press the accelerator pedal, brake pedal or clutch pedal to restart the engine.
Auto StartStop Select Neutral To Start Engine	The system needs to restart the engine but cannot because the transmission is in gear.	Shift into neutral to restart the engine.

Auto-Start-Stop

RESTARTING THE ENGINE - AUTOMATIC TRANSMISSION

Release the brake pedal or press the accelerator pedal.

A message appears in the information display if the system requires you to take action.

AUTO-START-STOP INDICATORS



WARNING: The system may require the engine to automatically restart when the auto-start-stop indicator illuminates green or flashes amber. Failure to follow this instruction could result in personal injury.



The Auto-Start-Stop indicator illuminates green when the engine stops. It flashes amber and a message appears when you need to take action.



The Auto-Start-Stop indicator illuminates gray with a strikethrough when the system is not available.

Note: You can display the reason why the system is not available in the information display.

AUTO-START-STOP – TROUBLESHOOTING

AUTO-START-STOP – INFORMATION MESSAGES - MANUAL TRANSMISSION

Message	Condition	Action
Auto StartStop Manual Restart Required	The system is not functioning.	Restart the engine yourself.

Auto-Start-Stop

AUTO-START-STOP – INFORMATION MESSAGES - AUTOMATIC TRANSMISSION

A message appears in the information display if the system requires you to take action.

Message	Condition	Action
Auto StartStop Press Brake to Start Engine	The system needs to restart the engine but requires your confirmation.	Press the brake pedal to restart the engine.
Auto StartStop Press a Pedal to Start Engine	The system needs to restart the engine but requires your confirmation.	Press the brake pedal or the accelerator pedal to restart the engine.
Auto StartStop Shift to P, then Restart Engine	The System is not functioning.	Shift in park (P) and restart the engine.

Auto-Start-Stop

AUTO-START-STOP – FREQUENTLY ASKED QUESTIONS

Why does the engine not always stop when I expect it to?

The system is designed to work in a way that complements other vehicle systems, allowing them to operate at optimum performance.

The system does not stop the engine if:

- The driver door is open.
- Your vehicle is at high altitude.
- The heated windshield is on.
- The engine is warming up.
- The outside temperature is too low or too high.
- The battery charge is low.
- The battery temperature is outside the optimal operating range.
- The engine is required to run to maintain interior climate and reduce fogging.

Why does the engine sometimes restart when I do not expect it to?

The system is designed to work in a way that complements other vehicle systems, allowing them to operate at optimum performance.

The system restarts the engine if:

- You switch the heated windshield on.
- You switch maximum defrost on.
- Your vehicle starts to roll downhill in neutral.
- The engine is required to run to maintain adequate brake system assistance.
- The engine is required to run to maintain interior climate and reduce fogging.

Can I permanently switch the system off?

No. The system plays an important role in reducing the fuel consumption and the CO₂ emissions.

Will the frequent engine starts cause parts to wear out?

Your vehicle has an enhanced battery and starter motor that are designed for the increased number of engine starts.

Fuel and Refueling

FUEL AND REFUELING PRECAUTIONS

 **WARNING:** Do not overfill the fuel tank. The pressure in an overfilled tank may cause leakage and lead to fuel spray and fire.

 **WARNING:** The fuel system may be under pressure. If you hear a hissing sound near the fuel filler inlet, do not refuel until the sound stops. Otherwise, fuel may spray out, which could cause serious personal injury.

 **WARNING:** Fuels can cause serious injury or death if misused or mishandled.

 **WARNING:** Fuel may contain benzene, which is a cancer-causing agent.

 **WARNING:** When refueling always shut the engine off and never allow sparks or open flames near the fuel tank filler valve. Never smoke or use a cell phone while refueling. Fuel vapor is extremely hazardous under certain conditions. Avoid inhaling excess fumes.

 **WARNING:** Read and follow all the instructions on the pump island.

Follow these guidelines when refueling:

- Extinguish all smoking materials and any open flames before refueling your vehicle.
- Switch the engine off before refueling.

- Automotive fuels can be harmful or fatal if swallowed. Fuel is highly toxic and if swallowed can cause death or permanent injury. If fuel is swallowed immediately call a physician, even if no symptoms are immediately apparent. The toxic effects of fuel may not be apparent for hours.
- Avoid inhaling fuel vapors. Inhaling fuel vapor can lead to eye and respiratory tract irritation. In severe cases, excessive or prolonged breathing of fuel vapor can cause serious illness and permanent injury.
- Avoid getting fuel in your eyes. If you splash fuel in your eyes, immediately remove contact lenses, if worn, flush with water for 15 minutes and seek medical attention. Failure to seek proper medical attention could lead to permanent injury.
- Fuels can be harmful if absorbed through the skin. If you splash fuel on your skin, clothing or both, promptly remove contaminated clothing and thoroughly wash your skin with soap and water. Repeated or prolonged skin contact causes skin irritation.
- Be particularly careful if you are taking Antabuse or other forms of Disulfiram for the treatment of alcoholism. Breathing fuel vapors could cause an adverse reaction, serious personal injury or sickness. Immediately call a physician if you experience any adverse reactions.

Fuel and Refueling

FUEL QUALITY

SELECTING THE CORRECT FUEL

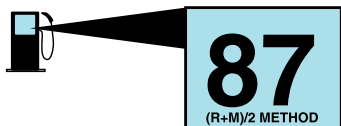

Your vehicle operates on regular unleaded gasoline with a minimum pump (R+M)/2 octane rating of 87.

Some fuel stations, particularly those in high altitude areas, offer fuels posted as regular unleaded gasoline with an octane rating below 87. The use of these fuels could result in engine damage that will not be covered by the vehicle Warranty.

For best overall vehicle and engine performance, premium fuel with an octane rating of 91 or higher is recommended. The performance gained by using premium fuel is most noticeable in hot weather as well as other conditions, for example when towing a trailer. See **Towing a Trailer** (page 283).

Do not be concerned if the engine sometimes knocks lightly. However, if the engine knocks heavily while using fuel with the recommended octane rating, contact an authorized dealer to prevent any engine damage.

We recommend Top Tier detergent gasolines, where available to help minimize engine deposits and maintain optimal vehicle and engine performance.

For additional information, visit www.toptiergas.com.

Note: Use of any fuel for which the vehicle was not designed can impair the emission control system, cause loss of vehicle performance, and cause damage to the engine which may not be covered by the vehicle Warranty.

Do not use:

- Diesel fuel.
- Fuels containing kerosene or paraffin.
- Fuel containing more than 15% ethanol or E85 fuel.
- Fuels containing methanol.
- Fuels containing metallic-based additives, including manganese-based compounds.
- Fuels containing the octane booster additive, methylcyclopentadienyl manganese tricarbonyl (MMT).
- Leaded fuel, using leaded fuel is prohibited by law.

The use of fuels with metallic compounds such as methylcyclopentadienyl manganese tricarbonyl, which is a manganese-based fuel additive, will impair engine performance and affect the emission control system.

LOCATING THE FUEL FILLER FUNNEL

The fuel filler funnel is in the rear floor compartment with the jack and tools.

Fuel and Refueling

RUNNING OUT OF FUEL

FILLING A PORTABLE FUEL CONTAINER

WARNING: Flow of fuel through a fuel pump nozzle can produce static electricity. This can cause a fire if you are filling an ungrounded fuel container.

Use the following guidelines to avoid electrostatic charge build-up, which can produce a spark, when filling an ungrounded fuel container:

- Only use an approved fuel container to transfer fuel to your vehicle. Place the container on the ground when filling it.
- Do not fill a fuel container when it is inside your vehicle (including the cargo area).
- Keep the fuel pump nozzle in contact with the fuel container when filling it.
- Do not use a device that holds the fuel pump nozzle lever in the fill position.

ADDING FUEL FROM A PORTABLE FUEL CONTAINER

WARNING: Do not insert the nozzle of a fuel container or an aftermarket funnel into the fuel filler neck. This may damage the fuel system filler neck or its seal and cause fuel to run onto the ground.

WARNING: Do not pry open the fuel tank filler valve. This could damage the fuel system. Failure to follow this instruction could result in fire, personal injury or death.

WARNING: Do not dispose of fuel in the household refuse or the public sewage system. Use an authorized waste disposal facility.

When refueling the vehicle fuel tank from a fuel container, use the fuel filler funnel included with your vehicle. See **Locating the Fuel Filler Funnel** (page 167).

Note: Do not use aftermarket funnels as they may not work with the capless fuel system and can damage it.

When refueling the vehicle fuel tank from a fuel container, do the following:

1. Fully open the fuel filler door.



2. Fully insert the fuel filler funnel into the fuel filler inlet.
3. Add fuel to your vehicle from the fuel container.
4. Remove the fuel filler funnel.
5. Fully close the fuel filler door.
6. Clean the fuel filler funnel and place it back in your vehicle or correctly dispose of it.

Fuel and Refueling

Note: If your vehicle runs out of fuel add a minimum of 1.3 gal (5 L) of fuel to restart the engine.

Note: You may need to switch the ignition from off to on several times after refueling to allow the fuel system to pump the fuel from the tank to the engine. When restarting, cranking time takes a few seconds longer than normal.

Note: Extra funnels can be purchased from an authorized dealer if you choose to dispose of the funnel.

REFUELING

REFUELING SYSTEM OVERVIEW

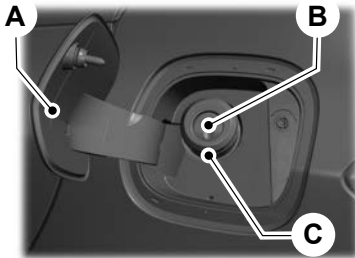

- A Fuel filler door.
- B Fuel tank filler valve.
- C Fuel tank filler pipe.

REFUELING YOUR VEHICLE

WARNING: When refueling always shut the engine off and never allow sparks or open flames near the fuel tank filler valve. Never smoke or use a cell phone while refueling. Fuel vapor is extremely hazardous under certain conditions. Avoid inhaling excess fumes.

WARNING: The fuel system may be under pressure. If you hear a hissing sound near the fuel filler inlet, do not refuel until the sound stops. Otherwise, fuel may spray out, which could cause serious personal injury.

WARNING: Do not pry open the fuel tank filler valve. This could damage the fuel system. Failure to follow this instruction could result in fire, personal injury or death.

WARNING: Do not remove the fuel pump nozzle from its fully inserted position when refueling.

WARNING: Stop refueling when the fuel pump nozzle automatically shuts off for the first time. Failure to follow this will fill the expansion space in the fuel tank and could lead to fuel overflowing.

WARNING: Do not overfill the fuel tank. The pressure in an overfilled tank may cause leakage and lead to fuel spray and fire.

WARNING: Wait at least five seconds before removing the fuel pump nozzle to allow any residual fuel to drain into the fuel tank.

1. Fully open the fuel filler door.

Fuel and Refueling

2. Select the correct fuel pump nozzle for your vehicle.

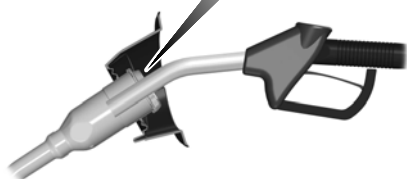
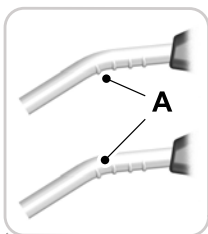

3. Insert the fuel pump nozzle up to the first notch. Keep the fuel pump nozzle resting on the fuel tank filler pipe.

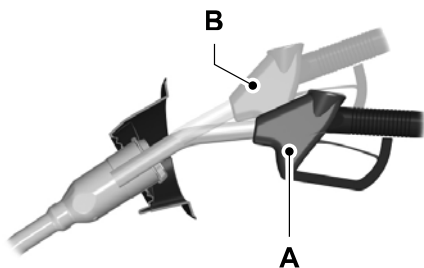

4. Hold the fuel pump nozzle in position A when refueling. Holding the fuel pump nozzle in position B can affect the flow of fuel and shut off the fuel pump nozzle before the fuel tank is full.

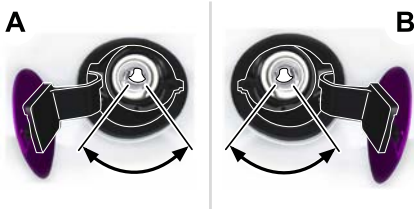

5. Operate the fuel pump nozzle within the area shown. Refer to A for left hand drive or B for right hand drive.

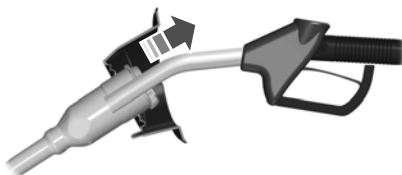

6. When the pump shuts off, wait five seconds, then raise the fuel pump nozzle and slowly remove it.
7. Fully close the fuel filler door.

Note: Do not attempt to start the engine if you have filled the fuel tank with incorrect fuel. Incorrect fuel use could cause damage not covered by the vehicle Warranty. Have your vehicle immediately checked.

MANUALLY OPENING THE FUEL FILLER DOOR

Your vehicle does not have a fuel tank filler cap.

Fuel and Refueling

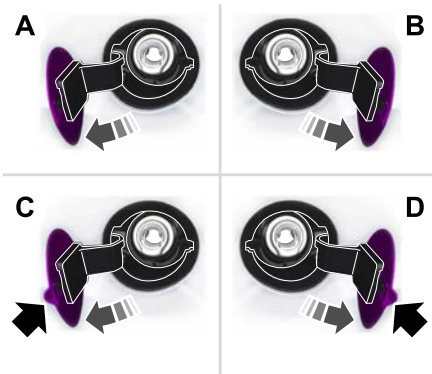

- A Left-hand side. To open the fuel filler door, press the center rear edge of the fuel filler door and then release.
- B Right-hand side. To open the fuel filler door, press the center rear edge of the fuel filler door and then release.
- C Left-hand side. Pull the rear of the fuel filler door to open it.
- D Right-hand side. Pull the rear of the fuel filler door to open it.

FUEL TANK CAPACITY

Advertised Capacity

The advertised capacity is the maximum amount of fuel that you can add to the fuel tank when the fuel gauge indicates empty. In addition, the fuel tank contains an empty reserve. The empty reserve is an unspecified amount of fuel that remains in the fuel tank when the fuel gauge indicates empty.

Note: *The amount of fuel in the empty reserve varies and should not be relied upon to increase driving range.*

FUEL AND REFUELING – TROUBLESHOOTING

FUEL AND REFUELING – WARNING LAMPS



If it illuminates when you are driving, refuel as soon as possible.

FUEL AND REFUELING – INFORMATION MESSAGES

Refueling System Warning

If the fuel tank filler valve does not fully close, a message could appear in the information display.

Message
Check Fuel Fill Inlet

If the message appears, do the following:

1. Stop your vehicle as soon as it is safe to do so and switch the engine off.
2. Shift into park (P) or neutral (N).
3. Apply the parking brake.
4. Fully open the fuel filler door.
5. Check the fuel tank filler valve for any debris that may be restricting its movement.
6. Remove any debris from the fuel tank filler valve.
7. Fully insert a fuel pump nozzle or the fuel filler funnel provided with your vehicle into the fuel filler pipe. See **Locating the Fuel Filler Funnel** (page 167). This action should dislodge any debris that may be preventing the fuel tank filler valve from fully closing.
8. Remove the fuel pump nozzle or fuel filler funnel from the fuel filler pipe.

Fuel and Refueling

9. Fully close the fuel filler door.

Note: *The message may not immediately reset. If the message continues to appear and a warning lamp illuminates, have your vehicle checked as soon as possible.*

Catalytic Converter

WHAT IS THE CATALYTIC CONVERTER

The catalytic converter is part of your vehicle's emissions system and filters harmful pollutants from the exhaust gas.

CATALYTIC CONVERTER PRECAUTIONS



WARNING: Do not park, idle or drive your vehicle on dry grass or other dry ground cover. The emission system heats up the engine compartment and exhaust system, creating the risk of fire.



WARNING: The normal operating temperature of the exhaust system is very high. Never work around or attempt to repair any part of the exhaust system until it has cooled. Use special care when working around the catalytic converter. The catalytic converter heats up to a very high temperature after only a short period of engine operation and stays hot after the engine is switched off.

To avoid damaging the catalytic converter:

- Do not crank the engine for more than 10 seconds at a time.
- Do not run the engine with a spark plug lead disconnected.
- Do not push-start or tow-start your vehicle. Use booster cables. See **Jump Starting the Vehicle** (page 301).
- Use the correct fuel. See **Fuel and Refueling** (page 166).
- Do not switch the ignition off when your vehicle is moving.
- Avoid running out of fuel.
- Have the items listed in scheduled maintenance information performed according to the specified schedule.

Note: Do not make any unauthorized changes to your vehicle or engine. By law, vehicle owners and anyone who manufactures, repairs, or services a fleet of vehicles are not permitted to intentionally remove an emission control device or prevent it from working.

CATALYTIC CONVERTER – TROUBLESHOOTING

CATALYTIC CONVERTER – WARNING LAMPS

Your vehicle has an on-board diagnostics system that monitors the emission control system. If any of the following warning lamps illuminate, this may indicate that the on-board diagnostics system has detected an emission control system malfunction.



Continuing to drive your vehicle may cause reduced power or the engine to stop. Failure to respond to a warning lamp may cause damage that your vehicle Warranty may not cover. Have your vehicle checked as soon as possible.

Manual Transmission

MANUAL TRANSMISSION PRECAUTIONS



WARNING: Always set the parking brake fully and make sure you shift the gearshift lever to first gear. Switch the ignition off and remove the key whenever you leave your vehicle.

Failure to fully press the clutch pedal to the floor may cause increased shift efforts, premature wear to transmission components or damage the transmission.

Do not drive with your foot resting on the clutch pedal or use the clutch pedal to hold your vehicle at a standstill when waiting on a hill. These actions reduce the life of the clutch and could nullify a clutch warranty claim.

SHIFTING INTO REVERSE

Reverse (R)

1. Press the clutch pedal to the floor to disengage clutch.
2. Shift into reverse (R) by raising the collar below the gearshift knob up, then moving the lever fully to the left, then forward.

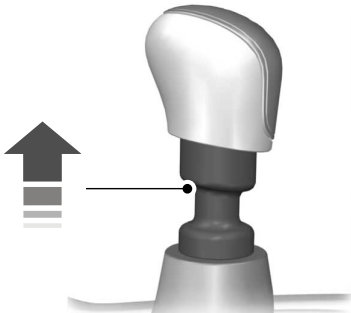

Note: You can only move the gearshift lever to reverse (R) by raising the collar below the gearshift knob up before shifting to reverse. This is a lockout feature which protects the transmission from accidentally engaging reverse (R) when intending to select first (1).

If reverse (R) is not fully engaged, press the clutch pedal down and return the gearshift to the neutral position. Release the clutch pedal, then raise the collar and shift to reverse (R) again.

Note: Do not move the transmission selector lever to reverse (R) gear when your vehicle is moving. This can cause damage to the transmission.

Note: Make sure that your vehicle is at a complete stop before you shift into reverse (R). Failure to do so could damage the transmission.

CRAWLER GEAR

WHAT IS CRAWLER GEAR

Allows you to cruise at ultra low speeds with the clutch fully engaged, when driving through obstacles and jagged terrain.

USING CRAWLER GEAR

Crawler (C)

Shifting into crawler gear:

1. Press the clutch pedal to the floor to disengage clutch.
2. Shift into crawler (C) by raising the collar below the gearshift knob up, then moving the lever fully to the left, then backward.

Manual Transmission

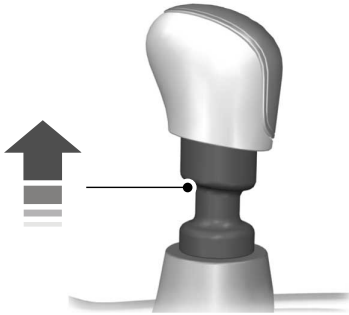

Note: You can only move the gearshift lever to crawler (C) by raising the collar below the gearshift knob up before shifting to crawler. This is a lockout feature which protects the transmission from accidentally engaging crawler (C) when intending to select second (2).

If crawler (C) is not fully engaged, press the clutch pedal down and return the gearshift to the neutral position. Release the clutch pedal, then raise the collar and shift to crawler (C) again.

The crawler gear enables an easier start in unusual conditions or terrain. You should change up to first (1) when possible and refrain from using crawler (C) at high engine speeds as transmission damage could result. See **Manual Transmission Precautions** (page 174).

In normal use, ensure your vehicle is stationary before selecting crawler (C) as it is primarily a starting gear. If you change down to crawler (C) from first (1) while the vehicle is moving, ensure an engine speed is below 1500 rpm, and that the clutch pedal is fully pressed for a smooth transition to crawler gear.

RECOMMENDED SHIFT SPEEDS

Recommended Shift Speeds

For best fuel efficiency when driving your vehicle, shift to the next gear by 3000 RPM.

Shifting at a higher RPM such as 3000-6000 RPM can increase the performance capabilities of the vehicle. However, higher engine and transmission speeds can increase wear and reduce fuel economy.

When downshifting your vehicle, always shift at the lowest engine RPM possible to match your driving conditions. This is usually under 2000 RPM for all forward gears, except for downshifting into the crawler (C) gear which you should do below 1500 RPM. See **Manual Transmission Precautions** (page 174).

Note: Always fully depress the clutch pedal between gear shifts.

Manual Transmission

CHECKING THE MANUAL TRANSMISSION FLUID LEVEL

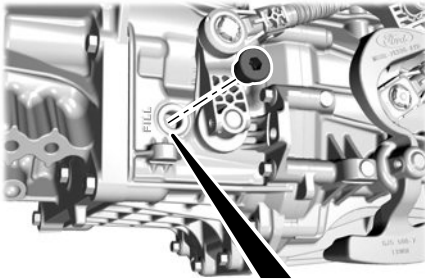

Transmission fill level is 0.16 in (4 mm) from oil fill plug.

CHECKING THE CLUTCH FLUID LEVEL



1. Check the system for any visual leaks before continuing.
2. Make sure the clutch pedal is in the most upward position.
3. Remove the cap and diaphragm and inspect the fluid level. To avoid contamination, make sure the reservoir cap remains in place and fully tightened unless you are checking the fluid level.
4. Reinstall the reservoir cap and diaphragm.

Only use fluid that meets our specifications. See **Capacities and Specifications** (page 393).

Note: A fluid level on the step line in the reservoir is within the normal operating range and there is no need to add fluid. A fluid level not in the normal operating range could compromise the performance of the system. Have your vehicle checked immediately.

MANUAL TRANSMISSION FLUID CAPACITY AND SPECIFICATION

See **Manual Transmission Fluid Capacity and Specification** (page 403).

CLUTCH FLUID CAPACITY AND SPECIFICATION

See **Capacities and Specifications** (page 393).

Manual Transmission

MANUAL TRANSMISSION – TROUBLESHOOTING

MANUAL TRANSMISSION – FREQUENTLY ASKED QUESTIONS

Using Crawler Gear



When shifting into crawler (C), make sure your vehicle is completely stationary and that the engine speed is below 1500 RPM.

Because the low gear ratio enables you to start the vehicle in off-road conditions, shift out of crawler (C) as soon as possible. Prolonged use of crawler (C) can cause transmission wear and increased fuel consumption.

Note: Use crawler (C) when driving your vehicle off-road, or in hilly, rocky terrain.

Automatic Transmission

AUTOMATIC TRANSMISSION PRECAUTIONS



WARNING: Apply the parking brake, shift into park (P), switch the ignition off and remove the key before you leave your vehicle. Failure to follow this instruction could result in personal injury or death.



WARNING: Do not use tow/haul when the road surface is slippery. Failure to follow this instruction could result in the loss of control of your vehicle.



WARNING: When your vehicle is stationary, keep the brake pedal fully pressed when shifting gears. Failure to follow this instruction could result in personal injury, death or property damage.



WARNING: Do not apply the brake pedal and accelerator pedal simultaneously. Applying both pedals simultaneously for more than a few seconds will limit engine performance, which may result in difficulty maintaining speed in traffic and could lead to serious injury.

AUTOMATIC TRANSMISSION POSITIONS

PARK (P)

This position locks the driveline and prevents the wheels from turning. Come to a complete stop before putting your vehicle into and out of park (P).

The electric parking brake could apply when you shift to park (P) without the brake pedal fully pressed. The electric parking brake applies when you shift to park (P) on large slopes. The electric parking brake releases with the drive away release function or manually as described in the Releasing the Electric Parking Brake section. See **Electric Parking Brake** (page 198).

Note: A warning tone sounds if you open the driver door and you have not shifted the transmission selector to park (P).

REVERSE (R)



WARNING: Move the transmission selector lever to reverse (R) only when your vehicle is stationary and the engine is at idle speed.

This position allows your vehicle to move backward. Come to a complete stop before shifting into and out of reverse (R).

NEUTRAL (N)



WARNING: In neutral (N) your vehicle is free to roll.

This position allows your vehicle to roll free. Hold the brake pedal down when in this position.

Note: You can start your vehicle in this position.

DRIVE (D)

Drive (D) is the normal driving position for the best fuel economy, and allows automatic upshifts and downshifts through all available gears.

Automatic Transmission

MANUAL (M)

To select manual mode press the (M) button on the shifter.

Note: *In order to activate manual mode your vehicle must be in drive (D).*

This position allows you to change gears up or down as preferred using + or - buttons on the shifter lever.

To return to the normal drive (D) position, press the (M) button again to exit manual mode.

SPORT (S)



To activate Sport Mode, press the button on the gearshift lever until sport mode is selected. The SPORT or **S** indicator light illuminates in the instrument display when the system becomes active.

The sport mode feature:

- Provides additional slope, engine braking and extends lower gear operation to enhance performance for uphill climbs, hilly terrain or mountainous areas. This increases engine RPM during engine braking.
- Provides additional lower gear operation through the automatic transmission shift strategy.
- Selects gears more quickly and at higher engine speeds.

To deactivate the sport mode feature and return to normal driving mode, press the button on the gearshift lever again. The SPORT or **S** indicator light deactivates when the system turns off. The sport mode feature also deactivates when you power down your vehicle.

SHIFTING YOUR VEHICLE INTO GEAR



1. Fully press down on the brake pedal.
2. Press the front button on the shifter and move the gearshift lever into the desired gear.
3. When you finish driving, come to a complete stop.
4. Press the front button on the shifter, move the gearshift lever and securely latch it in park (P).

AUTOMATIC TRANSMISSION POSITION INDICATORS

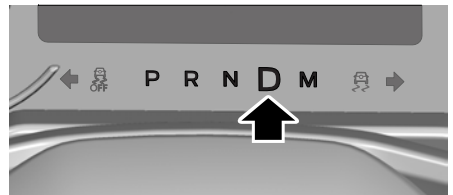

Automatic Transmission

MANUALLY SHIFTING GEARS

SHIFTING USING THE BUTTONS ON THE SELECTOR LEVER

Your vehicle has a SelectShift Automatic transmission gearshift lever. This gives you the ability to change gears up or down, without a clutch, as preferred.

To prevent the engine from running at too low an RPM, which could cause it to stall, SelectShift still makes some downshifts if it determines that you have not downshifted in time. Although SelectShift makes some downshifts for you, it still allows you to downshift at any time if it determines that damage to the engine from over-revving does not occur.

Note: *SelectShift does not automatically upshift, even if the engine is approaching the RPM limit. Shift manually by pressing the + button.*

Note: *Engine damage could occur if you maintain excessive engine revving without shifting.*

BRAKE SHIFT INTERLOCK

WHAT IS BRAKE SHIFT INTERLOCK

Brake shift interlock prevents you from shifting out of park (P) when you have switched the ignition on and not pressed the brake pedal.

BRAKE SHIFT INTERLOCK PRECAUTIONS

WARNING: Do not drive your vehicle until you verify that the stoplamps are working.

WARNING: When doing this procedure, you need to take the transmission out of park (P) which means your vehicle can roll freely. To avoid unwanted vehicle movement, always fully apply the parking brake prior to doing this procedure. Use wheels chocks if appropriate.

WARNING: If the parking brake is fully released, but the brake warning lamp remains illuminated, the brakes may not be working properly. Have your vehicle checked as soon as possible.

In the event of an electrical malfunction, it is possible that a fuse has blown or the stoplamps are not working. See **Fuse Precautions** (page 310).

If the vehicle battery has no charge, jump start your vehicle. See **Jump Starting Precautions** (page 300).

USING BRAKE SHIFT INTERLOCK

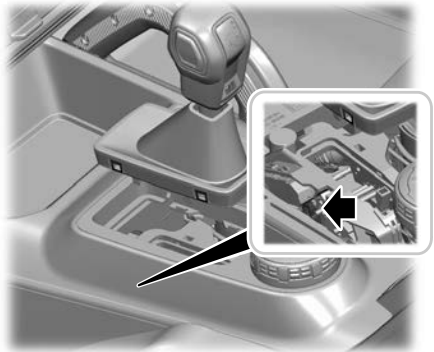

1. Insert a screwdriver between the shifter boot material and trim ring to access the retainer tabs from the top panel trim ring.

Automatic Transmission

2. Lift the shifter boot upward.
3. Locate the release lever on the side of the transmission selector lever.
4. Using a screwdriver, move the release lever toward the front of the transmission selector lever.
5. When holding the release lever in the forward position, move the transmission selector lever out of the park (P) position and into another gear.

AUTOMATIC TRANSMISSION AUDIBLE WARNINGS

Transmission Not In Park(P) Audible Warning

Sounds if any of the following occur:

- You switch your vehicle off before shifting into park (P).
- You open the driver door before shifting into park (P).
- You unlatch your seatbelt before shifting into park (P) when the driver door is removed. See **Removable Windows** (page 334).

Four-Wheel Drive

HOW DOES FOUR-WHEEL DRIVE WORK - 4X4 WITH PART TIME ENGAGEMENT

4x4 With Part Time Engagement (If Equipped)

This system offers the driver two-wheel drive high, four-wheel drive high, and four-wheel drive low as available modes of operation. When you select either four-wheel drive high or four-wheel drive low, the system provides mechanically locked four-wheel drive power to both the front and rear wheels for use in off-road or slippery conditions such as deep snow, sand or mud. Selecting four-wheel drive low also provides additional gearing for increased torque multiplication for conditions like deep sand, steep slopes, or pulling heavy objects.

Additionally, the system is capable of recreational flat towing by putting the transfer case into neutral (N). See **Recreationally Towing Your Vehicle** (page 307).

HOW DOES FOUR-WHEEL DRIVE WORK - ADVANCED 4X4 WITH 4A MODE

Advanced 4x4 With Automatic On Demand Engagement (If Equipped)

This system monitors various vehicle sensory inputs to provide an increased level of performance. This system offers the driver two-wheel drive high, four-wheel drive auto, four-wheel drive high, and four-wheel drive low as available modes of operation. When you select four-wheel drive auto, the system continuously varies power to the front wheels for optimum performance for all on-road conditions. When you select either four-wheel drive

high or four-wheel drive low, the system provides electronically locked power to the front and rear wheels for use in off-road or slippery conditions such as deep snow, sand or mud. Selecting four-wheel drive low also provides additional gearing for increased torque multiplication for conditions like deep sand, steep slopes, or pulling heavy objects.

Additionally, the system is capable of recreational flat towing by putting the transfer case into neutral (N). See **Recreationally Towing Your Vehicle** (page 307).

FOUR-WHEEL DRIVE PRECAUTIONS



WARNING: Do not become overconfident in the ability of four-wheel drive vehicles. Although a four-wheel drive vehicle may accelerate better than a two-wheel drive vehicle in low traction situations, it won't stop any faster than two-wheel drive vehicles. Always drive at a safe speed.



WARNING: Vehicles with a higher center of gravity (utility and four-wheel drive vehicles) handle differently than vehicles with a lower center of gravity (passenger cars). Avoid sharp turns, excessive speed and abrupt steering in these vehicles. Failure to drive cautiously increases the risk of losing control of your vehicle, vehicle rollover, personal injury and death.

Four-Wheel Drive

FOUR-WHEEL DRIVE LIMITATIONS

Do not use four-wheel drive high or four-wheel drive low mode on dry, hard surfaced roads. Doing so can produce excessive noise, increase tire wear and can damage drive components. Four-wheel drive high or four-wheel drive low mode is only for use on consistently slippery or loose surfaces. Use of four-wheel drive low mode on these surfaces could produce some noise, such as occasional clunks, but should not damage drive components.

For vehicles with an electronic shift-on-the-fly transfer case, the driveline could become mechanically blocked when attempting to shift out of a four-wheel drive mode on dry, hard surfaced roads.

Note: *When your vehicle comes with the 4x4 part-time selectable engagement transfer case and you are transitioning from consistently loose or slippery surfaces, be sure the four-wheel drive system is not mechanically blocked once you are on dry, hard surfaced roads in two-wheel drive high.*

Note: *In certain scenarios, where the four-wheel drive system has difficulty engaging, a **To Engage 4x4 Slow to 3 MPH** or **To Engage 4x4 Slow to 5 km/h** message could appear in the instrument cluster. You can also see this message when engaging the four-wheel drive system in extreme cold climates at the beginning of the drive cycle. Once the driveline warms up, shifting to four-wheel drive can resume as normal.*

Operating Four-Wheel Drive with a Spare or Mismatched Tires

On four-wheel drive vehicles, the size of the spare tire can affect the four-wheel drive system.

If there is a significant difference between the size of the spare tire and the remaining tires, you could have limited four-wheel drive functionality, added noise, discomfort and driveline damage.

Due to normal tire wear, your spare tire is not necessarily the same size as your on-road tires, which makes your spare tire a dissimilar size. Use the spare tire on a limited basis only.

When driving with a dissimilar wheel and tire assembly do not:

- Exceed 50 mph (80 km/h) while operating in a four-wheel drive mode.
- Select a four-wheel drive mode unless the vehicle is stationary.
- Use a four-wheel drive mode on dry pavement.

You could have limited four-wheel drive functionality when driving with a dissimilar wheel and tire assembly, especially when driving in a mechanically locked four-wheel drive mode. You can experience the following:

- Additional noise from the transfer case or other drive components.
- Difficulty shifting in and out of a mechanically locked four-wheel drive mode.
- Driveline component damage.

Mechanical Shift Blocking

On vehicles with an electronic shift-on-the-fly transfer case, the transfer case distributes torque to the front wheels by mechanically interlocking the front and rear driveshafts together. Various external factors can affect shifting performance of this type of system including, but not limited to:

- Vehicle acceleration.
- Dissimilar tire sizes.
- High steering input.

Four-Wheel Drive

For vehicles with an electronic shift-on-the-fly transfer case, when shifting into two-wheel drive high on dry, hard surfaced roads, we recommend that you follow the following procedure to reduce the likelihood of a mechanical shift block:

1. While driving straight, come to a complete stop on a flat, horizontal surface.
2. For vehicles with an automatic transmission, shift into park (P). For vehicles with a manual transmission, press the clutch.
3. Select 2H and wait for the 2H LED to become solid.
4. For vehicles with an automatic transmission, shift into reverse (R). For vehicles with a manual transmission, select reverse (R) and release the clutch. Let the vehicle roll backward up to 3 ft (1 m) and press the brake.
5. For vehicles with an automatic transmission, shift into drive (D). For vehicles with a manual transmission, press the clutch in again, select a forward gear and release the clutch. Let the vehicle roll forward up to 3 ft (1 m).

If the system is mechanically blocked, one or more of the following actions can relieve the mechanical shift block:

- Momentary acceleration.
- Momentary braking.
- Bringing the vehicle to a stop.
- Shifting the transmission to neutral and back to drive.
- Shifting the transmission to reverse and back to drive.
- Driving the vehicle around a tight turn at a slow speed.

SWITCHING FOUR-WHEEL DRIVE ON AND OFF

A vehicle that comes with four-wheel drive, when selected, has the ability to use all four wheels to power itself. This increases traction, which may enable you to safely drive over terrain and road conditions that a conventional two-wheel drive vehicle cannot.

On some four-wheel drive models, the initial shift from two-wheel drive to four-wheel drive while the vehicle is moving can cause a momentary clunk and ratcheting sound. These sounds are normal as the front drivetrain comes up to speed and are not cause for concern.

Note: *Your four-wheel drive system is for use with a spare tire that is identical in make, model and size, to the road tires.*

We make four-wheel drive vehicles specially for driving on sand, snow, mud and rough terrain and having operating characteristics that are somewhat different from conventional vehicles, both on and off the road.

The transfer case supplies power to all four wheels. On four-wheel drive vehicles, the transfer case allows you to select different four-wheel drive modes when necessary.

Four-Wheel Drive

SELECTING A FOUR-WHEEL DRIVE MODE - 4X4 WITH PART TIME ENGAGEMENT



To select a four-wheel drive mode, push the button.

- 2H - Two-wheel drive high.
- 4H - Four-wheel drive high. See **Four-Wheel Drive High** (page 187).
- 4L - Four-wheel drive low. See **Four-Wheel Drive Low** (page 187).

Shifting to or from Four-Wheel Drive Low

1. Bring your vehicle to a speed of 0 mph (0 km/h).
2. For vehicles with an automatic transmission, place in neutral (N). For vehicles with a manual transmission, fully depress the clutch pedal.
3. Push the 4L on the four-wheel drive mode selector.

Note: A **4x4 Shift in Progress** message appears in the information display indicating the shift is in progress. If any of the previous shift conditions are not met, the shift should not occur and the information display can guide the driver through the proper shifting procedures.

Note: If **Shift Delayed Drive Forward** displays in the information display, place the transmission in a forward gear, move your vehicle forward approximately 5 ft (1.5 m), and shift the transmission back to neutral (N) to allow the transfer case to complete the range shift.

Note: When the light is solid, the system has achieved the desired four-wheel drive mode. When a selected four-wheel drive mode light is blinking, the system is attempting to shift to that specific four-wheel drive mode.

Note: When you achieve recreational towing, all lights will be off and the instrument cluster will display **Neutral Tow Enabled Leave Transmission in Neutral**.

Four-Wheel Drive

SELECTING A FOUR-WHEEL DRIVE MODE- ADVANCED 4X4 WITH 4A MODE



To select a four-wheel drive mode, push the button.

- 2H - Two-wheel drive high.
- 4A - Four-wheel drive Auto. See **Four-Wheel Drive Auto** (page 187).
- 4H - Four-wheel drive high. See **Four-Wheel Drive High** (page 187).
- 4L - Four-wheel drive low. See **Four-Wheel Drive Low** (page 187).

Shifting to or from Four-Wheel Drive Low

1. Bring your vehicle to a speed of 0 mph (0 km/h).
2. For vehicles with an automatic Transmission, place in neutral (N). For vehicles with a manual transmission, fully depress the clutch pedal.
3. Push the 4L on the four-wheel drive mode selector.

Note: A **4x4 Shift in Progress** message appears in the information display indicating the shift is in progress. If any of the previous shift conditions are not met, the shift should not occur and the information display can guide the driver through the proper shifting procedures.

Note: If **Shift Delayed Drive Forward** displays in the information display, place the transmission in a forward gear, move your vehicle forward approximately 5 ft (1.5 m), and shift the transmission back to neutral (N) to allow the transfer case to complete the range shift.

Note: When the light is solid, the system has achieved the desired four-wheel drive mode. When a selected four-wheel drive mode LED is blinking, the system is attempting to shift to that specific four-wheel drive mode.

Note: When all lights are blinking have your vehicle serviced as soon as possible.

Note: When you achieve recreational towing, all lights will be off and the instrument cluster will display **Neutral Tow Enabled Leave Transmission in Neutral**.

FOUR-WHEEL DRIVE MODES

TWO-WHEEL DRIVE HIGH

Two-wheel drive high is for general on-road driving. Power is sent to the rear wheels only.

Note: Two-wheel drive high can turn on or off based on Drive Mode selection See **G.O.A.T. Mode Control** (page 242).

Four-Wheel Drive

FOUR-WHEEL DRIVE AUTO (If Equipped)

Four-wheel drive auto provides electronically controlled four-wheel drive power to both the front and rear wheels, as required, for increased traction in varying on-road conditions. The four-wheel drive auto tuning varies based on selected Drive Mode. See **Selecting a Four-Wheel Drive Mode** (page 185).

Note: *Four-wheel drive auto can turn on or off automatically based on Drive Mode selection. See **Selecting a Four-Wheel Drive Mode** (page 185).*

FOUR-WHEEL DRIVE HIGH

Four-wheel drive high provides electronically or mechanically locked four-wheel drive power to both the front and rear wheels for use in off-road or winter conditions such as deep snow, sand or mud. This mode is not for use on dry pavement.

Note: *Four-wheel drive high can turn on or off automatically based on Drive Mode selection. See **Selecting a Four-Wheel Drive Mode** (page 185).*

FOUR-WHEEL DRIVE LOW

Four-wheel drive low provides electronically or mechanically locked four-wheel drive power to both the front and rear wheels for use on low traction surfaces, but does so with additional gearing for increased torque multiplication. This mode is only for off-road conditions such as deep sand, steep slopes, or pulling heavy objects.

Note: *Four-wheel drive low can turn on or off automatically based on drive mode selection. See **Selecting a Four-Wheel Drive Mode** (page 185).*

FOUR-WHEEL DRIVE INDICATORS

Two-wheel Drive High



Illuminates briefly when two-wheel drive high is selected.

Four-wheel Drive Auto (If Equipped)



Illuminates when four-wheel drive auto is selected.

Four-wheel Drive High



Illuminates when four-wheel drive high is selected.

Four-wheel Drive Low



Illuminates when four-wheel drive low is selected.

TRANSFER CASE FLUID CAPACITY AND SPECIFICATION

See **Transfer Case Fluid Capacity and Specification** (page 405).

FOUR-WHEEL DRIVE – TROUBLESHOOTING

FOUR-WHEEL DRIVE – WARNING LAMPS



Illuminates when a four-wheel drive or power train fault is present.

Four-Wheel Drive

Note: When a system fault is present, the system can typically remain in whichever mode was selected prior to the fault condition occurring. It does not default to two-wheel drive in all circumstances. When this warning is displayed, have your vehicle serviced by an authorized dealer.

FOUR-WHEEL DRIVE – INFORMATION MESSAGES

Message	Details
For 4L slow to a stop	Displays when the driver attempts to shift into four-wheel drive low when traveling at too high of a speed.
For 4L Shift to N	Displays when the driver attempts to shift into four-wheel drive low without the transmission in neutral (N).
For 4L press Clutch	Displays when the driver attempts to shift into four-wheel drive low without the clutch pedal pressed.
To exit 4L slow to a stop	Displays when the driver attempts to shift out of four-wheel drive low when traveling at too high of a speed.
To Exit 4L Shift to N	Displays when the driver attempts to shift out of four-wheel drive low without the transmission in neutral (N).
To exit 4L Press Clutch	Displays when the driver attempts to shift out of four-wheel drive low without the clutch pedal pressed.
4x4 Shift in Progress	Displays when the four-wheel drive system is shifting into and out of two-wheel drive high or between high and low ranges.
4X4 Temporarily Locked	Displays when the four-wheel drive system detects a driving condition which temporarily requires greater four-wheel drive performance. The system resumes normal function after the system no longer detects these driving conditions.
4x4 Temporarily Disabled	Displays when the four-wheel system detects elevated system temperature and temporarily stops providing power to the front wheels. The system resumes normal function when the system temperature returns to normal.
4x4 Restored	Displays when the four-wheel drive system resumes normal function.

Four-Wheel Drive

Message	Details
Shift Delayed Drive Forward	Displays when the transfer case is not able to complete a shift and requires forward motion to complete the shift.
4x4 OFF	Displays when the system has become disabled due to mismatched tires or an external fault.
Neutral Tow Enabled Leave Transmission in Neutral	Displays when neutral tow mode has been successfully engaged.
Neutral Tow Disabled	Displays when neutral tow mode has been successfully disengaged.
Selected 4x4 Mode Not Available in Current Drive Mode	Displays when the driver selects a four-wheel drive mode that is disallowed in the currently selected drive mode.
To Engage 4x4 Slow to 5 km/h	Displays when the system is unable to engage four-wheel drive high and requires the driver to slow down before attempting to engage.
To Engage 4x4 Release Accelerator Pedal	Displays when the four-wheel drive system requires the accelerator pedal to be released to perform the shift into four-wheel drive mode.
4x4 Performance Reduced See Manual	Displays when the system has entered a degraded mode due to mismatched tires.

Electronic Locking Differential (If Equipped)

WHAT IS THE ELECTRONIC LOCKING DIFFERENTIAL

The electronic locking differential is a device housed in the front or rear axle, and when activated allows both wheels on that axle to turn at the same speed. The electronic locking differential can provide additional traction should your vehicle become stuck. You can activate the differential electronically and shift it on the fly within the operating speed range. The electronic differential automatically disengages when the vehicle speed exceeds a set value and it automatically reengages when the vehicle speed goes below a set value. See **Switching the Electronic Locking Differential On and Off** (page 190). It also automatically engages based on certain selected drive modes. See **G.O.A.T. Mode Control** (page 242). The electronic locking differential is for use in mud, rocks, sand, or any off-road condition where you need maximum traction. It is not for use on dry pavement.

Note: *The electronic locking differentials are for off-road use only and not for use on dry pavement. Using the electronic locking differentials on dry pavement results in increased tire wear, noise and vibration.*

Note: *The front electronic locking differential is only available in four-wheel drive low.*

Note: *Locking the front differential reduces your ability to make tight turning maneuvers and creates additional resistance to steering inputs.*

Front Electronic Locking Differential Engagement Speed and Availability

Four-Wheel Drive Mode	Maximum Engagement Speed	Automatic Disengagement Speed	Automatic Re-Engagement Speed
4L	20 mph (32 km/h)	25 mph (41 km/h)	20 mph (32 km/h)

Note: *Switching the electronic locking differentials off while turning results in disengagement difficulties. If the electronic locking differential has difficulty disengaging, release the accelerator pedal and turn the steering wheel back and forth in small increments while maintaining control and following a straight line.*

SWITCHING THE ELECTRONIC LOCKING DIFFERENTIAL ON AND OFF

Activating the Electronic Locking Differential

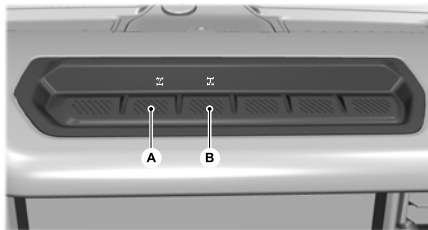

A	Front locking differential switch
B	Rear locking differential switch

You can activate the front or rear locking differential by pressing the switch on the center switch pack.

Electronic Locking Differential (If Equipped)

Rear Electronic Locking Differential Engagement Speed and Availability

Drive Modes (Four-Wheel Drive Modes)	Maximum Engagement Speed	Automatic Disengagement Speed	Automatic Re-Engagement Speed
Normal (2H,4A, 4H)	20 mph (32 km/h)	25 mph (41 km/h)	20 mph (32 km/h)
Eco (2H, 4A, 4H)	20 mph (32 km/h)	25 mph (41 km/h)	20 mph (32 km/h)
Sport (2H, 4A, 4H)	20 mph (32 km/h)	25 mph (41 km/h)	20 mph (32 km/h)
Slippery (2H, 4A, 4H)	20 mph (32 km/h)	25 mph (41 km/h)	20 mph (32 km/h)
Deep Snow/Sand (4H, 4L) ¹	No Speed Limit	No Speed Limit	No Speed Limit
Mud/Ruts (4H, 4L) ¹			
Baja (2H, 4H, 4L)			
Rock Crawl (4L) ¹			

¹Automatically engages when you select these drive modes. You have the ability to manually override the automatic engagement by pressing the electronic locking differential switch.

Drive Modes (Four-Wheel Drive Modes)	Maximum Engagement Speed	Automatic Disengagement Speed	Automatic Re-Engagement Speed
4L	No Speed Limit	No Speed Limit	No Speed Limit

ELECTRONIC LOCKING DIFFERENTIAL INDICATORS



Rear locking differential Indicator.



Front locking differential Indicator.

If the front or rear indicator in the cluster is amber, both wheels of the indicated axle are locked together providing additional traction.

If the electronic locking differential is selected and the indicator in the cluster is gray or turns from amber to gray while driving, one of the following has occurred:

- Your vehicle speed is too high.
- The accelerator pedal is too high during an engagement attempt.
- Your vehicle is experiencing an anti-lock brake activation.
- The left and right wheel speed difference is too high during an engagement attempt.

Electronic Locking Differential (If Equipped)

If the electronic locking differential is selected and the indicator in the cluster does not turn on, one of the following has occurred:

- The electronic locking differential is not allowed in the current drive mode and is accompanied by **SELECTED LOCKING DIFFERENTIAL NOT AVAILABLE IN CURRENT DRIVE MODE** in the information display.
- The electronic locking differential is not allowed in the current 4x4 mode and is accompanied by **SELECTED LOCKING DIFFERENTIAL NOT AVAILABLE IN CURRENT 4x4 MODE** in the information display.
- The system has malfunctioned and is accompanied by **CHECK LOCKING DIFFERENTIAL** in the information display. See your authorized dealer for assistance.

ELECTRONIC LOCKING DIFFERENTIAL – TROUBLESHOOTING

ELECTRONIC LOCKING DIFFERENTIAL – INFORMATION MESSAGES

Message	Details
Selected Locking Differential Not Available in Current Drive Mode	The selected electronic locking differential is not available in current drive mode. See G.O.A.T. Mode Control (page 242).
Selected Locking Differential Not Available in Current 4x4 Mode	The selected electronic locking differential is not available in your current four-wheel drive mode. See G.O.A.T. Mode Control (page 242).
To Engage Locking Differential Release Accelerator Pedal	The selected electronic locking differential requires that you release the accelerator pedal in order to engage.
Check Locking Differential	An electronic locking differential system fault is present. See your authorized dealer as soon as possible.

The following conditions affect the electronic locking differential:

Electronic Locking Differential (If Equipped)

- Based on drive mode selection, the rear electronic locking differential does not engage if your vehicle speed is above 20 mph (32 km/h).
 - The front electronic locking differential does not engage if your vehicle speed is above 20 mph (32 km/h) in four-wheel drive low (4L).
 - Based on drive mode selection, the electronic locking differential automatically disengages at speeds above 25 mph (41 km/h) and automatically re-engages at speeds below 20 mph (32 km/h).
 - The electronic locking differential may not engage if you press your accelerator pedal during an engagement attempt. A message may display in the instrument display guiding you to release the accelerator pedal.
 - In four-wheel drive low (4L), the front electronic locking differential automatically disengages at speeds above 25 mph (41 km/h) and automatically re-engages at speeds below 20 mph (32 km/h).
 - The AdvanceTrac system has the ability to take over control of the electronic locking differential and disable it during driving maneuvers when necessary.
- release the accelerator pedal and turn the steering wheel in the opposite direction when rolling. We recommend engaging and disengaging the electronic locking differential at a stop when you mount a spare or mismatched tire on either axle.

Operating Electronic Locking Differential With a Spare or Mismatched Tires

On vehicles with an electronic locking differential, the size of the spare tire can affect performance of the system. If there is a significant difference between the two rear tires or two front tires, you may have limited electronic locking differential functionality. If the electronic locking differential has difficulty disengaging,

Brakes

BRAKE PRECAUTIONS



WARNING: Driving your vehicle with the warning lamp on is dangerous. A significant decrease in braking performance may occur. It may take you longer to stop your vehicle. Have your vehicle checked as soon as possible. Driving extended distances with the parking brake engaged can cause brake failure and the risk of personal injury.

Wet brakes result in reduced braking efficiency. Gently press the brake pedal a few times when driving from a car wash or standing water to dry the brakes.

ANTI-LOCK BRAKING SYSTEM

ANTI-LOCK BRAKING SYSTEM LIMITATIONS

The anti-lock braking system does not eliminate the risk of crash when:

- You drive too closely to the vehicle in front of you.
- Your vehicle is hydroplaning.
- You take corners too fast.
- The road surface is poor.

Note: *If the system activates, the brake pedal could pulse and could travel further. Maintain pressure on the brake pedal.*

BRAKE OVER ACCELERATOR

In the event the accelerator pedal becomes stuck or entrapped, apply steady and firm pressure to the brake pedal to slow the vehicle and reduce engine power. If you experience this condition, apply the brakes and bring your vehicle to a safe

stop. Move the transmission to park (P), switch the engine off and apply the parking brake. Inspect the accelerator pedal for any interference. If none are found and the condition persists, have your vehicle towed to the nearest authorized dealer.

LOCATING THE BRAKE FLUID RESERVOIR - 2.3L ECOBOOST™

- See **Under Hood Overview** (page 319).

LOCATING THE BRAKE FLUID RESERVOIR - 2.7L ECOBOOST™

- See **Under Hood Overview** (page 320).

CHECKING THE BRAKE FLUID



WARNING: Do not use any fluid other than the recommended brake fluid as this will reduce brake efficiency. Use of incorrect fluid could result in the loss of vehicle control, serious personal injury or death.



WARNING: Only use brake fluid from a sealed container. Contamination with dirt, water, petroleum products or other materials may result in brake system damage or failure. Failure to adhere to this warning could result in the loss of vehicle control, serious personal injury or death.



WARNING: Do not allow the fluid to touch your skin or eyes. If this happens, rinse the affected areas immediately with plenty of water and contact your physician.

Brakes



WARNING: The brake system could be affected if the brake fluid level is below the **MIN** mark or above the **MAX** mark on the brake fluid reservoir.



1. Park your vehicle on a level surface.
2. Look at the brake fluid reservoir to see where the brake fluid level is relative to the **MIN** and the **MAX** marks on the reservoir.

Note: To avoid fluid contamination, the reservoir cap must remain in place and fully tight, unless you are adding fluid.

Only use fluid that meets our specifications. See **Capacities and Specifications** (page 393).

BRAKE FLUID SPECIFICATION

See **Brake Fluid Specification** (page 404).

BRAKES – TROUBLESHOOTING

BRAKES – WARNING LAMPS



If the ABS indicator illuminates when you are driving, this indicates a malfunction. Your vehicle continues to have normal braking without the anti-lock braking system function. See an authorized dealer.

It also momentarily illuminates when you switch the ignition on to confirm the lamp is functional. If it does not illuminate when you switch the ignition on, or begins to flash at any time, have the system checked by an authorized dealer.

BRAKE



The brake indicator momentarily illuminates when you switch the ignition on to confirm the lamp is functional. It may also illuminate when you apply the parking brake and the ignition is on. If it illuminates when your vehicle is moving, make sure the parking brake is disengaged. If the parking brake is disengaged, this indicates low brake fluid level or a brake system fault. See an authorized dealer.

Brakes

BRAKES – INFORMATION MESSAGES

Message	Details
Brake Fluid Level Low	The brake fluid level is low, check the brake system immediately. See Checking the Brake Fluid (page 194).
Check Brake System	Have the system checked before continuing on your journey.

BRAKES – FREQUENTLY ASKED QUESTIONS

Is it normal for my brakes to make noise?

Occasional brake noise is normal. If a metal-to-metal, continuous grinding, or continuous squeal sound is present, the brake lining could be worn-out. Have the system checked by an authorized dealer.

There is an electrical motor sound when I press on the brake pedal or activate the park brake switch. Is this normal?

Yes, those sounds are the electronic brake booster or the electronic park brake operating.

Note: *Brake dust could accumulate on the wheels, even under normal driving conditions. Some dust is inevitable as the brakes wear and does not contribute to brake noise. See **Cleaning Wheels** (page 361).*

Electric Parking Brake

WHAT IS THE ELECTRIC PARKING BRAKE

The electric parking brake is used to hold your vehicle on slopes and flat roads.

APPLYING THE ELECTRIC PARKING BRAKE



WARNING: Always fully apply the parking brake and make sure you shift into park (P). Failure to follow this instruction could result in personal injury or death.



WARNING: If you drive extended distances with the parking brake applied, you could cause damage to the brake system.



The switch is on the lower part of the instrument panel.

1. Pull the switch up.

The red warning lamp flashes during operation and illuminates when the parking brake is applied.

Note: You can apply the electric parking brake when the ignition is off.

Note: The electric parking brake could apply when you shift into park (P). See **Park (P)** (page 178).

APPLYING THE ELECTRIC PARKING BRAKE IN AN EMERGENCY

You can use the electric parking brake to slow or stop your vehicle in an emergency.

1. Pull the switch up and hold it.

The electric parking brake continues to slow your vehicle down unless you release the switch.

The red warning lamp illuminates, a tone sounds and the stoplamps turn on when you use the electric parking brake in an emergency.

Note: Do not apply the electric parking brake when your vehicle is moving, except in an emergency.

MANUALLY RELEASING THE ELECTRIC PARKING BRAKE

1. Switch the ignition on.
2. Press and hold the brake pedal.
3. Push the switch down.

The red warning lamp turns off.

Pulling Away on a Hill When Towing a Trailer

1. Press and hold the brake pedal.
2. Pull the switch upward and hold it.
3. Shift into gear.
4. Press the accelerator pedal until engine has developed sufficient torque to prevent your vehicle from rolling down the hill.
5. Release the switch and pull away in a normal manner.

AUTOMATICALLY RELEASING THE ELECTRIC PARKING BRAKE

1. Close the driver door.
2. Shift into gear.
3. Press the accelerator pedal and pull away in a normal manner.

Electric Parking Brake

ELECTRIC PARKING BRAKE AUDIBLE WARNING

Sounds when the parking brake is on and your vehicle is moving. If the warning tone continues after you have released the parking brake, this indicates a malfunction. Have your vehicle checked as soon as possible.

RELEASING THE ELECTRIC PARKING BRAKE IF THE VEHICLE BATTERY HAS RUN OUT OF CHARGE



WARNING: The electric parking brake does not operate if the vehicle battery has run out of charge.

Connect a booster battery to the vehicle battery to release the electric parking brake if the vehicle battery has run out of charge. See **Jump Starting the Vehicle** (page 301).

ELECTRIC PARKING BRAKE – TROUBLESHOOTING

ELECTRIC PARKING BRAKE – WARNING LAMPS

Brake System



It illuminates red when you apply the parking brake and your vehicle is on. If the lamp flashes when the parking brake has been released, this indicates the parking brake system requires service. Have your vehicle checked as soon as possible.



Note: Lamps may vary depending on region.

Electric Parking Brake



When the lamp illuminates yellow, it indicates a malfunction in the electric parking brake. Have your vehicle checked as soon as possible.

Electric Parking Brake

ELECTRIC PARKING BRAKE – INFORMATION MESSAGES

Park Brake

Message	Details
To Release: Press Brake and Switch	The electric parking brake is set and you attempted a manual release without pressing the brake.
Park Brake Use Switch to Release	With the electric parking brake set, you attempted an automatic release with no success. Perform a manual release.
Release Park Brake	The electric park brake is set and your vehicle speed exceeds 3 mph (5 km/h). Release park brake before continued driving.
Park Brake Not Applied	The electric park brake is not fully applied.
Park Brake Not Released	The electric park brake is not fully released.
Park Brake Maintenance Mode	The electric park brake system has been put into a special mode that is used to allow service of the rear brakes. Contact an authorized dealer.
Park Brake Limited Function Service Required	The electric park brake system has detected a condition that requires service. Some functionality may still be available. Contact an authorized dealer.
Park Brake Malfunction Service Now	The electric park brake system has detected a condition that requires service. Contact an authorized dealer.

Hill Start Assist

WHAT IS HILL START ASSIST

Hill Start Assist makes it easier for you to pull away when your vehicle is on a slope without using the parking brake.

HOW DOES HILL START ASSIST WORK

When the system activates, your vehicle remains stationary for a few seconds after you release the brake pedal. This gives you time to move your foot from the brake pedal to the accelerator pedal. The brakes release when the engine has developed sufficient torque to prevent your vehicle from rolling down the slope.

The system activates when your vehicle is in any forward gear and facing uphill, or when your vehicle is in reverse (R) and facing downhill.

HILL START ASSIST PRECAUTIONS



WARNING: The system does not replace the parking brake. When you leave your vehicle, always apply the parking brake.



WARNING: You must remain in your vehicle when the system turns on. At all times, you are responsible for controlling your vehicle, supervising the system and intervening, if required. Failure to take care may result in the loss of control of your vehicle, serious personal injury or death.



WARNING: The system turns off if there is a malfunction or if you excessively rev the engine.

SWITCHING HILL START ASSIST ON AND OFF - MANUAL TRANSMISSION

You can switch hill start assist on and off on the touchscreen:

1. Press **Features** on the touchscreen.
2. Press **Driver Assistance**.
3. Switch **Hill Start Assist** on or off.

Note: *The system remembers the last setting when you start your vehicle.*

SWITCHING HILL START ASSIST ON AND OFF - AUTOMATIC TRANSMISSION

Hill start assist is active when you switch the ignition on. You cannot switch the system on or off.

HILL START ASSIST – TROUBLESHOOTING

HILL START ASSIST – INFORMATION MESSAGES

Message	Action
Hill Start Assist Not Available	Displays when system is not available. Have your vehicle checked as soon as possible.

Traction Control

WHAT IS TRACTION CONTROL

The traction control system helps to avoid drive wheel spin and loss of traction.

HOW DOES TRACTION CONTROL WORK

If your vehicle begins to slide, the system applies the brakes to individual wheels and, when needed, reduces engine power at the same time. If the wheels spin when accelerating on slippery or loose surfaces, the system reduces engine power in order to increase traction.

SWITCHING TRACTION CONTROL ON AND OFF

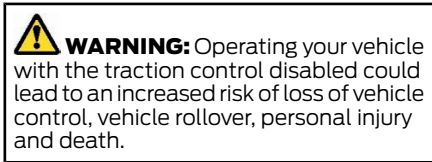

The system turns on each time you switch the ignition on.

If your vehicle is stuck in mud or snow, switching traction control off may be beneficial as this allows the wheels to spin.

Switching the System Off



The switch for the stability and traction control system is on the instrument panel.

When you switch the system off, a message and an illuminated icon appear on the instrument cluster.

Use the switch again to return the traction control system to normal operation.

Note: When you switch traction control off, stability control remains fully active.

Note: When you place your vehicle into four-wheel drive low, the traction control disables. Traction control resumes when you put your vehicle back into two-wheel drive or four-wheel drive high.

Note: For additional information on the traction and stability control systems. See **Stability Control** (page 204).

TRACTION CONTROL INDICATOR

Stability and Traction Control Indicator



If the indicator does not illuminate when you switch the ignition on, or remains on when the engine is running, this indicates a malfunction. Have your vehicle checked by an authorized dealer as soon as possible.



The traction control off indicator illuminates when you switch the traction control system off, or when an alternative stability control mode is selected that requires the traction control off depending on the drive mode selected.

Traction Control

TRACTION CONTROL – TROUBLESHOOTING

TRACTION CONTROL – INFORMATION MESSAGES

Message	Action
Traction Control Off	The status of the traction control system after you switched it off.
Traction Control On	The status of the traction control system after you switched it on.

Stability Control

HOW DOES STABILITY CONTROL WORK



WARNING: Vehicle modifications involving braking system, aftermarket roof racks, suspension, steering system, tire construction and wheel and tire size may change the handling characteristics of your vehicle and may adversely affect the performance of the electronic stability control system. In addition, installing any stereo speakers may interfere with and adversely affect the electronic stability control system. Reducing the effectiveness of the electronic stability control system could lead to an increased risk of loss of vehicle control, vehicle rollover, personal injury and death.



WARNING: Remember that even advanced technology cannot defy the laws of physics. It's always possible to lose control of a vehicle due to inappropriate driver input for the conditions. Aggressive driving on any road condition can cause you to lose control of your vehicle increasing the risk of personal injury or property damage. Activation of the electronic stability control system is an indication that at least some of the tires have exceeded their ability to grip the road; this could reduce the operator's ability to control the vehicle potentially resulting in a loss of vehicle control, vehicle rollover, personal injury and death.



WARNING: You are responsible for controlling your vehicle at all times. The system is designed to be an aid and does not relieve you of your responsibility to drive with due care and attention. Failure to follow this instruction could result in the loss of control of your vehicle, personal injury or death.

If a driving condition activates either the stability control or traction control you may experience the following conditions:

- The stability and traction control light flashes.
- Your vehicle slows down.
- Reduced engine power.

The stability control system has several features built into it to help you maintain control of your vehicle:

Electronic Stability Control

Electronic stability control enhances your vehicle's ability to prevent skids or lateral slides by applying brakes to one or more of the wheels individually and, if necessary, reducing engine power.

Roll Stability Control

Roll stability control enhances your vehicle's ability to prevent rollovers by detecting your vehicle's roll motion and the rate at which it changes by applying the brakes to one or more wheels individually.

Curve Control

Curve control enhances your vehicle's ability to follow the road when cornering severely or avoiding objects in the roadway. Curve control operates by reducing engine power and, if necessary, applying brakes to one or more of the wheels individually.

Stability Control

Side Wind Stabilization

Side wind stabilization is an advanced feature that works by carefully applying the brakes on one side of the vehicle to reduce the effect of a side wind gust on the vehicle's path.

Torque Vectoring by Brakes

Torque vectoring control applies brake torque on the inner driven wheel in a curve for better traction to avoid an understeer, or oversteer situation. Unlike electronic stability control, enhanced torque vectoring control does not slow the vehicle. It helps control excessive wheel slip and gives the vehicle improved cornering agility.

Traction Control

Traction control enhances your vehicle's ability to maintain traction of the wheels by detecting and controlling wheel spin. See **What Is Traction Control** (page 202).

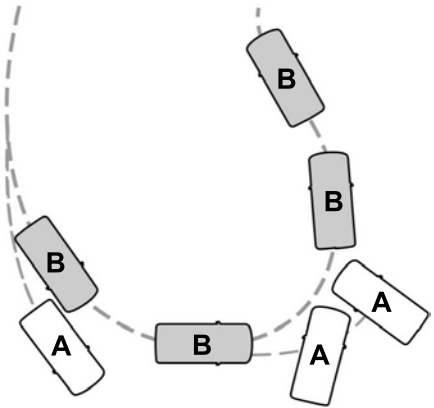

- A Vehicle without stability control skidding off its intended route.
- B Vehicle with stability control maintaining control on a slippery surface.

SWITCHING STABILITY CONTROL ON AND OFF

The system turns on each time you switch the ignition on.

The electronic stability control system is disabled when the transmission selector is in reverse (R).

You can switch the traction control independently. See **Switching Traction Control On and Off** (page 202).

Note: When you place your vehicle into four-wheel drive low, the stability control disables. Stability control resumes when you put your vehicle back into two-wheel drive or four-wheel drive high.

Stability Control

ESC Features				
Button Functions	Mode	Stability Control Off Light	Electronic Stability Control	Traction Control Systems
Default at start-up	Default - Traction Control On and Normal Advancetrac	On during bulb check	Enabled	Enabled
Button momentarily pressed - single press	Traction Control Off	On	Enabled	Disabled
Button pressed and held for five seconds	AdvanceTrac Off	On	Disabled	Disabled
Button pressed when Traction Control Off or Advance Trac Off	Return to Default	Off	Enabled	Enabled

Note: Do not use the AdvanceTrac Off setting on public roadways.

If a fault occurs in either the stability control or the traction control system, you may experience the following conditions:

- The stability and traction control light illuminates steadily.
- The stability control and traction control systems do not enhance your vehicle's ability to maintain traction of the wheels.

If a driving condition activates either the stability control or the traction control system you may experience the following conditions

- The stability and traction control light flashes.
- Your vehicle slows down.
- Reduced engine power.
- A vibration in the brake pedal.

- The brake pedal is stiffer than usual.
- If the driving condition is severe and your foot is not on the brake, the brake pedal may move as the system applies higher brake force.

STABILITY CONTROL INDICATOR



If it does not illuminate when you switch the power on, or remains on, this indicates a malfunction. Have your vehicle checked by an authorized dealer as soon as possible.

Trail Control (If Equipped)

WHAT IS TRAIL CONTROL



WARNING: The system does not control speed in low traction conditions or extremely steep slopes. The system is designed to be an aid and does not relieve you of your responsibility to drive with due care and attention. Failure to follow this instruction could result in personal injury.

Trail control lets you focus on steering during low-speed and off-road use by controlling your vehicle's acceleration and braking to maintain the speed that you set.

You may hear a noise from the anti-lock brake system pump motor when you use the system. This is normal.

TRAIL CONTROL LIMITATIONS

Trail control is unavailable when any of the following occur:

- Your vehicle speed is greater than 20 mph (32 km/h) in two-wheel drive high or four-wheel drive high modes.
- Your vehicle speed is greater than 9 mph (15 km/h) in four-wheel drive low mode.
- Your vehicle speed is greater than 3 mph (5 km/h) in reverse (R).
- The transmission is in park (P).
- The driver side door is open or your seatbelt is off when the driver side door is removed.
- Cruise control is on.
- Pro trailer backup assist is on.

SWITCHING TRAIL CONTROL ON AND OFF

Press the button on the center console.



Note: If your vehicle is equipped with trail one pedal drive, this will activate trail one pedal drive if you are in four wheel drive high or four wheel drive low mode, until you set a speed for trail control.

The system switches off if you press the button again or exceed 40 mph (64 km/h).

SETTING THE TRAIL CONTROL SPEED

Note: The buttons are on the steering wheel.

Drive to the speed you prefer.

SET+

Press the button to set or increase the set speed. Press and hold to adjust the speed in larger increments.

SET-

Press the button to set or decrease the set speed. Press and hold to adjust the speed in larger increments.

Note: The indicator changes color.

Trail Control (If Equipped)

You can also adjust the set speed by braking, then pressing the + or - button.

Note: Pressing the brake pedal does not switch off the system.

CANCELING THE SET SPEED

CAN

Press the button on the steering wheel to cancel the set speed.

Note: If your vehicle has trail one pedal drive and you are in four-wheel drive high (4H) or four-wheel drive low (4L) mode, cancelling the set speed activates this feature.

TRAIL CONTROL INDICATORS



TRAIL ONE PEDAL DRIVE (IF EQUIPPED)

WHAT IS TRAIL ONE PEDAL DRIVE

Trail one pedal drive allows you to accelerate and brake using only the accelerator pedal. The system assists when driving through difficult off-road terrain. Pressing the accelerator pedal down accelerates your vehicle and releasing pressure on the accelerator pedal, with your foot still on the pedal, slows your vehicle down. Releasing the accelerator pedal may allow your vehicle to come to a complete stop, some situations may require you to press the brake pedal to come to a complete stop.

TRAIL ONE PEDAL DRIVE PRECAUTIONS



WARNING: This system is an extra driving aid. It does not replace your attention and judgment, or the need to apply the brakes. This system does NOT automatically brake your vehicle. If you fail to press the brake pedal when necessary, you may collide with another vehicle.

Shifting into drive (D) or reverse (R) does not cause the vehicle to move.

You can press the brake pedal to increase braking. This does not turn the system off.

Trail one pedal drive could apply the parking brake when your vehicle is not moving and not in park (P).

Note: Always check the transmission selection before accelerating.

Note: Only use trail one pedal drive on slippery or loose surfaces. Using trail one pedal drive on dry, hard surfaces could produce some vibration, driveline bind up and potential excessive tire and vehicle wear.

TRAIL ONE PEDAL DRIVE LIMITATIONS

Trail one pedal drive is unavailable when any of the following occur:

- Your vehicle is not in four-wheel drive high or four-wheel drive low modes.
- Using cruise control.
- Using trail control.
- You exceed 30 mph (48 km/h).

Releasing the accelerator pedal may allow your vehicle to come to a complete stop, some situations may require you to press the brake pedal to come to a complete stop.

Trail Control (If Equipped)

SWITCHING TRAIL ONE PEDAL DRIVE ON AND OFF



Switching Trail One Pedal Drive On

Press the trail features button when in four-wheel drive high or four-wheel drive low to activate trail one pedal drive.

Switching Trail One Pedal Drive Off

Press the trail features button again to switch trail one pedal drive off.

Selecting a driveline mode other than four-wheel drive high or four-wheel drive low switches trail one pedal drive off.

If you exceed 42 mph (68 km/h) trail one pedal drive switches off.

SET+

Pressing either button when trail one pedal drive is active turns trail control on and places trail one pedal drive into standby mode.

SET-

Switching from Trail Control to Trail One Pedal Drive

CAN

When using trail control in four-wheel drive high or four-wheel drive low modes, you can switch to trail one pedal drive by pressing the button on the steering wheel.

TRAIL ONE PEDAL DRIVE INDICATORS



When trail one pedal drive is active, the indicator displays green in the instrument cluster.

When the system is switched on but is unavailable or in standby mode, it displays grey.

Trail Control (If Equipped)

TRAIL ONE PEDAL DRIVE – TROUBLESHOOTING (IF EQUIPPED)

TRAIL ONE PEDAL DRIVE – INFORMATION MESSAGES

Message	Action
Trail 1-Pedal Drive Active Use SET Button for Trail Control	Displays when trail one pedal drive is active, use the SET+ or SET- to switch to trail control.
Trail Control with Trail 1- Pedal Drive Off	Displays when you switch trail one pedal drive off.
Trail Control Enabled Use SET button to Set Speed Trail 1-Pedal Drive Available in 4H or 4L	Trail control is in two-wheel drive high or four-wheel drive auto. Set a speed to activate trail control or change the driveline state to four-wheel drive high or four-wheel drive low modes to active trail one pedal drive.

Trail Control (If Equipped)

TRAIL CONTROL – TROUBLESHOOTING

TRAIL CONTROL – INFORMATION MESSAGES

Message	Details
Reduce Speed To Enter Trail Control	Displays when you must reduce your vehicle speed to use trail control.
Trail Control Not Available with Park Brake Applied	Displays when you must release the park brake to use trail control.
Trail Control Not Available While Pro Trailer Backup Assist™ Active	Displays when you must switch off the trailer backup assist to use trail control.
Trail Control Enabled Use SET Button to Set Speed	Displays when you successfully enabled trail control and can set a speed with the Set+ or Set- control.
Trail Control Off Driver Resume Control	Displays when a system fault has occurred when trail control was active and the driver must resume control.
Trail Control Off	Displays when the system has turned off.
Trail Control Fault See Manual	Displays when a system fault is present. See the trail control section in your Owner's Manual. See your authorized dealer for diagnosis.
Trail Control To Activate Select Gear	Displays when you must be in drive (D), neutral (N) or reverse (R) to use trail control.
Trail Control Not Available with Cruise Control Active	Displays when you must switch the cruise control off to use trail control.
Trail Control Not Available with Driver Door Open	Displays when you must close the driver door to use trail control.
Set Trail Control to 1 MPH to Aid in Getting Unstuck in Sand	Displays when the system detects you may be stuck in sand and recommends using trail control on to the lowest set speed. Doing this could slowly pull sand under the tires to free the vehicle.
Set Trail Control to 2 km/h to Aid in Getting Unstuck in Sand	
Descent Control Now Active Press Trail Control Switch To Exit	Due to some driver action, Trail Control propulsion was turned off but the vehicle will still brake if descending a hill. The driver must press the Trail Control switch to turn the feature OFF, they can then turn it back on.
Trail Control Not Available with Seatbelt Off	Displays when you must have the seatbelt on to use trail control.

Trail Turn Assist (If Equipped)

WHAT IS TRAIL TURN ASSIST

Trail turn assist can reduce the turning radius of your vehicle by applying the brakes to the inside rear wheel in low-speed, high steering-angle maneuvers.

TRAIL TURN ASSIST PRECAUTIONS

Note: Do not use trail turn assist on dry, hard surfaced roads. Doing so can produce excessive noise, increase tire wear and may damage drive line, or braking components. Trail turn assist is only intended for slippery, or loose surfaces.

You may hear noise from the anti-lock brake system while trail turn assist is active. This is normal operation.

TRAIL TURN ASSIST LIMITATIONS

You can only use trail turn assist when the system is in four-wheel drive high (4H), or four-wheel drive low (4L) mode.

You cannot use trail turn assist with the rear differential engaged. If the system detects that the rear differential has recently been engaged, it may not activate trail turn assist until it can confirm that the rear differential is disengaged.

If the vehicle's rear differential is engaged when pressing the trail turn assist button, the rear differential will attempt to disengage to allow for trail turn assist operation.

SWITCHING TRAIL TURN ASSIST ON AND OFF

While in four-wheel drive high or four-wheel drive low, press the trail turn assist button to turn the feature on. trail turn assist will be on at this time but will not activate until:

- Vehicle speed is less than 12 mph (19.3 km/h).
- Rear differential is fully unlocked.
- Steering wheel is almost fully turned to the left or right.

You can turn off trail turn assist by doing any of the following:

- Pressing the trail turn assist button again.
- Selecting a two-wheel drive high, or four-wheel drive auto.
- Turning on the rear locking differential.

TRAIL TURN ASSIST INDICATORS



When trail turn assist is on, one of these two indicators will be displayed, depending on the direction of the vehicle's last turn. When the feature is on but not in use, the indicator light will be grey. When the feature is active the indicator light will be green.

Trail Turn Assist (If Equipped)

TRAIL TURN ASSIST – TROUBLESHOOTING

TRAIL TURN ASSIST – INFORMATION MESSAGES

Message	Details
Trail Turn Assist Available in 4L or 4H	Switch to four-wheel drive low or four-wheel drive high to activate trail turn assist. See Selecting a Four-Wheel Drive Mode (page 185).
Trail Turn Assist Not Available See Manual	Trail turn assist system malfunction could be present. If this condition persists, have your vehicle serviced.
Trail Turn Assist ON	You have activated trail turn assist.
Trail Turn Assist OFF	You have switched trail turn assist off.

TRAIL TURN ASSIST – FREQUENTLY ASKED QUESTIONS

Why does Trail Turn Assist not activate after unlocking the rear differential?

The rear differential may not be fully disengaged. When possible, turn off the rear axle locker while driving straight before using trail turn assist. If you are already in a tight turn when you encounter this situation, driving the vehicle for a short distance in reverse could allow the differential to fully disengage.

Stabilizer Bar Disconnect (If Equipped)

WHAT IS THE STABILIZER BAR DISCONNECT

Stabilizer bar disconnect is a feature that allows the front stabilizer bar to be disconnected for off-road use. This allows for increased front wheel articulation to improve capability and comfort on off-road terrain.

STABILIZER BAR DISCONNECT PRECAUTIONS



WARNING: If the stabilizer bar disconnect warning lamp illuminates red, a fault could be detected and the stabilizer bar could not be connected. Do not drive your vehicle above 20 mph (32 km/h) and have the system checked as soon as possible. Driving your vehicle above 20 mph (32 km/h) could reduce vehicle stability.



WARNING: Do not get under a vehicle that is switched on as the stabilizer bar disconnect could activate and the vehicle could unexpectedly drop. Failure to follow this instruction could result in personal injury or death.

If an amber warning message appears in the cluster indicating that the system requires service, the stabilizer bar disconnect will not be available. Have your vehicle checked by an authorized dealer as soon as possible.

SWITCHING THE STABILIZER BAR DISCONNECT ON AND OFF

Switching the Stabilizer Bar Disconnect On



Switch the system on by pressing the button on the instrument panel. The stabilizer bar disconnects when the vehicle's speed is below 20 mph (32 km/h). An amber indicator illuminates to show that the stabilizer bar disconnects.

When the vehicle speed exceeds 20 mph (32 km/h), the stabilizer bar reconnects and a grey indicator illuminates, indicating the system is in standby mode. The stabilizer bar disconnects again once the vehicle speed is below 20 mph (32 km/h).

If the vehicle speed is above 20 mph (32 km/h) and the system is on, the request is stored and a grey indicator illuminates to indicate that the system is in standby mode. When the vehicle speed falls below 20 mph (32 km/h), the stabilizer bar disconnects and the amber indicator illuminates, indicating that the stabilizer bar has disconnected.

Note: *The grey indicator stays on until either the vehicle speed reduces and the stabilizer bar disconnects or, the system turns off.*

The stabilizer bar system also turns on and disconnects when you select the Rock Crawl drive mode. See **Selecting a G.O.A.T. Mode** (page 242).

Note: *The stabilizer bar disconnect is not available in certain drive modes. See **Selecting a G.O.A.T. Mode** (page 242).*

Note: *The stabilizer bar disconnect could be delayed during wheel slippage, dynamic maneuvers, dynamic cornering, or when there is an anti-lock brake system or electronic stability control event in progress.*

Stabilizer Bar Disconnect (If Equipped)

Switching the Stabilizer Bar Disconnect Off

Switch the system off by pressing the stabilizer bar disconnect button, which reconnects the stabilizer bar if currently disconnected.

The stabilizer bar disconnect system also turns off when:

- The engine is switched off.
- You switch out of four-wheel drive low or four-wheel drive high.
- You select a drive mode that does not allow the stabilizer bar to disconnect.

Note: *The stabilizer bar can be reconnected at any time, it is not necessary for the vehicle to be on a level surface as the stabilizer bar self-aligns.*

STABILIZER BAR DISCONNECT INDICATORS



An indicator illuminates when you switch the stabilizer bar disconnect system on. The color of the indicator changes to indicate the system status.

Amber indicates that the stabilizer bar is disconnected.

Grey indicates that the stabilizer bar is connected and in standby.

Red indicates that there is a fault with the system, have the system checked as soon as possible.

STABILIZER BAR DISCONNECT – TROUBLESHOOTING

STABILIZER BAR DISCONNECT – INFORMATION MESSAGES

Message	Action
Sta-Bar Disconnect Not Available In Selected Drive Mode	The selected drive mode does not allow you to turn on the stabilizer bar disconnect feature. See G.O.A.T. Mode Control (page 242).
Sta-Bar Disconnected Sta-Bar Reconnects over 20 MPH	The stabilizer bar has been disconnected.
Sta-Bar Disconnected Sta-Bar Reconnects over 32 km/h	
Sta-Bar Disconnect Available Below 20 MPH	The stabilizer bar disconnect is available below 20 mph (32 km/h).
Sta-Bar Disconnect Available Below 32 km/h	
Sta-Bar Disconnect Available in 4L or 4H	The selected 4WD mode does not allow you to turn on the stabilizer bar disconnect feature.

Stabilizer Bar Disconnect (If Equipped)

Message	Action
Sta-Bar Disconnect Not Available See Manual	Stabilizer bar disconnect is not available. See Stabilizer Bar Disconnect – Frequently Asked Questions (page 216).
Sta-Bar Disconnect Drive Below 32 km/h Service Now	Stabilizer bar disconnect fault detected, drive below 20 mph (32 km/h). Have your vehicle checked by an authorized dealer as soon as possible.
Sta-Bar Disconnect Drive Below 20 MPH Service Now	

Why is the stabilizer bar disconnect not disconnecting?

The vehicle's battery charge is low and needs to be changed or charged.

Why is the stabilizer bar disconnect not disconnecting?

There is a fault active in another system on the vehicle, have the system checked as soon as possible.

Why is the stabilizer bar disconnect not disconnecting?

The vehicle is in a drive mode that does not allow the stabilizer bar to disconnect and needs to be switched to a different drive mode.

STABILIZER BAR DISCONNECT – FREQUENTLY ASKED QUESTIONS

Why is the stabilizer bar disconnect not disconnecting?

The engine is turned off and needs to be turned on.

Why is the stabilizer bar disconnect not disconnecting?

The vehicle is not in four-wheel drive low or four-wheel drive high, and needs to be switched to either mode.

Why is the stabilizer bar disconnect not disconnecting?

Vehicle speed is above 20 mph (32 km/h) and needs to be reduced in order for the stabilizer bar to disconnect.

Why is the stabilizer bar disconnect not disconnecting?

The vehicle is on a very significant lateral incline, and needs to be moved to more level ground.

Hill Descent Control - Manual Transmission

WHAT IS HILL DESCENT CONTROL

Hill descent control allows the driver to set and maintain vehicle speed while descending steep slopes in various surface conditions.

HOW DOES HILL DESCENT CONTROL WORK

Hill descent control can maintain vehicle speeds on downhill slopes between 2–20 mph (3–32 km/h). Above 20 mph (32 km/h), the system remains on but the descent speed cannot be set or maintained.

Note: *The system does not function below 2 mph (3 km/h).*

The system requires a cool down interval after a period of sustained use. Hill descent control provides a warning in the message center and a tone sounds when the system is about to disengage for cooling. At this time, manually apply the brakes as needed to maintain descent speed.

Note: *The amount of time that the system can remain active before cooling varies with conditions.*

HILL DESCENT CONTROL PRECAUTIONS



WARNING: The system does not control speed in low traction conditions or extremely steep slopes. The system is designed to be an aid and does not relieve you of your responsibility to drive with due care and attention. Failure to follow this instruction could result in personal injury.



WARNING: The system does not replace the parking brake. When you leave your vehicle, always apply the parking brake.

SWITCHING HILL DESCENT CONTROL ON AND OFF



Press the button on the center console. A light in the instrument cluster illuminates when the system is active.

SETTING THE HILL DESCENT SPEED

To increase or decrease the descent speed, press the accelerator or brake pedal, or use the SET + and SET - buttons on the steering wheel. Once you reach the preferred speed remove your feet from the pedals.

HILL DESCENT CONTROL INDICATOR



Illuminates when you switch hill descent control on.

Hill Descent Control - Manual Transmission

HILL DESCENT CONTROL – TROUBLESHOOTING

HILL DESCENT CONTROL – INFORMATION MESSAGES

Message	Details
Hill Descent Control OFF	Displays when you deactivate hill descent control mode.
For Hill Descent Reduce Speed	Displays when the speed exceeds 20 mph (32 km/h) and hill descent control is unavailable.
Hill Descent Control Not Available With Cruise Control Active	Displays when Cruise Control is Active and driver attempts to turn on hill descent control.
Hill Descent Driver Resume Control	Displays when the hill descent control mode requires you to resume control.
Hill Descent Control Fault	Displays when a hill descent system fault is present.
Hill Descent Control Off System Cooling	Displays when the hill descent control turns off to cool the brake system.
Hill Descent Control Ready	Displays when you activate the hill descent control mode.

Steering

ELECTRIC POWER STEERING

HOW DOES ELECTRIC POWER STEERING WORK

The electric power steering system assists the brake system to help operate advanced stability control and accident avoidance systems.

If your vehicle loses electrical power or detects a concern when you are driving the system switches off and you retain normal steering function. Additionally, whenever the battery is disconnected or a new battery is installed, you must drive your vehicle a short distance before the system relearns the strategy and reactivates all systems.

ELECTRIC POWER STEERING PRECAUTIONS



WARNING: The electric power steering system has diagnostic checks that continuously monitor the system. If a fault is detected, a message displays in the information display. Stop your vehicle as soon as it is safe to do so.

Switch the vehicle off. After at least 10 seconds, switch the vehicle on and watch the information display for a steering system warning message. If a steering system warning message returns, have the system checked as soon as possible.



WARNING: If the system detects an error, you may not feel a difference in the steering, however a serious condition may exist. Have your vehicle checked as soon as possible. Failure to do so may result in loss of steering control.

Adapt your speed and driving behavior according to reduced steering assist.

Extreme continuous steering may increase the effort to steer. This occurs to prevent internal overheating and damage to the steering system. If this occurs, you will not lose the ability to steer your vehicle manually nor will it cause damage to the system. Normal steering and driving allows the system to cool down and steering assist returns to normal.

Note: *There is no fluid reservoir to check or fill.*

Steering

STEERING – TROUBLESHOOTING

STEERING – INFORMATION MESSAGES

Message	Action
Steering Fault Service Now	The power steering system has detected a condition that requires service. Have your vehicle checked as soon as possible.
Steering Loss Stop Safely	The power steering system is not working. Stop your vehicle in a safe place. Have your vehicle checked as soon as possible.
Steering Assist Fault Service Required	The power steering system has detected a condition that requires service. Have your vehicle checked as soon as possible.
Steering Lock Malfunction Service Now	The steering system has detected a condition that requires service. Have your vehicle checked as soon as possible.

Steering

STEERING—FREQUENTLY ASKED QUESTIONS

Why does it seem that the steering is wandering or pulling?

Check your vehicle for an improperly inflated or uneven tire, loose or worn suspension or steering components, or improper vehicle alignment.

The system is functioning properly and the components have been checked, why is the steering system continuing to pull or wander?

A high crown in the road or crosswinds could make the steering system feel like it is wandering or pulling.

Parking Aids (If Equipped)

PARKING AID PRECAUTIONS

 **WARNING:** To help avoid personal injury, always use caution when in reverse (R) and when using the sensing system.

 **WARNING:** The system may not detect objects with surfaces that absorb reflection. Always drive with due care and attention. Failure to take care may result in a crash.

 **WARNING:** Traffic control systems, fluorescent lamps, inclement weather, air brakes, external motors and fans may affect the correct operation of the sensing system. This may cause reduced performance or false alerts.

 **WARNING:** The system may not detect small or moving objects, particularly those close to the ground.

 **WARNING:** The parking aid system can only assist you to detect objects when your vehicle is moving at parking speeds. To help avoid personal injury you must take care when using the parking aid system.

 **WARNING:** The system may not function if the sensor is blocked.

 **WARNING:** In cold and severe weather conditions the system may not function. Rain, snow and spray can all limit sensor performance.

 **WARNING:** If damage occurs in the immediate area surrounding the sensor, have your vehicle checked as soon as possible.

Note: *If your vehicle sustains damage leaving the sensors misaligned, this will cause inaccurate measurements or false alerts.*

When you connect a trailer to your vehicle, the rear parking aid detects the trailer and provides an alert. Disable the parking aid when you connect a trailer to prevent the alert.

Note: *Certain add-on devices installed around the bumper or fascia may create false alerts, for example, large trailer hitches, bike or surfboard racks, license plate brackets, bumper covers or any other device that could block the normal detection zone of the parking aid system. Aftermarket spare tires or spare tire covers mounted to the rear tailgate could cause false alerts from the park aid system. Remove the add-on device to prevent false alerts.*

Note: *Keep the sensors free from snow, ice and large accumulations of dirt. If the sensors are covered, the system's accuracy can be affected.*

Do not clean the sensors with sharp objects.

Note: *When using a programmed MyKey you cannot switch this off. See MyKey™ (page 74).*

SWITCHING PARKING AID ON AND OFF



Press the parking aid button and use the menu to switch the system on and off.

You can also switch the system off using the pop-up message that appears when you are in reverse (R).

Parking Aids (If Equipped)

REAR PARKING AID

WHAT IS THE REAR PARKING AID

Rear parking sensors detect objects behind your vehicle when in reverse (R).

REAR PARKING AID LIMITATIONS

There is a decreased coverage area at the outer corners.

When using a programmed MyKey, you cannot switch the rear parking aid off.

The rear parking aid sensors are active when your vehicle is in reverse (R) and the vehicle speed is less than 5 mph (8 km/h).

The sensor coverage area is up to 71 in (180 cm) from the rear bumper.

The rear parking aid detects large objects when you shift into reverse (R) and any of the following occur:

- Your vehicle is moving backward at a low speed.
- Your vehicle is stationary but an object is approaching the rear of your vehicle at a low speed.
- Your vehicle is moving backward at a low speed and an object is moving towards your vehicle, for example another vehicle at a low speed.

LOCATING THE REAR PARKING AID SENSORS



The rear parking aid sensors are in the rear bumper.

REAR PARKING AID AUDIBLE WARNINGS

A warning tone sounds when your vehicle approaches an object. As your vehicle moves closer to an object, the rate of the tone increases. The warning tone continuously sounds when an object is 12 in (30 cm) or less from the rear bumper.

If your vehicle remains stationary for a few seconds, the audible warning turns off. If your vehicle moves backward the tone sounds again.

Note: When the parking aid system sounds a tone, the audio system could reduce the set volume.

FRONT PARKING AID

WHAT IS THE FRONT PARKING AID

Front parking sensors detect objects in front of your vehicle.

Parking Aids (If Equipped)

FRONT PARKING AID LIMITATIONS

The front parking aid sensors are active when your vehicle is in any position other than park (P) and the vehicle speed is less than 5 mph (8 km/h).

The sensor coverage area is up to 28 in (70 cm) from the bumper.

If your vehicle is in reverse (R), the front parking aid detects objects when your vehicle is moving at a low speed or an object is moving toward your vehicle and provides an audio warning, for example another vehicle at a low speed. Once your vehicle reaches a stop, the audio warning stops after a few seconds. Visual indication is always active in reverse (R).

If your vehicle is in any forward gear, the front parking aid provides audible warnings and visual indication when your vehicle is moving at a speed of 5 mph (8 km/h) or below and the system detects an object within the detection zone. Once your vehicle reaches a stop, the visual indication and audio warning stops after a few seconds.

If your vehicle is in neutral (N), the front and rear sensors provide visual indication only when your vehicle is moving below a speed of 5 mph (8 km/h) and obstacles are detected inside the detection areas. Once your vehicle stops, the visual indication and audio warning stops after a few seconds.

LOCATING THE FRONT PARKING AID SENSORS



The front parking aid sensors are in the front bumper.

FRONT PARKING AID AUDIBLE WARNINGS

A warning tone sounds when there is an object within 28 in (70 cm) from the front bumper. As your vehicle moves closer to an object, the rate of the tone increases.

The warning tone continuously sounds when an object is 12 in (30 cm) or less from the front bumper.

Note: *If the detected object is 12 in (30 cm) or less from your vehicle, visual indication remains on.*

Parking Aids (If Equipped)

PARKING AID INDICATORS

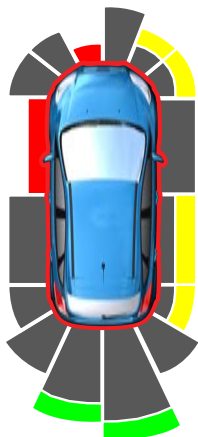

The system provides object distance indication through the information display.

- As the distance to the object decreases, the indicator blocks illuminate and move toward the vehicle icon.
- If there is no object detected, the distance indicator blocks are gray.

Visual indication remains on when the transmission is in reverse (R). When you stop your vehicle, visual indication turns off after four seconds.

If the system is not available, the side distance indicator blocks do not display.

PARKING AIDS – TROUBLESHOOTING

PARKING AIDS – INFORMATION MESSAGES

If a fault is present in the parking aids, a warning message appears in the instrument cluster or the information and entertainment display.

Message	Action
Check Front Park Aid	The system detects a condition that requires service. Have your vehicle checked as soon as possible.
Check Rear Park Aid	The system detects a condition that requires service. Have your vehicle checked as soon as possible.
Front Park Aid On Off	Displays the park aid status.
Rear Park Aid On Off	Displays the park aid status.

Rear View Camera

WHAT IS THE REAR VIEW CAMERA

The rear view camera provides a video image of the area behind your vehicle when the transmission is in reverse (R).

REAR VIEW CAMERA PRECAUTIONS



WARNING: The rear view camera system is a reverse aid supplement device that still requires the driver to use it in conjunction with the interior and exterior mirrors for maximum coverage.



WARNING: Objects that are close to either corner of the bumper or under the bumper, might not be seen on the screen due to the limited coverage of the camera system.



WARNING: Reverse your vehicle slowly. Failure to follow this instruction could result in the loss of control of your vehicle, personal injury or death.



WARNING: Use caution when the rear cargo door is ajar. If the rear cargo door is ajar, the camera will be out of position and the video image could be incorrect. All guide lines disappear when the rear cargo door is ajar. Failure to follow this instruction could result in personal injury.



WARNING: Use caution when turning camera features on or off when the transmission is not in park (P). Make sure your vehicle is not moving.

Note: When towing, the camera only sees what you are towing. This might not provide adequate coverage and you might not see some objects. In some vehicles, the guide lines may disappear when you connect the trailer tow connector.

LOCATING THE REAR VIEW CAMERA

The rear view camera is in the spare tire carrier.

REAR VIEW CAMERA GUIDE LINES

Note: Active guide lines and fixed guide lines are only available when the transmission is in reverse (R).

Note: The centerline is only available if the active or fixed guide lines are on.

Rear View Camera

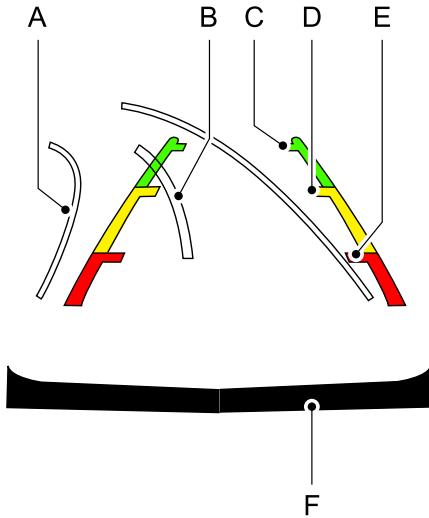

- A. Active guide lines.
- B. Centerline.
- C. Fixed guide line: Green zone.
- D. Fixed guide line: Yellow zone.
- E. Fixed guide line: Red zone.
- F. Rear bumper.

Active guide lines only show with fixed guide lines. To use active guide lines, turn the steering wheel to point the guide lines toward an intended path. If the steering wheel position changes while reversing, your vehicle might deviate from the intended path.

The fixed and active guide lines fade in and out depending on the steering wheel position. The active guide lines do not display when the steering wheel position is straight.

Use caution while reversing. Objects in the red zone are closest to your vehicle and objects in the green zone are farther away. Objects get closer to your vehicle as they move from the green zone to the yellow or red zones. Use the side view mirrors and rear view mirror to get better coverage on both sides and rear of your vehicle.

REAR VIEW CAMERA OBJECT DISTANCE INDICATORS

The system provides an image of your vehicle and the sensor zones. The zones highlight green, yellow, and red when the parking aid sensors detect an object in the coverage area.

REAR VIEW CAMERA SETTINGS

ZOOMING THE REAR VIEW CAMERA IN AND OUT

 **WARNING:** When manual zoom is on, the full area behind your vehicle may not show. Be aware of your surroundings when using the manual zoom feature.

Selectable settings for this feature are zoom in (+) and zoom out (-). Press the symbol on the camera screen to change the view. The default setting is zoom off.

This allows you to get a closer view of an object behind your vehicle. The zoomed image keeps the bumper in the image to provide a reference. The zoom is only active while the transmission is in reverse (R).

Note: Manual zoom is only available when the transmission is in reverse (R).

Note: Only the centerline shows when you enable manual zoom.

Rear View Camera

SWITCHING REAR VIEW CAMERA DELAY ON AND OFF

1. Press **Features** on the touchscreen.
2. Press **Driver Assistance**.
3. Press **Rear View Camera**.
4. Switch **Rear View Camera Delay** on or off.

When shifting the transmission out of reverse (R) and into any gear other than park (P), the camera image remains in the display until:

- Your vehicle speed reaches approximately 5 mph (8 km/h).
- You shift your vehicle into park (P).

360 Degree Camera (If Equipped)

WHAT IS THE 360 DEGREE CAMERA

The 360 degree camera system consists of front, side and rear cameras.

The 360 degree camera system:

- Allows you to see what is directly in front of or behind your vehicle.
- Provides a cross traffic view in front of and behind your vehicle.
- Allows you to see a top-down view of the area outside your vehicle, including the blind spots.

The system provides visibility around your vehicle to you in parking maneuvers such as:

- Centering in a parking space.
- Obstacles near your vehicle.
- Parallel parking.

HOW DOES THE 360 DEGREE CAMERA WORK

The 360 degree camera system:

- Allows you to see what is directly in front of or behind your vehicle.
- Helps you when parallel parking and centering in a parking space.
- Provides a cross traffic view in front of and behind your vehicle.
- Allows you to see a top-down view of the area outside your vehicle, including the blind spots and obstacles near your vehicle.

360 DEGREE CAMERA PRECAUTIONS



WARNING: The 360 degree camera system still requires the driver to use it in conjunction with looking out of the windows, and checking the interior and exterior mirrors for maximum coverage.



WARNING: Objects that are close to either corner of the bumper or under the bumper, might not be seen on the screen due to the limited coverage of the camera system.



WARNING: Use caution when turning camera features on or off when the transmission is not in park (P). Make sure your vehicle is not moving.



WARNING: You are responsible for controlling your vehicle at all times. The system is designed to be an aid and does not relieve you of your responsibility to drive with due care and attention. Failure to follow this instruction could result in the loss of control of your vehicle, personal injury or death.

360 DEGREE CAMERA LIMITATIONS

Note: Use caution if a door is ajar. The 360 degree camera could be out of position and the image could be incorrect.

360 Degree Camera (If Equipped)

LOCATING THE 360 DEGREE CAMERAS

Rear View Camera

The rear view camera is in the spare tire carrier. It provides an image of the area behind your vehicle.

Front View Camera

The front video camera is in the grille. It provides a video image of the area in front of your vehicle. To use the front camera system, place the transmission in any gear except reverse (R) and press the camera icon in the corner of the screen.

Note: The front camera system switches on when you are in mud/sand, rock crawl, or baja mode.

Side View Camera

The side view cameras are on the outside mirrors. They provide a video image of the area on the sides of your vehicle to aid you when parking.

360 DEGREE CAMERA GUIDE LINES

Note: Active guide lines are only available when the transmission is in reverse (R).

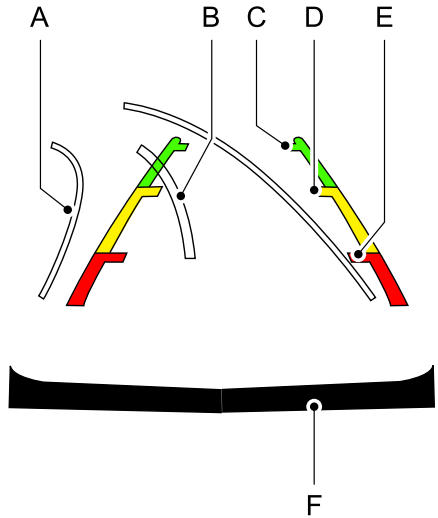

A	Active guide lines.
B	Centerline.
C	Fixed guide line: Green zone.
D	Fixed guide line: Yellow zone.
E	Fixed guide line: Red zone.
F	Rear bumper.

Active guide lines only show with fixed guide lines. Turn the steering wheel to point the guide lines toward an intended path. If the steering wheel position changes when reversing, your vehicle could deviate from the intended path.

360 Degree Camera (If Equipped)

The fixed and active guide lines fade in and out depending on the steering wheel position. The active guide lines do not display when the steering wheel position is straight.

Objects in the red zone are closest to your vehicle and objects in the green zone are farther away. Objects get closer to your vehicle as they move from the green zone to the yellow or red zones. Use the side view mirrors and rear view mirror to get better coverage on both sides and rear of your vehicle.

Keep Out Zone

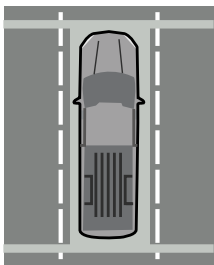

The Keep Out Zone is represented by the yellow dotted lines running parallel to your vehicle.

360 DEGREE CAMERA SETTINGS

SWITCHING THE 360 DEGREE CAMERA ON AND OFF



The 360 degree camera system button is on the instrument panel and allows you to toggle through different camera views. The front and rear cameras have multiple screens which consist of:

- Normal view.
- Normal view with 360.
- Split view.

Note: *The rear view camera activates when you switch into reverse (R). Additional views are then accessible on the touchscreen.*

When in park (P), neutral (N) or drive (D), only the front images display when you press the button. When in reverse (R), only the rear images display when you press the button.

Note: *The 360 degree camera system turns off when your vehicle is in motion at low speed, except when in reverse (R).*

SWITCHING THE 360 DEGREE CAMERA VIEW



Press to access the different camera views.



Normal + 360 view: Contains the normal camera view next to a 360 degree camera view.



Normal view: Provides an image of what is directly in front of or behind your vehicle.



Split view: Provides an extended view of what is in front of or behind your vehicle.



Zooms in on the image.

Cruise Control (If Equipped)

WHAT IS CRUISE CONTROL

Cruise control lets you maintain a set speed without keeping your foot on the accelerator pedal.

Requirements

Use cruise control when the vehicle speed is greater than 15 mph in imperial units and 20 km/h in metric units.

SWITCHING CRUISE CONTROL ON AND OFF



WARNING: Do not use cruise control on winding roads, in heavy traffic or when the road surface is slippery. This could result in loss of vehicle control, serious injury or death.

The cruise controls are on the steering wheel.

Switching Cruise Control On



Press the button to activate the system. When the system activates, the set speed is equal to whichever is greater, the current vehicle speed, or 15 mph when in imperial units or 20 km/h when in metric units. If the speed is too low, or other conditions are not correct for cruise control activation, the system will instead enter standby mode.

Switching Cruise Control Off



Press the button when the system is active or switch the ignition off.

Note: When you switch cruise control off, the set speed clears.

SETTING THE CRUISE CONTROL SPEED



WARNING: When you are going downhill, your vehicle speed could increase above the set speed. The system does not apply the brakes.

Drive to the speed you prefer.

SET+

Press either the Set+ or Set- buttons to set the current speed.

SET-

Take your foot off the accelerator pedal.

Note: The indicator changes color in the information display.

Changing the Set Speed

SET+

Press the Set+ button to increase the set speed in small increments. Press and hold the Set+ button to accelerate. Release the button when you have reached your preferred speed.

SET-

Press the Set- button to decrease the set speed in small increments. Press and hold the Set- button to decelerate. Release the button when you have reached your preferred speed.

Note: If you accelerate by pressing the accelerator pedal, the set speed does not change. When you release the accelerator pedal, your vehicle returns to the speed that you previously set.

Cruise Control (If Equipped)

CANCELING THE SET SPEED



Press the button, or tap the brake pedal to cancel the set speed.

Note: *The system remembers the set speed.*

Note: *The system cancels if the vehicle speed drops below 10 mph (16 km/h) under the set speed when driving uphill.*

RESUMING THE SET SPEED



Press the button.

CRUISE CONTROL INDICATORS



Illuminates when you switch the system on.

Adaptive Cruise Control (If Equipped)

HOW DOES ADAPTIVE CRUISE CONTROL WORK

Adaptive cruise control uses a radar sensor to adjust your vehicle speed to maintain a set gap between you and the vehicle in front of you in the same lane.

ADAPTIVE CRUISE CONTROL PRECAUTIONS

 **WARNING:** You are responsible for controlling your vehicle at all times. The system is designed to be an aid and does not relieve you of your responsibility to drive with due care and attention. Failure to follow this instruction could result in the loss of control of your vehicle, personal injury or death.

 **WARNING:** Pay close attention to changing road conditions such as entering or leaving a highway, on roads with intersections or roundabouts, roads without visible lanes of travel, roads that are winding, slippery, unpaved, or steep slopes.

 **WARNING:** The system does not control speed in low traction conditions or extremely steep slopes. The system is designed to be an aid and does not relieve you of your responsibility to drive with due care and attention. Failure to follow this instruction could result in personal injury.

 **WARNING:** The system is not a crash warning or avoidance system.

 **WARNING:** Do not use the system when towing a trailer that has aftermarket electronic trailer brake controls. Failure to follow this instruction could result in the loss of control of your vehicle, personal injury or death.

 **WARNING:** Do not use tire sizes other than those recommended because this can affect the normal operation of the system. Failure to do so may result in a loss of vehicle control, which could result in serious injury.

 **WARNING:** Do not use the system with a snow plow blade installed.

 **WARNING:** Do not use the system in poor visibility, for example fog, heavy rain, spray or snow.

When Following a Vehicle

 **WARNING:** When following a vehicle that is braking, your vehicle does not always decelerate quickly enough to avoid a crash without driver intervention. Apply the brakes when necessary. Failure to follow this instruction could result in personal injury or death.

Hilly Condition Usage

You should select a lower gear when the system is active in situations such as prolonged downhill driving on steep slopes, for example in mountainous areas. The system needs additional engine braking in these situations to reduce the load on the vehicle's regular brake system to prevent it from overheating.

Adaptive Cruise Control (if Equipped)

Note: An audible alarm sounds and the system shuts down if it applies brakes for an extended period of time. This allows the brakes to cool. The system functions normally again after the brakes cool.

ADAPTIVE CRUISE CONTROL LIMITATIONS

Sensor Limitations

WARNING: On rare occasions, detection issues can occur due to the road infrastructures, for example bridges, tunnels and safety barriers. In these cases, the system may brake late or unexpectedly. At all times, you are responsible for controlling your vehicle, supervising the system and intervening, if required.

WARNING: If the system malfunctions, have your vehicle checked as soon as possible.

WARNING: Large contrasts in outside lighting can limit sensor performance.

WARNING: The system only warns of vehicles detected by the radar sensor. In some cases there may be no warning or a delayed warning. Apply the brakes when necessary. Failure to follow this instruction could result in personal injury or death.

WARNING: The system may not detect stationary or slow moving vehicles below 6 mph (10 km/h).

WARNING: The system does not detect pedestrians or objects in the road.

WARNING: The system does not detect oncoming vehicles in the same lane.

WARNING: The system may not operate properly if the sensor is blocked. Keep the windshield free from obstruction.

WARNING: The sensor may incorrectly track lane markings as other structures or objects. This can result in a false or missed warning.



The camera is mounted on the windshield behind the interior mirror.

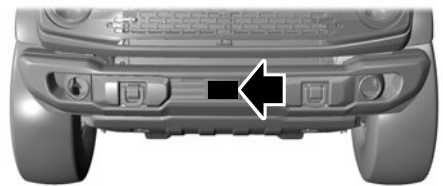

The radar sensor is in the lower grille.

Note: You cannot see the sensor. It is behind a fascia panel.

Adaptive Cruise Control (If Equipped)

Note: Keep the front of your vehicle free of dirt, metal badges or objects. Vehicle front protectors, aftermarket lights, additional paint or plastic coatings could also degrade sensor performance.

A message displays if something obstructs the camera or the sensor. When something blocks the sensor, the system cannot detect a vehicle ahead and does not function. See **Adaptive Cruise Control – Information Messages** (page 240).

The radar sensor has a limited field of view. It may not detect vehicles at all or detect a vehicle later than expected in some situations. The lead vehicle image does not illuminate if the system does not detect a vehicle in front of you.

Detection issues can occur:

A

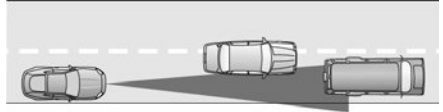

B



C

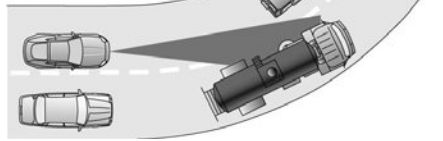

- A When driving on a different line than the vehicle in front.
- B With vehicles that edge into your lane. The system can only detect these vehicles once they move fully into your lane.
- C There may be issues with the detection of vehicles in front when driving into and coming out of a bend or curve in the road.

In these cases, the system may brake late or unexpectedly.

If something hits the front end of your vehicle or damage occurs, the radar-sensing zone could change. This could result in a missed or false vehicle detection.

Adaptive Cruise Control (If Equipped)

Optimal system performance requires a clear view of the road by the windshield-mounted camera.

Optimal performance may not occur if:

- The camera is blocked.
- There is poor visibility or lighting conditions.
- There are bad weather conditions.

SWITCHING ADAPTIVE CRUISE CONTROL ON AND OFF

The cruise controls are on the steering wheel. See **Cruise Control** (page 232).

Switching Adaptive Cruise Control On



Press the button to activate the system. When the system activates, the set speed is equal to the current vehicle speed. If the speed is too low, or other conditions are not correct for adaptive cruise control activation, the system enters standby mode.

Note: *The minimum set speed is 15 mph or 20 km/h.*

The indicator, current gap setting and set speed appear in the instrument cluster display.

Switching Adaptive Cruise Control Off



Press the button when the system is in standby mode or switch the ignition off.

Note: *When you switch the system off, the set speed clears.*

Automatic Cancellation or Deactivation

The system may cancel if:

- The tires lose traction.
- You apply the parking brake.
- Your vehicle speed falls significantly below 15 mph or 20 km/h.

The system may cancel and set the parking brake if:

- You unbuckle the seatbelt and open the driver door after you stop your vehicle.

The system may turn off or prevent activating when requested if:

- The vehicle has a blocked sensor.
- The brake temperature is too high.
- There is a failure in the system or a related system.

SETTING THE ADAPTIVE CRUISE CONTROL SPEED

Drive to the speed you prefer.



Press the toggle button upward or downward to set the current speed.



Take your foot off the accelerator pedal.

The indicator, current gap setting and set speed appear in the information display.



Adaptive Cruise Control (If Equipped)

A vehicle image illuminates if there is a vehicle detected in front of you.

Note: When adaptive cruise control is active, the speedometer may vary slightly from the set speed displayed in the information display.

Manually Changing the Set Speed

SET+

Press and release the toggle button upward to increase the set speed in small increments.

Press and hold the toggle button upward to increase the set speed in large increments. Release the button when you reach the speed you prefer.

SET-

Press and release the toggle button downward to decrease the set speed in small increments.

Press and hold the toggle button downward to decrease the set speed in large increments. Release the button when you reach the speed you prefer.

Press the accelerator or brake pedal until you reach the speed you prefer. Press the toggle button upward or downward to select the current speed as the set speed.

The system may apply the brakes to slow the vehicle to the new set speed. The set speed displays continuously in the information display when the system is active.

SETTING THE ADAPTIVE CRUISE CONTROL GAP

Note: A minimum vehicle speed of 15 mph or 20 km/h must be met, before you can set the gap.



Press the button to cycle through the four gap settings.



The selected gap appears in the instrument cluster display as shown by the bars in the image.

Note: The gap setting is time dependent and therefore, the distance adjusts with your vehicle speed.

Note: It is your responsibility to select a gap appropriate to the driving conditions.

Adaptive Cruise Control (If Equipped)

Adaptive Cruise Control Gap Settings

Graphic Display, Bars Indicated Between Vehicles	Gap Distance	Dynamic Behavior
1	Closest.	Sport.
2	Close.	Normal.
3	Medium.	Normal.
4	Far.	Comfort.

Each time you switch the system on, it selects the last chosen gap setting.

Following a Vehicle

When a vehicle ahead of you enters the same lane or a slower vehicle is ahead in the same lane, the vehicle speed adjusts to maintain the gap setting.

Note: *When you are following a vehicle and you switch on a turn signal lamp, adaptive cruise control may provide a small, temporary acceleration to help you pass.*

Your vehicle maintains a consistent gap from the vehicle ahead until:

- The vehicle in front of you accelerates to a speed above the set speed.
- The vehicle in front of you moves out of the lane you are in.
- You set a new gap distance.

The system applies the brakes to slow down your vehicle to maintain a safe gap distance from the vehicle in front of you. The system only applies limited braking. You can override the system by applying the brakes.

Note: *The brakes may emit noise when applied by the system.*

If the system determines that its maximum braking level is not sufficient, an audible warning sounds, a message appears in the instrument cluster display and an indicator flashes when the system continues to brake. Take immediate action.

CANCELING THE SET SPEED



Press the button or tap the brake pedal.

The set speed does not erase.

RESUMING THE SET SPEED



Press the button.

Your vehicle speed returns to the previously set speed and gap setting. The set speed displays continuously in the information display when the system is active.

Note: *Only use resume if you are aware of the set speed and intend to return to it.*

OVERRIDING THE SET SPEED

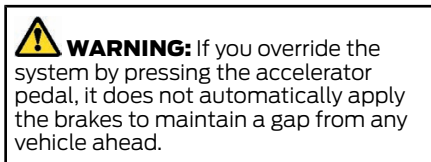

When you press the accelerator pedal, you override the set speed and gap distance.

Use the accelerator pedal to intentionally exceed the set speed limit.

Adaptive Cruise Control (If Equipped)

When you override the system, the green indicator illuminates and the vehicle icon does not appear in the instrument cluster display.

The system resumes operation when you release the accelerator pedal. The vehicle speed decreases to the set speed, or a lower speed if following a slower vehicle.

ADAPTIVE CRUISE CONTROL INDICATORS



Illuminates when you switch adaptive cruise control on. The color of the indicator changes to indicate the system status.

White indicates the system is on but inactive.

Green indicates that you set the speed and the system is active.

SWITCHING FROM ADAPTIVE CRUISE CONTROL TO CRUISE CONTROL



WARNING: Normal cruise control will not brake when your vehicle is approaching slower vehicles. Always be aware of which mode you have selected and apply the brakes when necessary.

Use the touchscreen to select the following:

1. Select **Settings**.
2. Select **Driver Assist..**
3. Select **Cruise Control**.
4. Select **Normal**.



The cruise control indicator replaces the adaptive cruise control indicator if you select normal cruise control. The gap setting does not display, and the system does not respond to lead vehicles. Automatic braking remains active to maintain set speed. The system remembers the last setting when you start your vehicle.

ADAPTIVE CRUISE CONTROL – TROUBLESHOOTING

ADAPTIVE CRUISE CONTROL – INFORMATION MESSAGES

Note: Depending on your vehicle options and instrument cluster type, not all messages display or are available.

Note: The system could abbreviate or shorten certain messages depending upon which cluster type you have.

Message	Action
Adaptive Cruise Malfunction	A malfunction is preventing the adaptive cruise from engaging.
Front Sensor Not Aligned	Contact an authorized dealer to have the radar checked for proper coverage and operation.
Adaptive Cruise Not Available	Conditions exist preventing the system from being available.

Adaptive Cruise Control (If Equipped)

Message	Action
Adaptive Cruise Not Available Sensor Blocked See Manual	You have a blocked radar because of poor radar visibility due to inclement weather or ice, mud, or water in front of the radar. You can typically clean the sensor to resolve this. Due to the nature of radar technology, it is possible to get a blockage warning with no actual block. This happens, for example, when driving in sparse rural or desert environments. A false blocked condition either self clears, or clears after you restart your vehicle.
Normal Cruise Active Adaptive Braking Off	You have selected normal cruise control. The system does not brake or react to traffic.
Adaptive Cruise - Driver Resume Control	Displays when the adaptive cruise control is going to cancel and you must take control.
Adaptive Cruise Speed Too Low to Activate	Displays when the vehicle speed is too slow to activate the adaptive cruise control and there is no lead vehicle in range.

G.O.A.T. Mode Control

WHAT IS G.O.A.T. MODE CONTROL

Your vehicle has several goes over any-type of terrain (G.O.A.T.) modes that you can select for different driving conditions. Depending on the mode that you select, the system adjusts various vehicle settings.

HOW DOES G.O.A.T. MODE CONTROL WORK

Each selectable mode changes various electronic and mechanical settings within your vehicle to tailor its performance and driving characteristics to on-road or off-road driving conditions. The system may alter steering feel and effort, traction control, stability control, chassis controls, powertrain response, transmission shift points, four-wheel driveline setting, exhaust noise level and suspension dampening to a pre-determined setting, depending upon the mode that you select.

Your vehicle reverts to normal mode each time it is started. If you switch your vehicle off in a drive mode other than normal mode at startup, the instrument cluster screen displays a pop-up asking if you would like to return to your last used mode. If you select yes to the pop-up, your vehicle returns to the last selected mode and the default four-wheel driveline setting associated with that mode. If you select no, your vehicle remains in normal mode and the default four-wheel driveline setting associated with that mode. If you do not select yes or no, the pop up message times out, your vehicle remains in normal mode, and the four-wheel driveline setting remains in its last used setting.

Note: Your vehicle has diagnostic checks that continuously monitor all systems for proper operation. If a mode is unavailable due to a system fault, your vehicle defaults to normal mode and the driveline remains in the four-wheel drive setting that you last selected prior to the system fault.

SELECTING A G.O.A.T. MODE



To select a mode, use the console mounted controller.

Note: Mode changes may not be available when the ignition is off or when the engine is not running.

Note: Button icons may vary.

G.O.A.T. Mode Control

Note: To optimize off-road driving performance, the system disables the brake over accelerator feature on off-road modes, including mud/ruts, sand, baja and rock crawl modes. A message displays in the instrument cluster when you select an off-road mode. See **G.O.A.T. Mode Control – Information Messages** (page 246). Brake over accelerator enables when an off-road mode is exited or during the next ignition key-cycle. Return to on-road modes, normal, eco, sport or slippery, when driving on regular roads. See **Brake Over Accelerator** (page 194).

G.O.A.T. MODES

BAJA



For high speed off-road driving. Baja mode optimizes the throttle control for better response and torque delivery.

Four-wheel drive high is the default four-wheel drive mode. Four-wheel drive auto is not selectable in baja mode.

The front electronic locking differential is available below 25 mph (40 km/h) when in four-wheel drive low. The rear electronic locking differential is available at any speed in all selectable four-wheel drive modes.

The stabilizer bar disconnect is available in four-wheel drive high or four-wheel drive low.

Note: Do not use this mode on dry, hard pavement. This could produce some vibration, driveline bind up, and potential excessive tire and vehicle wear depending on the four-wheel drive mode selection.

ECO



For efficient driving. This mode helps deliver maximum fuel efficiency and helps to increase driving range.

Two-wheel drive high is the default four-wheel drive mode. Four-wheel drive low is not selectable in eco mode.

The front electronic locking differential is not available in eco mode. The rear electronic locking differential is available below 25 mph (40 km/h).

The stabilizer bar disconnect is not available in eco mode.

MUD/RUTS



For off-road driving. This mode enhances vehicle performance to traverse muddy, rutted or uneven terrains.

Four-wheel drive high is the default four-wheel drive mode. Four-wheel drive low is selectable in mud/rut mode.

The front electronic locking differential is available below 25 mph (40 km/h) when in four-wheel drive low. The rear electronic locking differential is engaged when in mud/ruts mode and is available at any speed in all selectable four-wheel drive modes.

The stabilizer bar disconnect is available in four-wheel drive high or four-wheel drive low.

Note: Do not use this mode on dry, hard pavement. This could produce some vibration, driveline bind up, and potential excessive tire and vehicle wear depending on the four-wheel drive mode selection.

G.O.A.T. Mode Control

NORMAL



For everyday driving. This mode is the perfect balance of excitement, comfort and convenience. This is the default mode after each ignition cycle, the driveline settings remain the same prior to the ignition cycle.

Two-wheel drive high is the default four-wheel drive mode. All four-wheel drive modes are selectable when in normal mode.

The front electronic locking differential is available below 25 mph (40 km/h) when in four-wheel drive low. The rear electronic locking differential is available below 25 mph (40 km/h).

Note: *The rear electronic locking differential is available at any speed when in four-wheel drive low.*

The stabilizer bar disconnect is available in four-wheel drive high or four-wheel drive low.

ROCK CRAWL



For off-road driving and optimum rock-climbing ability. Rock crawl mode optimizes the throttle and transmission response to provide you additional control of your vehicle.

Four-wheel drive low is the only four-wheel drive mode selectable in rock crawl, the system prompts you to put your vehicle into four-wheel drive low upon selection.

The front electronic locking differential is available below 25 mph (40 km/h) when in four-wheel drive low. The rear electronic locking differential is engaged when in rock crawl mode and is available at any speed.

The stabilizer bar disconnects when in rock crawl mode.

Note: *Do not use this mode on dry, hard pavement. This could produce some vibration, driveline bind up, and potential excessive tire and vehicle wear depending on the four-wheel drive mode selection.*

SAND



For off-road driving on soft, dry sand or deep snow. This mode may help get your vehicle unstuck from deep snow or sand.

Four-wheel drive high is the default four-wheel drive mode. Four-wheel drive low is selectable in sand mode.

The front electronic locking differential is available below 25 mph (40 km/h) when in four-wheel drive low. The rear electronic locking differential is engaged when in sand mode and is available at any speed in all selectable four-wheel drive modes.

The stabilizer bar disconnect is available in four-wheel drive high or four-wheel drive low.

Note: *The front camera system switches on when you are in sand mode and your speed is less than 15 mph (24 km/h). If you exceed 15 mph (24 km/h), the camera shuts off until your vehicle speed is below 12 mph (20 km/h).*

Note: *Do not use this mode on dry, hard pavement. This could produce some vibration, driveline bind up, and potential excessive tire and vehicle wear depending on the four-wheel drive mode selection.*

Note: *Sand mode is not intended for use on firm, slippery surfaces, such as paved roads covered with snow or ice. For slippery, firm surfaces use slippery mode.*

G.O.A.T. Mode Control

SLIPPERY - 4X4 WITH PART TIME ENGAGEMENT



For less than ideal road conditions such as snow or ice covered roads. This mode can be used for crossing terrain where a firm surface is covered with loose, wet or slippery material. Slippery mode lowers throttle response and optimizes shifting for slippery surfaces.

Four-wheel drive high is the default four-wheel drive mode. All four-wheel drive modes are selectable in slippery mode.

The front electronic locking differential is available below 25 mph (40 km/h) when in four-wheel drive low. The rear electronic locking differential is available below 25 mph (40 km/h).

Note: *The rear electronic locking differential is available at any speed when in four-wheel drive low.*

The stabilizer bar disconnect is not available in slippery mode.

Note: *Do not use this mode on dry, hard pavement. This could produce some vibration, driveline bind up, and potential excessive tire and vehicle wear depending on the four-wheel drive mode selection.*

SLIPPERY - ADVANCED 4X4 WITH 4A MODE



For less than ideal road conditions such as snow or ice covered roads. This mode can be used for crossing terrain where a firm surface is covered with loose, wet or slippery material. Slippery mode lowers throttle response and optimizes shifting for slippery surfaces.

Four-wheel drive auto is the default four-wheel drive mode. Two-wheel drive high is not selectable in slippery mode.

The front electronic locking differential is available below 25 mph (40 km/h) when in four-wheel drive low. The rear electronic locking differential is available below 25 mph (40 km/h).

Note: *The rear electronic locking differential is available at any speed when in four-wheel drive low.*

The stabilizer bar disconnect is not available in slippery mode.

Note: *Do not use this mode on dry, hard pavement. This could produce some vibration, driveline bind up, and potential excessive tire and vehicle wear depending on the four-wheel drive mode selection.*

SPORT - 4X4 WITH PART TIME ENGAGEMENT



For sporty driving with improved performance handling and response. This mode increases accelerator pedal response and provides a sportier steering feel. The powertrain system holds onto lower gears longer, helping your vehicle accelerate faster.

Two-wheel drive high is the default four-wheel drive mode. Four-wheel drive low is not selectable in sport mode.

The front electronic locking differential is not available in sport mode. The rear electronic locking differential is available below 25 mph (40 km/h).

The stabilizer bar disconnect is not available in sport mode.

G.O.A.T. Mode Control

SPORT - ADVANCED 4X4 WITH 4A MODE



For sporty driving with improved performance handling and response. This mode increases accelerator pedal response and provides a sportier steering feel. The powertrain system holds onto lower gears longer, helping your vehicle accelerate faster.

Four-wheel drive auto is the default four-wheel drive mode. Four-wheel drive low is not selectable in sport mode.

The front electronic locking differential is not available in sport mode. The rear electronic locking differential is available below 25 mph (40 km/h).

The stabilizer bar disconnect is not available in sport mode.

G.O.A.T. MODE CONTROL – TROUBLESHOOTING

G.O.A.T. MODE CONTROL – WARNING LAMPS



Some drive modes reduce traction and stability control performance and the indicator illuminates in the instrument cluster.

G.O.A.T. MODE CONTROL – INFORMATION MESSAGES

Message	Details
Changing to Normal Drive Mode for Improved Towing Performance	Displays when the system switches to normal mode to support towing performance.
Drive Mode Not Available	Displays when you select a drive mode that is not available. Select a different drive mode.
Drive Mode Preconditions Not Met	Displays when you select a drive mode that is not available. Check the four-wheel drive mode, electronic locking differential and stabilizer bar before selecting a drive mode.
Drive Mode Selection Reduced due to System Fault	Displays when you select a drive mode that is not available. Have the system checked.
Off-Road Use Only	Displays when you select an off-road drive mode.

G.O.A.T. Mode Control

Message	Details
Selected 4x4 Mode Not Available in Current Drive Mode	Displays when you select a four-wheel drive mode that is not available in the current drive mode. Select an available four-wheel drive mode.
Selected Locking Differential Not Available in Current Drive Mode	Displays when you select an electronic locking differential that is not available in the current drive mode. Select an available electric locking differential.
Sta-Bar Disconnect Not Available In Selected Drive Mode	Displays when you attempt to disconnect the stabilizer bar in the current drive mode. Select a different drive mode to disconnect the stabilizer bar.

G.O.A.T. Mode Control

G.O.A.T. MODE CONTROL – FREQUENTLY ASKED QUESTIONS

Why did the system default to normal mode?

If a mode is unavailable due to a system fault, it defaults to normal mode and the driveline settings remain the same as prior to the system fault.

Lane Keeping System (If Equipped)

WHAT IS THE LANE KEEPING SYSTEM

The lane keeping system alerts you by providing temporary steering assistance or steering wheel vibration when it detects an unintended lane departure.

HOW DOES THE LANE KEEPING SYSTEM WORK

The lane keeping system uses a forward looking camera mounted on the windshield to monitor vehicle movement within the travel lane.

When the camera detects a drift out of the travel lane, the lane keeping system alerts the driver by vibrating the steering wheel, or aids the driver by providing a small steering input to move the vehicle back into the travel lane.

The driver can select one of three modes:

- Alert (If Equipped)
- Aid
- Alert + Aid

LANE KEEPING SYSTEM PRECAUTIONS

 **WARNING:** You are responsible for controlling your vehicle at all times. The system is designed to be an aid and does not relieve you of your responsibility to drive with due care and attention. Failure to follow this instruction could result in the loss of control of your vehicle, personal injury or death.

 **WARNING:** The system will not operate if the sensor cannot track the road lane markings.

 **WARNING:** The sensor may incorrectly track lane markings as other structures or objects. This can result in a false or missed warning.

 **WARNING:** In cold and severe weather conditions the system may not function. Rain, snow and spray can all limit sensor performance.

 **WARNING:** The system may not operate properly if the sensor is blocked. Keep the windshield free from obstruction.

 **WARNING:** If damage occurs in the immediate area surrounding the sensor, have your vehicle checked as soon as possible.

 **WARNING:** The system may not correctly operate if your vehicle is fitted with a suspension kit not approved by us.

 **WARNING:** Large contrasts in outside lighting can limit sensor performance.

LANE KEEPING SYSTEM LIMITATIONS

The lane keeping system only operates when the vehicle speed is greater than 40 mph (64 km/h).

The system works when the camera can detect at least one lane marking.

The lane keeping system may not correctly operate in any of the following conditions:

- The lane keeping system does not detect at least one lane marking.
- You switch the turn signal on.

Lane Keeping System (If Equipped)

- You apply direct steering, accelerate fast or brake hard.
- The vehicle speed is less than 40 mph (64 km/h).
- The anti-lock brake, stability control or traction control system activates.
- The lane is too narrow.
- Something is obscuring the camera or it is unable to detect the lane markings due to environment, traffic or vehicle conditions.

The lane keeping system may not correct lane positioning in any of the following conditions:

- High winds.
- Uneven road surfaces.
- Heavy or uneven loads.
- Incorrect tire pressure.

SWITCHING THE LANE KEEPING SYSTEM ON AND OFF



To activate the lane keeping system, press the button on the steering wheel.

To deactivate the lane keeping system, press the button again.

Note: When switching the system on or off a message appears in the information and entertainment display to show the status.

Note: The system stores the on or off setting until manually changed, unless it detects a MyKey™. If the system detects a MyKey™, it defaults to the last setting for that MyKey™.

Note: If the system detects a MyKey™, pressing the button does not affect the on or off status of the system. You can only change the mode and intensity settings.

SWITCHING THE LANE KEEPING SYSTEM MODE

The lane keeping system has different settings that you can view or adjust using the information display.

The system stores the last known selection for each of these settings. You do not need to readjust your settings each time you switch on the system.

To change the lane keeping system mode, use the touchscreen:

1. Select **Driver Assistance**.
2. Select **Lane Keeping System**.
3. Select **Mode**.
4. Select a setting.

Note: The system remembers the last setting when you start your vehicle. If the system detects a MyKey™, the mode is set to alert.

ALERT MODE

WHAT IS ALERT MODE

Alert mode vibrates the steering wheel when it detects an unintended lane departure.

Lane Keeping System (If Equipped)

HOW DOES ALERT MODE WORK

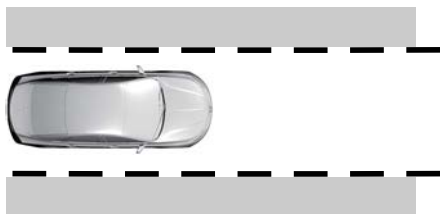

When in alert mode, the lane keeping system alerts you by vibrating the steering wheel. The intensity of the vibration is set through the lane keeping system menu.

ADJUSTING THE STEERING WHEEL VIBRATION INTENSITY

To change the steering wheel vibration intensity, use the touchscreen:

1. Select ***Driver Assistance***.
2. Select ***Lane Keeping System***.
3. Select ***Intensity***.
4. Select a setting.

AID MODE

WHAT IS AID MODE

Aid mode provides temporary steering assistance toward the center of the lane.

HOW DOES AID MODE WORK

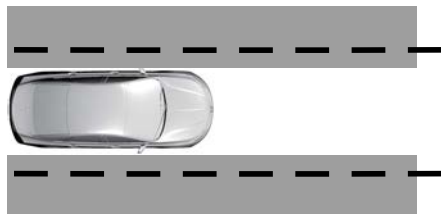

The lane keeping system aids you when an unintentional lane departure occurs. The system provides a small steering input to move the vehicle towards the center of the lane.

ALERT AND AID MODE

WHAT IS ALERT AND AID MODE

Alert and aid mode uses multiple features to keep you in your lane. The system first provides a small steering input to bring your vehicle back towards the center of the lane. If your vehicle moves too far out of the center of the lane the system alerts you with vibration in the steering wheel.

Lane Keeping System (If Equipped)

HOW DOES ALERT AND AID MODE WORK

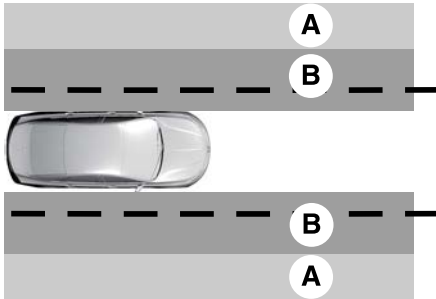

- A Alert.
- B Aid.

The lane keeping system detects a lane departure and provides aid when the vehicles enters **B** and applies the additional alert warning if **A** is entered.

LANE KEEPING SYSTEM INDICATORS

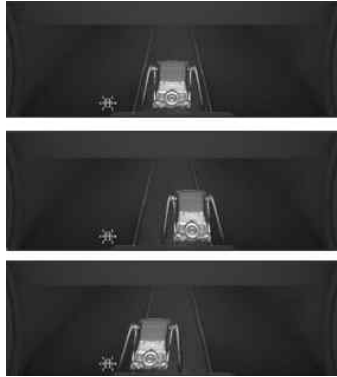

If you switch the lane keeping system on, a graphic with lane markings appears in the information display.

When you switch the system off, the lane marking graphics do not display.

Note: *The overhead vehicle graphic may still display if adaptive cruise control is enabled.*

While the lane keeping system is on, the color of the lane markings change to indicate the system status.

Gray	Green	Yellow	Red
Indicates that the system is temporarily unavailable to provide a warning or intervention on the indicated side.	Indicates that the system is available or ready to provide a warning or intervention on the indicated side.	Indicates that the system is providing or has just provided a lane keeping aid intervention.	Indicates that the system is providing or has just provided a lane keeping alert warning.

Lane Keeping System (If Equipped)

LANE KEEPING SYSTEM – TROUBLESHOOTING

LANE KEEPING SYSTEM – INFORMATION MESSAGES

Message	Action
Lane Keeping Sys. Malfunction Service Required	The system has malfunctioned. Have your vehicle checked as soon as possible.
Front Camera Temporarily Not Available	The system has detected a condition that has caused the system to be temporarily unavailable.
Front Camera Low Visibility Clean Screen	The system has detected a condition that requires you to clean the windshield in order for it to operate properly.
Front Camera Malfunction Service Required	The system has malfunctioned. Have your vehicle checked as soon as possible.
Keep Hands on Steering Wheel	The system requests that you keep your hands on the steering wheel.

Lane Keeping System (If Equipped)

LANE KEEPING SYSTEM – FREQUENTLY ASKED QUESTIONS

Why is the feature not available (lane markings are gray) when I can see the lane markings on the road?
Your vehicle speed is less than 40 mph (65 km/h).
The sun is shining directly into the camera lens.
A quick intentional lane change has occurred.
Your vehicle stays too close to the lane markings for an extended interval of time.
Driving at high speeds in curves.
The last alert warning or aid intervention occurred a short time ago.
Ambiguous lane markings, for example, in construction zones.
Rapid transition from light to dark, or from dark to light.
Sudden offset in lane markings.
ABS or AdvanceTrac™ is active.
There is a camera blockage due to dirt, grime, fog, frost or water on the windshield.
You are driving too close to the vehicle in front of you.
Transitioning between no lane markings to lane markings, or vice versa.
There is standing water on the road.
Faint lane markings, for example, partial yellow lane markings on concrete roads.
Lane width is too narrow or too wide.
You have not calibrated the camera after a windshield replacement.
Driving on tight or on uneven roads.

Lane Keeping System (If Equipped)

Why does the vehicle not come back toward the middle of the lane, as expected, in the Aid, or Aid + Alert mode?
High cross winds are present.
There is a large road crown.
Rough roads, grooves or shoulder drop-offs.
Heavy, uneven loading of the vehicle or improper tire inflation pressure.
You changed the tires or modified the suspension.

Blind Spot Information System (If Equipped)

WHAT IS BLIND SPOT INFORMATION SYSTEM

Blind spot information system detects vehicles that may have entered the blind spot zone.

HOW DOES BLIND SPOT INFORMATION SYSTEM WORK

Blind spot information system uses sensors on both sides of your vehicle, detecting rearward from the exterior mirrors to approximately 13 ft (4 m) beyond the rear bumper. The detection area extends to approximately 59 ft (18 m) beyond the rear bumper when the vehicle speed is greater than 30 mph (48 km/h) to alert you of faster approaching vehicles.

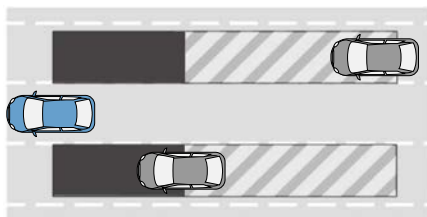

BLIND SPOT INFORMATION SYSTEM PRECAUTIONS



WARNING: Do not use the blind spot information system as a replacement for using the interior and exterior mirrors or looking over your shoulder before changing lanes. The blind spot information system is not a replacement for careful driving.



WARNING: The system may not operate properly during severe weather conditions, for example snow, ice, heavy rain and spray. Always drive with due care and attention. Failure to take care may result in a crash.

Note: *Blind spot information system does not prevent contact with other vehicles. It does not detect parked vehicles, pedestrians, animals or other infrastructure.*

BLIND SPOT INFORMATION SYSTEM LIMITATIONS

Blind spot information system does not operate in park (P) or reverse (R).

The system may not alert you if a vehicle quickly passes through the detection zone.

BLIND SPOT INFORMATION SYSTEM REQUIREMENTS - MANUAL TRANSMISSION

Blind spot information system turns on when all the following occur:

- You start your vehicle.
- You shift into drive (D).
- The vehicle speed is greater than 6 mph (10 km/h).

Blind Spot Information System (If Equipped)

BLIND SPOT INFORMATION SYSTEM REQUIREMENTS - AUTOMATIC TRANSMISSION

Blind spot information system turns on when all the following occur:

- You start your vehicle.
- You shift into drive (D).
- The vehicle speed is greater than 6 mph (10 km/h).

SWITCHING BLIND SPOT INFORMATION SYSTEM ON AND OFF

To switch blind spot information system on or off, use the touchscreen:

1. Press **Features** on the touchscreen.
2. Press **Driver Assistance**.
3. Press **Blind Spot Information System**.
4. Switch the feature on or off.

When you switch blind spot information system off, a warning lamp illuminates and a message displays. When you switch the system on or off, the alert indicators flash twice.

Note: The system remembers the last setting when you start your vehicle.

To permanently switch the system off, contact an authorized dealer.

LOCATING THE BLIND SPOT INFORMATION SYSTEM SENSORS

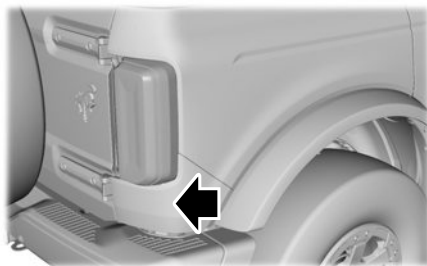

The sensors are behind the rear fascia panel.

Note: Keep the sensors free from snow, ice and large accumulations of dirt.

Note: Do not cover the sensors with bumper stickers, repair compound or other objects.

Note: Bike and cargo racks could cause false alerts due to obstruction of the sensor. We recommend switching the feature off when using a bike or cargo rack.

Note: Blocked sensors may affect system accuracy.

If the sensors become blocked, a message appears in the instrument cluster display. See **Blind Spot Information System – Information Messages** (page 258). The alert indicators illuminate but the system does not alert you.

Blind Spot Information System (If Equipped)

BLIND SPOT INFORMATION SYSTEM INDICATORS



When blind spot information system detects a vehicle, an alert indicator illuminates in the exterior mirror on the side the approaching vehicle is coming from. If you turn the turn signal on for that side of your vehicle, the alert indicator flashes.

BLIND SPOT INFORMATION SYSTEM – TROUBLESHOOTING

BLIND SPOT INFORMATION SYSTEM – INFORMATION MESSAGES

Message	Action
Blind Spot System Fault	A fault with the system has occurred. Have your vehicle checked as soon as possible.
Blind Spot Not Available Sensor Blocked See Manual	Something is blocking the sensors. Clean the sensors.
Blind Spot Alert Deactivated Trailer Attached	The system automatically turns off and displays this message when you connect a trailer to the vehicle that does not have a trailer blind spot system or when you switch the trailer blind spot system off through the touchscreen.

Cross Traffic Alert (If Equipped)

WHAT IS CROSS TRAFFIC ALERT

The system alerts you of vehicles approaching from the sides behind your vehicle when you shift into reverse (R).

HOW DOES CROSS TRAFFIC ALERT WORK

Cross Traffic Alert detects vehicles that approach at a speed between 4–37 mph (6–60 km/h). Coverage decreases when the sensors are partially, mostly or fully obstructed.

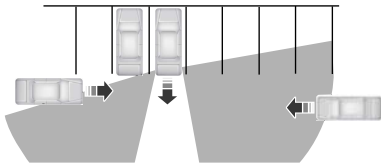

The sensor on the left-hand side is only partially obstructed and zone coverage on the right-hand side is maximized.

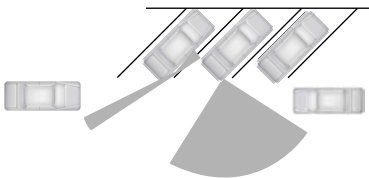

Zone coverage also decreases when parking at narrow angles. The sensor on the left-hand side is mostly obstructed and zone coverage on that side is severely reduced.

Note: *Slowly reversing helps increase the coverage area and effectiveness.*

CROSS TRAFFIC ALERT PRECAUTIONS

⚠️ WARNING: Do not use the cross traffic alert system as a replacement for using the interior and exterior mirrors or looking over your shoulder before reversing out of a parking space. The cross traffic alert system is not a replacement for careful driving.

⚠️ WARNING: The system may not operate properly during severe weather conditions, for example snow, ice, heavy rain and spray. Always drive with due care and attention. Failure to take care may result in a crash.

CROSS TRAFFIC ALERT LIMITATIONS

Cross Traffic Alert may not correctly operate when any of the following occur:

- Something is blocking the sensors.
- Adjacently parked vehicles or objects are obstructing the sensors.
- Vehicles approach at speeds less than 4 mph (6 km/h) or greater than 37 mph (60 km/h).
- Your vehicle speed is greater than 7 mph (12 km/h).
- You reverse out of an angled parking space.

SWITCHING CROSS TRAFFIC ALERT ON AND OFF

To switch cross traffic alert on or off use the touchscreen.

1. Press **Features** on the touchscreen.
2. Press **Driver Assistance**.

Cross Traffic Alert (If Equipped)

3. Switch **Cross Traffic Alert** on or off.

Note: The system switches on every time you switch the ignition on. To permanently switch the system off, contact an authorized dealer.

LOCATING THE CROSS TRAFFIC ALERT SENSORS

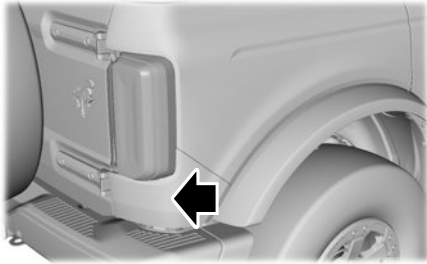

The sensors are behind the rear fascia panel.

Note: Keep the sensors free from snow, ice and large accumulations of dirt.

Note: Do not cover the sensors with bumper stickers, repair compound or other objects.

Note: Bike and cargo racks could cause false alerts due to obstruction of the sensor. We recommend switching the feature off when using a bike or cargo rack.

Note: Blocked sensors may affect system accuracy.

If something is blocking the sensors, a message may appear in the information display when you shift into reverse (R).

CROSS TRAFFIC ALERT INDICATORS



When the cross traffic alert detects an approaching vehicle, a tone sounds, a warning lamp illuminates in the relevant exterior mirror and arrows appear in the information display to show which side the vehicle is approaching from.

If the system malfunctions, a warning lamp illuminates in the instrument cluster and a message appears in the information display. Have your vehicle checked as soon as possible.

Note: If arrows do not display, a message appears in the information display.

Note: In some conditions, the system could alert you, even when there is nothing in the detection zone, for example a vehicle passing further away from your vehicle.

Cross Traffic Alert (If Equipped)

CROSS TRAFFIC ALERT – TROUBLESHOOTING

CROSS TRAFFIC ALERT – INFORMATION MESSAGES

Message	Action
Cross Traffic Alert	Displays instead of indication arrows when the system detects a vehicle. Check for approaching traffic.
Cross Traffic Not Available Sensor Blocked See Manual	Indicates blocked cross traffic alert system sensors. Clean the sensors. If the message continues to appear, have your vehicle checked as soon as possible.
Cross Traffic System Fault	The system has malfunctioned. Have your vehicle checked as soon as possible.
Cross Traffic Alert Deactivated Trailer Attached	Displays if you attach a trailer to your vehicle.

Pre-Collision Assist

WHAT IS PRE-COLLISION ASSIST

Pre-collision assist detects and warns of approaching hazards in the roadway. If your vehicle is rapidly approaching another stationary vehicle, a vehicle traveling in the same direction as yours, or a pedestrian within your driving path, the system provides multiple levels of assistance to help avoid a collision.

HOW DOES PRE-COLLISION ASSIST WORK

The system warns the driver of potential hazards by providing three levels of assistance.



If your vehicle is rapidly approaching potential hazards the system provides the following levels of functionality:

1. Alert.
2. Brake Support.
3. Automatic Emergency Braking.



Alert: When active, a flashing visual warning appears and an audible warning tone sounds.

Brake Support: The system is designed to help reduce the impact speed by preparing the brakes for rapid braking. The system does not automatically apply the brakes. If you press the brake pedal, the system could apply additional braking up to maximum braking force, even if you lightly press the brake pedal.

Automatic Emergency Braking: Automatic emergency braking may activate if the system determines that a collision is imminent.

Note: If you perceive pre-collision assist alerts as being too frequent or disturbing, then you can reduce the alert sensitivity, although the manufacturer recommends using the highest sensitivity setting where possible. Setting lower sensitivity would lead to fewer and later system warnings.

Each system has various levels of detection capabilities. See **Pre-Collision Assist Limitations** (page 263).

PRE-COLLISION ASSIST PRECAUTIONS



WARNING: You are responsible for controlling your vehicle at all times. The system is designed to be an aid and does not relieve you of your responsibility to drive with due care and attention. Failure to follow this instruction could result in the loss of control of your vehicle, personal injury or death.



WARNING: The system does not detect vehicles that are driving in a different direction, cyclists or animals. Apply the brakes when necessary. Failure to follow this instruction could result in the loss of control of your vehicle, personal injury or death.



WARNING: The system does not operate during hard acceleration or steering. Failure to take care may lead to a crash or personal injury.



WARNING: The system may fail or operate with reduced function during cold and severe weather conditions. Snow, ice, rain, spray and fog can adversely affect the system. Keep the front camera and radar free of snow and ice. Failure to take care may result in the loss of control of your vehicle, serious personal injury or death.

Pre-Collision Assist



WARNING: Take additional care if your vehicle is heavily loaded or you are towing a trailer. These conditions could result in reduced performance of this system. Failure to follow this instruction could result in the loss of control of your vehicle, personal injury or death.



WARNING: The system cannot help prevent all crashes. Do not rely on this system to replace driver judgment and the need to maintain a safe distance and speed.



WARNING: In situations where the vehicle camera has limited detection capability, this may reduce system performance. These situations include but are not limited to direct or low sunlight, vehicles at night without tail lights, unconventional vehicle types, pedestrians with complex backgrounds, running pedestrians, partly obscured pedestrians, or pedestrians that the system cannot distinguish from a group. Failure to take care may result in the loss of control of your vehicle, serious personal injury or death.

Note: Brake support and automatic emergency braking are active at speeds up to 75 mph (120 km/h). If the vehicle has a radar sensor included with adaptive cruise control, then brake support and automatic emergency braking are active up to the maximum speed of the vehicle.

Pedestrian Detection Limitations

Pedestrian detection is active at speeds up to 50 mph (80 km/h).

Pedestrian detection operates optimally when detected hazards are clearly identifiable. System performance may reduce in situations where pedestrians are running, partly obscured, have a complex background, or cannot be distinguished from a group.

Intersection Assist (if Equipped)

If your vehicle comes with a radar sensor included in adaptive cruise control, the pre-collision assist system may operate in a scenario where you are turning across an oncoming vehicle's path. Detection of vehicles driving in an oncoming direction is active if your vehicle is driving at speeds up to 19 mph (30 km/h).

PRE-COLLISION ASSIST LIMITATIONS

Pre-collision assist depends on the detection ability of its camera and sensors. Any obstructions or damage to these areas can limit detection or prevent the system from functioning. See **Locating the Pre-Collision Assist Sensors** (page 264).

The system is active at speeds above 3 mph (5 km/h).

Note: The pre-collision assist system automatically disables when you select four-wheel drive low, manually disable AdvanceTrac™, or select rock crawl mode.

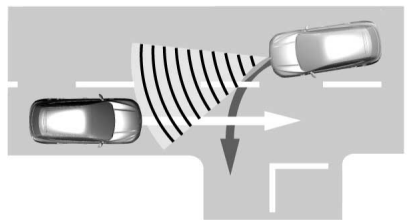

Pre-Collision Assist

SWITCHING PRE-COLLISION ASSIST ON AND OFF

To switch the system on or off, use the touchscreen:

1. Press **Features** on the touchscreen.
2. Press **Driver Assistance**.
3. Press **Pre-Collision Assist**.
4. Switch the feature on or off.

Adjusting the Pre-Collision Assist Settings

You can adjust the following settings by using the touchscreen controls in the pre-collision assist menu:

- Change alert and distance alert sensitivity to one of three possible settings.
- Switch distance indication and alert on or off.
- If required, switch automatic emergency braking on or off.
- If required, switch the entire pre-collision assist feature on or off.
- If required, switch evasive steering assist on or off.

Note: *Automatic emergency braking and evasive steering turn on every time you switch the ignition on.*

Note: *If your vehicle has a radar sensor, we recommend that you switch the system off if you install a snow plow or similar object in such a way that it may block the radar sensor. Your vehicle remembers the selected setting across key cycles.*

Note: *If you switch automatic emergency braking off, evasive steering assist switches off.*

LOCATING THE PRE-COLLISION ASSIST SENSORS

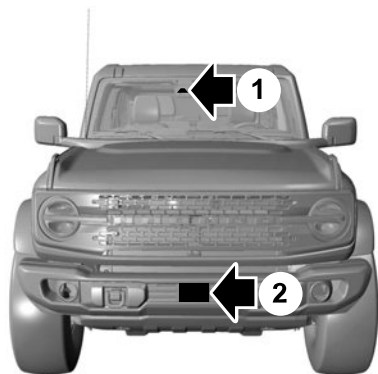

- 1 Camera.
- 2 Radar sensor (if equipped).

If a message regarding a blocked sensor or camera appears in the information display, something is obstructing the radar signals or camera images. If your vehicle has a radar sensor, it is behind the fascia cover in the center of the lower grille. With a blocked sensor or camera, the system may not function, or performance may reduce. See **Pre-Collision Assist – Information Messages** (page 267).

DISTANCE INDICATION

WHAT IS DISTANCE INDICATION

Distance indication displays the gap between your vehicle and the vehicle ahead of you.

Note: *The graphic does not display if you switch on cruise control or adaptive cruise control.*

Pre-Collision Assist

Vehicle Speed	System Sensitivity	Distance Indicator Color	Distance Gap	Time Gap
62 mph (100 km/h).	Normal.	Gray.	Greater than 82 ft (25 m).	Greater than 0.9 seconds.
		Yellow.	56–82 ft (17–25 m).	0.6-0.9 seconds.
		Red.	Less than 56 ft (17 m).	Less than 0.6 seconds.

Pre-Collision Assist

SWITCHING DISTANCE INDICATION ON AND OFF

To switch the system on or off, use the touchscreen:

1. Press **Features** on the touchscreen.
2. Press **Driver Assistance**.
3. Press **Pre-Collision Assist**.
4. Switch **Distance Indication** on or off.

DISTANCE INDICATION INDICATOR

The indicator displays the time gap between your vehicle and vehicles traveling in the same direction ahead of you.

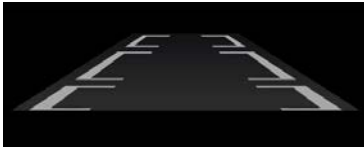

AUTOMATIC EMERGENCY BRAKING

WHAT IS AUTOMATIC EMERGENCY BRAKING

Automatic emergency braking may activate if the system determines that a collision is imminent. The system may help reduce impact damage to avoid the crash completely.

Automatic emergency braking is only available up to certain speeds. See **Pre-Collision Assist Limitations** (page 263).

SWITCHING AUTOMATIC EMERGENCY BRAKING ON AND OFF

To switch the system on or off, use the touchscreen:

1. Press **Features** on the touchscreen.
2. Press **Driver Assistance**.
3. Press **Pre-Collision Assist**.
4. Press **Auto Emergency Braking**.
5. Switch the feature on or off.

EVASIVE STEERING ASSIST

WHAT IS EVASIVE STEERING ASSIST

If your vehicle is rapidly approaching a road user, evasive steering assist helps you steer around the road user.

Pre-Collision Assist

After you turn the steering wheel in an attempt to avoid a crash with the road user, the system applies additional steering torque to help you steer around the road user. After you pass the road user, the system applies steering torque when you turn the steering wheel to steer back into the lane. The system deactivates after you fully pass the road user.

Note: Road users are defined as another stationary vehicle in the same lane or a vehicle traveling in the same lane in the same direction as you. See **Pre-Collision Assist Precautions** (page 262).

EVASIVE STEERING ASSIST LIMITATIONS

Evasive steering assist only activates when all the following occur:

- Automatic emergency braking and evasive steering assist are on.
- The system detects a road user ahead and starts to apply the brakes.
- You significantly turn the steering wheel to steer around a road user.

Note: Evasive steering assist does not automatically steer around a road user. If you do not turn the steering wheel, evasive steering assist does not activate.

Note: Evasive steering assist does not activate if the distance to the road user ahead is too small and the system cannot avoid a crash.

Note: Evasive steering does not activate with cyclists or pedestrians.

SWITCHING EVASIVE STEERING ASSIST ON AND OFF

To switch the system on or off, use the touchscreen:

1. Press **Features** on the touchscreen.
2. Press **Driver Assistance**.
3. Press **Pre-Collision Assist**.
4. Switch **Evasive Steering** on or off.

Note: If you switch automatic emergency braking off, evasive steering assist turns off.

Note: Automatic emergency braking and evasive steering assist turn on every time you switch the ignition on.

PRE-COLLISION ASSIST – TROUBLESHOOTING

PRE-COLLISION ASSIST – WARNING LAMPS



A telltale illuminates in the cluster to indicate if the system is disabled or unavailable.

PRE-COLLISION ASSIST – INFORMATION MESSAGES

Message	Action
Pre-Collision Assist Not Available Sensor Blocked	You have a blocked sensor due to bad weather, ice, mud or water in front of the radar sensor. You can typically clean the sensor to resolve.
Pre-Collision Assist Not Available	A fault with the system has occurred. Have your vehicle checked as soon as possible.

Pre-Collision Assist

PRE-COLLISION ASSIST – FREQUENTLY ASKED QUESTIONS

Camera Troubleshooting

The windshield in front of the camera is dirty or obstructed.

Clean the outside of the windshield in front of the camera.

The windshield in front of the camera is clean, but the message remains in the instrument cluster display.

Wait a short time. It could take several minutes for the camera to detect that there is no obstruction.

Radar Troubleshooting (If Equipped)

The surface of the radar in the grille is dirty or obstructed.

Clean the grille surface in front of the radar or remove the object causing the obstruction.

The surface of the radar in the grille is clean, but the message remains in the instrument cluster display.

Wait a short time. It could take several minutes for the radar to detect that there is no obstruction.

Heavy rain, spray or fog is interfering with the radar signals.

The pre-collision assist system is temporarily disabled. Pre-collision assist reactivates a short time after the weather conditions improve.

Swirling water or snow or ice on the surface of the road could interfere with the radar signals.

The pre-collision assist system is temporarily disabled. Pre-collision assist reactivates a short time after the weather conditions improve.

Radar is out of alignment due to a front end impact.

Have your vehicle serviced to have the radar checked for proper coverage and operation.

Driver Alert (If Equipped)

WHAT IS DRIVER ALERT

Driver alert alerts you if it determines that you are becoming drowsy or if your driving deteriorates.

HOW DOES DRIVER ALERT WORK

Driver Alert calculates your alertness level based on your driving behavior in relation to the lane markings and other factors through use of the front camera sensor behind the interior mirror.

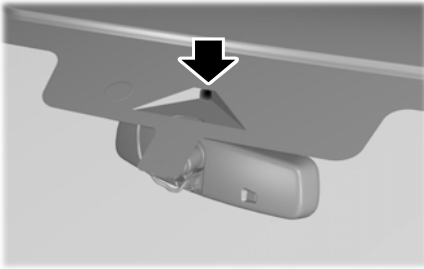

DRIVER ALERT PRECAUTIONS

WARNING: You are responsible for controlling your vehicle at all times. The system is designed to be an aid and does not relieve you of your responsibility to drive with due care and attention. Failure to follow this instruction could result in the loss of control of your vehicle, personal injury or death.

WARNING: Take regular rest breaks if you feel tired. Do not wait for the system to warn you.

WARNING: Certain driving styles may result in the system warning you even if you are not feeling tired.

WARNING: In cold and severe weather conditions the system may not function. Rain, snow and spray can all limit sensor performance.

WARNING: The system will not operate if the sensor cannot track the road lane markings.

WARNING: If damage occurs in the immediate area surrounding the sensor, have your vehicle checked as soon as possible.

WARNING: The system may not correctly operate if your vehicle is fitted with a suspension kit not approved by us.

WARNING: The system may not operate properly if the sensor is blocked. Keep the windshield free from obstruction.

Note: If something is blocking the camera or damaged the windshield, Driver Alert may not function.

DRIVER ALERT LIMITATIONS

Driver alert may not function correctly if:

- The sensor cannot track the road lane markings.
- Your vehicle's speed is less than approximately 40 mph (65 km/h).

Driver Alert (If Equipped)

SWITCHING DRIVER ALERT ON AND OFF

To switch driver alert on or off, use the touchscreen:

1. Press **Features** on the touchscreen.
2. Press **Driver Assistance**.
3. Switch **Driver Alert** on or off.

Note: *The system remains on or off depending on the last selection.*

Resetting Driver Alert

You can reset the system by either:

- Switching the ignition off and on.
- Stopping the vehicle and then opening and closing the driver door.

DRIVER ALERT INDICATORS

System Warnings

The warning system has two stages:

1. A temporary warning is issued to advise you to take a rest. This message only appears for a short time.
2. If you do not rest and the system continues to detect that your driving deteriorates, it issues a further warning. This remains in the instrument cluster display until you cancel it.

Note: *The system does not warn you if the vehicle speed falls below approximately 40 mph (65 km/h).*

DRIVER ALERT – TROUBLESHOOTING

DRIVER ALERT – INFORMATION MESSAGES

Message	Action
Driver Alert Warning Rest Now	Stop and rest as soon as it is safe to do so.
Driver Alert Warning Rest Suggested	Take a rest soon.

Load Carrying

LOAD CARRYING PRECAUTIONS

Keep your loaded vehicle weight within its design rating capability, with or without a trailer. Properly loading your vehicle provides maximum return of vehicle design performance. Before you load your vehicle, become familiar with the following terms for determining your vehicle's weight rating, with or without a trailer, from the vehicle's Tire and Loading Information label or Safety Compliance Certification label.



WARNING: The appropriate loading capacity of your vehicle can be limited either by volume capacity (how much space is available) or by payload capacity (how much weight the vehicle should carry). Once you have reached the maximum payload of your vehicle, do not add more cargo, even if there is space available. Overloading or improperly loading your vehicle can contribute to loss of vehicle control and vehicle rollover.



WARNING: Exceeding the Safety Compliance Certification label vehicle weight limits can adversely affect the performance and handling of your vehicle, cause vehicle damage and can result in the loss of control of your vehicle, serious personal injury or death.



WARNING: Do not use replacement tires with lower load carrying capacities than the original tires because they may lower your vehicle's GVWR and GAWR limitations. Replacement tires with a higher limit than the original tires do not increase the GVWR and GAWR limitations.



WARNING: Do not exceed the GVWR or the GAWR specified on the certification label.



WARNING: Exceeding any vehicle weight rating can adversely affect the performance and handling of your vehicle, cause vehicle damage and can result in the loss of control of your vehicle, serious personal injury or death.



WARNING: When loading the roof racks, we recommend you evenly distribute the load, as well as maintain a low center of gravity. Loaded vehicles, with higher centers of gravity, may

Load Carrying

handle differently than unloaded vehicles. Take extra precautions, such as slower speeds and increased stopping distance, when driving a heavily loaded vehicle.

The gross combined weight must never exceed the Gross Combined Weight Rating.

LOCATING THE SAFETY COMPLIANCE CERTIFICATION LABELS

Safety Compliance Certification Label Example:

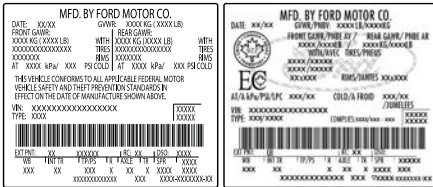

The Safety Compliance Certification label is located on the door hinge pillar, door-latch post, or the door edge that meets the door-latch post, next to the driver seating position.

WHAT IS THE GROSS AXLE WEIGHT RATING

GAWR (Gross Axle Weight Rating)

GAWR is the maximum allowable weight that a single axle (front or rear) can carry. These numbers are on the Safety Compliance Certification label.

WHAT IS THE GROSS VEHICLE WEIGHT RATING

GVWR is the maximum allowable weight of the fully loaded vehicle. This includes all options, equipment, passengers and cargo. It appears on the Safety Compliance Certification label.

WHAT IS THE MAXIMUM LOADED TRAILER WEIGHT

Maximum loaded trailer weight is the highest possible weight of a fully loaded trailer the vehicle can tow. Consult an authorized dealer (or the RV and Trailer Towing Guide available at an authorized dealer) for more detailed information. See **Towing a Trailer** (page 283).

WHAT IS THE GROSS COMBINED WEIGHT RATING

Gross Combined Weight Rating (GCWR) is the maximum allowable weight of the vehicle and the loaded trailer, including all cargo and passengers, that the vehicle can handle without risking

Load Carrying

damage. (Important: The towing vehicle's braking system is rated for operation at Gross Vehicle Weight Rating, not at Gross Combined Weight Rating.) Separate functional brakes should

be used for safe control of towed vehicles and for trailers where the Gross Combined Weight of the towing vehicle plus the trailer exceed the Gross Vehicle Weight Rating of the towing vehicle.

Note: *For trailer towing information refer to the RV and Trailer Towing Guide available at an authorized dealer, or online at the website that follows.*

RV & Trailer Towing Guide Online	
Website	www.fleet.ford.com/towing-guides

Load Carrying

CALCULATING PAYLOAD

Tire and Loading Label Information

Example:



TIRE AND LOADING INFORMATION

SEATING CAPACITY TOTAL : 5 FRONT: 2 REAR: 3

The combined weight of occupants and cargo should never exceed **385 kg or 850 lbs.**

TIRE	SIZE	COLD TIRE PRESSURE	SEE OWNERS MANUAL FOR ADDITIONAL INFORMATION
FRONT	235/45R18 94V	235 KPA, 34 PSI	
REAR	235/45R18 94V	235 KPA, 34 PSI	
SPARE	NONE	NONE	

is the maximum payload for your vehicle as built by the assembly plant. If you install any additional equipment on your vehicle, you must determine the new payload. Subtract the weight of the equipment from the payload listed on the Tire and Loading label. When towing, trailer tongue weight or king pin weight is also part of payload.

CALCULATING THE LOAD LIMIT

Steps for determining the correct load limit:

1. Locate the statement "The combined weight of occupants and cargo should never exceed XXX kg or XXX lb." on your vehicle's placard.
2. Determine the combined weight of the driver and passengers that will be riding in your vehicle.
3. Subtract the combined weight of the driver and passengers from XXX kg or XXX lb.
4. The resulting figure equals the available amount of cargo and luggage load capacity. For example, if the "XXX" amount equals 1,400 lb. and there will be five 150 lb. passengers in your vehicle, the amount of available cargo and luggage load capacity is 650 lb. (1400-750 (5 x 150) = 650 lb.)



TIRE AND LOADING INFORMATION
RENSEIGNEMENTS SUR LES PNEUS ET LE CHARGEMENT

SEATING CAPACITY TOTAL 5 FRONT 2 REAR 3
NOMBRE DE PLACES

The combined weight of occupants and cargo should never exceed **396 kg or 875 lbs.**
Le poids total des occupants et du chargement ne doit jamais dépasser

TIRE PNEU	SIZE DIMENSIONS	COLD TIRE PRESSURE PRESSION DES PNEUS A FROID	SEE OWNER'S MANUAL FOR ADDITIONAL INFORMATION VOIR LE MANUEL DE L'USAGER POUR PLUS DE RENSEIGNEMENTS
FRONT AVANT	235/40R19 96V	255 KPA, 37 PSI	
REAR ARRIERE	235/40R19 96V	255 KPA, 37 PSI	
SPARE DE SECOURS	T125/80R16 97M	415 KPA, 60 PSI	

Payload is the combined weight of cargo and passengers that your vehicle is carrying. The maximum payload for your vehicle appears on the Tire and Loading label. The label is either on the B-pillar or the edge of the driver door. Vehicles exported outside the US and Canada may not have a tire and loading label. Look for "The combined weight of occupants and cargo should never exceed XXX kg or XXX lb" for maximum payload. The payload listed on the Tire and Loading Information label

Load Carrying

- Determine the combined weight of luggage and cargo being loaded on the vehicle. That weight may not safely exceed the available cargo and luggage load capacity calculated in Step 4.
- If your vehicle will be towing a trailer, load from your trailer will be transferred to your vehicle. Consult this manual to determine how this reduces the available cargo and luggage load capacity of your vehicle.

Helpful examples for calculating the available amount of cargo and luggage load capacity

Suppose your vehicle has a 1400-pound (635-kilogram) cargo and luggage capacity. You decide to go golfing. Is there enough load capacity to carry you, four of your friends and all the golf bags? You and four friends average 220 pounds (99 kilograms) each and the golf bags weigh approximately 30 pounds (13.5 kilograms) each. The calculation would be: $1400 - (5 \times 220) - (5 \times 30) = 1400 - 1100 - 150 = 150$ pounds. Yes, you have enough load capacity in your vehicle to transport four friends and your golf bags. In metric units, the calculation would be: $635 \text{ kilograms} - (5 \times 99 \text{ kilograms}) - (5 \times 13.5 \text{ kilograms}) = 635 - 495 - 67.5 = 72.5$ kilograms.

Suppose your vehicle has a 1400-pound (635-kilogram) cargo and luggage capacity. You and one of your friends decide to pick up cement from the local home improvement store to finish that patio you have been planning for the past two years. Measuring the inside of the vehicle with the rear seat folded down, you have room for twelve 100-pound (45-kilogram) bags of cement. Do you have enough load capacity to transport the cement to your home? If you and your friend each weigh 220 pounds (99 kilograms), the calculation would be: $1400 - (2 \times 220) - (12 \times 100) = 1400 - 440 - 1200 = -240$ pounds. No, you do not have enough cargo capacity to carry that much weight. In metric units, the calculation would be: $635 \text{ kilograms} - (2 \times 99 \text{ kilograms}) - (12 \times 45 \text{ kilograms}) = 635 - 198 - 540 = -103$ kilograms. You will need to reduce the load weight by at least 240 pounds (104 kilograms). If you remove three 100-pound (45-kilogram) cement bags, then the load calculation would be: $1400 - (2 \times 220) - (9 \times 100) = 1400 - 440 - 900 = 60$ pounds. Now you have the load capacity to transport the cement and your friend home. In metric units, the calculation would be: $635 \text{ kilograms} - (2 \times 99 \text{ kilograms}) - (9 \times 45 \text{ kilograms}) = 635 - 198 - 405 = 32$ kilograms.

Load Carrying

The above calculations also assume that the loads are positioned in your vehicle in a manner that does not overload the front or the rear gross axle weight rating specified for your vehicle on the Safety Compliance Certification label.

ROOF RACK (IF EQUIPPED)

ROOF RACK PRECAUTIONS

 **WARNING:** Read and follow the manufacturer's instructions when you are fitting a roof rack.

 **WARNING:** When loading the roof racks, we recommend you evenly distribute the load, as well as maintain a low center of gravity. Loaded vehicles, with higher centers of gravity, may handle differently than unloaded vehicles. Take extra precautions, such as slower speeds and increased stopping distance, when driving a heavily loaded vehicle.

Note: If you use a roof rack, the fuel consumption of your vehicle will be higher and you may experience different driving characteristics.

Note: Never place loads directly on the roof panel. The roof panel is not designed to directly carry a load.

You must place loads directly on the crossbars fitted to the roof rack side rails. When using the roof rack system, we recommend that you use genuine Ford accessory crossbars specifically designed for your vehicle.

Make sure that you securely fasten the load. Check the tightness of the load before driving and at each fuel stop.

REMOVING AND INSTALLING THE ROOF RACK

Removing the Roof Rack (If Equipped)



1. Using the provided T30 tool, remove the front roof rack cover fasteners.
2. Remove the front roof rack covers by pulling upward at the rear edge and rotating forward.

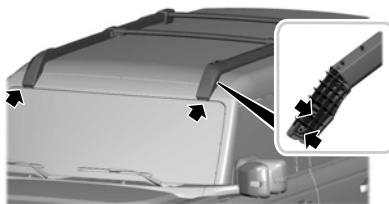

3. Using the provided T30 tool, remove the front roof rack fasteners.

Load Carrying

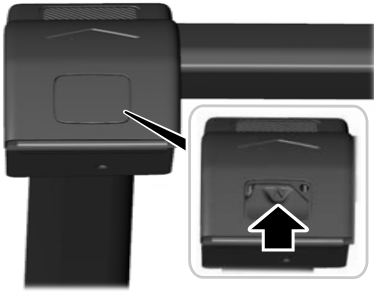

4. Remove the cover to access the rear fastener.
5. Using the supplied special tool, loosen the fastener until you can remove the rack.
6. Remove the rack from the vehicle.

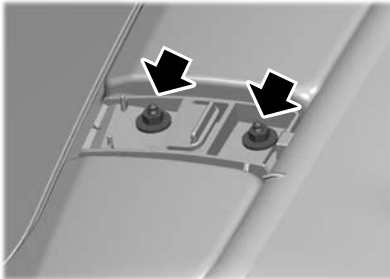

Note: The windshield trim cover, retaining plate and fasteners are provided. The trim cover is installed when you remove the roof rack.

7. Locate the trim cover components.
8. Place the trim cover retaining plate over the mounting studs.
9. Install the supplied fasteners. Torque nuts to 7.7 lb.ft (10.5 Nm).
10. Align the cover with the alignment slot at the front of the cover, then rotate rearward and snap into place.

Installing the Roof Rack

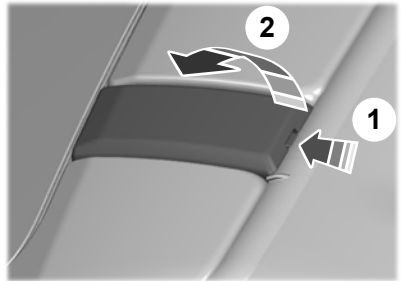

1. To remove, press the button on the rear of the cover and rotate forward.
2. Remove the fasteners and remove the trim cover retaining plate.
3. Store the trim cover components.

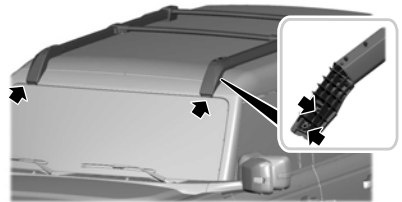

4. Position the roof rack on the vehicle.
5. Hand start the front roof rack fasteners.
6. Using the provided T30 tool, tighten the front roof rack fasteners. Torque bolts to 7.7 lb.ft (10.5 Nm).
7. Align the cover with the alignment slot and rotate rearward.
8. Hand start the front roof rack cover fasteners.
9. Using the provided T30 tool, tighten the front roof rack cover fasteners. Torque bolts to 5.9 lb.ft (8 Nm).

Load Carrying

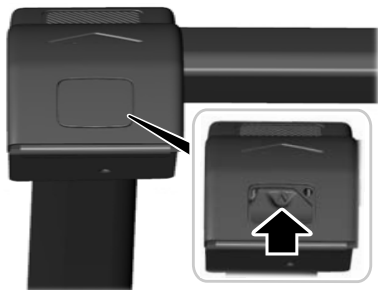

ADJUSTING A ROOF RACK CROSSBAR

Adjusting the Crossbar (If Equipped)

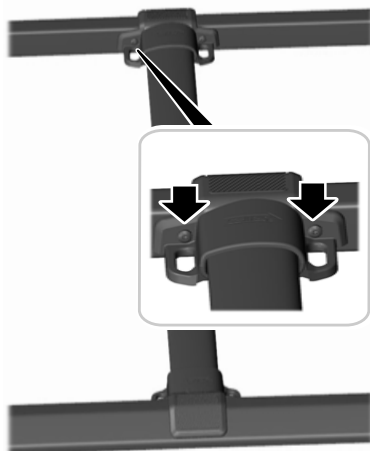

Note: The rear crossbar is part of the clamping system. If you removed the crossbar you must install it first for proper attachment to the hard top.

10. Using the supplied special tool, tighten the fastener.

Note: The supplied special tool stops turning the fastener when you have proper torque applied.

11. Install the rear roof rack fastener cover.

1. Using the provided T30 tool, remove the crossbar bolts.
2. Move the crossbar to the new position.
3. Using the provided T30 tool, install the crossbar bolts.

Note: Torque bolts to 5.9 lb.ft (8 Nm).

Note: Moving the crossbars forward may increase wind noise. To limit wind noise return the crossbars to the rearward position.

ROOF RACK LOAD CAPACITIES

Maximum Recommended Load Amounts

Description	Maximum Recommended Load
When in motion	110 lb (50 kg)
When stationary	450 lb (204 kg)
Vehicles with 315/70R17 Tires	0 lb (0 kg)

Load Carrying

Note: *The maximum recommended load is based on the load being evenly distributed on the crossbars.*

FENDER ANCHOR POINTS

LOCATING THE FENDER ANCHOR POINTS

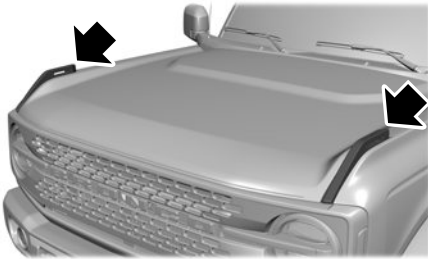

FENDER ANCHOR POINT LOAD CAPACITIES

The maximum recommended load is 150 lb (68 kg).

Rear Cargo Area

REAR CARGO AREA ANCHOR POINTS

REAR CARGO AREA ANCHOR POINT PRECAUTIONS



WARNING: Always properly secure cargo to prevent shifting cargo or cargo falling from the vehicle. Failure to do so could result in compromised vehicle stability and serious personal injury to vehicle occupants or others.



WARNING: The appropriate loading capacity of your vehicle can be limited either by volume capacity (how much space is available) or by payload capacity (how much weight the vehicle should carry). Once you have reached the maximum payload of your vehicle, do not add more cargo, even if there is space available. Overloading or improperly loading your vehicle can contribute to loss of vehicle control and vehicle rollover.



WARNING: It is extremely dangerous to ride in a cargo area, inside or outside of a vehicle. In a crash, people riding in these areas are more likely to be seriously injured or killed. Do not allow people to ride in any area of your vehicle that is not equipped with seats and seatbelts. Make sure everyone in your vehicle is in a seat and properly using a seatbelt. Failure to follow this warning could result in serious personal injury or death.

LOCATING THE REAR CARGO AREA ANCHOR POINTS

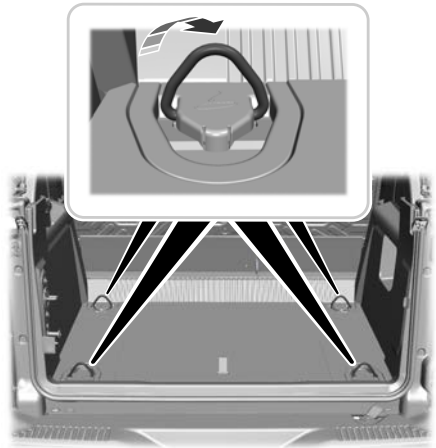

REAR CARGO AREA ANCHOR POINT LOAD CAPACITIES

Maximum Load Value
2,000 lb (907 kg)

Connecting a Trailer

CONNECTING A TRAILER PRECAUTIONS



WARNING: Do not adjust the spring bars so that your vehicle's rear bumper is higher than before attaching the trailer. Doing so will defeat the function of the weight-distributing hitch, which may cause unpredictable handling, and could result in serious personal injury.

Do not tow a trailer until you drive your vehicle at least 1,000 mi (1,600 km).

Consult your local motor vehicle laws for towing a trailer.

See the instructions included with towing accessories for the proper installation and adjustment specifications.

Service your vehicle more frequently if you tow a trailer. See **Normal Scheduled Maintenance** (page 455).

If you use a rental trailer, follow the instructions the rental agency gives you.

When attaching the trailer wiring connector to your vehicle, only use a proper fitting connector that works with the vehicle and trailer functions.

Account for the trailer coupler weight as part of your vehicle load when calculating the total vehicle weight.

Do not exceed the load limits. See **Calculating the Load Limit** (page 274).

CONNECTING A TRAILER

Trailer Towing Connector (If Equipped)



When attaching the trailer wiring connector to your vehicle, only use a proper fitting connector that works with the vehicle and trailer functions.

Trailer Lamps



WARNING: Never connect any trailer lamp wiring to the vehicle's tail lamp wiring; this may damage the electrical system resulting in fire. Contact your authorized dealer as soon as possible for assistance in proper trailer tow wiring installation. Additional electrical equipment may be required.

Most towed vehicles require trailer lamps. Make sure all running lights, brake lights, turn signals and hazard lights are working.

Safety Chains

Install trailer safety chains to the trailer hitch as recommended by the manufacturer. Cross the chains under the trailer coupler and allow enough slack for turning tight corners. Do not allow the chains to drag on the ground.

Connecting a Trailer

Note: Do not attach safety chains to the bumper. Always connect the safety chains to the frame or hook retainers of your trailer hitch.

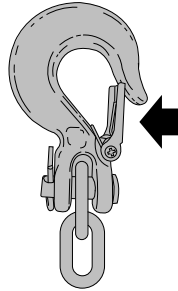

If the trailer safety chain hook has a latch, make sure to fully close the latch.

CONNECTING A TRAILER – TROUBLESHOOTING

CONNECTING A TRAILER – INFORMATION MESSAGES

Message	Description
Trailer Disconnected	The system senses a trailer connection disconnecting, either intentionally or unintentionally, during a given ignition cycle.

Towing a Trailer

TOWING A TRAILER PRECAUTIONS

 **WARNING:** Do not exceed the GVWR or the GAWR specified on the certification label.

 **WARNING:** Towing trailers beyond the maximum recommended gross trailer weight exceeds the limit of your vehicle and could result in engine damage, transmission damage, structural damage, loss of vehicle control, vehicle rollover and personal injury.

 **WARNING:** Do not exceed the lowest rating capacity for your vehicle or trailer hitch. Overloading your vehicle or trailer hitch can impair your vehicle stability and handling. Failure to follow this instruction could result in the loss of control of your vehicle, personal injury or death.

 **WARNING:** Make sure that the vertical load on the tow ball is between the minimum and maximum recommended weight at all times. Failure to follow this instruction could result in the loss of control of your vehicle, personal injury or death.

 **WARNING:** Do not cut, drill, weld or modify the trailer hitch. Modifying the trailer hitch could reduce the hitch rating.

 **WARNING:** The anti-lock brake system does not control the trailer brakes.

TRAILER BRAKE PRECAUTIONS

 **WARNING:** Do not connect a trailer's hydraulic brake system directly to your vehicle's brake system. Your vehicle may not have enough braking power and your chances of having a collision greatly increase.

 **WARNING:** Do not tow a trailer fitted with electric trailer brakes unless your vehicle is fitted with a compatible aftermarket electronic trailer brake controller. Failure to follow this instruction could result in the loss of control of your vehicle, personal injury or death. For additional information and assistance, we recommend that you contact an authorized dealer.

Electric brakes and manual, automatic or surge-type trailer brakes are safe if you install them properly and adjust them to the manufacturer's specifications. The trailer brakes must meet local and federal regulations.

The rating for the tow vehicle's braking system operation is at the gross vehicle weight rating, not the gross combined weight rating.

Towing a Trailer

Certain states require functioning trailer brakes for trailers over a specified weight. Be sure to check state regulations for this specified weight.

Ford Motor Company recommends separate functioning brake systems for trailers weighing more than 1,500 lb (680 kg) when loaded.

TOWING A TRAILER LIMITATIONS

The vehicle's load capacity designation is by weight, not by volume, so you cannot necessarily use all available space when loading a vehicle or trailer.

Note: *Your vehicle could have reduced performance when operating at high altitudes and when heavily loaded or towing a trailer. When driving at elevation, to match driving performance as perceived at sea level, reduce gross vehicle weight and gross combination weight by 2% per 1,000 ft (300 m) elevation.*

LOADING YOUR TRAILER

To help minimize how trailer movement affects your vehicle when driving:

- Load the heaviest items closest to the trailer floor.
- Load the heaviest items centered between the left and right side trailer tires.

- Load the heaviest items above the trailer axles or just slightly forward toward the trailer tongue. Do not allow the final trailer tongue weight to go above or below 10-15% of the loaded trailer weight. The trailer tongue weight should never exceed 10% of the maximum towing capacity.
- Select a ball mount with the correct rise or drop. When both the loaded vehicle and trailer are connected, the trailer frame should be level, or slightly angled down toward your vehicle, when viewed from the side.

TRAILER TOWING HINTS

Towing a trailer places an extra load on your vehicle's engine, transmission, axle, brakes, tires and suspension. Periodically inspect these components during and after any towing operation.

When driving with a trailer or payload, a slight takeoff vibration or shudder may be present due to the increased payload weight.

Your vehicle may have a temporary or conventional spare tire. A temporary spare tire is different in diameter or width, tread-type, or is from a different manufacturer than the road tires on your vehicle. Consult information on the tire label or Safety Compliance label for limitations when using.

Towing a Trailer

When towing a trailer:

- Obey country specific regulations for towing a trailer.
- Do not drive faster than 70 mph (113 km/h) during the first 500 mi (800 km).
- Do not make full-throttle starts.
- Check your hitch, electrical connections and trailer wheel lug nuts thoroughly after you have traveled 50 mi (80 km).
- When stopped in congested or heavy traffic during hot weather, place the transmission in park (P) to aid engine and transmission cooling and to help A/C performance.
- Turn off the speed control with heavy loads or in hilly terrain. The speed control may turn off when you are towing on long, steep slopes.
- Shift to a lower gear when driving down a long or steep hill. Do not continuously apply the brakes, as they may overheat and become less effective.
- If your transmission has Grade Assist or Tow/Haul, use this feature when towing. This provides engine braking and helps eliminate excessive transmission shifting for optimum fuel economy and transmission cooling.
- Your vehicle has AdvanceTrac with roll stability control. When towing a trailer, additional loads could cause the AdvanceTrac system to engage during cornering maneuvers. Reduce cornering speeds to make sure that you can maintain control of the vehicle and trailer if the AdvanceTrac system engages.

- Allow more distance for stopping with a trailer attached. Anticipate stops and gradually brake.
- Avoid parking on a slope. However, if you must park on a slope, turn the steering wheel to point your vehicle tires away from traffic flow, set the parking brake, place the transmission in park (P) and place wheel chocks in front and back of the trailer wheels.

Note: *Chocks are not included with your vehicle.*

LAUNCHING OR RETRIEVING A BOAT OR PERSONAL WATERCRAFT

When backing down a ramp during boat launching or retrieval:

- Do not allow the static water level to rise above the bottom edge of the rear bumper.
- Do not allow waves to break higher than 6 in (15 cm) above the bottom edge of the rear bumper.

Exceeding 6 in (15 cm) could allow water to enter vehicle components, causing internal damage to the components and affecting driveability, emissions and reliability.

Note: *Replace the rear axle lubricant anytime the rear axle has been submerged in water.*

Note: *Disconnect the trailer wiring connector before backing the trailer into the water.*

Note: *Reconnect the trailer wiring connector after removing the trailer from the water.*

Towing a Trailer

TOWING WEIGHTS AND DIMENSIONS

RECOMMENDED TOWING WEIGHTS

Market	Website
United States of America	https://www.fleet.ford.com/towing-guides/
Canada	https://www.fleet.ford.ca/towing-guides/

Towing a Trailer

WHAT IS THE MAXIMUM LOADED TRAILER WEIGHT

The maximum loaded trailer weight is the highest possible weight of a fully loaded trailer the vehicle can tow.

CALCULATING THE MAXIMUM LOADED TRAILER WEIGHT FOR YOUR VEHICLE

1. Start with the gross combined weight rating for your vehicle model and axle ratio.
2. Subtract all of the following that apply to your vehicle:
 - Vehicle curb weight.
 - Hitch hardware weight, for example a draw bar, ball, locks or weight distributing hardware.

- Driver weight.
- Passenger weight.
- Payload, cargo and luggage weight.
- Aftermarket equipment weight.

This equals the maximum loaded trailer weight for this combination.

Note: *The trailer tongue load is considered part of the payload for your vehicle. Reduce the total payload by the final trailer tongue weight.*

Note: *Consult an authorized dealer to determine the maximum trailer weight allowed for your vehicle if you are not sure.*

TOWING A TRAILER – TROUBLESHOOTING

TOWING A TRAILER – INFORMATION MESSAGES

Message	Details
Trailer Sway Reduce Speed	The trailer sway control detects trailer sway. Reduce the vehicle's speed.

Trailer Sway Control

HOW DOES TRAILER SWAY CONTROL WORK

The system applies the brakes to the individual wheels and reduces engine torque to aid vehicle stability.

If the trailer begins to sway, the stability control lamp flashes and the message **Trailer Sway Reduce Speed** appears in the information display.

Stop your vehicle as soon as it is safe to do so. Check the vertical weight on the tow ball and trailer load distribution.

2. Press **Towing**.
3. Switch **Trailer Sway Control** on or off.

The system turns on each time you start your vehicle.

TRAILER SWAY CONTROL PRECAUTIONS



WARNING: Turning off trailer sway control increases the risk of loss of vehicle control, serious injury or death. Ford does not recommend disabling this feature except in situations where speed reduction may be detrimental (such as hill climbing), the driver has significant trailer towing experience, and can control trailer sway and maintain safe operation.

Note: *This feature only activates when significant trailer sway occurs.*

Note: *This feature does not prevent trailer sway, but reduces it once it begins.*

Note: *This feature cannot stop all trailers from swaying.*

Note: *In some cases, if vehicle speed is too high, the system may activate multiple times, gradually reducing vehicle speed.*

SWITCHING TRAILER SWAY CONTROL ON AND OFF

1. Press **Features** on the touchscreen.

Driving Hints

OFF-ROAD DRIVING

WHAT IS OFF-ROAD DRIVING

Off-road driving is driving your vehicle on unsurfaced roads or trails, made from dirt, rocks, sand and mud.

Your vehicle has been designed and equipped to explore those places where the road cannot take you, whether you choose a forest trail or the open desert.

OFF-ROAD DRIVING PRECAUTIONS



WARNING: If you continue to drive your vehicle when the engine is overheating, the engine could stop without warning. Failure to follow this instruction could result in the loss of control of your vehicle.

Before going off-road, consult with your local governmental agencies to determine designated off-road trails and recreation areas. Also, be sure to understand any off-road vehicle registration requirements for the area in which you plan on driving.

Tread Lightly is an educational program designed to increase public awareness of land-use regulations and responsibilities in our nation's wilderness areas. The U.S. Forest Service and Bureau of Land Management is encouraging you to help preserve our national forest and other public and private lands by treading lightly.

Before taking your vehicle off-road, perform a basic vehicle inspection to make sure the vehicle is in top working condition.

Before you venture off road, have a clear mental picture of the underside of your vehicle. Learn the location of any low hanging items and any skid plates that may be on the vehicle. You can avoid snagging them on rocks and other obstacles if you know where they are.

Memorizing some basic dimensions helps you confidently deal with off-road obstacles. Get to know your vehicle's height and width, its lowest point, its wading depth and angles. Familiarize yourself with your vehicle's on-board technology features.

We recommend driving at least two vehicles when driving off-road. The buddy system helps make sure that help is close at hand should a vehicle become stuck or damaged.

We recommend taking supplies such as a first aid kit, supply of water, tow strap and cell or satellite phone with you any time you plan an off-road excursion.

BASIC OFF-ROAD DRIVING TECHNIQUES

Grip the steering wheel with your thumbs on the outside of the rim. This reduces the risk of injury due to abrupt steering wheel motions that occur when negotiating rough terrain.

Control your throttle, brake and steering inputs in a smooth manner. Sudden inputs to the controls can cause a loss of traction for the vehicle, especially when on sloped terrain or crossing obstacles such as rocks or logs.

Driving Hints

Look ahead on your route noting upcoming obstacles, surface texture or color changes or any other factors which may indicate a change in available traction. Adjust the vehicle speed and route to avoid a loss in traction. Conditions can change causing the course to vary day to day. Mark obstacles with GPS markers to avoid potential vehicle damage. Where necessary, get out of your vehicle and check the terrain.

When driving off-road, if the front or rear suspension is bottoming-out or excessive contact with the skid-plates is happening, reduce the vehicle's speed to avoid potential damage to your vehicle.

If you are driving in a dusty area, be sure to leave ample distance between your vehicle and any other vehicles to allow for adequate vision.

When driving off-road verify that your wipers and washers are working properly and reduce your speed for better visibility.

When driving in desert conditions, we recommend driving with your headlamps on to help other drivers easily see you.

When convoying with other vehicles, we recommend that communication is used, and the lead vehicle notify other vehicles of upcoming obstacles.

Keep available ground clearance in mind and pick a route that minimizes the risk of catching the underside of the vehicle on an obstacle.

When negotiating low speed obstacles, applying light brake pressure in conjunction with the throttle allows you to negotiate the obstacle in a more controlled manner.

Driving off-road requires a high amount of concentration. Even if your local law does not prohibit drinking alcohol when driving off-road we do not recommend it.

DRIVING OFF-ROAD

Driving In Snow and Ice



WARNING: If you are driving in slippery conditions that require tire chains or cables, then it is critical that you drive cautiously. Keep speeds down, allow for longer stopping distances and avoid aggressive steering to reduce the chances of a loss of vehicle control which can lead to serious injury or death. If the rear end of your vehicle slides while cornering, steer in the direction of the slide until you regain control of your vehicle.

Four-wheel drive vehicles have advantages over two-wheel drive vehicles in snow and ice but can skid like any other vehicle. If your vehicle slides when driving on snowy or icy roads, turn the steering wheel in the direction of the slide until you regain control. Avoid sudden applications of power and quick changes of direction on snow and ice. Slowly and steadily apply the accelerator when starting from a full stop. Avoid sudden braking.



WARNING: Do not become overconfident in the ability of four-wheel drive vehicles. Although a four-wheel drive vehicle may accelerate better than a two-wheel drive vehicle in low traction situations, it won't stop any faster than two-wheel drive vehicles. Always drive at a safe speed.

Make sure you allow sufficient distance between your vehicle and other vehicles for stopping.

In emergency stopping situations, do not pump the brake pedal, apply the brake firmly.

Driving Hints

Driving In Sand

When driving over sand, try to keep all four wheels on the most solid area of the trail. Drive through the terrain without varying vehicle speed. Apply the accelerator and avoid excessive wheel slip.

Use the vehicle's momentum to maintain forward motion in sand. Avoid coming to a stop on steep sand slopes as the vehicle may not be able to continue forward after it has stopped.

Driving In Mud

Be cautious of sudden changes in vehicle speed or direction when you are driving in mud.

Even four-wheel drive vehicles can lose traction in slick mud. If your vehicle does slide, steer in the direction of the slide until you regain control of your vehicle.

After driving through mud, clean off residue stuck to the wheels and tires and rotating driveshafts. Excess mud stuck on the wheels and tires and rotating driveshafts can cause an imbalance that could damage drive components.

Note: *The vehicle brakes are less effective when wet or muddy.*

Driving Over Rocks and Gravel

Gravel is a constantly changing, low-grip surface. Driving at slow speeds on gravel reduces the risk of losing traction when you stop, accelerate or turn a corner.

When approaching large rocks, position the vehicle so that the tires pass over the largest obstacle.

Note: *Never attempt to straddle a rock that is large enough to strike your axles or undercarriage.*

Note: *Never attempt to drive over a rock which is large enough to contact the door sills if your vehicle does not have rock rails.*

If you lose traction on your wheels facing uphill, stop and choose a more suitable route.

Leave a generous gap between your vehicle and other vehicles to minimize the risk of damage from flying gravel. Avoid dust clouds as they reduce visibility.

Before navigating on uneven ground, secure anything inside the vehicle. If possible, remove any roof-rack items. Use the lowest gear possible and approach the obstacle at a slow speed.

If your vehicle begins to slide down a slope, steer downhill and gently apply the throttle. If you lose traction on your uphill wheels, stop immediately and choose a more suitable route.

Approach logs, rocky steps or ditches diagonally. Keep at least three wheels on the ground at all times.

Climbing A Hill



WARNING: Extreme care should be used when steering the vehicle in reverse down a slope so as not to cause the vehicle to swerve out of control.

Although natural obstacles can make it necessary to travel diagonally up or down a hill or steep incline, try to drive straight up or straight down.

Note: *Avoid turning on steep slopes or hills. A danger lies in losing traction, slipping sideways and possible vehicle roll over.*

Whenever driving on a hill, you must first determine the route you can use.

When climbing a steep slope or hill, start in a lower gear rather than downshifting to a lower gear from a higher gear. This reduces strain on the engine and the possibility of stalling.

Driving Hints

If your vehicle stalls, do not try to turn around because this could cause your vehicle to roll over. It is better to reverse back to a safe location.

Do not drive over the crest of a hill without seeing what conditions are on the other side. Do not drive in reverse over a hill without the aid of an observer.

If the vehicle is unable to make it up the hill, do not attempt to turn back down the slope.

Apply the accelerator just enough for the wheels to climb the hill.

Note: *Too much acceleration can cause the tires to slip, spin or lose traction, resulting in loss of vehicle control.*

Descending A Hill:

- Use the same gear you would use to climb the hill.
- Do not descend in neutral.
- Disengage overdrive.
- Avoid sudden and excessive braking.

Note: *The front wheels have to be turning in order to steer your vehicle.*

When descending a steep hill in a manual transmission vehicle do not leave the vehicle in gear with the clutch pressed. This could cause damage to your driveline.

Driving Through Water



WARNING: Do not attempt to cross a deep, fast flowing body of water. Failure to follow this instruction could result in the loss of control of your vehicle, personal injury or death.

As the water depth increases, you must reduce your vehicle speed to avoid potential vehicle damage.

The key to a safe crossing is the water depth, current and bottom of the water's condition. On soft bottoms, the vehicle sinks in, effectively increasing the water level on the vehicle. Make sure to consider this when determining the depth of water.

Determine the depth and speed of the current before attempting a water crossing.

Be aware that obstacles and debris may be beneath the water's surface.

Note: *Cross flowing water at an angle heading slightly upstream.*

Note: *You should tread lightly and avoid damage to the environment.*

Drive slowly when crossing water. Proceed with a constant slow speed lightly pressing on the accelerator.

Drive through the water very slowly when entering, then build up momentum. Keep your vehicle moving at a steady pace.

Note: *Do not try to accelerate through the water crossing.*

When driving too fast in water or through deep water, the engine, transmission, transfer case, axles, electrical components or vehicle interior could ingest water. Water can cause permanent damage that may not be covered by your vehicle warranty. See **Driving Through Water Limitations** (page 294).

Note: *Failure to follow the recommended speeds can result in vehicle damage.*

Never stop or shut a vehicle off when crossing deep water unless your vehicle ingested water into the engine air intake. If the engine stalls, do not attempt to restart it.

Ease off the accelerator as you reach the other side to diminish the front wave. Apply the accelerator slowly and as necessary to climb out of the other side.

Driving Hints

Muddy waters can reduce the cooling system effectiveness by depositing debris into the radiator.

Extra care must be taken crossing any type of water. Do not drive into water unless necessary. You should only drive through areas that are designated and approved.

High currents even in shallow water can wash the dirt out from around your tires or push your vehicle across slippery rocks or surfaces.

Never attempt to cross flowing water that is deeper than your vehicles ground clearance. Even in low currents your vehicles body surface area can be pushed downstream and out of control.

Do not cross any body of water that is fast flowing and rising, wait for the flow rate to reduce.

Determine exit points that are downstream of your entry point to allow for drifting.

If there are other vehicles ahead, wait until they've left the water. Unsettled water can make a safe passage more challenging.

Know your vehicle's abilities and be able to recover it if something goes wrong.

Keep the doors fully closed during a water crossing.

Vehicles used to traverse water regularly should be periodically inspected for signs of water ingestion in all of the vehicle's fluids. If water is found inside your vehicle fluids, service your vehicle or see an authorized dealer.

After driving through water and as soon as it is safe to do so, check the brakes, horn, lights, and steering wheel to make sure everything is still in working order.

Avoid Getting High-Centered

Always keep available ground clearance in mind and pick a route that minimizes the risk of catching the underside of the vehicle on an obstacle and getting high-centered.

Freeing A Stuck Vehicle



WARNING: Do not spin the wheels at over 34 mph (55 km/h). The tires may fail and injure a passenger or bystander.

Recovery hooks are mounted to the vehicle's structure and are used to pull out the vehicle from a surface or location when stuck. Recover your vehicle using various towing apparatus attached to your recovery hook such as winch, open hook, or strap.

Note: Do not use recovery hooks to *recreationally tow your vehicle*. See **Recreationally Towing Your Vehicle** (page 307).

If your vehicle gets stuck in mud or snow, you may rock it out by shifting between forward and reverse gears, stopping between shifts in a steady pattern. Press the accelerator in each gear.

Note: Do not rock your vehicle if the engine is not at normal operating temperature damage to the transmission may occur.

Note: Do not rock your vehicle for more than a minute damage to the transmission and tires may occur or the engine may overheat.

If you are unable to free your vehicle call roadside assistance. See **Roadside Assistance** (page 299).

Driving Hints

Crossing A Ravine, Gully, Ditch, Washout Or Rut

Review the path ahead before attempting to cross any obstacle. Review the obstacle from outside the vehicle for an understanding of the terrain condition in front of and behind the obstacle. Approach obstacles slowly and inch the vehicle over. Ditches and washouts should be crossed at a 45 degree angle when possible.

Driving Over Logs

Review the path ahead before attempting to cross any obstacle. Review the obstacle from outside the vehicle for an understanding of the terrain condition in front of and behind the obstacle.

Approach obstacles slowly and inch the vehicle over, approaching at a 15 degree angle.

Note: *It is best to have a front tire on top of the log when the other begins to climb over.*

If a large obstacle near the log such as a rock cannot be avoided, choose a path that places the rock directly under the tire rather than the undercarriage of the vehicle. This helps prevent damage to the vehicle.

DRIVING THROUGH WATER LIMITATIONS

Model	Maximum Wading Depth
Vehicles without the Sasquatch Package.	31.5 in (800 mm)
Vehicles with the Sasquatch Package.	33.5 in (850 mm)

When you are driving through water do not exceed 4 mph (7 km/h).

OFF-ROAD DRIVING AIDS

Selecting an Off-Road Drive Mode

Using the appropriate drive mode increases your vehicle's control. See **G.O.A.T. Mode Control** (page 242).

Note: *Drive modes are selected by using the Goes Over Any-type of Terrain G.O.A.T. MODES controller.*

Using Four-Wheel Drive

Your vehicle has a four-wheel drive system that offers various modes to help you optimize traction on any off-road surface. See **Four-Wheel Drive** (page 182).

Using the Stabilizer Bar Disconnect

The stabilizer bar disconnect improves suspension articulation, improving traction and comfort in rough terrain.

The vehicle's disconnect system is hydraulically actuated.

Your vehicle is capable of disconnecting under high load. Your vehicle is also capable of reconnecting under all conditions.

It is not necessary for the vehicle to be on level ground in order to reconnect the stabilizer bar. See **Stabilizer Bar Disconnect** (page 214).

Using the Cameras Off-Road

Use the 360 degree camera to enhance your off-road experience. See **360 Degree Camera** (page 229).

Driving Hints

Using the Front and Rear Differential Lock

When engaged, the front and rear differential lock provides additional traction to your vehicle by forcing either the two rear wheels or two front wheels to turn at the same speed.

You can activate and deactivate the front and rear differential lock on the fly within the operating speed range. See **Electronic Locking Differential** (page 190).

Using Trail Control

The system works in a similar manner to cruise control in off-road conditions. Trail Control provides you the ability to maneuver the vehicle without using the throttle and brake pedals.

Trail Control allows you to set a speed between 1 mph (1.6 km/h) to 14 mph (23 km/h) in a forward motion and 1 mph (1.6 km/h) to 5 mph (8 km/h) in reverse. The system controls acceleration and braking in difficult off-road environments, which allows you to focus on steering. See **Trail Control** (page 207).

Trail Control Performance:

- Manages wheel slip to maximize traction.
- Removes the need for you to use both feet when driving in off-road situations.
- Provides braking to maximize traction in descents.
- Gives you confidence in difficult environments.

Using Trail One Pedal Drive

Trail one pedal drive coordinates propulsive and braking torque through your application of the accelerator pedal to simulate a two footed driving technique.

Use this when driving over large obstacles, such as rocks or logs, to help maintain a constant vehicle speed.

In 4H, the system offers lift pedal braking and auto hill hold functionality. See **What Is Trail One Pedal Drive** (page 208).

Note: *Trail one pedal drive is only available when the vehicle is in 4H or 4L.*

Using Trail Turn Assist

The feature reduces the turn radius of the vehicle on off-road surfaces.

The system reduces driver effort to negotiate difficult off-road terrain by allowing the vehicle to make a tight turn in a single maneuver that might otherwise require a three point turn. See **Trail Turn Assist** (page 212).

Note: *Trail turn assist is only available when the vehicle is in 4H or 4L.*

Note: *Trail turn assist cannot activate if the rear differential is locked.*

What Are Rock Rails (if Equipped)

Rock rails protect the rocker and body side from damage and provide a sliding surface to allow the vehicle to cross boulders and rock ledges.

Rock rails also can act as a pivot point to sharply turn the vehicle in tight spaces with high walls or rocks present.

AFTER DRIVING YOUR VEHICLE OFF-ROAD



WARNING: After off-road use, before returning to the road, check the wheels and tires for damage. Off-road use may cause damage to your wheels and tires that can lead to tire failure, loss of vehicle control, serious injury or death.

Driving Hints

Driving off-road places more stress on your vehicle than most on-road driving. After driving off-road, check for damage to the wheels, chassis and underbody.

Inspect the underbody of your vehicle by checking tires, body structure, steering, suspension, and exhaust system for damage.

Inspect the tires for any cuts in the tread or sidewall area. Also inspect the sidewall for any bulge indicating damage to the tire.

Make sure the tires are inflated to proper tire pressure as indicated on the tire placard.

Check the radiator for mud and debris and clean as needed.

Check that the air filter is clean and dry.

Remove accumulations of plants or brush. These things could be a fire hazard or hide damage to the fuel lines, brake hoses and propeller shafts.

Make sure the grille and radiator are clear of any obstructions that may affect cooling.

After extended operation in mud, sand, water, or similar dirty conditions, inspect the wipers and washers to make sure they are working.

Note: *Mud caked windows are hard to see through and can damage wiper blades or motor.*

Check wipers for debris or anything that may scratch the windshield.

If you experience unusual vibration after driving in mud, slush or similar conditions, check the wheels for impacted material. Impacted material can cause vibrations when driving and wheel imbalance. Remove the material to reduce the vibration.

Note: *If you have removed the impacted material from the wheels and your vehicle still has a vibration check your vehicle for damage or see an authorized dealer.*

Inspect the exhaust system for damage or looseness.

Make sure that the brakes are in proper working order and free of any mud, stones and debris, which can become trapped around the brake rotor, backing plate and caliper.

Inspect the wheels for dents, cracks, or other damage.

Inspect undercarriage fasteners. If any are loose or damaged, tighten or replace ensuring that the proper torque specification is used.

Inspect for torn or punctured boots on ball joints, half shafts, steering gears.

Refit the front license plate if removed previously.

DRIVING YOUR VEHICLE AT HIGH SPEEDS

Before off-road driving in unfamiliar areas at high speeds, do a low speed reconnaissance run to become aware of any obstacles that you could encounter.

Your vehicle can incur damage if driven beyond its capabilities. Skid plates and rock rails are designed to help limit damage to vital components and exterior finishes, but cannot prevent all damage if driven in extreme off-road conditions. Damage to skid plates, rock rails and exterior finishes as well as bent, cracked or broken body, frame and chassis components may not be covered by warranty.

It is important that you take the time to become familiar with the controls and dynamics of your vehicle before attempting higher speed off-road driving.

Driving Hints

Some points to consider:

- Slowly build up speed. Initially, drive at a speed that allows ample time to fully assess the terrain around you and to understand how the vehicle responds to both the terrain and your inputs. Increase speed as comfort increases, being mindful of how the vehicle responds to various conditions at different speeds.
- Find a wide open place to experiment with different functions on your vehicle and different driving techniques. Try a given maneuver with different functions, such as drive modes, four-wheel drive modes or switching the electronic locking differential on and off and see how your vehicle responds. If the vehicle is tending to push straight ahead when trying to negotiate a turn, a light application of the brake when turning could help turn your vehicle. A wider entry to a corner or entering a corner more slowly could help your vehicle turn and allow you to apply the throttle sooner after negotiating the turn.
- As speed increases, look farther ahead of the vehicle so that there is time to react to oncoming obstacles. Remember that in many off-road environments, obstacles can be hard to see until they are relatively near. A good strategy is to alternate between looking far ahead and up closer to the front of your vehicle when driving.
- Remember that you may not be the only one in a particular recreational area. Be aware of others in your area. This is especially true of motorcycles and all-terrain vehicles that may be more difficult to spot than a full-sized vehicle.

- When driving in desert conditions, the midpoint of the day is the most difficult time to see many of the small ridges and dips due to flat shadows from the sun being at its highest point. Extreme care should be taken at these times.
- We encourage you to switch on off-road modes for off-road driving. See **G.O.A.T. Mode Control** (page 242).

COLD WEATHER PRECAUTIONS

The functional operation of some components and systems can be affected at temperatures below approximately -13°F (-25°C).

BREAKING-IN

Your vehicle requires a break-in period. For the first 1,000 mi (1,600 km), avoid driving at high speeds, heavy braking, aggressive shifting or using your vehicle to tow. During this time, your vehicle may exhibit some unusual driving characteristics.

DRIVING ECONOMICALLY

The following helps to improve fuel consumption:

- Drive smoothly, accelerate gently and anticipate the road ahead to avoid heavy braking.
- Regularly check your tire pressures and make sure that they are inflated to the correct pressure.
- Follow the recommended maintenance schedule and carry out the recommended checks.

Driving Hints

- Plan your journey and check the traffic before you set off. It is more efficient to combine errands into a single trip whenever possible.
- Avoid idling the engine in cold weather or for extended periods. Start the engine only when you are ready to set off.
- Do not carry unnecessary weight in your vehicle as extra weight wastes fuel.
- Do not add unnecessary accessories to the exterior of your vehicle, for example running boards. If you use a roof rack, remember to fold it down or remove it when not in use.
- Do not shift into neutral when you are braking or when your vehicle is slowing down.
- Shut all windows when driving at high speeds.
- Switch off all electric systems when not in use, for example air conditioning. Make sure that you unplug any accessories from the auxiliary power points when not in use.



WARNING: Secure the floor mat to both retention devices so that it cannot slip out of position and interfere with the pedals. Failure to follow this instruction could result in the loss of control of your vehicle, personal injury or death.



WARNING: Do not place additional floor mats or any other covering on top of the original floor mats. This could result in the floor mat interfering with the operation of the pedals. Failure to follow this instruction could result in the loss of control of your vehicle, personal injury or death.



WARNING: Always make sure that objects cannot fall into the driver foot well while your vehicle is moving. Objects that are loose can become trapped under the pedals causing a loss of vehicle control.

FLOOR MATS



WARNING: Use a floor mat designed to fit the footwell of your vehicle that does not obstruct the pedal area. Failure to follow this instruction could result in the loss of control of your vehicle, personal injury or death.



WARNING: Pedals that cannot move freely can cause loss of vehicle control and increase the risk of serious personal injury.



To install the floor mats, position the floor mat eyelet over the retention post and press down to lock in position.

To remove the floor mat, reverse the installation procedure.

Note: Regularly check the floor mats to make sure they are secure.

Crash and Breakdown Information

ROADSIDE ASSISTANCE

Vehicles Sold in the United States: Getting Roadside Assistance

To fully assist you should you have a vehicle concern, Ford Motor Company offers a complimentary roadside assistance program. This program is separate from the New Vehicle Limited Warranty.

The service is available:

- 24 hours a day, seven days a week.
- For the coverage period supplied with your vehicle.

Roadside Assistance covers:

- A flat tire change with a good spare (except vehicles supplied with a tire inflation kit).
- Battery jump start.
- Lock-out assistance (key replacement cost is the customer's responsibility).
- Fuel delivery — independent service contractors, if not prohibited by state, local or municipal law, shall deliver up to 2 gal (8 L) of gasoline or 5 gal (20 L) of diesel fuel to a disabled vehicle. Roadside assistance limits fuel delivery service to two no-charge occurrences within a 12-month period.
- Winch out — available within 100 ft (30 m) of a paved or county maintained road, no recoveries.

- Towing — independent service contractors, if not prohibited by state, local or municipal law, shall tow Ford eligible vehicles to an authorized dealer within 35 mi (56 km) of the disablement location or to the nearest authorized dealer. If a member requests a tow to an authorized dealer that is more than 35 mi (56 km) from the disablement location, the member shall be responsible for any mileage costs in excess of 35 mi (56 km).
- Roadside Assistance includes up to \$200 for a towed trailer if the disabled eligible vehicle requires service at the nearest authorized dealer. If the towing vehicle is operational but the trailer is not, then the trailer does not qualify for any roadside services.

Vehicles Sold in the United States: Using Roadside Assistance

Complete the roadside assistance identification card and place it in your wallet for quick reference. This card is in the Owner's Manual kit.

United States vehicle customers who require Roadside Assistance, call 1-800-241-3673.

If you need to arrange roadside assistance for yourself, Ford Motor Company reimburses a reasonable amount for towing to the nearest dealership within 35 mi (56 km). To obtain reimbursement information, United States vehicle customers call 1-800-241-3673. Customers need to submit their original receipts.

Crash and Breakdown Information

Vehicles Sold in Canada: Getting Roadside Assistance

To fully assist you should you have a vehicle concern, Ford Motor Company of Canada, Limited offers a complimentary roadside assistance program. This program is eligible within Canada or the continental United States.

The service is available 24 hours a day, seven days a week.

This program is separate from the New Vehicle Limited Warranty, but the coverage is concurrent with the powertrain coverage period of your vehicle. Canadian roadside coverage and benefits may differ from the U.S. coverage.

If you require more information, please call us in Canada at 1-800-665-2006, or visit our website at www.ford.ca.

SWITCHING THE HAZARD FLASHERS ON AND OFF



The hazard flasher button is on the instrument panel. Press the button to switch the hazard flashers on if your vehicle is creating a safety hazard for other road users.

When you switch the hazard flashers on, all front and rear direction indicators flash.

Note: *The hazard flashers operate when the ignition is in any position, or if the key is not in the ignition. The battery loses charge and could have insufficient power to restart your vehicle.*

Press the button again to switch them off.

JUMP STARTING THE VEHICLE

JUMP STARTING PRECAUTIONS



WARNING: Batteries normally produce explosive gases which can cause personal injury. Therefore, do not allow flames, sparks or lighted substances to come near the battery. When working near the battery, always shield your face and protect your eyes. Always provide correct ventilation.



WARNING: Keep batteries out of reach of children. Batteries contain sulfuric acid. Avoid contact with skin, eyes or clothing. Shield your eyes when working near the battery to protect against possible splashing of acid solution. In case of acid contact with skin or eyes, flush immediately with water for a minimum of 15 minutes and get prompt medical attention. If acid is swallowed, call a physician immediately.



WARNING: Use only adequately sized cables with insulated clamps.



WARNING: Make sure that the cables are clear of any moving parts and fuel delivery system parts.



WARNING: Connect batteries with only the same nominal voltage.



WARNING: If the engine is running while the hood is open, stay clear of moving engine components. Failure to follow this warning could result in serious personal injury or death.

Do not attempt to push-start an automatic transmission vehicle. This could cause transmission damage.

Crash and Breakdown Information

Do not disconnect the battery of the disabled vehicle. This could damage your vehicle's electrical system.

PREPARING THE VEHICLE

Use only a 12 volt supply to start your vehicle.

Park the booster vehicle close to the hood of the disabled vehicle, making sure the two vehicles do not touch.

JUMP STARTING THE VEHICLE

Connecting the Jumper Cables



WARNING: Do not connect the negative jumper cable to any other part of your vehicle. Use the ground point.

Note: If you are using a jump pack or booster box, follow the manufacturer's instructions.

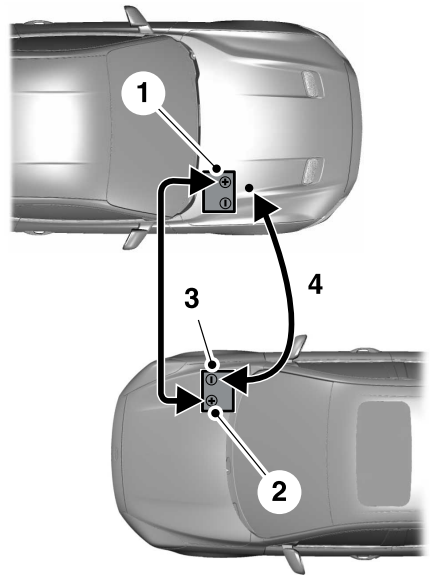

1. Pull the red rubber boot backward. Connect the positive (+) jumper cable to the positive (+) terminal of the discharged battery.
2. Connect the other end of the positive (+) jumper cable to the positive (+) terminal of the booster vehicle battery.
3. Connect the negative (-) jumper cable to the negative (-) terminal of the booster vehicle battery.
4. Make the final connection of the negative (-) jumper cable to an exposed metal part of the disabled vehicle's engine, as shown in the following illustration, away from the battery and fuel injection system, or connect the negative (-) jumper cable to a ground connection point if available.

Crash and Breakdown Information

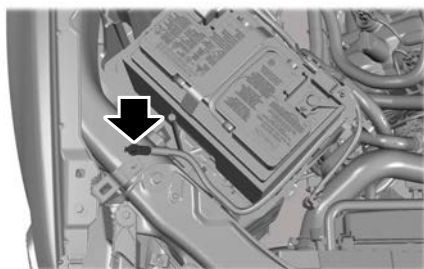

HOW DOES THE POST-CRASH ALERT SYSTEM WORK

The system is designed to turn the hazard flashers on and to intermittently sound the horn in the event of a serious impact that deploys an airbag or the seatbelt pretensioners.

POST-CRASH ALERT SYSTEM LIMITATIONS

Depending on applicable laws in the country your vehicle was built for, the horn does not sound in the event of a serious impact.

SWITCHING THE POST-CRASH ALERT SYSTEM OFF

Press the hazard flasher switch or the unlock button on the remote control to switch the system off.

Note: *The alert turns off when the vehicle battery runs out of charge.*

AUTOMATIC CRASH SHUTOFF

WHAT IS AUTOMATIC CRASH SHUTOFF

The automatic crash shutoff is designed to stop the fuel going to the engine in the event of a moderate or severe crash.

Note: *Not every impact causes a shutoff.*

Starting the Engine

1. Start the engine of the booster vehicle and moderately rev the engine, or gently press the accelerator to keep the engine speed between 2000 and 3000 RPM, as shown in your tachometer.
2. Start the engine of the disabled vehicle.
3. Once you start the disabled vehicle, run both vehicle engines for an additional three minutes before disconnecting the jumper cables.

Removing the Jumper Cables

Remove the jumper cables in the reverse order that they were connected.

Note: *Do not switch the headlamps on when disconnecting the cables. The peak voltage could blow the bulbs.*

POST-CRASH ALERT SYSTEM

WHAT IS THE POST-CRASH ALERT SYSTEM

The system helps draw attention to your vehicle in the event of a serious impact.

Crash and Breakdown Information

AUTOMATIC CRASH SHUTOFF PRECAUTIONS



WARNING: If your vehicle has been involved in a crash, have the fuel system checked. Failure to follow this instruction could result in fire, personal injury or death.

RE-ENABLING YOUR VEHICLE

1. Switch the ignition off.
2. Attempt to start your vehicle.
3. Switch the ignition off.
4. Attempt to start your vehicle.

Note: If your vehicle does not start after the third attempt, have your vehicle checked as soon as possible.

RECOVERY TOWING

ACCESSING THE FRONT TOWING POINT



WARNING: Using recovery hooks is dangerous and should only be done by a person familiar with proper vehicle recovery safety practices. Improper use of recovery hooks may cause hook failure or separation from the vehicle and could result in serious injury or death.



WARNING: Slowly remove the slack from the recovery strap prior to pulling. Failure to do so can introduce significantly higher loads which can cause the recovery hooks to break off, or the recovery strap to fail which can cause serious injury or death.



WARNING: Never link two straps together with a clevis pin. These heavy metal objects could become projectiles if the strap breaks and can cause serious injury or death.

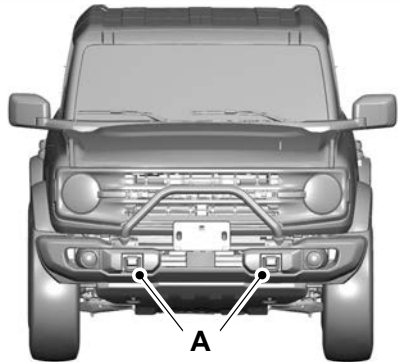

- A. Front recovery hooks.

Note: Do not apply a load to the recovery hooks that is greater than the gross vehicle weight rating of your vehicle.

Before using recovery hooks:

- Make sure all attaching points are secure and capable of withstanding the applied load.
- Do not use chains, cables or tow straps with metal hook ends.
- Only use recovery straps that have a minimum breaking strength two to three times the gross vehicle weight of the stuck vehicle.
- Make sure the recovery strap is in good condition and free of visible cuts, tears or damage.

Crash and Breakdown Information

- Use a damper device such as a tarp, heavy blanket or piece of carpet, and place it over the recovery strap to help absorb the energy in the event the strap breaks.
- Make sure the stuck vehicle is not loaded heavier than its gross vehicle weight rating specified on the certification label.
- Align the tow vehicle and stuck vehicle in a straight line, within 10 degrees.
- Keep bystanders to the sides of the vehicle, at a distance of at least twice the length of the recovery strap. This helps avoid injury from the hazard of a recovery hook or strap breaking, or a vehicle lurching into their path.

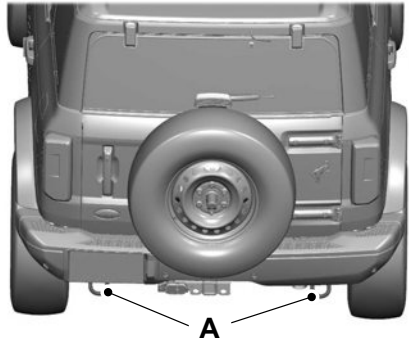

A. Rear recovery hooks.

Note: Do not apply a load to the recovery hooks that is greater than the gross vehicle weight rating of your vehicle.

Before using recovery hooks:

- Make sure all attaching points are secure and capable of withstanding the applied load.
- Do not use chains, cables or tow straps with metal hook ends.
- Only use recovery straps that have a minimum breaking strength two to three times the gross vehicle weight of the stuck vehicle.
- Make sure the recovery strap is in good condition and free of visible cuts, tears or damage.
- Use a damper device such as a tarp, heavy blanket or piece of carpet, and place it over the recovery strap to help absorb the energy in the event the strap breaks.
- Make sure the stuck vehicle is not loaded heavier than its gross vehicle weight rating specified on the certification label.

ACCESSING THE REAR TOWING POINT



WARNING: Using recovery hooks is dangerous and should only be done by a person familiar with proper vehicle recovery safety practices. Improper use of recovery hooks may cause hook failure or separation from the vehicle and could result in serious injury or death.



WARNING: Slowly remove the slack from the recovery strap prior to pulling. Failure to do so can introduce significantly higher loads which can cause the recovery hooks to break off, or the recovery strap to fail which can cause serious injury or death.



WARNING: Never link two straps together with a clevis pin. These heavy metal objects could become projectiles if the strap breaks and can cause serious injury or death.

Crash and Breakdown Information

- Align the tow vehicle and stuck vehicle in a straight line, within 10 degrees.
- Keep bystanders to the sides of the vehicle, at a distance of at least twice the length of the recovery strap. This helps avoid injury from the hazard of a recovery hook or strap breaking, or a vehicle lurching into their path.

TRANSPORTING THE VEHICLE

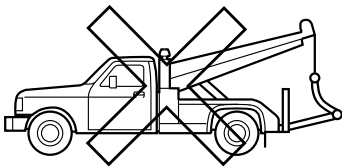
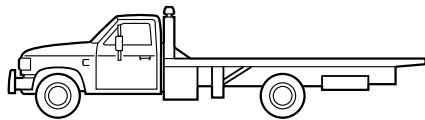
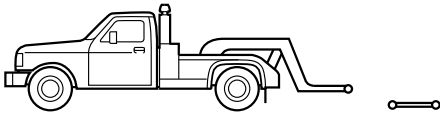

We recommend the use of a wheel lift and dollies or flatbed equipment to tow your vehicle. Vehicle damage could occur if towed incorrectly, or by any other means.

Make sure front-wheel and rear-wheel drive vehicles have their designated drive wheels off the ground regardless of towing direction. Use tow dollies to prevent damage to the transmission.

We recommend towing a four-wheel drive vehicle with all wheels off the ground, such as using a wheel lift and dollies or flatbed equipment. However, it is acceptable to use a wheel lift to raise the rear of your vehicle so long as, depending on vehicle configuration, you perform the following before towing:

- If your vehicle has an electronic shift-on-the-fly transfer case, make sure you switch the four-wheel drive control to the **2H** position before towing.

Note: Towing an electronic shift-on-the-fly four-wheel drive vehicle with the front wheels on the ground without disengaging the front hubs could cause damage to the automatic transmission.

Note: Towing a two-wheel drive vehicle or an electronic shift-on-the-fly four-wheel drive vehicle with the rear wheels on the ground for more than 50 mi (80 km) or faster than 35 mph (56 km/h) could cause damage to the automatic transmission.

If you need to tow your vehicle, contact a professional towing service or your roadside assistance service provider.

Your manufacturer produces a towing manual for all authorized tow truck operators. Have your tow truck operator refer to this manual for proper hook-up and towing procedures.

Towing Your Vehicle

TOWING YOUR VEHICLE PRECAUTIONS

Use the following guidelines when towing your vehicle. Failure to follow this instruction could result in vehicle damage not covered by the vehicle warranty.

Note: Make sure you properly secure your vehicle to the tow vehicle.

Note: If you are unsure of the vehicle's configuration, contact an authorized dealer.

RECREATIONALLY TOWING YOUR VEHICLE - MANUAL TRANSMISSION



WARNING: Do not disconnect the battery when recreationally towing your vehicle. This prevents the transfer case from shifting properly and could cause the vehicle to roll, even if the transmission is in gear.



WARNING: Placing the transfer case in its neutral position could cause your vehicle to freely roll. Make sure you press and hold the brake pedal and the vehicle is in a secure, safe position when you place the transfer case in its neutral position.

Follow these guidelines if you have a need for recreational towing. An example of recreational towing would be towing your vehicle behind a motorhome. These guidelines are to make sure that you do not damage the transmission.

You can only tow your vehicle with all four wheels on the ground by placing the transfer case in its neutral position by engaging the recreational tow feature. Perform the following steps after positioning your vehicle behind the tow vehicle and properly securing them together.

Note: Put your climate control system in recirculated air mode to prevent exhaust fumes from entering your vehicle.

Note: Failure to put the transfer case in its neutral position can damage vehicle components.

Note: You can check the towing status at any time by opening the driver door or turning the ignition to the accessory or on position. **Neutral Tow Enabled Leave Transmission in Neutral** appears in the instrument cluster display to confirm you can recreationally tow your vehicle.

Note: If your vehicle has an anti-theft alarm, make sure you switch perimeter sensing on when towing.

Note: A tone could sound for up to 30 minutes if you recreationally tow with the doors removed.

Switching Neutral Tow On

1. Switch your vehicle to accessory mode by pressing the push button ignition switch without pressing any pedals.
2. Press the **2H** button on the four-wheel drive mode control.
3. Leave the gearshift lever in the neutral position and fully press and hold both the clutch and the brake pedal.
4. Using the instrument cluster controls on the steering wheel, select **Settings**.
5. Select **Neutral Tow**.
6. Press and hold the **OK** button until a confirmation message appears in the information display.

Towing Your Vehicle

Note: If completed successfully, the information display shows **Neutral Tow Enabled Leave Transmission in Neutral**. This indicates that your vehicle is safe to tow with all wheels on the ground.

Note: If you do not see a confirmation message in the instrument cluster display, you must perform the procedure again from the beginning.

Note: You may hear noise as the transfer case shifts into its neutral position. This is normal.

7. Release both the clutch and the brake pedals and leave the gearshift lever in the neutral position.
8. Switch your vehicle off by pressing the push button ignition switch once without pressing any pedals.

Switching Neutral Tow Off

1. With your vehicle properly secured to the tow vehicle, switch your vehicle to accessory mode by pressing the push button ignition switch without pressing any pedals.
2. Starting with both the brake and clutch pedal released, fully press and hold both pedals at the same time for approximately seven seconds. Continue holding both pedals until the instrument cluster display shows **2H** and **Neutral Tow Disabled**.

Note: If completed successfully, the instrument cluster displays **2H** and **Neutral Tow Disabled**.

Note: You must perform the switching neutral tow on and switching neutral tow off procedures again from the beginning if the indicator light and message do not display.

Note: You may hear a noise as the transfer case shifts out of its neutral position. This is normal.

3. Release the pedals.

4. Apply the parking brake, then disconnect your vehicle from the tow vehicle.
5. Release the parking brake, start your vehicle, and shift into either a forward or a reverse gear to make sure the transfer case is out of the neutral tow position.
6. If the transfer case did not successfully shift out of its neutral position, set the parking brake. Have your vehicle checked as soon as possible.

Resolving the Shift Delayed Drive Forward Message

1. Fully press and hold both the brake and the clutch pedals.
2. Press the push button ignition switch.
3. With the vehicle running, shift into a forward gear and release the clutch. Let the vehicle roll forward up to 3 ft (1 m).

Note: You may hear a noise as the transfer case shifts out of its neutral position. This is normal.

4. Make sure the instrument cluster displays **Neutral Tow Disabled**.

RECREATIONALLY TOWING YOUR VEHICLE - AUTOMATIC TRANSMISSION



WARNING: Do not disconnect the battery when recreationally towing your vehicle. This prevents the transfer case from shifting properly and could cause the vehicle to roll, even if the transmission is in park (P).

Towing Your Vehicle



WARNING: Placing the transfer case in its neutral position could cause your vehicle to freely roll. Make sure you press and hold the brake pedal and the vehicle is in a secure, safe position when you place the transfer case in its neutral position.

Follow these guidelines if you have a need for recreational towing. An example of recreational towing would be towing your vehicle behind a motorhome. These guidelines are to make sure that you do not damage the transmission.

You can only tow your vehicle with all four wheels on the ground by placing the transfer case in its neutral position by engaging the recreational tow feature. Perform the following steps after positioning your vehicle behind the tow vehicle and properly securing them together.

Note: Put your climate control system in recirculated air mode to prevent exhaust fumes from entering your vehicle.

Note: Failure to put the transfer case in its neutral position can damage vehicle components.

Note: You can check the towing status at any time by opening the driver door or turning the ignition to the accessory or on position. **Neutral Tow Enabled Leave Transmission in Neutral** appears in the instrument cluster display to confirm you can recreationally tow your vehicle.

Note: If your vehicle has an anti-theft alarm, make sure you switch perimeter sensing on when towing.

Note: A tone could sound for up to 30 minutes if you recreationally tow with the doors removed.

Switching Neutral Tow On

1. Switch your vehicle to accessory mode by pressing the push button ignition switch without pressing any pedals.
2. Press the **2H** button on the four-wheel drive mode control.
3. Fully press and hold the brake pedal and shift the transmission to neutral (N).
4. Using the instrument cluster controls on the steering wheel, select **Settings**.
5. Select **Neutral Tow**.
6. Press and hold the **OK** button until a confirmation message appears in the information display.

Note: If completed successfully, the information display shows **Neutral Tow Enabled Leave Transmission in Neutral**. This indicates that your vehicle is safe to tow with all wheels on the ground.

Note: If you do not see a confirmation message in the instrument cluster display, perform the procedure again from the beginning.

Note: You may hear noise as the transfer case shifts into its neutral position. This is normal.

7. Release the brake pedal and leave the transmission in neutral (N).
8. Switch your vehicle off by pressing the push button ignition switch once without pressing any pedals.

Switching Neutral Tow Off

1. With your vehicle properly secured to the tow vehicle, switch your vehicle to accessory mode by pressing the push button ignition switch without pressing any pedals.

Towing Your Vehicle

- Starting with the brake pedal released and the transmission in neutral (N), fully press and hold the brake pedal for approximately seven seconds and shift the transmission to park (P). Continue holding the brake pedal until the instrument cluster display shows **2H** and **Neutral Tow Disabled**.
 - If the transfer case did not successfully shift out of its neutral position, set the parking brake. Have your vehicle checked as soon as possible.
- Resolving the Shift Delayed Drive Forward Message**
- Fully press and hold the brake pedal.
 - Press the push button ignition switch.
 - With the vehicle running, shift into drive (D). Let the vehicle roll forward up to 3 ft (1 m).
- Note:** You could hear a noise as the transfer case shifts out of its neutral position. This is normal.
- Make sure the instrument cluster displays **Neutral Tow Disabled**.
- Note:** If completed successfully, the instrument cluster displays **2H** and **Neutral Tow Disabled**.
- Note:** Perform the switching neutral tow on and switching neutral tow off procedures again from the beginning if the indicator light and message do not display.
- Note:** You could hear a noise as the transfer case shifts out of its neutral position. This is normal.
- Release the brake pedal.
 - Apply the parking brake, then disconnect your vehicle from the tow vehicle.
 - Release the parking brake, start your vehicle, and shift into either drive (D) or reverse (R) to make sure the transfer case is out of the neutral tow position.

EMERGENCY TOWING

If you need to tow your vehicle, contact a professional towing service or, if you are a member of a roadside assistance program, your roadside assistance service provider.

TOWING YOUR VEHICLE – TROUBLESHOOTING

TOWING YOUR VEHICLE – INFORMATION MESSAGES

Message	Description
Neutral Tow Enabled Leave Transmission in Neutral	The transfer case is in the neutral position and your vehicle is safe to tow with all four wheels on the ground.
Shift Delayed Drive Forward	There is a transfer case gear tooth blockage present. With your vehicle on, shift the transmission into drive (D) and let the vehicle roll forward, up to 3 ft (1 m).
Neutral Tow Disabled	The transfer case is not in the neutral position and your vehicle is not safe to tow with all four wheels on the ground.

Fuses

FUSE PRECAUTIONS



WARNING: Always disconnect the battery before servicing high current fuses.



WARNING: To reduce risk of electrical shock, always replace the cover to the power distribution box before reconnecting the battery or refilling fluid reservoirs.



WARNING: Always replace a fuse with one that has the specified amperage rating. Using a fuse with a higher amperage rating can cause severe wire damage and could start a fire.

UNDER HOOD FUSE BOX

LOCATING THE UNDER HOOD FUSE BOX

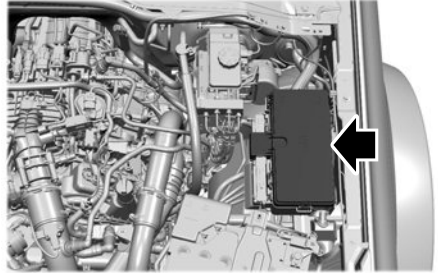

ACCESSING THE UNDER HOOD FUSE BOX

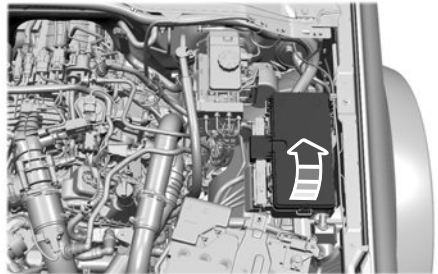

Fuses

IDENTIFYING THE FUSES IN THE UNDER HOOD FUSE BOX

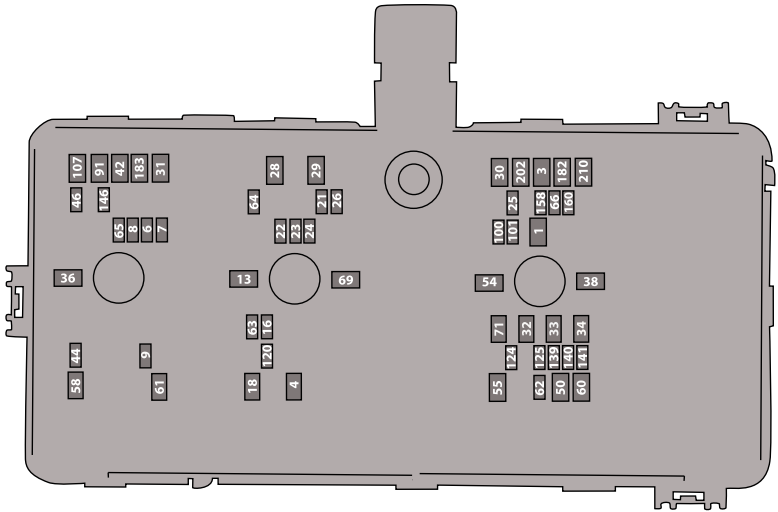

Item	Rating	Protected Component
1	30 A	Body control module - battery power in feed 1.
3	30 A	Body control module - battery power in feed 2.
4	30 A	Fuel pump.
6	25 A	Powertrain control module power.
7	30 A	Powertrain components.
8	20 A	Powertrain components.
9	20 A	Ignition coils.
13	40 A	Blower motor.
16	10 A	Rear windshield washer.
18	30 A	Starter motor.

Fuses

Item	Rating	Protected Component
21	10 A	Not used (spare).
22	10 A	360 degree camera module.
23	10 A	Anti-lock brake system run-start feed.
24	10 A	Powertrain control module. Power steering module.
25	10 A	Blind spot information system. Rear view camera. Adaptive cruise control. Driveline control module.
26	15 A	Transmission control module.
28	60 A	Anti-lock brake system valves.
29	60 A	Anti-lock brake system pump.
30	30 A	Driver power seat.
31	30 A	Passenger power seat.
32	20 A	Auxiliary power point.
33	20 A	Auxiliary power point.
34	20 A	Auxiliary power point.
36	40 A	150 watt DC/AC inverter.
38	30 A	Heated seat module.
42	30 A	Trailer brake control module.
44	10 A	Brake on-off switch.
46	20 A	SYNC module.
50	40 A	Heated rear windshield.
54	40 A	Driveline control module.
55	30 A	Trailer tow park lamp relay.

Fuses

Item	Rating	Protected Component
58	20 A	Trailer tow backup lamps.
60	30 A	Upfitter switch #1.
61	15 A	Upfitter switch #2.
62	10 A	Upfitter switch #3.
63	10 A	Upfitter switch #4.
64	10 A	Upfitter switch #5.
65	10 A	Upfitter switch #6.
66	10 A	Stability bar disconnect module.
69	30 A	Front windshield wiper.
71	30 A	Rear windshield wiper.
91	40 A	Trailer tow light module.
100	20 A	Left-hand headlamps.
101	20 A	Right-hand headlamps.
107	30 A	Trailer tow battery charge.
120	10 A	Fuel injectors (2.7L).
124	5 A	Not used (spare).
125	10 A	USB smart charger 1.
139	5 A	USB smart charger 2.
140	5 A	Not used (spare).
141	5 A	Not used (spare).
146	20 A	Amplifier.
158	10 A	Stability bar disconnect module run/start.
160	10 A	Smart data link control.
182	60 A	Driver door module.

Fuses

Item	Rating	Protected Component
183	60 A	Passenger door module.
202	60 A	Body control module B+.
210	30 A	Body control module start stop.

BODY CONTROL MODULE FUSE BOX

LOCATING THE BODY CONTROL MODULE FUSE BOX

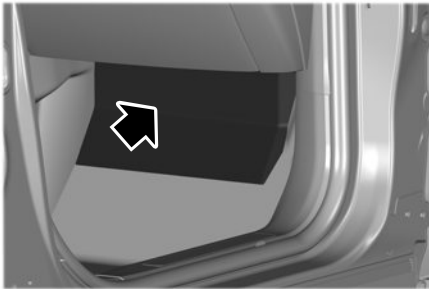

ACCESSING THE BODY CONTROL MODULE FUSE BOX

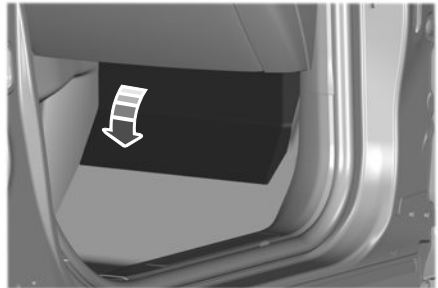

Fuses

IDENTIFYING THE FUSES IN THE BODY CONTROL MODULE FUSE BOX

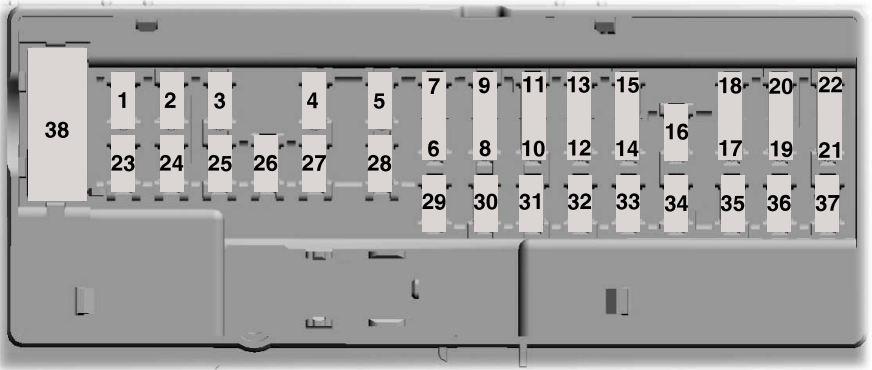

Item	Rating	Protected Component
1	—	Not used.
2	10 A	Power windows. DC/AC inverter.
3	7.5 A	Exterior mirrors. Wireless charging module.
4	20 A	Not used (spare).
5	—	Not used.
6	10 A	Anti-theft alarm horn.
7	10 A	Not used.
8	5 A	Not used (spare).
9	5 A	Not used (spare).
10	—	Not used.
11	—	Not used.
12	7.5 A	Climate control. Gateway module.

Fuses

Item	Rating	Protected Component
13	7.5 A	Steering column control module. Instrument cluster module.
14	15 A	Not used (spare).
15	15 A	Not used (spare).
16	—	Not used.
17	7.5 A	Not used (spare).
18	7.5 A	Not used (spare).
19	5 A	Ignition switch. Headlamps.
20	5 A	Telematics modem.
21	5 A	In-vehicle temperature and humidity sensor.
22	5 A	Not used.
23	30 A	Not used (spare).
24	30 A	Not used (spare).
25	20 A	Not used (spare).
26	30 A	Not used (spare).
27	30 A	Not used (spare).
28	30 A	Not used (spare).
29	15 A	Not used (spare).
30	5 A	Brake on-off switch.
31	10 A	Terrain management switch. Integrated control panel switch. Driveline and chassis controls switch panel. 12 inch center display. Radio frequency receiver module.
32	20 A	Audio control module.

Fuses

Item	Rating	Protected Component
33	—	Not used.
34	30 A	Run/start relay.
35	5 A	Not used (spare).
36	15 A	Automatic high beam. Image processing module A.
37	20 A	Auto-dimming interior mirror. Parking assist control module. Heated steering wheel.
38	30 A Circuit Breaker	Not used.

IDENTIFYING FUSE TYPES

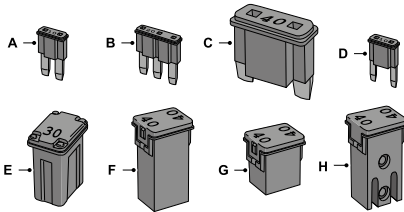

- A Micro 2.
- B Micro 3.
- C Maxi.
- D Mini.
- E M Case.
- F J Case.
- G J Case Low Profile.
- H Slotted M Case.

FUSES – TROUBLESHOOTING

FUSES – FREQUENTLY ASKED QUESTIONS

When do I need to check a fuse?

If electrical components in the vehicle are not working.

When do I need to replace a fuse?

If a fuse has blown.

How do I identify a blown fuse?

You can identify a blown fuse by a broken wire within the fuse.

Maintenance

MAINTENANCE PRECAUTIONS

Service your vehicle regularly to help maintain its roadworthiness and resale value. There is a large network of authorized dealers that are there to help you with their professional servicing expertise. We believe that their specially trained technicians are best qualified to service your vehicle properly and expertly. They are supported by a wide range of highly specialized tools developed specifically for servicing your vehicle.

If your vehicle requires professional service, an authorized dealer can provide the necessary parts and service. Check your warranty information to find out which parts and services are covered.

Use only recommended fuels, lubricants, fluids and service parts conforming to specifications. See **Capacities and Specifications** (page 393).

- Do not work on a hot engine.
- Make sure that nothing gets caught in moving parts.
- Do not work on a vehicle with the engine running in an enclosed space, unless you are sure you have enough ventilation.
- Keep all open flames and other burning material, such as cigarettes, away from the battery and all fuel related parts.
- Set the parking brake, shift the transmission to park (P) and block the wheels.

OPENING AND CLOSING THE HOOD

Opening the Hood

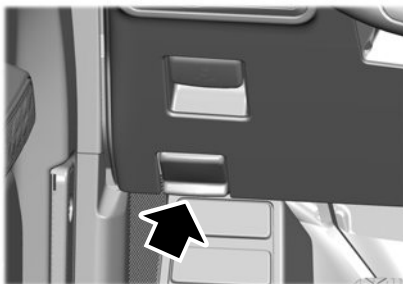

1. Pull the hood release handle under the left-hand side of the instrument panel.

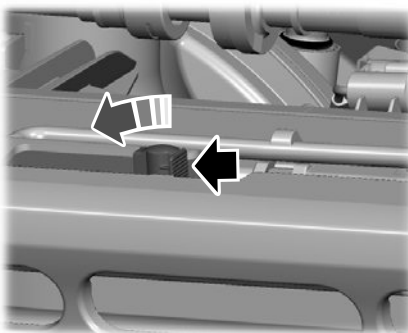

2. Release the hood latch by pushing the secondary release lever to your left-hand side.

Maintenance

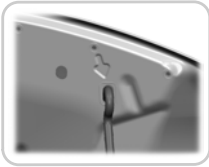

3. Open the hood and support it with the hood strut.

Closing the Hood

 **WARNING:** Make sure that you fully latch the hood before driving. Failure to follow this instruction could result in personal injury or death.

1. Fully stow the strut prior to lowering the hood.
2. To close, lower the hood and make sure that it fully latches.

UNDER HOOD OVERVIEW - 2.3L ECOBOOST™

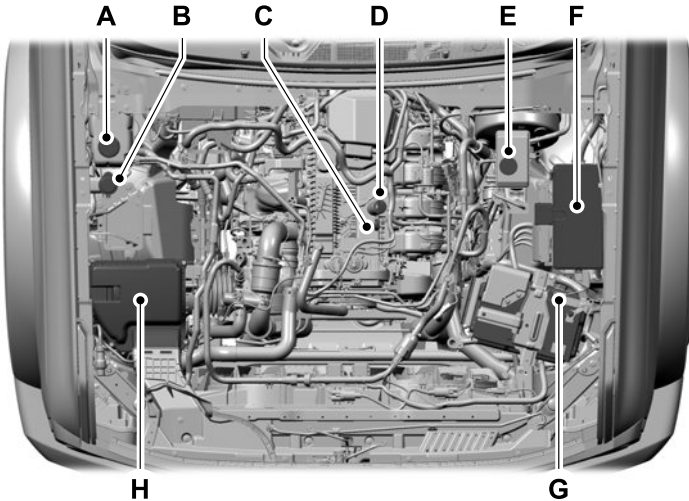

- A Engine coolant reservoir. See **Checking the Coolant** (page 322).
- B Windshield washer fluid reservoir. See **Adding Washer Fluid** (page 93).
- C Engine oil dipstick. See **Engine Oil Dipstick Overview** (page 321).

Maintenance

- D Engine oil filler cap. See **Adding Engine Oil** (page 321).
- E Brake fluid reservoir. See **Locating the Brake Fluid Reservoir** (page 194).
- F Engine compartment fuse box. See **Locating the Under Hood Fuse Box** (page 310).
- G Battery. See **Changing the 12V Battery** (page 326).
- H Air filter assembly. See **Changing the Engine Air Filter** (page 326).

UNDER HOOD OVERVIEW - 2.7L ECOBOOST™

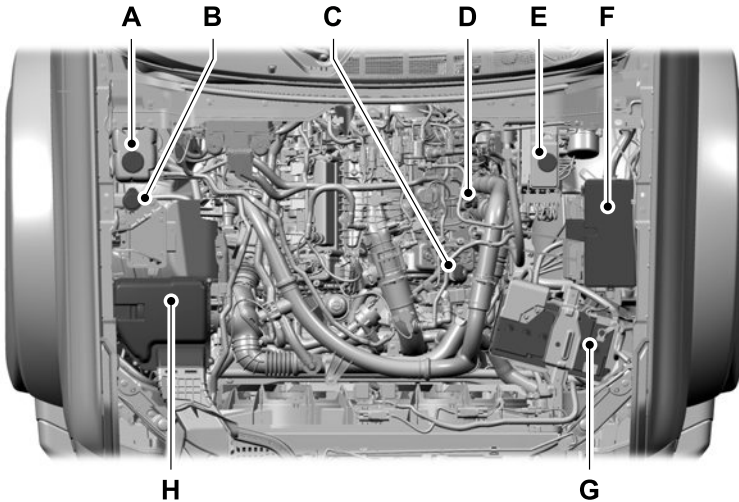

- A Engine coolant reservoir. See **Checking the Coolant** (page 322).
- B Windshield washer fluid reservoir. See **Adding Washer Fluid** (page 93).
- C Engine oil filler cap. See **Adding Engine Oil** (page 321).
- D Engine oil dipstick. See **Engine Oil Dipstick Overview** (page 321).
- E Brake fluid reservoir. See **Locating the Brake Fluid Reservoir** (page 194).
- F Engine compartment fuse box. See **Locating the Under Hood Fuse Box** (page 310).

Maintenance

- G Battery. See **Changing the 12V Battery** (page 326).
- H Air filter assembly. See **Changing the Engine Air Filter** (page 326).

ENGINE OIL

ENGINE OIL DIPSTICK OVERVIEW

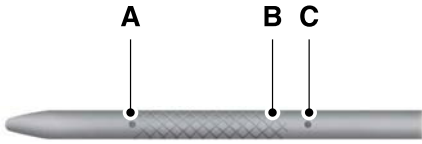

- A Minimum.
- B Nominal.
- C Maximum.

CHECKING THE ENGINE OIL LEVEL

1. Make sure that your vehicle is on level ground.
2. Check the oil level before starting the engine, or switch the engine off after warming up and wait 10 minutes for the oil to drain into the oil pan.
3. Remove the dipstick and wipe it with a clean, lint-free cloth.
4. Reinstall the dipstick and make sure it is fully seated.
5. Remove the dipstick again to check the oil level.

Note: *If the oil level is between the maximum and minimum marks, the oil level is acceptable. Do not add oil.*

6. If the oil level is at the minimum mark, immediately add oil.
7. Reinstall the dipstick. Make sure it is fully seated.

Note: *The oil consumption of new engines reaches its normal level after approximately 3,000 mi (5,000 km).*

ADDING ENGINE OIL

 **WARNING:** Do not remove the filler cap when the engine is running.

 **WARNING:** Do not add engine oil when the engine is hot. Failure to follow this instruction could result in personal injury.

Do not use supplemental engine oil additives because they are unnecessary and could lead to engine damage that the vehicle warranty may not cover.

1. Clean the area surrounding the engine oil filler cap before you remove it.
2. Remove the engine oil filler cap.
3. Add engine oil that meets our specifications. See **Capacities and Specifications** (page 393).
4. Reinstall the engine oil filler cap. Turn it clockwise until you feel a strong resistance.

Note: *Do not add oil further than the maximum mark. Oil levels above the maximum mark may cause engine damage.*

Note: *Immediately soak up any oil spillage with an absorbent cloth.*

Maintenance

RESETTING THE ENGINE OIL CHANGE REMINDER

Use the information display controls on the steering wheel to reset the oil change reminder.

From the main menu scroll to:

Message	Action and Description
Settings	Press the right arrow button, then from this menu scroll to the following message.
Convenience	Press the right arrow button, then from this menu scroll to the following message.
Oil Life Reset	Press the right arrow button, then from this menu scroll to the following message.
Hold OK to Reset	Press and hold the OK button until the instrument cluster displays the following message.
	Reset Successful
	When the oil change reminder resets the instrument cluster displays 100%. Remaining Life {00}%
	If the instrument cluster displays one of the following messages, repeat the process. Not Reset Reset Cancelled

ENGINE OIL CAPACITY AND SPECIFICATION

For filling information, please refer to the Capacities and Specifications section of your owner's manual. See **Engine Oil Capacity and Specification** (page 398).

CHECKING THE COOLANT

When the engine is cold, check the concentration and level of the coolant at the intervals listed in the scheduled maintenance information. See **Scheduled Maintenance** (page 452).

Note: Make sure that the coolant level is between the minimum and maximum marks on the coolant reservoir.

Note: Coolant expands when it is hot. The level may extend beyond the **MAX** mark.

If the coolant level is at or below the minimum mark, add prediluted coolant immediately.

Maintain coolant concentration within 48% to 50%, which equates to a freeze point between -29°F (-34°C) and -35°F (-37°C). Coolant concentration should be checked using a refractometer. We do not recommend the use of hydrometers or coolant test strips for measuring coolant concentration.

Adding Coolant



WARNING: Do not remove the coolant reservoir cap when the engine is on or the cooling system is hot. Wait 10 minutes for the cooling system to cool down. Cover the coolant reservoir cap with a thick cloth to prevent the possibility of scalding and slowly remove the cap. Failure to follow this instruction could result in personal injury.

Maintenance



WARNING: Do not add engine coolant when the engine is on or the cooling system is hot. Failure to follow this instruction could result in personal injury.



WARNING: Do not add coolant further than the **MAX** mark.



WARNING: Do not put coolant in the windshield washer reservoir. If sprayed on the windshield, coolant could make it difficult to see through the windshield.

Note: Do not use stop leak pellets, cooling system sealants, or non-specified additives as they can cause damage to the engine cooling or heating systems. Resulting component damage may not be covered by the vehicle Warranty.

Note: Automotive fluids are not interchangeable.

It is very important to use prediluted coolant approved to the correct specification in order to avoid plugging the small passageways in the engine cooling system. See **Capacities and Specifications** (page 393). Do not mix different colors or types of coolant in your vehicle. Mixing of engine coolants or using an incorrect coolant may harm the engine or cooling system components and could void the vehicle Warranty.

Note: If prediluted coolant is not available, use the approved concentrated coolant diluting it to 50/50 with deionized or distilled water. See **Capacities and Specifications** (page 393). Using water that has not been deionized may contribute to deposit formation, corrosion and plugging of the small cooling system passageways.

To top up the coolant level do the following:

1. Unscrew the cap slowly. Any pressure escapes as you unscrew the cap.
2. Add enough prediluted coolant to reach the correct level.

Note: We do not recommend the use of recycled coolant.

3. Replace the coolant reservoir cap. Turn the cap clockwise until it contacts the hard stop.
4. Check the coolant level in the coolant reservoir the next few times you drive your vehicle. If necessary, repeat step 2.

If you have to add more than 1.1 qt (1 L) of engine coolant per month, have your vehicle checked as soon as possible. Operating an engine with a low level of coolant can result in engine overheating and possible engine damage.

In case of emergency, you can add a large amount of water without engine coolant in order to reach a vehicle service location. Service your vehicle as soon as possible.

Water alone, without engine coolant, can cause engine damage from corrosion, overheating or freezing.

Do not use the following as a coolant substitute, as they can cause engine damage from overheating or freezing:

- Alcohol.
- Methanol.
- Brine.
- Any coolant mixed with alcohol or methanol antifreeze.

Do not add extra inhibitors or additives to the coolant. These can be harmful and compromise the corrosion protection of the coolant.

Maintenance

Severe Climates

If you drive in extremely cold climates, you may need to increase the coolant concentration above 50%.

Note: A coolant concentration of 60% provides improved freeze point protection. Coolant concentrations above 60% decrease the overheat protection characteristics of the coolant and could cause engine damage.

If you drive in extremely hot climates, you may need to decrease the coolant concentration to 40%.

Note: A coolant concentration of 40% provides improved overheat protection. Coolant concentrations below 40% decrease the overheat and corrosion protection characteristics of the coolant and could cause engine damage.

Coolant Change

Change the coolant at specific mileage intervals. Refer to the scheduled maintenance information. See **Normal Scheduled Maintenance** (page 455).

Note: Dispose of used coolant in the appropriate manner.

Follow your community's regulations and standards for recycling and disposing of automotive fluids.

Fail-Safe Cooling

Fail-safe cooling allows you to temporarily drive your vehicle before any incremental component damage occurs. The fail-safe distance depends on ambient temperature, vehicle load and terrain.

How Fail-Safe Cooling Works



If the engine begins to overheat, the coolant temperature gauge moves toward the red zone:



A warning lamp illuminates and a message may appear in the information display.

If the engine reaches a preset over-temperature condition, the engine automatically switches to alternating cylinder operation. Each disabled cylinder acts as an air pump and cools the engine.

When this occurs, your vehicle still operates, however:

- Engine power is limited.
- The air conditioning system turns off.

Continued operation increases the engine temperature, causing the engine to completely shut down. Your steering and braking effort increases in this situation.

When the engine temperature cools, you can re-start the engine. Have your vehicle checked as soon as possible to minimize engine damage.

When Fail-Safe Mode Is Activated



WARNING: Fail-safe mode is for use during emergencies only. Operate your vehicle in fail-safe mode only as long as necessary to bring your vehicle to rest in a safe location and seek immediate repairs. When in fail-safe mode, your vehicle will have limited power, will not be able to maintain high-speed operation, and may completely shut down without warning, potentially losing engine power, power steering assist, and power brake assist, which may increase the possibility of a crash resulting in serious injury.

Maintenance



WARNING: Do not remove the coolant reservoir cap when the engine is on or the cooling system is hot. Wait 10 minutes for the cooling system to cool down. Cover the coolant reservoir cap with a thick cloth to prevent the possibility of scalding and slowly remove the cap. Failure to follow this instruction could result in personal injury.

Your vehicle has limited engine power when in the fail-safe mode, drive your vehicle with caution. Your vehicle does not maintain high-speed operation and the engine could operate poorly.

Remember that the engine is capable of automatically shutting down to prevent engine damage. In this situation:

1. Pull off the road as soon as safely possible and switch the engine off.
2. If you are a member of a roadside assistance program, we recommend that you contact your roadside assistance service provider.
3. If this is not possible, wait for a short period of time for the engine to cool.
4. Check the coolant level. If the coolant level is at or below the minimum mark, add prediluted coolant immediately.
5. When the engine temperature cools, you can re-start the engine. Have your vehicle checked as soon as possible to minimize engine damage.

Note: *Driving your vehicle without repair increases the chance of engine damage.*

Engine Coolant Temperature Management (If Equipped)



WARNING: To reduce the risk of crash and injury, be prepared that the vehicle speed may reduce and the vehicle may not be able to accelerate with full power until the coolant temperature reduces.

If you tow a trailer with your vehicle, the engine may temporarily reach a higher temperature during severe operating conditions, for example ascending a long or steep grade in high ambient temperatures.

At this time, you may notice the coolant temperature gauge moves toward the red zone and a message may appear in the information display.

You may notice a reduction in vehicle speed caused by reduced engine power in order to manage the engine coolant temperature. Your vehicle may enter this mode if certain high-temperature and high-load conditions take place. The amount of speed reduction depends on vehicle loading, grade and ambient temperature. If this occurs, there is no need to stop your vehicle. You can continue to drive.

The air conditioning may automatically turn on and off during severe operating conditions to protect the engine from overheating. When the coolant temperature decreases to the normal operating temperature, the air conditioning turns on.

If the coolant temperature gauge moves fully into the red zone, or if the coolant temperature warning or service engine soon messages appear in your information display, do the following:

Maintenance

1. Stop your vehicle as soon as it is safe to do so. Fully apply the parking brake, shift into park (P) or neutral (N).
2. Leave the engine running until the coolant temperature gauge needle returns to the normal position. If the temperature does not drop after several minutes, follow the remaining steps.
3. Switch the engine off and wait for it to cool. Check the coolant level.
4. If the coolant level is at or below the minimum mark, add prediluted coolant immediately.
5. If the coolant level is normal, restart the engine and continue.

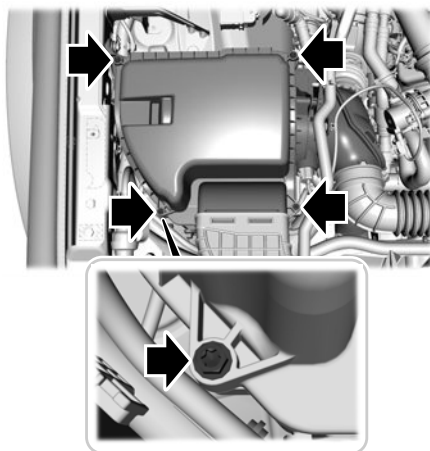

CHANGING THE ENGINE AIR FILTER



WARNING: To reduce the risk of vehicle damage and personal burn injuries, do not start your engine with the air cleaner removed and do not remove it while the engine is running.

Change the air filter element at the proper intervals. See **Scheduled Maintenance** (page 452).

When changing the air filter element, use only the air filter element listed. See **Capacities and Specifications** (page 393).

Note: Failure to use the correct air filter element could result in severe engine damage that the vehicle Warranty may not cover.

Note: When servicing the air cleaner, do not allow foreign material to enter the air induction system. The engine is susceptible to damage from even small particles.

1. Remove the screws from the air filter housing cover.
2. Carefully lift the air filter housing cover.
3. Remove the air filter element from the air filter housing.
4. To install, reverse the removal procedure.

CHANGING THE FUEL FILTER

Your vehicle has a lifetime fuel filter that integrates with the fuel tank. It does not need regular maintenance or replacement.

CHANGING THE 12V BATTERY



WARNING: Batteries normally produce explosive gases which can cause personal injury. Therefore, do not allow flames, sparks or lighted substances to come near the battery. When working near the battery, always shield your face and protect your eyes. Always provide correct ventilation.

Maintenance



WARNING: When lifting a plastic-cased battery, excessive pressure on the end walls could cause acid to flow through the vent caps, resulting in personal injury and damage to the vehicle or battery. Lift the battery with a battery carrier or with your hands on opposite corners.



WARNING: Keep batteries out of reach of children. Batteries contain sulfuric acid. Avoid contact with skin, eyes or clothing. Shield your eyes when working near the battery to protect against possible splashing of acid solution. In case of acid contact with skin or eyes, flush immediately with water for a minimum of 15 minutes and get prompt medical attention. If acid is swallowed, call a physician immediately.



WARNING: Battery posts, terminals and related accessories contain lead and lead compounds, chemicals known to the State of California to cause cancer and reproductive harm. **Wash your hands after handling.**



WARNING: This vehicle may have more than one battery. Removing the battery cables from only one battery does not disconnect your vehicle electrical system. Make sure you disconnect the battery cables from all batteries when disconnecting power. Failure to do so may cause serious personal injury or property damage.

The battery is in the engine compartment. See **Under Hood Overview** (page 320).

Your vehicle has a maintenance-free battery. It does not require additional water during service.

For longer, trouble-free operation, keep the top of the battery clean and dry and the battery cables tightly fastened to the battery terminals. If any corrosion is present on the battery or terminals, remove the cables from the terminals and clean with a wire brush. You can neutralize the acid with a solution of baking soda and water.

We recommend that you disconnect the negative battery cable terminal from the battery if you plan to store your vehicle for an extended period.

Note: *If you only disconnect the negative battery cable terminal, make sure it is isolated or placed away from the battery terminal to avoid unintended connection or arcing.*

To maintain correct operation of the battery management system, if you add any electrical devices to your vehicle, do not connect the ground connection directly to the negative battery terminal. A connection at the negative battery terminal can cause inaccurate measurements of the battery condition and potential incorrect system operation.

Note: *If you add electrical accessories or components to your vehicle this may adversely affect battery performance, durability and the performance of other electrical systems on your vehicle.*

If you replace the battery make sure it matches the electrical requirements of your vehicle.

If you disconnect or replace the battery and your vehicle has an automatic transmission, it must relearn its adaptive strategy. Because of this, the transmission may shift firmly when first driven. This is normal operation while the transmission fully updates its operation to optimum shift feel.

Maintenance

Remove and Reinstall the Battery

To disconnect or remove the battery, do the following:

1. Apply the parking brake and switch the ignition off.
2. Switch all electrical equipment off, for example lights and radio.
3. Wait a minimum of two minutes before disconnecting the battery.

Note: *The engine management system has a power hold function and remains powered for a period of time after you switch the ignition off. This is to allow diagnostic and adaptive tables to be stored. Disconnecting the battery without waiting can cause damage not covered by the vehicle Warranty.*

4. Disconnect the negative battery cable terminal.
5. Disconnect the positive battery cable terminal.
6. Remove the battery securing clamp.
7. Remove the battery.
8. To install, reverse the removal procedure.

Note: *Before reconnecting the battery, make sure the ignition remains switched off.*

Note: *Make sure the battery cable terminals are fully tightened.*

Note: *After cleaning or replacing the battery, make sure you reinstall the battery cover or shield.*

If you disconnect or replace the vehicle battery, you must reset the following features:

- Window bounce-back. See **Window Bounce-Back** (page 103).
- Clock Settings.
- Pre-set radio stations.
- Steering Angle Sensor.

Note: *To calibrate the steering angle sensor, drive the vehicle above 30 mph (50 km/h) for a minimum of 1.2 mi (2 km). Make sure to drive straight ahead for a minimum of 30 seconds. Several vehicle functions are disabled and a warning light could appear until the sensor is calibrated.*

Battery Management System

The battery management system monitors battery conditions and takes actions to extend battery life. If excessive battery drain is detected, the system temporarily disables some of the following features:

- Heated rear window.
- Heated seats.
- Climate control.
- Heated steering wheel.
- Audio unit.
- Navigation system.

A message may appear in the information display to alert you that battery protection actions are active.

After battery replacement, or in some cases after charging the battery with an external charger, the battery management system requires eight hours of vehicle sleep time to relearn the battery state of charge. During this time your vehicle must remain fully locked with the ignition off.

Note: *If you add electrical accessories or components to the vehicle, it may adversely affect battery performance and durability. This may also affect the performance of other electrical systems in the vehicle.*

Battery Disposal



Make sure that you dispose of old batteries in an environmentally friendly way. Seek advice from your local authority about recycling old batteries.

Maintenance

ADJUSTING THE HEADLAMPS

Vertical Aim Adjustment

The headlamps on your vehicle are properly aimed at the assembly plant. If your vehicle has been in an accident, contact an authorized dealer to check and realign your headlamps.

Headlamp Aiming Target

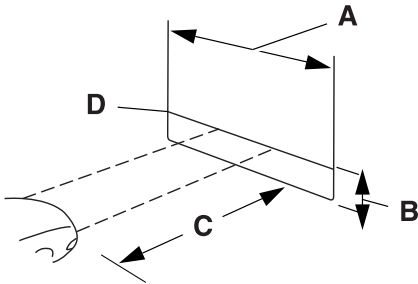

- A 8 ft (2.4 m).
- B Center height of lamp to ground.
- C 25 ft (7.6 m).
- D Horizontal reference line.

1. Park your vehicle directly in front of a wall or screen on a level surface, approximately 25 ft (7.6 m) away.
2. Measure the height from the center of your headlamp, indicated by a 3 millimeter circle on the lens, to the ground and mark an 8 ft (2.4 m) horizontal reference line on the vertical wall or screen at this height, a piece of masking tape works well.
3. Switch on the low beam headlamps to illuminate the wall or screen and open the hood. Cover one of the headlamps so no light hits the wall.



4. On the wall or screen, observe a light pattern with a distinct horizontal edge toward the right. If this edge is not at the horizontal reference line, adjust the beam so the edge is at the same height as the horizontal reference line.

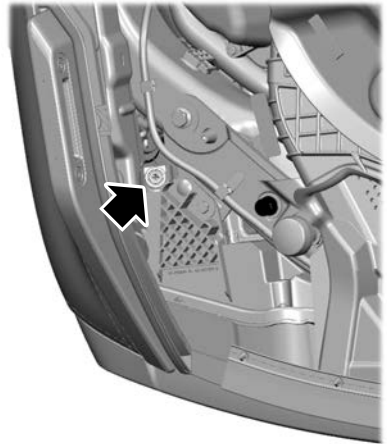

5. Locate the vertical adjuster on each headlamp. Use a #2 Phillips screwdriver to turn the adjuster either counterclockwise or clockwise in order to adjust the vertical aim of the headlamp.
6. Repeat Steps 3 through 7 to adjust the other headlamp.

Maintenance

7. Close the hood and turn off the lamps.

Horizontal Aim Adjustment

Horizontal aim is not required for this vehicle and is not adjustable.

EXTERIOR BULBS

EXTERIOR BULB SPECIFICATION CHART

Replacement bulbs are specified in the chart below. Headlamp bulbs must be marked with an authorized D.O.T. marking for North America to make sure they have the proper lamp performance, light brightness, light pattern and safe visibility. The correct bulbs will not damage the lamp assembly or void the lamp assembly warranty and will provide quality bulb illumination time.

Lamp	Specification	Power (Watt)
Center high mounted stop lamp.	LED	LED
Daytime running lamp.	LED	LED
Front turn signal and parking lamp.	LED	LED
Front fog lamp.	LED	LED
Front side marker lamp.	LED	LED
Headlamp low beam.	LED	LED
Headlamp high beam.	LED	LED
Rear turn signal - high series.	LED	LED
Rear lamp, stoplamp, rear side marker lamp and rear turn signal - low series.	WT21W/7W	21/7
Reversing lamp - low series.	WT21W	21
Reversing lamp - high series.	LED	LED
Side turn signal lamp.	LED	LED
Taillamp.	LED	LED

Note: LED lamps are not serviceable. See an authorized dealer if they fail.

Maintenance

REMOVING A REAR LAMP ASSEMBLY

1. Make sure the headlamps are off.

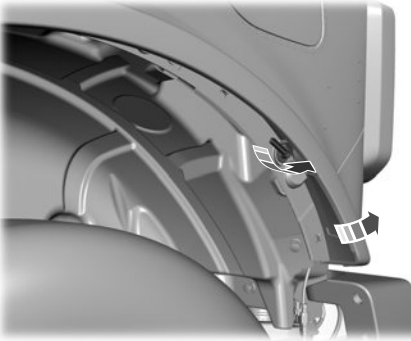

2. Loosen the quarter-turn fastener on the rearmost fender flare.
3. Fully open the tailgate. See **Opening the Tailgate From Outside Your Vehicle** (page 84).

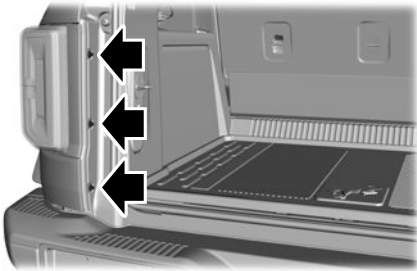

4. Remove the three pushpins from inside the trim panel.



5. Remove the lower trim piece by disengaging the retaining tabs. Pull from the inside edge first, then pull from the outside edge.

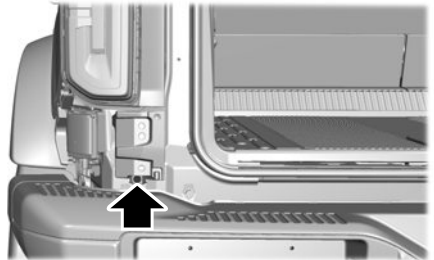

6. Remove the lower retaining bolt from the inside trim piece. Pull on the lower part of the trim piece to disengage the upper retaining clips.

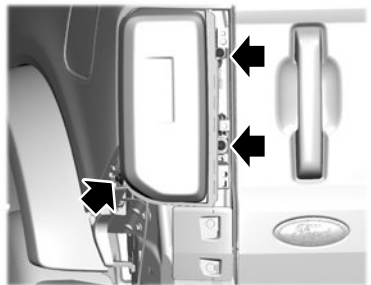

Maintenance

7. Remove the three retaining bolts securing the rear lamp to the body.

Note: Remove and install the retaining bolt near the wheel well before the retaining bolts near the luggage compartment.

8. Pull the rear lamp away from the vehicle and disconnect the electrical connectors as needed.
9. To install, reverse the removal procedure.

CHANGING A REAR LAMP BULB

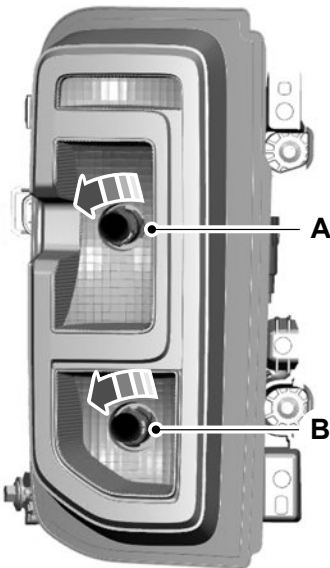

- A. Stoplamp, rear and turn signal bulb.
- B. Reversing lamp bulb.

1. Remove the rear lamp assembly. See **Removing a Rear Lamp Assembly** (page 331).
2. Rotate the bulb socket counterclockwise and remove it from the rear lamp assembly.
3. To install, reverse the removal procedure.

INTERIOR BULBS

INTERIOR BULB SPECIFICATION CHART

Your vehicle has LED lamps. These are not serviceable items. See an authorized dealer if they fail.

DRIVE BELT ROUTING - 2.3L ECOBOOST™

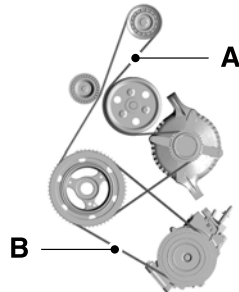

- A. Long drive belt is on the first pulley groove closest to engine.
- B. Short drive belt is on the second pulley groove farthest from engine.

Maintenance

DRIVE BELT ROUTING - 2.7L ECOBOOST™

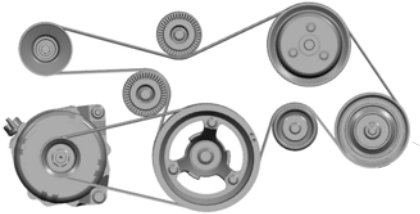

Removable Vehicle Components

REMOVABLE WINDOWS (IF EQUIPPED)

REMOVABLE WINDOWS PRECAUTIONS



WARNING: Do not drive unless all rear windows are removed or securely installed. Failure to follow these instructions could result in personal injury.

Note: Use caution when moving or handling the windows. Do not drop the windows.

Note: Do not place the windows directly on hard or sharp surfaces. This could cause damage to the window.

REMOVING AND INSTALLING THE REAR QUARTER WINDOWS - VEHICLES WITH MODULAR HARD TOP

The following procedure shows the passenger side rear window, driver side is similar.

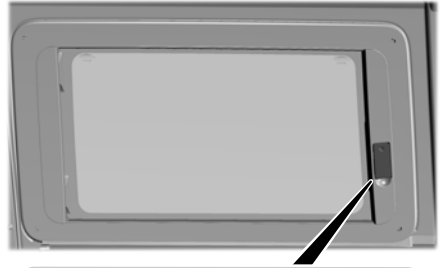

1. Lift the latch to release the quarter window.

Note: The quarter window opens slightly to provide access.

Removable Vehicle Components

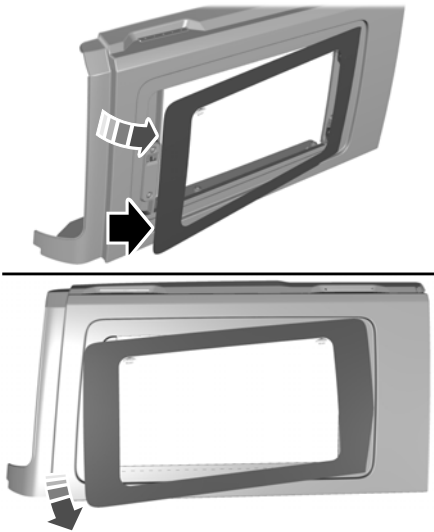

2. Rotate the quarter window while pulling down to separate the glass from the frame.

To install the glass back on your vehicle:

1. Rotate the quarter window in to the rubber seal.
2. Push the rear glass into the latch mechanism. The latch engages when correctly installed.

REMOVING AND INSTALLING THE REAR QUARTER WINDOWS - VEHICLES WITH: SOFT TOP

The following procedure shows the driver side rear window, passenger side similar.



1. Release the rear edge of the panel by pulling the fabric out of the slot.

Removable Vehicle Components

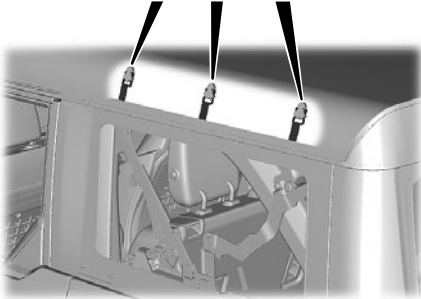
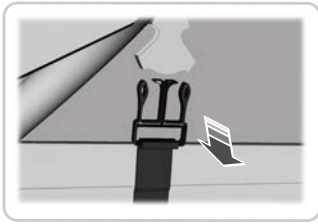

2. Unbuckle the three clips at the top.

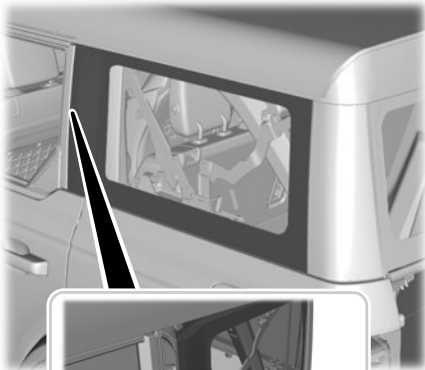

3. Release the front edge of the panel by pulling the fabric out of the slot to remove.

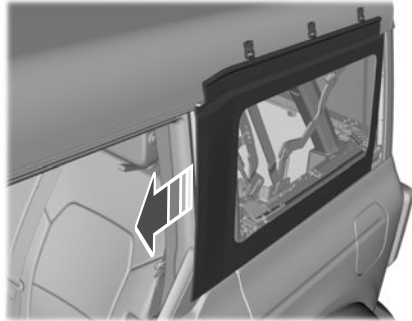

4. Slide the bottom panel forward out of the slot to remove.

5. To install the rear quarter window, perform the steps above in reverse order.

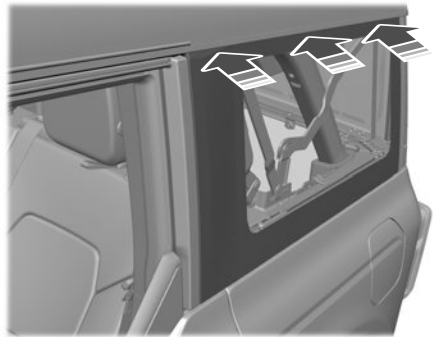

6. When installing the rear quarter windows, make sure the window is tucked under the tension cable.

Removable Vehicle Components

Note: When installing the rear edge of the rear quarter window into the slot, you can unlatch the soft top for easier installation. See **Opening and Closing the Soft Top** (page 348).

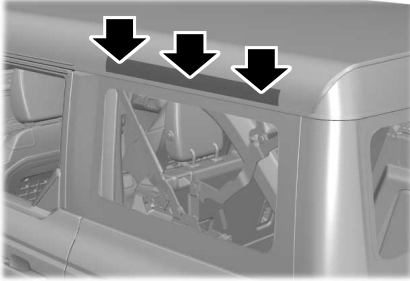

7. After installing the rear quarter windows, press along the top of the window to secure the Velcro strips.

Note: The buckles snap together and windows are flush when correctly installed. If the parts have visible gaps or stick out they are not correctly secured.

REMOVING AND INSTALLING THE REAR WINDOW - VEHICLES WITH: SOFT TOP

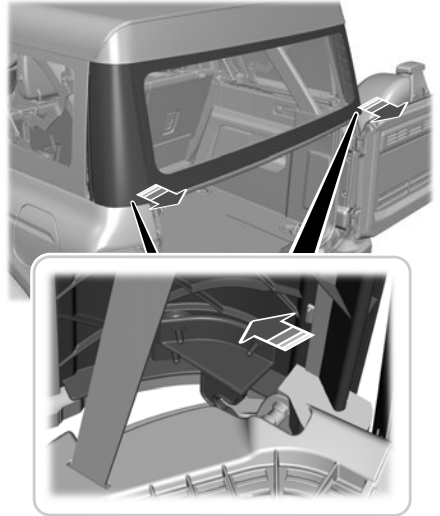

1. Pull the bottom corners of the backlight rearward to disengage the clip.

Removable Vehicle Components

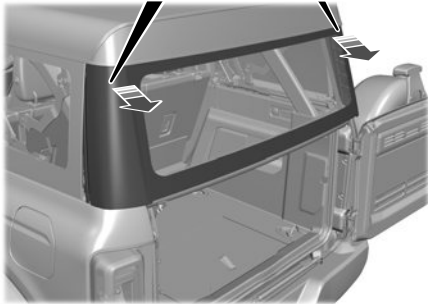
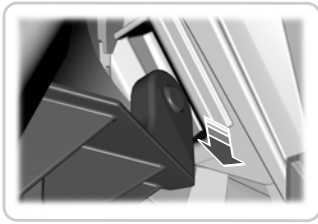

2. Remove the top corners from the slots.

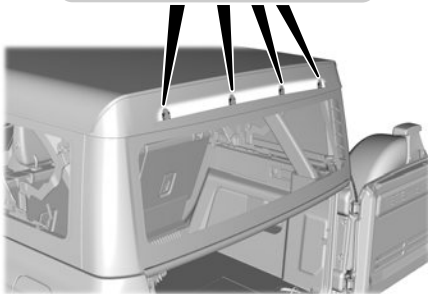
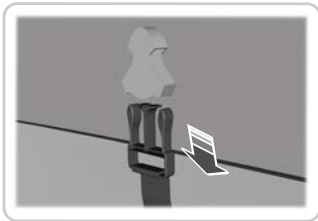

3. Unbuckle the four clips at the top.

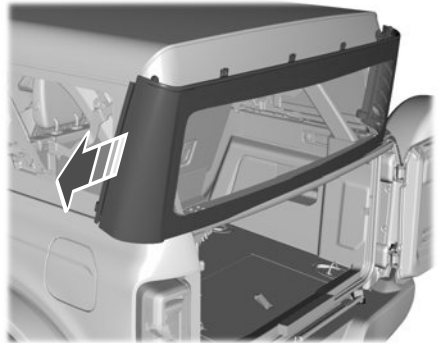

4. Slide the bottom out of the slot left or right to remove.
5. To install the rear window, perform the above steps in reverse order.

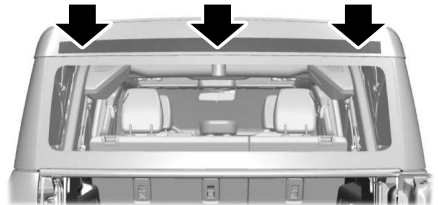

6. After installing the rear window, press along the top of the window to secure the Velcro strips.

Note: *The buckles snap together and windows are flush when correctly installed. If the parts have visible gaps or stick out they are not correctly secured.*

Removable Vehicle Components

REMOVABLE DOORS

REMOVING AND INSTALLING THE DOORS

Removing the Doors



WARNING: Removal of doors for off-road use only. Removing the doors from the vehicle will affect protection provided by the doors and may affect safety system performance, including safety canopy and front seat mounted side airbags, during a crash or rollover.



WARNING: Vehicle needs to be turned off before reconnecting doors to verify all electrical connections have been properly connected. Failure to follow these instructions may affect safety system performance, including safety canopy and front seat mounted side airbags, during a crash or rollover.

1. Fully open the windows on the doors you are removing.
2. Switch your vehicle off.
3. Fold the mirrors toward the front of your vehicle before removing the front doors.
4. Fully open the door you are removing.

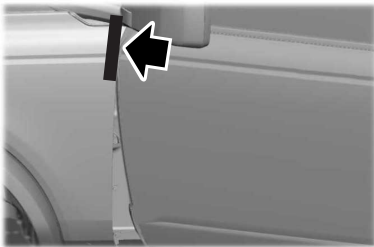

5. Locate the fender protector in the tool pouch and install it over the fender edge near the top door hinge.



6. To release the door harness connector, open the connector door. Pull the connector straight out.



7. Make sure to seat the connector door in the closed position.
8. We recommend that you use a door storage bag on the door you are removing.

Note: Make sure you fully secure the bag. Make sure the bag contains the edge and corners of the door to prevent accidental door damage before proceeding with the removal of the door.

Removable Vehicle Components

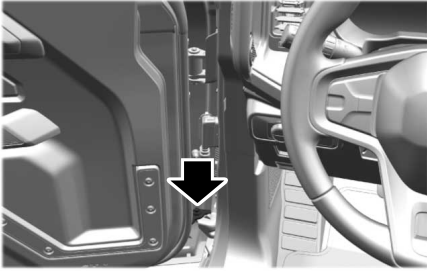

9. Locate the tool pouch and use the hex tool to remove the lower hinge bolt.

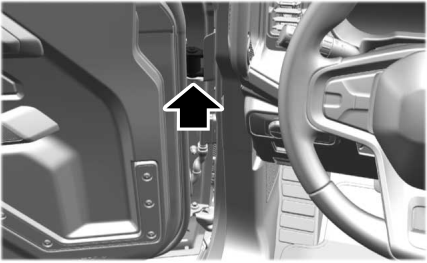

10. Remove the upper hinge bolt.

Note: Store the hinge bolts in the pocket of the tool pouch.



11. Locate the lower lift handle.

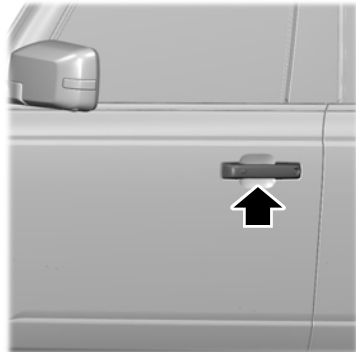

12. Use the door handle as the upper lift handle.
13. With the help of another person, lift the door vertically to separate it from the vehicle.

Note: Use caution when removing the doors as they are heavy.

Note: Store the doors out of the elements to prevent damage.

14. To remove additional doors, repeat Steps 4 – 13.

Removable Vehicle Components

15. Return the hex tool to the tool pouch and secure it in vehicle.
16. Return mirrors to the driving position.

Note: When you remove the doors, the rear seat occupant alert no longer functions.

Installing the Doors

1. Switch your vehicle off.
2. Fold the mirrors towards the front of the vehicle before installing the front doors.
3. Inspect and clean debris from the bodyside and door hinges.
4. If you are using a storage bag, unzip it far enough to allow access to the hinges.

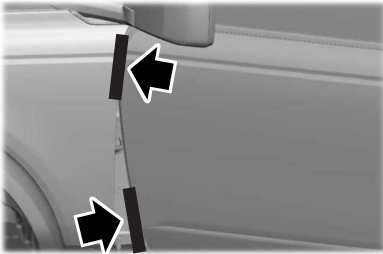

5. Locate the fender and door protectors in the tool pouch. Install one over the fender edge near the upper door hinge and the other on the door edge near the bottom door hinge.

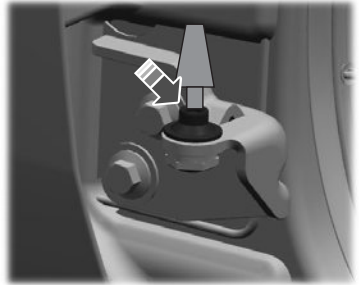

6. Locate the lower bodyside hinge and install alignment pin.

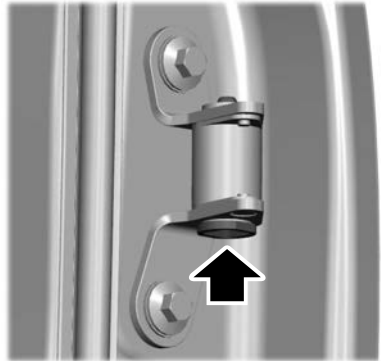

7. Locate the upper door hinge portion.

Removable Vehicle Components



8. Locate the upper bodyside hinge.

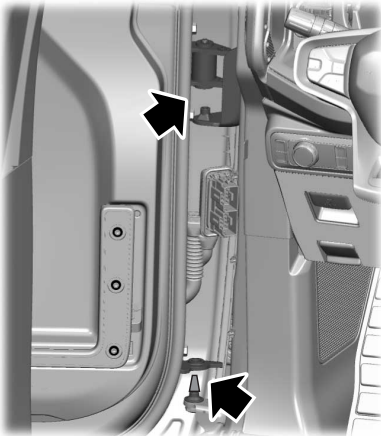

9. With the help of another person, lower the door onto the body hinges, aligning the upper door portion to the upper body pin and the lower door portion to the alignment pin.

Note: Make sure you do not pinch the wiring connector harness between the door and the body of the vehicle.

10. Remove the lower alignment pin.

11. Hand start the hinge bolts to the upper and lower door hinges.
12. Use the hex tool to tighten the bolts.

Note: We recommend that you use a torque wrench to make sure you tighten the bolts to the required 22 lb.ft (30 Nm) specification.

13. If using a storage bag, remove it from the door.
14. Open the harness connector door.



15. Insert the door harness into the connector.



16. Open and close the installed door a few times to make sure you aligned it properly and that it operates normally.
17. To install additional doors, repeat Steps 3 – 16.

Removable Vehicle Components

18. Close the doors and switch the ignition on. Check for any warning messages.
19. Return the mirrors to the driving position.

DOORS AND LOCKS AUDIBLE WARNINGS

Sounds when a door is not fully closed or removed and your vehicle is moving.

REMOVABLE ROOF PANELS (IF EQUIPPED)

REMOVABLE ROOF PANEL PRECAUTIONS



WARNING: When opening, closing, removing or installing the removable vehicle components, take care not to get your fingers or hands caught in the mechanism. Failure to follow this instruction could result in personal injury.



WARNING: Do not drive your vehicle with only the center or the rear roof panel removed. Failure to follow this instruction could cause unintended separation of the roof panels from your vehicle.



WARNING: Do not drive your vehicle unless the installed roof panels are properly secured. Failure to follow this instruction could cause unintended separation of the roof panels from your vehicle.

Removal of the center and rear roof panels requires two adults.

Do not cut, drill, weld or modify the roof panels or attach anything other than the factory-installed roof rack.

If there is any damage to the roof panels, see an authorized dealer.

Make sure the locating pins on the rear roof panel sit flush in your vehicle when installed.

Failure to follow these instructions could cause interior water damage, stains or mildew:

- Properly position the hard top assembly to seal the top to your vehicle during installation. Improper installation could cause water to leak into the vehicle's interior.
- Properly handle and store the removable roof panels. Improper handling and storage could damage the seals, causing water to leak into the vehicle's interior.
- Do not place anything on top of the rear roof panel when it is removed from the vehicle. This could cause damage to the rear roof panel and its seals.

REMOVING AND INSTALLING THE FRONT ROOF PANEL

Remove the driver side front roof panel before removing the passenger side front roof panel.

1. Fold down the sun visor against the windshield.

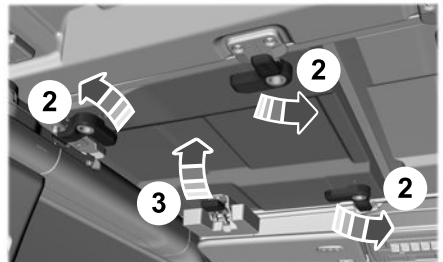

Removable Vehicle Components

2. Turn the three L-shaped latches on the driver side front roof panel, unlocking them from the roof.
3. Unlatch the driver side header panel latch at the top of the windshield.
4. Remove the driver side front roof panel.
5. Repeat the steps to remove the passenger side panel front roof panel.
6. Store the front roof panels in the storage bag. See **Storing the Roof Panels** (page 359). See **Storing the Doors and the Roof Panels** (page 352).
7. To install, reverse the removal procedure.

REMOVING AND INSTALLING THE CENTER ROOF PANEL - 4-DOOR

Remove both of the front roof panels before removing the center roof panel.

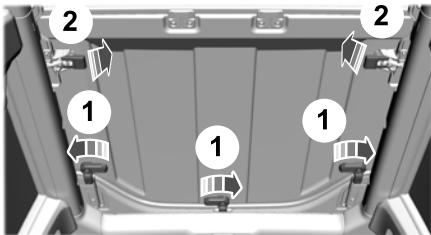

1. Turn the three L-shaped latches on the center roof panel, unlocking them from the rear roof panel.
2. Unlatch the driver side and passenger side latches of the center roof panel.
3. Remove the center roof panel.
4. To install, reverse the removal procedure.

REMOVING AND INSTALLING THE REAR ROOF PANEL - 2-DOOR

Remove the front panels before removing the rear roof panel.

1. Open the rear doors.
2. Open the tailgate window. See **Opening and Closing the Windows** (page 103).
3. Locate the wire harness and washer hose on the driver side rear inside corner of the vehicle.
4. Release the locking tab by pushing it down.

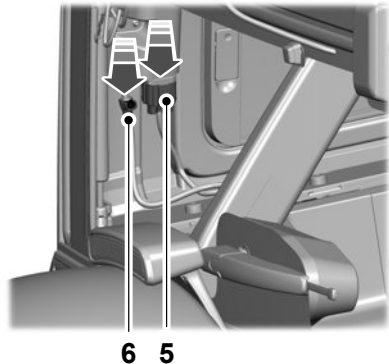

5. Push the tab inward when pulling down to disconnect and remove the wiring harness.
6. Push the release button on the hose connector and pull down to remove the washer hose.

Removable Vehicle Components

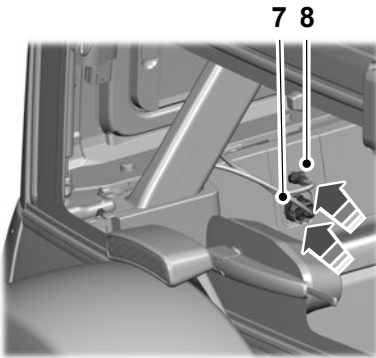

7. Secure the wiring harness to the body side by plugging it into the receptacle and pushing up on the locking tab.
8. Secure the washer hose by snapping it into the top of the body side receptacle.

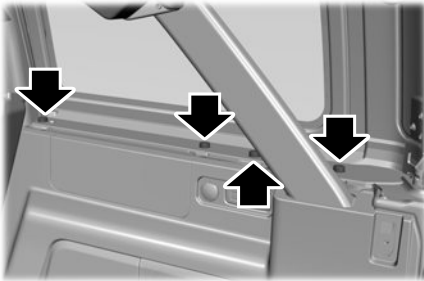

9. Remove the four fasteners on each side of your vehicle that secure the rear roof panel to the vehicle using the provided head driver and ratchet.
10. With the tailgate window open, grab the opening with one hand and slightly lift with the other hand. Lift the rear roof panel straight up and off. Place the rear roof panel on a soft surface to prevent damage.

Note: Store the rear roof panel with the tailgate window open to prevent damage to the glass seal.

11. To install, reverse the removal procedure. Torque the fasteners that secure the rear roof panel to your vehicle to 15 ± 2 lb.ft (20 ± 3 Nm).

Note: Make sure the locating pins on the rear roof panel sit flush in your vehicle when installed.

Note: Do not overtighten the fasteners. You can strip the fasteners if they are overtightened.

Removing and Installing the Modular Roof Panel (If Equipped)

Store the modular roof panel in a safe place when you remove it to prevent part damage.

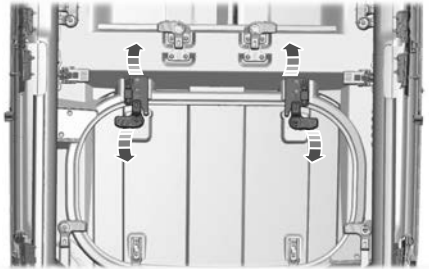

1. Pull and hold the spring-loaded slide.
2. Turn the L-shaped latch.
3. Repeat steps 1 and 2 on the other latch to unlock the modular roof panel from the roof.
4. Push up on the front of the panel.
5. Slide the panel forward to remove it from your vehicle.
6. To install, reverse the removal procedure.

Removable Vehicle Components

Note: Make sure the modular roof panel slides back into place and the locating pins sit in the front latch receiver when installing the modular roof panel.

Note: You do not need to pull and hold the spring-loaded slides to turn the latches to lock the modular roof panel.

REMOVING AND INSTALLING THE REAR ROOF PANEL - 4-DOOR

Remove the front panels and center panel before removing the rear roof panel.

1. Open the rear doors.
2. Open the tailgate window. See **Opening and Closing the Windows** (page 103).
3. Locate the wire harness and washer hose on the driver side rear inside corner of the vehicle.
4. Release the locking tab by pushing it down.

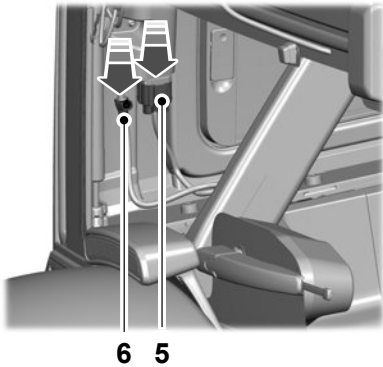

5. Push the tab inward when pulling down to disconnect and remove the wiring harness.
6. Push the release button on the hose connector and pull down to remove the washer hose.

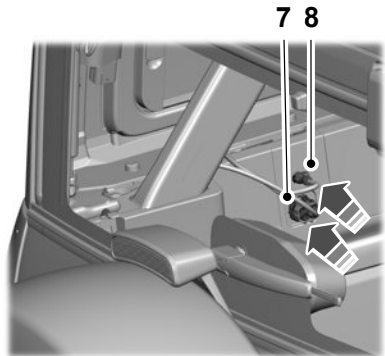

7. Secure the wiring harness to the body side by plugging it into the receptacle and pushing up on the locking tab.
8. Secure the washer hose by snapping it into the top of the body side receptacle.

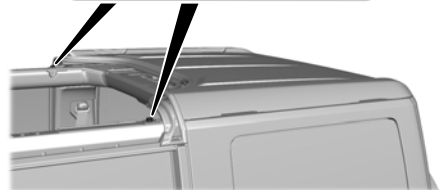
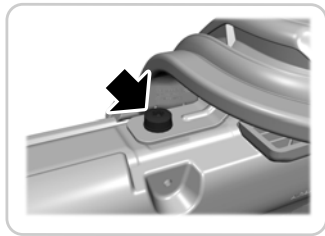

9. Remove the two fasteners that secure the rear roof panel at the C-pillar using the provided head driver and ratchet.

Removable Vehicle Components

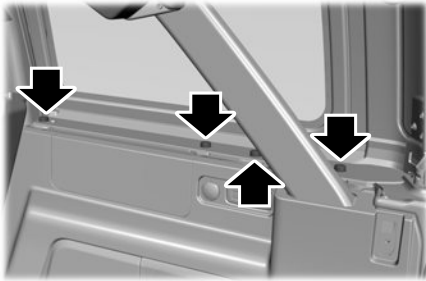

10. Remove the four fasteners on each side of your vehicle that secure the rear roof panel to the vehicle using the provided head driver and ratchet.
11. With the tailgate window open, grab the opening with one hand and slightly lift with the other hand. Lift the rear roof panel straight up and off. Place the rear roof panel on a soft surface to prevent damage.

Note: Store the rear roof panel with the tailgate window open to prevent damage to the glass seal.

12. To install, reverse the removal procedure. Torque the fasteners that secure the rear roof panel to your vehicle to 15 ± 2 lb.ft (20 ± 3 Nm).

Note: Make sure the locating pins on the rear roof panel sit flush in your vehicle when installed.

Note: Do not overtighten the fasteners. You can strip the fasteners if they are overtightened.

REMOVABLE HARD TOP (IF EQUIPPED)

REMOVING AND INSTALLING THE HARD TOP



WARNING: When opening, closing, removing or installing the removable vehicle components, take care not to get your fingers or hands caught in the mechanism. Failure to follow this instruction could result in personal injury.

1. Remove the roof panels. See **Removable Roof Panels** (page 343).
2. To install, reverse the removal procedure.

Removing the Soft Top Trim Piece (If Equipped)

Make sure to remove the soft top trim pieces before installing the hard top.

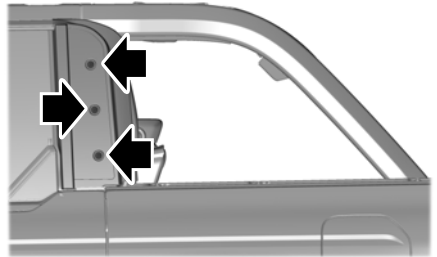

Remove the three fasteners to the soft top trim piece on each side of your vehicle using the provided head driver and ratchet.

Removable Vehicle Components

REMOVABLE SOFT TOP (IF EQUIPPED)

OPENING AND CLOSING THE SOFT TOP



WARNING: When opening, closing, removing or installing the removable vehicle components, take care not to get your fingers or hands caught in the mechanism. Failure to follow this instruction could result in personal injury.

Partially Opening the Soft Top



1. Unlatch the two latches in the headliner.

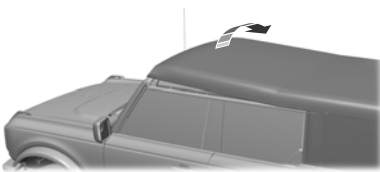

2. Push the soft top up and rearward.

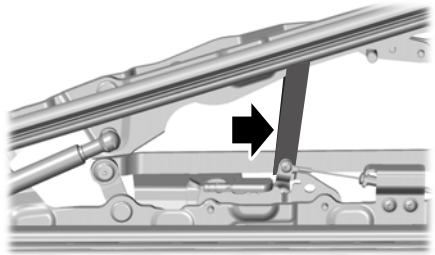

3. Attach the provided straps if you are off-road driving or driving on rough roads.
4. To close, rotate the soft top forward, making sure it latches in place.

Note: Do not drive without the soft top properly latched or fully opened.

Note: Do not store your vehicle in cold weather with the soft top open.

Fully Opening the Soft Top

1. Remove the rear quarter windows and the rear window. See **Removable Windows** (page 334).

Note: Do not drive unless all rear windows are removed or installed.

2. Follow the steps to partially open the soft top.

Removable Vehicle Components

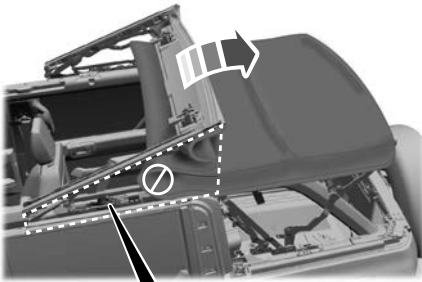

5. To return to the partially open position, press down and lift the handle on the driver side of your vehicle to unlatch the soft top, then rotate the soft top forward.

Note: Do not store your vehicle in cold weather with the soft top open.

Accessing the Rear Cargo Area

1. Open the tailgate.

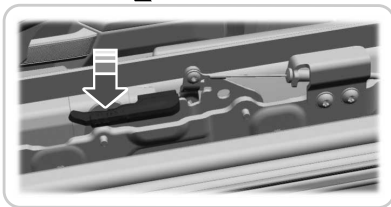

3. Press down the handle on the driver side of your vehicle to unlatch the soft top. Lift and rotate the soft top rearward, making sure to keep your hands and fingers free of the mechanism.



2. Unlatch the soft top.

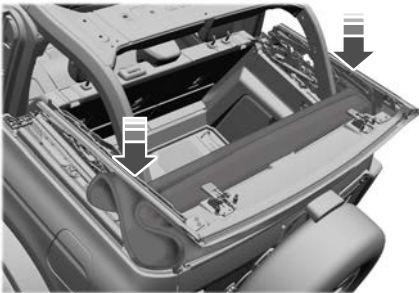

4. Press down on the driver side and passenger side of the soft top to fully secure it.

Removable Vehicle Components



3. Lift the rear of the soft top and support it with the soft top strut.

REMOVING AND INSTALLING THE SOFT TOP



WARNING: When opening, closing, removing or installing the removable vehicle components, take care not to get your fingers or hands caught in the mechanism. Failure to follow this instruction could result in personal injury.

1. Fully open the soft top. See **Opening and Closing the Soft Top** (page 348).

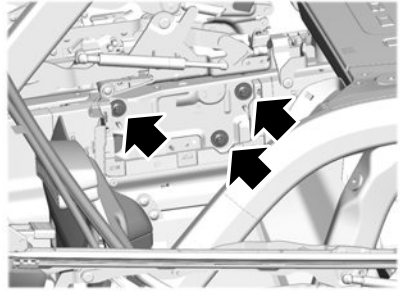

2. Remove the three fasteners on each side in the rear cargo area using the provided head driver and ratchet.
3. Remove the soft top.
4. To install, reverse the removal procedure. Torque the fasteners that secure soft top to the vehicle to 15 ± 2 lb.ft (20 ± 3 Nm).

Note: Make sure the soft top is set flush on the locating pins.

Note: Do not overtighten the fasteners. You can strip the fasteners if they are overtightened.

Installing the Soft Top Trim Piece (If Equipped)

Make sure to install the soft top trim pieces before installing the soft top.

Removable Vehicle Components

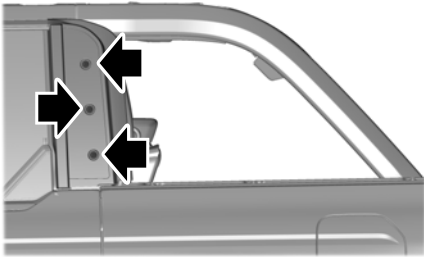

Secure the three fasteners to the soft top trim piece on each side of your vehicle using the provided head driver and ratchet.

REMOVABLE FENDERS

REMOVABLE FENDER PRECAUTIONS



WARNING: Do not drive your vehicle on public roads with fenders removed as you will lose the protection they provide in a crash. Failure to follow this instruction could result in personal injury or death.

REMOVING THE FENDER FLARES

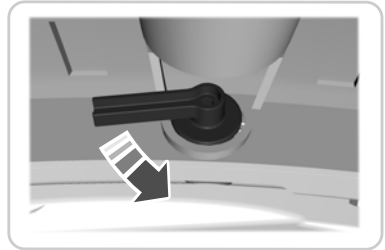
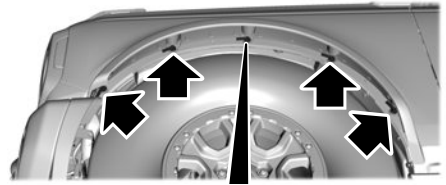

1. Unlock the five quarter turn clips by turning the clips counterclockwise.

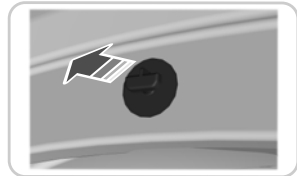
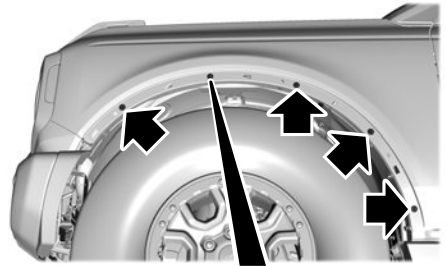

2. Pull outward on the fender flare with your hands to unseat the 5 push pin clips from the sheet metal.

Removable Vehicle Components

Note: Push pins and quarter pins should not be removed from fender flare.

Installing the Fender Flares

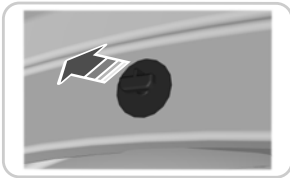
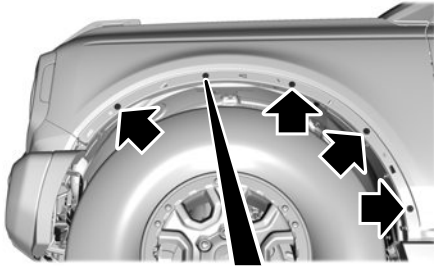

1. Press the five push clips in until they are seated.

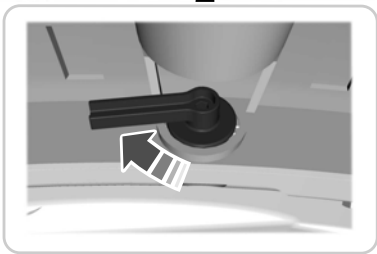
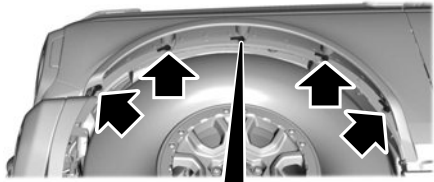

2. Lock the five quarter turn clips by turning the clips clockwise.

STORING THE DOORS AND THE ROOF PANELS - 4-DOOR

(IF EQUIPPED)



WARNING: Do not store removed doors or roof panels in vehicle without using the Ford onboard storage kit, and verifying they have been secured per instructions. Failure to follow this instruction could result in personal injury or death.

Note: Cargo can shift under severe vehicle use, to reduce the risk of damage, avoid high speed or extreme rock crawl off-road situations when storing the doors in the cargo area.

Note: Inspect the bags and harness periodically to make sure they are not damaged. Inspect the door retention harness straps to make sure there are no nicks, tears or cuts. Replace if necessary.

Note: Clean the roof panels and doors prior to storing them in the bags as dirt may damage the finish.

Storing the Front Roof Panels

1. Remove the front roof panels. See **Removing and Installing the Front Roof Panel** (page 343).

Removable Vehicle Components

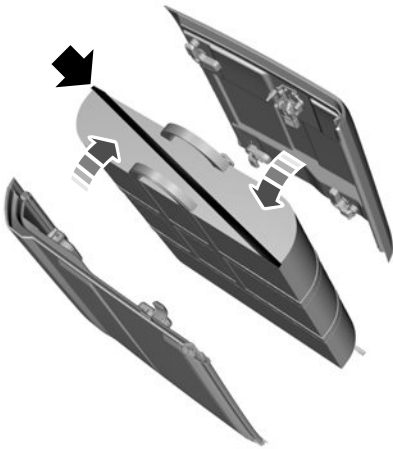

2. Open the bag and pull out the divider. Place the first panel into the bag. Replace the divider before placing the second panel into the bag.
3. Zip the bag closed.
4. Gently slide the roof panel bag into the cargo area.

Securing the Front Roof Panels Vertically

1. Raise the bag to the vertical position.

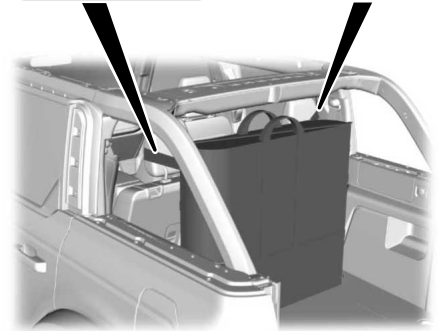
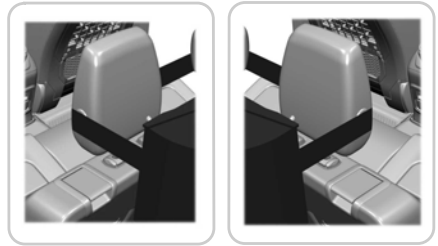

2. Secure the upper roof bag strap around the rear seat headrests. Adjust the tension on the strap until it is snug.

Note: Do not over-tighten the strap. This may cause damage to the headrest.

3. Secure the lower bag hooks to the forward cargo rings.

Note: Some vehicle accessories may prevent vertical storage of the panels.

Removable Vehicle Components

Securing the Front Roof Panels Horizontally



1. Install the loops through the two D-rings and secure the panels.

Note: Do not place objects on the roof panel bag to avoid damaging the panels.

Securing the Door Retention Harness



1. Install the eyebolts located in the Ford onboard storage kit into the rear cargo area pillars.

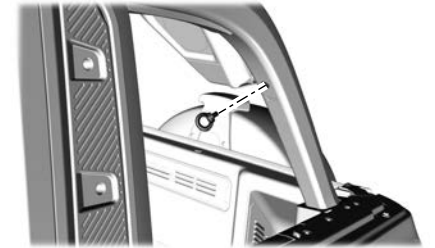

2. Use the ratchet tool provided in the kit to assist in tightening the eyebolts. The eyebolts should rest in the groove of the handle. Using the tool as a lever, apply force until fully tightened.

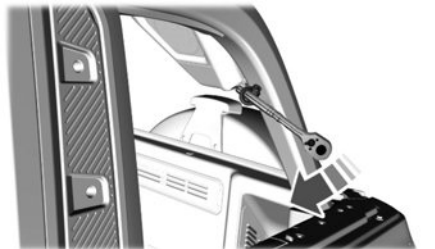

Removable Vehicle Components

Note: We recommend tightening the eyebolts to 13 lb.ft (17 Nm).

Note: The eyebolts can remain installed on the vehicle. Make sure the eyebolts are fully tightened each time they are used.

3. Fully open the tailgate and rear lift glass, or open the soft top cargo access and connect the prop rod to hold open.

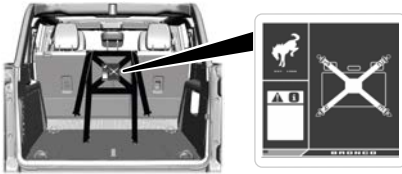

4. Install the door retention harness.

Note: Refer to harness label for image.

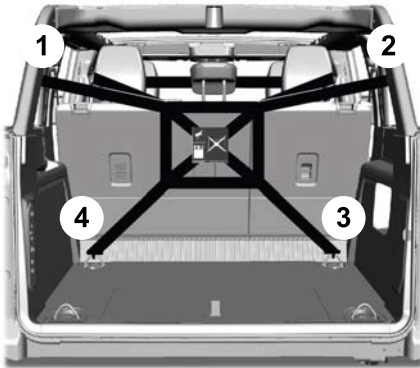

5. Attach upper straps 1 and 2 to the eyebolts. Attach lower straps 3 and 4 to the forward cargo rings.

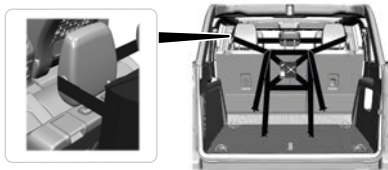

6. Place the narrow strap loop over all the rear headrests and tighten until snug.

Note: Do not over-tighten the strap. This may cause damage to the headrest.

7. Place the remaining harness over the seat so it is out of the way.

Storing the Front Doors

1. Adjust the seat backrest to the optimal seating position. Pull the lever up, and push the backrest rearward when storing the two front doors. This creates more space between the front door sail and the upper trim. Ensure the cargo area is clear of any other items. See **Adjusting the Seat Backrest** (page 134).
2. See Securing the Door Retention Harness earlier in this chapter and complete Steps 1-7.
3. Open the passenger side front door and install the door bag. See **Removing and Installing the Doors** (page 339).

Removable Vehicle Components

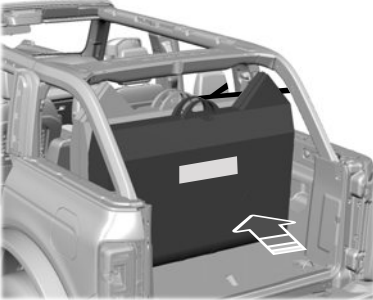
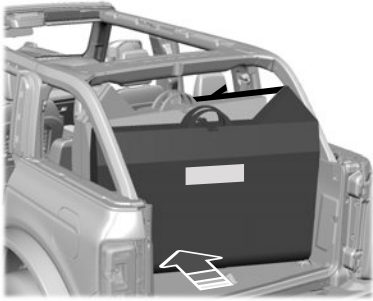

4. Zip the bag fully closed and gently place the door in the cargo area. Avoid contacting the rear pillars, speakers, striker, and trim. For soft tops, take care to avoid contacting the prop rod.
5. Slide the door into position with the bag label facing rearward. Center the door to make sure there is space between the door and cargo box trim panels.
6. Push the lower edge of the door forward until it stops to create space for the door peak.
7. Secure the door bag to the retention harness with the clip.
8. Repeat Steps 3-5 for the driver side front door. Secure the bags using the clips on the bags.

9. Lift the retention harness over the doors. Make sure the straps are straight.
10. Secure the upper straps 5 and 6 to the eyelet bolts and lower straps 7 and 8 to the rear cargo rings.
11. Tighten all adjustable straps to secure the doors.
12. To prevent the doors from moving, fold the unused rear door bags to use as a spacer and place them between the doors and lower cargo hooks as shown.

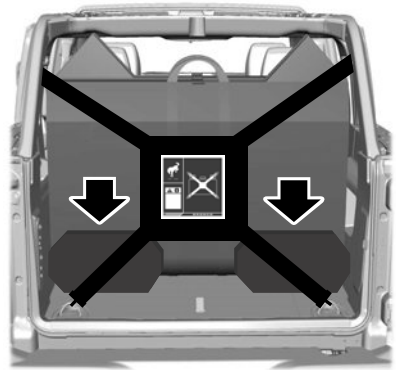
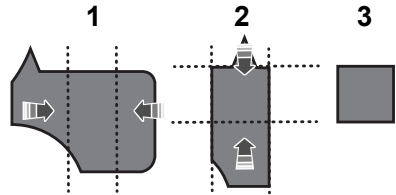

Note: The doors should not move when pressure is applied.

Removable Vehicle Components

Storing the Front Roof Panels and the Front Doors

1. Adjust the seat backrest to the optimal seating position. Pull the lever up, and push the backrest rearward when storing the two front doors. This creates more space between the front door sail and the upper trim. Ensure the cargo area is clear of any other items. See **Adjusting the Seat Backrest** (page 134).
2. See **Securing the Door Retention Harness** earlier in this chapter and complete Steps 1-7.
3. Open the passenger side front door and install the door bag. See **Removing and Installing the Doors** (page 339).

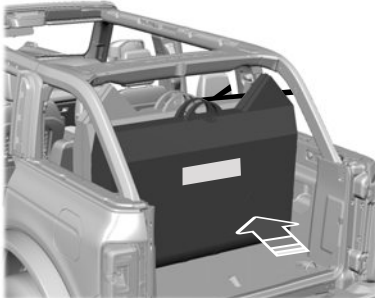
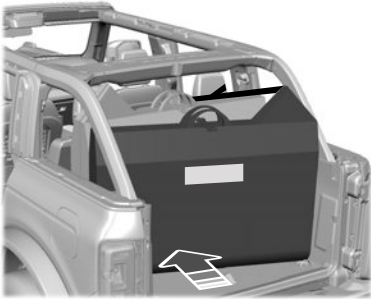

4. Zip the bag fully closed and gently place the door in the cargo area. Avoid contacting the rear pillars, speakers, striker, and trim.
5. Slide the door into position with the bag label facing rearward. Center the door to make sure there is space between the door and cargo box trim panels.
6. Push the lower edge of the door forward until it stops to create space for the door peak.
7. Secure the door bag to the retention harness with the clip.
8. Repeat Steps 3-5 for the driver side front door. Secure the bags using the clips on the bags.
9. Place the front roof panels in the bag, and then into the cargo area. See **Storing the Doors and the Roof Panels** (page 352).

Note: Do not use the roof bag retention system in this orientation. Secure the roof panels by the harness.

10. Lift the retention harness over the doors. Make sure the straps are straight.
11. Secure the upper straps 5 and 6 to the eyelet bolts and lower straps 7 and 8 to the rear cargo rings.
12. Tighten all adjustable straps to secure the doors and roof panels.

Note: The doors and roof panels should not move when pressure is applied.

Storing all Four Doors

1. Adjust the rear seat backrest to the upright position and raise the center headrest to the highest position. Pull on the seat backrest to make sure that it has fully latched. Ensure the cargo area is clear of any other items. See **Adjusting the Seat Backrest** (page 134).

Removable Vehicle Components

Note: Four door storage in the cargo area will prevent the soft tops from fully retracting. Limit to the partially open position.

Note: Make sure the rear seat headrests are upright.

2. See Securing the Door Retention Harness earlier in this chapter and complete Steps 1-7.
3. Open the driver-side rear door and install the bag. See **Removing and Installing the Doors** (page 339).

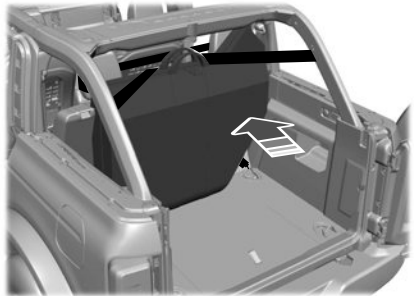
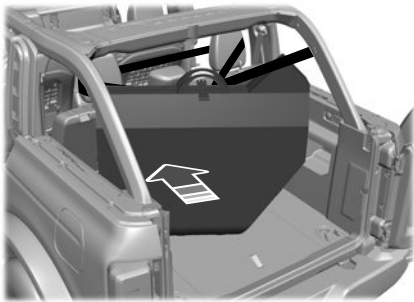

4. Zip the bag fully closed and gently place the door in the cargo area. Avoid contacting the rear pillars, speakers, striker, and trim. For soft tops, take care to avoid contacting the prop rod.
5. Slide the door into position with the bag label facing rearward.

6. Align the door peak with the highest point in the upper trim.



7. Secure the door bag to the retention harness with the clip.
8. Repeat Steps 3-5 for the remaining doors. Secure the bags with the harness clips.

Note: In order to store all four doors onboard, you must store the doors in the following sequence: driver-side rear, driver-side front, passenger-side front, passenger-side rear.

9. Lift the retention harness over the doors. Make sure the straps are straight.
10. Secure the upper straps 5 and 6 to the eyelet bolts and lower straps 7 and 8 to the rear cargo rings.
11. Tighten all adjustable straps to secure the doors.

Note: The doors should not move when pressure is applied.

Note: When closing the tailgate, make sure the tailgate and glass do not strike the stowed doors.

Removable Vehicle Components

STORING THE ROOF PANELS - 2-DOOR (IF EQUIPPED)



WARNING: Do not store removed doors or roof panels in vehicle without using the Ford onboard storage kit, and verifying they have been secured per instructions. Failure to follow this instruction could result in personal injury or death.

Note: The two-door vehicle is not capable of on board storage of the doors. Store the doors in a secure area to avoid damage.

Note: Roof panels should be clean prior to storage in bags as dirt may damage the finish.

1. Remove the front roof panels. See **Removing and Installing the Front Roof Panel** (page 343).

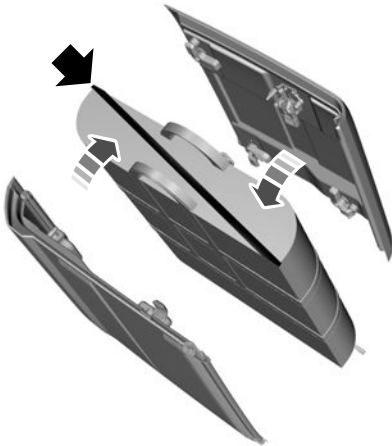

2. Open the bag and pull out the divider. Place the first panel into the bag. Replace the divider before placing the second panel into the bag.

3. Zip the bag closed.
4. Gently slide the roof panel bag into the cargo area in the vertical position.
5. Secure the upper roof bag strap around the rear seat headrests. Adjust the tension on the straps until it is snug.

Note: Do not over-tighten the strap. This may cause damage to the headrest.

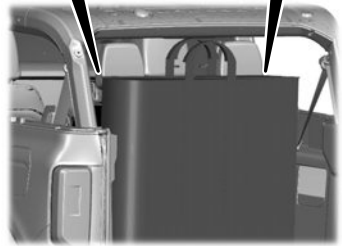
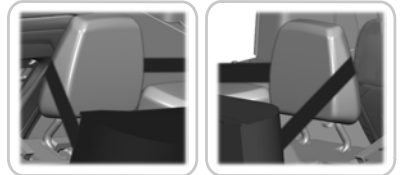

6. Secure the lower bag hooks to the forward cargo rings.

Vehicle Care

CLEANING PRODUCTS

Materials

For best results, use the following products

or products of equivalent quality:

For additional information and assistance, we recommend that you contact an authorized dealer.

Name	Specification
Motorcraft® Bug and Tar Remover, ZC-42 (U.S. & Canada)	
Motorcraft® Custom Bright Metal Cleaner, ZC-15 (U.S. & Canada)	ESR-M5B194-B
Motorcraft® Detail Wash, ZC-3-A (U.S. & Canada)	ESR-M14P4-A
Motorcraft® Engine Shampoo and Degreaser, ZC-20 (U.S.)	ESR-M14P3-A
Motorcraft® Engine Shampoo, CXC-66-A (Canada)	
Motorcraft® Premium Leather and Vinyl Cleaner, ZC-56 (U.S. & Canada)	
Motorcraft® Multi-Purpose Cleaner, CXC-101 (Canada)	
Motorcraft® Premium Windshield Wash Concentrate with Bitterant, ZC-32-B2 (U.S.)	WSS-M14P19-A
Motorcraft® Premium Quality Windshield Washer Fluid, CXC-37-F/M (Canada)	WSS-M14P19-A
Motorcraft® Professional Strength Carpet & Upholstery Cleaner, ZC-54 (U.S. & Canada)	
Motorcraft® Premium Glass Cleaner, CXC-100 (Canada)	ESR-M14P5-A
Motorcraft® Spot and Stain Remover, ZC-14 (U.S.)	
Motorcraft® Ultra-Clear Spray Glass Cleaner, ZC-23 (U.S.)	ESR-M14P5-A
Motorcraft® Wheel and Tire Cleaner, ZC-37-A (U.S. & Canada)	

CLEANING THE EXTERIOR

CLEANING THE EXTERIOR PRECAUTIONS

If you have a Sasquatch or soft top package, wash your vehicle by hand, or by using a touchless commercial wash with no mechanical tracks on the floor.

Immediately remove fuel spillages, bird droppings, insect deposits and road tar from your vehicle. These items may cause damage to your vehicle's paintwork or trim over time.

Remove any exterior accessories, for example antennas, before entering a car wash.

Vehicle Care

CLEANING HEADLAMPS AND REAR LAMPS

We recommend that you only use cold or lukewarm water containing car shampoo to clean the headlamps and the rear lamps.

Do not scrape the lamps.

Do not wipe lamps when they are dry.

CLEANING WINDOWS AND WIPER BLADES

To clean the windshield and wiper blades:

- Clean the windshield with a non-abrasive glass cleaner.

Note: *When cleaning the interior of the windshield, avoid getting any glass cleaner on the instrument panel or door panels. Wipe any glass cleaner off these surfaces immediately.*

- Clean the wiper blades with washer fluid or water applied with a soft sponge or cloth.

Note: *Do not use razor blades or other sharp objects to clean or remove decals from the inside of the heated rear window. This can cause damage not covered by the vehicle Warranty.*

CLEANING CHROME, ALUMINIUM OR STAINLESS STEEL

We recommend that you only use a car shampoo, a soft cloth and water on bumpers and other chrome, aluminium or stainless steel parts.

Note: *For additional information and assistance, we recommend that you contact an authorized dealer.*

Note: *Rinse the area well after cleaning.*

Note: *Do not use abrasive materials, for example steel wool or plastic pads, as they can scratch these surfaces.*

Note: *Do not use chrome cleaner, metal cleaner or polish on wheels or wheel covers.*

CLEANING WHEELS

Only use a recommended wheel and tire cleaner to clean the wheels weekly. For additional information and assistance, we recommend that you contact an authorized dealer.

1. Use a sponge to remove heavy deposits of dirt and brake dust.
2. Rinse well after cleaning.

Note: *Do not apply a cleaning chemical to warm or hot wheel rims and covers.*

If you intend on parking your vehicle for an extended period after cleaning the wheels with a wheel cleaner, drive your vehicle for a few minutes before parking your vehicle. This reduces the risk of corrosion of the brake discs, brake pads and linings.

Do not clean the wheels when they are hot.

Note: *Some car washes could damage wheel rims and covers.*

Note: *Using non-recommended cleaners, harsh cleaning products, chrome wheel cleaners or abrasive materials could damage wheel rims and covers.*

CLEANING THE ENGINE COMPARTMENT

Use a vacuum cleaner to remove debris from the screen area below windshield.

Note: *If you are not familiar with the parts around the engine do not wash the engine compartment. Avoid frequent engine washes.*

Vehicle Care

When washing the engine compartment:

- Never wash or rinse the engine while it is hot or running.
- Never wash or rinse any ignition coil, spark plug wire or spark plug well.
- Cover the battery, power distribution box, and air filter assembly to prevent water damage.

Note: *If your vehicle has an engine cover remove the cover before application of shampoo and degreaser.*

- Spray an approved engine shampoo and degreaser on all parts that require cleaning and rinse with water.

CLEANING THE CONVERTIBLE TOP

Remove lint with a lint roller or a vacuum with a soft bristle brush.

Wash with an approved high quality convertible top cleaner and protectant.

Note: *Do not use stiff bristle brushes, abrasive materials or household cleaning products.*

Note: *High pressure water may cause water leaks and possible seal damage to the convertible top.*

CLEANING STRIPES OR GRAPHICS

It is recommended to wash your vehicle by hand however, pressure washing may be used under the following conditions:

- Use a spray with a 40° wide spray angle pattern.
- Keep the nozzle at a 12 in (305 mm) distance and 90° angle to your vehicle's surface.

- Do not use water pressure higher than 2,000 psi (14,000 kPa).
- Do not use water hotter than 179°F (82°C).

Note: *Holding the pressure washer nozzle at an angle to the vehicle's surface may damage graphics and cause the edges to peel away from the vehicle's surface.*

CLEANING CAMERA LENSES AND SENSORS

We recommend that you only use lukewarm or cold water and a soft cloth to clean the camera lens and sensors.

Note: *Do not pressure wash camera lens and sensors.*

CLEANING THE UNDERBODY

Regularly clean the underside of your vehicle using water. Keep body and door drain holes free of debris or foreign material.

CLEANING THE INTERIOR

CLEANING THE INSTRUMENT PANEL



WARNING: Do not use chemical solvents or strong detergents when cleaning the steering wheel or instrument panel to avoid contamination of the airbag system.

We recommend that you only clean the instrument panel and cluster lens with a damp soft cloth. Dry the area with a clean, soft cloth.

For additional information and assistance, we recommend that you contact an authorized dealer.

Vehicle Care

Note: Avoid cleaners or polishes that increase the gloss of the upper portion of the instrument panel. The dull finish in this area helps protect you from undesirable windshield reflection.

CLEANING PLASTIC

We recommend that you only use a mild soap and water solution on a soft cloth. Dry the area with a clean, soft cloth.

CLEANING DISPLAYS AND SCREENS

We recommend that you only use a microfiber cloth in a circular motion to clean off the fingerprint or dust.

If dirt or fingerprints are still on the screen, apply a small amount of alcohol to the cloth and try to clean it again.

Note: Do not pour or spray alcohol onto the touchscreen.

Note: Do not use detergent or any type of solvent to clean the touchscreen.

CLEANING LEATHER AND VINYL

We recommend that you only clean the leather and vinyl surfaces in the following way:

1. Remove dust and loose dirt with a vacuum cleaner.
2. Wipe the surface with a soft, damp cloth and a mild soap and water solution. Dry the area with a clean, soft cloth.
3. Make sure the leather is dry, then apply a small amount of conditioner to a clean, dry cloth.

4. Rub the conditioner into the leather until it disappears. Allow the conditioner to dry, then repeat the process for the entire interior. If a film appears, wipe it off with a dry, clean cloth.
5. For additional information and assistance, we recommend that you contact an authorized dealer.

CLEANING FABRIC SEATS AND HEADLINERS



WARNING: On vehicles equipped with seat-mounted airbags, do not use chemical solvents or strong detergents. Such products could contaminate the side airbag system and affect performance of the side airbag in a crash.

We recommend that you only clean the fabric seats and headliners in the following way:

1. Remove dust and loose dirt with a vacuum cleaner.
2. Wipe the surface with a soft, damp cloth and a mild soap and water solution. Dry the area with a clean, soft cloth.
3. For additional information and assistance, we recommend that you contact an authorized dealer.

For heavy stains, spot clean the area. If a ring forms on the fabric, clean the entire area immediately, but do not oversaturate or the ring could set.

CLEANING CARPETS AND FLOOR MATS

We recommend that you only clean your carpets in the following way:

Vehicle Care

1. Remove dust and loose dirt with a vacuum cleaner.
2. Wipe the surface with a soft, damp cloth and a mild soap and water solution. Dry the area with a clean, soft cloth.
3. For additional information and assistance, we recommend that you contact an authorized dealer.

For heavy stains, spot clean the area. If a ring forms on the fabric, clean the entire area immediately, but do not over-saturate or the ring could set.

We recommend that you only clean your floor mats in the following way:

1. Remove dust and loose dirt with a vacuum cleaner.
2. Wash rubber floor mats using mild soap and lukewarm or cold water.
3. Completely dry the floor mat before placing them back in your vehicle.

Cleaning Rubber Floors

1. Remove the floor mats prior to washing out. See **Floor Mats** (page 298).

Note: Prior to washing out, remove large debris to prevent clogging the drain.

2. Turn active drain plugs in each passenger compartment counterclockwise to open.
3. Wash out debris using a standard garden style hose.

Note: Use caution to not spray seats, console, door interior, electrical connections, instrument cluster display and underside of the instrument panel on both driver and passenger sides.

4. Wipe out remaining water or debris from the floor.
5. Install active drain plugs and turn clockwise to close.
6. Reinstall floor mats.

CLEANING SEATBELTS



WARNING: Do not use cleaning solvents, bleach or dye on the vehicle's seatbelts, as these actions may weaken the belt webbing.

1. Wipe the surface with a soft, damp cloth and a mild soap and water solution. Dry the area with a clean, soft cloth.

REPAIRING MINOR PAINT DAMAGE

Authorized dealers have touch-up paint to match your vehicle's color. Your vehicle color code is printed on a sticker on the front, left-hand side door jamb. Take your color code to your authorized dealer to make sure you get the correct color.

Before repairing minor paint damage, use a cleaner to remove particles such as bird droppings, tree sap, insect deposits, tar spots, road salt and industrial fallout.

Read the instructions before using cleaning products.

WAXING YOUR VEHICLE

Wax the high-gloss painted surface of your prewashed vehicle once or twice a year.

We recommend that you only use an approved quality wax that does not contain abrasives. Follow the manufacturer's instructions to apply and remove the wax. For additional information and assistance, we recommend that you contact an authorized dealer.

When washing and waxing, park your vehicle in a shaded area out of direct sunlight.

Vehicle Care

Note: *Avoid waxing unpainted or low-gloss black colored parts, they discolor over time.*

Storing Your Vehicle

PREPARING YOUR VEHICLE FOR STORAGE

If you plan on storing your vehicle for 30 days or more, the following maintenance recommendations ensures your vehicle stays in good operating condition.

Under various conditions, long-term storage may lead to degraded engine performance or failure unless you use specific precautions to preserve your vehicle.

General

- Store all vehicles in a dry, ventilated place.
- If vehicles are stored outside, they require regular maintenance to protect against rust and weather damage.
- Make sure all linkages, cables, levers and pins under your vehicle are covered with grease to prevent rust.
- Move vehicles at least 25 ft (7.5 m) every 15 days to lubricate working parts and prevent corrosion.
- Fill the fuel tank with high-quality fuel until the first automatic shutoff of the fuel pump nozzle.

Engine

- Change the engine oil and filter prior to storage because used engine oil contains contaminants which may cause engine damage.
- Start the engine every 15 days for a minimum of 15 minutes. Run at fast idle with the climate controls set to defrost until the engine reaches normal operating temperature.
- With your foot on the brake, shift through all the gears while the engine is running.

Body

- Wash your vehicle thoroughly to remove dirt, grease, oil, tar or mud from exterior surfaces, rear-wheel housings and the underside of front fenders.
- Periodically wash your vehicle if it is stored in exposed locations.
- Touch-up exposed or primed metal to prevent rust.
- Cover chrome and stainless steel parts with a thick coat of auto wax to prevent discoloration. Re-wax as necessary when you wash your vehicle.
- Lubricate all hood, door and luggage compartment hinges and latches with a light grade oil.
- Cover interior trim to prevent fading.
- Keep all rubber parts free from oil and solvents.

Hybrid Battery Systems

We recommend the following actions for your vehicle:

- When storing your vehicle for greater than 30 days the state of charge should be approximately 50%. Additionally we recommend disconnecting the 12V battery which will reduce system loads on the HV battery.

12 Volt Battery

- Check and recharge as necessary. Keep connections clean.

Note: *It is necessary to reset memory features if you disconnect the battery cables.*

Brakes

Make sure the brakes and parking brake release fully.

Storing Your Vehicle

Note: *If you intend on parking your vehicle for an extended period after cleaning the wheels with a wheel cleaner, drive your vehicle for a few minutes before doing so to reduce the risk of increased corrosion of the brake discs, brake pads and linings.*

Tires

- Maintain recommended air pressure.

Note: *If you intend on parking your vehicle for an extended period after cleaning the wheels with a wheel cleaner, drive your vehicle for a few minutes before doing so. This reduces the risk of corrosion of the brake discs, brake pads and linings.*

- Check fluid levels (including coolant, oil and gas) to make sure there are no leaks, and fluids are at recommended levels.
- If you remove the battery, clean the battery cable ends and check for damage.

Contact an authorized dealer if you have any concerns or issues.

REMOVING YOUR VEHICLE FROM STORAGE

When your vehicle is ready to come out of storage, do the following:

- We recommend that you change the engine oil before you use your vehicle again.
- Wash your vehicle to remove any dirt or grease film build-up on window surfaces.
- Check windshield wipers for any deterioration.
- Check under the hood for any foreign material that may have collected during storage such as mice or squirrel nests.
- Check the exhaust for any foreign material that may have collected during storage.
- Check tire pressures and set tire inflation per the Tire Label.
- Check brake pedal operation. Drive your vehicle 15 ft (4.5 m) back and forth to remove rust build-up.

Wheel and Tire Information

LOCATING THE TIRE LABEL

You will find a Tire Label containing tire inflation pressure by tire size and other important information located on the B-Pillar or the edge of the driver's door. See **Locating the Safety Compliance Certification Labels** (page 272).

DEPARTMENT OF TRANSPORTATION UNIFORM TIRE QUALITY GRADES



Tire Quality Grades apply to new pneumatic passenger car tires. The Quality grades can be found where applicable on the tire sidewall between tread shoulder and maximum section width. For example: **Treadwear 200 Traction AA Temperature A.**

These Tire Quality Grades are determined by standards that the United States Department of Transportation has set.

Tire Quality Grades apply to new pneumatic passenger car tires. They do not apply to deep tread, winter-type snow tires, space-saver or temporary use spare tires, light truck or LT type tires, tires with nominal rim diameters of 10 to 12 inches or limited production tires as defined in Title 49 Code of Federal Regulations Part 575.104 (c)(2).

U.S. Department of Transportation Tire quality grades: The U.S. Department of Transportation requires us to give you the following information about tire grades exactly as the government has written it.

Treadwear

The treadwear grade is a comparative rating based on the wear rate of the tire when tested under controlled conditions on a specified government test course. For example, a tire graded 150 would wear 1½ times as well on the government course as a tire graded 100. The relative performance of tires depends upon the actual conditions of their use, however, and may depart significantly from the norm due to variations in driving habits, service practices, and differences in road characteristics and climate.

Wheel and Tire Information

Traction AA A B C



WARNING: The traction grade assigned to this tire is based on straight-ahead braking traction tests, and does not include acceleration, cornering, hydroplaning or peak traction characteristics.

The traction grades, from highest to lowest are AA, A, B, and C. The grades represent the tire's ability to stop on wet pavement as measured under controlled conditions on specified government test surfaces of asphalt and concrete. A tire marked C may have poor traction performance.

Temperature A B C



WARNING: The temperature grade for this tire is established for a tire that is properly inflated and not overloaded. Excessive speed, underinflation, or excessive loading, either separately or in combination, can cause heat buildup and possible tire failure.

The temperature grades are A (the highest), B and C, representing the tire's resistance to the generation of heat and its ability to dissipate heat when tested under controlled conditions on a specified indoor laboratory

test wheel. Sustained high temperature can cause the material of the tire to degenerate and reduce tire life, and excessive temperature can lead to sudden tire failure. The grade C corresponds to a level of performance which all passenger car tires must meet under the Federal Motor Vehicle Safety Standard No. 139. Grades B and A represent higher levels of performance on the laboratory test wheel than the minimum required by law.

INFORMATION ON THE TIRE SIDEWALL

Both United States and Canada Federal regulations require tire manufacturers to place standardized information on the sidewall of all tires. This information identifies and describes the fundamental characteristics of the tire and also provides a U.S. DOT Tire Identification Number for safety standard certification and in case of a recall.

Wheel and Tire Information

Information on P Type Tires

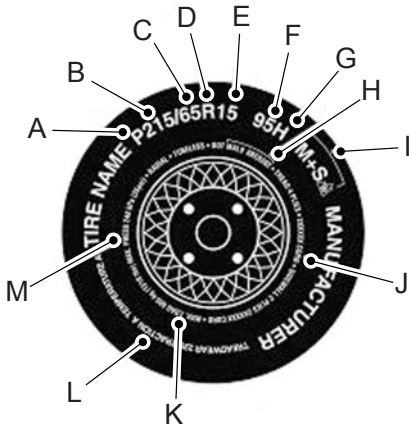

P215/65R15 95H is an example of a tire size, load index and speed rating. The definitions of these items are listed below. (Note that the tire size, load index and speed rating for your vehicle may be different from this example.)

A. **P:** Indicates a tire, designated by the Tire and Rim Association, that may be used for service on cars, sport utility vehicles, minivans and light trucks. **Note:** If your tire size does not begin with a letter this may mean it is designated by either the European Tire and Rim Technical Organization or the Japan Tire Manufacturing Association.

B. **215:** Indicates the nominal width of the tire in millimeters from sidewall edge to sidewall edge. In general, the larger the number, the wider the tire.

C. **65:** Indicates the aspect ratio which gives the tire's ratio of height to width.

D. **R:** Indicates a radial type tire.

E. **15:** Indicates the wheel or rim diameter in inches. If you change your wheel size, you will have to purchase new tires to match the new wheel diameter.

F. **95:** Indicates the tire's load index. It is an index that relates to how much weight a tire can carry. You may find this information in your owner's manual. If not, contact a local tire dealer.

Note: You may not find this information on all tires because it is not required by federal law.

G. **H:** Indicates the tire's speed rating. The speed rating denotes the speed at which a tire is designed to be driven for extended periods of time under a standard condition of load and inflation pressure. The tires on your vehicle may operate at different conditions for load and inflation pressure. These speed ratings may need to be adjusted for the difference in conditions. The ratings range from 81 mph (130 km/h) to 186 mph (299 km/h). These ratings are listed in the following chart.

Wheel and Tire Information

Note: You may not find this information on all tires because it is not required by federal law.

Letter rating	Speed rating
M	81 mph (130 km/h)
N	87 mph (140 km/h)
Q	99 mph (159 km/h)
R	106 mph (171 km/h)
S	112 mph (180 km/h)
T	118 mph (190 km/h)
U	124 mph (200 km/h)
H	130 mph (210 km/h)
V	149 mph (240 km/h)
W	168 mph (270 km/h)
Y	186 mph (299 km/h)

Note: For tires with a maximum speed capability over 149 mph (240 km/h), tire manufacturers sometimes use the letters ZR. For those with a maximum speed capability over 186 mph (299 km/h), tire manufacturers always use the letters ZR.

H. U.S. DOT Tire Identification Number (TIN): This begins with the letters DOT and indicates that the tire meets all federal standards. The next two numbers or letters are the plant code designating where it was manufactured, the next two are

the tire size code and the last four numbers represent the week and year the tire was built. For example, the numbers 317 mean the 31st week of 1997. After 2000, the numbers go to four digits. For example, 2501 means the 25th week of 2001. The numbers in between are identification codes used for traceability. This information is used to contact customers if a tire defect requires a recall.

I. M+S or M/S: Mud and Snow, or

AT: All Terrain, or

AS: All Season.

J. Tire Ply Composition and Material Used: Indicates the number of plies or the number of layers of rubber-coated fabric in the tire tread and sidewall. Tire manufacturers also must indicate the ply materials in the tire and the sidewall, which include steel, nylon, polyester, and others.

K. Maximum Load: Indicates the maximum load in kilograms and pounds that can be carried by the tire. See the Safety Compliance Certification Label (affixed to either the door hinge pillar, door-latch post, or the door edge that meets the door-latch post, next to the driver's seating position), for the correct tire pressure for your vehicle.

L. Treadwear, Traction and Temperature Grades:

Wheel and Tire Information

***Treadwear:** The treadwear grade is a comparative rating based on the wear rate of the tire when tested under controlled conditions on a specified government test course. For example, a tire graded 150 would wear one and one-half times as well on the government course as a tire graded 100.

***Traction:** The traction grades, from highest to lowest are AA, A, B, and C. The grades represent the tire's ability to stop on wet pavement as measured under controlled conditions on specified government test surfaces of asphalt and concrete. A tire marked C may have poor traction performance.

***Temperature:** The temperature grades are A (the highest), B and C, representing the tire's resistance to the generation of heat and its ability to dissipate heat when tested under controlled conditions on a specified indoor laboratory test wheel.

M. Maximum Inflation

Pressure: Indicates the tire manufacturers' maximum permissible pressure or the pressure at which the maximum load can be carried by the tire. This pressure is normally higher than the vehicle manufacturer's recommended cold inflation pressure which can be found on the Safety Compliance Certification Label (affixed to either the door hinge pillar,

door-latch post, or the door edge that meets the door-latch post, next to the driver's seating position), or Tire Label which is located on the B-Pillar or the edge of the driver's door. The cold inflation pressure should never be set lower than the recommended pressure on the vehicle label.

The tire suppliers may have additional markings, notes or warnings such as standard load or radial tubeless.

Additional Information Contained on the Tire Sidewall for LT Type Tires

Note: *Tire Quality Grades do not apply to this type of tire.*

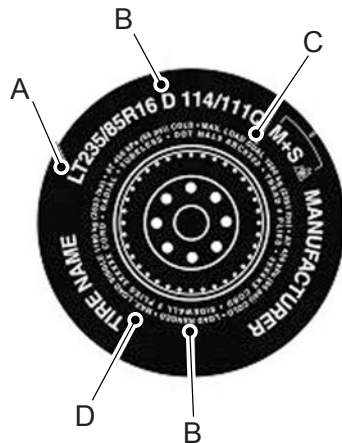

Wheel and Tire Information

LT type tires have some additional information beyond those of P type tires; these differences are described below.

A. **LT:** Indicates a tire, designated by the Tire and Rim Association, that is intended for service on light trucks.

B. **Load Range and Load Inflation Limits:** Indicates the tire's load-carrying capabilities and its inflation limits.

C. **Maximum Load Dual lb (kg) at psi (kPa) cold:** Indicates the maximum load and tire pressure when the tire is used as a dual, defined as four tires on the rear axle (a total of six or more tires on the vehicle).

D. **Maximum Load Single lb (kg) at psi (kPa) cold:** Indicates the maximum load and tire pressure when the tire is used as a single, defined as two tires (total) on the rear axle.

Information on T Type Tires

T145/80D16 is an example of a tire size.

Note: *The temporary tire size for your vehicle may be different from this example. Tire Quality Grades do not apply to this type of tire.*

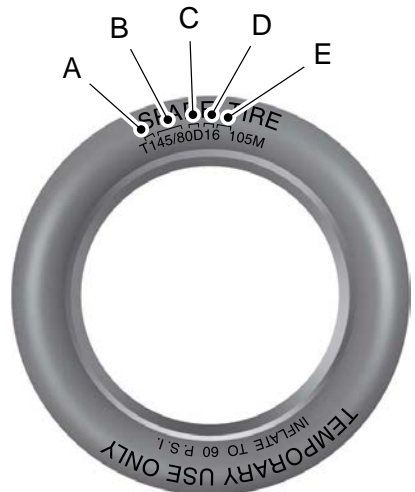

T type tires have some additional information beyond those of P type tires; these differences are described below:

A. **T:** Indicates a type of tire, designated by the Tire and Rim Association, that is intended for temporary service on cars, sport utility vehicles, minivans and light trucks.

B. **145:** Indicates the nominal width of the tire in millimeters from sidewall edge to sidewall edge. In general, the larger the number, the wider the tire.

Wheel and Tire Information

C. **80:** Indicates the aspect ratio which gives the tire's ratio of height to width. Numbers of 70 or lower indicate a short sidewall.

D. **D:** Indicates a diagonal type tire.

R: Indicates a radial type tire.

E. **16:** Indicates the wheel or rim diameter in inches. If you change your wheel size, you will have to purchase new tires to match the new wheel diameter.

GLOSSARY OF TIRE TERMINOLOGY

***Tire label:** A label showing the original equipment tire sizes, recommended inflation pressure and the maximum weight the vehicle can carry.

***Tire Identification Number (TIN):** A number on the sidewall of each tire providing information about the tire brand and manufacturing plant, tire size and date of manufacture. Also referred to as DOT code.

***Inflation pressure:** A measure of the amount of air in a tire.

***Standard load:** A class of P-metric or Metric tires designed to carry a maximum load at set pressure. For example: For P-metric tires 35 psi (2.4 bar) and for Metric tires 36 psi (2.5 bar). Increasing the inflation pressure beyond this pressure will not increase the tire's load carrying capability.

***Extra load:** A class of P-metric or Metric tires designed to carry a heavier maximum load at 42 psi (2.9 bar). Increasing the inflation pressure beyond this pressure will not increase the tire's load carrying capability.

***kPa:** Kilopascal, a metric unit of air pressure.

***PSI:** Pounds per square inch, a standard unit of air pressure.

***Cold tire pressure:** The tire pressure when the vehicle has been stationary and out of direct sunlight for an hour or more and prior to the vehicle being driven for 1 mi (1.6 km).

***Recommended inflation pressure:** The cold inflation pressure found on the Safety Compliance Certification Label (affixed to either the door hinge pillar, door-latch post, or the door edge that meets the door-latch post, next to the driver's seating position), or Tire Label located on the B-Pillar or the edge of the driver door.

***B-pillar:** The structural member at the side of the vehicle behind the front door.

***Bead area of the tire:** Area of the tire next to the rim.

***Sidewall of the tire:** Area between the bead area and the tread.

Wheel and Tire Information

***Tread area of the tire:** Area of the perimeter of the tire that contacts the road when mounted on the vehicle.

***Rim:** The metal support (wheel) for a tire or a tire and tube assembly upon which the tire beads are seated.

TIRE REPLACEMENT REQUIREMENTS

AGE



WARNING: Tires degrade over time depending on many factors such as weather, storage conditions, and conditions of use (load, speed, inflation pressure) the tires experience throughout their lives.

In general, tires should be replaced after six years regardless of tread wear. However, heat caused by hot climates or frequent high loading conditions can accelerate the aging process and may require tires to be replaced more frequently.

You should replace your spare tire when you replace the road tires or after six years due to aging even if it has not been used.

U.S. DOT Tire Identification Number

Both United States and Canada Federal regulations require tire manufacturers to place standardized information on the sidewall of all tires. This information identifies and describes the fundamental characteristics of the tire and also provides a U.S. DOT Tire Identification Number for safety standard certification and in case of a recall.

This begins with the letters DOT and indicates that the tire meets all federal standards. The next two numbers or letters are the plant code designating where it was manufactured, the next two are the tire size code and the last four numbers represent the week and year the tire was built. For example, the numbers 317 mean the 31st week of 1997. After 2000, the numbers go to four digits. For example, 2501 means the 25th week of 2001. The numbers in between are identification codes used for traceability. This information is used to contact customers if a tire defect requires a recall.

Tire Replacement Requirements

Your vehicle is equipped with tires designed to provide a safe ride and handling capability.

Wheel and Tire Information



WARNING: Only use replacement tires and wheels that are the same size, load index, speed rating and type (such as P-metric versus LT-metric or all-season versus all-terrain) as those originally provided by Ford. The recommended tire and wheel size may be found on either the Safety Compliance Certification Label (affixed to either the door hinge pillar, door-latch post, or the door edge that meets the door-latch post, next to the driver's seating position), or the Tire Label which is located on the B-Pillar or edge of the driver's door. If this information is not found on these labels, then you should contact your authorized dealer as soon as possible. Use of any tire or wheel not recommended by Ford can affect the safety and performance of your vehicle, which could result in an increased risk of loss of vehicle control, vehicle rollover, personal injury and death.



WARNING: To reduce the risk of serious injury, when mounting replacement tires and wheels, you should not exceed the maximum pressure indicated on the sidewall of the tire to set the beads without additional precautions listed below. If the beads do not seat at the maximum pressure indicated, re-lubricate and try again.



WARNING: For a mounting pressure more than 20 psi (1.38 bar) greater than the maximum pressure, a Ford dealer or other tire service professional should do the mounting.



WARNING: Always inflate steel carcass tires with a remote air fill with the person inflating standing at a minimum of 12 ft (3.66 m) away from the wheel and tire assembly.



WARNING: When inflating the tire for mounting pressures up to 20 psi (1.38 bar) greater than the maximum pressure on the tire sidewall, the following precautions must be taken to protect the person mounting the tire:

- Make sure that you have the correct tire and wheel size.
- Lubricate the tire bead and wheel bead seat area again.

Wheel and Tire Information

- Stand at a minimum of 12 ft (3.66 m) away from the wheel and tire assembly.
- Use both eye and ear protection.

Important: Remember to replace the wheel valve stems when the road tires are replaced on your vehicle.

If a four tire rotation is being followed, it is recommended that both front tires or both rear tires generally be replaced as a pair if the two remaining worn tires still have usable tread depth. If a five tire rotation is being followed and the fifth tire is used to replace a single unrepairable tire, a four tire rotation should be followed with the undamaged tires. Any replacement for the damaged tire should be used as a dedicated spare until the remaining tires are replaced as a set.

To avoid potential Four-Wheel Drive (4WD) malfunction or (4WD) system damage, it is recommended to replace all tires used in the tire rotation rather than mixing significantly worn tires with new tires.

The tire pressure sensors mounted in the wheels (originally installed on your vehicle) are not designed to be used in aftermarket wheels.

The use of wheels or tires not recommended may affect the operation of your tire pressure monitoring system.

If the tire pressure monitoring system indicator is flashing, your system is malfunctioning. Your replacement tire might be incompatible with your tire pressure monitoring system, or some component of the system may be damaged.

USING SNOW CHAINS



WARNING: Do not exceed 30 mph (50 km/h). Failure to follow this instruction could result in the loss of control of your vehicle, personal injury or death.



WARNING: Do not use snow chains on snow-free roads.



WARNING: Only fit snow chains to specified tires.



WARNING: If your vehicle is fitted with wheel trims, remove them before fitting snow chains.



WARNING: If you choose to install snow tires on your vehicle, they must be the same size, construction, and load range as the original tires listed on the tire placard, and they must be installed on all four wheels. Mixing tires of different size or construction on your vehicle can adversely affect your vehicle's handling and braking, and may lead to loss of vehicle control.

Only use snow chains on rear wheels. Install snow chains in pairs. Do not use self-tensioning snow chains.

Only use snow chains on the following specified tire sizes:

Wheel and Tire Information

- 255/70R16
 - Only install chains that are 15 mm or less.
- 255/75R17
 - Only install chains that are 15 mm or less.

We recommend you use steel wheels of the same size and specification if snow chains are required because chains may chip aluminum wheels.

Follow these guidelines when using snow tires and traction devices:

- If possible, avoid fully loading your vehicle.
 - Purchase snow chains from a manufacturer that clearly labels body to tire dimension restrictions.
- When driving with snow chains do not exceed 30 mph (50 km/h) or the maximum speed recommended by the chain manufacturer, whichever is less.
 - Drive cautiously. If you hear the snow chains rub or bang against the vehicle, stop and tighten them. If this does not work, remove the snow chains to prevent vehicle damage.
 - Remove the snow chains when they are no longer needed. Do not use snow chains on dry roads.
 - If a temporary spare wheel is mounted on your vehicle, do not use snow chains on the axle with the temporary spare wheel.

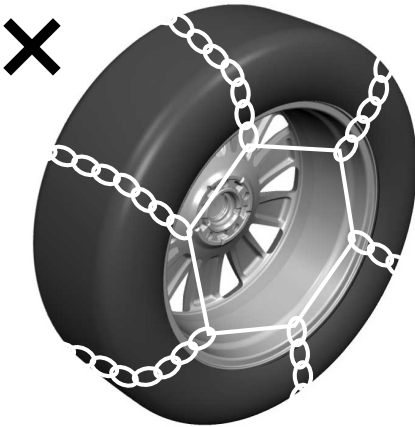

Use snow chains that fit against the sidewall of the tire to prevent the chains from touching the wheel rims or suspension, see following illustration above.

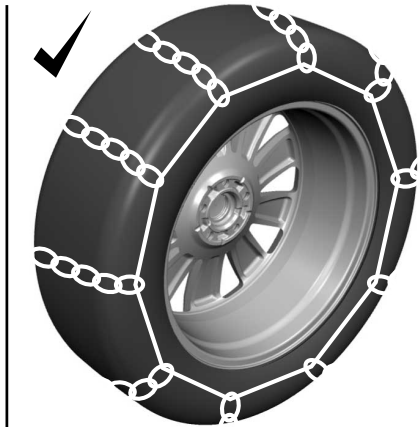

If you have any questions regarding snow chains, please contact your authorized dealer.

Tire Care

CHECKING THE TIRE PRESSURES

Safe operation of your vehicle requires that your tires are properly inflated. Every day before you drive, check your tires.

At least once a month and before long trips, inspect each tire and check the tire pressure with a tire gauge. Inflate all tires to the recommended inflation pressure. See **Inflating the Tires** (page 379).

INFLATING THE TIRES



WARNING: Under-inflation is the most common cause of tire failures and may result in severe tire cracking, tread separation or blowout, with unexpected loss of vehicle control and increased risk of injury. Under-inflation increases sidewall flexing and rolling resistance, resulting in heat buildup and internal damage to the tire. It also may result in unnecessary tire stress, irregular wear, loss of vehicle control and accidents. A tire can lose up to half of its air pressure and not appear to be flat!



WARNING: Do not use the tire pressure displayed in the information display as a tire pressure gauge. Failure to follow this instruction could result in personal injury or death.

Use the recommended cold inflation pressure for optimum tire performance and wear. Under-inflation or over-inflation may cause uneven treadwear patterns.

Inflate your tires to the recommended inflation pressure even if it is less than the maximum inflation pressure information found on the tire. You can find the tire label with the recommended tire inflation pressure next to the tire size on the B-Pillar or the edge of the driver door.

The recommended tire inflation pressure is also found on the Safety Compliance Certification Label, affixed to either the door hinge pillar, door-latch post, or the door edge that meets the door-latch on the B-pillar, or on the edge of the driver door.

Failure to follow the tire pressure recommendations can cause uneven treadwear patterns and adversely affect the way your vehicle handles.

Tire Care

INSPECTING THE TIRE FOR WEAR

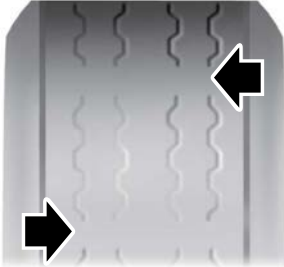

When the tread is worn down to one sixteenth of an inch (2 mm), tires must be replaced to help prevent your vehicle from skidding and hydroplaning. Built-in treadwear indicators, or wear bars, which look like narrow strips of smooth rubber across the tread will appear on the tire when the tread is worn down to one sixteenth of an inch (2 mm).

When the tire tread wears down to the same height as these wear bars, the tire is worn out and must be replaced.

The tires should also be balanced periodically. An unbalanced tire and wheel assembly may result in irregular tire wear.

Periodically inspect the tire treads for uneven or excessive wear and remove objects such as stones, nails or glass that may be wedged in the tread grooves.

INSPECTING THE TIRE FOR DAMAGE

Inspect the tire sidewalls for cracking, cuts, bruises and other signs of damage or excessive wear. If internal damage to the tire is suspected, have the tire dismantled and inspected in case it needs to be repaired or replaced. For your safety, tires that are damaged or show signs of excessive wear should not be used because they are more likely to blow out or fail.

Periodically inspect the tire treads and sidewalls for damage, such as bulges in the tread or sidewalls, cracks in the tread groove and separation in the tread or sidewall. If damage is observed or suspected, have the tire inspected by a tire professional.

Safety Practices



WARNING: If your vehicle is stuck in snow, mud or sand, do not rapidly spin the tires; spinning the tires can tear the tire and cause an explosion. A tire can explode in as little as three to five seconds.



WARNING: Do not spin the wheels at over 34 mph (55 km/h). The tires may fail and injure a passenger or bystander.

Tire Care

Highway Hazards

No matter how carefully you drive, there is always the possibility that you could eventually have a flat tire on the highway. Drive slowly to the closest safe area out of traffic. This could further damage the flat tire, but your safety is more important.

If you feel a sudden vibration or ride disturbance while driving, or you suspect your tire or vehicle has been damaged, immediately reduce your speed. Drive with caution until you can safely pull off the road. Stop and inspect the tires for damage. If a tire is under-inflated or damaged, deflate it, remove the wheel and replace it with your spare tire and wheel. If you cannot detect a cause, have the vehicle towed to the nearest repair facility or tire dealer to have the vehicle inspected.

Tire and Wheel Alignment

A bad jolt from hitting a curb or pothole can cause the front end of your vehicle to become misaligned or cause damage to your tires. If your vehicle seems to pull to one side when you are driving, the wheels could be out of alignment. Have an authorized dealer check the wheel alignment periodically.

Wheel misalignment in the front or the rear can cause uneven and rapid treadwear of your tires and should be corrected by an authorized dealer.

INSPECTING THE WHEEL VALVE STEMS

Check the valve stems for holes, cracks, or cuts that could permit air leakage.

TIRE ROTATION



WARNING: If the tire label shows different tire pressures for the front and rear tires and the vehicle has a tire pressure monitoring system, then you need to update the settings for the system sensors. Always perform the system reset procedure after tire rotation. If you do not reset the system, it may not provide a low tire pressure warning when necessary.

Note: *If your tires show uneven wear ask an authorized dealer to check for and correct any wheel misalignment, tire imbalance or mechanical problem involved before tire rotation.*

Note: *After having your tires rotated, inflation pressure must be checked and adjusted to the vehicle requirements.*

Tire Care

Rotating your tires at the recommended interval, as indicated in the scheduled maintenance chapter, will help your tires wear more evenly, providing better tire performance and longer tire life.

For the best tire life, a five tire rotation is recommended that includes the matching spare tire mounted on the back of the vehicle. This rotation requires a forced re-learning of your tire pressure monitor system sensors by your vehicle, and should be performed by an authorized dealer or a service center to ensure the tire pressure monitor system will provide proper warning at all times. When performing the tire rotation yourself, a four tire rotation is recommended, without using the spare tire in the rotation, so that no tire pressure monitor system sensor re-learn is required. If a five tire rotation is performed without a tire pressure monitor system sensor re-learn, the system may not provide a low tire pressure warning when necessary.

Keep in mind that a spare tire that is not used in the tire rotation should only be used temporarily in the event of a flat tire, not as a permanent replacement. The spare tire should always be replaced if it exceeds 6 years of age, regardless of whether it is part of the tire rotation.

Rear-wheel drive vehicles and four-wheel drive vehicles with four tire rotation, front tires at left of diagram.

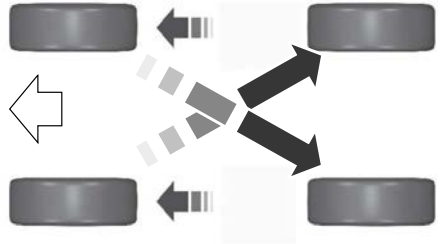

Sometimes irregular tire wear can be corrected by rotating the tires.

Tire Pressure Monitoring System

WHAT IS THE TIRE PRESSURE MONITORING SYSTEM



The tire pressure monitoring system measures the vehicle's tire pressures. A warning lamp illuminates if one or more tires are significantly underinflated or if there is a system malfunction.

TIRE PRESSURE MONITORING SYSTEM OVERVIEW



WARNING: If the tire pressure monitor sensor becomes damaged it may not function.



WARNING: Under-inflation is the most common cause of tire failures and may result in severe tire cracking, tread separation or blowout, with unexpected loss of vehicle control and increased risk of injury. Under-inflation increases sidewall flexing and rolling resistance, resulting in heat buildup and internal damage to the tire. It also may result in unnecessary tire stress, irregular wear, loss of vehicle control and accidents. A tire can lose up to half of its air pressure and not appear to be flat!



WARNING: To determine the required pressure(s) for your vehicle, see the Safety Compliance Certification Label (on the door hinge pillar, door-latch post or the door edge that meets the door-latch post, next to the driver seat) or the Tire Label on the B-Pillar or the edge of the driver door.

Each tire, including the spare (if provided), should be checked monthly when cold and inflated to the inflation pressure recommended by the vehicle manufacturer on the vehicle placard or tire inflation pressure label. (If your vehicle has tires of a different size than the size indicated on the vehicle placard or tire inflation pressure label, you should determine the proper tire inflation pressure for those tires).

As an added safety feature, your vehicle has been equipped with a Tire Pressure Monitoring System (TPMS) that illuminates a low tire pressure telltale when one or more of your tires is significantly under-inflated. Accordingly, when the low tire pressure telltale illuminates, you should stop and check your tires as soon as possible, and inflate them to the proper pressure. Driving on a significantly under-inflated tire causes the tire to overheat and can lead to tire failure. Under-inflation also reduces fuel efficiency and tire tread life, and may affect the vehicle's handling and stopping ability.

Please note that the TPMS is not a substitute for proper tire maintenance, and it is the driver's responsibility to maintain correct tire pressure, even if under-inflation has not reached the level to trigger illumination of the TPMS low tire pressure telltale.

Your vehicle has also been equipped with a TPMS malfunction indicator to indicate when the system is not operating properly. The TPMS malfunction indicator is combined with the low tire pressure telltale. When the system detects a malfunction, the telltale will flash for approximately one minute and then remain continuously illuminated. This sequence will continue upon subsequent vehicle start-ups as long as the malfunction exists.

Tire Pressure Monitoring System

When the malfunction indicator is illuminated, the system may not be able to detect or signal low tire pressure as intended. TPMS malfunctions may occur for a variety of reasons, including the installation of replacement or alternate tires or wheels on the vehicle that prevent the TPMS from functioning properly. Always check the TPMS malfunction telltale after replacing one or more tires or wheels on your vehicle to ensure that the replacement or alternate tires and wheels allow the TPMS to continue to function properly.



WARNING: Changes or modifications not expressly approved by the party responsible for compliance could void the user's authority to operate the equipment. The term "IC:" before the radio certification number only signifies that Industry Canada technical specifications were met.

This device complies with Part 15 of the FCC Rules and with License exempt RSS Standards of Industry Canada. Operation is subject to the following two conditions:

1. This device may not cause harmful interference, and
2. This device must accept any interference received, including interference that may cause undesired operation.

TIRE PRESSURE MONITORING SYSTEM PRECAUTIONS



WARNING: The tire pressure monitoring system is not a substitute for manually checking tire pressures. You should periodically check tire pressures using a pressure gauge. Failure to correctly maintain tire pressures could increase the risk of tire failure, loss of control, vehicle rollover and personal injury.



WARNING: Do not use the tire pressure displayed in the information display as a tire pressure gauge. Failure to follow this instruction could result in personal injury or death.

Note: *The use of tire sealants can damage the tire pressure monitoring system.*

TIRE PRESSURE MONITORING SYSTEM LIMITATIONS

When the outside temperature drops significantly, the tire pressure could decrease and activate the low tire pressure warning lamp.

The warning lamp could also illuminate when you use a spare wheel, or tire sealant from the inflator kit.

Note: *Regularly checking the vehicle tire pressures can reduce the possibility for the warning lamp to illuminate due to outside air temperature changes.*

Note: *After you inflate the tires to the recommended pressure it could take up to two minutes of driving over 20 mph (32 km/h) for the warning indicator to turn off.*

Tire Pressure Monitoring System

VIEWING THE TIRE PRESSURES

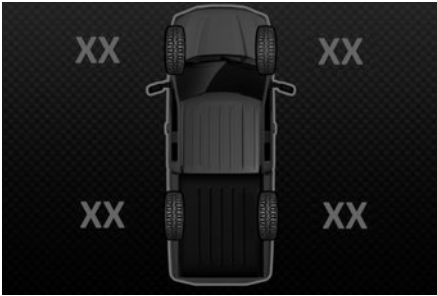

Using the information display arrow keys navigate to the truck info section where you can view the tire pressures.

TIRE PRESSURE MONITORING SYSTEM – TROUBLESHOOTING

TIRE PRESSURE MONITORING SYSTEM – WARNING LAMPS



The low tire pressure warning lamp has combined functions, as it warns you when your tires need air, and when the system is no longer capable of functioning as intended.

Warning Lamp	Possible Cause	Action Required
Solid warning lamp	One or more tires are significantly under inflated	After inflating your tires to the manufacturer's recommended pressure as shown on the tire label, on the edge of driver door or the B-pillar, drive your vehicle for at least two minutes over 20 mph (32 km/h) before the light turns off.
Solid warning lamp or flashing warning lamp	Temporary spare wheel in use	Repair the damaged road wheel and tire and refit it to your vehicle to restore operation of the system.
	Tire pressure monitoring system malfunction	If the tires are inflated to the recommended tire pressures and the temporary spare wheel is not in use, the system detected a fault that requires service. Have your vehicle checked as soon as possible.

Tire Pressure Monitoring System

TIRE PRESSURE MONITORING SYSTEM – INFORMATION MESSAGES

Message	Action
Tire Pressure Low	After inflating your tires to the manufacturer's recommended pressure as shown on the tire label, on the edge of the driver door or the B-pillar, drive your vehicle for at least two minutes over 20 mph (32 km/h) before the light turns off.
Tire Pressure Monitor Fault	The system has detected a fault that requires service. Have your vehicle checked as soon as possible.
Tire Pressure Sensor Fault	The system has detected a fault that requires service or a spare tire is in use. Have your vehicle checked as soon as possible.

Changing a Road Wheel

CHANGING A FLAT TIRE

Note: You should only use tire sealants in roadside emergencies as they may cause damage to the tire pressure monitoring system sensor.

Note: The tire pressure monitoring system indicator light illuminates when the spare tire is in use. To restore the full function of the monitoring system, all road wheels equipped with tire pressure monitoring sensors must be mounted on the vehicle.

If you get a flat tire when driving, do not apply the brake heavily. Instead, gradually decrease your speed. Hold the steering wheel firmly and slowly move to a safe place on the side of the road.

Have a flat serviced by an authorized dealer in order to prevent damage to the tire pressure monitoring system sensors. Replace the spare tire with a road tire as soon as possible. During repairing or replacing of the flat tire, have the authorized dealer inspect the tire pressure monitoring system sensor for damage.

Tire Change Procedure

 **WARNING:** Failure to follow these guidelines could result in an increased risk of loss of vehicle control, injury or death.

 **WARNING:** Do not get under a vehicle that is only supported by a vehicle jack.

 **WARNING:** The jack supplied with this vehicle is only intended for changing wheels. Do not use the vehicle jack other than when you are changing a wheel in an emergency.

 **WARNING:** Check that the vehicle jack is not damaged or deformed and the thread is lubricated and clean.

 **WARNING:** Do not work on your vehicle when the jack is the only support as your vehicle could slip off the jack. Failure to follow this instruction could result in personal injury or death.

 **WARNING:** To help prevent your vehicle from moving when changing a wheel, shift the transmission into park (P), set the parking brake and use an appropriate block or wheel chock to secure the wheel diagonally opposite to the wheel being changed. For example, when changing the front left wheel, place an appropriate block or wheel chock on the right rear wheel.

 **WARNING:** Always use the jack provided as original equipment with your vehicle. If using a jack other than the one provided, make sure the jack capacity is adequate for the vehicle weight, including any vehicle cargo or modifications. If you are unsure if the jack capacity is adequate, contact the authorized dealer.

 **WARNING:** Use only the specified jacking points. If you use other positions, you may damage the body, steering, suspension, engine, braking system or the fuel lines.

 **WARNING:** Never place anything between the vehicle jack and your vehicle.

 **WARNING:** Never place anything between the vehicle jack and the ground.

Changing a Road Wheel

WARNING: Park your vehicle so that you do not obstruct the flow of traffic or place yourself in any danger and set up a warning triangle.

WARNING: Do not attempt to change a tire on the side of the vehicle close to moving traffic. Pull far enough off the road to avoid the danger of being hit when operating the jack or changing the wheel.

Note: Passengers should not remain in your vehicle when the vehicle is being jacked.

Note: Jack at the specified locations to avoid damage to the vehicle.

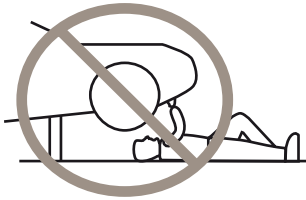

Note: No maintenance or additional lubrication of your jack is required over the service life of your vehicle.

1. Park the vehicle on a level firm ground and activate the hazard flashers.
2. Apply the parking brake, and place the transmission in park (P) for an automatic transmission or reverse (R) for a manual transmission and turn the engine off.
3. Block the wheel diagonally opposite of the flat tire. For example, if the left front is flat, block the right rear wheel.

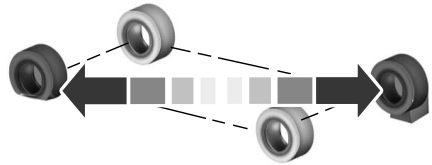

4. Find the jack and tool kit in the rear trunk of the vehicle. Turn the jack retainer counterclockwise to remove the jack and jack extension block.

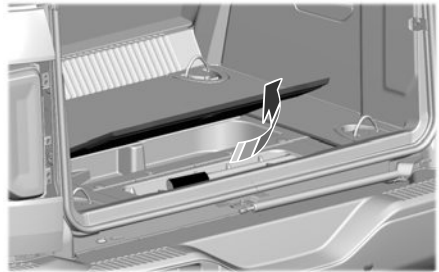

5. Remove the tool bag.

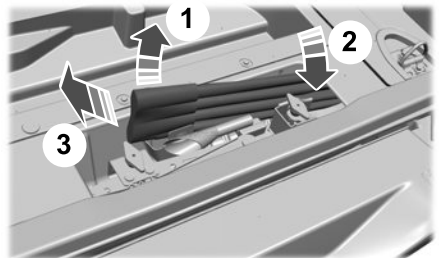

Changing a Road Wheel

6. Remove the lug wrench from the tool bag. Turn the spare tire fasteners counterclockwise starting with the lowest first, and remove the spare tire from the rear of the vehicle.

Note: The wheel lock key must be inserted into the wheel lock nut before the lug wrench can turn the locking nut.

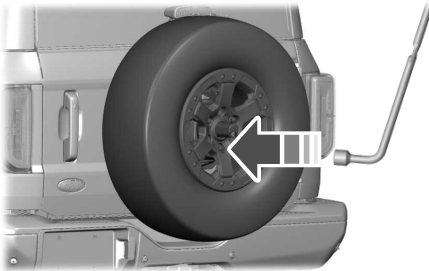

Note: Do not lay the wheel's face down on the ground, as there is a risk of scratching or marring the wheel if laid down on an uneven surface.

7. Loosen each road wheel nut a half a turn counterclockwise, do not remove them until the flat tire is raised off the ground.

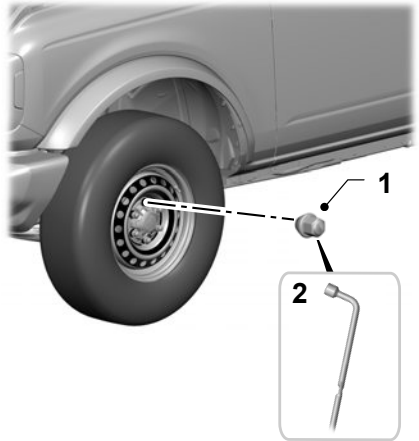

8. When you are changing a flat front tire, connect the extension block to the jack loadrest using the wing bolt as shown. Connect the jack handle to the jack, and use the lug nut wrench to operate the jack.

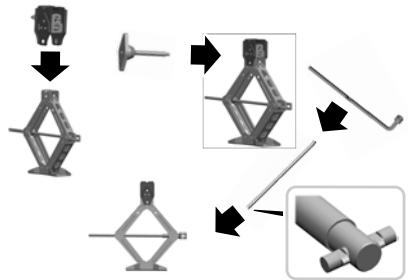

9. Do not use the extension block when you are changing a flat tire on the rear of the vehicle. Assemble the jack handle using the extensions as shown to operate the jack when placing under the rear axle.

Changing a Road Wheel

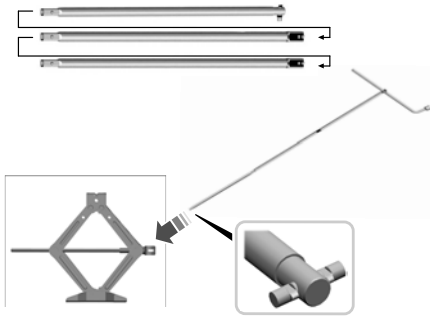

10. The front jacking point location is indicated by an arrow-shaped mark on the frame.

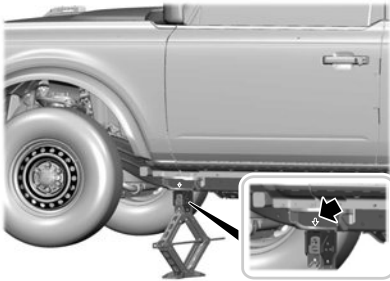

11. Use the rear axle tube for the rear jacking point.

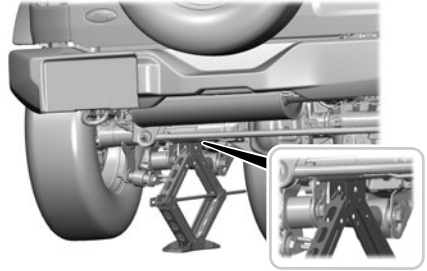

Note: Only use the jack on the specified jacking points and as close to the affected wheel as possible.

12. Place the jack at the jacking point closest to the flat tire you are changing. Turn the lug wrench handle clockwise until the flat tire is completely off the ground.
13. Remove the wheel nuts with the wheel nut wrench.
14. Replace the flat tire with the spare wheel, make sure the wheel is on with the valve stem facing outward.
15. Install the wheel nuts snug against the hub. Do not fully tighten the wheel nuts until the vehicle is lowered back onto the ground.
16. Turn the wrench handle counterclockwise to lower the jack.
17. Remove the jack and fully tighten the lug nuts in the order shown below.

Changing a Road Wheel

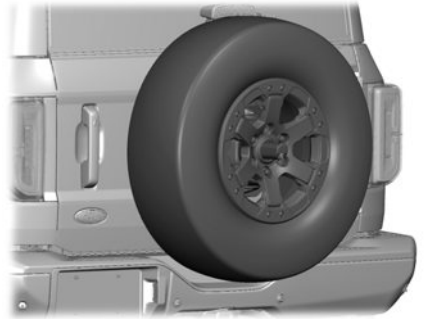
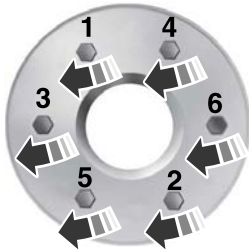

18. Stow the flat tire on the rear of the vehicle and fully tighten the securing nuts.
19. Remove the wheel blocks.
20. Stow the jack and tools in the original locations shown in the removal section and tighten the retaining screws by turning clockwise.

Changing a Road Wheel

WHEEL NUTS

Wheel Nut Torque Specifications



WARNING: When you install a wheel, always remove any corrosion, dirt or foreign materials present on the mounting surfaces of the wheel or the surface of the wheel hub, brake drum or brake disc that contacts the wheel. Make sure to secure any fasteners that attach the rotor to the hub so they do not interfere with the mounting surfaces of the wheel. Installing wheels without correct metal-to-metal contact at the wheel mounting surfaces can cause the wheel nuts to loosen and the wheel to come off while your vehicle is in motion, resulting in loss of vehicle control, personal injury or death.



WARNING: If the tire pressure monitor sensor becomes damaged it may not function.

Bolt size	lb.ft (Nm) *
M12 X 1.5	100 lb.ft (135 Nm)

*Torque specifications are for nut and bolt threads free of dirt and rust. Use only our recommended replacement fasteners.

Retighten the lug nuts to the specified torque within 100 mi (160 km) after any wheel disturbance (such as tire rotation, changing a flat tire, wheel removal).



A Wheel pilot bore

Inspect the wheel pilot bore and mounting surface prior to installation. Remove any visible corrosion or loose particles.

Capacities and Specifications

ENGINE SPECIFICATIONS - 2.3L ECOBOOST™

Engine	Specification
Compression ratio.	10.0:1
Displacement.	138 in ³ (2,261 cm ³)
Firing order.	1-3-4-2
Ignition system.	Coil on plug
Spark plug gap.	0.028 in (0.7 mm) - 0.031 in (0.8 mm)

Capacities and Specifications

ENGINE SPECIFICATIONS - 2.7L ECOBOOST™

Engine	Specification
Compression ratio.	10.0:1
Displacement.	165 in ³ (2,700 cm ³)
Firing order.	1-4-2-5-3-6
Ignition system.	Coil on plug
Spark plug gap.	0.028 in (0.7 mm) - 0.031 in (0.8 mm)

Capacities and Specifications

MOTORCRAFT PARTS - 2.3L ECOBOOST™

Component	Motorcraft Part Number
Air filter element.	FA-2022
Battery.	BAGM-94RH7-800
Cabin air filter.	FP-93
Engine oil filter. ¹	FL-910-S
Spark plug.	SP-578
Transmission fluid filter.	FT-218
Windshield wiper blade-front.	WW-1703
Windshield wiper blade-rear.	WW-801

¹ If a Motorcraft oil filter is not available, use an oil filter that meets industry performance specification SAE/USCAR-36.

We recommend Motorcraft parts that are available at your authorized dealer or at www.parts.ford.com. We engineer these parts for your vehicle to meet or exceed our specifications. Use of other parts could impact vehicle performance, emissions and durability. Your warranty could be void for any damage related to use of other parts.

Capacities and Specifications

MOTORCRAFT PARTS - 2.7L ECOBOOST™

Component	Motorcraft Part Number
Air filter element.	FA-2022
Battery.	BAGM-94RH7-800
Cabin air filter.	FP-93
Engine oil filter. ¹	FL-2062-A
Spark plug.	SP-578
Transmission fluid filter.	FT-218
Windshield wiper blade-front.	WW-1703
Windshield wiper blade-rear.	WW-801

¹ If a Motorcraft oil filter is not available, use an oil filter that meets industry performance specification SAE/USCAR-36.

We recommend Motorcraft parts that are available at your authorized dealer or at www.parts.ford.com. We engineer these parts for your vehicle to meet or exceed our specifications. Use of other parts could impact vehicle performance, emissions and durability. Your warranty could be void for any damage related to use of other parts.

Capacities and Specifications

ENGINE OIL CAPACITY AND SPECIFICATION - 2.3L ECOBOOST™

Use oil that meets the defined specification and viscosity grade.

If you do not use oil that meets the defined specification and viscosity grade, it could result in:

- Component damage that your vehicle warranty does not cover.
- Longer engine cranking periods.
- Increased emission levels.
- Reduced vehicle performance.
- Reduced fuel economy.



An oil that displays this symbol conforms to current engine, emission system and fuel economy performance standards of ILSAC.

We recommend Motorcraft motor oil for your vehicle. If Motorcraft oil is not available, use motor oils of the recommended viscosity grade that meet API SP requirements and display the API Certification Mark for gasoline engines.

Do not use supplemental engine oil additives because they are unnecessary and could lead to engine damage that your vehicle warranty does not cover.

Capacities

Variant	Including the Oil Filter
All.	6.2 qt (5.9 L)

Materials

Name	Specification
Motorcraft® SAE 5W-30 Synthetic Blend Motor Oil(U.S.) Motorcraft® SAE 5W-30 Super Premium Motor Oil / Huile moteur de très haute qualité SAE 5W-30 Motorcraft®(Canada) XO-5W30-Q1SP(U.S.) CXO-5W30-LSP6(Canada)	WSS-M2C961-A1

Capacities and Specifications

Alternative Engine Oil for Extremely Cold Climates

To improve engine cold start performance,

we recommend that you use the following alternative engine oil in extremely cold climates, where the ambient temperature reaches -22.0°F (-30°C) or below.

Materials

Name	Specification
Engine Oil - SAE 0W-30 - Synthetic Blend	WSS-M2C963-A1

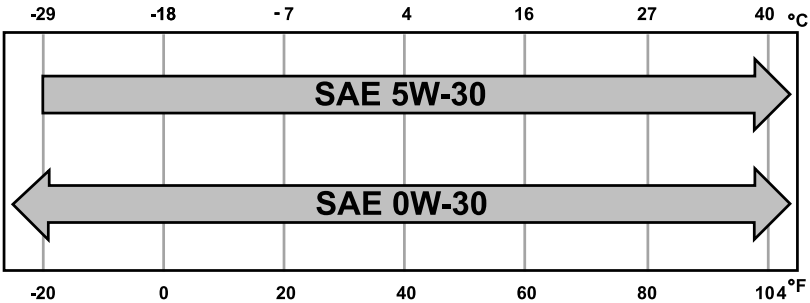

ENGINE OIL CAPACITY AND SPECIFICATION - 2.7L ECOBOOST™

Use oil that meets the defined specification and viscosity grade.

If you do not use oil that meets the defined specification and viscosity grade, it could result in:

- Component damage that your vehicle warranty does not cover.
- Longer engine cranking periods.
- Increased emission levels.
- Reduced vehicle performance.
- Reduced fuel economy.



An oil that displays this symbol conforms to current engine, emission system and fuel economy performance standards of ILSAC.

Capacities and Specifications

We recommend Motorcraft motor oil for your vehicle. If Motorcraft oil is not available, use motor oils of the recommended viscosity grade that meet API SP requirements and display the API

Certification Mark for gasoline engines.

Do not use supplemental engine oil additives because they are unnecessary and could lead to engine damage that your vehicle warranty does not cover.

Capacities

Variant	Including the Oil Filter
All.	7.0 qt (6.6 L)

Materials

Name	Specification
Motorcraft® SAE 5W-30 Synthetic Blend Motor Oil(U.S.) Motorcraft® SAE 5W-30 Super Premium Motor Oil / Huile moteur de très haute qualité SAE 5W-30 Motorcraft®(Canada) XO-5W30-Q1SP(U.S.) CXO-5W30-LSP6(Canada)	WSS-M2C961-A1

Alternative Engine Oil for Extremely Cold Climates

To improve engine cold start performance, we recommend that you use the following alternative engine oil in extremely cold climates, where the ambient temperature reaches -22.0°F (-30°C) or below.

Materials

Name	Specification
Engine Oil - SAE 0W-30 - Synthetic Blend	WSS-M2C963-A1

Capacities and Specifications

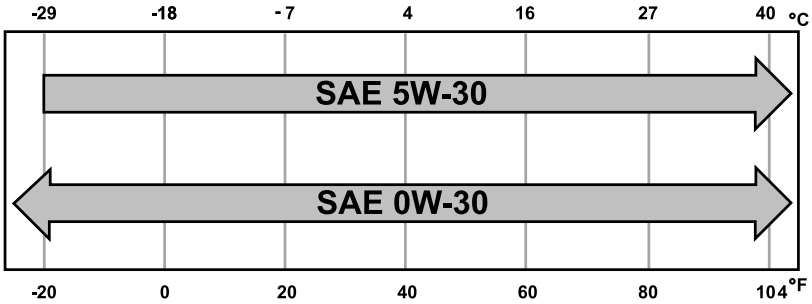

COOLING SYSTEM CAPACITY AND SPECIFICATION - 2.3L ECOBOOST™

Use coolant that meets the defined specification.

If you do not use coolant that meets the defined specification, it could result in:

- Component damage that your vehicle warranty does not cover.
- Reduced vehicle performance.

Capacities

Variant	Quantity
With automatic transmission.	10.5 qt (9.9 L)
With manual transmission.	9.6 qt (9.1 L)

Materials

Name	Specification
Motorcraft® Yellow Prediluted Antifreeze/Coolant (U.S.) Motorcraft® Yellow Prediluted Antifreeze/Coolant / Antigel/liquide de refroidissement prédilué jaune Motorcraft® (Canada) VC-13DL-G (U.S.) CVC-13DL-G (Canada)	WSS-M97B57-A2

Capacities and Specifications

COOLING SYSTEM CAPACITY AND SPECIFICATION - 2.7L ECOBOOST™

Use coolant that meets the defined specification.

If you do not use coolant that meets the defined specification, it could result in:

- Component damage that your vehicle warranty does not cover.
- Reduced vehicle performance.

Capacities

Variant	Quantity
All.	12.4 qt (11.7 L)

Materials

Name	Specification
Motorcraft® Yellow Prediluted Antifreeze/Coolant(U.S.) Motorcraft® Yellow Prediluted Antifreeze/Coolant / Antigel/liquide de refroidissement prédilué jaune Motorcraft®(Canada) VC-13DL-G(U.S.) CVC-13DL-G(Canada)	WSS-M97B57-A2

FUEL TANK CAPACITY

Capacities

Variant	Quantity
Long wheelbase.	21.1 gal (80 L)
Short wheelbase.	17.4 gal (66 L)

Capacities and Specifications

AIR CONDITIONING SYSTEM CAPACITY AND SPECIFICATION



WARNING: The air conditioning refrigerant system contains refrigerant under high pressure. Only qualified personnel should service the air conditioning refrigerant system. Opening

the air conditioning refrigerant system can cause personal injury.

Use refrigerant and oil that meets the defined specifications.

If you do not use refrigerant and oil that meets the defined specifications, it could result in:

- Component damage that your vehicle warranty does not cover.
- Reduced vehicle performance.

Capacities

Variant	Refrigerant
All.	19.4 oz (0.55 kg)

Materials

Name	Specification
R-1234yf Refrigerant(U.S.) R-1234yf Refrigerant / Frigorigène R-1234yf(Canada) YN-33-A(U.S.) HS7Z-19B519-BA(Canada)	WSS-M17B21-A
Motorcraft® R-1234yf Refrigerant PAG Oil(U.S.) Motorcraft® R-1234yf Refrigerant PAG Oil / Huile PAG pour frigorigène R-1234yf Motorcraft®(Canada) YN-35(U.S. & Canada)	WSS-M2C300-A2

WASHER FLUID SPECIFICATION

Capacities

Variant	Quantity
All.	Fill as required.

Capacities and Specifications

Materials

Name	Specification
Motorcraft® Premium Windshield Wash Concentrate with Bitterant(U.S.) Motorcraft® Premium Quality Windshield Washer Fluid / Liquide lave-glace de haute qualité Motorcraft®(Canada) ZC-32-B2(U.S.) CXC-37-F/M(Canada)	WSS-M14P19-A

MANUAL TRANSMISSION FLUID CAPACITY AND SPECIFICATION

Use fluid that meets the defined specification and viscosity grade.

If you do not use fluid that meets the defined specification and viscosity grade, it could result in:

- Component damage that your vehicle warranty does not cover.
- Reduced vehicle performance.
- Reduced fuel economy.

Capacities

Variant	Quantity
All.	2.4 qt (2.3 L) ¹

¹ Approximate dry fill capacity. Actual amount could vary during fluid changes.

Materials

Name	Specification
Motorcraft® Dual Clutch Transmission Fluid(U.S.) Motorcraft® Dual Clutch Transmission Fluid / Huile pour boîtes embrayage double Motorcraft®(Canada) XT-11-QDC(U.S. & Canada)	WSS-M2C200-D2

CLUTCH FLUID CAPACITY AND SPECIFICATION

The clutch and brake systems share the same fluid reservoir. See **Brake Fluid Specification** (page 404).

AUTOMATIC TRANSMISSION FLUID CAPACITY AND SPECIFICATION

Use fluid that meets the defined specification and viscosity grade.

Capacities and Specifications

If you do not use fluid that meets the defined specification and viscosity grade, it could result in:

- Component damage that your vehicle warranty does not cover.
- Reduced vehicle performance.

- Reduced fuel economy.

Note: Only use MERCON ULV transmission fluid for automatic transmissions that require MERCON ULV transmission fluid. The use of any other fluid could cause transmission damage.

Capacities

Variant	Quantity
All.	13.1 qt (12.4 L) ¹

¹ Approximate dry fill capacity. Actual amount could vary during fluid changes.

Materials

Name	Specification
Motorcraft® MERCON® ULV Automatic Transmission Fluid (U.S.) Motorcraft® MERCON® ULV Automatic Transmission Fluid / MERCON® ULV huile pour boîtes automatique Motorcraft® (Canada) XT-12-QULV (U.S. & Canada)	WSS-M2C949-A, MERCON® ULV

BRAKE FLUID SPECIFICATION

Use fluid that meets the defined specification and viscosity grade.

If you do not use fluid that meets the defined specification and viscosity grade, it could result in:

- Component damage that your vehicle warranty does not cover.
- Reduced brake performance.

Note: We recommend you use Dot 4 Low Viscosity (LV) High Performance Brake Fluid meeting WSS-M6C65-A2 specifications or ISO 4925 Class 6 standards. If you use any fluid other than the recommended fluid, it could cause reduced brake performance and not meet our performance standards. Keep brake fluid clean and dry. Contamination with dirt, water, petroleum products or other materials could result in brake system damage and possible failure.

Capacities

Variant	Quantity
All.	Fill as required.

Capacities and Specifications

Materials

Name	Specification
Motorcraft® DOT 4 LV High Performance Motor Vehicle Brake Fluid(U.S.) Motorcraft® DOT 4 LV High Performance Motor Vehicle Brake Fluid / Liquide de frein automobile haute performance DOT 4 LV Motorcraft®(Canada) PM-20(U.S. & Canada)	WSS-M6C65-A2

TRANSFER CASE FLUID CAPACITY AND SPECIFICATION

Use fluid that meets the defined specification and viscosity grade.

If you do not use fluid that meets the defined specification and viscosity grade, it could result in:

- Component damage that your vehicle warranty does not cover.
- Reduced vehicle performance.

Capacities

Variant	Quantity
4x4 with part time engagement.	1.3 qt (1.2 L)
Advanced 4x4 with 4A mode.	1.6 qt (1.55 L)

Materials

Name	Specification
Motorcraft® MERCON® LV Automatic Transmission Fluid(U.S.) Motorcraft® MERCON® LV Automatic Transmission Fluid / Huile pour boîte automatique MERCON® LV Motorcraft®(Canada) XT-10-QLVC(U.S.) CXT-10-LV6(Canada)	WSS-M2C938-AMERCON® LV,

FRONT AXLE FLUID CAPACITY AND SPECIFICATION

Use fluid that meets the defined specification and viscosity grade.

If you do not use fluid that meets the defined specification and viscosity grade, it could result in:

- Component damage that your vehicle warranty does not cover.
- Reduced vehicle performance.

Capacities and Specifications

Capacities

Variant	Quantity
With electronic locking differential.	26.2 fl oz (775 ml)
Without electronic locking differential and without front axle disconnect.	29.2 fl oz (865 ml)
Without electronic locking differential and with front axle disconnect.	30.4 fl oz (900 ml)

Materials

Name	Specification
Motorcraft® SAE 80W-90 Premium Rear Axle Lubricant(U.S.) Motorcraft® SAE 80W-90 Premium Axle Lubricant / Lubrifiant pour essieux de très haute qualité SAE 80W-90 Motorcraft®(Canada) XY-80W90-QL(U.S.) CXY-80W90-1L(Canada)	WSP-M2C197-A

REAR AXLE FLUID CAPACITY AND SPECIFICATION

Use fluid that meets the defined specification and viscosity grade.

If you do not use fluid that meets the defined specification and viscosity grade, it could result in:

- Component damage that your vehicle warranty does not cover.
- Reduced vehicle performance.

Capacities

Variant	Quantity
With electronic locking differential.	63.6 fl oz (1.88 L)
Without electronic locking differential.	65.3 fl oz (1.93 L)

Capacities and Specifications

Materials

Name	Specification
Motorcraft® SAE 75W-85 Premium Synthetic Hypoid Gear Lubricant (U.S.) Motorcraft® SAE 75W-85 Premium Synthetic Hypoid Gear Lubricant / Huile synthétique de haute qualité pour engrenages hypoides SAE 75W-85 Motorcraft® (Canada) XY-75W85-QL (U.S. & Canada)	WSS-M2C942-A

Vehicle Identification

VEHICLE IDENTIFICATION NUMBER

LOCATING THE VEHICLE IDENTIFICATION NUMBER

The vehicle identification number is on the left-hand side of the instrument panel.

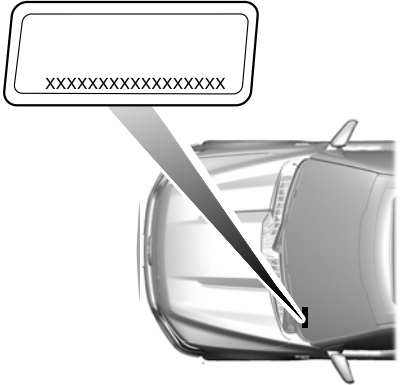

Note: In the illustration, XXXX is representative of your vehicle identification number.

VEHICLE IDENTIFICATION NUMBER OVERVIEW

The vehicle identification number contains the following information:

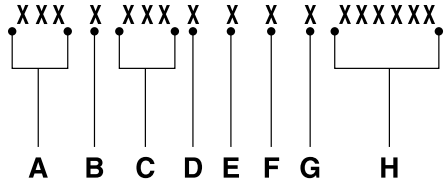

- A World manufacturer identifier.
- B Brake system, gross vehicle weight rating, restraint devices and their locations.
- C Make, vehicle line, series, body type.
- D Engine or motor type.
- E Check digit.
- F Model year.
- G Assembly plant.
- H Production sequence number.

Connected Vehicle

WHAT IS A CONNECTED VEHICLE

A connected vehicle has technology that allows your vehicle to connect to a mobile network and for you to access a range of features. When used in conjunction with the FordPass app, it could allow you to monitor and control your vehicle further, for example checking the tire pressures, the fuel level and the vehicle location. For additional information, refer to the local Ford website.

CONNECTED VEHICLE REQUIREMENTS

Connected service and related feature functionality requires a compatible vehicle network.

Some remote features require additional service activation. Log in to your Ford account for details. Some restrictions, third party terms and message or data rates may apply.

CONNECTED VEHICLE LIMITATIONS

Evolving technology, cellular networks, or regulations could affect functionality and availability, or continued provision of some features. These changes could even stop some features from functioning.

CONNECTING THE VEHICLE TO A MOBILE NETWORK

WHAT IS THE MODEM



The modem allows access to a range of features built into your vehicle.

ENABLING AND DISABLING THE MODEM

1. Press **Settings**.
2. Press **Connectivity**.
3. Press **Connected Vehicle Features**.
4. Switch vehicle connectivity on or off.

CONNECTING FORDPASS TO THE MODEM

1. Make sure that the modem is enabled using the vehicle settings menu.
2. Open the FordPass app on your device and log in.
3. Add your vehicle or select your vehicle if already added.
4. Select the option for vehicle details.
5. Select the option to activate your vehicle.
6. Make sure that the name on the screen matches the name shown in your FordPass account.
7. Confirm that FordPass account is connected to the modem.

CONNECTING THE VEHICLE TO A WI-FI NETWORK

Access the application drawer on the touchscreen.

1. Press **Settings**.
2. Press **Connectivity**.
3. Press **Manage Wi-Fi Networks**.
4. Switch **Wi-Fi Hotspot** on.
5. Press **View Available Networks**.
6. Select an available Wi-Fi network.

Note: Enter the network password to connect to a secure network.

Connected Vehicle

CONNECTED VEHICLE – TROUBLESHOOTING

Symptom	Possible Cause and Resolution
I cannot connect to a Wi-Fi network.	<ul style="list-style-type: none">– Password error.<ul style="list-style-type: none">• Enter the correct network password.– Weak network signal.<ul style="list-style-type: none">• Move your vehicle closer to the Wi-Fi hotspot or to a place where the network signal is not obstructed.– Multiple access points in range with the same SSID.<ul style="list-style-type: none">• Use a unique name for your SSID. Do not use the default name unless it contains a unique identifier, for example as part of the MAC address.
The Wi-Fi connection disconnects after successful connection.	<ul style="list-style-type: none">– Weak network signal.<ul style="list-style-type: none">• Move your vehicle closer to the Wi-Fi hotspot or to a place where the network signal is not obstructed.
I am close to a Wi-Fi hotspot but the network signal strength is weak.	<ul style="list-style-type: none">– Obstructed network signal.<ul style="list-style-type: none">• If your vehicle has a heated windshield, position your vehicle so that the windshield is not facing the Wi-Fi hotspot.• If your vehicle has metallic tinting on the windows but not on the windshield, position your vehicle so that the windshield is facing the Wi-Fi hotspot or open the windows that are facing the hotspot.• If your vehicle has metallic tinting on the windows and the windshield, open the windows that are facing the hotspot.• If your vehicle is in a garage and you have the garage door closed, open the garage door.
I cannot see a network in the list of available networks that I expect to see.	<ul style="list-style-type: none">– Hidden network.<ul style="list-style-type: none">• Make the network visible and try again.

Connected Vehicle

Symptom	Possible Cause and Resolution
I cannot see the Wi-Fi hotspot name when I search for Wi-Fi networks on my cell phone or other device.	<ul style="list-style-type: none">– System limitation.<ul style="list-style-type: none">• Make sure Wi-Fi hotspot visibility is on.• The system does not provide a Wi-Fi hotspot at this time.
Software downloads take too long.	<ul style="list-style-type: none">– Weak network signal.<ul style="list-style-type: none">• Move your vehicle closer to the Wi-Fi hotspot or to a place where the network signal is not obstructed.– Wi-Fi hotspot in high demand or has a slow Internet connection.<ul style="list-style-type: none">• Use a more reliable Wi-Fi hotspot.
The system seems to connect to a Wi-Fi network and the signal strength is excellent but the software does not update.	<ul style="list-style-type: none">– No software update available.– Wi-Fi network requires a subscription or acceptance of terms and conditions.<ul style="list-style-type: none">• Test the connection using another device. If the network requires a subscription or acceptance of terms and conditions, contact the network service provider.

Vehicle Wi-Fi Hotspot

CREATING A VEHICLE WI-FI HOTSPOT

You can create a Wi-Fi hotspot in your vehicle and allow devices to connect to it for access to the Internet.



Select the settings option on the feature bar.

1. Press **Vehicle Hotspot**.

Note: The vehicle hotspot default setting is on.

2. Press **Settings**.
3. Press **Edit**.
4. Press **Hotspot visibility**.

Note: The hotspot visibility default setting is on.

Finding the Wi-Fi Hotspot Name and Password



Select the settings option on the feature bar.

1. Press **Vehicle Hotspot**.
2. Press **Settings**.

Note: The network name is the hotspot name.

3. Press **View Password**.

Connecting a Device to the Wi-Fi Hotspot

1. On your device, switch Wi-Fi on and select the hotspot from the list of available Wi-Fi networks.
2. When prompted, enter the password.

Purchasing a Data Plan

1. Connect a device to the hotspot.

Note: The vehicle network carrier's portal opens on your device.

2. If the portal does not open on your device, open a website and it redirects to the vehicle network carrier's portal.

Note: Secure websites do not redirect.

3. Follow the instructions on the carrier portal to purchase a plan.

Note: If you have an active plan, the system does not redirect to the vehicle network carrier's portal when you connect a device. Visit the vehicle network carrier's website to purchase more data.

Note: If data usage information is available in the vehicle hotspot menu, it is approximate.

Note: If you carry out a master reset, the system does not remove your vehicle from your vehicle network carrier's account. To remove your vehicle from the account, contact your vehicle network carrier.

Note: The vehicle network carrier provides Vehicle Hotspot services, subject to your vehicle network carrier agreement, coverage and availability.

CHANGING THE VEHICLE WI-FI HOTSPOT NAME OR PASSWORD



Select the settings option on the feature bar.

1. Press **Vehicle Hotspot**.
2. Press **Settings**.
3. Press **Edit**.
4. Press **Change Network Name**.
5. Enter your required network name.
6. Press **Done**.
7. Press **Change Password**.
8. Enter your required password.
9. Press **Done**.

Vehicle Wi-Fi Hotspot

Changing the Wi-Fi Hotspot Frequency

Note: *The Vehicle Hotspot frequency band is selectable depending upon your device capabilities. You will be unable to connect your device to the Vehicle Hotspot if it does not support the selected frequency band.*



Select the settings option on the feature bar.

1. Press **Vehicle Hotspot**.
2. Press **Settings**.
3. Press **Edit**.
4. Select a frequency.
5. Press **Done**.

Audio System

AUDIO SYSTEM PRECAUTIONS



WARNING: Driving while distracted can result in loss of vehicle control, crash and injury. We strongly recommend that you use extreme caution when using any device that may take your focus off the road. Your primary responsibility is the safe operation of your vehicle. We recommend against the use of any hand-held device while driving and encourage the use of voice-operated systems when possible. Make sure you are aware of all applicable local laws that may affect the use of electronic devices while driving.

Listening to loud audio for long periods of time could damage your hearing.

SWITCHING THE AUDIO UNIT ON AND OFF



Press the button on the volume control.

SELECTING THE AUDIO SOURCE

Audio Unit



Press to open the media source menu.

You can press this multiple times to change the audio source or scroll through the media sources.

Touchscreen

Press **Sources** on the touchscreen to open the media source menu.

PLAYING OR PAUSING THE AUDIO SOURCE

Audio Unit



Press the button to pause playback. Press again to resume playback.

Touchscreen



Press the button to pause playback. Press again to resume playback.

Note: *Not all sources can be paused.*

ADJUSTING THE VOLUME

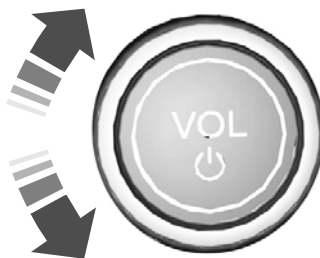

Turn to adjust the volume.

Some vehicles may be able to adjust the volume using buttons on the steering wheel.

Audio System

SWITCHING SHUFFLE MODE ON AND OFF



Press the button on the touchscreen to switch shuffle mode on or off.

Note: *Not all sources have shuffle mode.*

SWITCHING REPEAT MODE ON AND OFF



Press the button on the touchscreen to switch repeat mode on or off.

Note: *Not all sources have repeat mode.*

SETTING A MEMORY PRESET

1. Select a station or channel.
2. Press and hold a memory preset button on the touchscreen.

Note: *The audio mutes briefly while the system saves the preset and returns once it is stored.*

Note: *You can save presets from multiple sources to the memory preset bar.*

MUTING THE AUDIO



Press the button on the steering wheel to mute the audio.



Press to mute the signal. Press again to restore the signal.

ADJUSTING THE SOUND SETTINGS

Balance and Fade (If Equipped)

1. Press **Settings** on the touchscreen.

2. Press **Sound Settings**.
3. Press **Balance / Fade**.
4. Press the arrows to adjust the settings.

Tone Settings

1. Press **Settings** on the touchscreen.
2. Press **Sound Settings**.
3. Press **Tone Settings**.
4. Press the arrows or slider bar to adjust the settings.

Speed Compensated Volume

1. Press **Settings** on the touchscreen.
2. Press **Sound Settings**.
3. Press **Speed Compensated Volume**.
4. Press a setting.

Occupancy Mode (If Equipped)

1. Press **Settings** on the touchscreen.
2. Press **Sound Settings**.
3. Press **Occupancy Mode**.
4. Press a setting.

Sound Mode (If Equipped)

1. Press **Settings** on the touchscreen.
2. Press **Sound Settings**.
3. Press **Sound Mode**.
4. Press a setting.

SETTING THE CLOCK AND DATE

1. Press **Settings** on the touchscreen.
2. Press **Clock Settings**.
3. Set the time.

Note: *The AM and PM options are not available if 24-hour mode is on.*

Audio System

Switching Automatic Time Updates On and Off

1. Press **Settings** on the touchscreen.
2. Press **Clock Settings**.
3. Switch **Automatic time zone update** on or off.

AM/FM RADIO

AM/FM RADIO LIMITATIONS

The further you travel from an AM or FM station, the weaker the signal and the weaker the reception.

Hills, mountains, tall buildings, bridges, tunnels, freeway overpasses, parking garages, dense tree foliage and thunderstorms can interfere with the reception.

When you pass a ground-based broadcast repeating tower, a stronger signal may overtake a weaker one and result in the audio system muting.

SELECTING A RADIO STATION

Manually Selecting a Radio Station

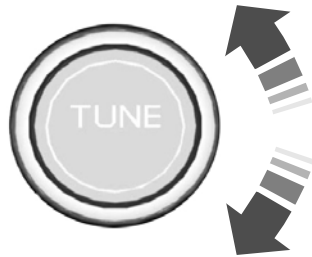

Turn to search through the radio frequency band.

Using Direct Tune

1. Press **Direct Tune** to open the number pad.
2. Enter the station you prefer.

Note: *You can only enter a valid station for the audio source you are currently listening to.*

Using Seek



Press either button. The system stops at the first station it finds in that direction.

Audio System

SWITCHING THE DISPLAY ON AND OFF

Audio Unit



Press the button.

Touchscreen

To switch the display off:

1. Press **Settings** on the touchscreen.
2. Press **Display Settings**.
3. Press **Display Off**.

Note: The display defaults to on each time you switch your vehicle on.

To switch the display on, press anywhere on the touchscreen.

DIGITAL RADIO (IF EQUIPPED)

WHAT IS DIGITAL RADIO

HD Radio™ technology is the digital evolution of analog AM/FM radio.

For additional information, visit www.HDRadio.com.

HD Radio Technology is manufactured under license from iBiquity Digital Corporation and foreign patents. HD Radio and the HD and HD Radio logos are proprietary trademarks of DTS. The vehicle manufacturer and DTS are not responsible for the content sent using HD Radio technology. Content may be changed, added or deleted at any time at the station owner's discretion.

HOW DOES DIGITAL RADIO WORK

Your system has a special receiver that allows it to receive digital broadcasts in addition to analog broadcasts.

HD1 signifies the main programming status and is available in both analog and digital broadcasts. Other multicast stations are only available digitally and could contain new or different content.

Note: When the system first receives an HD1 station, it plays the station in the analog version until it verifies the station is an HD Radio station. Then it shifts to the digital version.

Note: There is an audio mute delay when switching to an HD2 or HD3 station because the system has to reacquire and decode the digital signal.

DIGITAL RADIO LIMITATIONS

If you are outside the reception area, the system could not work.

If you are on the fringe of the reception area, the station could mute due to weak signal strength.

Note: If you are listening to HD1, the system changes back to the analog broadcast until the digital broadcast is available again. If you are listening to any other multicast channels, the station mutes and stays muted unless it is able to connect to the digital signal again.

Depending on the station quality, you could hear a slight sound change when the station changes between analog and digital audio.

You cannot access a saved HD station if your vehicle is outside the station's reception area.

SWITCHING DIGITAL RADIO RECEPTION ON AND OFF

1. Press **Settings** on the touchscreen.
2. Press **Radio Settings**.
3. Switch **AM HD Radio** or **FM HD Radio** on or off.

Audio System

DIGITAL RADIO INDICATORS

HD Radio Indicator

The indicator appears when HD Radio is on and you tune to a station broadcasting HD Radio technology.



The color of the indicator changes to indicate the system status.

Gray indicates the system is acquiring a digital station.

Orange indicates digital audio is playing.

Multicast Indicator

The multicast indicator appears if the current station is broadcasting multiple digital broadcasts. The highlighted numbers indicate additional digital channels available.

Note: For stations that have more than one HD multicast, the HD indicator and radio text appears as a button. Press the button to cycle through all of the HD stations on that specific frequency.

SATELLITE RADIO (IF EQUIPPED)

WHAT IS SATELLITE RADIO

Your factory-installed SiriusXM radio system includes a limited subscription term, which begins on the date of sale or lease of your vehicle. See an authorized dealer for availability.

For additional information about extended subscription terms, visit www.SiriusXM.com in the United States, www.SiriusXM.ca in Canada, or call SiriusXM at 1-888-539-7474.

Note: SiriusXM reserves the unrestricted right to change, rearrange, add or delete programming including canceling, moving or adding particular channels, and its prices, at any time, with or without notice to you. Neither SiriusXM and its affiliates nor Ford Motor Company and its affiliates will be liable to you or any third party for any such modification, suspension or termination.

SATELLITE RADIO LIMITATIONS

For optimal reception performance, keep the antenna clear of snow and ice build-up and keep luggage and other material as far away from the antenna as possible. Placing luggage over the antenna may reduce performance.

Hills, mountains, tall buildings, bridges, tunnels, freeway overpasses, parking garages, dense tree foliage and thunderstorms can interfere with your reception.

When you pass a ground-based broadcast-repeating tower, a stronger signal may overtake a weaker one and could result in the audio system muting. Your display could show an error message to indicate the interference.

LOCATING THE SATELLITE RADIO IDENTIFICATION NUMBER

1. Select SiriusXM as the audio source.
2. Tune to channel 0.

Audio System

SELECTING A CHANNEL

Manually Selecting a Channel



Press the button to find the previous or next available radio channel.



Linear Tuner

The linear tuner is displayed when manually selecting a channel. You can swipe left or right on the linear tuner carousel to navigate through the channel list. Tap on a channel title to listen to it.

Using Direct Tune

1. Press the channel up or down button to open the linear tuner screen.
2. Press **Direct Tune** to open the number pad.
3. Enter the channel you prefer.

Using Browse

1. Press **Browse**.
2. Select a channel.

SATELLITE RADIO SETTINGS

Subscription

Your subscription status is displayed. You can subscribe or manage your subscription directly from the touchscreen.

Listener Add/Switch

You can create up to five listener profiles per SiriusXM account. Each listener profile can be personalized with a name and profile image.

Note: Requires a trial or active subscription to use.

Note: A default profile is available when no listener profiles are created.

SiriusXM Favorites

SiriusXM Favorites are shown for the active listener profile. While you are listening to SiriusXM, you can save favorites by:

- Tapping the currently tuned channel or show logo on the SiriusXM audio screen. A favorite icon appears next to the logo when it is saved as a favorite.
- Tuning to a channel or show you want to save as a favorite. Navigate to the SiriusXM Favorites screen and press the Add Current button. The currently tuned channel or show is saved as a favorite.
- Saving a radio preset. This saves the currently tuned SiriusXM channel or show as a favorite.

Note: Requires a trial or active subscription to use.

Listening History

Listening history is a list of recently listened to SiriusXM content and is shown for the active listener profile. You can view, manage and reset the listening history using the controls on the touchscreen.

Note: Requires a trial or active subscription to use.

Listener Settings

Listener settings apply to the active listener profile.

Note: Requires a trial or active subscription to use.

Note: A default profile is available when no listener profiles are created.

Audio System

Help and Support

You can contact SiriusXM Customer Care

directly from SYNC and view information required to manage your SiriusXM account.

Audio System

AUDIO SYSTEM – TROUBLESHOOTING

AUDIO SYSTEM – INFORMATION MESSAGES

Satellite Radio Troubleshooting

Error Message	Potential Effects	Recommended Action
Connectivity Disabled	Internet streaming and On Demand shows are unavailable and some SiriusXM features are disabled.	Internet connectivity is turned off. See Connected Vehicle (page 409).
No Internet	Audio system may mute. "Switch to Satellite" button may be displayed on the SiriusXM audio screen if the channel is also available via satellite.	SYNC will attempt to connect. See Satellite Radio Limitations (page 418). Switch to a satellite connection for the current channel if the option is available.
No Satellite Signal	Audio system may mute. "Switch to Internet" button may be displayed on the SiriusXM audio screen if the channel is also available via streaming.	Antenna may be obstructed or satellite reception is weak in your location. See Satellite Radio Limitations (page 418). Switch to an internet connection for the current channel if the option is available.
Slow Network Connection	Audio system may mute while audio attempts to load.	Allow some time for audio to load or tune to a different channel.
Channel Unavailable	Audio system may mute. Radio may tune to a different channel.	A temporary update may be in progress. Allow some time before retrying to tune to the channel. If issue persists, the channel may no longer be available.
Episode Unavailable	Audio system may mute. Radio may tune to a different channel.	A temporary update may be in progress. Allow some time before retrying to play the episode. If issue persists, the episode may no longer be available.

Audio System

Something went wrong	Audio system may mute. Radio may tune to a different channel.	Retry action after some time or tune to a different channel.
Subscribe to Listen	Cannot listen to selected content. Content may appear grayed out and some features may be disabled.	<p>Your subscription has expired or you have not yet subscribed for access to the listed content. Navigate to Subscription under the Satellite Radio Settings menu. If you have an active subscription which includes the listed channel or content and you see this error, you may need to refresh your radio. To refresh your SiriusXM radio, visit www.siriusxm.com/refresh in the US, or www.siriusxm.ca/refresh in Canada.</p> <p>You may need to provide your SiriusXM Radio identification number. See Locating the Satellite Radio Identification Number (page 418).</p>

Audio System

Upgrade to Listen	Cannot listen to selected content. Content may appear grayed out and some features may be disabled.	Your subscription does not include access to the listed content. You may need to upgrade your subscription. Navigate to Subscription under the Satellite Radio Settings menu. If you have an active subscription which includes the listed channel or content and you see this error, you may need to refresh your radio. To refresh your SiriusXM radio, visit www.siriusxm.com/refresh in the US, or www.siri-usxm.ca/refresh in Canada. You may need to provide your SiriusXM Radio identification number. See Locating the Satellite Radio Identification Number (page 418).
Location Restricted Content	Audio may mute. "Not available in your location" or "Unable to determine your location" may be displayed.	Content is not available in your location or SiriusXM is unable to determine your location. Tuning to a different channel may resolve the issue.
Channel Blocked	Audio may mute. Radio may tune to a different channel.	The Block Explicit Content filter is turned on. Navigate to Listener Settings under the Satellite Radio Settings menu to access the Block Explicit Content filter. Navigate to Listener Settings. See Satellite Radio Settings (page 419).
Antenna Problem or Hardware Problem	Audio may mute. Access to SiriusXM features may be unavailable.	If issue persists, you may need to visit an authorized dealer for service.

Audio System

SiriusXM Updating...	Audio may mute.	Allow SiriusXM some time to complete updating.
Loading...	Audio may mute. Content may be temporarily unavailable while loading.	No action necessary. If loading time is longer than usual, See Satellite Radio Limitations (page 418).
SiriusXM Loading...	Audio may mute. Content and controls may be temporarily unavailable.	No action necessary. Allow SiriusXM some time to finish loading.

IDENTIFYING THE AUDIO UNIT



Depending on your vehicle options, the controls may look different from what you see here.

Center Display Overview

CENTER DISPLAY PRECAUTIONS



WARNING: Driving while distracted can result in loss of vehicle control, crash and injury. We strongly recommend that you use extreme caution when using any device that may take your focus off the road. Your primary responsibility is the safe operation of your vehicle. We recommend against the use of any hand-held device while driving and encourage the use of voice-operated systems when possible. Make sure you are aware of all applicable local laws that may affect the use of electronic devices while driving.

CENTER DISPLAY LIMITATIONS

Speed-restricted Features

For your safety, some features are not available while the vehicle is in motion at or above 6 mph (10 km/h).

Settings that are not critical while driving your vehicle will be shown as restricted on your display. See the following chart for specific examples.

Restricted Features	
System Functionality	System updates.
	Personal profiles setup.
	Valet mode setup.
	Driver assistance settings.
	Auto start-stop speed threshold.
Vehicle Settings	30 minute max idle.
	MyKey setup.
	Keyless entry keypad code setup.

Restricted features will become available again once the vehicle is no longer in motion.

STATUS BAR

The bar is on top of the display and indicates the status of your vehicle's features.



Call in progress.



Cell phone microphone muted.



Audio system muted.

Center Display Overview



System update installed.



Wi-Fi available.



Wi-Fi connected.



Cell phone roaming.



Text message received.



Email received.



Bluetooth® device connected.



Automatic crash notification system off.



Cell phone battery status.



Wireless charger is active.



Cell phone network signal strength.



Vehicle data sharing on.



Vehicle data sharing off.



Vehicle location sharing on.



Vehicle data and vehicle location sharing on.



Vehicle system update activating.



Additional consent needed.



Vehicle system activation reminder.



Vehicle system update not successful.



Vehicle system update reminder.

FEATURE BAR

The bar is on the bottom of the display and allows you to access vehicle features.



Select to use the radio, a USB, a media player or a **Bluetooth®** device.



Select to make calls and access the phonebook on your cell phone.



Select to use the navigation system.



Select to view favorites.



Select to search for and use compatible apps on your iOS or Android device.



Select to adjust system settings.



Select to view features.



Center Display Overview



Note: *The icon may be different depending on your vehicle.*

INFORMATION ON DEMAND SCREEN - VEHICLES WITH: 12.3 INCH SCREEN

The Information on Demand screen displays cards on the side of the display and allows you to see information from different features.



Select the button to view the next card.



Select the button to view the previous card.



Select the button to view available cards.

Voice Interaction

WHAT IS VOICE INTERACTION

Voice Interaction allows you to control vehicle features using conversational requests.

SETTING THE WAKE WORD

1. Press the Settings option on the feature bar.
2. Press the Voice Control button.
3. Switch on Listen for Wake Word.
4. Press Preferred Wake Word
5. Select a wake word.

BEGINNING A VOICE INTERACTION

Say the selected wake word.



Press the voice interaction button on the steering wheel.

VOICE INTERACTION EXAMPLES

Note: You may need to enable your vehicle's modem to use certain voice commands. See **Enabling and Disabling the Modem** (page 409).

General Examples

Command	Result
Start Over.	The system resets the current voice interaction.
Cancel.	The system ends the current voice interaction.
Next Page.	The system goes to the next page.
Previous Page.	The system goes to the previous page.
Help.	The system displays a list of available commands you can use on the current screen.

Entertainment Examples

Command	Result
Play The Beatles.	The system plays the selected music.
Show music by The Beatles.	The system shows the selected music.
Tune to FM 101.9.	The system tunes the radio to 101.9 FM.
Set the station to Sirius Channel 2.	The system tunes the radio to Sirius Channel 2.

Voice Interaction

Climate Examples

Command	Result
Set the temperature to low.	The system sets the temperature to the minimum.
Set the temperature to 72°F (22°C).	The system sets the temperature to 72°F (22°C).

Phone Examples

Command	Result
Call Henry.	The system calls Henry using your connected device.
Dial (phone number).	The system dials the selected phone number.
Send a text message to Henry.	The system begins a dictated text message.
Read my message from Henry.	The system reads you the most recent message from Henry.

Apps Examples

Command	Result
Mobile Apps.	The system prompts you to say the name of an app to start it on the system.
List Mobile Apps.	The system will list all of the currently available Mobile Apps.
Find Mobile Apps	The system will search and connect to compatible app running on your mobile device.

Navigation Examples

Command	Result
Drive to 125 Main Street, New York.	The system begins guided navigation to the address.
Where is ___	The system searches for the requested point of interest.
Show me directions to Oakwood Boulevard and Pelham Road.	The system shows directions to the selected intersection.
Cancel route.	The system ends guided navigation to the destination.

Ford Assistant Examples

Note: When you are not driving, additional commands are available by using popular chat applications. Use FordPass to setup a conversation with your Ford assistant.

Voice Interaction

Remote Vehicle Control Examples

Command	Result
How much gas is in my tank?	The vehicle tells you how much gas it has left.

Maintenance and Roadside Assistance Examples

Command	Result
Call roadside assistance.	Your vehicle calls the roadside assistance phone number.

Vehicle Information Examples

Command	Result
How does cruise control work?	Information about the feature appears on the center display or FordPass app.
What does the warning light mean?	Information about the warning light appears on the center display or FordPass app.
Am I affected by any recalls?	Information about open recalls appears on the center display or FordPass app.
When does my warranty expire?	Your vehicle or FordPass app tells you the expiration date.

Charging Examples

Command	Result
When is my next scheduled charge?	Information about the time and location of the next charge appears on the center display or FordPass app.
Show me the charging schedule.	Shows the charging display in the vehicle.
Change my charge schedule.	Shows the charging display in the vehicle.

Phone

PHONE PRECAUTIONS



WARNING: Driving while distracted can result in loss of vehicle control, crash and injury. We strongly recommend that you use extreme caution when using any device that may take your focus off the road. Your primary responsibility is the safe operation of your vehicle. We recommend against the use of any hand-held device while driving and encourage the use of voice-operated systems when possible. Make sure you are aware of all applicable local laws that may affect the use of electronic devices while driving.

CONNECTING YOUR PHONE

Go to the settings menu on your device and switch **Bluetooth®** on.



Select the phone option on the feature bar.

1. Select **Add Phone**.

Note: A prompt alerts you to search for your vehicle on your cell phone.

2. Select your vehicle on your cell phone.

Note: A number appears on your cell phone and on the touchscreen.

3. Confirm that the PIN (personal identification number) on your cell phone matches the number on the touchscreen.

Note: The touchscreen indicates that you have successfully paired your cell phone.

4. Download the phonebook from your cell phone when you are prompted.

Note: If you pair more than one cell phone, use the phone settings to specify the primary phone. You can change this setting at any time.

PHONE MENU

This menu becomes available after pairing a phone.

Recent Call List

Display and select an entry from a list of previous calls.

Contacts

Display a smart search form to look up your contacts. Use the List button to alphabetically sort your contacts.

Favorites

Display the list of favorite contacts that are set up on your phone.

Messaging

Displays the list of text messages to read, listen to, or respond to.

Email

Displays the list of emails to read, listen to, or respond to.

Phone List

Display the list of paired or connected devices that you can select.

Note: Up to 12 devices can be stored.

Do Not Disturb

Reject incoming calls and switch ring tones and alerts off.

Phone Keypad

Directly dial a number.

Phone

Voice Control

Say a command to use the Google or Siri voice assistant available on your connected phone to access supported features.

Note: *Some features under the phone menu may not be available if the feature is not supported through the phone.*

Phone

MAKING AND RECEIVING A PHONE CALL

Making Calls

To call a number in your contacts, select:

Menu Item	Action and Description
Contacts	You can then select the name of the contact you want to call. Any numbers stored for that contact display along with any stored contact photos. You can then select the number that you want to call. The system begins the call.

To call a number from your recent calls, select:

Menu Item	Action and Description
Recent Call List	You can then select an entry that you want to call. The system begins the call.

To call a number from your favorites, select:

Menu Item	Action and Description
Favorites	You can then select an entry that you want to call. The system begins the call.

To call a number that is not stored in your phone, select:

Menu Item	Action and Description
Phone Keypad	Select the digits of the number you wish to call.
Call	The system begins the call.

Pressing the backspace button deletes the last digit you typed.

Receiving Calls

During an incoming call, an audible tone sounds. Caller information appears in the display if it is available.

To accept the call, select:

Menu Item
Accept

Note: You can also accept the call by pressing the phone button on the steering wheel.

To reject the call, select:

Menu Item
Reject

Ignore the call by doing nothing. The system logs it as a missed call.

During a Phone Call

During a phone call, the contacts name and number display on the screen along with the call duration.

The phone status items are also visible:

- Signal Strength.
- Battery.

You can select any of the following during an active phone call:

Phone

Item	
End Call	Immediately end a phone call. You can also press the button on the steering wheel.
Keypad	Press this to access the phone keypad.

Item	
Mute	You can switch the microphone off so the caller does not hear you.
Privacy	Transfer the call to the cell phone or back to the touch-screen.

SENDING AND RECEIVING A TEXT MESSAGE

Menu Item	Description
Hear It	Hear the text message.
View	View the text message.
Call	Call the sender.
Reply	Reply to the text message with a standard text message.

Phone

SWITCHING TEXT MESSAGE NOTIFICATION ON AND OFF

IOS

1. Go to the settings menu on your cell phone.
2. Select **Bluetooth®**.
3. Select the information icon to the right of your vehicle.
4. Switch text message notification on or off.

Android

1. Go to the settings menu on your cell phone.
2. Select **Bluetooth®**.
3. Select the profiles option.
4. Select the phone profile.
5. Switch text message notification on or off.

Bluetooth®

CONNECTING A BLUETOOTH® DEVICE

1. Make sure **Bluetooth®** is enabled on your device.
2. Press **Settings** on the touchscreen.
3. Press **Connectivity**.
4. Press **Bluetooth**.
5. Press **Add a Bluetooth Device**.

Note: A prompt alerts you to search for your vehicle on your device.

6. Select your vehicle on your device.

Note: A number appears on your device and on the touchscreen.

7. Confirm that the number on your device matches the number on the touchscreen.

Note: The touchscreen indicates that you have successfully paired your device.

The **Bluetooth®** word mark and logos are registered trademarks owned by **Bluetooth SIG, Inc.** and any use of such marks by Ford Motor Company is under license. Other trademarks and trade names are those of their respective owners.

PLAYING MEDIA USING BLUETOOTH®



WARNING: Driving while distracted can result in loss of vehicle control, crash and injury. We strongly recommend that you use extreme caution when using any device that may take your focus off the road. Your primary responsibility is the safe operation of your vehicle. We recommend against the use of any

hand-held device while driving and encourage the use of voice-operated systems when possible. Make sure you are aware of all applicable local laws that may affect the use of electronic devices while driving.

Connect your device.



Press the audio button on the feature bar.



Press **Sources**.



Press the **Bluetooth®** option.



Press to play a track. Press again to pause the track.



Press to skip to the next track. Press and hold to fast forward through the track.



Press once to return to the beginning of a track. Repeatedly press to return to previous

tracks.

Press and hold to fast rewind through the track.

Apps

APP PRECAUTIONS



WARNING: Driving while distracted can result in loss of vehicle control, crash and injury. We strongly recommend that you use extreme caution when using any device that may take your focus off the road. Your primary responsibility is the safe operation of your vehicle. We recommend against the use of any hand-held device while driving and encourage the use of voice-operated systems when possible. Make sure you are aware of all applicable local laws that may affect the use of electronic devices while driving.

APP REQUIREMENTS

When you start an app through the system for the first time, you could be asked to grant certain permissions. You can review and change the permissions that you have granted at any time when your vehicle is not moving. We recommend that you check your data plan before using your apps through the system. Using them could result in additional charges. We also recommend that you check the app provider's terms and conditions and privacy policy before using their app. Make sure that you have an active account for apps that you want to use through the system. Some apps will work with no setup. Others require you to configure some personal settings before you can use them.

ACCESSING APPS



Select the apps option on the feature bar.

ENABLING APPS ON AN IOS DEVICE



Select the apps option on the feature bar.

1. Select Mobile Apps Help.
2. Follow the instructions to pair and connect your device via **Bluetooth®** or with a USB cable.
3. Start the apps on your device that you want to use.
4. Select the app that you want to use on the touchscreen.

Note: Some apps may run through Apple CarPlay if it is enabled.

Note: Closing an app on your device will close it on the touchscreen.

Note: For troubleshooting assistance select *Compatible Apps List* or *My App Isn't Listed under Mobile Apps Help*.

ENABLING APPS ON AN ANDROID DEVICE



Select the apps option on the feature bar.

1. Select Mobile Apps Help.
2. Follow the instructions to pair and connect your device via **Bluetooth®** or with a USB cable.
3. Start the apps on your device that you want to use.
4. Select **Find Mobile Apps**.
5. Select the app that you want to use on the touchscreen.

Note: To enable apps when pairing with a USB cable, switch on Android App via USB.

Apps

Note: Some devices may lose the ability to play music over USB when Mobile Apps are enabled.

Note: Some apps may run through Android Auto if it is enabled.

Note: Closing an app on your device will close it on the touchscreen.

Note: For troubleshooting assistance select *Compatible Apps List* or *My App Isn't Listed* under *Mobile Apps Help*.

SWITCHING APPLE CARPLAY ON AND OFF

Enabling Apple CarPlay with USB

1. Connect your device to a USB port.
2. Follow the instructions on your device and the touchscreen.

Note: Selecting "Enable Wireless CarPlay" on your device will prepare the device for wireless carplay when you re-enter the vehicle.

Enabling Apple CarPlay with Wireless

1. Pair your device to **Bluetooth®**.
2. Follow the instructions on your device and the touchscreen.

Disabling Apple CarPlay



Select the settings option on the feature bar.

1. Press Phone List.
2. Select your device from the list.
3. Press Disable.

Re-Enabling Apple CarPlay



Select the settings option on the feature bar.

1. Press Phone List.
2. Select your device from the list.
3. Press Connect to Apple CarPlay.

SWITCHING ANDROID AUTO ON AND OFF

Enabling Android Auto with USB (If Equipped)

1. Connect your device to a USB port.
2. Follow the instructions on the touchscreen.

Note: Certain features of the system are not available when you are using Android Auto.

Enabling Android Auto with Wireless

1. Pair your device to **Bluetooth®**.
2. Follow the instructions on your device and the touchscreen.

Note: Certain Android Devices do not support Android Auto Wireless. Please check your Android OS version for compatibility.

Disabling Android Auto



Select the settings option on the feature bar.

1. Press Phone List.
2. Select your device from the list.
3. Press Disable.

Re-Enabling Android Auto



Select the settings option on the feature bar.

1. Press Phone List.
2. Select your device from the list.

Apps

3. Press Connect to Android Auto.

Navigation

ACCESSING NAVIGATION



WARNING: Driving while distracted can result in loss of vehicle control, crash and injury. We strongly recommend that you use extreme caution when using any device that may take your focus off the road. Your primary responsibility is the safe operation of your vehicle. We recommend against the use of any hand-held device while driving and encourage the use of voice-operated systems when possible. Make sure you are aware of all applicable local laws that may affect the use of electronic devices while driving.



Press the button to access Navigation.

Note: For optimal reception performance, keep the antenna clear of snow and ice build-up and keep luggage and other material as far away from the antenna as possible. Placing luggage over the antenna may reduce performance.

NAVIGATION MAP UPDATES

To update your Map data over Wi-Fi, your vehicle must be connected to a Wi-Fi access point. For USB updates and other details, contact dealers at 1-866-462-8837 in the United States and Canada, or 01-800-557-5539 in Mexico.

Note: If you find map data errors, you may report them by going to www.here.com/mapcreator.

ADJUSTING THE MAP

ZOOMING THE MAP IN AND OUT

You can use pinch gestures to zoom in and out. Place two fingers on the screen and move them apart to zoom in. Place two fingers on the screen and bring them together to zoom out.

CHANGING THE FORMAT OF THE MAP



Press the Menu button.

1. Press the Map Orientation tile.
2. Select a map orientation.

LIVE TRAFFIC

WHAT IS LIVE TRAFFIC

You can observe real-time road congestion when live traffic is on.

SWITCHING LIVE TRAFFIC ON AND OFF



Press the Menu button.

1. Press the Traffic on Map tile.
2. Press Traffic on or Traffic Off.

SETTING A DESTINATION

SETTING A DESTINATION USING THE TEXT ENTRY SCREEN

1. Press the search bar at the top of the screen.

Navigation

2. Enter your destination using the keyboard.
3. Press Search.
4. Select a destination from the list.
5. Press Start to begin navigation.

SETTING A DESTINATION USING THE MAP SCREEN

Press and hold on the map to place a pin at that location. Information about the location of the pin appears on the screen.



Press the button to begin navigation to the pin.

SETTING A DESTINATION USING A PREDICTIVE DESTINATION

Press the predicted destination card on the screen to navigate to it. These appear when the navigation system has learned your driving habits.

SETTING A DESTINATION USING A RECENT DESTINATION



Press the Menu button.

1. Press the Recents tile.
2. Select a destination from the list.

SETTING A DESTINATION USING A SAVED DESTINATION



Press the Menu button.

1. Press Saved Places.
2. Select a saved destination.

Note: Press the star icon next when viewing location details to save the location.

SETTING A DESTINATION USING A POINT OF INTEREST

Press and hold on a point of interest icon on the map. Information about the location of the point of interest appears on the screen.



Press the button to begin navigation to the point of interest.

WAYPOINTS

ADDING A WAYPOINT



Press the Add Waypoint button when in an active navigation session.

1. Enter your waypoint on the keyboard.
2. Press Search.
3. Select a waypoint from the list.
4. Press Add to Trip.

EDITING WAYPOINTS

1. Press the waypoint you would like to edit.
2. Select an option to reorder or delete the waypoint.

ROUTE GUIDANCE

ADJUSTING THE GUIDANCE PROMPT VOLUME

Turn the volume control when a guidance prompt plays to adjust the volume.

REPEATING AN INSTRUCTION

Press the turn indicator to hear the last voice instruction.

Navigation

ROUTE GUIDANCE SETTINGS

Avoid 4x4 Roads

Before Starting a Navigation Session

Before starting a navigation session you can enable and disable 4x4 roads using the controls on the point of interest detail page. When enabled the system will include 4x4 roads when determining the best route. When disabled the system will avoid 4x4 roads.

During a Navigation Session

If you do not wish to have your route take you on 4x4 roads you can remove the turn onto the 4x4 road using the turn list.

1. Tap the chevron below the turn panel.
2. Swipe to the left on the 4x4 road on the turn list that appears.
3. Press the delete button to remove that road from your route.

The system will then re-route you to your destination.

CANCELING ROUTE GUIDANCE



Press the button to cancel route guidance to the selected location.

Vehicle System Updates

UPDATING THE VEHICLE SYSTEMS WIRELESSLY



Over-the-Air Updates allow you to update your vehicle system software wirelessly. To make sure you receive all updates, set a recurring schedule and connect to Wi-Fi. See **Connected Vehicle** (page 409). Updates may take longer if not connected to Wi-Fi, or may not download at all. Multiple connections may be required to complete a download.

Enabling Over-the-Air Updates



Press the settings option on the feature bar.

1. Press the **System Update** tile.
2. Switch **Automatic Updates** on.

Note: *Over-the Air Updates are enabled by default.*

Note: *If you do not want to receive Over-the-Air Updates you can turn them off. You will not be notified of new updates.*

Scheduling an Update

Scheduling an update allows you to set a convenient time for the update to complete. We recommend updating overnight when your vehicle is not in use. Ensure Vehicle Connectivity and Automatic Over-the-Air Updates are enabled. Once you complete these steps, your schedule will be saved for future updates. As long as an update is not in process you can adjust your schedule.

Note: *Some updates may be applied outside of your set schedule. Information about the unscheduled update appears on the touchscreen after it is applied.*

Using the Settings Menu



Press the settings option on the feature bar.

1. Press the **System Update** tile.
2. Press **Schedule Update**.
3. Use the controls to set the time and day of the update.
4. Save the schedule.

Note: *You can set the updates to occur at any time.*

Using the Status Bar Icon



When an update is available, tap the notification icon and follow the prompts on the screen.

Additional Over-the-Air Update icons may appear on the status bar. See **Status Bar** (page 425).

Applying an Over-the-Air Update

You can see the progress of the update on the touchscreen. An update cannot be canceled once it has been started.

During scheduled updates you will not be able to drive your vehicle, start the vehicle, use remote controls to lock and unlock the vehicle. The alarm, central locks, and door tones are disabled. The electronic door lock will not function during an update. You can open the doors using the mechanical latch if child locks are not on. Pull the handle until it stops to use the mechanical latch. Some updates may not allow you to use your vehicle during the update process.

Note: *Some updates can complete in the background, but more complex updates can take up to 45 minutes.*

Note: *Double locking is switched off and central locking is switched on during and after an update.*

Vehicle System Updates

Note: *If your vehicle is plugged in, charging will stop during an update and resume when the update is complete.*

Over-the-Air Update Requirements

If these requirements are not met during a scheduled update the update will be postponed. You can update your schedule if you want to retry the update sooner.

- Your vehicle is not running.
- Your vehicle is stopped.
- Your vehicle is parked.
- The hazard indicators are switched off.
- The alarm is not sounding.
- The doors are closed.
- The parking lights are switched off.
- You are not pressing the brake pedal.
- An emergency call is not in progress.
- The Stop Safely lamp is not illuminated. See **Instrument Cluster Warning Lamps** (page 108).

Viewing Update Information

If an update is successful, the touchscreen will provide additional details or statuses about the update. You can also access this information under the System Update tile.

If an update is not successful, follow the prompt that appears on the touchscreen.

PERFORMING A MASTER RESET



Press the settings option on the feature bar.

1. Press the **Reset** tile.
2. Press **Master Reset**.
3. Follow the prompts on the screen to complete the reset.

Accessories

For a complete listing of the accessories that are available for your vehicle, please contact your authorized dealer or visit the online store web site:

Web Address (United States)

www.Accessories.Ford.com
--

Web Address (Canada)

www.Accessories.Ford.ca
--

We will repair or replace any properly authorized dealer-installed Ford Original Accessory found to be defective in factory-supplied materials or workmanship during the warranty period, as well as any component damaged by the defective accessories.

We will warrant your Ford Original Accessory through the warranty that provides the greatest benefit:

- 24 months, unlimited mileage.
- The remainder of your new vehicle limited warranty.

Contact an authorized dealer for details and a copy of the warranty.

Ford Licensed Accessories are the accessory manufacturer's designs. The manufacturer develops and therefore warrants Ford Licensed Accessories, and does not design or test these accessories to Ford Motor Company engineering requirements.

Contact an authorized Ford dealer for the manufacturer's limited warranty details, and request a copy of the Ford Licensed Accessories product limited warranty from the accessory manufacturer.

Most Ford Performance Parts are sold with no warranty, unless otherwise indicated. Check the Ford Performance Part website: www.performanceparts.ford.com or contact the Ford Performance Parts tech-line at (800) FORD788 for the latest limited warranty information on specific products.

For maximum vehicle performance, keep the following information in mind when adding accessories or equipment to your vehicle:

- When adding accessories, equipment, passengers and luggage to your vehicle, do not exceed the total weight capacity of the vehicle or of the front or rear axle (GVWR or GAWR as indicated on the Safety Compliance Certification label). Ask an authorized dealer for specific weight information.
- The Federal Communications Commission (FCC) and Canadian Radio Telecommunications Commission (CRTC) regulate the use of mobile communications systems that are equipped with radio transmitters, for example two-way radios, telephones and theft alarms. Any such equipment installed in your vehicle should comply with Federal Communications Commission (FCC) and Canadian Radio Telecommunications Commission (CRTC) regulations and should be installed only by an authorized dealer.

Accessories

- An authorized dealer needs to install mobile communications systems. Improper installation may harm the operation of your vehicle, particularly if the manufacturer did not design the mobile communication system specifically for automotive use.
- If you or an authorized Ford dealer add any non-Ford electrical or electronic accessories or components to your vehicle, you may adversely affect battery performance and durability. In addition, you may also adversely affect the performance of other electrical systems in the vehicle.

Auxiliary Switches (If Equipped)

WHAT ARE THE AUXILIARY SWITCHES

The auxiliary switchboard on the overhead console makes aftermarket customization easier with six prewired switches connected to the power distribution box. Each circuit is individually fused for connection of electrical accessories.

LOCATING THE AUXILIARY SWITCHES

The switches are labeled AUX 1 through AUX 6. They only operate when the ignition is in the on position or in the off position when Delay Accessory is active, whether the engine is running or not. We recommend that you leave the engine running to maintain battery charge when

using the switches for an extended time or when using higher current draw accessories. When a switch is turned on, the indicator light on the switch illuminates and the circuit provides power to the device wired to that switch.



LOCATING THE AUXILIARY SWITCH WIRING

There are six powered circuits and five non-powered circuits.

Auxiliary Switches (If Equipped)

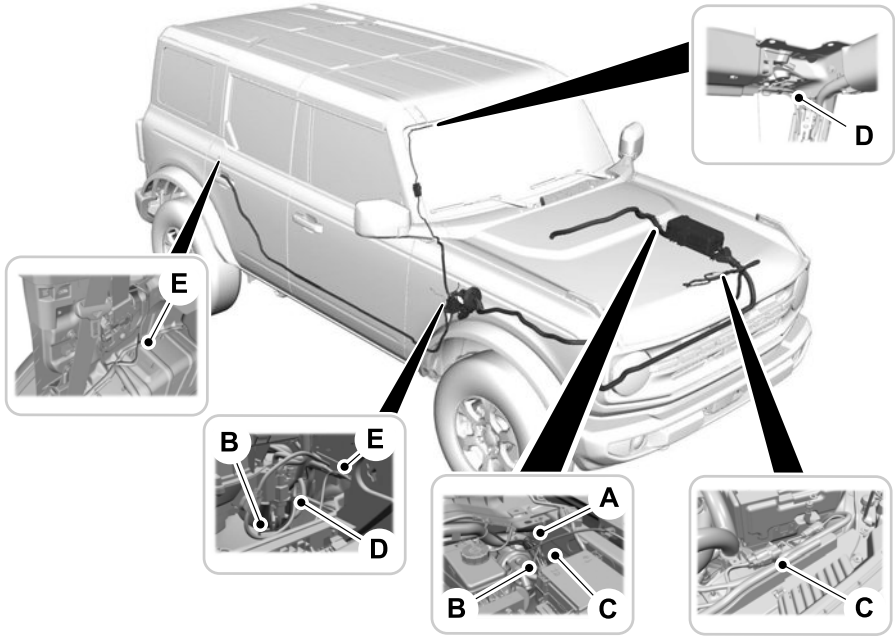

- A Circuits from under hood fuse box. See **Locating the Under Hood Fuse Box** (page 310).
- B Circuits to interior right-hand cowl side.
- C Circuit to front grille.
- D Circuit to right-hand visor.
- E Circuit to right-hand rear quarter panel.

Circuits from the under hood fuse box (A) are powered. All other circuits (B-E) are not connected at either end.

Additional information on fuse and relay locations is available. See **Fuses** (page 310). See your authorized dealer for service.

Auxiliary Switches (If Equipped)

IDENTIFYING THE AUXILIARY SWITCH WIRING

The relays are coded as follows:

Power Distribution Box	Wire Color	Wire Size	Fuse
AUX 1	Yellow	1.5 mm ²	30A
AUX 2	Green/Brown	1.5 mm ²	15A
AUX 3	Violet/Green	0.75 mm ²	10A
AUX 4	Brown	0.75 mm ²	10A
AUX 5	Blue/Orange	0.75 mm ²	10A
AUX 6	Yellow/Orange	0.75 mm ²	10A

Non-powered circuits:

Note: The non-powered circuits correspond with the auxiliary switch wiring graphic. See **Locating the Auxiliary Switch Wiring** (page 447).

Non-powered Circuit	Location	Wire Color	Wire Size
B1	Passenger Compartment	Brown/White	1.5 mm ²
B2	Passenger Compartment	White	1.5 mm ²
C	Front Grille	Violet/Grey	1.5 mm ²
D	Right-hand Visor	Grey/Orange	1.5 mm ²
E	Right-hand Rear Quarter Panel	White/Orange	1.5 mm ²

Ford Protect

WHAT IS FORD PROTECT

Protect yourself from the rising cost of vehicle repairs with a Ford Protect extended service plan.

Ford Protect Extended Service Plans - United States Only

Ford Protect extended service plans mean peace of mind. Extended service plans are backed by Ford Motor Company, and provide more protection beyond the New Vehicle Limited Warranty coverage. When you visit your Ford Dealer, insist on the Ford Protect extended service plan.

Ford Protect Can Quickly Pay for Itself

One trip to the service center could easily exceed the price of your Ford Protect extended service plan. With the Ford Protect extended service plan, you minimize your risk for unexpected repair bills and rising repair costs.

Up to 1,000+ Covered Vehicle Components

There are four mechanical Ford Protect extended service plans with different levels of coverage. Ask your authorized dealer for details.

1. PremiumCARE - Our most comprehensive coverage. With over 1,000 covered components, this plan is so complete it is probably easier to list what is not covered.
2. ExtraCARE - Covers 113 components, and includes many high-tech items.
3. BaseCARE - Covers 84 components.
4. PowertrainCARE - Covers 29 critical components.

Ford Protect extended service plans are honored by all authorized Ford dealers in the United States, Canada and Mexico.

That means you get:

- Reliable, quality service at any Ford or Lincoln dealership.
- Repairs performed by factory trained technicians, using genuine parts.

Rental Car Reimbursement

First Day Rental Benefit

If you bring your car into your dealer for service, we will give you a rental vehicle to use for the day.

Extended Rental Benefits

If your vehicle is kept overnight for covered repairs, you are eligible for rental car coverage, warranty repairs, and field service actions.

Roadside Assistance

Exclusive 24/7 roadside assistance, including:

- Towing, flat-tire change and battery jump starts.
- Out of fuel and lock-out assistance.
- Travel expense reimbursement for lodging, meals and rental car.
- Assistance for taxi, shuttle, rental car coverage or other transportation.

Transferable Coverage

If you sell your vehicle before your Ford Protect extended service plan coverage expires, you can transfer any remaining coverage to the new owner. This should give you and your potential buyer peace of mind.

Ford Protect

Less Cost to Properly Maintain Your Vehicle

The Ford Protect extended service plan also offers a Premium Maintenance Plan that covers all scheduled maintenance, and selected wear items. The coverage is prepaid, so you never have to worry about the cost of your vehicle's maintenance.

Covered maintenance includes:

- Windshield wiper blades.
- Spark plugs.
- The clutch disc (if equipped).
- Brake pads and linings.
- Shock absorbers.
- Struts.
- Engine belts.
- Engine coolant hoses, clamps and o-rings.
- Diesel exhaust fluid replenishment (if equipped).
- Cabin air filter replacement every 20,000 mi (32,000 km) for electric vehicles only.

Interest Free Finance Options

Just a 5% down payment provides you with an affordable, no interest, no fee payment program allowing you all the security and benefits Ford Protect extended service plan has to offer while paying over time. You are pre-approved with no credit check or hassles. To learn more, call our Ford Protect extended service plan specialists at 800-367-3377.

Ford Protect Extended Service Plan
P.O. Box 321067
Detroit, MI 48232

Ford Protect Extended Service Plan (Canada Only)

You can get more protection for your vehicle by purchasing a Ford Protect extended service plan. Ford Protect extended service plan is the only service contract backed by Ford Motor Company of Canada, Limited. Depending on the plan you purchase, Ford Protect extended service plan provides benefits such as:

- Rental reimbursement.
- Coverage for certain maintenance and wear items.
- Protection against repair costs after your New Vehicle Limited Warranty Coverage expires.
- Roadside Assistance benefits.

There are several Ford Protect extended service plans available in various time, distance and deductible combinations. Each plan is tailored to fit your own driving needs, including reimbursement for towing and rental. When you purchase Ford Protect extended service plan, you receive added peace-of-mind protection throughout Canada, the United States and Mexico, provided by a network of participating authorized Ford Motor Company dealers.

Note: *Repairs performed outside of Canada and the United States are not eligible for Ford Protect extended service plan coverage.*

This information is subject to change. Visit your local Ford of Canada dealer or www.ford.ca to find the Ford Protect extended service plan that is right for you.

Scheduled Maintenance

GENERAL MAINTENANCE INFORMATION

Why Maintain Your Vehicle?

Carefully following the maintenance schedule helps protect against major repair expenses resulting from neglect or inadequate maintenance and may help to increase the value of your vehicle when you sell or trade it. Keep all receipts for completed maintenance with your vehicle.

It is important that you have your vehicle serviced at the proper times. These intervals serve two purposes: first is to maintain the reliability of your vehicle and the second is to keep the cost of owning your vehicle down.

It is your responsibility to have all scheduled maintenance performed and to make sure that the materials used meet the specifications identified in this owner's manual. See **Capacities and Specifications** (page 393).

Failure to perform scheduled maintenance and regularly inspect your vehicle may result in vehicle damage not covered by the vehicle Warranty.

Why Maintain Your Vehicle at Your Dealership?

Our Genuine Replacement Parts

Dealerships stock our parts and our authorized branded re-manufactured replacement parts. These parts meet or exceed our specifications. Parts installed at your dealership carry a nationwide 24-month or unlimited mile (kilometer) parts and labor limited warranty.

If you do not use our authorized parts they may not meet our specifications and could affect emissions compliance.

Protecting Your Investment

Maintenance is an investment that pays dividends in the form of improved reliability, durability and resale value. To maintain the proper performance of your vehicle and its emission control systems, make sure you have scheduled maintenance performed at the designated intervals.

Your vehicle comes with the Intelligent Oil-Life Monitor system, a message appears in the information display at the proper oil change interval. This interval may be up to one year or 10,000 mi (16,000 km), hybrid vehicles could exceed 10,000 mi (16,000 km).

When the oil change message appears in the information display, it is time for an oil change. Make sure you perform the oil change within two weeks or 500 mi (800 km) of the message appearing. Make sure to reset the Intelligent Oil-Life Monitor after each oil change. See **Resetting the Engine Oil Change Reminder** (page 322).

If your information display resets prematurely or becomes inoperative, you should perform the oil change interval at six months or 5,000 mi (8,000 km) from your last oil change. Never exceed one year or 10,000 mi (16,000 km) between oil change intervals.

You can drive high performance vehicles in such a way that may lead to higher oil consumption including extended time at high engine speeds, high loads, engine braking, hard cornering maneuvers, track and off-road usage. Under these conditions, oil consumption of approximately 1 quart per 500 miles (1 liter per 800 km) is possible. Check the engine oil level at every refueling and adjust to maintain proper levels to avoid engine damage.

Scheduled Maintenance

It is important to rely upon your dealership to properly diagnose and repair your vehicle.

We strongly recommend only using our genuine or our authorized re-manufactured replacement parts engineered for your vehicle.

Additives and Chemicals

We do not recommend using chemicals or additives not approved by us as part of your vehicle's normal maintenance. Please consult your warranty information.

Oils, Fluids and Flushing

In many cases, fluid discoloration is a normal operating characteristic and, by itself, does not necessarily indicate a concern or that the fluid needs to be changed. Have discolored fluids that also show signs of overheating or foreign material contamination checked immediately.

Make sure to change the vehicle's oils and fluids at the specified intervals or in conjunction with a repair. Flushing is a viable way to change fluid for many vehicle sub-systems during scheduled maintenance. It is critical that systems are flushed only with new fluid that is the same as that required to fill and operate the system or using our approved flushing chemical.

Owner Checks and Services

Make sure you perform the following basic maintenance checks and inspections.

Check Every Month
The air filter restriction gauge. ¹
The engine oil level.
Function of all interior and the exterior lights.
The tires including the spare for wear and proper pressure.
The windshield washer fluid level.
The fuel and water separator. Drain if necessary or if indicated by the information display. ¹
The holes and slots in the tail pipe to make sure they are functional and clear of debris. ¹

¹ Diesel vehicles only.

Scheduled Maintenance

Check Every Six Months
The battery connections. Clean if necessary.
The body and door drain holes for obstructions. Clean if necessary.
The cooling system fluid level and the coolant system strength.
The door weatherstrips for wear. Lubricate if necessary.
The hinges, latches and outside locks for proper operation. Lubricate if necessary.
The parking brake for proper operation.
The seatbelts and seat latches for wear and function.
Safety warning lamps, brake, ABS, airbag and seatbelt for operation.
The washer spray and wiper operation. Clean or replace blades as necessary.

Multi-Point Inspection

It is important to have the systems on your vehicle regularly checked. This can help identify potential issues and prevent major problems. We recommend having the following multi-point inspection performed at every scheduled maintenance interval to help make sure your vehicle keeps running great.

Multi-Point Inspection	
Accessory drive belt or belts	Hazard warning system operation
Battery performance	Horn operation
Engine air filter	Radiator, cooler, heater and air conditioning hoses
Exhaust system	Suspension components for leaks or damage
Exterior lamps operation	Steering and linkage
Fluid levels ¹ ; fill if necessary	Tires including the spare for wear and proper pressure ²

Scheduled Maintenance

Multi-Point Inspection	
For oil and fluid leaks	Windshield for cracks, chips or pits
Half-shaft dust boots	Washer spray and wiper operation

¹ Brake, coolant recovery reservoir, automatic transmission and window washer.

² If your vehicle has a temporary mobility kit, check the tire sealant expiration Use By date on the canister. Replace as needed.

Be sure to ask your dealership service advisor or technician about the multi-point vehicle inspection. It is a comprehensive way to perform a thorough inspection of your vehicle. Your checklist gives you immediate feedback on the overall condition of your vehicle.

NORMAL SCHEDULED MAINTENANCE

Oil Change Reminder

Your vehicle comes with an oil change reminder that determines when you should change the engine oil based on how you use your vehicle.

When to Expect the OIL CHANGE REQUIRED Message	
Interval	Vehicle Use and Example
7,500–10,000 mi (12,000–16,000 km)	Normal
	Normal commuting with highway driving No, or moderate, load or towing Flat to moderately hilly roads No extended idling
5,000–7,500 mi (8,000–12,000 km)	Severe
	Moderate to heavy load or towing Mountainous or off-road conditions Extended idling Extended hot or cold operation
3,000–5,000 mi (5,000–8,000 km)	Extreme
	Maximum load or towing Extreme hot or cold operation

Scheduled Maintenance

Normal Maintenance Intervals

At Every Oil Change Interval as Indicated by the Information Display¹
Change the engine oil and filter. ²
Rotate the tires, inspect tire wear and measure the tread depth.
Perform a multi-point inspection, recommended.
Inspect the automatic transmission fluid level, if applicable with dipstick. Consult your dealer for requirements.
Inspect the brake pads, shoes, rotors, drums, brake linings, hoses and the parking brake.
Inspect the engine coolant system strength and hoses.
Inspect the exhaust system and heat shields.
Inspect the front axle and U-joints. Lubricate grease fittings in applicable.
Inspect the half-shaft boots.
Inspect the steering linkage, ball joints, suspension, tire-rod ends, driveshaft and the U-joints. Lubricate any areas with grease fittings.
Inspect the wheels and related components for abnormal noise, wear, looseness or drag.

¹ Do not exceed one year or 10,000 mi (16,000 km) between service intervals.

² Reset the oil change reminder after engine oil and filter changes. See **Resetting the Engine Oil Change Reminder** (page 322).

Brake Fluid Maintenance¹	
Every three Years	Change the brake fluid. ²

¹ Perform this maintenance item every three years. Do not exceed the designated time for the interval.

² Brake fluid servicing requires special equipment available at your authorized dealer.

Scheduled Maintenance

Other Maintenance Items ¹	
Every 20,000 mi (32,000 km)	Replace the cabin air filter.
Every 30,000 mi (48,000 km)	Replace the engine air filter.
Every 100,000 mi (160,000 km)	Replace the spark plugs.
	Inspect the accessory drive belt(s). ²
Every 150,000 mi (240,000 km)	Change the automatic transmission fluid and filter.
	Change the manual transmission fluid.
	Change the front axle fluid.
	Change the rear axle fluid.
	Change the transfer case fluid.
	Replace the accessory drive belt(s).
At 200,000 mi (322,000 km)	Change the engine coolant. ³

¹ Perform these maintenance items within 3,000 mi (4,800 km) of the last engine oil and filter change. Do not exceed the designated distance for the interval.

² After initial inspection, inspect every other oil change until replaced.

³ Initial replacement at 10 years or 200,000 mi (322,000 km), then every 5 years or 100,000 mi (160,000 km).

SPECIAL OPERATING CONDITIONS SCHEDULED MAINTENANCE

If you operate your vehicle primarily in any of the following conditions, you need to perform extra maintenance, as indicated. If you operate your vehicle occasionally under any of these conditions, it is not necessary to perform the extra maintenance. For specific recommendations, see your dealership service advisor or technician.

Perform the services shown in the following tables when specified or within 3,000 mi (4,800 km) of the oil change required message appearing in the information display.

Scheduled Maintenance

- Example 1: The message comes on at 28,751 mi (46,270 km). Perform the 30,000 mi (48,000 km) automatic transmission fluid replacement.
- Example 2: The message has not come on, but the odometer reads 30,000 mi (48,000 km), for example, the oil change reminder was reset at 25,000 mi (40,000 km). Perform the engine air filter replacement.

Towing a Trailer or Using a Car-top Carrier	
As required	Change the engine oil and filter as indicated by the information display and perform services listed in the Normal Scheduled Maintenance chart.
Inspect frequently, service as required	Inspect and lubricate the U-joints.
	See the axle maintenance items under Exceptions.
Every 60,000 mi (96,000 km)	Replace the spark plugs.

Extensive Idling or Low-speed Driving for Long Distances, as in Heavy Commercial Use, such as Delivery, Taxi, Patrol Car or Livery	
As required	Change the engine oil and filter as indicated by the information display and perform services listed in the Normal Scheduled Maintenance chart.
Inspect frequently, service as required	Replace the engine air filter.
Every 60,000 mi (96,000 km)	Replace the spark plugs.

Scheduled Maintenance

Operating in Dusty or Sandy Conditions, such as Unpaved or Dusty Roads	
Inspect frequently, service as required	Replace the engine air filter.
Every 5,000 mi (8,000 km)	Inspect the wheels and related components for abnormal noise, wear, looseness or drag.
	Rotate the tires, inspect tires for wear and measure the tread depth.
Every 5,000 mi (8,000 km) or six months	Change the engine oil and filter. ¹

¹Reset your oil change reminder after each engine oil and filter change. See **Resetting the Engine Oil Change Reminder** (page 322).

Off-road Operation	
Inspect frequently, service as required	Inspect the steering linkage, ball joints and the U-joints. Lubricate grease fittings, if applicable.
	Replace the engine air filter.
Every 5,000 mi (8,000 km) or six months	Change the engine oil and filter. ¹
	Inspect the wheels and related components for abnormal noise, wear, looseness or drag.
	Rotate the tires, inspect tires for wear and the measure the tread depth.

¹Reset your oil change reminder after each engine oil and filter change. See **Resetting the Engine Oil Change Reminder** (page 322).

Exclusive Use of E85 - Flex Fuel Vehicles Only	
Every oil change interval	If ran exclusively on E85, fill the fuel tank full with regular unleaded fuel.

Exceptions

There are several exceptions to the Normal Schedule.

Scheduled Maintenance

Axle and Transfer Case Maintenance

Axle(s) and transfer case, four-wheel drive vehicles, fluid changes or level checks are not required unless a leak is suspected or the assembly has been submerged in water. Contact an authorized dealer for service.

California Fuel Filter Replacement

If you register your vehicle in California, the California Air Resources Board has determined that the failure to perform this maintenance item does not nullify the emission warranty or limit recall liability before the completion of your vehicle's useful life. Ford Motor Company, however, urges you to have all recommended maintenance services performed at the specified intervals and to record all vehicle service.

Hot Climate Oil Change Intervals

Vehicles operating in the Middle East, North Africa, Sub-Saharan Africa or locations with similar climates using an oil that meets our specification or has an American Petroleum Institute (API) Certified for Gasoline Engines (Certification mark) oil, the normal oil change interval is 3,000 mi (4,800 km).

Engine Air Filter Replacement

The life of the engine air filter is dependent on exposure to dusty and dirty conditions. Vehicles operated in these conditions require frequent inspection and replacement of the engine air filter.

Customer Information

ROLLOVER WARNING



WARNING: Utility vehicles have a significantly higher rollover rate than other types of vehicles.



WARNING: Vehicles with a higher center of gravity (utility and four-wheel drive vehicles) handle differently than vehicles with a lower center of gravity (passenger cars). Avoid sharp turns, excessive speed and abrupt steering in these vehicles. Failure to drive cautiously increases the risk of losing control of your vehicle, vehicle rollover, personal injury and death.



WARNING: In a rollover crash, an unbelted person is significantly more likely to die than a person wearing a seatbelt.



WARNING: Do not become overconfident in the ability of four-wheel drive vehicles. Although a four-wheel drive vehicle may accelerate better than a two-wheel drive vehicle in low traction situations, it won't stop any faster than two-wheel drive vehicles. Always drive at a safe speed.

Utility vehicles and trucks handle differently than passenger cars in the various driving conditions that are encountered on streets, highways and off-road. Utility vehicles and trucks are not designed for cornering at speeds as high as passenger cars any more than low-slung sports cars are designed to perform satisfactorily under off-road conditions.

OUR SUSTAINABILITY REPORT

You should play your part in protecting the environment. Correct vehicle usage and the authorized disposal of waste, cleaning and lubrication materials are significant steps toward this aim.

For additional information about our sustainability progress and initiatives, visit www.sustainability.ford.com.

THE BETTER BUSINESS BUREAU AUTO LINE PROGRAM - UNITED STATES OF AMERICA

Your satisfaction is important to Ford Motor Company and to your dealer. If a warranty concern has not been resolved using the three-step procedure outlined earlier in this chapter in the Getting the Services you need section, you may be eligible to participate in the BBB AUTO LINE program.

The BBB AUTO LINE program consists of two parts – mediation and arbitration. During mediation, a representative of the BBB will contact both you and Ford Motor Company to explore options for settlement of the claim. If an agreement is not reached during mediation or you do not want to participate in mediation, and if your claim is eligible, you may participate in the arbitration process. An arbitration hearing will be scheduled so that you can present your case in an informal setting before an impartial person. The arbitrator considers the testimony provided and makes a decision after the hearing.

Customer Information

Disputes submitted to the BBB AUTO LINE program are usually decided within 40 days after you file your claim with the BBB. You are not bound by the decision, and may reject the decision and proceed to court where all findings of the BBB Auto Line dispute, and decision, are admissible in the court action. Should you choose to accept the BBB AUTO LINE decision, Ford is then bound by the decision, and must comply with the decision within 30 days of receipt of your acceptance letter.

BBB AUTO LINE Application: Using the information that follows, please call or write to request a program application. You will be asked for your name and address, general information about your new vehicle, information about your warranty concerns, and any steps you have already taken to try to resolve them. A Customer Claim Form will be mailed that needs to be completed, signed and returned to the BBB along with proof of ownership. Upon receipt, the BBB reviews the claim for eligibility under the Program Summary Guidelines.

You can get more information by calling BBB AUTO LINE at 1-800-955-5100, or writing to:

**BBB AUTO LINE a Division of BBB National Programs, Inc.
1676 International Drive, Suite 550
McLean, VA 22102**

BBB AUTO LINE applications can also be requested by calling the Ford Motor Company Customer Relationship Center at 1-800-392-3673.

For additional information, refer to the Better Business Bureau website.

Note: *Ford Motor Company reserves the right to change eligibility limitations, modify procedures, or to discontinue this process at any time without notice and without obligation.*

THE MEDIATION AND ARBITRATION PROGRAM - CANADA

For vehicles delivered to authorized Canadian dealers. In those cases where you continue to feel that the efforts by Ford of Canada and the authorized dealer to resolve a factory-related vehicle service concern have been unsatisfactory, Ford of Canada participates in an impartial third party mediation/arbitration program administered by the Canadian Motor Vehicle Arbitration Plan (CAMVAP).

The CAMVAP program is a straightforward and relatively speedy alternative to resolve a disagreement when all other efforts to produce a settlement have failed. This procedure is without cost to you and is designed to eliminate the need for lengthy and expensive legal proceedings.

In the CAMVAP program, impartial third-party arbitrators conduct hearings at mutually convenient times and places in an informal environment. These impartial arbitrators review the positions of the parties, make decisions and, when appropriate, render awards to resolve disputes. CAMVAP decisions are fast, fair, and final as the arbitrator's award is binding on both you and Ford of Canada.

CAMVAP services are available in all Canadian territories and provinces. For more information, without charge or obligation, call your CAMVAP Provincial Administrator directly at 1-800-207-0685 or visit www.camvap.ca.

ORDERING A CANADIAN FRENCH OWNER'S MANUAL

You can obtain a French owner's manual from an authorized dealer or by contacting Helm, LLC at:

Customer Information

HELM, LLC
47911 Halyard Drive, Suite 200
Plymouth, Michigan 48170
Attention: Customer Service

Call toll free: 1-800-782-4356

Monday-Friday 8:00 a.m. - 6:00 p.m. EST

For additional information, visit
www.helminc.com.

REPORTING SAFETY DEFECTS IN THE UNITED STATES

If you believe that your vehicle has a defect which could cause a crash or could cause injury or death, you should immediately inform the National Highway Traffic Safety Administration (NHTSA) in addition to notifying Ford Motor Company.

If NHTSA receives similar complaints, it may open an investigation, and if it finds that a safety defect exists in a group of vehicles, it may order a recall and remedy campaign. However, NHTSA cannot become involved in individual problems between you, your dealer, or Ford Motor Company.

To contact NHTSA, you may call the Vehicle Safety Hotline toll-free at 1-888-327-4236 (TTY: 1-800-424-9153); go to www.safercar.gov; or write to:

Administrator

1200 New Jersey Avenue,
Southeast

Washington, D.C. 20590

You can also obtain other information about motor vehicle safety from www.safercar.gov.

REPORTING SAFETY DEFECTS IN CANADA

If you believe that your vehicle has a defect which could cause a crash or could cause injury or death, you should immediately inform Transport Canada and Ford of Canada.

Transport Canada Contact Information	
Website	http://tc.canada.ca/recalls
Website	http://tc.canada.ca/rappels
Phone	1-800-333-0510

Customer Information

Ford of Canada Contact Information

Website	www.ford.ca
Phone	1-800-565-3673

RADIO FREQUENCY CERTIFICATION LABELS

BLIND SPOT INFORMATION SYSTEM SENSORS

Argentina



Belarus



Brazil



Canada

Short Range Radar Sensor SRR3-B
IC ID: 4135A-SRR3B

Customer Information

This device contains licence-exempt transmitter(s)/receiver(s) that comply with Innovation, Science and Economic Development Canada's licence-exempt RSS(s). Operation is subject to the following two conditions:

1. This device may not cause interference.
2. This device must accept any interference, including interference that may cause undesired operation of the device.

Radiofrequency radiation exposure information:

This equipment complies with radiation exposure limits set forth for an uncontrolled environment. This equipment should be installed and operated with minimum distance of 8 in (20 cm) between the radiator and the body of any persons, user or bystander.

L'émetteur/récepteur exempt de licence contenu dans le présent appareil est conforme aux CNR d'Innovation, Sciences et Développement économique Canada applicables aux appareils radio exempts de licence. L'exploitation est autorisée aux deux conditions suivantes:

1. L'appareil ne doit pas produire de brouillage;
2. L'appareil doit accepter tout brouillage radioélectrique subi, même si le brouillage est susceptible d'en compromettre le fonctionnement.

Cet équipement est conforme aux limites d'exposition aux rayonnements établies pour un environnement non contrôlé. Cet équipement doit être installé et utilisé avec un minimum de 8 in (20 cm) de distance entre la source de rayonnement et votre corps.

Djibouti

AGREE PAR LE MCPT (REPUBLIQUE DE DJIBOUTI)
Numéro d'agrément : 240/MCPT/SG/16
Date d'agrément : 23/05/2016

European Union EU

CE

Customer Information

Ghana

NCA PRODUCT IDENTIFIER: 3R8-8M-7DF-231

Mauritania

AGREE PAR L'ANE MAURITANIE
Numéro d'agrément : 0727/ARE/2018
Date d'agrément : 10/12/2019

Jamaica

This product has been Type Approved
by Jamaica: SMA - SRR3-B.

Malaysia



RALM/24A/0715/S(15-2272)

Mexico

IFETEL: RLVCSR15-0904

La operación de este equipo está sujeta a las siguientes
dos condiciones:

- (1) es posible que este equipo o dispositivo no cause
interferencia perjudicial y
- (2) este equipo o dispositivo debe aceptar cualquier
interferencia, incluyendo la que pueda causar
su operación no deseada.

Moldova



Customer Information

Pakistan



Serbia



Paraguay



Singapore

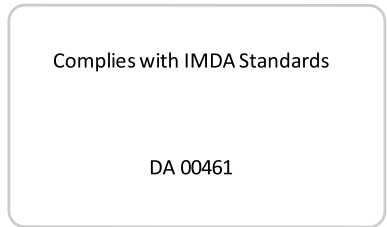

Russia



South Africa



Customer Information

South Korea



MSIP-CRM-8DC-SRR3B

Taiwan, China

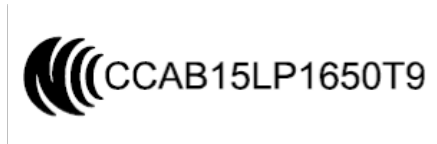

警語

經型式認證合格之低功率射頻電機，非經許可，公司、商號或使用者均不得擅自變更頻率、加大功率或變更原設計之特性及功能。

低功率射頻電機之使用不得影響飛航安全及干擾合法通信；經發現有干擾現象時，應立即停用，並改善至無干擾時方得繼續使用。

前項合法通信，指依電信法規定作業之無線電通信。低功率射頻電機須忍受合法通信或工業、科學及醫療用電波輻射性電機設備之干擾。

Customer Information

Ukraine



справжнім FDC. Automotive Distance Control Systems GmbH заявляє, що тип радіообладнання SRR3 - В відповідає технічному регламенту радіообладнання ;

повний текст декларації про відповідність доступний на веб-сайті за такою адресою :

<http://continental.automotive-approvals.com/>

United Arab Emirates (U.A.E.)

TRA
REGISTERED No:
ER62934

DEALER No:
DA40068

This device complies with Part 15 of the FCC Rules. Operation is subject to the following two conditions:

1. This device may not cause harmful interference, and
2. This device must accept any interference received, including interference that may cause undesired operation.

CAUTION TO USERS

Changes or modifications not expressly approved by the party responsible for compliance could void the user's authority to operate the equipment.

United States of America

FCC ID: OAYSRR3B

Customer Information

Vietnam

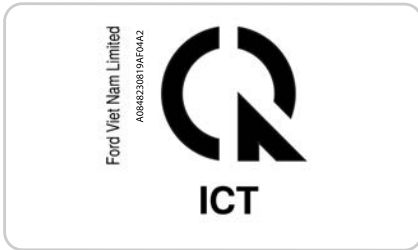

Brazil



Zambia



Ghana

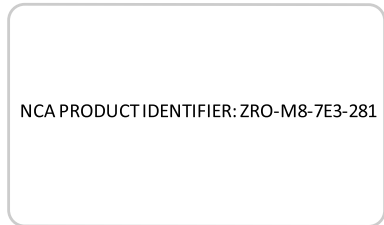

BODY CONTROL MODULE

Argentina



Jamaica

This product has been Type Approved by Jamaica: SMA - M3NA2C766336.

Customer Information

Moldova



Serbia



И011 20

Morocco

AGREE PAR L'ANRT MAROC
Numéro d'agrément: MR 20148 ANRT 2019
Date d'agrément: 19/06/2019

Singapore

Complies with IMDA Standards

DA 00461

Paraguay



2019-01-I-000076

South Africa



Customer Information

Ukraine



This device complies with Part 15 of the FCC Rules and with Innovation, Science and Economic Development Canada's licence-exempt RSS(s). Operation is subject to the following two conditions:

1. This device may not cause harmful interference, and
2. This device must accept any interference received, including interference that may cause undesired operation.

Vietnam

United Arab Emirates (U.A.E.)

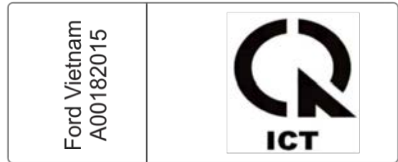
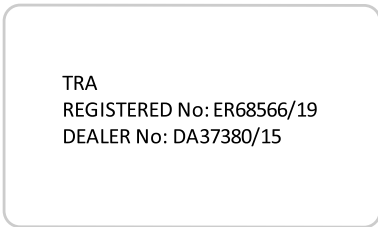

Zambia

United States and Canada

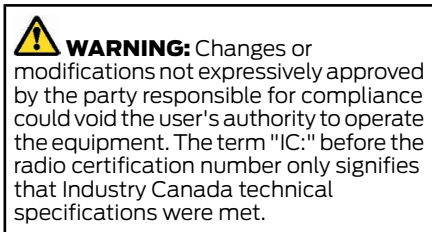

FCC ID: M3NA2C766336

IC: 7812A-A2C766336

Customer Information

GARAGE DOOR OPENER

United States and Canada



WARNING: Changes or modifications not expressly approved by the party responsible for compliance could void the user's authority to operate the equipment. The term "IC:" before the radio certification number only signifies that Industry Canada technical specifications were met.

FCC ID: NZLSAHL5E

IC: 4112A-SAHL5E

This device complies with Part 15 of the FCC Rules and with Innovation, Science and Economic Development Canada's licence-exempt RSS(s). Operation is subject to the following two conditions:

1. This device may not cause harmful interference, and
2. This device must accept any interference received, including interference that may cause undesired operation.

KEYS AND REMOTE CONTROLS

Argentina

CNC COMISIÓN NACIONAL
DE COMUNICACIONES

CNC ID: H-22290

CNC COMISIÓN NACIONAL
DE COMUNICACIONES

CNC ID: H-16355

CNC: H-16366

CNC COMISIÓN NACIONAL
DE COMUNICACIONES

CNC COMISIÓN NACIONAL
DE COMUNICACIONES

CNC ID: H-24101

Customer Information

Brazil



Canada and United States of America

 **WARNING:** Changes or modifications not expressly approved by the party responsible for compliance could void the user's authority to operate the equipment. The term "IC:" before the radio certification number only signifies that Industry Canada technical specifications were met.

FCC ID: M3N-A2C931426

FCC ID: M3N-A2C931423

IC: 7812A-A2C931426

IC: 7812A-A2C913423

This device complies with Part 15 of the FCC Rules and with Innovation, Science and Economic Development Canada's licence-exempt RSS(s). Operation is subject to the following two conditions:

1. This device may not cause harmful interference, and
2. This device must accept any interference received, including interference that may cause undesired operation.

Djibouti

AGREE PAR LE MCPT (REPUBLIQUE DE DJIBOUTI)
Numéro d'agrément : 287/MCPT/SC/16
Date d'agrément : 02/07/2016

AGREE PAR LE MCPT (REPUBLIQUE DE DJIBOUTI)
Numéro d'agrément : 289/MCPT/SC/116
Date d'agrément : 02/07/2016

Ghana

NCA APPROVED: 2R9-8M-7E0-x94

Customer Information

Malaysia

NCA APPROVED: 2R9-1H-7E0-01A

Jamaica

This product has been Type Approved
by Jamaica: SMA – A2C97102000



F17000176

**This product has been Type Approved
by Jamaica: SMA – A2C93142100**

Mauritania

AGREE PAR L'ANE MAURITANIE
Numéro d'agrément : 0324/ARE/2016
Date d'agrément : 07/03/2016

This product has been Type Approved by Jamaica: SMA – M3N-A2C931426

AGREE PAR L'ANE MAURITANIE
Numéro d'agrément : 0323/ARE/2016
Date d'agrément : 07/03/2016

This product has been Type Approved by Jamaica: SMA – M3N-A2C931423

Customer Information

Moldova



Pakistan

Pakistan Telecommunication Authority



Approved by PTA 2016

Morocco

AGREE PAR L'ANRT MAROC
Numéro d'agrément : MR 12432 ANRT 2016
Date d'agrément : 31/08/2016

Paraguay



AGREE PAR L'ANRT MAROC
Numéro d'agrément : MR 12433 ANRT 2016
Date d'agrément : 31/08/2016

NR: 2016-9-I-000222
NR: 2016-9-I-000220
NR: 2016-9-I-000223

Customer Information

Serbia

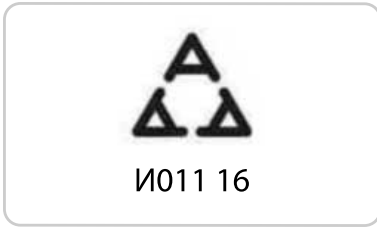

Singapore

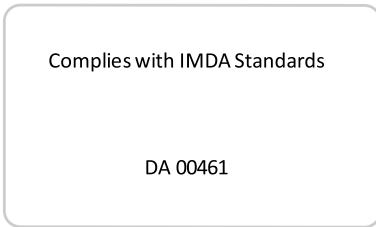

South Korea



MSIP-CRM-TAL-A2C97102000

South Africa



Taiwan, China



Customer Information

 CCAB16LP284DT9

TRA
REGISTERED No:
ER46754/16

DEALER No:
DA37380/15

Ukraine



Vietnam



United Arab Emirates (U.A.E.)

TRA
REGISTERED No: ER47690/16
DEALER No: DA37380/15

Zambia



Customer Information



RADIO TRANSCEIVER MODULE

Argentina



Brazil



Djibouti

AGREE PAR LE MCPT (REPUBLIQUE DE DJIBOUTI)
Numéros d'agrément : 033/DDTIC/2020
Date d'agrément : 07/06/2020

AGREE PAR LE MCPT (REPUBLIQUE DE DJIBOUTI)
Numéros d'agrément : 034/DDTIC/2020
Date d'agrément : 07/06/2020

Ghana

NCA APPROVED: SRO-1M-7E4-108

NCA APPROVED: SRO-1M-7E4-114

Mauritania

AGREE PAR L'ANE MAURITANIE
Numéro d'agrément: 0803/ARE/2020
Date d'agrément: 03/06/2020

Customer Information

South Africa

AGREE PAR L'ANE MAURITANIE
Numéro d'agrément : 0802/ARE/2020
Date d'agrément : 03/06/2020



Morocco

AGREE PAR L'ANE MAROC
Numéro d'agrément : MR 24102 ANRT 2020
Date d'agrément : 18/05/2020

United Arab Emirates (U.A.E.)

TRA
REGISTERED No:
ER81341/20

DEALER No:
DA88113/20

Pakistan



TRA
REGISTERED No:
ER81342/20

DEALER No:
DA88113/20

Customer Information

United States and Canada



WARNING: Changes or modifications not expressly approved by the party responsible for compliance could void the user's authority to operate the equipment. The term "IC:" before the radio certification number only signifies that Industry Canada technical specifications were met.

FCC ID: L2C0082R

FCC ID: L2C0083TR

IC: 342A-0083TR

This device complies with Part 15 of the FCC Rules and with Innovation, Science and Economic Development Canada's licence-exempt RSS(s). Operation is subject to the following two conditions:

1. This device may not cause harmful interference, and
2. This device must accept any interference received, including interference that may cause undesired operation.

Zambia



SYNC

Argentina

CNC COMISIÓN NACIONAL
DE COMUNICACIONES

CNC ID: C-24008

CNC COMISIÓN NACIONAL
DE COMUNICACIONES

CNC ID: C-24009

Brazil



08657-19-01505

Este equipamento não tem direito à proteção contra interferência prejudicial e não pode causar interferência em sistemas devidamente autorizados.

Customer Information



08658-19-01505

Este equipamento não tem direito à proteção
contra interferência prejudicial e não pode causar
interferência em sistemas devidamente autorizados.

European Union EU

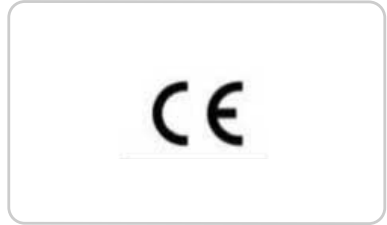

Djibouti

AGREE PAR LE MCPT (REPUBLIQUE DE DJIBOUTI)
Numéro d'agrément : 124/DDTIC/2019
Date d'agrément : 07/08/2019



Ghana

NCA APPROVED: ZRO-1H-7E3-182

NCA APPROVED: ZRO-1H-7E3-180

Jamaica

This product has been Type Approved by
Jamaica: SMA – SYNC-G4.

Customer Information

This product has been Type Approved by Jamaica: SMA – SYNC-G4L

AGREE PAR L'ANE MAURITANIE
Numéro d'agrément : 0691/ARE/2018
Date d'agrément : 08/08/2019

Malaysia



SQASI/TA/19/4047

SQASI/TA/19/4046

Mauritania

AGREE PAR L'ANE MAURITANIE
Numéro d'agrément : 0692/ARE/2018
Date d'agrément : 08/08/2019

Moldova



Morocco

AGREE PAR L'ANRT MAROC
N° D'AGRÉMENT: MR 20608 ANRT 2019
07 AOUT 2019

Customer Information

Serbia

AGREE PAR L'ANRT MAROC
N° D'AGRÉMENT: MR 20606 ANRT 2019
07 AOUT 2019



M005 20

Pakistan



Singapore

Complies with IMDA Standards

DA 00461

Paraguay



South Africa



2020-03-I-00192

2020-03-I-00193

Customer Information



South Korea



Ukraine



Taiwan



United Arab Emirates (U.A.E.)

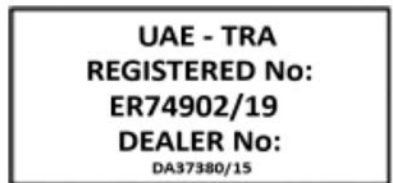

Customer Information

Zambia



United States and Canada

 **WARNING:** Changes or modifications not expressly approved by the party responsible for compliance could void the user's authority to operate the equipment. The term "IC:" before the radio certification number only signifies that Industry Canada technical specifications were met.



FCC ID: KMH-SYNG4

FCC ID: KMH-SYNG4L

IC: 1422A-SYNG4

IC: 1422A-SYNG4L

This device complies with Part 15 of the FCC Rules and with Innovation, Science and Economic Development Canada's licence-exempt RSS(s). Operation is subject to the following two conditions:

1. This device may not cause harmful interference, and
2. This device must accept any interference received, including interference that may cause undesired operation.

TELEMATICS CONTROL UNIT

United Arab Emirates (U.A.E.)

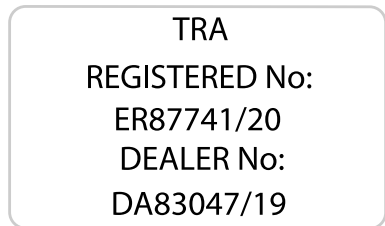

Customer Information

United States and Canada



WARNING: Changes or modifications not expressly approved by the party responsible for compliance could void the user's authority to operate the equipment. The term "IC:" before the radio certification number only signifies that Industry Canada technical specifications were met.

FCC ID: KMH-14H074-NA1

IC: 1422A-14H074NA1

This device complies with Part 15 of the FCC Rules and with Innovation, Science and Economic Development Canada's licence-exempt RSS(s). Operation is subject to the following two conditions:

1. This device may not cause harmful interference, and
2. This device must accept any interference received, including interference that may cause undesired operation.

TIRE PRESSURE MONITORING SYSTEM SENSORS - VEHICLES WITH: 315 MHZ SENSORS

Argentina

CNC COMISIÓN NACIONAL
DE COMUNICACIONES

CNC ID: H-24068

Brazil



05160-16-08001

Este equipamento opera em caráter secundário, isto é, não tem direito a proteção contra interferência prejudicial, mesmo de estações do mesmo tipo, e não pode causar interferência a sistemas operando em caráter primário.

Jamaica

This product has been Type Approved by Jamaica: SMA – FP3

Mexico

IFT: RLVSCFP16-1400
"La operación de este equipo está sujeta a las siguientes dos condiciones:
(1) es posible que este equipo o dispositivo no cause interferencia perjudicial y
(2) este equipo o dispositivo debe aceptar cualquier interferencia, incluyendo la que pueda causar su operación no deseada."

Customer Information

Paraguay



TIRE PRESSURE MONITORING SYSTEM SENSORS - VEHICLES WITH: 433 MHZ SENSORS

Argentina



United States and Canada

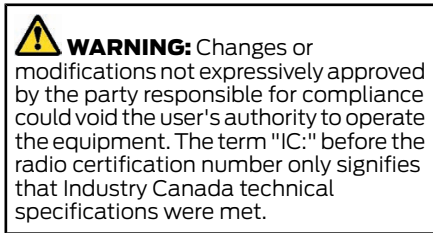

FCC ID: MRXFP3

IC: 2546A-FP3

This device complies with Part 15 of the FCC Rules and with Innovation, Science and Economic Development Canada's licence-exempt RSS(s). Operation is subject to the following two conditions:

1. This device may not cause harmful interference, and
2. This device must accept any interference received, including interference that may cause undesired operation.

China

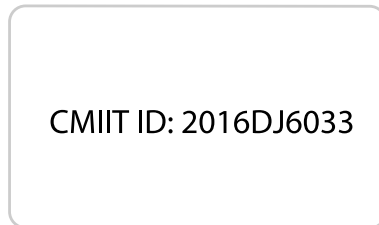

Customer Information

Djibouti

AGREE PAR LE MCPT
(REPUBLIQUE DE DJIBOUTI)
Numéro d'agrément : 547/MCPT/DPT/16
Date d'agrément : 27/09/16

Mauritania

AGREE PAR L'ANE MAURITANIE
Numéro d'agrément : 0358/ARE/2016
Date d'agrément : 04/10/2016

Ghana

NCA APPROVED: 2R9-8M-7E0-0BE

Jordan

Model: FP4
Manufacturer: Schrader Electronics Ltd
Type Approval No: TRC/LPD/2017/360
Equipment Type: Low Power Device (LPD)

Moldova



Nigeria

Connection and use of this
communications
equipment is permitted by the Nigerian
Communications Commission

Customer Information

Oman

OMAN TRA
TA-R/3591/16
D080134

Pakistan

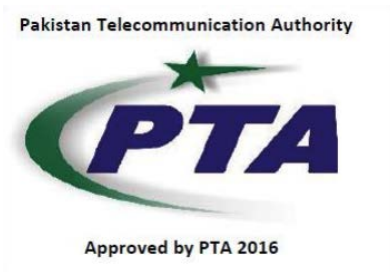

Paraguay



Serbia

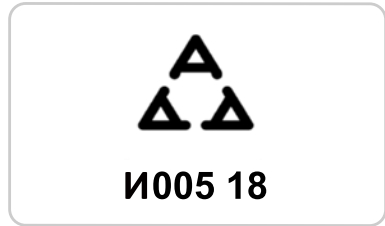

Singapore

Complies with
IMDA Standards
DA 107968

South Korea



Ukraine



Customer Information

United Arab Emirates

TRA
REGISTERED No:
ER48598/16

DEALER No.
DA0047074

Djibouti

AGREE PAR LE MCPT (REPUBLIQUE DE DJIBOUTI)
Numéro d'agrément : 004/DDTIC/2019
Date d'agrément : 10/01/2019

WIRELESS ACCESSORY CHARGING MODULE

Argentina

CNC COMISIÓN NACIONAL
DE COMUNICACIONES

CNC ID: H-21576

European Union EU

CE

Ghana

NCA APPROVED: 1R3-1M-7E1-174

Brazil

 **ANATEL**

Agência Nacional de Telecomunicações

04021-18-06661

Jamaica

This product has been Type Approved
by Jamaica: SMA - WACM.

Customer Information

Jordan

Type Approval No: TRC/LPD/2017/418
Equipment Type: Low Power Device (LPD)

Malaysia



SQASI/TA/19/4129

Mauritania

AGREE PAR L'ANE MAURITANIE
Numéro d'agrément : 0474/ARE/2018
Date d'agrément : 05/03/2018

Moldova



Morocco

AGREE PAR L'ANRT MAROC
Numéro d'agrément : MR 15474 ANRT 2017
Date d'agrément : 25/12/2017

Paraguay



2017-10-I-0000333

Customer Information

Serbia



M011 18

South Korea



R-RMM-DLH-WACM

Singapore

Complies with IMDA Standards

DA 00461

Taiwan, China



CCAH17LP1930T0

South Africa



Ukraine



UA.TR.028

Customer Information

United Arab Emirates (U.A.E.)

TRA
REGISTERED No:
ER57347/17

DEALER No:
DA37380/15

Vietnam



United States



WARNING: Changes or modifications not expressly approved by the party responsible for compliance could void the user's authority to operate the equipment. The term "IC:" before the radio certification number only signifies that Industry Canada technical specifications were met.

FCC ID: L2C0066T

This device complies with Part 15 of the FCC Rules and with Innovation, Science and Economic Development Canada's licence-exempt RSS(s). Operation is subject to the following two conditions:

1. This device may not cause harmful interference, and
2. This device must accept any interference received, including interference that may cause undesired operation.

Zambia



CALIFORNIA PROPOSITION 65 - UNITED STATES OF AMERICA



WARNING: Operating, servicing and maintaining a passenger vehicle or off-highway motor vehicle can expose you to chemicals including engine exhaust, carbon monoxide, phthalates, and lead, which are known to the State of California to cause cancer and

Customer Information

birth defects or other reproductive harm. To minimize exposure, avoid breathing exhaust, do not idle the engine except as necessary, service your vehicle in a well-ventilated area and wear gloves or wash your hands frequently when servicing your vehicle. For more information go to www.P65Warnings.ca.gov/passenger-vehicle.



WARNING: Battery posts, terminals and related accessories contain lead and lead compounds, chemicals known to the State of California to cause cancer and reproductive harm. **Wash your hands after handling.**

PERCHLORATE

Certain components in your vehicle such as airbag modules, seatbelt pretensioners and remote control batteries may contain perchlorate material. Special handling may apply for service or vehicle end of life disposal.

For more information visit:
www.dtsc.ca.gov/hazardouswaste/perchlorate.

REPLACEMENT PARTS RECOMMENDATION

We have built your vehicle to the highest standards using quality parts. We recommend that you demand the use of genuine Ford and Motorcraft parts whenever your vehicle requires scheduled maintenance or repair. You can clearly identify genuine Ford and Motorcraft parts by looking for the Ford, FoMoCo or Motorcraft branding on the parts or their packaging.

Scheduled Maintenance and Mechanical Repairs

One of the best ways for you to make sure that your vehicle provides years of service is to have it maintained in line with our recommendations and instructions using parts that conform to the original vehicle parts specification. Genuine Ford and Motorcraft parts meet or exceed these specifications.

Collision Repairs

We hope that you never experience a collision, but accidents do happen. Genuine Ford replacement collision parts meet our stringent requirements for fit, finish, structural integrity, corrosion protection and dent resistance. During vehicle development we validate that these parts deliver the intended level of protection as a whole system. A great way to know for sure you are getting this level of protection is to use genuine Ford replacement collision parts.

Customer Information

Warranty on Replacement Parts

Genuine Ford and Motorcraft replacement parts are the only replacement parts that benefit from a Ford Warranty. The Ford Warranty may not cover damage caused to your vehicle because of failed non-Ford parts. For extra information, refer to the terms and conditions of the Ford Warranty.

MOBILE COMMUNICATIONS EQUIPMENT



WARNING: Driving while distracted can result in loss of vehicle control, crash and injury. We strongly recommend that you use extreme caution when using any device that may take your focus off the road. Your primary responsibility is the safe operation of your vehicle. We recommend against the use of any hand-held device while driving and encourage the use of voice-operated systems when possible. Make sure you are aware of all applicable local laws that may affect the use of electronic devices while driving.

Using mobile communications equipment is becoming increasingly important in the conduct of business and personal affairs. However, you must not compromise your own or others' safety when using such equipment. Mobile communications can enhance personal safety and security when appropriately used, particularly in emergency situations. Safety must be paramount when using mobile communications equipment to avoid negating these benefits. Mobile communication equipment includes, but is not limited to, cellular phones, pagers, portable email devices, text messaging devices and portable two-way radios.

END USER LICENSE AGREEMENT

VEHICLE SOFTWARE END USER LICENSE AGREEMENT (EULA)

- You ("You" or "Your" as applicable) have acquired a vehicle having several devices, including SYNC ® and various control modules, ("DEVICES") that include software licensed or owned by Ford Motor Company and its affiliates ("FORD MOTOR COMPANY"). Those software products of FORD MOTOR COMPANY origin, as well as associated media, printed materials, and "online" or electronic documentation ("SOFTWARE") are protected by international intellectual property laws and treaties. The SOFTWARE is licensed, not sold. All rights reserved.
- The SOFTWARE may interface with and/or communicate with, or may be later upgraded to interface with and/or communicate with additional software and/or systems provided by FORD MOTOR COMPANY.

IF YOU DO NOT AGREE TO THIS END USER LICENSE AGREEMENT ("EULA") DO NOT USE THE DEVICES OR COPY THE SOFTWARE. ANY USE OF THE SOFTWARE, INCLUDING BUT NOT LIMITED TO USE ON THE DEVICES, WILL CONSTITUTE YOUR AGREEMENT TO THIS EULA (OR RATIFICATION OF ANY PREVIOUS CONSENT).

GRANT OF SOFTWARE LICENSE: This EULA grants you the following license:

- You may use the SOFTWARE as installed on the DEVICES and as otherwise interfacing with systems and/or services provide by or through FORD MOTOR COMPANY or its third party software and service providers.

Customer Information

Description of Other Rights and Limitations.

- **Speech Recognition:** If the SOFTWARE includes speech recognition component(s), you should understand that speech recognition is an inherently statistical process and that recognition errors are inherent in the process. Neither FORD MOTOR COMPANY nor its suppliers shall be liable for any damages arising out of errors in the speech recognition process. It is your responsibility to monitor any speech recognition functions included in the system.
- **Limitations on Reverse Engineering, Decompilation and Disassembly:** You may not reverse engineer, decompile, translate, disassemble or attempt to discover any source code or underlying ideas or algorithms of the SOFTWARE nor permit others to reverse engineer, decompile or disassemble the SOFTWARE, except and only to the extent that such activity is expressly permitted by applicable law notwithstanding this limitation or to the extent as may be permitted by the licensing terms governing use of any open source components included with the SOFTWARE.
- **Limitations on Distributing, Copying, Modifying and Creating Derivative Works:** You may not distribute, copy, make modifications to or create derivative works based on the SOFTWARE, except and only to the extent that such activity is expressly permitted by applicable law notwithstanding this limitation or to the extent as may be permitted by the licensing terms governing use of any open source components included with the SOFTWARE.
- **Single EULA:** The end user documentation for the DEVICES and related systems and services may contain multiple EULAs, such as multiple translations and/or multiple media versions (e.g., in the user documentation and in the software). Even if you receive multiple EULAs, you are licensed to use only one (1) copy of the SOFTWARE.
- **SOFTWARE Transfer:** You may permanently transfer your rights under this EULA only as part of a sale or transfer of the DEVICES, provided you retain no copies, you transfer all of the SOFTWARE (including all component parts, the media and printed materials, any upgrades, and, if applicable, the Certificate(s) of Authenticity), and the recipient agrees to the terms of this EULA. If the SOFTWARE is an upgrade, any transfer must include all prior versions of the SOFTWARE.
- **Termination:** Without prejudice to any other rights, FORD MOTOR COMPANY may terminate this EULA if you fail to comply with the terms and conditions of this EULA.
- **Internet-Based Services Components:** The SOFTWARE may contain components that enable and facilitate the use of certain Internet-based services. You acknowledge and agree that FORD MOTOR COMPANY, third party software and service suppliers, its affiliates and/or its designated agent may automatically check the version of the SOFTWARE and/or its components that you are utilizing and may provide upgrades or supplements to the SOFTWARE that may be automatically downloaded to your DEVICES.

Customer Information

- **Additional Software/Services:** The SOFTWARE may permit FORD MOTOR COMPANY, third party software and service suppliers, its affiliates and/or its designated agent to provide or make available to you SOFTWARE updates, supplements, add-on components, or Internet-based services components of the SOFTWARE after the date you obtain your initial copy of the SOFTWARE ("Supplemental Components".) SOFTWARE updates may cause you to incur additional charges from your wireless service provider. If FORD MOTOR COMPANY or third party software and services suppliers provide or make available to you Supplemental Components and no other EULA terms are provided along with the Supplemental Components, then the terms of this EULA shall apply. FORD MOTOR COMPANY, its affiliates and/or its designated agent reserve the right to discontinue without liability any Internet-based services provided to you or made available to you through the use of the SOFTWARE.
- **Links to Third Party Sites:** The SOFTWARE may provide you with the ability to link to third party sites. The third party sites are not under the control of FORD MOTOR COMPANY, its affiliates and/or its designated agent. Neither FORD MOTOR COMPANY nor its affiliates nor its designated agent are responsible for (i) the contents of any third party sites, any links contained in third party sites, or any changes or updates to third party sites, or (ii) webcasting or any other form of transmission received from any third party sites. If the SOFTWARE provides links to third party sites, those links are provided to you only as a convenience, and the inclusion of any link does not imply an endorsement of the third party site by FORD MOTOR COMPANY, its affiliates and/or its designated agent.
- **Obligation to Drive Responsibly:** You recognize your obligation to drive responsibly and keep attention on the road. You will read and abide with the DEVICES operating instructions particularly as they pertain to safety and you agree to assume any risk associated with the use of the DEVICES.

UPGRADES AND RECOVERY MEDIA:

If the SOFTWARE is provided by FORD MOTOR COMPANY separate from the DEVICES on media such as a ROM chip, CD ROM disk(s) or via web download or other means, and is labeled "For Upgrade Purposes Only" or "For Recovery Purposes Only" you may install one (1) copy of such SOFTWARE onto the DEVICES as a replacement copy for the existing SOFTWARE, and use it in accordance with this EULA, including any additional EULA terms accompanying the upgrade SOFTWARE.

Customer Information

INTELLECTUAL PROPERTY RIGHTS:

All title and intellectual property rights in and to the SOFTWARE (including but not limited to any images, photographs, animations, video, audio, music, text and "applets" incorporated into the SOFTWARE), the accompanying printed materials, and any copies of the SOFTWARE, are owned by FORD MOTOR COMPANY, or its affiliates or suppliers. The SOFTWARE is licensed, not sold. You may not copy the printed materials accompanying the SOFTWARE. All title and intellectual property rights in and to the content which may be accessed through use of the SOFTWARE is the property of the respective content owner and may be protected by applicable copyright or other intellectual property laws and treaties. This EULA grants you no rights to use such content outside its intended use. All rights not specifically granted under this EULA are reserved by FORD MOTOR COMPANY, its affiliates, and third party software and service providers and suppliers. Use of any on-line services which may be accessed through the SOFTWARE may be governed by the respective terms of use relating to such services. If this SOFTWARE contains documentation that is provided only in electronic form, you may print one copy of such electronic documentation.

EXPORT RESTRICTIONS: You acknowledge that the SOFTWARE is subject to U.S. and European Union export jurisdiction. You agree to comply with all applicable international and national laws that apply to the SOFTWARE, including the U.S. Export Administration Regulations, as well as end-user, end-use and destination restrictions issued by U.S. and other governments.

TRADEMARKS: This EULA does not grant you any rights in connection with any trademarks or service marks of FORD MOTOR COMPANY, its affiliates, and third party software and service providers.

PRODUCT SUPPORT: Please refer to FORD MOTOR COMPANY instructions provided in the documentation for the DEVICES product support, such as the vehicle owner guide.

Should you have any questions concerning this EULA, or if you desire to contact FORD MOTOR COMPANY for any other reason, please refer to the address provided in the documentation for the DEVICES.

No Liability for Certain Damages:

EXCEPT AS PROHIBITED BY LAW, FORD MOTOR COMPANY, ANY THIRD PARTY SOFTWARE OR SERVICES SUPPLIERS, AND THEIR AFFILIATES SHALL HAVE NO LIABILITY FOR ANY INDIRECT, SPECIAL, CONSEQUENTIAL OR INCIDENTAL DAMAGES ARISING FROM OR IN CONNECTION WITH THE USE OR PERFORMANCE OF THE SOFTWARE. THIS LIMITATION SHALL APPLY EVEN IF ANY REMEDY FAILS OF ITS ESSENTIAL PURPOSE. THERE ARE NO WARRANTIES OTHER THAN THOSE THAT MAY BE EXPRESSLY PROVIDED FOR YOUR NEW VEHICLE.

SYNC® Automotive Important Safety Information Read and follow instructions:

- Before using your SYNC® system, read and follow all instructions and safety information provided in this end user manual ("Owner Guide".) Not following precautions found in the Owner Guide can lead to an accident or other serious injuries.

Customer Information

General Operation

- **Voice Command Control:** Certain functions within the SYNC® system may be accomplished using voice commands. Using voice commands while driving helps you to operate the system without removing your hands from the wheel or eyes from the road.
- **Prolonged Views of Screen:** Do not access any function requiring a prolonged view of the screen while you are driving. Pull over in a safe and legal manner before attempting to access a function of the system requiring prolonged attention.
- **Volume Setting:** Do not raise the volume excessively. Keep the volume at a level where you can still hear outside traffic and emergency signals while driving. Driving while unable to hear these sounds could cause an accident.
- **Navigation Features:** Any navigation features included in the system are intended to provide turn by turn instructions to get you to a desired destination. Please make certain all persons using this system carefully read and follow instructions and safety information fully.
- **Distraction Hazard:** Any navigation features may require manual (non-verbal) setup. Attempting to perform such set-up or insert data while driving can distract your attention and could cause an accident or other serious injury. Stop the vehicle in a safe and legal manner before attempting these operations.
- **Let Your Judgment Prevail:** Any navigation features are provided only as an aid. Make your driving decisions based on your observations of local conditions and existing traffic regulations. Any such feature is not a substitute for your personal judgment. Any route suggestions made by this system should never replace any local traffic regulations or your personal judgment or knowledge of safe driving practices.
- **Route Safety:** Do not follow the route suggestions if doing so would result in an unsafe or illegal maneuver, if you would be placed in an unsafe situation, or if you would be directed into an area that you consider unsafe. The driver is ultimately responsible for the safe operation of the vehicle and therefore, must evaluate whether it is safe to follow the suggested directions.
- **Potential Map Inaccuracy:** Maps used by this system may be inaccurate because of changes in roads, traffic controls or driving conditions. Always use good judgment and common sense when following the suggested routes.
- **Emergency Services:** Do not rely on any navigation features included in the system to route you to emergency services. Ask local authorities or an emergency services operator for these locations. Not all emergency services such as police, fire stations, hospitals and clinics are likely to be contained in the map database for such navigation features.

Customer Information

Your Responsibilities and Assumptions of Risk

- You agree to each of the following: (a) Any use of the SOFTWARE while driving an automobile or other vehicle in violation of applicable law or otherwise driving in an unsafe manner presents a significant risk of distracted driving and should not be attempted under any circumstances; (b) Use of the SOFTWARE at excessive volume poses a significant risk of hearing damage and should not be attempted under any circumstances; (c) The SOFTWARE may not be compatible with new or different versions of an operating system, third party software, or third party services, and the SOFTWARE may potentially cause a critical failure of an operating system, third party software, or third party service. (d) Any third party service accessed by or third party software used with the SOFTWARE (i) may charge an additional fee for access, (ii) may not work correctly, on an uninterrupted basis, or error free, (iii) may change streaming formats or discontinue operation, (iv) may contain adult, profane or offensive content; and (v) may contain inaccurate, false or misleading traffic, weather, financial or safety information or other content; and (e) Use of the SOFTWARE may cause you to incur additional charges from your wireless service provider (WSP) and any data or minute calculators that may be included in the software program are for reference only, are not warranted in any way and should not be relied upon in anyway.
- When using the SOFTWARE, you agree to be responsible for and assume the entire risk to the items set forth in Section (a) – (e) above.

Disclaimer of Warranty

YOU EXPRESSLY ACKNOWLEDGE AND AGREE THAT USE OF THE DEVICES AND SOFTWARE IS AT YOUR SOLE RISK AND THAT THE ENTIRE RISK AS TO SATISFACTORY QUALITY, PERFORMANCE, COMPATIBILITY, ACCURACY AND EFFORT IS WITH YOU. TO THE MAXIMUM EXTENT PERMITTED BY APPLICABLE LAW, THE SOFTWARE AND ANY THIRD PARTY SOFTWARE OR THIRD-PARTY SERVICES ARE PROVIDED "AS IS" AND "AS AVAILABLE", WITH ALL FAULTS AND WITHOUT WARRANTY OF ANY KIND, AND FORD MOTOR COMPANY HEREBY DISCLAIMS ALL WARRANTIES AND CONDITIONS WITH RESPECT TO THE SOFTWARE, THIRD PARTY SOFTWARE, AND THIRD-PARTY SERVICES, EITHER EXPRESS, IMPLIED OR STATUTORY, INCLUDING, BUT NOT LIMITED TO, THE IMPLIED WARRANTIES AND/OR CONDITIONS OF MERCHANTABILITY, OF SATISFACTORY QUALITY, OF FITNESS FOR AN PARTICULAR PURPOSE, OF ACCURACY, OF QUIET ENJOYMENT, AND NON-INFRINGEMENT OF THIRD-PARTY RIGHTS. FORD MOTOR COMPANY DOES NOT WARRANT (a) AGAINST INTERFERENCE WITH YOUR ENJOYMENT OF THE SOFTWARE, THIRD PARTY SOFTWARE, OR THIRD-PARTY SERVICES, (b) THAT THE SOFTWARE, THIRD PARTY SOFTWARE, OR THIRD-PARTY SERVICES WILL MEET YOUR REQUIREMENTS, (c) THAT THE OPERATION OF THE SOFTWARE, THIRD PARTY SOFTWARE, OR THIRD-PARTY SERVICES WILL BE UNINTERRUPTED OR ERROR-FREE, (d) OR THAT DEFECTS IN THE SOFTWARE, THIRD PARTY SOFTWARE, OR THIRD-PARTY SERVICES WILL BE CORRECTED. NO ORAL OR WRITTEN INFORMATION OR ADVICE GIVEN BY FORD MOTOR COMPANY OR ITS AUTHORIZED REPRESENTATIVE SHALL

Customer Information

CREATE A WARRANTY. SHOULD THE SOFTWARE, THIRD PARTY SOFTWARE, OR THIRD-PARTY SERVICES PROVE DEFECTIVE, YOU ASSUME THE ENTIRE COST OF ALL NECESSARY SERVICING, REPAIR OR CORRECTION. SOME JURISDICTIONS DO NOT ALLOW THE DISCLAIMER OF IMPLIED WARRANTIES OR LIMITATIONS ON APPLICABLE STATUTORY RIGHTS OF A CONSUMER, SO THE ABOVE DISCLAIMER MAY NOT FULLY APPLY TO YOU. THE SOLE WARRANTY PROVIDED BY FORD MOTOR COMPANY SHALL BE FOUND IN THE WARRANTY INFORMATION INCLUDING WITH YOUR OWNER GUIDE. TO THE EXTENT THAT THERE IS ANY CONFLICT BETWEEN THE TERMS OF THIS SECTION AND THE WARRANTY BOOKLET, THE WARRANTY BOOKLET SHALL CONTROL.

Applicable Law, Venue, Jurisdiction

- The laws of the State of Michigan govern this EULA and Your use of the SOFTWARE. Your use of the SOFTWARE may also be subject to other local, state, national, or international laws. Any litigation arising out of or related to this EULA shall be brought and maintained exclusively in a court of the State of Michigan located in Wayne County or in the United States District Court for the Eastern District of Michigan. You hereby consent to submit to the personal jurisdiction of a court in the State of Michigan located in Wayne County and the United States District Court for the Eastern District of Michigan for any dispute arising out of or relating to this EULA.

Binding Arbitration and Class Action Waiver

(a) Application. This Section applies to any dispute EXCEPT IT DOES NOT INCLUDE A DISPUTE RELATING TO COPYRIGHT INFRINGEMENT, OR TO THE ENFORCEMENT OR VALIDITY OF YOUR, FORD MOTOR COMPANY, OR ANY OF FORD MOTOR COMPANY'S LICENSORS' INTELLECTUAL PROPERTY RIGHTS.

Dispute means any dispute, action, or other controversy between You and FORD MOTOR COMPANY, other than the exceptions listed above, concerning the SOFTWARE (including its price) or this EULA, whether in contract, warranty, tort, statute, regulation, ordinance, or any other legal or equitable basis.

(b) Notice of Dispute. In the event of a Dispute, You or FORD MOTOR COMPANY must give the other a "Notice of Dispute", which is a written statement of the name, address, and contact information of the party giving it, the facts giving rise to the dispute, and the relief requested. You and FORD MOTOR COMPANY will attempt to resolve any dispute through informal negotiation within 60 days from the date the Notice of Dispute is sent. After 60 days, You or FORD MOTOR COMPANY may commence arbitration.

(c) Small claims court. You may also litigate any dispute in small claims court in your county of residence or FORD MOTOR COMPANY'S principal place of business, if the dispute meets all requirements to be heard in the small claims court. You may litigate in small claims court whether or not You negotiated informally first.

(d) Binding arbitration. If You and FORD MOTOR COMPANY, do not resolve any dispute by informal negotiation or in small claims court, any other effort to resolve the dispute will be conducted exclusively by binding arbitration. You are giving up

Customer Information

the right to litigate (or participate in as a party or class member) all disputes in court before a judge or jury. Instead, all disputes will be resolved before a neutral arbitrator, whose decision will be final except for a limited right of appeal under the Federal Arbitration Act. Any court with jurisdiction over the parties may enforce the arbitrator's award.

(e) Class action waiver. Any proceedings to resolve or litigate any dispute in any forum will be conducted solely on an individual basis. Neither you nor FORD MOTOR COMPANY, will seek to have any dispute heard as a class action, as a private attorney general action, or in any other proceeding in which any party acts or proposes to act in a representative capacity. No arbitration or proceeding will be combined with another without the prior written consent of all parties to all affected arbitrations or proceedings.

(f) Arbitration procedure. Any arbitration will be conducted by the American Arbitration Association (the "AAA"), under its Commercial Arbitration Rules. If You are an individual and use the SOFTWARE for personal or vehicle use, or if the value of the dispute is \$75,000 or less whether or not You are an individual or how You use the SOFTWARE, the AAA Supplementary Procedures for Consumer-Related Disputes will also apply. To commence arbitration, submit a Commercial Arbitration Rules Demand for Arbitration form to the AAA. You may request a telephonic or in-person hearing by following the AAA rules. In a dispute involving \$10,000 or less, any hearing will be telephonic unless the arbitrator finds good cause to hold an in-person hearing instead. For more information, see adr.org or call 1-800-778-7879. You agree to commence arbitration only in your county of residence or FORD MOTOR COMPANY'S principal place of business. The arbitrator

may award the same damages to you individually as a court could. The arbitrator may award declaratory or injunctive relief only to you individually, and only to the extent required to satisfy your individual claim.

(g) Arbitration fees and incentives.

- I. Disputes involving \$75,000 or less. FORD MOTOR COMPANY will promptly reimburse your filing fees and pay the AAA's and arbitrator's fees and expenses. If you reject FORD MOTOR COMPANY'S last written settlement offer made before the arbitrator was appointed ("last written offer"), your dispute goes all the way to an arbitrator's decision (called an "award"), and the arbitrator awards you more than the last written offer, FORD MOTOR COMPANY will give you three incentives: (1) pay the greater of the award or \$1,000; (2) pay twice your reasonable attorney's fees, if any; and (3) reimburse any expenses (including expert witness fees and costs) that your attorney reasonably accrues for investigating, preparing, and pursuing your claim in arbitration. The arbitrator will determine the amounts.
- ii. Disputes involving more than \$75,000. The AAA rules will govern payment of filing fees and the AAA's and arbitrator's fees and expenses.
- iii. Disputes involving any amount. In any arbitration you commence, FORD MOTOR COMPANY will seek its AAA or arbitrator's fees and expenses, or Your filing fees it reimbursed, only if the arbitrator finds the arbitration frivolous or brought for an improper purpose. In any arbitration FORD MOTOR COMPANY commences, it will pay all

Customer Information

filing, AAA, and arbitrator's fees and expenses. It will not seek its attorney's fees or expenses from you in any arbitration. Fees and expenses are not counted in determining how much a dispute involves.

(h) Claims or disputes must be filed within one year. To the extent permitted by law, any claim or dispute under this EULA to which this Section applies must be filed within one year in small claims court (Section c) or in arbitration (Section d). The one-year period begins when the claim or dispute first could be filed. If such a claim or dispute is not filed within one year, it is permanently barred.

(I) Severability. If the class action waiver (Section e) is found to be illegal or unenforceable as to all or some parts of a dispute, then that portion of Section e will not apply to those parts. Instead, those parts will be severed and proceed in a court of law, with the remaining parts proceeding in arbitration. If any other provision of that portion Section e is found to be illegal or unenforceable, that provision will be severed with the remainder of Section e remaining in full force and effect.

Telenav Software End User License Agreement

Please read these terms and conditions carefully before you use the TeleNav Software. Your use of the TeleNav Software indicates that you accept these terms and conditions. If you do not accept these terms and conditions, do not break the seal of the package, launch, or otherwise use the TeleNav Software. TeleNav may revise this Agreement and the privacy policy at any time, with or without notice to you. You agree to visit <http://www.telenav.com> from time to time to review the then current version of this Agreement and of the privacy policy.

1. Safe and Lawful Use

You acknowledge that devoting attention to the TeleNav Software may pose a risk of injury or death to you and others in situations that otherwise require your undivided attention, and you therefore agree to comply with the following when using the TeleNav Software:

- (a) observe all traffic laws and otherwise drive safely;
- (b) use your own personal judgment while driving. If you feel that a route suggested by the TeleNav Software instructs you to perform an unsafe or illegal maneuver, places you in an unsafe situation, or directs you into an area that you consider to be unsafe, do not follow such instructions;
- (c) do not input destinations, or otherwise manipulate the TeleNav Software, unless your vehicle is stationary and parked;
- (d) do not use the TeleNav Software for any illegal, unauthorized, unintended, unsafe, hazardous, or unlawful purposes, or in any manner inconsistent with this Agreement;
- (e) arrange all GPS and wireless devices and cables necessary for use of the TeleNav Software in a secure manner in your vehicle so that they will not interfere with your driving and will not prevent the operation of any safety device (such as an airbag).

You agree to indemnify and hold TeleNav harmless against all claims resulting from any dangerous or otherwise inappropriate use of the TeleNav Software in any moving vehicle, including as a result of your failure to comply with the directions above.

Customer Information

2. Account Information

You agree: (a) when registering the TeleNav Software, to provide TeleNav with true, accurate, current, and complete information about yourself, and (b) to inform TeleNav promptly of any changes to such information, and to keep it true, accurate, current and complete.

3. Software License

- Subject to your compliance with the terms of this Agreement, TeleNav hereby grants to you a personal, non-exclusive, non-transferable license (except as expressly permitted below in connection with your permanent transfer of the TeleNav Software license), without the right to sublicense, to use the TeleNav Software (in object code form only) in order to access and use the TeleNav Software. This license shall terminate upon any termination or expiration of this Agreement. You agree that you will use the TeleNav Software only for your personal business or leisure purposes, and not to provide commercial navigation services to other parties.

3.1 License Limitations

- **(a)** reverse engineer, decompile, disassemble, translate, modify, alter or otherwise change the TeleNav Software or any part thereof; **(b)** attempt to derive the source code, audio library or structure of the TeleNav Software without the prior express written consent of TeleNav; **(c)** remove from the TeleNav Software, or alter, any of TeleNav's or its suppliers' trademarks, trade names, logos, patent or copyright notices, or other notices or markings; **(d)**

distribute, sublicense or otherwise transfer the TeleNav Software to others, except as part of your permanent transfer of the TeleNav Software; or **(e)** use the TeleNav Software in any manner that

- i. infringes the intellectual property or proprietary rights, rights of publicity or privacy or other rights of any party,
- ii. violates any law, statute, ordinance or regulation, including but not limited to laws and regulations related to spamming, privacy, consumer and child protection, obscenity or defamation, or
- iii. is harmful, threatening, abusive, harassing, tortuous, defamatory, vulgar, obscene, libelous, or otherwise objectionable; and (f) lease, rent out, or otherwise permit unauthorized access by third parties to the TeleNav Software without advanced written permission of TeleNav.

4. Disclaimers

- To the fullest extent permissible pursuant to applicable law, in no event will TeleNav, its licensors and suppliers, or agents or employees of any of the foregoing, be liable for any decision made or action taken by you or anyone else in reliance on the information provided by the TeleNav Software. TeleNav also does not warrant the accuracy of the map or other data used for the TeleNav Software. Such data may not always reflect reality due to, among other things, road closures, construction, weather, new roads and other changing conditions. You are responsible for the entire risk arising out of your use of the TeleNav Software. For example but without limitation, you agree not to rely on the TeleNav Software for critical navigation in areas where the well-being or survival of you or others

Customer Information

is dependent on the accuracy of navigation, as the maps or functionality of the TeleNav Software are not intended to support such high risk applications, especially in more remote geographical areas.

- TELENAV EXPRESSLY DISCLAIMS AND EXCLUDES ALL WARRANTIES IN CONNECTION WITH THE TELENAV SOFTWARE, WHETHER STATUTORY, EXPRESS OR IMPLIED, INCLUDING ALL WARRANTIES WHICH MAY ARISE FROM COURSE OF DEALING, CUSTOM OR TRADE AND INCLUDING, BUT NOT LIMITED TO, THE IMPLIED WARRANTIES OF MERCHANTABILITY, FITNESS FOR A PARTICULAR PURPOSE AND NON-INFRINGEMENT OF THIRD PARTY RIGHTS WITH RESPECT TO THE TELENAV SOFTWARE.
- Certain jurisdictions do not permit the disclaimer of certain warranties, so this limitation may not apply to you.

5. Limitation of Liability

- TO THE EXTENT PERMITTED UNDER APPLICABLE LAW, UNDER NO CIRCUMSTANCES SHALL TELENAV OR ITS LICENSORS AND SUPPLIERS BE LIABLE TO YOU OR TO ANY THIRD PARTY FOR ANY INDIRECT, INCIDENTAL, CONSEQUENTIAL, SPECIAL OR EXEMPLARY DAMAGES (INCLUDING IN EACH CASE, BUT NOT LIMITED TO, DAMAGES FOR THE INABILITY TO USE THE EQUIPMENT OR ACCESS DATA, LOSS OF DATA, LOSS OF BUSINESS, LOSS OF PROFITS, BUSINESS INTERRUPTION OR THE LIKE) ARISING OUT OF THE USE OF OR INABILITY TO USE THE TELENAV SOFTWARE, EVEN IF TELENAV HAS BEEN ADVISED OF THE POSSIBILITY OF SUCH DAMAGES. NOTWITHSTANDING ANY DAMAGES THAT YOU MIGHT INCUR FOR ANY

REASON WHATSOEVER (INCLUDING, WITHOUT LIMITATION, ALL DAMAGES REFERENCED HEREIN AND ALL DIRECT OR GENERAL DAMAGES IN CONTRACT, TORT (INCLUDING NEGLIGENCE) OR OTHERWISE), THE ENTIRE LIABILITY OF TELENAV AND OF ALL OF TELENAV'S SUPPLIERS SHALL BE LIMITED TO THE AMOUNT ACTUALLY PAID BY YOU FOR THE TELENAV SOFTWARE. SOME STATES AND/OR JURISDICTIONS DO NOT ALLOW THE EXCLUSION OR LIMITATION OF INCIDENTAL OR CONSEQUENTIAL DAMAGES, SO THE ABOVE LIMITATIONS OR EXCLUSIONS MAY NOT APPLY TO YOU.

6. Arbitration and Governing Law

- You agree that any dispute, claim or controversy arising out of or relating to this Agreement or the TeleNav Software shall be settled by independent arbitration involving a neutral arbitrator and administered by the American Arbitration Association in the County of Santa Clara, California. The arbitrator shall apply the Commercial Arbitration Rules of the American Arbitration Association, and the judgment upon the award rendered by the arbitrator may be entered by any court having jurisdiction. Note that there is no judge or jury in an arbitration proceeding and the decision of the arbitrator shall be binding upon both parties. You expressly agree to waive your right to a jury trial. This Agreement and performance hereunder will be governed by and construed in accordance with the laws of the State of California, without giving effect to its conflict of law provisions. To the extent judicial action is necessary in connection with the binding arbitration, both TeleNav and you agree to submit

Customer Information

to the exclusive jurisdiction of the courts of the County of Santa Clara, California. The United Nations Convention on Contracts for the International Sale of Goods shall not apply.

7. Assignment

- You may not resell, assign, or transfer this Agreement or any of your rights or obligations, except in totality, in connection with your permanent transfer of the TeleNav Software, and expressly conditioned upon the new user of the TeleNav Software agreeing to be bound by the terms and conditions of this Agreement. Any such sale, assignment or transfer that is not expressly permitted under this paragraph will result in immediate termination of this Agreement, without liability to TeleNav, in which case you and all other parties shall immediately cease all use of the TeleNav Software. Notwithstanding the foregoing, TeleNav may assign this Agreement to any other party at any time without notice, provided the assignee remains bound by this Agreement.

8. Miscellaneous

8.1

This Agreement constitutes the entire agreement between TeleNav and you with respect to the subject matter hereof.

8.2

Except for the limited licenses expressly granted in this Agreement, TeleNav retains all right, title and interest in and to the TeleNav Software, including without limitation all related intellectual property rights. No licenses or other rights which are not expressly granted in this Agreement are intended to, or shall be, granted or

conferred by implication, statute, inducement, estoppel or otherwise, and TeleNav and its suppliers and licensors hereby reserve all of their respective rights other than the licenses explicitly granted in this Agreement.

8.3

By using the TeleNav Software, you consent to receive from TeleNav all communications, including notices, agreements, legally required disclosures or other information in connection with the TeleNav Software (collectively, "Notices") electronically. TeleNav may provide such Notices by posting them on TeleNav's Website or by downloading such Notices to your wireless device. If you desire to withdraw your consent to receive Notices electronically, you must discontinue your use of the TeleNav Software.

8.4

TeleNav's or your failure to require performance of any provision shall not affect that party's right to require performance at any time thereafter, nor shall a waiver of any breach or default of this Agreement constitute a waiver of any subsequent breach or default or a waiver of the provision itself.

8.5

If any provision herein is held unenforceable, then such provision will be modified to reflect the intention of the parties, and the remaining provisions of this Agreement will remain in full force and effect.

Customer Information

8.6

The headings in this Agreement are for convenience of reference only, will not be deemed to be a part of this Agreement, and will not be referred to in connection with the construction or interpretation of this Agreement. As used in this Agreement, the words "include" and "including" and variations thereof, will not be deemed to be terms of limitation, but rather will be deemed to be followed by the words "without limitation".

9. Other Vendors Terms and Conditions

- The Telenav Software utilizes map and other data licensed to Telenav by third party vendors for the benefit of you and other end users. This Agreement includes end-user terms applicable to these companies (included at the end of this Agreement), and thus your use of the Telenav Software is also subject to such terms. You agree to comply with the following additional terms and conditions, which are applicable to Telenav's third party vendor licensors.

9.1 End User Terms Required by HERE North America, LLC

The data ("Data") is provided for your personal, internal use only and not for resale. It is protected by copyright, and is subject to the following terms and conditions which are agreed to by you, on the one hand, and Telenav ("Telenav") and its licensors (including their licensors and suppliers) on the other hand.

© 2013 HERE. All rights reserved.

The Data for areas of Canada includes information taken with permission from Canadian authorities, including: © Her Majesty the Queen in Right of Canada, © Queen's Printer for Ontario, © Canada Post Corporation, GeoBase®, © Department of Natural Resources Canada.

HERE holds a non-exclusive license from the United States Postal Service® to publish and sell ZIP+4® information.

©United States Postal Service® 2014. Prices are not established, controlled or approved by the United States Postal Service®. The following trademarks and registrations are owned by the USPS: United States Postal Service, USPS, and ZIP+4

The Data for Mexico includes certain data from Instituto Nacional de Estadística y Geografía.

9.2 End User Terms Required by NAV2 (Shanghai) Co., Ltd

The data ("Data") is provided for your personal, internal use only and not for resale. It is protected by copyright, and is subject to the following terms and conditions which are agreed to by you, on the one hand, and NAV2 (Shanghai) Co., Ltd ("NAV2") and its licensors (including their licensors and suppliers) on the other hand. 20xx. All rights reserved

Terms and Conditions

Permitted Use. You agree to use this Data together with the Telenav Software solely for the internal business and personal purposes for which you were licensed, and not for service bureau, time-sharing or other similar purposes. Accordingly, but subject to the restrictions set forth in the following paragraphs, you agree not to otherwise reproduce, copy, modify, decompile, disassemble, create any derivative works of, or reverse engineer any portion of this Data, and may not transfer or distribute it in any form, for any purpose, except to the extent permitted by mandatory laws.

Customer Information

Restrictions. Except where you have been specifically licensed to do so by Telenav, and without limiting the preceding paragraph, you may not use this Data (a) with any products, systems, or applications installed or otherwise connected to or in communication with vehicles, capable of vehicle navigation, positioning, dispatch, real time route guidance, fleet management or similar applications; or (b) with or in communication with any positioning devices or any mobile or wireless-connected electronic or computer devices, including without limitation cellular phones, palmtop and handheld computers, pagers, and personal digital assistants or PDAs.

Warning. The Data may contain inaccurate or incomplete information due to the passage of time, changing circumstances, sources used and the nature of collecting comprehensive geographic data, any of which may lead to incorrect results.

No Warranty. This Data is provided to you "as is," and you agree to use it at your own risk. Telenav and its licensors (and their licensors and suppliers) make no guarantees, representations or warranties of any kind, express or implied, arising by law or otherwise, including but not limited to, content, quality, accuracy, completeness, effectiveness, reliability, fitness for a particular purpose, usefulness, use or results to be obtained from this Data, or that the Data or server will be uninterrupted or error-free.

Disclaimer of Warranty: TELENAV AND ITS LICENSORS (INCLUDING THEIR LICENSORS AND SUPPLIERS) DISCLAIM ANY WARRANTIES, EXPRESS OR IMPLIED, OF QUALITY, PERFORMANCE, MERCHANTABILITY, FITNESS FOR A

PARTICULAR PURPOSE OR NON-INFRINGEMENT. Some States, Territories and Countries do not allow certain warranty exclusions, so to that extent the above exclusion may not apply to you.

Disclaimer of Liability: TELENAV AND ITS LICENSORS (INCLUDING THEIR LICENSORS AND SUPPLIERS) SHALL NOT BE LIABLE TO YOU: IN RESPECT OF ANY CLAIM, DEMAND OR ACTION, IRRESPECTIVE OF THE NATURE OF THE CAUSE OF THE CLAIM, DEMAND OR ACTION ALLEGING ANY LOSS, INJURY OR DAMAGES, DIRECT OR INDIRECT, WHICH MAY RESULT FROM THE USE OR POSSESSION OF THE INFORMATION; OR FOR ANY LOSS OF PROFIT, REVENUE, CONTRACTS OR SAVINGS, OR ANY OTHER DIRECT, INDIRECT, INCIDENTAL, SPECIAL OR CONSEQUENTIAL DAMAGES ARISING OUT OF YOUR USE OF OR INABILITY TO USE THIS INFORMATION, ANY DEFECT IN THE INFORMATION, OR THE BREACH OF THESE TERMS OR CONDITIONS, WHETHER IN AN ACTION IN CONTRACT OR TORT OR BASED ON A WARRANTY, EVEN IF TELENAV OR ITS LICENSORS HAVE BEEN ADVISED OF THE POSSIBILITY OF SUCH DAMAGES. Some States, Territories and Countries do not allow certain liability exclusions or damages limitations, so to that extent the above may not apply to you.

Export Control. You shall not export from anywhere any part of the Data or any direct product thereof except in compliance with, and with all licenses and approvals required under, applicable export laws, rules and regulations, including but not limited to the laws, rules and regulations administered by the Office of Foreign Assets Control of the U.S. Department of Commerce and the Bureau of Industry and Security of the U.S. Department of Commerce. To the extent that any such

Customer Information

export laws, rules or regulations prohibit HERE from complying with any of its obligations hereunder to deliver or distribute Data, such failure shall be excused and shall not constitute a breach of this Agreement.

Entire Agreement. These terms and conditions constitute the entire agreement between Telenav (and its licensors, including their licensors and suppliers) and you pertaining to the subject matter hereof, and supersedes in their entirety any and all written or oral agreements previously existing between us with respect to such subject matter.

Governing Law. The above terms and conditions shall be governed by the laws of the State of Illinois [insert "Netherlands" where European HERE Data is used], without giving effect to (i) its conflict of laws provisions, or (ii) the United Nations Convention for Contracts for the International Sale of Goods, which is explicitly excluded. You agree to submit to the jurisdiction of the State of Illinois [insert "The Netherlands" where European HERE Data is used] for any and all disputes, claims and actions arising from or in connection with the Data provided to you hereunder.

Government End Users. If the Data is being acquired by or on behalf of the United States government or any other entity seeking or applying rights similar to those customarily claimed by the United States government, this Data is a "commercial item" as that term is defined at 48 C.F.R. ("FAR") 2.101, is licensed in accordance with these End-User Terms, and each copy of Data delivered or otherwise furnished shall be marked and embedded as appropriate with the following "Notice of Use," and shall be treated in accordance with such Notice:

NOTICE OF USE
CONTRACTOR (MANUFACTURER/SUPPLIER) NAME: HERE
CONTRACTOR (MANUFACTURER/SUPPLIER) ADDRESS: c/o Nokia, 425 West Randolph Street, Chicago, Illinois 60606
This Data is a commercial item as defined in FAR 2.101 and is subject to these End-User Terms under which this Data was provided.
© 1987 – 2014 HERE – All rights reserved.

If the Contracting Officer, federal government agency, or any federal official refuses to use the legend provided herein, the Contracting Officer, federal government agency, or any federal official must notify HERE prior to seeking additional or alternative rights in the Data.

I. US/Canada Territory

A. United States Data. The End-User Terms for any Application containing Data for the United States shall contain the following notices:

"HERE holds a non-exclusive license from the United States Postal Service® to publish and sell ZIP+4® information."

"©United States Postal Service® 20XX. Prices are not established, controlled or approved by the United States Postal Service®. The following trademarks and registrations are owned by the USPS: United States Postal Service, USPS, and ZIP+4."

Customer Information

B. Canada Data. The following provisions apply to the Data for Canada, which may include or reflect data from third party licensors (“Third Party Data”), including Her Majesty the Queen in Right of Canada (“Her Majesty”), Canada Post Corporation (“Canada Post”) and the Department of Natural Resources of Canada (“NRCan”):

1. Disclaimer and Limitation: Client agrees that its use of the Third Party Data is subject to the following provisions:

a. Disclaimer: The Third Party Data is licensed on an “as is” basis. The licensors of such data, including Her Majesty, Canada Post and NRCan, make no guarantees, representations or warranties respecting such data, either express or implied, arising by law or otherwise, including but not limited to, effectiveness, completeness, accuracy or fitness for a particular purpose.

b. Limitation on Liability: The Third Party Data licensors, including Her Majesty, Canada Post and NRCan, shall not be liable: (i) in respect of any claim, demand or action, irrespective of the nature of the cause of the claim, demand or action alleging any loss, injury or damages, direct or indirect, which may result from the use or possession of such Data; or (ii) in any way for loss of revenues or contracts, or any other consequential loss of any kind resulting from any defect in the Data.

2. Copyright Notice: In connection with each copy of all or any portion of the Data for the Territory of Canada, Client shall affix in a conspicuous manner the following copyright notice on at least one of: (i) the label for the storage media of the copy; (ii) the packaging for the copy; or (iii) other materials packaged with the copy, such as user manuals or end user license agreements: “This data includes information taken with permission from Canadian authorities, including © Her Majesty the Queen in Right of Canada, © Queen’s Printer for Ontario, © Canada Post Corporation, GeoBase®, © The Department of Natural Resources Canada. All rights reserved.”

3. End-User Terms: Except as otherwise agreed by the parties, in connection with the provision of any portion of the Data for the Territory of Canada to End-Users as may be authorized under the Agreement, Client shall provide such End-Users, in a reasonably conspicuous manner, with terms (set forth with other end user terms required to be provided under the Agreement, or as otherwise may be provided, by Client) which shall include the following provisions on behalf of the Third Party Data licensors, including Her Majesty, Canada Post and NRCan:

The Data may include or reflect data of licensors, including Her Majesty the Queen in the Right of Canada (“Her Majesty”), Canada Post Corporation (“Canada Post”) and the Department of Natural Resources Canada (“NRCan”). Such data is licensed on an “as is” basis. The licensors, including Her Majesty, Canada Post and NRCan, make no guarantees, representations or warranties respecting such data,

Customer Information

either express or implied, arising by law or otherwise, including but not limited to, effectiveness, completeness, accuracy or fitness for a particular purpose. The licensors, including Her Majesty, Canada Post and NRCan, shall not be liable in respect of any claim, demand or action, irrespective of the nature of the cause of the claim, demand or action alleging any loss, injury or damages, direct or indirect, which may result from the use or possession of the data or the Data. The licensors, including Her Majesty, Canada Post and NRCan, shall not be liable in any way for loss of revenues or contracts, or any other consequential loss of any kind resulting from any defect in the data or the Data.

End User shall indemnify and save harmless the licensors, including Her Majesty, Canada Post and NRCan, and their officers, employees and agents from and against any claim, demand or action, irrespective of the nature of the cause of the claim, demand or action, alleging loss, costs, expenses, damages or injuries (including injuries resulting in death) arising out of the use or possession of the data or the Data.

4. Additional Provisions: The terms contained in this Section are in addition to all of the rights and obligations of the parties under the Agreement. To the extent that any of the provisions of this Section are inconsistent with, or conflict with, any other provisions of the Agreement, the provisions of this Section shall prevail.

II. Mexico. The following provision applies to the Data for Mexico, which includes certain data from the Instituto Nacional de Estadística y Geografía (“INEGI”):

A. Any and all copies of the Data and/or packaging containing Data for Mexico shall contain the following notice: “Fuente: INEGI (Instituto Nacional de Estadística y Geografía)”

III. Latin America Territory

A. Third Party Notices. Any and all copies of the Data and/or packaging relating thereto shall include the respective Third Party Notices set forth below and used as described below corresponding to the Territory (or portion thereof) included in such copy:

Territory	Notice
Argentina	IGN “INSTITUTO GEOGRAFICO NACIONAL ARGENTINO”
Ecuador	“INSTITUTO GEOGRAFICO MILITAR DEL ECUADOR AUTORIZACION N° IGM-2011-01- PCO-01 DEL 25 DE ENERO DE 2011” “source: © IGN 2009 - BD TOPO ®”
Guadeloupe, French Guiana and Martinique Mexico	“Fuente: INEGI (Instituto Nacional de Estadística y Geografía)”

IV. Middle East Territory

Customer Information

A. Third Party Notices. Any and all copies of the Data and/or packaging relating thereto shall include the respective Third Party Notices set forth below and used as described below corresponding to the Territory (or portion thereof) included in such copy:

Country Notice

Jordan “© Royal Jordanian Geographic Centre”. The foregoing notice requirement for Jordan Data is a material term of the Agreement. If Client or any of its permitted sublicensees (if any) fail to meet such requirement, HERE shall have the right to terminate Client’s license with respect to the Jordan Data.

B. Jordan Data. Client and its permitted sublicensees (if any) are restricted from licensing and/or otherwise distributing HERE’s database for the country of Jordan (“Jordan Data”) for use in Enterprise Applications to (i) non-Jordanian entities for use of the Jordan Data solely in Jordan or (ii) Jordan-based customers. In addition, Client, its permitted sublicensees (if any) and End-Users are restricted from using the Jordan Data in Enterprise Applications if such party is (i) a non-Jordanian entity using the Jordan Data solely in Jordan or (ii) a Jordan-based customer. For purposes of the foregoing, “Enterprise Applications” shall mean Geomarketing applications, GIS applications, mobile business asset management applications, call center applications, telematics applications, public organization Internet applications or for providing geocoding services.

V. Europe Territory

A. Use of Certain Traffic Codes in Europe

1. General Restrictions Applicable to Traffic Codes. Client acknowledges and agrees that in certain countries of the Europe Territory, Client will need to obtain rights directly from third party RDS-TMC code providers to receive and use the Traffic Codes in the Data and to deliver to End-Users Transactions in any way derived from or based on such Traffic Codes. For such countries, HERE shall deliver the Data incorporating Traffic Codes to Client only after receiving certification from Client of its having obtained such rights.

2. Display of Third Party Rights Legends for Belgium. Client shall, for each Transaction that uses Traffic Codes for Belgium, provide the following notice to the End-User: “Traffic Codes for Belgium are provided by the Ministerie van de Vlaamse Gemeenschap and the Ministère de l’Équipement et des Transports.”

B. Paper Maps. With respect to any license granted to Client relating to making, selling or distributing paper maps (i.e., a map fixed on a paper or paper-like medium): (a) such license with respect to Data for the Territory of Great Britain is conditioned on Client’s entering into and complying with a separate written agreement with the Ordnance Survey (“OS”) to create and sell paper maps, Client’s paying to the OS any and all applicable paper map royalties, and Client’s complying with the OS copyright notice requirements; (b) such license for selling or otherwise distributing for charge with respect to Data for the Territory of Czech Republic

Customer Information

is conditioned on Client's obtaining prior written consent from Kartografie a.s.; (c) such license for selling or distributing with respect to Data for the Territory of Switzerland is conditioned on Client's obtaining a permit from Bundesamt für Landestopografie of Switzerland; (d) Client is restricted from using Data for the Territory of France to create paper maps with a scale between 1:5,000 and 1:250,000; and (e) Client is restricted from using any Data to create, sell or distribute paper maps that are the same or substantially similar, in terms of data content and specific use of color, symbols and scale, to paper maps published by the European national mapping agencies, including without limitation, Landervermessungämter of Germany, Topografische Dienst of the Netherlands, Nationaal Geografisch Instituut of Belgium, Bundesamt für Landestopografie of Switzerland, Bundesamt für Eich-und Vermessungswesen of Austria, and the National Land Survey of Sweden.

C. OS Enforcement. Without limiting Section IV(B) above, with respect to Data for the Territory of Great Britain, Client acknowledges and agrees that the Ordnance Survey ("OS") may bring a direct action against Client to enforce compliance with the OS copyright notice (see Section IV(D) below) and paper map requirements (see Section IV(B) above) contained in this Agreement.

D. Third Party Notices. Any and all copies of the Data and/or packaging relating thereto shall include the respective Third Party Notices set forth below and used as described below corresponding to the Territory (or portion thereof) included in such copy:

Country(ies) Notice

Austria	"© Bundesamt für Eich- und Vermessungswesen"
Croatia Cyprus, Estonia, Latvia, Lithuania, Moldova, Poland, Slovenia and/or Ukraine	"© EuroGeographics"
France	"source: © IGN 2009 – BD TOPO ®"
Germany	"Die Grundlagendaten wurden mit Genehmigung der zuständigen Behörden entnommen"
Great Britain	"Contains Ordnance Survey data © Crown copyright and database right 2010 Contains Royal Mail data © Royal Mail copyright and database right 2010"
Greece	"Copyright Geomatics Ltd."
Hungary	"Copyright © 2003; Top-Map Ltd."
Italy	"La Banca Dati Italiana è stata prodotta usando quale riferimento anche cartografia numerica ed al tratto prodotta e fornita dalla Regione Toscana."
Norway	"Copyright © 2000; Norwegian Mapping Authority"
Portugal	"Source: IgeoE – Portugal"

Customer Information

Spain “Información geográfica propiedad del CNIG”

Sweden “Based upon electronic data © National Land Survey Sweden.”

Switzerland “Topografische Grundlage: © Bundesamt für Landestopographie.

E. Respective Country Distribution. Client acknowledges that HERE has not received approvals to distribute map data for the following countries in such respective countries: Albania, Belarus, Kyrgyzstan, Moldova and Uzbekistan. HERE may update such list from time to time. The license rights granted to Client under this TL with respect to the Data for such countries are contingent upon Client’s compliance with all applicable laws and regulations, including, without limitation, any required licenses or approvals to distribute the Application incorporating such Data in such respective countries.

VI. Australia Territory

A. Third Party Notices. Any and all copies of the Data and/or packaging relating thereto shall include the respective Third Party Notices set forth below and used as described below corresponding to the Territory (or portion thereof) included in such copy:

Copyright. Based on data provided under license from PSMA Australia Limited (www.pasma.com.au).

Product incorporates data which is © 20XX Telstra Corporation Limited, GM Holden Limited, Intelomatics Australia Pty Ltd and Continental Pty Ltd.

B. Third Party Notices for Australia. In addition to the foregoing, the End-User Terms for any Application containing RDS-TMC Traffic Codes for Australia shall contain the following notice: “Product incorporates traffic location codes which is © 20XX Telstra Corporation Limited and its licensors.”

AT&T Vehicle Network Carrier Telematics Disclosure

END USER FOR PURPOSES OF THIS SECTION MEANS YOU AND YOUR HEIRS, EXECUTORS, LEGAL PERSONAL REPRESENTATIVES AND PERMITTED ASSIGNS. FOR PURPOSES OF THIS SECTION “UNDERLYING WIRELESS SERVICE CARRIER” INCLUDES ITS AFFILIATES AND CONTRACTORS AND THEIR RESPECTIVE OFFICERS, DIRECTORS, EMPLOYEES, SUCCESSORS AND ASSIGNS. END USER HAS NO CONTRACTUAL RELATIONSHIP WITH THE UNDERLYING WIRELESS SERVICE CARRIER AND END USER IS NOT A THIRD PARTY BENEFICIARY OF ANY AGREEMENT BETWEEN FORD AND UNDERLYING CARRIER. END USER UNDERSTANDS AND AGREES THAT THE UNDERLYING CARRIER HAS NO LEGAL, EQUITABLE, OR OTHER LIABILITY OF ANY KIND TO END USER. IN ANY EVENT, REGARDLESS OF THE FORM OF THE ACTION, WHETHER FOR BREACH OF CONTRACT, WARRANTY, NEGLIGENCE, STRICT LIABILITY IN TORT OR OTHERWISE, END USER’S EXCLUSIVE REMEDY FOR CLAIMS ARISING IN ANY WAY IN CONNECTION WITH THIS AGREEMENT, FOR ANY CAUSE WHATSOEVER, INCLUDING BUT NOT LIMITED TO ANY FAILURE OR

Customer Information

DISRUPTION OF SERVICE PROVIDED HEREUNDER, IS LIMITED TO PAYMENT OF DAMAGES IN AN AMOUNT NOT TO EXCEED THE AMOUNT PAID BY END USER FOR THE SERVICES DURING THE TWO-MONTH PERIOD PRECEDING THE DATE THE CLAIM AROSE.

(ii) END USER AGREES TO INDEMNIFY AND HOLD HARMLESS THE UNDERLYING WIRELESS SERVICE CARRIER AND ITS OFFICERS, EMPLOYEES, AND AGENTS AGAINST ANY AND ALL CLAIMS, INCLUDING WITHOUT LIMITATION CLAIMS FOR LIBEL, SLANDER, OR ANY PROPERTY DAMAGE, PERSONAL INJURY OR DEATH, ARISING IN ANY WAY, DIRECTLY OR INDIRECTLY, IN CONNECTION WITH THIS AGREEMENT OR THE USE, FAILURE TO USE, OR INABILITY TO USE THE DEVICE EXCEPT WHERE THE CLAIMS RESULT FROM THE UNDERLYING CARRIER'S GROSS NEGLIGENCE OR WILLFUL MISCONDUCT. THIS INDEMNITY WILL SURVIVE THE TERMINATION OF THE AGREEMENT.

(iii) END USER HAS NO PROPERTY RIGHT IN ANY NUMBER ASSIGNED TO THE DEVICE.

(iv) END USER UNDERSTANDS THAT FORD AND THE UNDERLYING CARRIER CANNOT GUARANTY THE SECURITY OF WIRELESS TRANSMISSIONS, AND WILL NOT BE LIABLE FOR ANY LACK OF SECURITY RELATING TO THE USE OF THE SERVICES

THE SERVICE IS FOR [END USER'S] USE ONLY AND END USER MAY NOT RESELL THE SERVICE TO ANY OTHER PARTY END USER UNDERSTANDS THAT THE UNDERLYING CARRIER DOES NOT GUARANTEE ANY END USER UNINTERRUPTED SERVICE OR COVERAGE. THE UNDERLYING CARRIER DOES NOT WARRANT THAT END USERS CAN OR WILL BE LOCATED USING THE SERVICE. THE UNDERLYING CARRIER

MAKES NO WARRANTY, EXPRESS OR IMPLIED, OF MERCHANTABILITY OR FITNESS FOR A PARTICULAR PURPOSE, SUITABILITY, OR PERFORMANCE REGARDING ANY SERVICES OR GOODS, AND IN NO EVENT SHALL AT&T BE LIABLE, WHETHER OR NOT DUE TO ITS OWN NEGLIGENCE, FOR ANY: (A) ACT OR OMISSION OF A THIRD PARTY; (B) MISTAKES, OMISSIONS, INTERRUPTIONS, ERRORS, FAILURES TO TRANSMIT, DELAYS, OR DEFECTS IN THE SERVICE PROVIDED BY OR THROUGH THE UNDERLYING CARRIER; (C) DAMAGE OR INJURY CAUSED BY SUSPENSION OR TERMINATION BY THE UNDERLYING CARRIER; OR (D) DAMAGE OR INJURY CAUSED BY A FAILURE OR DELAY IN CONNECTING A CALL TO ANY ENTITY, INCLUDING 911 OR ANY OTHER EMERGENCY SERVICE. TO THE FULL EXTENT ALLOWED BY LAW, THE END USER RELEASES, INDEMNIFIES AND HOLDS THE UNDERLYING CARRIER HARMLESS FROM AND AGAINST ANY AND ALL CLAIMS OF ANY PERSON OR ENTITY FOR DAMAGES OF ANY NATURE ARISING IN ANY WAY FROM OR RELATING TO, DIRECTLY OR INDIRECTLY, SERVICES PROVIDED BY THE UNDERLYING CARRIER OR ANY PERSON'S USE THEREOF, INCLUDING CLAIMS ARISING IN WHOLE OR IN PART FROM THE ALLEGED NEGLIGENCE OF THE UNDERLYING CARRIER.

VII. China Territory

Personal Use Only

You agree to use this Data together with [insert name of Client Application] for the solely personal, non-commercial purposes for which you were licensed, and not for service bureau, time-sharing or other similar purposes. Accordingly, but subject to the restrictions set forth in the following paragraphs, you may copy this Data only as necessary for your personal use to (i)

Customer Information

view it, and (ii) save it, provided that you do not remove any copyright notices that appear and do not modify the Data in any way. You agree not to otherwise reproduce, copy, modify, decompile, disassemble or reverse engineer any portion of this Data, and may not transfer or distribute it in any form, for any purpose, except to the extent permitted by mandatory laws.

Restrictions

Except where you have been specifically licensed to do so by NAV2, and without limiting the preceding paragraph, you may not (a) use this Data with any products, systems, or applications installed or otherwise connected to or in communication with vehicles, capable of vehicle navigation, positioning, dispatch, real time route guidance, fleet management or similar applications; or (b) with or in communication with any positioning devices or any mobile or wireless-connected electronic or computer devices, including without limitation cellular phones, palmtop and handheld computers, pagers, and personal digital assistants or PDAs. You agree to cease using this Data if you fail to comply with these terms and conditions.

Limited Warranty

NAV2 warrants that (a) the Data will perform substantially in accordance with the accompanying written materials for a period of ninety (90) days from the date of receipt, and (b) any support services provided by NAV2 shall be substantially as described in applicable written materials provided to you by NAV2, and NAV2's support engineers will make commercially reasonable efforts to solve any problem issues.

Customer Remedies

NAV2 and its suppliers' entire liability and your exclusive remedy shall be, at NAV2's sole discretion, either (a) return of the price paid, if any, or (b) repair or replacement of the Data that do not meet NAV2's Limited Warranty and that are returned to NAV2 with a copy of your receipt. This Limited Warranty is void if failure of the Data has resulted from accident, abuse, or misapplication. Any replacement Data will be warranted for the remainder of the original warranty period or thirty (30) days, whichever is longer. Neither these remedies nor any product support services offered by NAV2 are available without proof of purchase from an authorized international source.

No Other Warranty:

EXCEPT FOR THE LIMITED WARRANTY SET FORTH ABOVE AND TO THE EXTENT PERMITTED BY APPLICABLE LAW, NAV2 AND ITS LICENSORS (INCLUDING THEIR LICENSORS AND SUPPLIERS) DISCLAIM ANY WARRANTIES, EXPRESS OR IMPLIED, OF QUALITY, PERFORMANCE, MERCHANTABILITY, FITNESS FOR A PARTICULAR PURPOSE, OWNERSHIP OR NON-INFRINGEMENT. Certain warranty exclusions may not be permitted under applicable law, so to that extent the above exclusion may not apply to you.

Limited Liability:

TO THE EXTENT PERMITTED BY APPLICABLE LAW, NAV2 AND ITS LICENSORS (INCLUDING THEIR LICENSORS AND SUPPLIERS) SHALL NOT BE LIABLE TO YOU: IN RESPECT OF ANY CLAIM, DEMAND OR ACTION, IRRESPECTIVE OF THE NATURE OF THE CAUSE OF THE CLAIM, DEMAND OR ACTION ALLEGING ANY LOSS, INJURY OR DAMAGES, DIRECT OR INDIRECT, WHICH MAY RESULT FROM THE USE OR POSSESSION OF THE INFORMATION; OR

Customer Information

FOR ANY LOSS OF PROFIT, REVENUE, CONTRACTS OR SAVINGS, OR ANY OTHER DIRECT, INDIRECT, INCIDENTAL, SPECIAL OR CONSEQUENTIAL DAMAGES ARISING OUT OF YOUR USE OF OR INABILITY TO USE THIS INFORMATION, ANY DEFECT IN THE INFORMATION, OR THE BREACH OF THESE TERMS OR CONDITIONS, WHETHER IN AN ACTION IN CONTRACT OR TORT OR BASED ON A WARRANTY, EVEN IF NAV2 OR ITS LICENSORS HAVE BEEN ADVISED OF THE POSSIBILITY OF SUCH DAMAGES. UNDER NO CIRCUMSTANCES SHALL NAV2'S OR ITS SUPPLIERS' LIABILITY HEREUNDER EXCEED THE PRICE PAID. Certain liability exclusions may not be permitted under applicable law, so to that extent the above exclusion may not apply to you.

Export Control

You agree not to export to anywhere any part of the Data provided to you or any direct product thereof except in compliance with, and with all licenses and approvals required under, applicable export laws, rules and regulations.

IP Protection

The Data are owned by NAV2 or its suppliers and are protected by applicable copyright and other intellectual property law and treaties. The Data are provided solely on the basis of a license to use, not sale.

Entire Agreement

These terms and conditions constitute the entire agreement between NAV2 (and its licensors, including their licensors and suppliers) and you pertaining to the subject matter hereof, and supersedes in their entirety any and all written or oral agreements previously existing between us with respect to such subject matter.

Governing Law.

The above terms and conditions shall be governed by the laws of the People's Republic of China, without giving effect to (i) its conflict of laws provisions, or (ii) the United Nations Convention for Contracts for the International Sale of Goods, which is explicitly excluded. Any dispute arising from or in connection with the Data provided to you hereunder shall be submitted to the Shanghai International Economic and Trade Arbitration Commission for arbitration.

Gracenote® Copyright

CD and music-related data from Gracenote, Inc., copyright©

2000-2007 Gracenote. Gracenote Software, copyright © 2000-2007 Gracenote. This product and service may practice one or more of the following U.S. Patents 5,987,525; 6,061,680; 6,154,773; 6,161,132; 6,230,192; 6,230,207; 6,240,459; 6,330,593 and other patents issued or pending. Some services supplied under license from Open Globe, Inc. for U.S. Patent 6,304,523.

Gracenote and CDDB are registered trademarks of Gracenote. The Gracenote logo and logotype, and the "Powered by Gracenote™" logo are trademarks of Gracenote.

Gracenote® End User License Agreement (EULA)

This device contains software from Gracenote, Inc. of 2000 Powell Street Emeryville, California 94608 ("Gracenote").

The software from Gracenote (the "Gracenote Software") enables this device to do disc and music file identification and obtain music-related information, including name, artist, track, and title information ("Gracenote Data") from online servers

Customer Information

("Gracenote Servers"), and to perform other functions. You may use Gracenote Data only by means of the intended End User functions of this device. This device may contain content belonging to Gracenote's providers. If so, all of the restrictions set forth herein with respect to Gracenote Data shall also apply to such content and such content providers shall be entitled to all of the benefits and protections set forth herein that are available to Gracenote. You agree that you will use the content from Gracenote ("Gracenote Content"), Gracenote Data, the Gracenote Software, and Gracenote Servers for your own personal, non-commercial use only. You agree not to assign, copy, transfer or transmit the Gracenote Content, Gracenote Software or any Gracenote Data (except in a Tag associated with a music file) to any third party. YOU AGREE NOT TO USE OR EXPLOIT GRACENOTE CONTENT, GRACENOTE DATA, THE GRACENOTE SOFTWARE, OR GRACENOTE SERVERS, EXCEPT AS EXPRESSLY PERMITTED HEREIN.

You agree that your non-exclusive licenses to use the Gracenote Content, Gracenote Data, the Gracenote Software, and Gracenote Servers will terminate if you violate these restrictions. If your licenses terminate, you agree to cease any and all use of the Gracenote Content, Gracenote Data, the Gracenote Software, and Gracenote Servers.

Gracenote, respectively, reserve all rights in Gracenote Data, the Gracenote Software, and the Gracenote Servers and Gracenote Content, including all ownership rights. Under no circumstances will either Gracenote become liable for any payment to you for any information that you provide,

including any copyrighted material or music file information. You agree that Gracenote may enforce its respective rights, collectively or separately, under this agreement against you, directly in each company's own name.

Gracenote uses a unique identifier to track queries for statistical purposes. The purpose of a randomly assigned numeric identifier is to allow Gracenote to count queries without knowing anything about who you are. For more information, see the web page at www.gracenote.com for the Gracenote Privacy Policy.

THE GRACENOTE SOFTWARE, EACH ITEM OF GRACENOTE DATA AND THE GRACENOTE CONTENT ARE LICENSED TO YOU "AS IS". NEITHER GRACENOTE MAKES ANY REPRESENTATIONS OR WARRANTIES, EXPRESS OR IMPLIED, REGARDING THE ACCURACY OF ANY GRACENOTE DATA FROM THE GRACENOTE SERVERS OR GRACENOTE CONTENT. GRACENOTE COLLECTIVELY AND SEPARATELY RESERVE THE RIGHT TO DELETE DATA AND/OR CONTENT FROM THE COMPANIES' RESPECTIVE SERVERS OR, IN THE CASE OF GRACENOTE, CHANGE DATA CATEGORIES FOR ANY CAUSE THAT GRACENOTE DEEMS SUFFICIENT. NO WARRANTY IS MADE THAT EITHER GRACENOTE CONTENT OR THE GRACENOTE SOFTWARE OR GRACENOTE SERVERS ARE ERROR-FREE OR THAT THE FUNCTIONING OF THE GRACENOTE SOFTWARE OR GRACENOTE SERVERS WILL BE UNINTERRUPTED. GRACENOTE IS NOT OBLIGATED TO PROVIDE YOU WITH ANY ENHANCED OR ADDITIONAL DATA TYPES THAT GRACENOTE MAY CHOOSE TO PROVIDE IN THE FUTURE AND IS FREE TO DISCONTINUE ITS ONLINE SERVICES AT ANY TIME. GRACENOTE DISCLAIMS ALL WARRANTIES EXPRESS OR IMPLIED, INCLUDING, BUT NOT LIMITED TO,

Customer Information

IMPLIED WARRANTIES OF MERCHANTABILITY, FITNESS FOR A PARTICULAR PURPOSE, TITLE, AND NON-INFRINGEMENT. NEITHER GRACENOTE WARRANTS THE RESULTS THAT WILL BE OBTAINED BY YOUR USE OF THE GRACENOTE SOFTWARE OR ANY GRACENOTE SERVER. IN NO CASE WILL GRACENOTE BE LIABLE FOR ANY CONSEQUENTIAL OR INCIDENTAL DAMAGES OR FOR ANY LOST PROFITS OR LOST REVENUES FOR ANY REASON WHATSOEVER. © Gracenote 2007.

Taiwan Territory

Note: In accordance with the management approach of low-power radio wave radiation motors:

Article 12: For approved and certified low-power radiation motor models, companies, firms or users must not alter the frequency, increase the power or change the characteristics and functions of the original design without authorization.

Article 14: The usage of low-power radio-frequency motors must not affect aviation safety and interfere with legal telecommunications. Should interference be detected, immediately stop using the device and only resume usage after ensuring that there is no longer any interference. For the legal telecommunication and wireless telecommunication of the telco, the low-power radio frequency motor must be able to tolerate legal limits of interference from telecommunication, industrial, scientific and radio wave equipment.

SUNA TRAFFIC CHANNEL – TERMS AND CONDITIONS

By activating, using and/or accessing the SUNA Traffic Channel, SUNA Predictive or other content or material provided by Intellematics (together, **SUNA Products and/or Services**), you must accept certain terms and conditions. The following is a brief summary of the terms and conditions that apply to you. To view the full terms and conditions relevant to your use of the SUNA Products and/or Services, please consult:

Website
www.sunatrafic.com.au/termsandconditions/

1. Acceptance

By using SUNA Products and/or Services, you will be deemed to have accepted and agreed to be bound by the terms and conditions fully detailed at:

Website
www.sunatrafic.com.au/termsandconditions/

2. Intellectual Property

SUNA Products and/or Services are for your personal use. You may not record, or retransmit the content, nor use the content in association with any other traffic information or route guidance service or device not approved by Intellematics. You obtain no right of ownership in any Intellectual Property Rights (including copyright) in the data that is used to provide SUNA Products and/or Services.

3. Appropriate Use

Customer Information

SUNA Products and/or Services are intended as an aid to personal motoring and travel planning, and do not provide comprehensive or accurate information on all occasions. On occasions, you may experience additional delay as a result of using SUNA Products and/or Services. You acknowledge that it is not intended, or suitable, for use in applications where time of arrival or driving directions may impact the safety of the public or yourself.

4. Use of SUNA Products and Services while driving

You, and other authorized drivers of the vehicle in which SUNA Products and/or Services are available or installed and active, remain at all times responsible for observing all relevant laws and codes of safe driving. In particular, you agree to only actively operate SUNA Products and/or Services when the Vehicle is at a complete stop and it is safe to do so.

5. Service Continuity and Reception of the SUNA Traffic Channel

We will use reasonable endeavors to provide the SUNA Traffic Channel 24 hours a day, 365 days a year. The SUNA Traffic Channel may occasionally be unavailable for technical reasons or for planned maintenance. We will try to perform maintenance at times when congestion is light. We reserve the right to withdraw SUNA Products and/or Services at any time.

Also, we cannot assure the uninterrupted reception of the SUNA Traffic Channel RDS-TMC signal at any particular location.

6. Limitation of Liability

Neither Intelematics (nor its suppliers or the manufacturer of your device (the “**Suppliers**”)) shall be liable to you or to any third party for any damages either direct, indirect, incidental, consequential or otherwise arising out of the use of or inability to use SUNA Products and/or

Services even if Intelematics or a Supplier has been advised of the possibility of such damages. You also acknowledge that the neither Intelematics nor any Supplier guarantees nor make any warranties that relate to the availability, accuracy or completeness of SUNA Products and/or Services, and to the extent which it is lawful to do so, both Intelematics and each Supplier excludes any warranties which might otherwise be implied by any State or Federal legislation in relation to SUNA Products and/or Services.

7. Please Note

Great care has been taken in preparing this manual. Constant product development may mean that some information is not entirely up-to-date. The information in this document is subject to change without notice.

EMISSION LAW



WARNING: Do not remove or alter the original equipment floor covering or insulation between it and the metal floor of the vehicle. The floor covering and insulation protect occupants of the vehicle from the engine and exhaust system heat and noise. On vehicles with no original equipment floor covering insulation, do not carry passengers in a manner that permits prolonged skin contact with the metal floor. Failure to follow these instructions may result in fire or personal injury.

U.S. federal laws and certain state laws prohibit removing or rendering inoperative emission control system components. Similar federal or provincial laws may apply in Canada. We do not approve of any vehicle modification without first determining applicable laws.

Customer Information



Tampering with emissions control systems including related sensors or the Diesel Exhaust Fluid system can result in reduced engine power and the illumination of the service engine soon light.

Tampering With a Noise Control System

Federal laws prohibit the following acts:

- Removal or rendering inoperative by any person other than for purposes of maintenance.
- Repair or replacement of any device or element of the design incorporated into a new vehicle for the purpose of noise control prior to its sale or delivery to the ultimate purchaser or while it is in use.
- The use of the vehicle after any person removes or renders inoperative any device or element of the design.

The U.S. Environmental Protection Agency may presume to constitute tampering as follows:

- Removal of hood blanket, fender apron absorbers, fender apron barriers, underbody noise shields or acoustically absorptive material.
- Tampering or rendering inoperative the engine speed governor, to allow engine speed to exceed manufacturer specifications.

If the engine does not start, runs rough, experiences a decrease in engine performance, experiences excess fuel consumption or produces excessive exhaust smoke, check for the following:

- A plugged or disconnected air inlet system hose.
- A plugged engine air filter element.
- Water in the fuel filter and water separator.

- A clogged fuel filter.
- Contaminated fuel.
- Air in the fuel system, due to loose connections.
- An open or pinched sensor hose.
- Incorrect engine oil level.
- Incorrect fuel for climatic conditions.
- Incorrect engine oil viscosity for climactic conditions.

Note: *Some vehicles have a lifetime fuel filter that is integrated with the fuel tank. Regular maintenance or replacement is not needed.*

Note: *If these checks do not help you correct the concern, have your vehicle checked as soon as possible.*

Noise Emissions Warranty, Prohibited Tampering Acts and Maintenance

On January 1, 1978, Federal regulation became effective governing the noise emission on trucks over 10,000 lb (4,536 kg) Gross Vehicle Weight Rating (GVWR). The preceding statements concerning prohibited tampering acts and maintenance, and the noise warranty found in the Warranty Guide, are applicable to complete chassis cabs over 10,000 lb (4,536 kg) GVWR.

EXPORT UNIQUE OPTIONS

For your particular global region, your vehicle may be equipped with features and options that are different from the features and options that are described in this Owner's Manual. A market unique supplement may be supplied that complements this book. By referring to the market unique supplement, if provided, you can properly identify those features, recommendations and specifications that are unique to your vehicle. This Owner's

Customer Information

Manual is written primarily for the U.S. and Canadian markets. Features or equipment listed as standard may be different on units built for export. **Refer to this Owner's Manual for all other required information and warnings.**

Appendices

ELECTROMAGNETIC COMPATIBILITY



WARNING: Do not place objects or mount equipment on or near the airbag cover, on the side of the front or rear seatbacks, or in areas that may come into contact with a deploying airbag. Failure to follow these instructions may increase the risk of personal injury in the event of a crash.



WARNING: Do not fasten antenna cables to vehicle wiring, fuel pipes and brake pipes.



WARNING: Keep antenna and power cables at least 4 in (10 cm) from any electronic modules and airbags.

Note: We test and certify your vehicle to meet electromagnetic compatibility legislation. It is your responsibility to make sure that any equipment an authorized dealer installs on your vehicle complies with applicable local legislation and other requirements. Installation of some aftermarket electronic devices could degrade the performance of vehicle functions, which use radio frequency signals such as broadcast radio receiver, tire pressure monitoring system, push button start, **Bluetooth®** connectivity or satellite navigation.

Note: Any radio frequency transmitter equipment in your vehicle (such as cellular telephones and amateur radio transmitters) must keep to the parameters in the following illustrations and table. We do not provide any other special provisions or conditions for installations or use.

Car

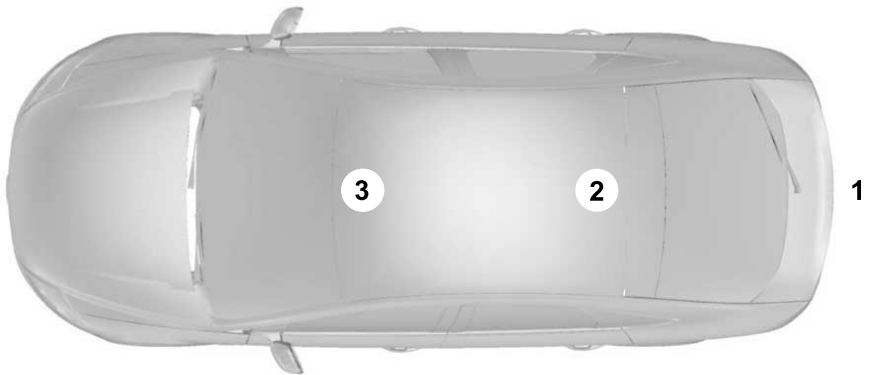

Appendices

Van

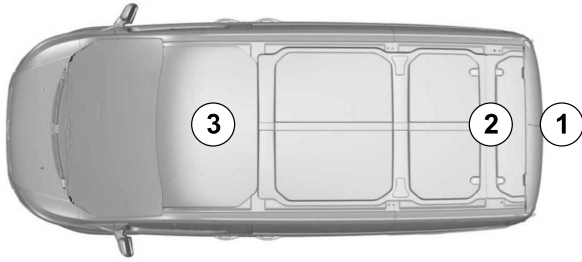

Truck

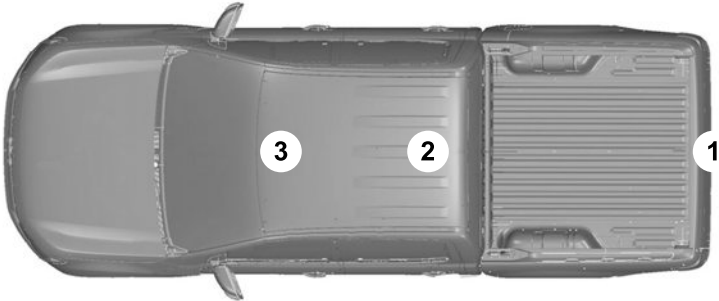

Appendices

Frequency Band MHz	Maximum Output Power Watt (Peak RMS)	Antenna Positions
1-30	50	1
50-54	50	2, 3
68-88	50	2, 3
142-176	50	2, 3
380-512	50	2, 3
806-870	10	2, 3

Note: *After the installation of radio frequency transmitters, check for disturbances from and to all electrical equipment in your vehicle, both in the standby and transmit modes.*

Check all electrical equipment:

- With the ignition ON.
- With the vehicle running.
- During a road test at various speeds.

Check that electromagnetic fields generated inside your vehicle cabin by the transmitter installed do not exceed applicable human exposure requirements.

Index

3

360 Degree Camera.....	229
360 Degree Camera Settings.....	231
360 Degree Camera Guide Lines.....	230
360 Degree Camera Limitations.....	229
360 Degree Camera Precautions.....	229
360 Degree Camera Settings.....	231
Switching the 360 Degree Camera On and Off.....	231
Switching the 360 Degree Camera View.....	231

4

4WD	
See: Four-Wheel Drive.....	182

9

911 Assist.....	68
-----------------	----

A

A/C

See: Climate Control - Vehicles With: Automatic Temperature Control.....	117
See: Climate Control - Vehicles With: Manual Temperature Control.....	122
About This Publication.....	17

ABS

See: Brakes.....	194
------------------	-----

Accessing Apps.....	437
---------------------	-----

Accessing Navigation.....	440
---------------------------	-----

Accessing the Passive Key Backup Position.....	156
--	-----

Accessories.....	445
------------------	-----

Adaptive Cruise Control.....	234
------------------------------	-----

Adaptive Cruise Control – Troubleshooting.....	240
--	-----

Adaptive Cruise Control Indicators.....	240
---	-----

Adaptive Cruise Control Limitations.....	235
--	-----

Adaptive Cruise Control Precautions.....	234
--	-----

Adaptive Cruise Control – Troubleshooting.....	240
--	-----

Adaptive Cruise Control – Information Messages.....	240
---	-----

Adjusting the Exterior Mirrors.....	105
-------------------------------------	-----

Adjusting the Headlamps.....	329
------------------------------	-----

Adjusting the Instrument Panel Lighting Brightness.....	102
---	-----

Adjusting the Map.....	440
------------------------	-----

Changing the Format of the Map.....	440
-------------------------------------	-----

Zooming the Map In and Out.....	440
---------------------------------	-----

Adjusting the Seatbelts During Pregnancy.....	54
---	----

Adjusting the Sound Settings.....	415
-----------------------------------	-----

Adjusting the Steering Wheel.....	89
-----------------------------------	----

Adjusting the Volume.....	414
---------------------------	-----

Aid Mode.....	251
---------------	-----

How Does Aid Mode Work.....	251
-----------------------------	-----

What Is Aid Mode.....	251
-----------------------	-----

Airbag Precautions.....	61
-------------------------	----

Airbags.....	59
--------------	----

Front Passenger Sensing System.....	63
-------------------------------------	----

Air Conditioning	
See: Climate Control - Vehicles With: Automatic Temperature Control.....	117

See: Climate Control - Vehicles With: Manual Temperature Control.....	122
---	-----

Air Conditioning System Capacity and Specification.....	402
---	-----

Air Filter	
------------	--

See: Changing the Engine Air Filter.....	326
--	-----

Alert and Aid Mode.....	251
-------------------------	-----

How Does Alert and Aid Mode Work.....	252
---------------------------------------	-----

What Is Alert and Aid Mode.....	251
---------------------------------	-----

Alert Mode.....	250
-----------------	-----

Adjusting the Steering Wheel Vibration Intensity.....	251
---	-----

How Does Alert Mode Work.....	251
-------------------------------	-----

What Is Alert Mode.....	250
-------------------------	-----

AM/FM Radio.....	416
------------------	-----

AM/FM Radio Limitations.....	416
------------------------------	-----

Selecting a Radio Station.....	416
--------------------------------	-----

Ambient Lighting.....	102
-----------------------	-----

Adjusting Ambient Lighting.....	102
---------------------------------	-----

Switching Ambient Lighting On and Off.....	102
--	-----

Index

Anti-Lock Braking System.....	194
Anti-Lock Braking System	
Limitations.....	194
Appendices.....	524
Applying the Electric Parking	
Brake.....	198
Applying the Electric Parking Brake in an	
Emergency.....	198
App Precautions.....	437
App Requirements.....	437
Apps.....	437
Audio System.....	414
AM/FM Radio.....	416
Audio System – Troubleshooting.....	421
Digital Radio.....	417
Satellite Radio.....	418
Audio System Precautions.....	414
Audio System – Troubleshooting.....	421
Audio System – Information	
Messages.....	421
Auto-Dimming Interior Mirror.....	104
Auto-Dimming Interior Mirror	
Limitations.....	104
What Is the Auto-Dimming Interior	
Mirror.....	104
Autolamps.....	95
Autolamp Settings.....	95
What Are Autolamps.....	95
Autolock.....	79
Autolock Requirements.....	79
What Is Autolock.....	79
Automatically Releasing the Electric	
Parking Brake.....	198
Automatic Crash Shutoff.....	302
Automatic Crash Shutoff	
Precautions.....	303
Re-Enabling Your Vehicle.....	303
What Is Automatic Crash Shutoff.....	302
Automatic Emergency Braking.....	266
Switching Automatic Emergency Braking	
On and Off.....	266
What Is Automatic Emergency	
Braking.....	266
Automatic Engine Stop.....	155
How Does Automatic Engine Stop	
Work.....	155
Overriding Automatic Engine Stop.....	156
Switching Automatic Engine Stop On and	
Off.....	156
What Is Automatic Engine Stop.....	155
Automatic High Beam Control.....	98
Automatic High Beam Control	
Indicators.....	99
Automatic High Beam Control	
Limitations.....	99
Automatic High Beam Control	
Precautions.....	98
Automatic High Beam Control	
Requirements.....	99
How Does Automatic High Beam Control	
Work.....	98
Overriding Automatic High Beam	
Control.....	99
Switching Automatic High Beam Control	
On and Off.....	99
Automatic High Beam Control –	
Troubleshooting.....	100
Automatic High Beam Control –	
Information Messages.....	100
Automatic Locking Mode.....	54
Disengaging Automatic Locking Mode.....	54
Engaging Automatic Locking Mode.....	54
What Is Automatic Locking Mode.....	54
Automatic Transmission Audible	
Warnings.....	181
Automatic Transmission.....	178
Automatic Transmission Positions.....	178
Brake Shift Interlock.....	180
Manually Shifting Gears.....	180
Automatic Transmission Fluid Capacity	
and Specification.....	403
Automatic Transmission Position	
Indicators.....	179
Automatic Transmission Positions.....	178
Drive (D).....	178
Manual (M).....	179
Neutral (N).....	178
Park (P).....	178
Reverse (R).....	178
Sport (S).....	179
Automatic Transmission	
Precautions.....	178
Auto Mode.....	119
Auto Mode Indicators.....	119
Switching Auto Mode On and Off.....	119

Index

Switching Dual Mode On and Off.....	120
Auto-Start-Stop.....	161
Auto-Start-Stop – Troubleshooting.....	163
Auto-Start-Stop Indicators.....	163
Auto-Start-Stop Precautions – Automatic Transmission.....	161
Auto-Start-Stop Precautions – Manual Transmission.....	161
Auto-Start-Stop – Troubleshooting.....	163
Auto-Start-Stop – Frequently Asked Questions.....	165
Auto-Start-Stop – Information Messages.....	163
Autounlock.....	78
Autounlock Requirements.....	78
Switching Autounlock On and Off.....	79
What Is Autounlock.....	78
Auxiliary Switches.....	447
B	
Battery	
See: Changing the 12V Battery.....	326
Beginning a Voice Interaction.....	428
Blind Spot Information System.....	256
Blind Spot Information System – Troubleshooting.....	258
Blind Spot Information System Indicators.....	258
Blind Spot Information System Limitations.....	256
Blind Spot Information System Precautions.....	256
Blind Spot Information System Requirements - Automatic Transmission.....	257
Blind Spot Information System Requirements - Manual Transmission.....	256
Blind Spot Information System – Troubleshooting.....	258
Blind Spot Information System – Information Messages.....	258
Bluetooth®.....	436
Body Control Module Fuse Box.....	314
Accessing the Body Control Module Fuse Box.....	314
Identifying the Fuses in the Body Control Module Fuse Box.....	315
Locating the Body Control Module Fuse Box.....	314
Bonnet Lock	
See: Opening and Closing the Hood.....	318
Booster Seats.....	48
Brake Fluid Specification.....	195
Brake Over Accelerator.....	194
Brake Precautions.....	194
Brakes.....	194
Anti-Lock Braking System.....	194
Brakes – Troubleshooting.....	195
Brake Shift Interlock.....	180
Brake Shift Interlock Precautions.....	180
Using Brake Shift Interlock.....	180
What Is Brake Shift Interlock.....	180
Brakes – Troubleshooting.....	195
Brakes – Frequently Asked Questions.....	197
Brakes – Information Messages.....	196
Brakes – Warning Lamps.....	195
Breaking-In.....	297
C	
Calculating Payload.....	274
Calculating the Load Limit.....	274
California Proposition 65 - United States of America.....	494
Canceling the Set Speed.....	208
Capacities and Specifications.....	393
Catalytic Converter.....	173
Catalytic Converter – Troubleshooting.....	173
Catalytic Converter Precautions.....	173
Catalytic Converter – Troubleshooting.....	173
Catalytic Converter – Warning Lamps.....	173
Center Console - Automatic Transmission.....	31
Center Console.....	149
Locking the Center Console.....	149
Opening the Center Console.....	149
Center Console - Manual Transmission.....	30
Center Display Limitations.....	425

Index

Center Display Overview.....	425	Cleaning the Convertible Top.....	362
Center Display Precautions.....	425	Cleaning the Engine Compartment.....	361
Changing a Flat Tire.....	387	Cleaning the Exterior Precautions.....	360
Changing a Road Wheel.....	387	Cleaning the Underbody.....	362
Changing the 12V Battery.....	326	Cleaning Wheels.....	361
Changing the Engine Air Filter.....	326	Cleaning Windows and Wiper Blades.....	361
Changing the Fuel Filter.....	326	Cleaning the Interior.....	362
Changing the Remote Control Battery.....	70	Cleaning Carpets and Floor Mats.....	363
Changing the Vehicle Wi-Fi Hotspot Name or Password.....	412	Cleaning Displays and Screens.....	363
Charging a Device.....	143	Cleaning Fabric Seats and Headliners.....	363
Charging a Wireless Device.....	148	Cleaning Leather and Vinyl.....	363
Checking MyKey System Status.....	76	Cleaning Plastic.....	363
Checking the Brake Fluid.....	194	Cleaning Seatbelts.....	364
Checking the Clutch Fluid Level.....	176	Cleaning the Instrument Panel.....	362
Checking the Coolant.....	322	Clearing All MyKeys.....	75
Checking the Manual Transmission Fluid Level.....	176	Clearing the Garage Door Opener.....	140
Checking the Seatbelts.....	56	Climate Control.....	117
Checking the Tire Pressures.....	379	Auto Mode.....	119
Checking the Wiper Blades.....	91	Climate Control Hints.....	120
Children and Airbags.....	62	Closing the Tailgate.....	84
Child Restraint Anchor Points.....	41	Closing the Tailgate From Outside Your Vehicle.....	84
Locating the Child Restraint Lower Anchor Points.....	41	Clutch Fluid Capacity and Specification.....	176
Locating the Child Restraint Top Tether Anchor Points.....	42	Cold Weather Precautions.....	297
What Are the Child Restraint Anchor Points.....	41	Connected Vehicle.....	409
Child Restraints.....	42	Connecting the Vehicle to a Mobile Network.....	409
Child Restraint Position Information.....	42	Connected Vehicle Data.....	24
Child Restraints Recommendation.....	44	Connected Vehicle Limitations.....	409
Child Safety.....	40	Connected Vehicle Requirements.....	409
Child Restraint Anchor Points.....	41	Connected Vehicle – Troubleshooting.....	410
Child Restraints.....	42	Connecting a Bluetooth® Device.....	436
Installing Child Restraints.....	44	Connecting a Trailer.....	281
Child Safety Locks.....	50	Connecting a Trailer – Troubleshooting.....	282
Child Safety Precautions.....	40	Connecting a Trailer Precautions.....	281
Cleaning Products.....	360	Connecting a Trailer – Troubleshooting.....	282
Cleaning the Exterior.....	360	Connecting a Trailer – Information Messages.....	282
Cleaning Camera Lenses and Sensors.....	362	Connecting the Vehicle to a Mobile Network.....	409
Cleaning Chrome, Aluminium or Stainless Steel.....	361	Connecting FordPass to the Modem.....	409
Cleaning Headlamps and Rear Lamps.....	361	Enabling and Disabling the Modem.....	409
Cleaning Stripes or Graphics.....	362	What Is the Modem.....	409

Index

Connecting the Vehicle to a Wi-Fi Network.....	409
Connecting Your Phone.....	431
Contacting Us.....	15
Cooling System Capacity and Specification - 2.3L EcoBoost™.....	400
Cooling System Capacity and Specification - 2.7L EcoBoost™.....	401
Crash and Breakdown Information.....	299
Automatic Crash Shutoff.....	302
Jump Starting the Vehicle.....	300
Post-Crash Alert System.....	302
Recovery Towing.....	303
Crash Sensors and Airbag Indicator.....	66
Crawler Gear.....	174
Using Crawler Gear.....	174
What Is Crawler Gear.....	174
Creating a MyKey.....	75
Creating a Vehicle Wi-Fi Hotspot.....	412
Cross Traffic Alert.....	259
Cross Traffic Alert – Troubleshooting.....	261
Cross Traffic Alert Indicators.....	260
Cross Traffic Alert Limitations.....	259
Cross Traffic Alert Precautions.....	259
Cross Traffic Alert – Troubleshooting.....	261
Cross Traffic Alert – Information Messages.....	261
Cruise Control.....	232
Cruise Control Indicators.....	233
Customer Information.....	461
Radio Frequency Certification Labels.....	464
D	
Data Privacy.....	22
Department of Transportation Uniform Tire Quality Grades.....	368
Digital Radio.....	417
Digital Radio Indicators.....	418
Digital Radio Limitations.....	417
How Does Digital Radio Work.....	417
Switching Digital Radio Reception On and Off.....	417
What Is Digital Radio.....	417
Directing the Flow of Air.....	118
Disposing of Airbags.....	67
Distance Indication.....	264
Distance Indication Indicator.....	266
Switching Distance Indication On and Off.....	266
What Is Distance Indication.....	264
Doors and Locks.....	78
Autolock.....	79
Autounlock.....	78
Doors and Locks – Troubleshooting.....	79
Mislock.....	79
Operating the Doors From Inside Your Vehicle.....	78
Operating the Doors From Outside Your Vehicle.....	78
Doors and Locks – Troubleshooting.....	79
Doors and Locks – Frequently Asked Questions.....	81
Doors and Locks – Information Messages.....	80
Doors and Locks – Warning Lamps.....	79
Drive Belt Routing - 2.3L EcoBoost™.....	332
Drive Belt Routing - 2.7L EcoBoost™.....	333
Driver Alert.....	269
Driver Alert – Troubleshooting.....	270
Driver Alert Indicators.....	270
Driver Alert Limitations.....	269
Driver Alert Precautions.....	269
Driver Alert – Troubleshooting.....	270
Driver Alert – Information Messages.....	270
Driving Economically.....	297
Driving Hints.....	289
Off-Road Driving.....	289
E	
Electric Parking Brake Audible Warning.....	199
Electric Parking Brake.....	198
Electric Parking Brake – Troubleshooting.....	199
Electric Parking Brake – Troubleshooting.....	199
Electric Parking Brake – Information Messages.....	200

Index

Electric Parking Brake – Warning Lamps.....	199
Electric Power Steering.....	219
Electric Power Steering Precautions.....	219
How Does Electric Power Steering Work.....	219
Electromagnetic Compatibility.....	524
Electronic Locking Differential.....	190
Electronic Locking Differential – Troubleshooting.....	192
Electronic Locking Differential Indicators.....	191
Electronic Locking Differential – Troubleshooting.....	192
Electronic Locking Differential – Information Messages.....	192
Emergency Call Limitations.....	68
Emergency Call Requirements.....	68
Emergency Call System Data.....	25
Emergency Towing.....	309
Emission Law.....	521
Enabling Apps on an Android Device.....	437
Enabling Apps on an iOS Device.....	437
Enabling Remote Start.....	114
End User License Agreement.....	496
Engine Block Heater.....	153
Engine Block Heater Precautions.....	153
How Does the Engine Block Heater Work.....	153
Using the Engine Block Heater.....	154
Engine Oil Capacity and Specification - 2.3L EcoBoost™.....	397
Engine Oil Capacity and Specification - 2.7L EcoBoost™.....	398
Engine Oil.....	321
Adding Engine Oil.....	321
Checking the Engine Oil Level.....	321
Engine Oil Capacity and Specification.....	322
Engine Oil Dipstick Overview.....	321
Resetting the Engine Oil Change Reminder.....	322
Engine Specifications - 2.3L EcoBoost™.....	393
Engine Specifications - 2.7L EcoBoost™.....	394
Evasive Steering Assist.....	266
Evasive Steering Assist Limitations.....	267
Switching Evasive Steering Assist On and Off.....	267
What Is Evasive Steering Assist.....	266
Event Data.....	23
Export Unique Options.....	522
Exterior Bulbs.....	330
Changing a Rear Lamp Bulb.....	332
Exterior Bulb Specification Chart.....	330
Removing a Rear Lamp Assembly.....	331
Exterior Lamps.....	95
Exterior Lamp Audible Warning.....	97
Exterior Lamp Indicators.....	96
Switching the Daytime Running Lamps On and Off.....	95
Switching the Front Fog Lamps On and Off.....	96
Switching the Spot Lamps On and Off.....	96
Switching the Turn Signal Lamps On and Off.....	95
Exterior Lighting Control.....	94
Exterior Lighting.....	94
Autolamps.....	95
Automatic High Beam Control.....	98
Automatic High Beam Control – Troubleshooting.....	100
Exterior Lamps.....	95
Exterior Zone Lighting.....	97
Headlamps.....	94
Headlamps – Troubleshooting.....	94
Exterior Mirrors.....	105
Exterior Zone Lighting.....	97
Exterior Zone Lighting Settings.....	97
Using the Exterior Zone Lighting.....	97
What Is Exterior Zone Lighting.....	97
F	
Fastening and Unfastening the Seatbelts.....	53
Feature Bar.....	426
Fender Anchor Points.....	279
Fender Anchor Point Load Capacities.....	279
Locating the Fender Anchor Points.....	279

Index

Flat Tire	
See: Changing a Flat Tire.....	387
Floor Mats.....	298
Folding the Exterior Mirrors.....	105
Ford Protect.....	450
Four-Wheel Drive.....	182
Four-Wheel Drive Modes.....	186
Four-Wheel Drive – Troubleshooting.....	187
Four-Wheel Drive Indicators.....	187
Four-Wheel Drive Limitations.....	183
Four-Wheel Drive Modes.....	186
Four-Wheel Drive Auto.....	187
Four-Wheel Drive High.....	187
Four-Wheel Drive Low.....	187
Two-Wheel Drive High.....	186
Four-Wheel Drive Precautions.....	182
Four-Wheel Drive – Troubleshooting.....	187
Four-Wheel Drive – Information Messages.....	188
Four-Wheel Drive – Warning Lamps.....	187
Front Axle Fluid Capacity and Specification.....	405
Front Exterior – 2-Door.....	34
Front Exterior – 4-Door, Vehicles With: Hard Top.....	35
Front Exterior – 4-Door, Vehicles With: Soft Top.....	36
Front Parking Aid.....	223
Front Parking Aid Audible Warnings.....	224
Front Parking Aid Limitations.....	224
Locating the Front Parking Aid Sensors.....	224
What is the Front Parking Aid.....	223
Front Passenger Sensing System.....	63
Front Passenger Sensing System Indicators.....	65
Front Passenger Sensing System Precautions.....	65
How Does the Front Passenger Sensing System Work.....	63
What Is the Front Passenger Sensing System.....	63
Front Seat Precautions.....	126
Front Seats.....	126
Heated Seats.....	132
Manual Seats.....	127
Power Seats.....	129
Fuel and Refueling.....	166
Fuel and Refueling – Troubleshooting.....	171
Fuel Quality.....	167
Refueling.....	169
Running Out of Fuel.....	168
Fuel and Refueling Precautions.....	166
Fuel and Refueling – Troubleshooting.....	171
Fuel and Refueling – Information Messages.....	171
Fuel and Refueling – Warning Lamps.....	171
Fuel Gauge.....	106
Fuel Gauge Limitations.....	107
Locating the Fuel Filler Door.....	107
What Is Distance to Empty.....	107
What Is the Fuel Gauge.....	106
What Is the Low Fuel Reminder.....	107
Fuel Quality.....	167
Selecting the Correct Fuel.....	167
Fuel Tank Capacity.....	171
Fuse Precautions.....	310
Fuses.....	310
Body Control Module Fuse Box.....	314
Fuses – Troubleshooting.....	317
Under Hood Fuse Box.....	310
Fuses – Troubleshooting.....	317
Fuses – Frequently Asked Questions.....	317
G	
G.O.A.T. Mode Control.....	242
G.O.A.T. Mode Control – Troubleshooting.....	246
G.O.A.T. Modes.....	243
G.O.A.T. Mode Control – Troubleshooting.....	246
G.O.A.T. Mode Control – Frequently Asked Questions.....	248
G.O.A.T. Mode Control – Information Messages.....	246
G.O.A.T. Mode Control – Warning Lamps.....	246
G.O.A.T. Modes.....	243
Baja.....	243
Eco.....	243
Mud/Ruts.....	243
Normal.....	244
Rock Crawl.....	244

Index

Sand.....	244	Hill Start Assist – Troubleshooting.....	201
Slippery.....	245	Hill Start Assist – Information	
Sport.....	245	Messages.....	201
Garage Door Opener.....	138	Hood Lock	
Garage Door Opener Limitations.....	138	See: Opening and Closing the Hood.....	318
Garage Door Opener Precautions.....	138	Horn.....	89
Garage Door Opener Radio		How Does Adaptive Cruise Control	
Frequencies.....	141	Work.....	234
General Maintenance Information.....	452	How Does Blind Spot Information	
Glasses Holder.....	150	System Work.....	256
Locating the Glasses Holder.....	150	How Does Cross Traffic Alert	
Glossary of Tire Terminology.....	374	Work.....	259
Glove Compartment.....	149	How Does Driver Alert Work.....	269
Locking the Glove Compartment.....	149	How Does Four-Wheel Drive Work - 4x4	
Opening the Glove Compartment.....	149	with Part Time Engagement.....	182
H		How Does Four-Wheel Drive Work -	
Headlamp Adjusting		Advanced 4x4 with 4A Mode.....	182
See: Adjusting the Headlamps.....	329	How Does G.O.A.T. Mode Control	
Headlamps.....	94	Work.....	242
Headlamp Indicators.....	94	How Does Hill Descent Control	
Using the High Beam Headlamps.....	94	Work.....	217
Headlamps – Troubleshooting.....	94	How Does Hill Start Assist Work.....	201
Headlamps – Frequently Asked		How Does Pre-Collision Assist	
Questions.....	94	Work.....	262
Heated Seats.....	132	How Does Stability Control Work.....	204
Heated Seat Precautions.....	132	How Does the 360 Degree Camera	
Switching the Heated Seats On and		Work.....	229
Off.....	132	How Does the Garage Door Opener	
Heating		Work.....	138
See: Climate Control - Vehicles With:		How Does the Lane Keeping System	
Automatic Temperature Control.....	117	Work.....	249
See: Climate Control - Vehicles With: Manual		How Does the Personal Safety System	
Temperature Control.....	122	Work.....	58
Hill Descent Control.....	217	How Does the Rear Occupant Alert	
Hill Descent Control –		System Work.....	136
Troubleshooting.....	218	How Does the Safety Canopy™	
Hill Descent Control Indicator.....	217	Work.....	60
Hill Descent Control Precautions.....	217	How Does Traction Control Work.....	202
Hill Descent Control –		How Does Trailer Sway Control	
Troubleshooting.....	218	Work.....	288
Hill Descent Control – Information		How Do the Front Airbags Work.....	59
Messages.....	218	How Do the Side Airbags Work.....	59
Hill Start Assist.....	201		
Hill Start Assist – Troubleshooting.....	201	I	
Hill Start Assist Precautions.....	201	Identifying Fuse Types.....	317
		Identifying the Audio Unit.....	424

Index

Identifying the Auxiliary Switch	
Wiring.....	449
Identifying the Climate Control Unit.....	117
Inflating the Tires.....	379
Information On Demand Screen -	
Vehicles With: 12.3 Inch Screen.....	427
Information on the Tire Sidewall.....	369
Inspecting the Tire for Damage.....	380
Inspecting the Tire for Wear.....	380
Inspecting the Wheel Valve Stems.....	381
Installing Child Restraints.....	44
Combining the Seatbelt and Lower Anchors	
for Attaching Child Restraints.....	47
Installing a Child Restraint in a Center	
Seat.....	47
Using Lower Anchors and Tethers for	
Children.....	46
Using Seatbelts.....	44
Using Tether Straps.....	48
Instrument Cluster Display.....	112
Personalized Settings.....	113
Trip Computer.....	113
Instrument Cluster Display Main	
Menu.....	112
Instrument Cluster Indicators.....	109
Instrument Cluster.....	106
Fuel Gauge.....	106
Instrument Cluster Overview.....	106
Instrument Cluster Warning	
Lamps.....	108
Instrument Panel.....	29
Interior Air Quality.....	125
Interior Bulbs.....	332
Interior Bulb Specification Chart.....	332
Interior Lamp Function.....	101
Switching the Interior Lamp Function On	
and Off.....	101
What Is the Interior Lamp Function.....	101
Interior Lighting.....	101
Ambient Lighting.....	102
Interior Lamp Function.....	101
Interior Lighting - Troubleshooting.....	102
Interior Lighting - Troubleshooting.....	102
Interior Lighting - Frequently Asked	
Questions.....	102
Interior Mirror.....	104
Auto-Dimming Interior Mirror.....	104
Interior Mirror Precautions.....	104
Introduction.....	17
J	
Jump Starting the Vehicle.....	300
Jump Starting Precautions.....	300
Jump Starting the Vehicle.....	301
Preparing the Vehicle.....	301
K	
Keyless Entry.....	82
Keyless Entry - Troubleshooting.....	83
Keyless Entry Limitations.....	82
Keyless Entry Settings.....	82
Keyless Entry - Troubleshooting.....	83
Keyless Entry - Frequently Asked	
Questions.....	83
Keys and Remote Controls.....	69
Keys and Remote Controls -	
Troubleshooting.....	73
Keys and Remote Controls -	
Troubleshooting.....	73
Keys and Remote Controls - Information	
Messages.....	73
L	
Lane Keeping System Indicators.....	252
Lane Keeping System.....	249
Aid Mode.....	251
Alert and Aid Mode.....	251
Alert Mode.....	250
Lane Keeping System -	
Troubleshooting.....	253
Lane Keeping System Limitations.....	249
Lane Keeping System	
Precautions.....	249
Lane Keeping System -	
Troubleshooting.....	253
Lane Keeping System - Frequently Asked	
Questions.....	254
Lane Keeping System - Information	
Messages.....	253
Launching or Retrieving a Boat or	
Personal Watercraft.....	285
Live Traffic.....	440
Switching Live Traffic On and Off.....	440

Index

What Is Live Traffic.....	440	Manually Shifting Gears.....	180
Load Carrying.....	271	Shifting Using the Buttons on the Selector Lever.....	180
Fender Anchor Points.....	279	Manual Seats.....	127
Roof Rack.....	276	Adjusting the Head Restraint.....	127
Load Carrying Precautions.....	271	Adjusting the Seat Backrest.....	129
Loading Your Trailer.....	284	Folding the Seats.....	134
Locating the 360 Degree Cameras.....	230	Head Restraint Components.....	127
Locating the Auxiliary Switches.....	447	Installing the Head Restraint.....	128
Locating the Auxiliary Switch Wiring.....	447	Moving the Seat Backward and Forward.....	128
Locating the Blind Spot Information System Sensors.....	257	Removing the Head Restraint.....	128
Locating the Brake Fluid Reservoir - 2.3L EcoBoost™.....	194	Unfolding the Seats.....	135
Locating the Brake Fluid Reservoir - 2.7L EcoBoost™.....	194	Manual Transmission Fluid Capacity and Specification.....	176
Locating the Cross Traffic Alert Sensors.....	260	Manual Transmission.....	174
Locating the Fuel Filler Funnel.....	167	Crawler Gear.....	174
Locating the Power Outlet.....	144	Manual Transmission – Troubleshooting.....	177
Locating the Pre-Collision Assist Sensors.....	264	Manual Transmission Precautions.....	174
Locating the Rear View Camera.....	226	Manual Transmission – Troubleshooting.....	177
Locating the Safety Compliance Certification Labels.....	272	Manual Transmission – Frequently Asked Questions.....	177
Locating the Tire label.....	368	Map Pocket.....	150
Locating the USB Ports.....	142	Locating the Map Pocket.....	150
Locating the Wireless Accessory Charger.....	147	Mislock.....	79
Locating Your Vehicle.....	70	Mislock Limitations.....	79
Locking and Unlocking the Tailgate.....	84	Switching Mislock On and Off.....	79
Locking the Rear Window Controls.....	103	What Is Mislock.....	79
M			
Maintenance.....	318	Mobile Communications Equipment.....	496
Engine Oil.....	321	Mobile Device Data.....	25
Exterior Bulbs.....	330	Motorcraft Parts - 2.3L EcoBoost™.....	395
Interior Bulbs.....	332	Motorcraft Parts - 2.7L EcoBoost™.....	396
Maintenance Precautions.....	318	Muting the Audio.....	415
Making and Receiving a Phone Call.....	433	MyKey Settings.....	74
Manually Dimming the Interior Mirror.....	104	Configurable MyKey Settings.....	74
Manually Releasing the Electric Parking Brake.....	198	Non-Configurable MyKey Settings.....	74
		MyKey – Troubleshooting.....	76
		MyKey – Frequently Asked Questions.....	77
		MyKey – Information Messages.....	76
		MyKey™.....	74
		MyKey Settings.....	74
		MyKey – Troubleshooting.....	76

Index

N

Navigation Map Updates.....	440
Navigation.....	440
Adjusting the Map.....	440
Live Traffic.....	440
Route Guidance.....	441
Setting a Destination.....	440
Waypoints.....	441
Normal Scheduled Maintenance.....	455

O

Off-Road Driving.....	289
After Driving Your Vehicle Off-Road.....	295
Basic Off-Road Driving Techniques.....	289
Driving Off-Road.....	290
Driving Through Water Limitations.....	294
Driving Your Vehicle at High Speeds.....	296
Off-Road Driving Aids.....	294
Off-Road Driving Precautions.....	289
What Is Off-Road Driving.....	289
Opening and Closing the Hood.....	318
Opening and Closing the Windows.....	103
Opening the Tailgate.....	84
Opening the Tailgate From Outside Your Vehicle.....	84
Operating the Doors From Inside Your Vehicle.....	78
Individually Unlocking and Locking the Doors Using the Locking Button.....	78
Unlocking and Locking the Doors Using the Central Locking.....	78
Operating the Doors From Outside Your Vehicle.....	78
Unlocking and Locking the Doors Using the Remote Control.....	78
Ordering a Canadian French Owner's Manual.....	462
Our Sustainability Report.....	461
Overriding the Set Speed.....	239

P

Parking Aid Indicators.....	225
Parking Aid Precautions.....	222
Parking Aids.....	222
Front Parking Aid.....	223

Parking Aids – Troubleshooting.....	225
Rear Parking Aid.....	223
Parking Aids – Troubleshooting.....	225
Parking Aids – Information Messages.....	225
Passive Anti-Theft System.....	87
How Does the Passive Anti-Theft System Work.....	87
What Is the Passive Anti-Theft System.....	87
Perchlorate.....	495
Performing a Master Reset.....	444
Personalized Settings.....	113
Changing the Instrument Cluster Display Language.....	113
Changing the Measure Unit.....	113
Changing the Temperature Unit.....	113
Changing the Tire Pressure Unit.....	113
Personal Safety System Components.....	58
Personal Safety System™.....	58
Phone Menu.....	431
Phone.....	431
Phone Precautions.....	431
Playing Media Using Bluetooth®.....	436
Playing Media Using the USB Port.....	142
Playing or Pausing the Audio Source.....	414
Post-Crash Alert System.....	302
How Does the Post-Crash Alert System Work.....	302
Post-Crash Alert System Limitations.....	302
Switching the Post-Crash Alert System Off.....	302
What Is the Post-Crash Alert System.....	302
Power Outlet Indicators.....	144
Power Outlet.....	144
Power Outlet Precautions.....	144
Power Seats.....	129
Adjusting the Head Restraint.....	129
Adjusting the Lumbar Support.....	131
Adjusting the Seat Backrest.....	131
Adjusting the Seat Cushion.....	131
Adjusting the Seat Height.....	131
Head Restraint Components.....	129
Installing the Head Restraint.....	130

Index

Moving the Seat Backward and Forward.....	130
Removing the Head Restraint.....	130
Pre-Collision Assist Limitations.....	263
Pre-Collision Assist Precautions.....	262
Pre-Collision Assist.....	262
Automatic Emergency Braking.....	266
Distance Indication.....	264
Evasive Steering Assist.....	266
Pre-Collision Assist – Troubleshooting.....	267
Pre-Collision Assist – Troubleshooting.....	267
Pre-Collision Assist – Frequently Asked Questions.....	268
Pre-Collision Assist – Information Messages.....	267
Pre-Collision Assist – Warning Lamps.....	267
Preparing Your Vehicle for Storage.....	366
Programming a MyKey.....	75
Programming the Garage Door Opener to Your Garage Door Opener Motor.....	139
Programming the Garage Door Opener to Your Gate Opener Motor.....	140
Programming the Garage Door Opener to Your Hand-Held Transmitter.....	139
Programming the Remote Control.....	72
Properly Adjusting the Driver and Front Passenger Seats.....	62
Puncture See: Changing a Flat Tire.....	387
Push Button Ignition Switch.....	151
R	
Radio Frequency Certification Labels.....	464
Blind Spot Information System Sensors.....	464
Body Control Module.....	470
Garage Door Opener.....	473
Keys and Remote Controls.....	473
Radio Transceiver Module.....	479
SYNC.....	481
Telematics Control Unit.....	486
Tire Pressure Monitoring System Sensors.....	487
Wireless Accessory Charging Module.....	491
Rear Axle Fluid Capacity and Specification.....	406
Rear Cargo Area Anchor Points.....	280
Locating the Rear Cargo Area Anchor Points.....	280
Rear Cargo Area Anchor Point Load Capacities.....	280
Rear Cargo Area Anchor Point Precautions.....	280
Rear Cargo Area.....	280
Rear Cargo Area Anchor Points.....	280
Rear Exterior - 2-Door.....	37
Rear Exterior - 4-Door, Vehicles With: Hard Top.....	38
Rear Exterior - 4-Door, Vehicles With: Soft Top.....	39
Rear Occupant Alert System Audible Warnings.....	137
Rear Occupant Alert System Indicators.....	137
Rear Occupant Alert System Limitations.....	136
Rear Occupant Alert System Precautions.....	136
Rear Occupant Alert System.....	136
Rear Parking Aid.....	223
Locating the Rear Parking Aid Sensors.....	223
Rear Parking Aid Audible Warnings.....	223
Rear Parking Aid Limitations.....	223
What is the Rear Parking Aid.....	223
Rear Seats.....	133
Manual Seats.....	133
Rear View Camera Guide Lines.....	226
Rear View Camera Object Distance Indicators.....	227
Rear View Camera Precautions.....	226
Rear View Camera.....	226
Rear View Camera Settings.....	227
Rear View Camera Settings.....	227
Switching Rear View Camera Delay On and Off.....	228
Zooming the Rear View Camera In and Out.....	227
Recommended Shift Speeds.....	175

Index

Recovery Towing.....	303
Accessing the Front Towing Point.....	303
Accessing the Rear Towing Point.....	304
Recreationally Towing Your Vehicle - Automatic Transmission.....	307
Recreationally Towing Your Vehicle - Manual Transmission.....	306
Refueling.....	169
Manually Opening the Fuel Filler Door.....	170
Refueling System Overview.....	169
Refueling Your Vehicle.....	169
Releasing the Electric Parking Brake if the Vehicle Battery Has Run Out of Charge.....	199
Remote Control Limitations.....	69
Remotely Starting and Stopping the Vehicle.....	114
Remote Start Limitations.....	114
Remote Start Precautions.....	114
Remote Start Remote Control Indicators.....	115
Remote Start.....	114
Remote Start Settings.....	115
Remote Start Settings.....	115
Setting the Remote Start Duration.....	116
Switching Climate Control Auto Mode On and Off.....	115
Switching Climate Control Last Settings On and Off.....	115
Switching the Heated Seat Settings On and Off.....	115
Switching the Heated Steering Wheel Settings On and Off.....	115
Removable Doors.....	339
Doors and Locks Audible Warnings.....	343
Removing and Installing the Doors.....	339
Removable Fenders.....	351
Removable Fender Precautions.....	351
Removing the Fender Flares.....	351
Removable Hard Top.....	347
Removing and Installing the Hard Top.....	347
Removable Roof Panels.....	343
Removable Roof Panel Precautions.....	343
Removing and Installing the Center Roof Panel.....	344
Removing and Installing the Front Roof Panel.....	343
Removing and Installing the Rear Roof Panel.....	344
Removable Soft Top.....	348
Opening and Closing the Soft Top.....	348
Removing and Installing the Soft Top.....	350
Removable Vehicle Components.....	334
Removable Doors.....	339
Removable Fenders.....	351
Removable Hard Top.....	347
Removable Roof Panels.....	343
Removable Soft Top.....	348
Removable Windows.....	334
Removable Windows.....	334
Removable Windows Precautions.....	334
Removing and Installing the Rear Quarter Windows.....	334
Removing and Installing the Rear Window.....	337
Removing the Key Blade.....	70
Removing Your Vehicle From Storage.....	367
Repairing Minor Paint Damage.....	364
Replacement Parts Recommendation.....	495
Replacing a Lost Key or Remote Control.....	71
Replacing the Cabin Air Filter.....	125
Replacing the Front Wiper Blades.....	91
Replacing the Rear Wiper Blades.....	92
Reporting Safety Defects in Canada.....	463
Reporting Safety Defects in the United States.....	463
Reprogramming the Garage Door Opener.....	141
Restarting the Engine - Automatic Transmission.....	163
Restarting the Engine - Manual Transmission.....	162
Resuming the Set Speed.....	233
Reverse Wipe.....	90
Reverse Wipe Settings.....	90
What Is Reverse Wipe.....	90
Roadside Assistance.....	299
Rollover Warning.....	461

Index

Roof Rack.....	276	Selecting a Four-Wheel Drive Mode - 4x4 with Part Time Engagement.....	185
Adjusting a Roof Rack Crossbar.....	278	Selecting a Four-Wheel Drive Mode - Advanced 4x4 with 4A Mode.....	186
Removing and Installing the Roof Rack.....	276	Selecting a G.O.A.T. Mode.....	242
Roof Rack Load Capacities.....	278	Selecting the Audio Source.....	414
Roof Rack Precautions.....	276	Sending and Receiving a Text Message.....	434
Route Guidance.....	441	Sensitive Locking Mode.....	53
Adjusting the Guidance Prompt Volume.....	441	How Does Sensitive Locking Mode Work.....	53
Canceling Route Guidance.....	442	What is Sensitive Locking Mode.....	53
Repeating an Instruction.....	441	Service Data.....	23
Route Guidance Settings.....	442	Setting a Destination.....	440
Running-In		Setting a Destination Using a Point of Interest.....	441
See: Breaking-In.....	297	Setting a Destination Using a Predictive Destination.....	441
Running Out of Fuel.....	168	Setting a Destination Using a Recent Destination.....	441
Adding Fuel From a Portable Fuel Container.....	168	Setting a Destination Using a Saved Destination.....	441
Filling a Portable Fuel Container.....	168	Setting a Destination Using the Map Screen.....	441
S		Setting a Destination Using the Text Entry Screen.....	440
Satellite Radio.....	418	Setting a Memory Preset.....	415
Locating the Satellite Radio Identification Number.....	418	Settings Data.....	24
Satellite Radio Limitations.....	418	Setting the Adaptive Cruise Control Gap.....	238
Satellite Radio Settings.....	419	Setting the Adaptive Cruise Control Speed.....	237
Selecting a Channel.....	419	Setting the Blower Motor Speed.....	118
What Is Satellite Radio.....	418	Setting the Clock and Date.....	415
Scheduled Maintenance.....	452	Setting the Cruise Control Speed.....	232
Seatbelt Extensions.....	57	Setting the Hill Descent Speed.....	217
Seatbelt Precautions.....	52	Setting the Temperature.....	118
Seatbelt Reminder.....	54	Setting the Trail Control Speed.....	207
How Does the Seatbelt Reminder Work.....	54	Setting the Wake Word.....	428
Seatbelt Reminder Indicators.....	55	Shifting Into Reverse.....	174
Switching the Seatbelt Reminder On and Off.....	56	Shifting Your Vehicle Into Gear.....	179
Seatbelts.....	52	Sitting in the Correct Position.....	126
Automatic Locking Mode.....	54	Sounding the Panic Alarm.....	70
Seatbelt Reminder.....	54	Special Operating Conditions Scheduled Maintenance.....	457
Sensitive Locking Mode.....	53	Speed Control	
Security.....	87	See: Cruise Control.....	232
Passive Anti-Theft System.....	87	Stability Control Indicator.....	206
Security – Troubleshooting.....	87		
Security – Troubleshooting.....	87		
Security – Frequently Asked Questions.....	88		
Security – Information Messages.....	87		

Index

Stability Control.....	204	Steering – Troubleshooting.....	220
Stabilizer Bar Disconnect Indicators.....	215	Steering – Frequently Asked Questions.....	221
Stabilizer Bar Disconnect Precautions.....	214	Steering – Information Messages.....	220
Stabilizer Bar Disconnect.....	214	Steering Wheel.....	89
Stabilizer Bar Disconnect – Troubleshooting.....	215	Steering Wheel - Vehicles With: Adaptive Cruise Control.....	27
Stabilizer Bar Disconnect – Troubleshooting.....	215	Steering Wheel - Vehicles With: Cruise Control, Vehicles Without: Lane Keeping Aid.....	26
Stabilizer Bar Disconnect – Frequently Asked Questions.....	216	Steering Wheel - Vehicles With: Cruise Control/Lane Keeping Aid.....	28
Stabilizer Bar Disconnect – Information Messages.....	215	Stopping the Engine - Automatic Transmission.....	162
Starting and Stopping the Engine – Precautions.....	151	Stopping the Engine - Manual Transmission.....	161
Starting and Stopping the Engine.....	151	Stopping the Engine.....	154
Automatic Engine Stop.....	155	Stopping the Engine When Your Vehicle is Moving.....	154
Engine Block Heater.....	153	Stopping the Engine When Your Vehicle is Stationary.....	154
Starting and Stopping the Engine – Troubleshooting.....	156	Storage.....	149
Starting the Engine.....	152	Center Console.....	149
Stopping the Engine.....	154	Glasses Holder.....	150
Starting and Stopping the Engine – Troubleshooting.....	156	Glove Compartment.....	149
Starting and Stopping the Engine – Frequently Asked Questions.....	158	Map Pocket.....	150
Starting and Stopping the Engine – Information Messages.....	157	Under Floor Storage.....	150
Starting and Stopping the Engine – Warning Lamps.....	156	Storing the Doors and the Roof Panels - 4-Door.....	352
Start in Gear Limitations.....	159	Storing the Roof Panels - 2-Door.....	359
Start in Gear Precautions.....	159	Storing Your Vehicle.....	366
Start in Gear.....	159	Switching Adaptive Cruise Control On and Off.....	237
Start in Gear – Troubleshooting.....	160	Switching Air Conditioning On and Off.....	117
Start in Gear – Troubleshooting.....	160	Switching All of the Interior Lamps On and Off.....	101
Start in Gear – Frequently Asked Questions.....	160	Switching Android Auto On and Off.....	438
Start in Gear – Information Messages.....	160	Switching Apple CarPlay On and Off.....	438
Starting the Engine.....	152	Switching Auto-Start-Stop On and Off.....	161
Restarting the Engine After Stopping it.....	152	Switching Blind Spot Information System On and Off.....	257
Starting a Gasoline Engine.....	152	Switching Climate Control On and Off.....	117
Status Bar.....	425		
Steering.....	219		
Electric Power Steering.....	219		
Steering – Troubleshooting.....	220		

Index

Switching Cross Traffic Alert On and Off.....	259
Switching Cruise Control On and Off.....	232
Switching Driver Alert On and Off.....	270
Switching Four-Wheel Drive On and Off.....	184
Switching From Adaptive Cruise Control to Cruise Control.....	240
Switching Hill Descent Control On and Off.....	217
Switching Hill Start Assist On and Off - Automatic Transmission.....	201
Switching Hill Start Assist On and Off - Manual Transmission.....	201
Switching Maximum Cooling On and Off.....	117
Switching Maximum Defrost On and Off.....	117
Switching Parking Aid On and Off.....	222
Switching Pre-Collision Assist On and Off.....	264
Switching Rear Occupant Alert System On and Off.....	136
Switching Recirculated Air On and Off.....	117
Switching Repeat Mode On and Off.....	415
Switching Shuffle Mode On and Off.....	415
Switching Stability Control On and Off.....	205
Switching Text Message Notification On and Off.....	435
Switching the Audio Unit On and Off.....	414
Switching the Display On and Off.....	417
Switching the Electronic Locking Differential On and Off.....	190
Switching the Front Interior Lamps On and Off.....	101
Switching the Hazard Flashers On and Off.....	300
Switching the Heated Mirrors On and Off.....	118
Switching the Heated Rear Window On and Off.....	118
Switching the Heated Steering Wheel On and Off.....	89
Switching the Lane Keeping System Mode.....	250
Switching the Lane Keeping System On and Off.....	250
Switching the Rear Interior Lamps On and Off.....	101
Switching the Rear Window Wiper On and Off.....	90
Switching the Stabilizer Bar Disconnect On and Off.....	214
Switching Traction Control On and Off.....	202
Switching Trail Control On and Off.....	207
Switching Trailer Sway Control On and Off.....	288
Switching Trail Turn Assist On and Off.....	212
Symbols Glossary.....	19
Symbols Used on Your Vehicle.....	19
T	
Tailgate.....	84
Closing the Tailgate.....	84
Opening the Tailgate.....	84
Tailgate – Troubleshooting.....	86
Tailgate – Troubleshooting.....	86
Tailgate – Information Messages.....	86
Tailgate – Warning Lamps.....	86
Technical Specifications See: Capacities and Specifications.....	393
The Better Business Bureau Auto Line Program - United States of America.....	461
The Mediation and Arbitration Program - Canada.....	462
Tire Care.....	379
Tire Pressure Monitoring System Limitations.....	384
Tire Pressure Monitoring System Overview.....	383
Tire Pressure Monitoring System Precautions.....	384

Index

Tire Pressure Monitoring System.....	383	Trail Control – Troubleshooting.....	211
Tire Pressure Monitoring System –		Trail Control – Information Messages.....	211
Troubleshooting.....	385	Trailer Brake Precautions.....	283
Tire Pressure Monitoring System –		Trailer Sway Control Precautions.....	288
Troubleshooting.....	385	Trailer Sway Control.....	288
Tire Pressure Monitoring System –		Trailer Towing Hints.....	284
Information Messages.....	386	Trail One Pedal Drive.....	208
Tire Pressure Monitoring System – Warning		Switching Trail One Pedal Drive On and	
Lamps.....	385	Off.....	209
Tire Replacement Requirements.....	375	Trail One Pedal Drive Indicators.....	209
Tire Rotation.....	381	Trail One Pedal Drive Limitations.....	208
Towing a Trailer Limitations.....	284	Trail One Pedal Drive Precautions.....	208
Towing a Trailer Precautions.....	283	What Is Trail One Pedal Drive.....	208
Towing a Trailer.....	283	Trail One Pedal Drive –	
Towing a Trailer – Troubleshooting.....	287	Troubleshooting.....	210
Towing Weights and Dimensions.....	286	Trail One Pedal Drive – Information	
Towing a Trailer –		Messages.....	210
Troubleshooting.....	287	Trail Turn Assist Indicators.....	212
Towing a Trailer – Information		Trail Turn Assist Limitations.....	212
Messages.....	287	Trail Turn Assist Precautions.....	212
Towing Weights and Dimensions.....	286	Trail Turn Assist.....	212
Calculating the Maximum Loaded Trailer		Trail Turn Assist – Troubleshooting.....	213
Weight for Your Vehicle.....	287	Trail Turn Assist –	
Recommended Towing Weights.....	286	Troubleshooting.....	213
What Is the Maximum Loaded Trailer		Trail Turn Assist – Frequently Asked	
Weight.....	287	Questions.....	213
Towing Your Vehicle Precautions.....	306	Trail Turn Assist – Information	
Towing Your Vehicle.....	306	Messages.....	213
Towing Your Vehicle –		Transfer Case Fluid Capacity and	
Troubleshooting.....	309	Specification.....	187
Towing Your Vehicle –		Transporting the Vehicle.....	305
Troubleshooting.....	309	Trip Computer.....	113
Towing Your Vehicle – Information		Accessing the Trip Computer.....	113
Messages.....	309	Resetting the Individual Trip Values.....	113
Traction Control Indicator.....	202	Resetting the Trip Computer.....	113
Traction Control.....	202		
Traction Control – Troubleshooting.....	203	U	
Traction Control –		Under Floor Storage.....	150
Troubleshooting.....	203	Locating the Luggage Compartment Under	
Traction Control – Information		Floor Storage.....	150
Messages.....	203	Under Hood Fuse Box.....	310
Trail Control Indicators.....	208	Accessing the Under Hood Fuse Box.....	310
Trail Control Limitations.....	207	Identifying the Fuses in the Under Hood	
Trail Control.....	207	Fuse Box.....	311
Trail Control – Troubleshooting.....	211	Locating the Under Hood Fuse Box.....	310
Trail One Pedal Drive.....	208	Under Hood Overview - 2.3L	
Trail One Pedal Drive –		EcoBoost™.....	319
Troubleshooting.....	210		

Index

Under Hood Overview - 2.7L EcoBoost™.....	320
Updating the Vehicle Systems	
Wirelessly.....	443
USB Ports.....	142
Using Keyless Entry.....	82
Using MyKey With Remote Start Systems.....	76
Using Snow Chains.....	377
Using Start in Gear.....	159
Using the Instrument Cluster Display Controls.....	112
Using the Remote Control.....	69
Using This Publication.....	18
V	
Vehicle Care.....	360
Cleaning the Exterior.....	360
Cleaning the Interior.....	362
Vehicle Identification Number.....	408
Locating the Vehicle Identification Number.....	408
Vehicle Identification Number Overview.....	408
Vehicle Identification.....	408
Vehicle Identification Number.....	408
Vehicle Interior - 2-Door.....	32
Vehicle Interior - 4-Door.....	33
Vehicle System Updates.....	443
Vehicle Wi-Fi Hotspot.....	412
Ventilation	
See: Climate Control - Vehicles With: Automatic Temperature Control.....	117
See: Climate Control - Vehicles With: Manual Temperature Control.....	122
Viewing the Tire Pressures.....	385
Visual Search.....	26
Voice Interaction Examples.....	428
Voice Interaction.....	428
W	
Washer Fluid Specification.....	402
Washers.....	92
Adding Washer Fluid.....	93
Switching the Courtesy Wipe On and Off.....	93
Using the Rear Window Washer.....	93
Using the Windshield Washer.....	92
Washer Fluid Specification.....	93
Washer Precautions.....	92
Washers	
See: Wipers and Washers.....	90
Waxing Your Vehicle.....	364
Waypoints.....	441
Adding a Waypoint.....	441
Editing Waypoints.....	441
What Are the Auxiliary Switches.....	447
What Are the Instrument Cluster Indicators.....	109
What Are the Instrument Cluster Warning Lamps.....	107
What Is 911 Assist.....	68
What Is a Connected Vehicle.....	409
What Is Auto-Start-Stop.....	161
What Is Blind Spot Information System.....	256
What Is Cross Traffic Alert.....	259
What Is Cruise Control.....	232
What Is Driver Alert.....	269
What Is Ford Protect.....	450
What Is G.O.A.T. Mode Control.....	242
What Is Hill Descent Control.....	217
What Is Hill Start Assist.....	201
What Is MyKey.....	74
What Is Pre-Collision Assist.....	262
What Is Remote Start.....	114
What Is Start in Gear.....	159
What Is the 360 Degree Camera.....	229
What Is the Cabin Air Filter.....	125
What Is the Catalytic Converter.....	173
What Is the Electric Parking Brake.....	198
What Is the Electronic Locking Differential.....	190
What Is the Engine Coolant Temperature Gauge.....	107
What Is the Garage Door Opener.....	138
What Is the Gross Axle Weight Rating.....	272
What Is the Gross Combined Weight Rating.....	272
What Is the Gross Vehicle Weight Rating.....	272
What Is the Information Bar.....	107
What Is the Lane Keeping System.....	249

Index

What Is the Maximum Loaded Trailer Weight.....	272
What Is the Personal Safety System.....	58
What Is the Power Outlet.....	144
What Is the Rear Occupant Alert System.....	136
What Is the Rear View Camera.....	226
What Is the Speedometer.....	106
What Is the Stabilizer Bar Disconnect.....	214
What Is the Tachometer.....	106
What Is the Tire Pressure Monitoring System.....	383
What Is the Transmission Fluid Temperature Gauge.....	107
What Is the Turbo Boost Gauge - 2.3L EcoBoost™.....	107
What Is the Wireless Accessory Charger.....	147
What Is Traction Control.....	202
What Is Trail Control.....	207
What Is Trail Turn Assist.....	212
What is Voice Interaction.....	428
Wheel and Tire Information.....	368
Wheel Nuts.....	392
Wi-Fi	
See: Changing the Vehicle Wi-Fi Hotspot Name or Password.....	412
See: Connecting the Vehicle to a Wi-Fi Network.....	409
See: Creating a Vehicle Wi-Fi Hotspot.....	412
See: Vehicle Wi-Fi Hotspot.....	412
Window Bounce-Back.....	103
Overriding Window Bounce-Back.....	103
What Is Window Bounce-Back.....	103
Windows.....	103
Window Bounce-Back.....	103
Wipers and Washers – Troubleshooting.....	93
Wipers and Washers – Frequently Asked Questions.....	93
Wipers and Washers – Warning Lamps.....	93
Wipers and Washers.....	90
Reverse Wipe.....	90
Washers.....	92
Wipers.....	90
Wipers and Washers – Troubleshooting.....	93
Wipers.....	90
Switching Windshield Wipers On and Off.....	90
Wiper Precautions.....	90
Wireless Accessory Charger Precautions.....	147
Wireless Accessory Charger – Troubleshooting.....	148
Wireless Accessory Charger – Information Messages.....	148
Wireless Accessory Charger.....	147
Wireless Accessory Charger – Troubleshooting.....	148

