

Pictorial index	Search by illustration	
1 For safety and security	Make sure to read through them	
2 Instrument cluster	How to read the gauges and meters, the variety of warning lights and indicators, etc.	
3 Operation of each component	Opening and closing the doors and windows, adjustment before driving, etc.	
4 Driving	Operations and advice which are necessary for driving	
5 Interior features	Usage of the interior features, etc.	
6 Maintenance and care	Caring for your vehicle and maintenance procedures	
7 When trouble arises	What to do in case of malfunction or emergency	
8 Vehicle specifications	Vehicle specifications, customizable features, etc.	
9 For owners	Reporting safety defects for U.S. owners, and seat belt and SRS airbag instructions for Canadian owners	
Index	Search by symptom	
	Search alphabetically	

For your information..... 8
 Reading this manual..... 14
 How to search..... 15
 Pictorial index 16

1 For safety and security

1-1. For safe use
 Before driving 28
 For safe driving 30
 Seat belts 32
 SRS airbags 37
 Front passenger occupant
 classification system 48
 Safety information for
 children 54
 Child restraint systems 55
 Installing child restraints 59
 Exhaust gas precautions 71

1-2. Emergency assistance
 Safety Connect..... 72

1-3. Theft deterrent system
 Engine immobilizer
 system..... 78
 Alarm..... 79

2 Instrument cluster

2. Instrument cluster
 Warning lights and
 indicators..... 82
 Gauges and meters..... 88
 Multi-information display 90

3 Operation of each component

3-1. Key information
 Keys..... 102
 Side doors 106

3-2. Opening, closing and locking the doors
 Smart key system 113
 Automatic running
 boards 121
 Back door 124

3-3. Adjusting the seats
 Front seats..... 129
 Rear seats 132
 Driving position memory 142
 Head restraints 146

3-4. Adjusting the steering wheel and mirrors
 Steering wheel..... 149
 Inside rear view mirror 151
 Outside rear view
 mirrors 153

3-5. Opening, closing the windows and moon roof
 Power windows..... 155
 Power back window..... 158
 Moon roof 161

4 Driving

4-1. Before driving

Driving the vehicle.....	166
Cargo and luggage.....	176
Vehicle load limits	181
Trailer towing.....	182
Dinghy towing.....	198

4-2. Driving procedures

Engine (ignition) switch	199
Automatic transmission	205
Turn signal lever.....	210
Parking brake	211

4-3. Operating the lights and wipers

Headlight switch	212
AHB (Automatic High Beam)	217
Fog light switch	221
Windshield wipers and washer	223
Rear window wiper and washer	226

4-4. Refueling

Opening the fuel tank cap	229
---------------------------------	-----

4-5. Using the driving support systems

Toyota Safety Sense P.....	232
PCS (Pre-Collision System)	239
LDA (Lane Departure Alert).....	249
Dynamic radar cruise control.....	257
BSM (Blind Spot Monitor)	270
Intuitive parking assist	277
RCTA (Rear Cross Traffic Alert).....	286
Four-wheel drive system (part-time 4WD models).....	294
Four-wheel drive system (full-time 4WD models).....	298
Active traction control system	302
AUTO LSD system (2WD models)	304
Rear differential lock system	306
Downhill assist control system	309
Crawl Control.....	312
Multi-terrain Select.....	315
Driving assist systems	322
4-6. Driving tips	
Winter driving tips	331
Off-road precautions.....	335

5 Interior features

5-1. Using the air conditioning system and defogger

Manual air conditioning system.....	342
Automatic air conditioning system.....	349
Heated steering wheel/ Seat heaters/ seat ventilators.....	357

5-2. Using the interior lights

Interior lights list	360
• Interior lights	361
• Personal lights	361

5-3. Using the storage features

List of storage features.....	363
• Glove box.....	364
• Console box.....	364
• Cup holders	365
• Auxiliary box	367
• Coin holder/ tissue pocket/ pen holder.....	368
• Bottle holders.....	369
Luggage compartment features	370

5-4. Other interior features

Other interior features.....	375
• Sun visors	375
• Vanity mirrors	375
• Clock	376
• Power outlets (120 V AC)	377
• Power outlets	381
• USB charging ports	384
• Armrest.....	386
• Assist grips	386
Garage door opener	387

6 Maintenance and care

- 6-1. Maintenance and care**
- Cleaning and protecting the vehicle exterior 396
 - Cleaning and protecting the vehicle interior 400
- 6-2. Maintenance**
- Maintenance requirements 403
 - General maintenance 405
 - Emission inspection and maintenance (I/M) programs 408
- 6-3. Do-it-yourself maintenance**
- Do-it-yourself service precautions 409
 - Hood 412
 - Engine compartment 413
 - Tires 427
 - Tire inflation pressure 440
 - Wheels 443
 - Air conditioning filter 445
 - Electronic key battery 447
 - Checking and replacing fuses 450
 - Light bulbs 453

7 When trouble arises

- 7-1. Essential information**
- Emergency flashers 466
 - If your vehicle has to be stopped in an emergency 467
 - If the vehicle is submerged or water on the road is rising 468
- 7-2. Steps to take in an emergency**
- If your vehicle needs to be towed 469
 - If you think something is wrong 475
 - Fuel pump shut off system 476
 - If a warning light turns on or a warning buzzer sounds 477
 - If a warning message is displayed 488
 - If you have a flat tire 493
 - If the engine will not start 509
 - If you cannot operate back door opener 511
 - If the electronic key does not operate properly 512
 - If the vehicle battery is discharged 515
 - If your vehicle overheats 519
 - If the vehicle becomes stuck 522

8 Vehicle specifications

8-1. Specifications
 Maintenance data
 (fuel, oil level, etc.) 524
 Fuel information 534
 Tire information 537

8-2. Customization
 Customizable features 549

8-3. Items to initialize
 Items to initialize..... 562

9 For owners

Reporting safety defects
 for U.S. owners 564

Reporting safety defects
 for Canadian owners 565

Seat belt instructions
 for Canadian owners
 (in French)..... 566

SRS airbag instructions
 for Canadian owners
 (in French)..... 568

Index

What to do if...
(Troubleshooting) 578
Alphabetical index..... 582

1

2

3

4

5

6

7

8

9

For vehicles with a audio/navigation system, refer to the “NAVIGATION AND MULTIMEDIA SYSTEM OWNER’S MANUAL” for information regarding the audio/navigation system.

For your information

Main Owner's Manual

Please note that this manual applies to all models and explains all equipment, including options. Therefore, you may find explanations for equipment not installed on your vehicle and the illustrations used may differ from your vehicle.

All specifications provided in this manual are current at the time of printing. Over time, your vehicle may receive updates that modify the vehicle and make material in this manual incomplete and/or inaccurate. Because of Toyota's interest in continual product improvement, Toyota reserves the right to make changes to this manual at any time without notice.

If Toyota chooses to update the manual, updated versions can be viewed by selecting your vehicle by model and year at the following URL or on your mobile device if you have access to the Toyota app.

www.toyota.com/owners

Noise from under vehicle after turning off the engine

Approximately five hours after the engine is turned off, you may hear sound coming from under the vehicle for several minutes. This is the sound of a fuel evaporation leakage check and, it does not indicate a malfunction.

Accessories, spare parts and modification of your Toyota

A wide variety of non-genuine spare parts and accessories for Toyota vehicles are currently available in the market. You should know that Toyota does not warrant these products and is not responsible for their performance, repair, or replacement, or for any damage they may cause to, or adverse effect they may have on, your Toyota vehicle.

This vehicle should not be modified with non-genuine Toyota products. Modification with non-genuine Toyota products could affect its performance, safety or durability, and may even violate governmental regulations. In addition, damage or performance problems resulting from the modification may not be covered under warranty.

Also, remodeling like this will have an effect on advanced safety equipment such as Toyota Safety Sense P and there is a danger that it will not work properly or the danger that it may work in situations where it should not be working.

Installation of a mobile two-way radio system

The installation of a mobile two-way radio system in your vehicle could affect electronic systems such as:

- Multiport fuel injection system/sequential multiport fuel injection system
- Toyota Safety Sense P
- Anti-lock brake system
- SRS airbag system
- Seat belt pretensioner system

Be sure to check with your Toyota dealer for precautionary measures or special instructions regarding installation of a mobile two-way radio system.

Vehicle data recording

The vehicle is equipped with sophisticated computers that will record certain data, such as:

- Engine speed/Electric motor speed (traction motor speed)
- Accelerator status
- Brake status
- Vehicle speed
- Operation status of the driving assist systems
- Images from the cameras

Your vehicle is equipped with cameras. Contact your Toyota dealer for the location of recording cameras.

The recorded data varies according to the vehicle grade level and options with which it is equipped.

These computers do not record conversations or sounds, and only record images outside of the vehicle in certain situations.

- Data Transmission

Your vehicle may transmit the data recorded in these computers to Toyota without notification to you.

- Data usage

Toyota may use the data recorded in this computer to diagnose malfunctions, conduct research and development, and improve quality.

Toyota will not disclose the recorded data to a third party except:

- With the consent of the vehicle owner or with the consent of the lessee if the vehicle is leased
- In response to an official request by the police, a court of law or a government agency
- For use by Toyota in a lawsuit
- For research purposes where the data is not tied to a specific vehicle or vehicle owner

- Recorded image information can be erased by your Toyota dealer.

The image recording function can be disabled. However, if the function is disabled, data from when the system operates will not be available.

- To learn more about the vehicle data collected, used and shared by Toyota, please visit www.toyota.com/privacyvts/.

Usage of data collected through Safety Connect (U.S. mainland only)

If your Toyota has Safety Connect and if you have subscribed to those services, please refer to the Safety Connect Telematics Subscription Service Agreement for information on data collected and its usage.

- To learn more about the vehicle data collected, used and shared by Toyota, please visit www.toyota.com/privacyvts/.

Event data recorder

This vehicle is equipped with an event data recorder (EDR). The main purpose of an EDR is to record, in certain crash or near crash-like situations, such as an air bag deployment or hitting a road obstacle, data that will assist in understanding how a vehicle's systems performed. The EDR is designed to record data related to vehicle dynamics and safety systems for a short period of time, typically 30 seconds or less.

The EDR in this vehicle is designed to record such data as:

- How various systems in your vehicle were operating;
- Whether or not the driver and passenger safety belts were buckled/fastened;
- How far (if at all) the driver was depressing the accelerator and/or brake pedal; and,
- How fast the vehicle was traveling.

These data can help provide a better understanding of the circumstances in which crashes and injuries occur.

NOTE: EDR data are recorded by your vehicle only if a non-trivial crash situation occurs; no data are recorded by the EDR under normal driving conditions and no personal data (e.g., name, gender, age, and crash location) are recorded. However, other parties, such as law enforcement, could combine the EDR data with the type of personally identifying data routinely acquired during a crash investigation.

To read data recorded by an EDR, special equipment is required, and access to the vehicle or the EDR is needed. In addition to the vehicle manufacturer, other parties, such as law enforcement, that have the special equipment, can read the information if they have access to the vehicle or the EDR.

- Disclosure of the EDR data

Toyota will not disclose the data recorded in an EDR to a third party except when:

- An agreement from the vehicle's owner (or the lessee for a leased vehicle) is obtained
- In response to an official request by the police, a court of law or a government agency
- For use by Toyota in a lawsuit

However, if necessary, Toyota may:

- Use the data for research on vehicle safety performance
- Disclose the data to a third party for research purposes without disclosing information about the specific vehicle or vehicle owner

Scrapping of your Toyota

The SRS airbag and seat belt pretensioner devices in your Toyota contain explosive chemicals. If the vehicle is scrapped with the airbags and seat belt pretensioners left as they are, this may cause an accident such as fire. Be sure to have the systems of the SRS airbag and seat belt pretensioner removed and disposed of by a qualified service shop or by your Toyota dealer before you scrap your vehicle.

Perchlorate Material

Special handling may apply, See www.dtsc.ca.gov/hazardouswaste/perchlorate.

Your vehicle has components that may contain perchlorate. These components may include airbag, seat belt pretensioners, and wireless remote control batteries.

“QR code”

The word “QR Code” is registered trademark of DENSO WAVE INCORPORATED in Japan and other countries.

 **WARNING****■ General precautions while driving**

Driving under the influence: Never drive your vehicle when under the influence of alcohol or drugs that have impaired your ability to operate your vehicle. Alcohol and certain drugs delay reaction time, impair judgment and reduce coordination, which could lead to an accident that could result in death or serious injury.

Defensive driving: Always drive defensively. Anticipate mistakes that other drivers or pedestrians might make and be ready to avoid accidents.

Driver distraction: Always give your full attention to driving. Anything that distracts the driver, such as adjusting controls, talking on a cellular phone or reading can result in a collision with resulting death or serious injury to you, your occupants or others.

■ General precaution regarding children's safety

Never leave children unattended in the vehicle, and never allow children to have or use the key.

Children may be able to start the vehicle or shift the vehicle into neutral. There is also a danger that children may injure themselves by playing with the windows, the moon roof, or other features of the vehicle. In addition, heat build-up or extremely cold temperatures inside the vehicle can be fatal to children.

Reading this manual



WARNING:

Explains something that, if not obeyed, could cause death or serious injury to people.



NOTICE:

Explains something that, if not obeyed, could cause damage to or a malfunction in the vehicle or its equipment.

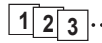

Indicates operating or working procedures. Follow the steps in numerical order.



Indicates the action (pushing, turning, etc.) used to operate switches and other devices.



Indicates the outcome of an operation (e.g. a lid opens).



Indicates the component or position being explained.



Means “Do not”, “Do not do this”, or “Do not let this happen”.

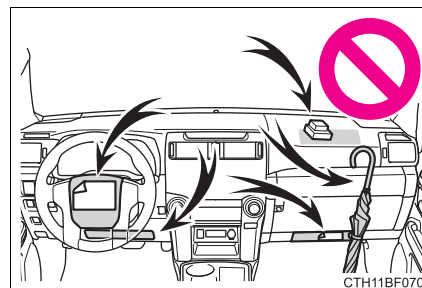
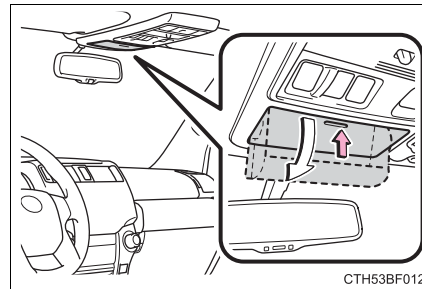

How to search

■ Searching by name

- Alphabetical index.....P. 582

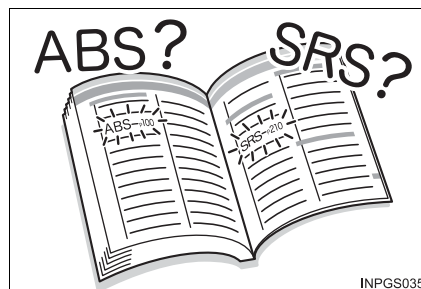

■ Searching by installation position

- Pictorial index.....P. 16

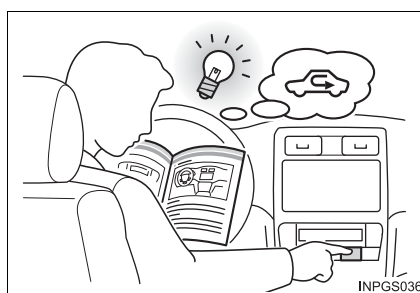

■ Searching by symptom or sound

- What to do if...
(Troubleshooting).....P. 578



■ Searching by title

- Table of contents.....P. 2

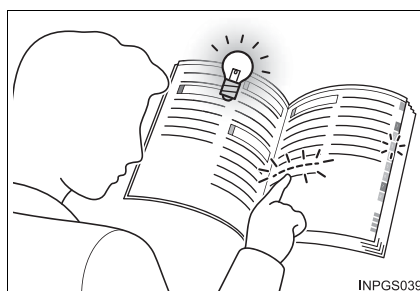

Pictorial index

Exterior

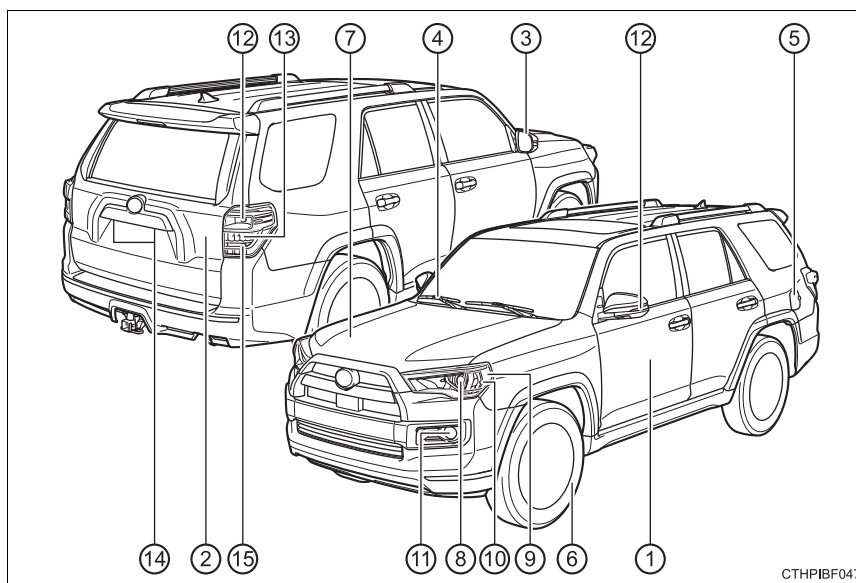

- ① **Side doors** **P. 106**
 - Locking/unlocking P. 106
 - Opening/closing the door glasses P. 155
 - Locking/unlocking by using the mechanical key P. 512
 - Warning lights/warning messages P. 479, 488
- ② **Back door** **P. 124**
 - Locking/unlocking P. 124
 - Opening/closing the door glasses P. 158
 - Warning lights/warning messages P. 479, 488
- ③ **Outside rear view mirrors** **P. 153**
 - Adjusting the mirror angle P. 153
 - Folding the mirrors P. 153
 - Defogging the mirrors P. 344, 351
- ④ **Windshield wipers** **P. 223**
 - Precautions against winter season P. 331
- ⑤ **Fuel filler door** **P. 229**
 - Refueling method P. 229
 - Fuel type/fuel tank capacity P. 526

- ⑥ **Tires** **P. 427**
 - Tire size/inflation pressure P. 532
 - Winter tires/tire chain P. 331
 - Checking/rotation/tire pressure warning system P. 427
 - Coping with flat tires P. 493
- ⑦ **Hood** **P. 412**
 - Opening P. 412
 - Engine oil P. 527
 - Coping with overheat P. 519

Light bulbs of the exterior lights for driving

(Replacing method: P. 453, Wattages: P. 533)

- ⑧ **Headlights/daytime running lights** **P. 212**
- ⑨ **Front side marker lights** **P. 212**
- ⑩ **Front turn signal/parking lights** **P. 212**
- ⑪ **Fog lights** **P. 221**
- ⑫ **Turn signal lights** **P. 210**
- ⑬ **Stop/tail lights/rear side marker lights** **P. 212**
- ⑭ **License plate lights** **P. 212**
- ⑮ **Back-up lights**
 - Shifting the shift lever to R. P. 205

Instrument panel

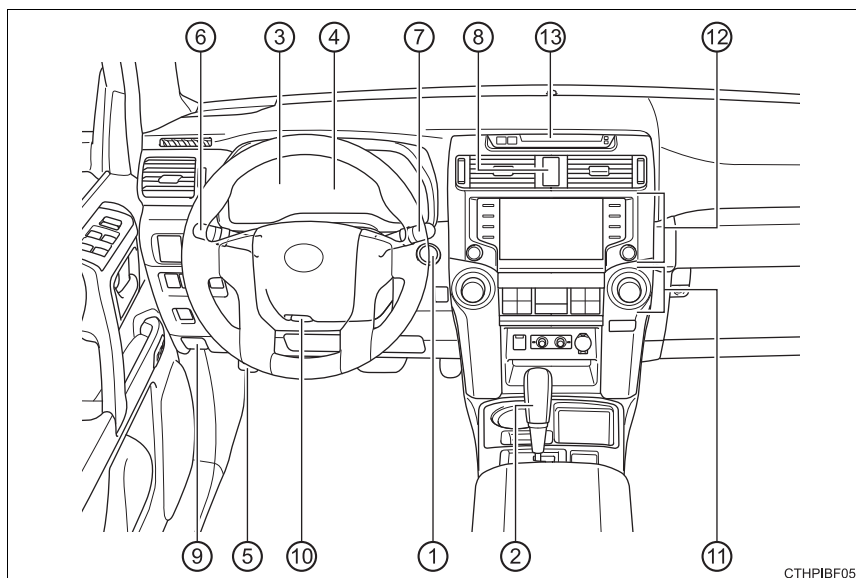

CTHPIBF050

①	Engine switch	P. 199
	Starting the engine/changing the modes	P. 199
	Emergency stop of the engine	P. 467
	When the engine will not start	P. 509
	Warning messages	P. 488
②	Shift lever	P. 205
	Changing the shift position	P. 205
	Precautions against towing	P. 469
	When the shift lever does not move	P. 208
③	Meters	P. 88
	Reading the meters	P. 88
	Warning lights/indicator lights	P. 82
	When the warning lights come on	P. 477

- ④ **Multi-information display P. 90**
 - Display P. 90
 - When the warning messages are displayed P. 488
- ⑤ **Parking brake P. 211**
 - Applying/releasing P. 211
 - Precautions against winter season P. 332
 - Warning buzzer/message P. 477, 488
- ⑥ **Turn signal lever P. 210**
 - Headlight switch P. 212
 - Headlights/parking lights/tail lights/daytime running lights. P. 212
 - Fog lights P. 221
- ⑦ **Windshield wiper and washer switch P. 223**
 - Usage P. 223
 - Adding washer fluid P. 425
- ⑧ **Emergency flasher switch P. 466**
- ⑨ **Hood lock release lever. P. 412**
- ⑩ **Tilt and telescopic steering lock release lever P. 149**
- ⑪ **Air conditioning system P. 342, 349**
 - Usage P. 342, 349
 - Rear window defogger. P. 344, 351
- ⑫ **Audio/Navigation system***
- ⑬ **Clock. P. 376**

*: Refer to "NAVIGATION AND MULTIMEDIA SYSTEM OWNER'S MANUAL".

■ Switches

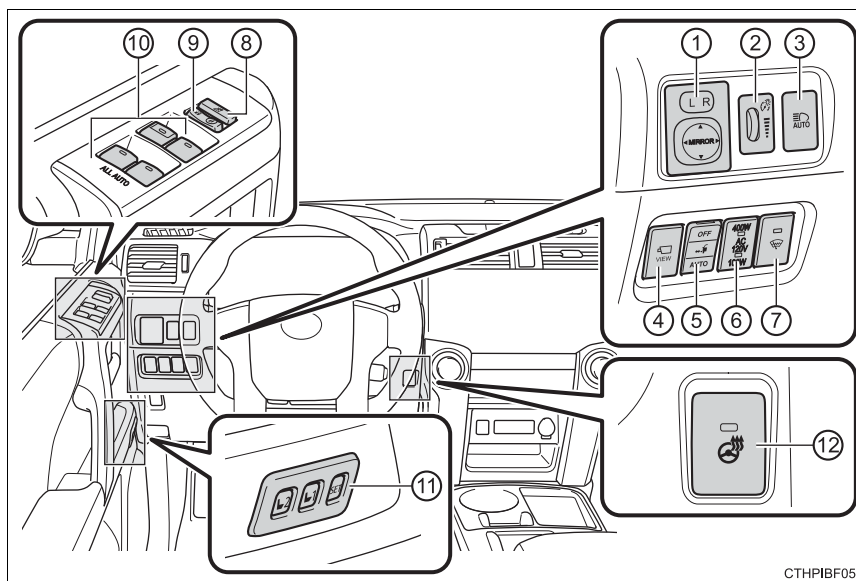

CTHPIBF052

- ① Outside rear view mirror switches P. 153
- ② Instrument panel light control dial P. 89
- ③ Automatic High Beam switch P. 217
- ④ VIEW switch*1, 2
- ⑤ Automatic running boards switch*1 P. 121
- ⑥ Power outlet main switch*1 P. 377
- ⑦ Windshield wiper de-icer switch*1 P. 344, 352
- ⑧ Window lock switch P. 155
- ⑨ Door lock switches P. 108
- ⑩ Power window switches P. 155
- ⑪ Driving position memory switches*1 P. 142
- ⑫ Heated steering wheel*1 P. 357

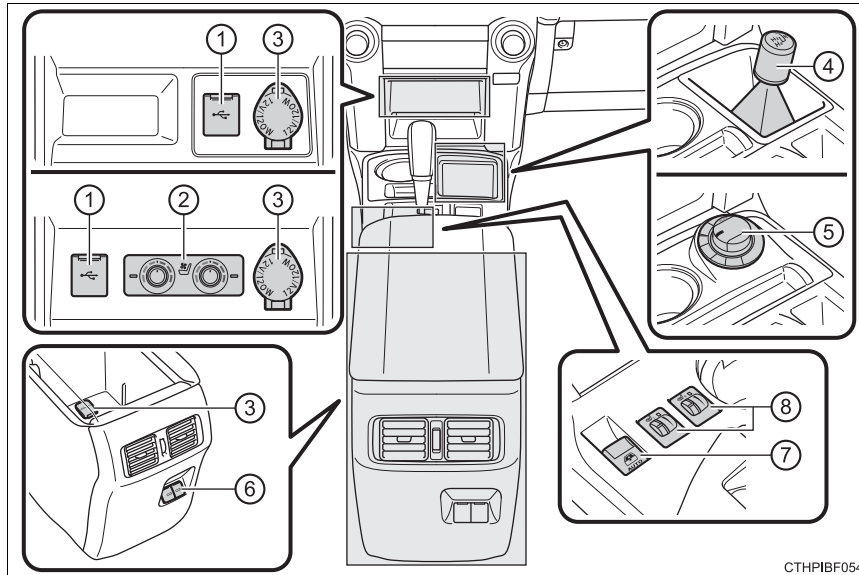

- ① USB port*2
- ② Seat heater/ventilator switches*1 P. 357
- ③ Power outlets P. 381
- ④ Front-wheel drive control lever*1 P. 294
- ⑤ Front-wheel drive control switch*1 P. 294
- Four-wheel drive control switch*1 P. 298
- ⑥ USB charging ports P. 384
- ⑦ Power back window switch P. 158
- ⑧ Seat heater switches*1 P. 357

*1: If equipped

*2: Refer to "NAVIGATION AND MULTIMEDIA SYSTEM OWNER'S MANUAL".

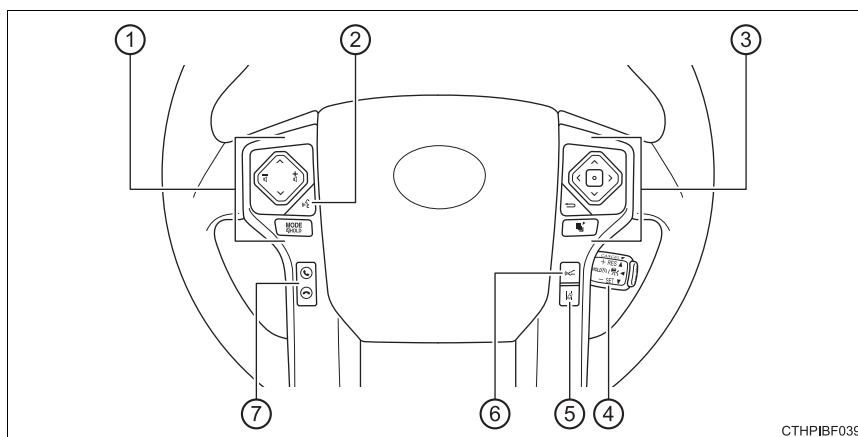

- ① **Audio remote control switches***
- ② **Talk switch***
- ③ **Meter control switches P. 91**
- ④ **Cruise control switch**
Dynamic radar cruise control P. 257
- ⑤ **LDA (Lane Departure Alert) switch. P. 249**
- ⑥ **Vehicle-to-vehicle distance switch. P. 264**
- ⑦ **Telephone switches***

Interior

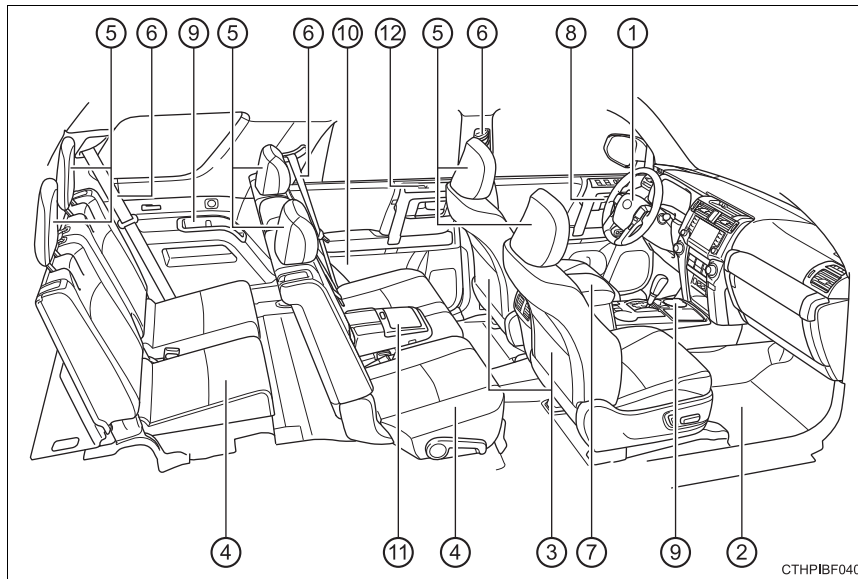

- | | |
|-----------------------------------|-------------|
| ① SRS airbags | P. 37 |
| ② Floor mat | P. 28 |
| ③ Front seats | P. 129 |
| ④ Rear seats | P. 132 |
| ⑤ Head restraints | P. 146 |
| ⑥ Seat belts | P. 32 |
| ⑦ Console box/tissue pocket | P. 364, 368 |
| ⑧ Inside lock buttons | P. 108 |
| ⑨ Cup holders | P. 365 |
| ⑩ Bottle holders | P. 369 |
| ⑪ Armrest/cup holders | P. 365, 386 |
| ⑫ Power window switches | P. 155 |

*: Refer to "NAVIGATION AND MULTIMEDIA SYSTEM OWNER'S MANUAL".

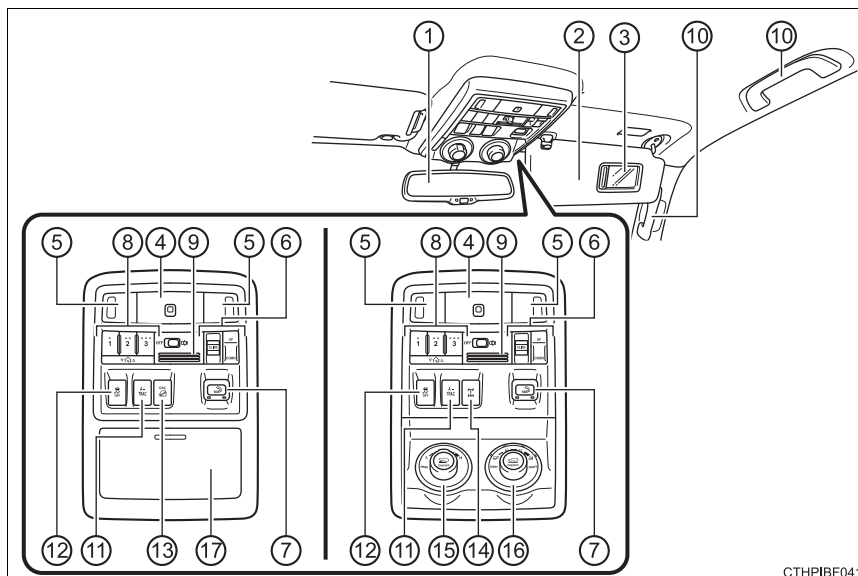

CTHPIBF041

- ① Inside rear view mirror P. 151
- ② Sun visors P. 375
- ③ Vanity mirrors P. 375
- ④ Interior light*2 P. 361
- ⑤ Personal lights P. 361
- ⑥ Moon roof switches*1 P. 161
- ⑦ “SOS” button*1 P. 72
- ⑧ Garage door opener switches*1 P. 387
- ⑨ Microphone*3
- ⑩ Assist grips P. 386
- ⑪ Active traction control switch*1 P. 302
- ⑫ VSC off switch P. 324
- ⑬ DAC switch*1 P. 309
- ⑭ Rear differential lock switch*1 P. 306
- ⑮ Crawl Control switch*1 P. 312
- ⑯ Multi-terrain Select switch*1 P. 315
- ⑰ Auxiliary box*1 P. 367

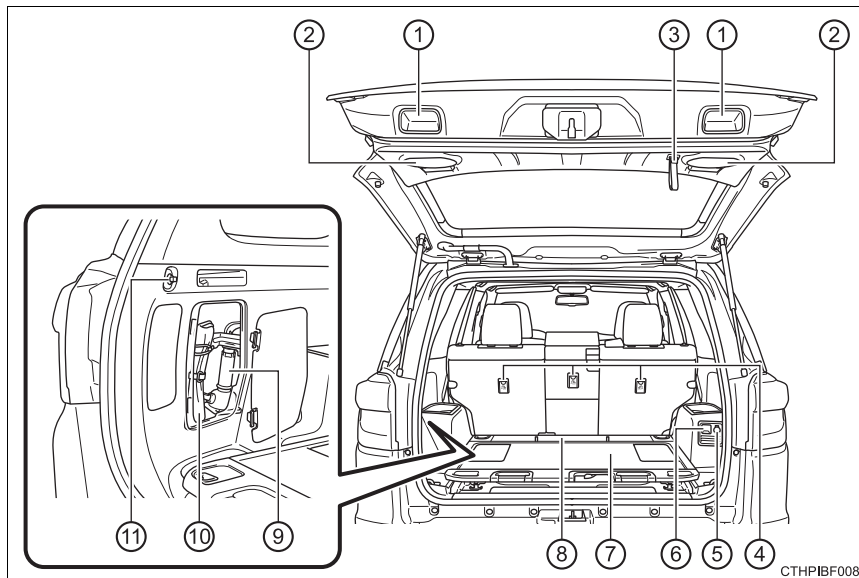

- ① **Back door handles** P. 125
- ② **Luggage compartment lights** P. 126
- ③ **Back door strap** P. 125
- ④ **Child restraint anchor brackets** P. 59
- ⑤ **Power outlets** P. 381
- ⑥ **Power outlets (120 V AC)** P. 377
- ⑦ **Slide deck^{*1}** P. 373
- ⑧ **Storage compartment^{*1}** P. 372
- ⑨ **Jack** P. 493
- ⑩ **Tool bag** P. 493
- ⑪ **Cargo net hooks/Grocery bag hooks** P. 371, 373

^{*1}: If equipped

^{*2}: The illustration shows the front, but they are also equipped in the rear.

^{*3}: Refer to "NAVIGATION AND MULTIMEDIA SYSTEM OWNER'S MANUAL".

For safety and security

1

27

1-1. For safe use

Before driving.....	28
For safe driving	30
Seat belts	32
SRS airbags.....	37
Front passenger occupant classification system	48
Safety information for children	54
Child restraint systems.....	55
Installing child restraints.....	59
Exhaust gas precautions.....	71

1-2. Emergency assistance

Safety Connect	72
----------------------	----

1-3. Theft deterrent system

Engine immobilizer system	78
Alarm.....	79

Before driving

Floor mat

Use only floor mats designed specifically for vehicles of the same model and model year as your vehicle. Fix them securely in place onto the carpet.

- 1 Insert the retaining hooks (clips) into the floor mat eyelets.

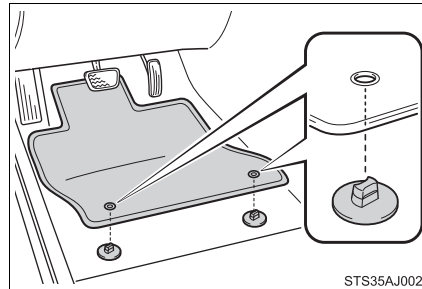

- 2 Turn the upper knob of each retaining hook (clip) to secure the floor mats in place.

*: Always align the \triangle marks.

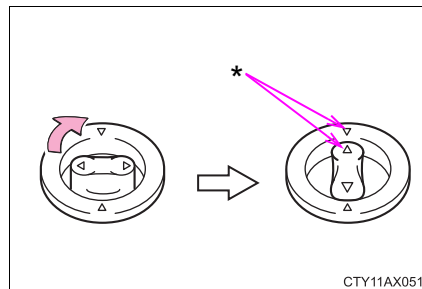

The shape of the retaining hooks (clips) may differ from that shown in the illustration.

⚠ WARNING

Observe the following precautions.

Failure to do so may cause the driver's floor mat to slip, possibly interfering with the pedals while driving. An unexpectedly high speed may result or it may become difficult to stop the vehicle. This could lead to an accident, resulting in death or serious injury.

■ When installing the driver's floor mat

- Do not use floor mats designed for other models or different model year vehicles, even if they are Toyota Genuine floor mats.
- Only use floor mats designed for the driver's seat.
- Always install the floor mat securely using the retaining hooks (clips) provided.
- Do not use two or more floor mats on top of each other.
- Do not place the floor mat bottom-side up or upside-down.

■ Before driving

- Check that the floor mat is securely fixed in the correct place with all the provided retaining hooks (clips). Be especially careful to perform this check after cleaning the floor.
- With the engine stopped and the shift lever in P, fully depress each pedal to the floor to make sure it does not interfere with the floor mat.

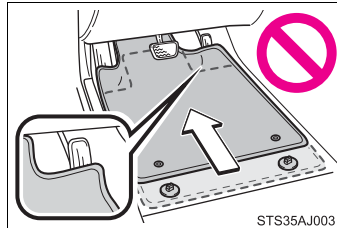

For safe driving

For safe driving, adjust the seat and mirror to an appropriate position before driving.

Correct driving posture

- ① Adjust the angle of the seat-back so that you are sitting straight up and so that you do not have to lean forward to steer. (→P. 129)
- ② Adjust the seat so that you can depress the pedals fully and so that your arms bend slightly at the elbow when gripping the steering wheel. (→P. 129)
- ③ Adjust the tilt and telescopic positions of the steering wheel downward so the airbag is facing your chest. (→P. 149)
- ④ Lock the head restraint in place with the center of the head restraint closest to the top of your ears. (→P. 146)
- ⑤ Wear the seat belt correctly. (→P. 32)

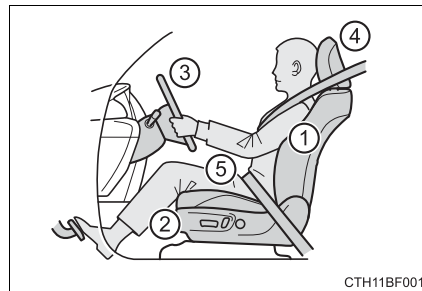

Correct use of the seat belts

Make sure that all occupants are wearing their seat belts before driving the vehicle. (→P. 32)

Use a child restraint system appropriate for the child until the child becomes large enough to properly wear the vehicle's seat belt. (→P. 55)

Adjusting the mirrors

Make sure that you can see backward clearly by adjusting the inside and outside rear view mirrors properly. (→P. 151, 153)

WARNING

Observe the following precautions.

Failure to do so may result in death or serious injury.

- Do not adjust the position of the driver's seat while driving.
Doing so could cause the driver to lose control of the vehicle.
- Do not place a cushion between the driver or passenger and the seatback.
A cushion may prevent correct posture from being achieved, and reduce the effectiveness of the seat belt and head restraint.
- Do not place anything under the front seats.
Objects placed under the front seats may become jammed in the seat tracks and stop the seat from locking in place. This may lead to an accident and the adjustment mechanism may also be damaged.
- Always observe the legal speed limit when driving on public roads.
- When driving over long distances, take regular breaks before you start to feel tired.
Also, if you feel tired or sleepy while driving, do not force yourself to continue driving and take a break immediately.

Seat belts

Make sure that all occupants are wearing their seat belts before driving the vehicle.

Correct use of the seat belts

- Extend the shoulder belt so that it comes fully over the shoulder, but does not come into contact with the neck or slide off the shoulder.
- Position the lap belt as low as possible over the hips.
- Adjust the position of the seat-back. Sit up straight and well back in the seat.
- Do not twist the seat belt.

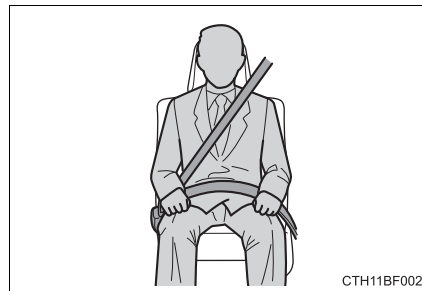

Fastening and releasing the seat belt

- ① To fasten the seat belt, push the plate into the buckle until a click sound is heard.
- ② To release the seat belt, press the release button.

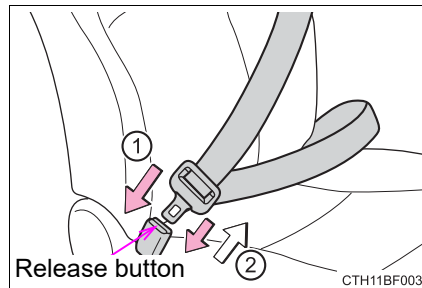

Adjusting the seat belt shoulder anchor height (front seats)

- ① Push the seat belt shoulder anchor down while pressing the release button.
- ② Push the seat belt shoulder anchor up.

Move the height adjuster up and down as needed until you hear a click.

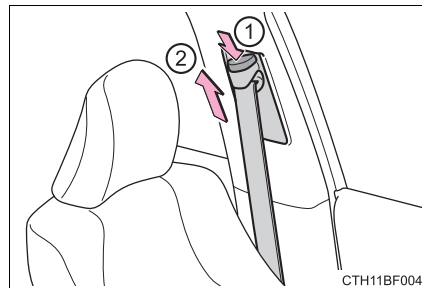

Seat belt pretensioners (front seats)

The pretensioners help the seat belts to quickly restrain the occupants by retracting the seat belts when the vehicle is subjected to certain types of severe frontal or side collision or a vehicle rollover.

The pretensioners do not activate in the event of a minor frontal impact, a minor side impact or a rear impact.

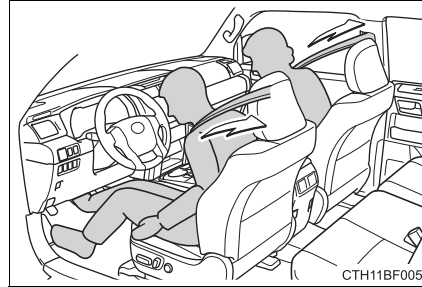

■ Emergency locking retractor (ELR)

The retractor will lock the belt during a sudden stop or on impact. It may also lock if you lean forward too quickly. A slow, easy motion will allow the belt to extend so that you can move around fully.

■ Automatic locking retractor (ALR)

When a passenger's shoulder belt is completely extended and then retracted even slightly, the belt is locked in that position and cannot be extended. This feature is used to hold the child restraint system (CRS) firmly. To free the belt again, fully retract the belt and then pull the belt out once more. (→P. 59)

■ Child seat belt usage

The seat belts of your vehicle were principally designed for persons of adult size.

- Use a child restraint system appropriate for the child, until the child becomes large enough to properly wear the vehicle's seat belt. (→P. 55)
- When the child becomes large enough to properly wear the vehicle's seat belt, follow the instructions regarding seat belt usage. (→P. 32)

■ Replacing the belt after the pretensioner has been activated

If the vehicle is involved in multiple collisions, the pretensioner will activate for the first collision, but will not activate for the second or subsequent collisions.

■ Seat belt extender

If your seat belts cannot be fastened securely because they are not long enough, a personalized seat belt extender is available from your Toyota dealer free of charge.

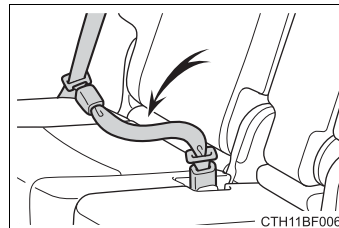

⚠ WARNING

Observe the following precautions to reduce the risk of injury in the event of sudden braking, sudden swerving or an accident. Failure to do so may cause death or serious injury.

■ Wearing a seat belt

- Ensure that all passengers wear a seat belt.
- Always wear a seat belt properly.
- Each seat belt should be used by one person only. Do not use a seat belt for more than one person at once, including children.
- Toyota recommends that children be seated in the rear seat and always use a seat belt and/or an appropriate child restraint system.
- To achieve a proper seating position, do not recline the seat more than necessary. The seat belt is most effective when the occupants are sitting up straight and well back in the seats.
- Do not wear the shoulder belt under your arm.
- Always wear your seat belt low and snug across your hips.

■ Pregnant women

Obtain medical advice and wear the seat belt in the proper way. (→P. 32)

Women who are pregnant should position the lap belt as low as possible over the hips in the same manner as other occupants, extending the shoulder belt completely over the shoulder and avoiding belt contact with the rounding of the abdominal area.

If the seat belt is not worn properly, not only the pregnant woman, but also the fetus could suffer death or serious injury as a result of sudden braking or a collision.

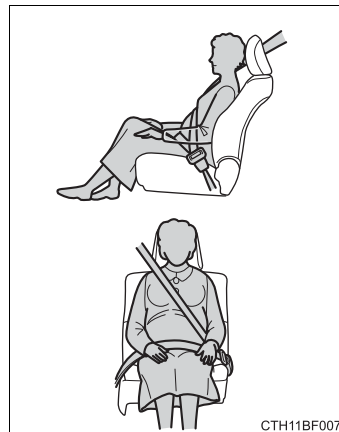

 **WARNING****■ People suffering illness**

Obtain medical advice and wear the seat belt in the proper way. (→P. 32)

■ When children are in the vehicle

Do not allow children to play with the seat belt. If the seat belt becomes twisted around a child's neck, it may lead to choking or other serious injuries that could result in death.

If this occurs and the buckle cannot be unfastened, scissors should be used to cut the belt.

■ Seat belt pretensioners

- Do not place anything, such as a cushion, on the front passenger's seat. Doing so will disperse the passenger's weight, which prevents the sensor from detecting the passenger's weight properly. As a result, the seat belt pretensioner for the front passenger's seat may not activate in the event of a collision.
- If the pretensioner has activated, the SRS warning light will come on. In that case, the seat belt cannot be used again and must be replaced at your Toyota dealer.

■ Adjustable shoulder anchor

Always make sure the shoulder belt is positioned across the center of your shoulder. The belt should be kept away from your neck, but not falling off your shoulder. Failure to do so could reduce the amount of protection in an accident and cause death or serious injuries in the event of a sudden stop, sudden swerve or accident. (→P. 32)

 WARNING**■ Seat belt damage and wear**

- Do not damage the seat belts by allowing the belt, plate, or buckle to be jammed in the door.
- Inspect the seat belt system periodically. Check for cuts, fraying, and loose parts. Do not use a damaged seat belt until it is replaced. Damaged seat belts cannot protect an occupant from death or serious injury.
- Ensure that the belt and plate are locked and the belt is not twisted. If the seat belt does not function correctly, immediately contact your Toyota dealer.
- Replace the seat assembly, including the belts, if your vehicle has been involved in a serious accident, even if there is no obvious damage.
- Do not attempt to install, remove, modify, disassemble or dispose of the seat belts. Have any necessary repairs carried out by your Toyota dealer. Inappropriate handling may lead to incorrect operation.

■ Using a seat belt extender

- Do not wear the seat belt extender if you can fasten the seat belt without the extender.
- Do not use the seat belt extender when installing a child restraint system because the belt will not securely hold the child restraint system, increasing the risk of death or serious injury in the event of an accident.
- The personalized extender may not be safe on another vehicle, when used by another person, or at a different seating position other than the one originally intended.

 NOTICE**■ When using a seat belt extender**

When releasing the seat belt, press on the buckle release button on the extender, not on the seat belt.
This helps prevent damage to the vehicle interior and the extender itself.

SRS airbags

The SRS airbags inflate when the vehicle is subjected to certain types of severe impacts that may cause significant injury to the occupants. They work together with the seat belts to help reduce the risk of death or serious injury.

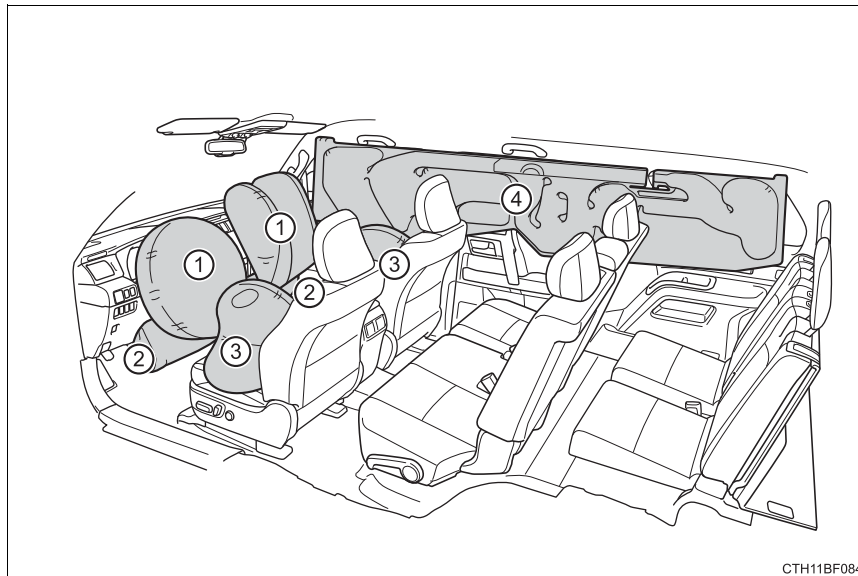

◆ SRS front airbags

- ① SRS driver airbag/front passenger airbag
Can help protect the head and chest of the driver and front passenger from impact with interior components
- ② SRS knee airbags
Can help provide driver and front passenger protection

◆ SRS side and curtain shield airbags

- ③ SRS side airbags
Can help protect the torso of the front seat occupants
- ④ SRS curtain shield airbags
 - Can help protect primarily the head of occupants in the outer seats
 - Can help prevent the occupants from being thrown from the vehicle in the event of vehicle rollover

SRS airbag system components

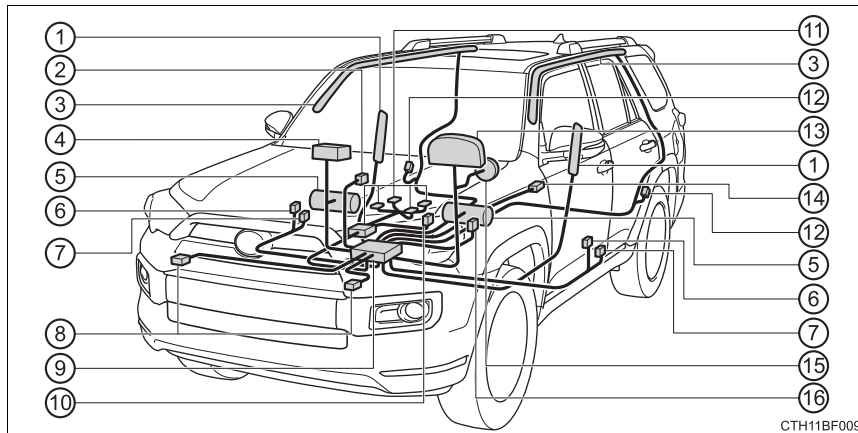

- | | |
|---|--|
| ① Side airbags | ⑩ Front passenger's seat belt buckle switch |
| ② "AIR BAG ON" and "AIR BAG OFF" indicator lights | ⑪ Front passenger occupant classification system (ECU and sensors) |
| ③ Curtain shield airbags | ⑫ Side impact sensors (rear) |
| ④ Front passenger airbag | ⑬ SRS warning light |
| ⑤ Knee airbags | ⑭ Safing sensor (rear) |
| ⑥ Side impact sensors (front door) | ⑮ Driver airbag |
| ⑦ Seat belt pretensioners and force limiters | ⑯ Driver's seat belt buckle switch |
| ⑧ Front impact sensors | |
| ⑨ Airbag sensor assembly | |

Your vehicle is equipped with ADVANCED AIRBAGS designed based on the US motor vehicle safety standards (FMVSS208). The airbag sensor assembly (ECU) controls airbag deployment based on information obtained from the sensors etc. shown in the system components diagram above. This information includes crash severity and occupant information. As the airbags deploy, a chemical reaction in the inflators quickly fills the airbags with non-toxic gas to help restrain the motion of the occupants.

 **WARNING**

■ **SRS airbag precautions**

Observe the following precautions regarding the SRS airbags. Failure to do so may cause death or serious injury.

- The driver and all passengers in the vehicle must wear their seat belts properly.

The SRS airbags are supplemental devices to be used with the seat belts.

- The SRS driver airbag deploys with considerable force, and can cause death or serious injury especially if the driver is very close to the airbag. The National Highway Traffic Safety Administration (NHTSA) advises:

Since the risk zone for the driver's airbag is the first 2 - 3 in. (50 - 75 mm) of inflation, placing yourself 10 in. (250 mm) from your driver airbag provides you with a clear margin of safety. This distance is measured from the center of the steering wheel to your breastbone. If you sit less than 10 in. (250 mm) away now, you can change your driving position in several ways:

- Move your seat to the rear as far as you can while still reaching the pedals comfortably.
- Slightly recline the back of the seat. Although vehicle designs vary, many drivers can achieve the 10 in. (250 mm) distance, even with the driver seat all the way forward, simply by reclining the back of the seat somewhat. If reclining the back of your seat makes it hard to see the road, raise yourself by using a firm, non-slippery cushion, or raise the seat if your vehicle has that feature.
- If your steering wheel is adjustable, tilt it downward. This points the airbag toward your chest instead of your head and neck.

The seat should be adjusted as recommended by NHTSA above, while still maintaining control of the foot pedals, steering wheel, and your view of the instrument panel controls.

⚠ WARNING**■ SRS airbag precautions**

- If the seat belt extender has been connected to the front seat belt buckles but the seat belt extender has not also been fastened to the latch plate of the seat belt, the SRS front airbags will judge that the driver and front passenger are wearing the seat belt even though the seat belt has not been connected. In this case, the SRS front airbags may not activate correctly in a collision, resulting in death or serious injury in the event of a collision. Be sure to wear the seat belt with the seat belt extender.
- The SRS front passenger airbag also deploys with considerable force, and can cause death or serious injury especially if the front passenger is very close to the airbag. The front passenger seat should be as far from the airbag as possible with the seatback adjusted, so the front passenger sits upright.
- Improperly seated and/or restrained infants and children can be killed or seriously injured by a deploying airbag. An infant or child who is too small to use a seat belt should be properly secured using a child restraint system. Toyota strongly recommends that all infants and children be placed in the rear seats of the vehicle and properly restrained. The rear seats are safer for infants and children than the front passenger seat. (→P. 55)
- Do not sit on the edge of the seat or lean against the dashboard.

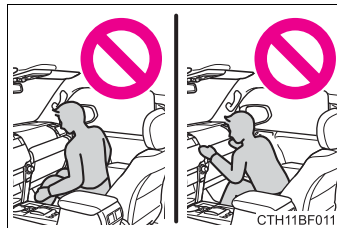
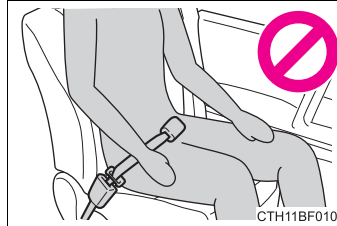

⚠ WARNING

■ SRS airbag precautions

- Do not allow a child to stand in front of the SRS front passenger airbag unit or sit on the knees of a front passenger.
- Do not allow the front seat occupants to hold items on their knees.

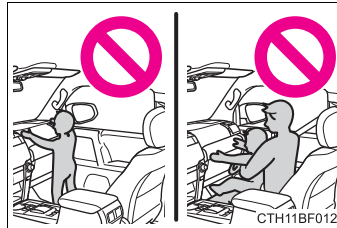

- Do not lean against the door, the roof side rail or the front, side and rear pillars.



- Do not allow anyone to kneel on the passenger seats toward the door or put their head or hands outside the vehicle.

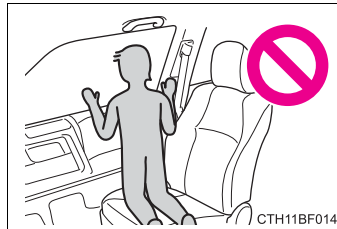

- Do not attach anything to or lean anything against areas such as the dashboard, steering wheel pad and lower portion of the instrument panel. These items can become projectiles when the SRS driver, front passenger and knee airbags deploy.

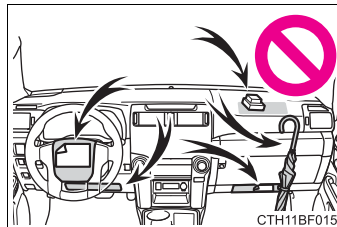

- Do not attach anything to areas such as a door, windshield glass, side door glass, front or rear pillar, roof side rail and assist grip.

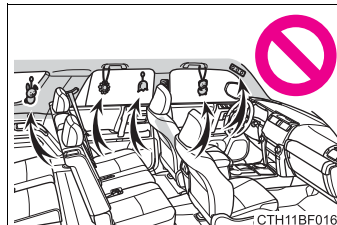

 **WARNING****■ SRS airbag precautions**

- Do not hang coat hangers or other hard objects on the coat hooks. All of these items could become projectiles and may cause death or serious injury, should the SRS curtain shield airbags deploy.
- If a vinyl cover is put on the area where the SRS knee airbag will deploy, be sure to remove it.
- Do not use seat accessories which cover the parts where the SRS side airbags inflate as they may interfere with inflation of the airbags. Such accessories may prevent the side airbags from activating correctly, disable the system or cause the side airbags to inflate accidentally, resulting in death or serious injury.
- Do not strike or apply significant levels of force to the area of the SRS airbag components.
Doing so can cause the SRS airbags to malfunction.
- Do not touch any of the component parts immediately after the SRS airbags have deployed (inflated) as they may be hot.
- If breathing becomes difficult after the SRS airbags have deployed, open a door or window to allow fresh air in, or leave the vehicle if it is safe to do so. Wash off any residue as soon as possible to prevent skin irritation.
- If the areas where the SRS airbags are stored, such as the steering wheel pad and front and rear pillar garnishes, are damaged or cracked, have them replaced by your Toyota dealer.
- Do not place anything, such as a cushion, on the front passenger's seat. Doing so will disperse the passenger's weight, which prevents the sensor from detecting the passenger's weight properly. As a result, the SRS front airbags for the front passenger may not deploy in the event of a collision.

⚠ WARNING**■ Modification and disposal of SRS airbag system components**

Do not dispose of your vehicle or perform any of the following modifications without consulting your Toyota dealer. The SRS airbags may malfunction or deploy (inflate) accidentally, causing death or serious injury.

- Installation, removal, disassembly and repair of the SRS airbags
- Repairs, modifications, removal or replacement of the steering wheel, instrument panel, dashboard, seats or seat upholstery, front, side and rear pillars or roof side rails
- Repairs or modifications of the front fender, front bumper, or side of the occupant compartment
- Installation of a grill guard (bull bars, kangaroo bar etc.), snow plows, winches or roof luggage carrier.
- Modifications to the vehicle's suspension system
- Installation of electronic devices such as mobile two-way radios and CD players
- Modifications to your vehicle for a person with a physical disability

■ If the SRS airbags deploy (inflate)

- Slight abrasions, burns, bruising etc., may be sustained from SRS airbags, due to the extremely high speed deployment (inflation) by hot gases.
- A loud noise and white powder will be emitted.
- Parts of the airbag module (steering wheel hub, airbag cover and inflator) as well as the front seats, parts of the front and rear pillars, and roof side rails may be hot for several minutes. The airbag itself may also be hot.
- The windshield may crack.
- Fuel supply to the engine will be stopped. (→P. 476)
- For Safety Connect subscribers, if any of the following situations occur, the system is designed to send an emergency call to the response center, notifying them of the vehicle's location (without needing to push the "SOS" button) and an agent will attempt to speak with the occupants to ascertain the level of emergency and assistance required. If the occupants are unable to communicate, the agent automatically treats the call as an emergency and helps to dispatch the necessary emergency services. (→P. 72)
 - An SRS airbag is deployed.
 - A seat belt pretensioner is activated.
 - The vehicle is involved in a severe rear-end collision.
 - The vehicle is involved in a rollover accident.

■ SRS airbag deployment conditions (SRS front airbags)

- The SRS front airbags will deploy in the event of an impact that exceeds the set threshold level (the level of force corresponding to an approximately 12 - 18 mph [20 - 30 km/h] frontal collision with a fixed wall that does not move or deform).

However, this threshold velocity will be considerably higher in the following situations:

- If the vehicle strikes an object, such as a parked vehicle or sign pole, which can move or deform on impact
 - If the vehicle is involved in an underride collision, such as a collision in which the front of the vehicle “underrides”, or goes under, the bed of a truck
- Depending on the type of collision, it is possible that only the seat belt pretensioners will activate.
 - The SRS front airbags for the front passenger will not activate if there is no passenger sitting in the front passenger seat. However, the SRS front airbags for the front passenger may deploy if luggage is put in the seat, even if the seat is unoccupied.

■ SRS airbag deployment conditions (SRS side and curtain shield airbags)

- The SRS side and curtain shield airbags will deploy in the event of an impact that exceeds the set threshold level (the level of force corresponding to the impact force produced by an approximately 3300 lb. [1500 kg] vehicle colliding with the vehicle cabin from a direction perpendicular to the vehicle orientation at an approximate speed of 12 - 18 mph [20 - 30 km/h]).
- Both SRS curtain shield airbags will deploy in the event of vehicle rollover.
- All SRS side and curtain shield airbags will deploy in the event of a severe frontal collision.

■ Conditions under which the SRS airbags may deploy (inflate), other than a collision

The SRS front airbags, SRS side and curtain shield airbags may also deploy if a serious impact occurs to the underside of your vehicle. Some examples are shown in the illustration.

- Hitting a curb, edge of pavement or hard surface
- Falling into or jumping over a deep hole
- Landing hard or falling

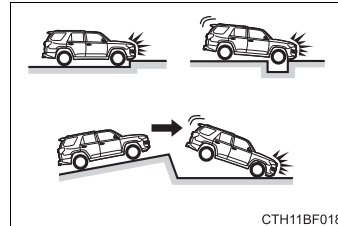

The SRS curtain shield airbags may also deploy under the situations shown in the illustration.

- The angle of vehicle tip-up is marginal.
- The vehicle skids and hits a curb stone.

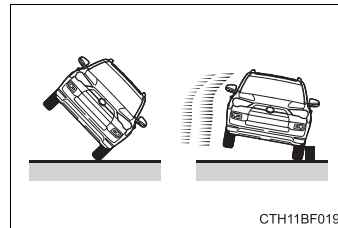

■ Types of collisions that may not deploy the SRS airbags (SRS front airbags)

The SRS front airbags do not generally inflate if the vehicle is involved in a side or rear collision, if it rolls over, or if it is involved in a low-speed frontal collision. But, whenever a collision of any type causes sufficient forward deceleration of the vehicle, deployment of the SRS front airbags may occur.

- Collision from the side
- Collision from the rear
- Vehicle rollover

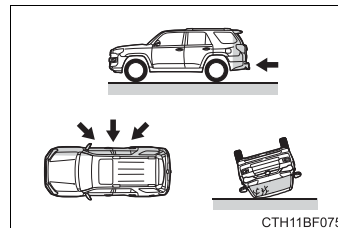

■ Types of collisions that may not deploy the SRS airbags (SRS side and curtain shield airbags)

The SRS side and curtain shield airbags may not activate if the vehicle is subjected to a collision from the side at certain angles, or a collision to the side of the vehicle body other than the passenger compartment.

- Collision from the side to the vehicle body other than the passenger compartment
- Collision from the side at an angle

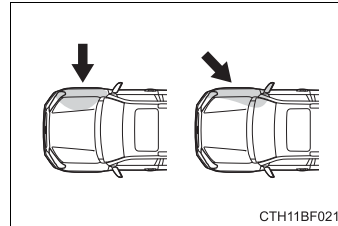

The SRS side airbags do not generally inflate if the vehicle is involved in a rear collision, if it rolls over, or if it is involved in a low-speed side or low-speed frontal collision.

- Collision from the rear
- Vehicle rollover

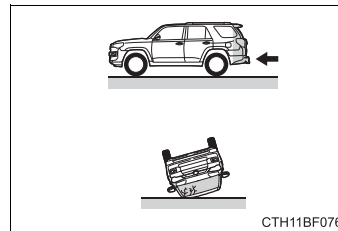

The SRS curtain shield airbags do not generally inflate if the vehicle is involved in a rear collision, if it pitches end over end, or if it is involved in a low-speed side or low-speed frontal collision.

- Collision from the rear
- Pitching end over end

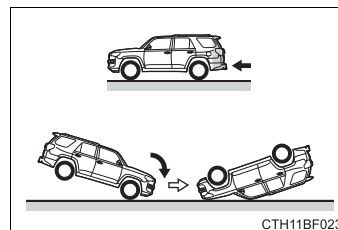

■ When to contact your Toyota dealer

In the following cases, the vehicle will require inspection and/or repair. Contact your Toyota dealer as soon as possible.

- Any of the SRS airbags have been inflated.
- The front of the vehicle is damaged or deformed, or was involved in an accident that was not severe enough to cause the SRS front airbags to inflate.

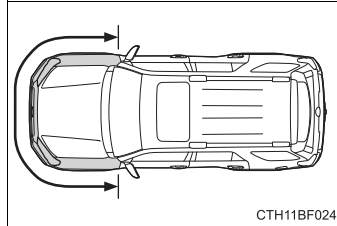

- A portion of a door or its surrounding area is damaged or deformed, or the vehicle was involved in an accident that was not severe enough to cause the SRS side and curtain shield airbags to inflate.

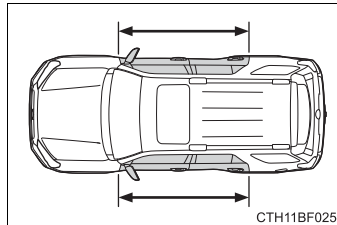

- The pad section of the steering wheel, dashboard near the front passenger airbag or lower portion of the instrument panel is scratched, cracked, or otherwise damaged.

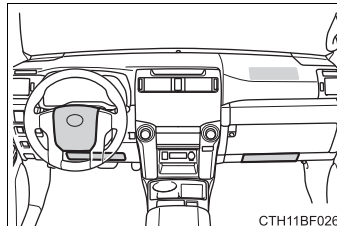

- The surface of the seats with the SRS side airbag is scratched, cracked, or otherwise damaged.

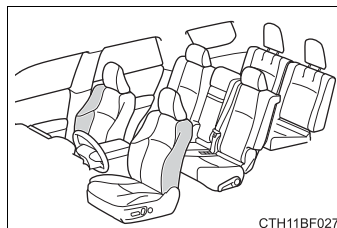

- The portion of the front pillars, rear pillars or roof side rail garnishes (padding) containing the SRS curtain shield airbags inside is scratched, cracked, or otherwise damaged.

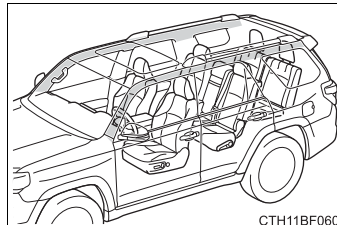

Front passenger occupant classification system

Your vehicle is equipped with a front passenger occupant classification system. This system detects the conditions of the front passenger seat and activates or deactivates the front passenger airbag, front passenger knee airbag, and front passenger's seat belt pretensioner.

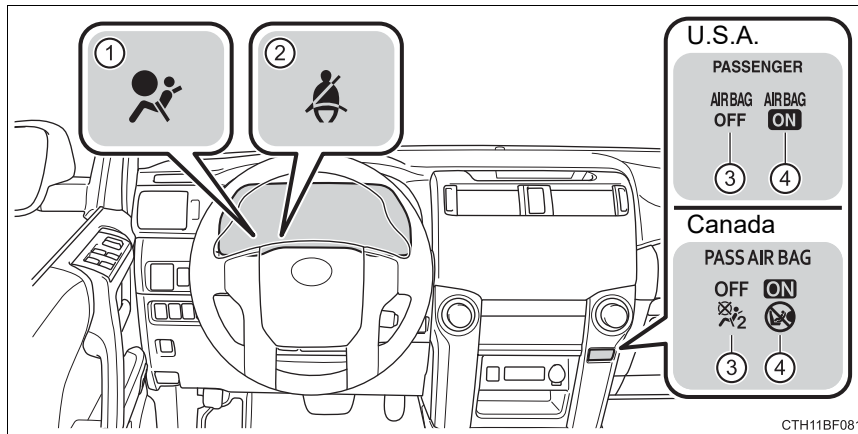

- ① SRS warning light
- ② Seat belt reminder light
- ③ "AIR BAG OFF" indicator light
- ④ "AIR BAG ON" indicator light

Condition and operation in the front passenger occupant classification system

■ Adult*1

Indicator/ warning light	"AIR BAG ON" and "AIR BAG OFF" indicator lights	"AIR BAG ON"
	SRS warning light	Off
	Seat belt reminder light	Off*2 or flashing*3
Devices	Front passenger airbag	Activated
	Front passenger knee airbag	
	Front passenger's seat belt pretensioner	

■ Child*4 or child restraint system*5

Indicator/ warning light	"AIR BAG ON" and "AIR BAG OFF" indicator lights	"AIR BAG OFF"*6
	SRS warning light	Off
	Seat belt reminder light	Flashing*3
Devices	Front passenger airbag	Deactivated
	Front passenger knee airbag	
	Front passenger's seat belt pretensioner	Activated

1

For safety and security

■ **Unoccupied**

Indicator/ warning light	"AIR BAG ON" and "AIR BAG OFF" indicator lights	Not illuminated
	SRS warning light	Off
	Seat belt reminder light	
Devices	Front passenger airbag	Deactivated
	Front passenger knee airbag	
	Front passenger's seat belt pretensioner	Activated* ⁷ or deactivated* ⁸

■ **There is a malfunction in the system**

Indicator/ warning light	"AIR BAG ON" and "AIR BAG OFF" indicator lights	"AIR BAG OFF"
	SRS warning light	On
	Seat belt reminder light	On or flashing
Devices	Front passenger airbag	Deactivated
	Front passenger knee airbag	
	Front passenger's seat belt pretensioner	Activated

*1: The system judges a person of adult size as an adult. When a smaller adult sits in the front passenger seat, the system may recognize him/her as a child depending on his/her physique and posture.

*2: In the event the front passenger is wearing a seat belt.

*3: In the event the front passenger does not wear a seat belt.

*4: When a larger child who has outgrown a child restraint system sits in the front passenger seat, the system may recognize him/her as an adult depending on his/her physique or posture.

*5: Never install a rear-facing child restraint system on the front passenger seat. A forward-facing child restraint system should only be installed on the front passenger seat when it is unavoidable.
(→P. 55)

*6: In case the indicator light is not illuminated, consult this manual on how to install the child restraint system properly. (→P. 59)

*7: In the event of a side collision.

*8: In the event of a frontal collision or rollover.

 **WARNING****■ Front passenger occupant classification system precautions**

Observe the following precautions regarding the front passenger occupant classification system.

Failure to do so may cause death or serious injury.

- Wear the seat belt properly.
- Make sure the front passenger's seat belt plate has not been left inserted into the buckle before someone sits in the front passenger seat.
- Make sure the "AIR BAG OFF" indicator light is not illuminated when using the seat belt extender for the front passenger seat. If the "AIR BAG OFF" indicator light is illuminated, disconnect the extender tongue from the seat belt buckle, and reconnect the seat belt. Reconnect the seat belt extender after making sure the "AIR BAG ON" indicator light is illuminated. If you use the seat belt extender while the "AIR BAG OFF" indicator light is illuminated, the SRS airbags for the front passenger will not activate, which could cause death or serious injury in the event of a collision.
- Do not apply a heavy load to the front passenger seat or equipment.
- Do not put weight on the front passenger seat by putting your hands or feet on the front passenger seat seatback from the rear passenger seat.
- Do not let a rear passenger lift the front passenger seat with their feet or press on the seatback with their legs.
- Do not put objects under the front passenger seat.

 **WARNING****■ Front passenger occupant classification system precautions**

- Do not recline the front passenger seatback so far that it touches a rear seat. This may cause the “AIR BAG OFF” indicator light to be illuminated, which indicates that the SRS airbags for the front passenger will not deploy in the event of a severe accident. If the seatback touches the rear seat, return the seatback to a position where it does not touch the rear seat. Keep the front passenger seatback as upright as possible when the vehicle is moving. Reclining the seatback excessively may lessen the effectiveness of the seat belt system.
- If an adult sits in the front passenger seat, the “AIR BAG ON” indicator light is illuminated. If the “AIR BAG OFF” indicator is illuminated, ask the passenger to sit up straight, well back in the seat, feet on the floor, and with the seat belt worn correctly. If the “AIR BAG OFF” indicator still remains illuminated, either ask the passenger to move to the rear seat, or if that is not possible, move the front passenger seat fully rearward.
- When it is unavoidable to install a forward-facing child restraint system on the front passenger seat, install the child restraint system on the front passenger seat in the proper order. (→P. 59)
- Do not modify or remove the front seats.
- Do not kick the front passenger seat or subject it to severe impact. Otherwise, the SRS warning light may come on to indicate a malfunction of the front passenger occupant classification system. In this case, contact your Toyota dealer immediately.
- Child restraint systems installed on the second seat should not contact the front seatbacks.
- Do not use a seat accessory, such as a cushion and seat cover, that covers the seat cushion surface.
- Do not modify or replace the upholstery of the front seat.

Safety information for children

Observe the following precautions when children are in the vehicle.

Use a child restraint system appropriate for the child, until the child becomes large enough to properly wear the vehicle's seat belt.

- It is recommended that children sit in the rear seats to avoid accidental contact with the shift lever, wiper switch etc.
- Use the rear door child-protector lock or the window lock switch to avoid children opening the door while driving or operating the power window accidentally.
- Do not let small children operate equipment which may catch or pinch body parts, such as the power window, hood, back door, seats etc.

WARNING

Never leave children unattended in the vehicle, and never allow children to have or use the key.

Children may be able to start the vehicle or shift the vehicle into neutral. There is also a danger that children may injure themselves by playing with the windows, the moon roof or other features of the vehicle. In addition, heat build-up or extremely cold temperatures inside the vehicle can be fatal to children.

Child restraint systems

A child restraint system for a small child or baby must itself be properly restrained on the seat with the LATCH anchors or the lap portion of the lap/shoulder belt.

The laws of all 50 states of the U.S.A. and Canada now require the use of child restraint systems.

Points to remember

Studies have shown that installing a child restraint on a rear seat is much safer than installing one on the front passenger seat.

- Choose a child restraint system that suits your vehicle and is appropriate to the age and size of the child.
- For installation details, follow the instructions provided with the child restraint system.

General installation instructions are provided in this manual.

(→P. 59)

Types of child restraints

Child restraint systems are classified into the following 3 types according to the age and size of the child:

- ▶ Rear facing — Infant seat/convertible seat
- ▶ Forward facing — Convertible seat

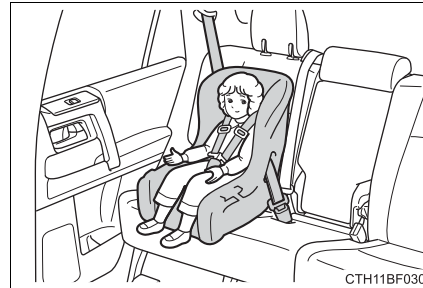
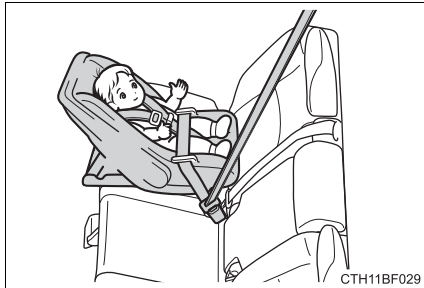

- ▶ Booster seat

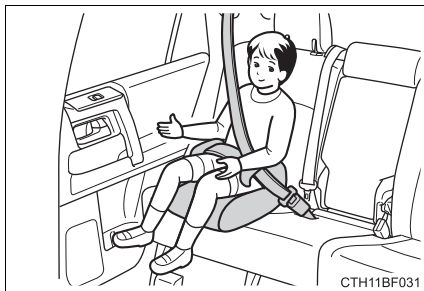

■ Selecting an appropriate child restraint system

- Use a child restraint system appropriate for the child until the child becomes large enough to properly wear the vehicle's seat belt.
- If the child is too large for a child restraint system, sit the child on a rear seat and use the vehicle's seat belt. (→P. 32)

 **WARNING****■ Child restraint precautions**

- For effective protection in automobile accidents and sudden stops, a child must be properly restrained, using a seat belt or child restraint system depending on the age and size of the child. Holding a child in your arms is not a substitute for a child restraint system. In an accident, the child can be crushed against the windshield, or between you and the vehicle's interior.
- Toyota strongly urges the use of a proper child restraint system that conforms to the size of the child, installed on the rear seat. According to accident statistics, the child is safer when properly restrained in the rear seat than in the front seat.
- Never install a rear-facing child restraint system on the front passenger seat even if the "AIR BAG OFF" indicator light is illuminated. In the event of an accident, the force of the rapid inflation of the front passenger airbag can cause death or serious injury to the child if the rear-facing child restraint system is installed on the front passenger seat.
- A forward-facing child restraint system may be installed on the front passenger seat only when it is unavoidable. A child restraint system that requires a top tether strap should not be used in the front passenger seat since there is no top tether strap anchor for the front passenger seat. Adjust the seatback as upright as possible and always move the seat as far back as possible even if the "AIR BAG OFF" indicator light is illuminated, because the front passenger airbag could inflate with considerable speed and force. Otherwise, the child may be killed or seriously injured.
- Do not use the seat belt extender when installing a child restraint system on the front or rear passenger seat. If installing a child restraint system with the seat belt extender connected to the seat belt, the seat belt will not securely hold the child restraint system, which could cause death or serious injury to the child or other passengers in the event of an accident.
- Do not allow the child to lean his/her head or any part of his/her body against the door or the area of the seat, front and rear pillars or roof side rails from which the SRS side airbags or SRS curtain shield airbags deploy even if the child is seated in the child restraint system. It is dangerous if the SRS side airbags and curtain shield airbags inflate, and the impact could cause death or serious injury to the child.
- Make sure you have complied with all installation instructions provided by the child restraint manufacturer and that the system is properly secured. If it is not secured properly, it may cause death or serious injury to the child in the event of a sudden stop, sudden swerve or accident.

 **WARNING****■ When children are in the vehicle**

Do not allow children to play with the seat belt. If the seat belt becomes twisted around a child's neck, it may lead to choking or other serious injuries that could result in death.

If this occurs and the buckle cannot be unfastened, scissors should be used to cut the belt.

■ When the child restraint system is not in use

- Keep the child restraint system properly secured on the seat even if it is not in use. Do not store the child restraint system unsecured in the passenger compartment.

- If it is necessary to detach the child restraint system, remove it from the vehicle or store it securely in the luggage compartment. This will prevent it from injuring passengers in the event of a sudden stop, sudden swerve or accident.

Installing child restraints

Follow the child restraint system manufacturer's instructions. Firmly secure child restraints to the seats using the LATCH (Lower Anchors and Tethers for Children) anchors or a seat belt. Attach the top tether strap when installing a child restraint. The lap/shoulder belt can be used if your child restraint system is not compatible with the LATCH system.

► Vehicles without third row seats

Child restraint LATCH anchors

LATCH anchors are provided for the outboard rear seats. (Buttons displaying the location of the anchors are attached to the seats.)

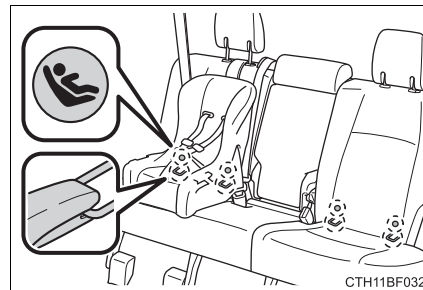

► Vehicles with third row seats

Child restraint LATCH anchors

LATCH anchors are provided for the outboard second row seats. (Buttons displaying the location of the anchors are attached to the seats.)

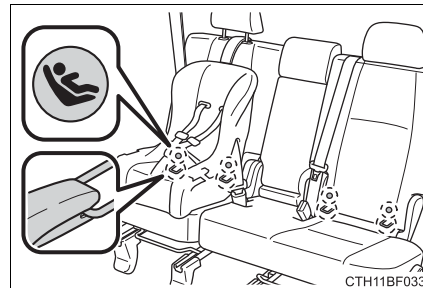

Seat belts equipped with a child restraint locking mechanism (ALR/ELR belts except driver's seat belt) (→P. 33)

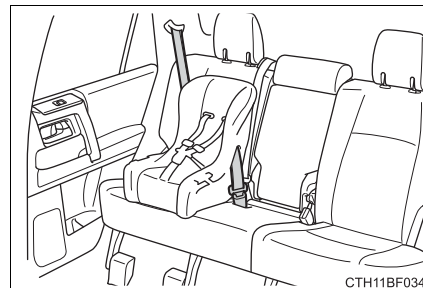

▶ Vehicles without third row seats

Anchor brackets (for top tether strap)

An anchor bracket is provided for each rear seat.

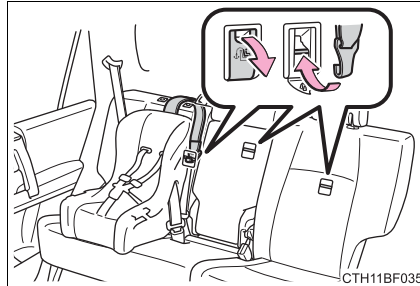

▶ Vehicles with third row seats

Anchor brackets (for top tether strap)

An anchor bracket is provided for each second row seat.

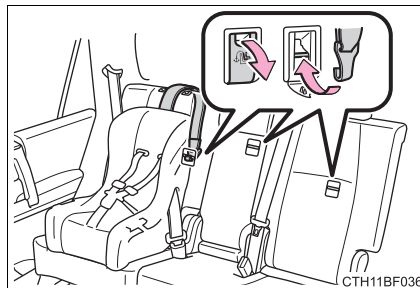

Installation with LATCH system (rear/second row seats only)

■ Installing on the rear seats (vehicles without third row seats)

- 1 Fold the seatback while pulling the seatback angle adjustment lever. Return the seatback and secure it at the first lock position. (→P. 132)

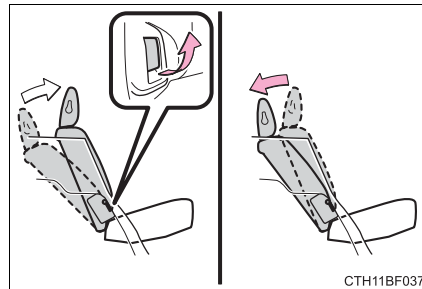

► Type A

- 2 Latch the hooks of the lower straps onto the LATCH anchors. If the child restraint has a top tether strap, the top tether strap should be latched onto the top tether strap anchor.

For owners in Canada:

The symbol on a child restraint system indicates the presence of a lower connector system.

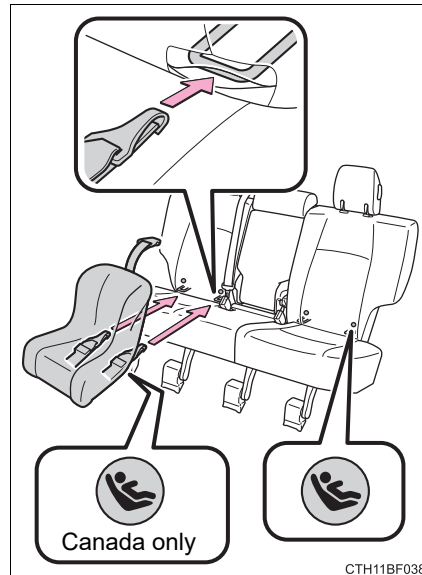

► Type B

- 2 Latch the buckles onto the LATCH anchors. If the child restraint has a top tether strap, the top tether strap should be latched onto the top tether strap anchor.

For owners in Canada:

The symbol on a child restraint system indicates the presence of a lower connector system.

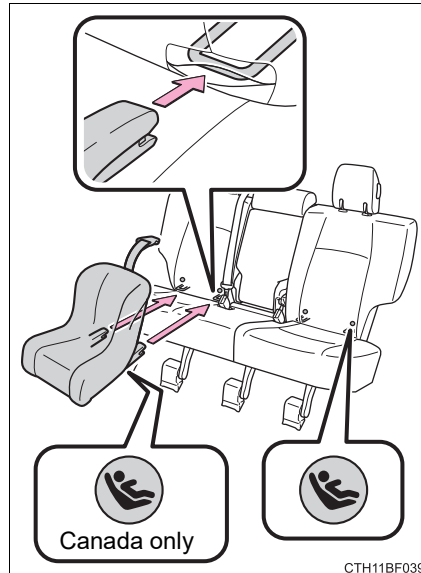

■ Installing on the second row seats (vehicles with third row seats)

- 1 Fold the seatback while pulling the seatback angle adjustment lever. Return the seatback and secure it at the first lock position. (→P. 132)
- 2 Flip the cover.

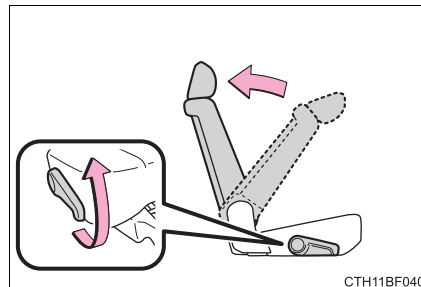

► Type A

- 3 Latch the hooks of the lower straps onto the LATCH anchors. If the child restraint has a top tether strap, the top tether strap should be latched onto the top tether strap anchor.

For owners in Canada:

The symbol on a child restraint system indicates the presence of a lower connector system.

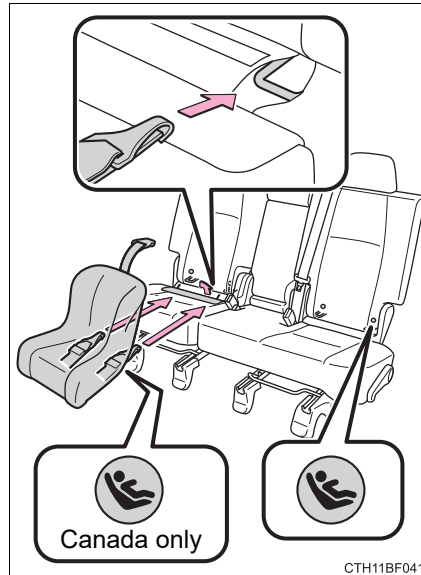

► Type B

- 3 Latch the buckles onto the LATCH anchors. If the child restraint has a top tether strap, the top tether strap should be latched onto the top tether strap anchor.

For owners in Canada:

The symbol on a child restraint system indicates the presence of a lower connector system.

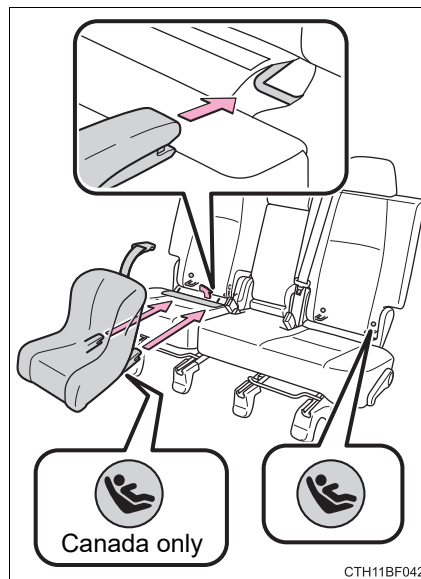

Installing child restraints using a seat belt (child restraint lock function belt)

■ Rear-facing — Infant seat/convertible seat

- 1 Place the child restraint system on the rear seat facing the rear of the vehicle.

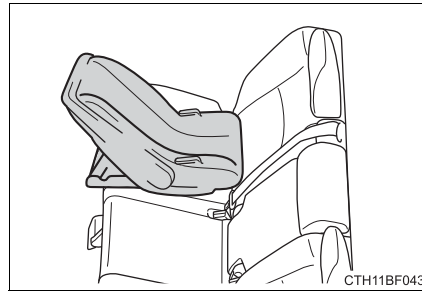

- 2 Run the seat belt through the child restraint system and insert the plate into the buckle. Make sure that the belt is not twisted.

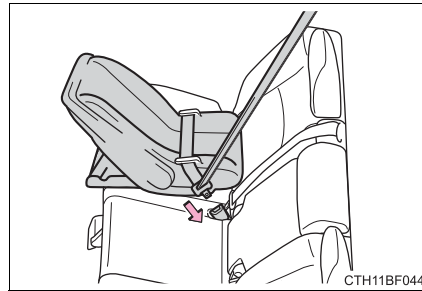

- 3 Fully extend the shoulder belt and allow it to retract to put it in lock mode. In lock mode, the belt cannot be extended.

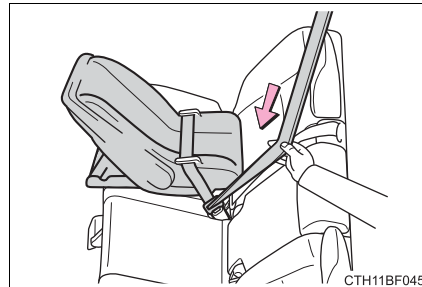

- 4 While pushing the child restraint system down into the rear seat, allow the shoulder belt to retract until the child restraint system is securely in place.

After the shoulder belt has retracted to a point where there is no slack in the belt, pull the belt to check that it cannot be extended.

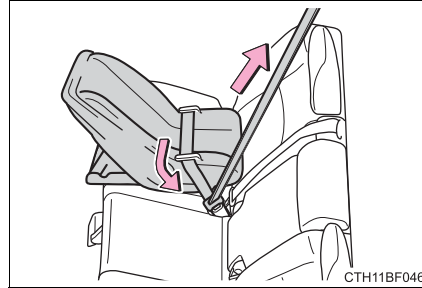

■ Forward-facing — Convertible seat

- 1 Place the child restraint system on the seat facing the front of the vehicle.

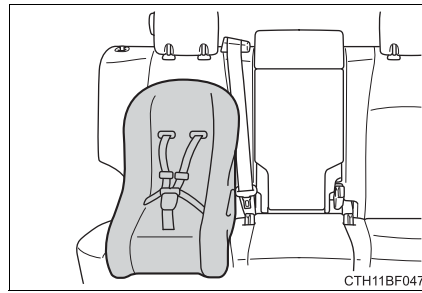

- 2 Run the seat belt through the child restraint system and insert the plate into the buckle. Make sure that the belt is not twisted.

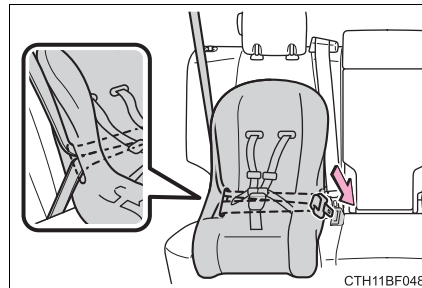

- 3 Fully extend the shoulder belt and allow it to retract to put it in lock mode. In lock mode, the belt cannot be extended.

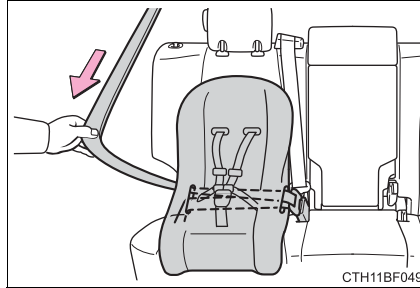

- 4 While pushing the child restraint system into the rear seat, allow the shoulder belt to retract until the child restraint system is securely in place.

After the shoulder belt has retracted to a point where there is no slack in the belt, pull the belt to check that it cannot be extended.

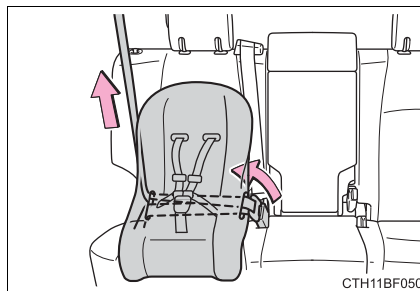

- 5 If the child restraint has a top tether strap, the top tether strap should be latched onto the top tether strap anchor. (→P. 68)

■ Booster seat

- 1 Place the child restraint system on the seat facing the front of the vehicle.

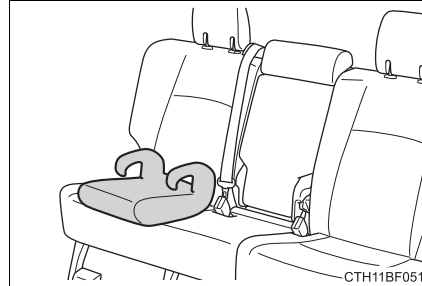

- 2 Sit the child in the child restraint system. Fit the seat belt to the child restraint system according to the manufacturer's instructions and insert the plate into the buckle. Make sure that the belt is not twisted.



Check that the shoulder belt is correctly positioned over the child's shoulder and that the lap belt is as low as possible. (→P. 32)

Removing a child restraint installed with a seat belt

Push the buckle release button and fully retract the seat belt.

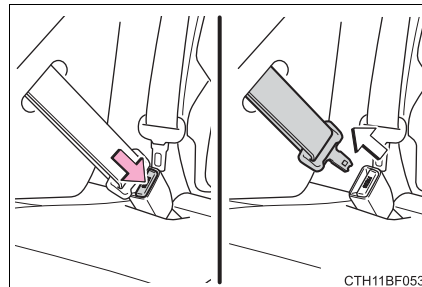

Child restraint systems with a top tether strap

- 1 Secure the child restraint system using the seat belt or the lower anchors, and remove the head restraint.

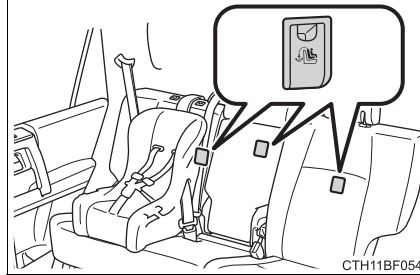
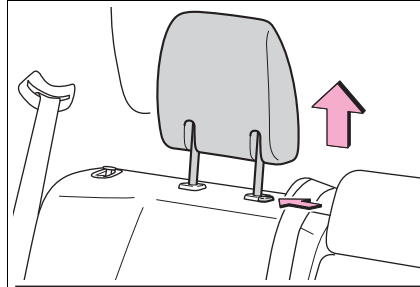

- 2 Open the anchor bracket cover, latch the hook onto the anchor bracket and tighten the top tether strap.

Make sure the top tether strap is securely latched.

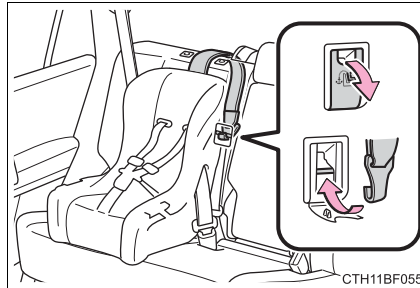

- 3 Replace the head restraint.

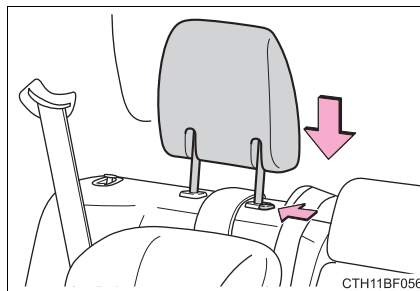

■ Laws and regulations pertaining to anchorages

The LATCH system conforms to FMVSS225 or CMVSS210.2.

Child restraint systems conforming to FMVSS213 or CMVSS213 specifications can be used.

This vehicle is designed to conform to the SAE J1819.

⚠ WARNING

■ When installing a booster seat

To prevent the belt from going into ALR lock mode, do not fully extend the shoulder belt. ALR mode causes the belt to tighten only. This could cause injury or discomfort to the child. (→P. 33)

■ When installing a child restraint system

Follow the directions given in the child restraint system installation manual and fix the child restraint system securely in place.

If the child restraint system is not correctly fixed in place, the child or other passengers may be seriously injured or even killed in the event of a sudden braking or an accident.

- If the driver's seat interferes with the child restraint system and prevents it from being attached correctly, attach the child restraint system to the right-hand rear seat.

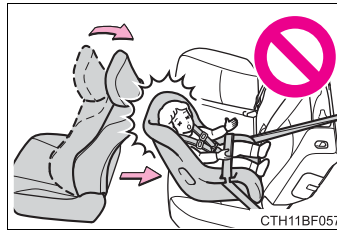

- Adjust the front passenger seat so that it does not interfere with the child restraint system.

- Only put a forward-facing child restraint system on the front seat when unavoidable. When installing a forward-facing child restraint system on the front passenger seat, move the seat as far back as possible even if the "AIR BAG OFF" indicator light is illuminated. Failure to do so may result in death or serious injury if the airbags deploy (inflate).

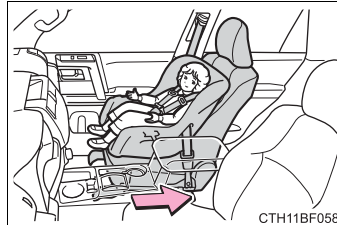

 **WARNING****■ When installing a child restraint system**

- Vehicles with third row seats: When using the LATCH anchors for a child restraint system, move the seat as far back as possible, with the seatback close to the child restraint system.
- When a booster seat is installed, always ensure that the shoulder belt is positioned across the center of the child's shoulder. The belt should be kept away from the child's neck, but not so that it could fall off the child's shoulder. Failing to do so may result in death or serious injury in the event of an accident or a sudden braking.
- Ensure that the belt and plate are securely locked and the seat belt is not twisted.
- Shake the child restraint system left and right, and forward and backward to ensure that it has been securely installed.
- After securing a child restraint system, never adjust the seat.
- Follow all installation instructions provided by the child restraint system manufacturer.
- When securing some types of child restraint systems in second or third row seats, it may not be possible to properly use the seat belts in positions next to the child restraint without interfering with it or affecting seat belt effectiveness. Be sure your seat belt fits snugly across your shoulder and low on your hips. If it does not, or if it interferes with the child restraint, move to a different position. Failure to do so may result in death or serious injury.

■ Do not use a seat belt extender

If a seat belt extender is used when installing a child restraint system, the seat belt will not securely hold the child restraint system, which could cause death or serious injury to the child or other passengers in the event of a sudden braking, sudden swerving or an accident.

■ To correctly attach a child restraint system to the anchors

When using the LATCH anchors, be sure that there are no foreign objects around the anchors and that the seat belt is not caught behind the child restraint system. Make sure the child restraint system is securely attached, or it may cause death or serious injury to the child or other passengers in the event of a sudden braking or an accident.

Exhaust gas precautions

Harmful substance to the human body is included in exhaust gases if inhale.

WARNING

Exhaust gases include harmful carbon monoxide (CO), which is colorless and odorless. Observe the following precautions.

Failure to do so may cause exhaust gases enter the vehicle and may lead to an accident caused by light-headedness, or may lead to death or a serious health hazard.

■ Important points while driving

- Keep the back door closed.
- If you smell exhaust gases in the vehicle even when the back door is closed, open the windows and have the vehicle inspected at your Toyota dealer as soon as possible.

■ When parking

- If the vehicle is in a poorly ventilated area or a closed area, such as a garage, stop the engine.
- Do not leave the vehicle with the engine on for a long time.
If such a situation cannot be avoided, park the vehicle in an open space and ensure that exhaust fumes do not enter the vehicle interior.
- Do not leave the engine running in an area with snow build-up, or where it is snowing. If snowbanks build up around the vehicle while the engine is running, exhaust gases may collect and enter the vehicle.

■ Exhaust pipe

The exhaust system needs to be checked periodically. If there is a hole or crack caused by corrosion, damage to a joint or abnormal exhaust noise, be sure to have the vehicle inspected and repaired by your Toyota dealer.

1

For safety and security

Safety Connect*

Safety Connect is a subscription-based telematics service that uses Global Positioning System (GPS) data and embedded cellular technology to provide safety and security features to subscribers. Safety Connect is supported by Toyota's designated response center, which operates 24 hours per day, 7 days per week.

Safety Connect service is available by subscription on select, telematics hardware-equipped vehicles.

By using the Safety Connect service, you are agreeing to be bound by the Telematics Subscription Service Agreement and its Terms and Conditions, as in effect and amended from time to time, a current copy of which is available at Toyota.com in the United States, Toyotapr.com in Puerto Rico and Toyota.ca in Canada. All use of the Safety Connect service is subject to such then-applicable Terms and Conditions.

■ System components

- ① Microphone
- ② "SOS" button
- ③ LED light indicators

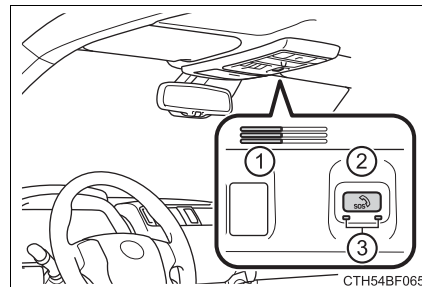

*: If equipped

■ Services

Subscribers have the following Safety Connect services available:

- Automatic Collision Notification*

Helps drivers receive necessary response from emergency service providers. (→P. 75)

*: U.S. Patent No. 7,508,298 B2

- Stolen Vehicle Location

Helps drivers in the event of vehicle theft. (→P. 75)

- Emergency Assistance Button (“SOS”)

Connects drivers to response-center support. (→P. 75)

- Enhanced Roadside Assistance

Provides drivers various on-road assistance. (→P. 76)

■ Subscription

After you have signed the Telematics Subscription Service Agreement and are enrolled, you can begin receiving services.

A variety of subscription terms are available for purchase. Contact your Toyota dealer, call the following appropriate Customer Experience Center or push the “SOS” button in your vehicle for further subscription details.

- The United States
1-800-331-4331
- Canada
1-888-869-6828
- Puerto Rico
1-877-855-8377

■ Safety Connect Services Information

- Phone calls using the vehicles Bluetooth® technology will not be possible when Safety Connect is active and in use.
- Safety Connect is available beginning Fall 2009 on select Toyota models (in the contiguous United States only). Contact with the Safety Connect response center is dependent upon the telematics device being in operative condition, cellular connection availability, and GPS satellite signal reception, which can limit the ability to reach the response center or receive emergency service support. Enrollment and Telematics Subscription Service Agreement required. A variety of subscription terms is available; charges vary by subscription term selected and location.
- Automatic Collision Notification, Emergency Assistance and Stolen Vehicle Location are available in the United States, including Hawaii and Alaska, Puerto Rico and Canada, and Enhanced Roadside Assistance are available in the United States, Puerto Rico and Canada.
- Automatic Collision Notification, Emergency Assistance, Stolen Vehicle and Enhanced Road Assistance are not available in the U.S. Virgin Islands. For vehicles first sold in the U.S. Virgin Islands, no Safety Connect services will function in or outside the U.S. Virgin Islands.
- Safety Connect services are not subject to section 255 of the Telecommunications Act and the device is not TTY compatible.

■ Languages

The Safety Connect response center will offer support in multiple languages. The Safety Connect system will offer voice prompts in English, Spanish, and French. Please indicate your language of choice when enrolling.

■ When contacting the response center

You may be unable to contact the response center if the network is busy.

Safety Connect LED light Indicators

When the engine switch is turned to IGNITION ON mode, the red indicator light comes on for 2 seconds then turns off. Afterward, the green indicator light comes on, indicating that the service is active.

The following indicator light patterns indicate specific system usage conditions:

- Green indicator light on = Active service
- Green indicator light flashing = Safety Connect call in process
- Red indicator light (except at vehicle start-up) = System malfunction (contact your Toyota dealer)
- No indicator light (off) = Safety Connect service not active

Safety Connect services

■ Automatic Collision Notification

In case of either airbag deployment or severe rear-end collision, the system is designed to automatically call the response center. The responding agent receives the vehicle's location and attempts to speak with the vehicle occupants to assess the level of emergency. If the occupants are unable to communicate, the agent automatically treats the call as an emergency, contacts the nearest emergency services provider to describe the situation, and requests that assistance be sent to the location.

■ Stolen Vehicle Location

If your vehicle is stolen, Safety Connect can work with local authorities to assist them in locating and recovering the vehicle. After filing a police report, call the Customer Experience Center at 1-800-331-4331 in the United States, 1-877-855-8377 in Puerto Rico or 1-888-869-6828 in Canada, and follow the prompts for Safety Connect to initiate this service.

In addition to assisting law enforcement with recovery of a stolen vehicle, Safety-Connect-equipped vehicle location data may, under certain circumstances, be shared with third parties to locate your vehicle. Further information is available at Toyota.com in the United States, Toyotapr.com in Puerto Rico and Toyota.ca in Canada.

■ Emergency Assistance Button (“SOS”)

In the event of an emergency on the road, push the “SOS” button to reach the Safety Connect response center. The answering agent will determine your vehicle's location, assess the emergency, and dispatch the necessary assistance required.

If you accidentally press the “SOS” button, tell the response-center agent that you are not experiencing an emergency.

■ Enhanced Roadside Assistance

Enhanced Roadside Assistance adds GPS data to the already included warranty-based Toyota roadside service.

Subscribers can press the “SOS” button to reach a Safety Connect response-center agent, who can help with a wide range of needs, such as: towing, flat tire, fuel delivery, etc. For a description of the Enhanced Roadside Assistance services and their limitations, please see the Safety Connect Terms and Conditions, which are available at Toyota.com in the United States, Toyotapr.com in Puerto Rico and Toyota.ca in Canada.

Safety information for Safety Connect

Important! Read this information before using Safety Connect.

■ Exposure to radio frequency signals

The Safety Connect system installed in your vehicle is a low-power radio transmitter and receiver. It receives and also sends out radio frequency (RF) signals.

In August 1996, the Federal Communications Commission (FCC) adopted RF exposure guidelines with safety levels for mobile wireless phones. Those guidelines are consistent with the safety standards previously set by the following U.S. and international standards bodies.

- ANSI (American National Standards Institute) C95.1 [1992]
- NCRP (National Council on Radiation Protection and Measurement) Report 86 [1986]
- ICNIRP (International Commission on Non-Ionizing Radiation Protection) [1996]

Those standards were based on comprehensive and periodic evaluations of the relevant scientific literature. Over 120 scientists, engineers, and physicians from universities, and government health agencies and industries reviewed the available body of research to develop the ANSI Standard (C95.1).

The design of Safety Connect complies with the FCC guidelines in addition to those standards.

■ Certification for Safety Connect

FCC ID: JOYDA39
IC: 574B-DA39

FCC/IC WARNING:

Changes or modifications not expressly approved by the manufacture could void the user's authority to operate the equipment. This device complies with Part 15 of the FCC Rules and Industry Canada license-exempt RSS standards. Operation is subject to the following two conditions:

- (1) this device may not cause harmful interference, and
- (2) this device must accept any interference, including interference that may cause undesired operation of the device.

This equipment complies with IC RSS-102 radiation exposure limits set forth for uncontrolled environment.

The antennas used for this transmitter must be installed to provide a separation distance of least 20cm from all persons.

FCC/IC AVERTISSEMENT:

L'utilisateur est averti que les changements ou modifications non expressément approuvés par le fabricant pourraient annuler l'autorité de l'utilisateur à utiliser l'équipement:

Ce appareil est compatible avec la Partie 15 du règlement FCC et de la Licence de l'industrie canadienne et des normes exemptes de RSS.

Opération soumise aux deux conditions suivantes :

- (1) ce appareil ne doit pas causer des interférences nuisibles, et
- (2) cet appareil doit accepté toutes les interférences, y compris les interférences qui peuvent entraîner un fonctionnement indésirable de l'appareil.

Cet appareil est compatible aux limites d'exposition aux radiation IC RSS-102 définies pour un environnement non contrôlé.

Les antennes utilisées pour cet émetteur doivent être installées à une distance d'au moins 20 cm de toutes les personnes.

Engine immobilizer system

The vehicle's keys have built-in transponder chips that prevent the engine from starting if a key has not been previously registered in the vehicle's on-board computer.

Never leave the keys inside the vehicle when you leave the vehicle.

This system is designed to help prevent vehicle theft but does not guarantee absolute security against all vehicle thefts.

The indicator light flashes after the engine switch has been turned off to indicate that the system is operating.

The indicator light stops flashing after the engine switch has been turned to ACCESSORY or IGNITION ON mode to indicate that the system has been canceled.

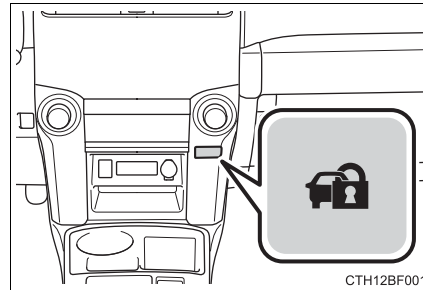

■ System maintenance

The vehicle has a maintenance-free type engine immobilizer system.

■ Conditions that may cause the system to malfunction

- If the grip portion of the key is in contact with a metallic object
- If the key is in close proximity to or touching a key to the security system (key with a built-in transponder chip) of another vehicle

⚠ WARNING

■ Certifications for the engine immobilizer system

Changes or modifications not expressly approved by the party responsible for compliance could void the user's authority to operate the equipment.

⚠ NOTICE

■ To ensure the system operates correctly

Do not modify or remove the system. If modified or removed, the proper operation of the system cannot be guaranteed.

Alarm*

The alarm

The alarm uses light and sound to give an alert when an intrusion is detected.

The alarm is triggered in the following situations when the alarm is set:

- A locked door is unlocked or opened in any way other than using the entry function, wireless remote control or mechanical key. (The doors will lock again automatically.)
- The hood is opened.
- The battery is reconnected.

Setting the alarm system

Close the doors and hood, and lock all the doors. The system will be set automatically after 30 seconds.

The indicator light changes from being on to flashing when the system is set.

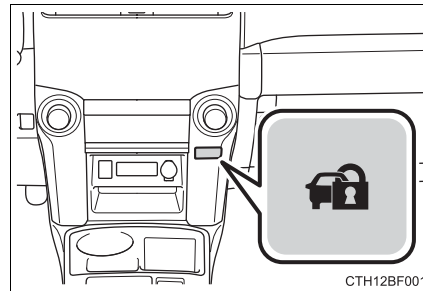

Deactivating or stopping the alarm

Do one of the following to deactivate or stopping the alarms:

- Unlock the doors.
- Turn the engine switch is in ACCESSORY or IGNITION ON mode, or start the engine. (The alarm will be deactivated or stopped after a few seconds.)

*: If equipped

1

For safety and security

■ System maintenance

The vehicle has a maintenance-free type alarm system.

■ Items to check before locking the vehicle

To prevent unexpected triggering of the alarm and vehicle theft, make sure of the following:

- Nobody is in the vehicle.
- The windows and moon roof are closed before the alarm is set.
- No valuables or other personal items are left in the vehicle.

■ Triggering of the alarm

The alarm may be triggered in the following situations:
(Stopping the alarm deactivates the alarm system.)

- A person inside the vehicle opens a door or the hood.

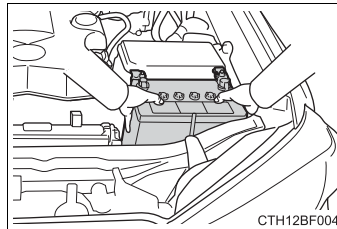

- The battery is recharged or replaced when the vehicle is locked.

**■ Alarm-operated door lock**

- When the alarm is operating, the doors are locked automatically to prevent intruders.
- Do not leave the key inside the vehicle when the alarm is operating, and make sure the key is not inside the vehicle when recharging or replacing the battery.

⚠ NOTICE**■ To ensure the system operates correctly**

Do not modify or remove the system. If modified or removed, the proper operation of the system cannot be guaranteed.

Instrument cluster

2

81

2. Instrument cluster

Warning lights and indicators 82
Gauges and meters 88
Multi-information display 90

Warning lights and indicators

The warning lights and indicators on the instrument cluster and center panel inform the driver of the status of the vehicle's various systems.



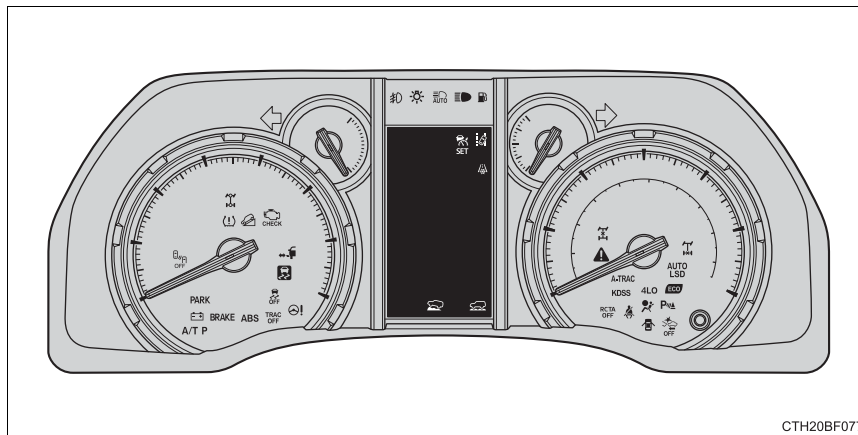













For the purpose of explanation, the following illustration displays all warning lights and indicators illuminated.

















The units used on the speedometer and some indicators may differ depending on where the vehicle is sold.

Warning lights

Warning lights inform the driver of malfunctions in the indicated vehicle's systems.

<p>*1</p>  <p>(U.S.A.)</p>	<p>Brake system warning light (→P. 477)</p>	<p>*1</p> 	<p>Slip indicator (→P. 478)</p>
<p>*1</p>  <p>(Canada)</p>	<p>Brake system warning light (→P. 477)</p>	<p>*3</p>  <p>(if equipped)</p>	<p>Four-wheel drive indicator light (→P. 479)</p>
<p>*5</p> 	<p>High coolant temperature warning light (→P. 477)</p>	<p>*3</p>  <p>(if equipped)</p>	<p>Low speed four-wheel drive indicator light (→P. 479)</p>
<p>*1</p> 	<p>Charging system warning light (→P. 477)</p>	<p>*3</p>  <p>(if equipped)</p>	<p>Rear differential lock indicator light (→P. 478)</p>
<p>*1</p>  <p>(U.S.A.)</p>	<p>Malfunction indicator lamp (→P. 478)</p>	<p>*3</p>  <p>(if equipped)</p>	<p>Center differential lock indicator light (→P. 479)</p>
<p>*1</p>  <p>(Canada)</p>	<p>Malfunction indicator lamp (→P. 478)</p>	<p>*2, 4, 5</p>  <p>(if equipped)</p>	<p>Multi-terrain Select indicator light (→P. 479)</p>
<p>*1</p> 	<p>SRS warning light (→P. 478)</p>	<p>*5</p> 	<p>Brake Override System/Drive-Start Control/warning light (→P. 480)</p>
<p>*1</p>  <p>(U.S.A.)</p>	<p>ABS warning light (→P. 478)</p>	<p>PARK</p> <p>(U.S.A.)</p>	<p>Parking brake indicator (→P. 480)</p>
<p>*1</p>  <p>(Canada)</p>	<p>ABS warning light (→P. 478)</p>	<p>(P)</p> <p>(Canada)</p>	<p>Parking brake indicator (→P. 480)</p>

	*1 BSM OFF (Blind Spot Monitor) indicator (→P. 482)		*5 Low engine oil pressure warning light (→P. 477)
	*1 RCTA OFF (Rear Cross Traffic Alert) indicator (→P. 482)		*1 Power steering warning light (→P. 479)
(Flashes)			
	*1, 6 PCS warning light (→P. 481)		*1 Master warning light (→P. 488)
	*5 LDA indicator (→P. 481)		*1 Tire pressure warning light (→P. 481)
(Amber)			
	Open door warning light (→P. 479)		A/T P Unengaged "Park" warning light (→P. 479)
		(if equipped)	
	Low fuel level warning light (→P. 480)		*1 KDSS warning light (→P. 479)
		(if equipped)	
	Seat belt reminder light (→P. 480)		*1, 2 Automatic running boards indicator light (→P. 479)
		(if equipped)	

*1: These lights turn on when the engine switch is turned to IGNITION ON mode to indicate that a system check is being performed. They will turn off after the engine is started, or after a few seconds. There may be a malfunction in a system if a light does not come on, or turn off. Have the vehicle inspected by your Toyota dealer.

*2: This light flashes to indicate a malfunction.

*3: This light flashes rapidly to indicate a malfunction.





















*4: This light flashes continuously to indicate a malfunction.

*5: This light illuminates on the multi-information display.















*6: This light flashes or illuminates to indicate a malfunction.

Indicators

The indicators inform the driver of the operating state of the vehicle's various systems.

	Turn signal indicator (→P. 210)		*1 "TRAC OFF" indicator (→P. 324)
	Headlight indicator (→P. 212) (U.S.A.)		*1, 2 Slip indicator (→P. 323)
	Tail light indicator (→P. 212) (Canada)		*1 VSC OFF indicator (→P. 324)
	Headlight high beam indicator (→P. 214)		*1, 4 "AIR BAG ON/OFF" indicator (→P. 48) (U.S.A.)
	Automatic High Beam indicator (→P. 217)		*1, 4 "AIR BAG ON/OFF" indicator (→P. 48) (Canada)
	Front fog light indicator (→P. 221)		*5 Cruise control indicator (→P. 257)
	*4 Security indicator (→P. 78, 79)		*5 Dynamic radar cruise control indicator (→P. 257)
	*1, 3 Eco Driving Indicator Light (→P. 98)		*5 Cruise control set indica- tor (→P. 257)
	PARK (U.S.A.) Parking brake indicator (→P. 211)		*1, 6 PCS warning light (→P. 239)
	(P) (Canada) Parking brake indicator (→P. 211)		RCTA OFF (Rear Cross Traffic Alert) indicator (→P. 286)

2
Instrument cluster

*1, 6  OFF	BSM OFF (Blind Spot Monitor) indicator (→P. 270)	 (if equipped)	Center differential lock indicator (→P. 298)
*1, 7, 8  (if equipped)	Outside rear view mirror indicator (→P. 270)	 (if equipped)	"A-TRAC" indicator (→P. 302)
*5  (Green)	LDA indicator (→P. 249)	*1  (if equipped)	"AUTO LSD" indicator (→P. 304)
*2, 5  (Amber)	LDA indicator (→P. 249)	*5  (if equipped)	Multi-terrain Select indicator (→P. 315)
 (if equipped)	Four-wheel drive indicator (→P. 294)	*5  (if equipped)	Crawl Control indicator (→P. 312)
*1  (if equipped)	Downhill assist control system indicator (→P. 309)	 (if equipped)	Intuitive parking assist indicator (→P. 277)
 (if equipped)	Low speed four-wheel drive indicator (→P. 294, 298)	*1, 2  (if equipped)	Automatic running boards indicator (→P. 121)
 (if equipped)	Rear differential lock indicator (→P. 306)		

- *1: These lights turn on when the engine switch is turned to IGNITION ON mode to indicate that a system check is being performed. They will turn off after the engine is started, or after a few seconds. There may be a malfunction in a system if a light does not come on, or turn off. Have the vehicle inspected by your Toyota dealer.
- *2: This light flashes to indicate that the system is operating.
- *3: This light does not turn on when the system is disabled.
- *4: This light illuminates on the center panel.
- *5: This light illuminates on the multi-information display.
- *6: This light turns on when the system is off.
- *7: In order to confirm operation, the BSM outside rear view mirror indicators illuminate in the following situations:
 - When the engine switch is turned to IGNITION ON mode while the system is set to on.
 - When the system is set to on while the engine switch is in IGNITION ON mode.
- *8: This light illuminates on the outside rear view mirrors.

⚠ WARNING**■ If a safety system warning light does not come on**

Should a safety system light such as the ABS and SRS warning light not come on when you start the engine, this could mean that these systems are not available to help protect you in an accident, which could result in death or serious injury. Have the vehicle inspected by your Toyota dealer immediately if this occurs.

Gauges and meters

The displayed content may differ depending on the type of meter.

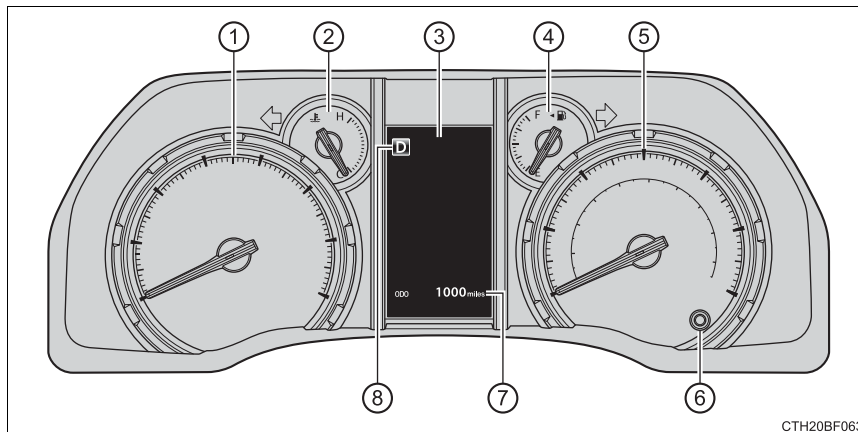

- ① Tachometer
Displays the engine speed in revolutions per minute
- ② Engine coolant temperature gauge
Displays the engine coolant temperature
- ③ Multi-information display
Presents the driver with a variety of vehicle data (→P. 90)
- ④ Fuel gauge
Displays the quantity of fuel remaining in the tank
- ⑤ Speedometer
Displays the vehicle speed
- ⑥ Odometer/trip meter display change button
Switches the trip information.
- ⑦ Odometer/trip meter display
- ⑧ Shift position and shift range
Displays the selected shift position or selected shift range (→P. 205)

Changing the display

Switches between odometer and trip meter displays. When the trip meter is displayed, pressing and holding the button will reset the trip meter.

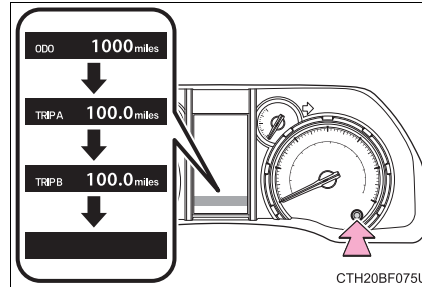

Instrument panel light control

The brightness of the instrument panel lights can be adjusted.

- ① Brighter
- ② Darker

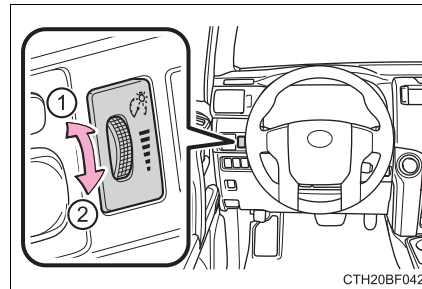

2

Instrument cluster

■ The meters and display illuminate when

The engine switch is in IGNITION ON mode.

■ The brightness of the instrument panel lights

When the headlight switch is turned to on, the brightness will be reduced slightly unless the control dial is turned fully upward.

⚠ NOTICE

■ To prevent damage to the engine and its components

- Do not let the indicator needle of the tachometer enter the red zone, which indicates the maximum engine speed.
- The engine may be overheating if the engine coolant temperature gauge is in the red zone (H). In this case, immediately stop the vehicle in a safe place, and check the engine after it has cooled completely. (→P. 519)

Multi-information display

Summary of functions

The multi-information display presents the driver with a variety of driving related data, such as the current outside temperature. The multi-information display can also be used to change the display settings and other settings.

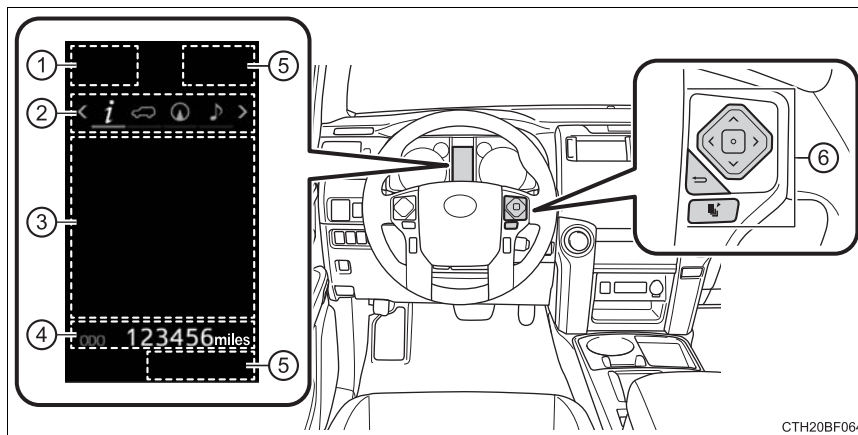

- ① Shift position and shift range (→P. 205)
- ② Menu icon display area
Displays the following items.
When a menu icon is not selected, the outside temperature is displayed.
 - Menu icons (→P. 92)
 - Outside temperature (→P. 98)
- ③ Content display area
A variety of information can be displayed by selecting a menu icon. Additionally, warning or pop-up display will be displayed in some situations.
 - Menu icon content (→P. 92)
 - Warning message (→P. 488)
- ④ Odometer and trip meter (→P. 88)
- ⑤ Indicators (→P. 82)
- ⑥ Meter control switches (→P. 91)

Operating the meter control switches

The multi-information display is operated using the meter control switches.

- ① Scroll screens*, change the displayed content* and move the cursor
- ② Press: Enter/Set
Press and hold:
Reset/Display the next screen
- ③ Press: Displays the screen registered as the top screen
When no screen has been registered, the drive information screen will be displayed.
Press and hold: Registers the currently displayed screen as the top screen

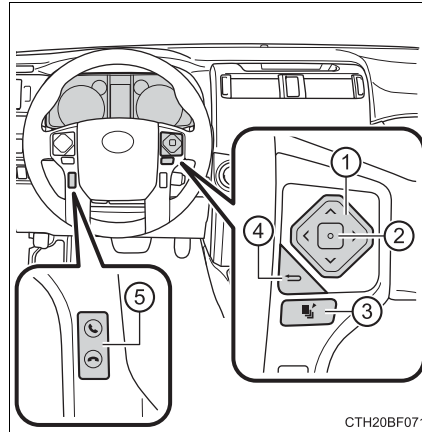

When the confirmation screen is displayed, select yes to register the screen. If the selected screen cannot be registered, a registration failure message will be shown.

- ④ Return to the previous screen
- ⑤ Call sending/receiving display
Linked with the hands-free system, sending or receiving call is displayed. For details regarding the hands-free system, refer to the "Navigation system owner's manual".

*: When the screen can be scrolled or different content can be displayed, a mark, such as an arrow, will be displayed to suggest which switch to operate.

Menu icons



Drive information

Select to display various drive data. (→P. 93)



Vehicle information display

Select to display the vehicle information. (→P. 95)



Navigation system-linked display (if equipped)

Select to display the following navigation system-linked information.

- Route guidance
- Compass display (north-up display/heading-up display)



Audio system-linked display (if equipped)

Select to enable selection of an audio source or track on the display using the meter control switches.



Driving assist system information

Select to display the operational status of the following systems:

- Dynamic radar cruise control (→P. 257)
- LDA (Lane Departure Alert) (→P. 249)



Warning message display

Select to display warning messages and measures to be taken if a malfunction is detected. (→P. 488)

- When there are no current warning messages, "No Messages" is displayed.
- When there are multiple warning messages, ^ or v can be used to switch the displayed warning message.



Settings display

Select to change the meter display settings and the operation settings of some vehicle functions. (→P. 95)

Drive information

Items displayed can be switched by pressing \wedge or \vee up and down.

■ After Start

- ① Average fuel economy*
Displays the average fuel consumption since the engine was started.
- ② Average vehicle speed
Displays the average vehicle speed since the engine was started.
- ③ Elapsed time
Displays the elapsed time since the engine was started.



*: Use the displayed average fuel economy as a reference.

■ After Reset

- ① Current fuel economy
Displays the current rate of fuel consumption.
- ② Average fuel economy*^{1,2}
Displays the average fuel consumption since the function was reset.
- ③ Average speed*²
Displays the average vehicle speed since the function was reset.



- ④ Elapsed time*²
Displays the elapsed time since the function was reset.

*¹: Use the displayed average fuel economy as a reference.

*²: Pressing and holding \square will reset.

■ After Refuel

① Range*^{1,2}

Displays the driving range with remaining fuel.

② Average fuel economy*^{2,3}

Displays the average fuel consumption since the vehicle was refueled.

*¹: This distance is computed based on your average fuel consumption. As a result, the actual distance that can be driven may differ from that displayed.

*²: When only a small amount of fuel is added to the tank, the display may not be updated. When refueling, turn the engine switch off. If the vehicle is refueled without turning the engine switch off, the display may not be updated.

*³: Use the displayed average fuel economy as a reference.

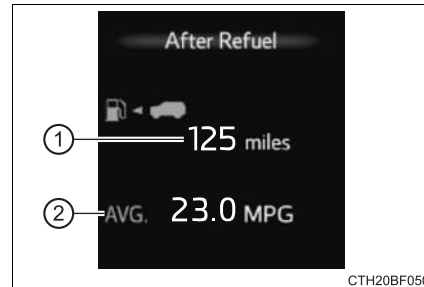

■ Eco Indicator (Eco Driving Indicator Zone Display)

→P. 98

■ Speed

Displays the vehicle speed.

■ Vehicle sway warning

Detects the sway of the vehicle within a lane, which is often associated with a decrease in the driver's attention level, and displays the decrease in attention using a bar display.

The shorter the bar length, the more the driver may need to rest.

This display is a part of the LDA (Lane Departure Alert) system. The display is enabled when the operating conditions of the vehicle sway warning function are met. (→P. 249)

■ Blank screen (display off)

Drive information is not displayed.

Vehicle information

Items displayed can be switched by pressing  or  up and down.

■ Steering angle

Displays the direction of the front tires.

The tire direction is displayed in 3 stages for both left and right, in accordance with the angle of the tire.

If a battery terminal is disconnected and reconnected, the display may be disabled temporarily. After driving the vehicle for a while, the display will be enabled.

■ Tire inflation pressure







Displays inflation pressure of each tire.

The inflation pressure of the spare tire will be displayed. (if equipped)

Settings display





The settings of some features can be changed by using the meter control switches.

■ Setting procedure

- 1 On the setting screen, choose the desired item using  or , and then press .
 - For functions that can be enabled or disabled, the function switches between on and off each time  is pressed.
 - For functions that allow to select operation contents, display contents, etc., the setting screen is displayed.
- 2 Select the desired setting by operating  or , and then press .



To stop the selection, press  to return to the previous screen.

■ Setting items

-  LDA (Lane Departure Alert)
Select to set up LDA. (→P. 560)
 - Alert sensitivity
 - Sway warning
 - Sway sensitivity
-  BSM (Blind Spot Monitor)
Select to activate/deactivate BSM. (→P. 558)
 - BSM on/off
 - BSM sensitivity
 - Outside rear view mirror indicator brightness
-  RCTA (Rear Cross Traffic Alert)
Select to activate/deactivate RCTA. (→P. 558)
 - RCTA on/off
-  PCS (Pre-Collision System)
Select to set the following items. (→P. 242)
 - PCS on/off
 - PCS sensitivity
-  Intuitive parking assist (if equipped)
Select to set the Intuitive parking assist on/off
- Vehicle settings
 - “TPWS” (Tire Pressure Warning System) (→P. 430)
 - “Set Pressure”
Select to initialize the tire pressure warning system.
 - “Change Wheel Set”
Select to register the ID codes of the tire pressure sensors to the tire pressure warning system.³

● Meter settings (→P. 559)

Select to set the following items.

- Language
Select to change the language on the display.
- Units
Select to change the unit for measure.
-  Eco Driving Indicator Light
Select to activate/deactivate the Eco Driving Indicator Light.
(→P. 98)
-  switch settings
You can register 1 screen as the top screen. To register, press and hold  while the desired screen is displayed.
- Pop-up display
Select to set the pop-up displays (→P. 99), which may appear in some situations, on/off.
- Initialization
Select to reset the meter display settings.

Other contents

■ Multi-terrain Select display* (if equipped)

→P. 315

■ Crawl Control display* (if equipped)

→P. 312

■ Outside temperature display

Displays the outside temperature

The temperature range that can be displayed is from -40 °F (-40 °C) to 122 °F (50 °C).

When the outside temperature drops below 37 °F (3 °C),  will flash approximately 10 seconds, then stay on.

■ Customization

Settings (e.g. available language) can be changed.
(Customizable features: →P. 549)

*: Automatically displayed when the system is used

■ Eco Driving Indicator

- ① Eco Driving Indicator Light
- ② Eco Driving Indicator Zone Display
Suggests the Zone of Eco driving with current Eco driving ratio based on acceleration.
- ③ Eco driving ratio based on acceleration
If the acceleration exceeds Zone of Eco driving, the right side of Eco Driving Indicator Zone Display will illuminate.
- ④ Zone of Eco driving
Eco Driving Indicator will not operate under the following conditions:
 - The shift lever is in any position other than D.
 - The vehicle speed is approximately 80 mph (130 km/h) or higher.
 - The Crawl Control is operating. (if equipped) (→P. 312)

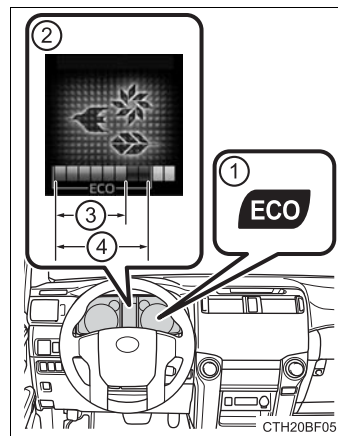

■ Pop-Up display

The pop-up display is displayed on the multi-information display according to the operating conditions of the following functions:

- Route guidance display of the navigation system-linked system (if equipped)
- Incoming call display of the hands-free phone system

The pop-up display function can be disabled.

■ Tire inflation pressure

● It may take a few minutes to display the tire inflation pressure after the engine switch is turned to IGNITION ON mode. It may also take a few minutes to display the tire inflation pressure after inflation pressure has been adjusted.

● “---” may be displayed if the tire information cannot be determined due to unfavorable radio wave conditions.

● Tire inflation pressure changes with temperature. The displayed values may also be different from the values measured using a tire pressure gauge.

■ Outside temperature display

In the following situations, the correct outside temperature may not be displayed, or the display may take longer than normal to change:

- When the vehicle is stopped, or moving at low speeds (less than 12 mph [20 km/h])
- When the outside temperature has changed suddenly (at the entrance/exit of a garage, tunnel, etc.)
- When “--” or “E” is displayed, the system may be malfunctioning. Take your vehicle to Toyota dealer.

■ Liquid crystal display

Small spots or light spots may appear on the display. This phenomenon is characteristic of liquid crystal displays, and there is no problem continuing to use the display.

 **WARNING****■ Caution for use while driving**

For safety, avoid operating the meter control switches while driving as much as possible, and do not look continuously at the multi-information display while driving. Stop the vehicle and operate the meter control switches. Failure to do so may cause a steering wheel operation error, resulting in an unexpected accident.

■ Cautions while setting up the display

As the engine needs to be running during setting up the display, ensure that the vehicle is parked in a place with adequate ventilation. In a closed area such as a garage, exhaust gases including harmful carbon monoxide (CO) may collect and enter the vehicle. This may lead to death or a serious health hazard.

■ The multi-information display at low temperatures

Allow the interior of the vehicle to warm up before using the multi-information display. At extremely low temperatures, the multi-information display monitor may respond slowly, and display changes may be delayed.

For example, there is a lag between the driver's shifting and the new gear number appearing on the display. This lag could cause the driver to down-shift again, causing rapid and excessive engine braking and possibly an accident resulting in death or serious injury.

 **NOTICE****■ While setting up the display**

To prevent battery discharge, ensure that the engine is running while setting up the display features.

3-1. Key information	
Keys	102
Side doors	106
3-2. Opening, closing and locking the doors	
Smart key system	113
Automatic running boards	121
Back door	124
3-3. Adjusting the seats	
Front seats	129
Rear seats	132
Driving position memory ...	142
Head restraints	146
3-4. Adjusting the steering wheel and mirrors	
Steering wheel	149
Inside rear view mirror	151
Outside rear view mirrors	153
3-5. Opening, closing the windows and moon roof	
Power windows	155
Power back window	158
Moon roof	161

Keys

The keys

The following keys are provided with the vehicle.

- ① Electronic keys
 - Operating the smart key system (→P. 113)
 - Operating the wireless remote control function
- ② Mechanical keys
- ③ Key number plate

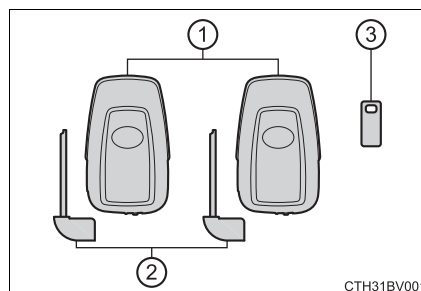

Wireless remote control

- ① Locks all the doors (→P. 106)
- ② Unlocks all the doors (→P. 106)

Pressing the button unlocks the driver's door. Pressing the button again within 3 seconds unlocks the other doors.
- ③ Opens the windows and moon roof (press and hold)*
- ④ Sounds the alarm (press and hold) (→P. 103)

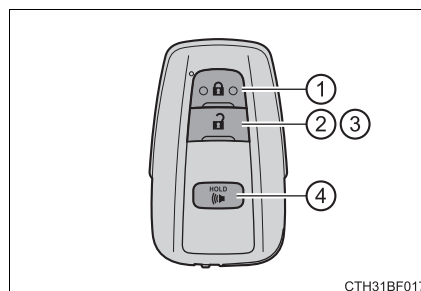

*: This setting must be customized at your Toyota dealer.

Using the mechanical key

To take out the mechanical key, push the release button and take the key out.

The mechanical key can only be inserted in one direction, as the key only has grooves on one side. If the key cannot be inserted in a lock cylinder, turn it over and re-attempt to insert it.

After using the mechanical key, store it in the electronic key. Carry the mechanical key together with the electronic key. If the electronic key battery is depleted or the entry function does not operate properly, you will need the mechanical key. (→P. 512)

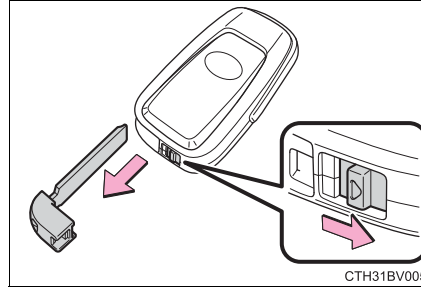

■ Panic mode

When (Panic) is pressed for longer than about one second, an alarm will sound intermittently and the vehicle lights will flash to deter any person from trying to break into or damage your vehicle.

To stop the alarm, press any button on the electronic key.



■ When required to leave the vehicle's key with a parking attendant

Lock the glove box as circumstances demand. (→P. 364)

Remove the mechanical key for your own use and provide the attendant with the electronic key only.

■ If you lose your mechanical keys

New genuine mechanical keys can be made by your Toyota dealer using the other mechanical key and the key number stamped on your key number plate. Keep the plate in a safe place such as your wallet, not in the vehicle.

■ When riding in an aircraft

When bringing a key with wireless remote control function onto an aircraft, make sure you do not press any buttons on the key while inside the aircraft cabin. If you are carrying the key in your bag etc., ensure that the buttons are not likely to be pressed accidentally. Pressing a button may cause the key to emit radio waves that could interfere with the operation of the aircraft.

■ Conditions affecting operation

→P. 117

■ Key battery depletion

- The standard battery life is 1 to 2 years.
- If the battery becomes low, an alarm will sound in the cabin when the engine stops.
- As the electronic key always receives radio waves, the battery will become depleted even if the electronic key is not used. The following symptoms indicate that the electronic key battery may be depleted. Replace the battery when necessary. (→P. 447)
 - The smart key system or the wireless remote control does not operate.
 - The detection area becomes smaller.
 - The LED indicator on the key surface does not turn on.
- To avoid serious deterioration, do not leave the electronic key within 3 ft. (1 m) of the following electrical appliances that produce a magnetic field:
 - TVs
 - Personal computers
 - Cellular phones, cordless phones and battery chargers
 - Recharging cellular phones or cordless phones
 - Table lamps
 - Induction cookers

■ Precautions when disconnecting the battery

- In some cases, it may not be possible to unlock the doors using the smart key system immediately after the battery has been disconnected. Use the wireless remote control or the mechanical key to lock or unlock the doors.
- The engine may not start on the first attempt after reconnecting the battery but will start normally after the second attempt. This is not a malfunction.
- The engine switch mode is memorized by the vehicle. When the battery is reconnected, the system will return to the mode it was in before the battery was disconnected. Before disconnecting the battery, turn the engine switch off.

If you are unsure what mode the engine switch was in when the battery was disconnected, be especially careful when reconnecting the battery.

■ Replacing the battery

→P. 447

■ Confirmation of the registered key number

The number of keys already registered to the vehicle can be confirmed. Ask your Toyota dealer for details.

■ If a wrong key is used

The key cylinder rotates freely to isolate inside mechanism.

 NOTICE**■ To prevent key damage**

- Do not drop the keys, subject them to strong shocks or bend them.
- Do not expose the keys to high temperatures for long periods of time.
- Do not get the keys wet or wash them in an ultrasonic washer etc.
- Do not attach metallic or magnetic materials to the keys or place the keys close to such materials.
- Do not disassemble the keys.
- Do not attach a sticker or anything else to the surface of the electronic key.
- Do not place the keys near objects that produce magnetic fields, such as TVs, audio systems and induction cookers, or medical electrical equipment, such as low-frequency therapy equipment.

■ Carrying the electronic key on your person

Carry the electronic key 3.9 in. (10 cm) or more away from electric appliances that are turned on. Radio waves emitted from electric appliances within 3.9 in. (10 cm) of the electronic key may interfere with the key, causing the key to not function properly.

■ In case of a smart key system malfunction or other key-related problems

Take your vehicle with all the electronic keys provided with your vehicle to your Toyota dealer.

■ When an electronic key is lost

If the electronic key remains lost, the risk of vehicle theft increases significantly. Visit your Toyota dealer immediately with all remaining electronic keys that was provided with your vehicle.

Side doors

Unlocking and locking the doors from the outside

◆ Smart key system

Carry the electronic key to enable this function.

- ① Grip the driver's door handle to unlock the door. Grip the passenger's door handle to unlock all the doors.

Make sure to touch the sensor on the back of the handle.

The doors cannot be unlocked for 3 seconds after the doors are locked.

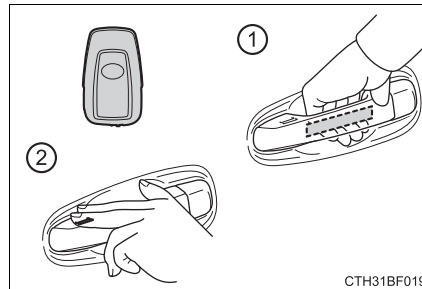

- ② Touch the lock sensor (the indentation on the upper part of the door handle) to lock the doors.

Check that the door is securely locked.

◆ Wireless remote control

- ① Locks all the doors

Check that the door is securely locked.

- ② Unlocks all the doors

Pressing the button unlocks the driver's door. Pressing the button again within 3 seconds unlocks the other doors.

Press and hold to open the windows and moon roof.*

(→P. 156, 163)

*: This setting must be customized at your Toyota dealer.

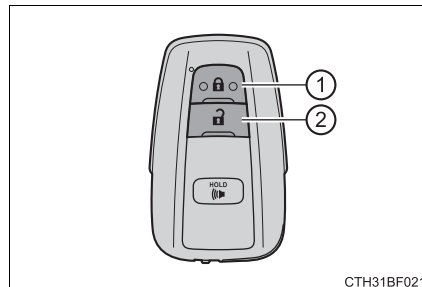

◆ Key

Turning the key operates the doors as follows:

The doors can also be locked and unlocked with the mechanical key. (→P. 512)

■ Operation signals

A buzzer sounds and the emergency flashers flash to indicate that the doors have been locked/unlocked. (Locked: once; Unlocked: twice)

■ Security feature

If a door is not opened within approximately 60 seconds after the vehicle is unlocked, the security feature automatically locks the vehicle again. (However, depending on the location of the electronic key, the key may be detected as being in the vehicle. In this case, vehicle may be unlocked.)

■ When the door cannot be locked by the lock sensor on the upper part of the door handle

If the door will not lock even when the top-side sensor area is touched, try touching both the topside and underside sensor areas at the same time.

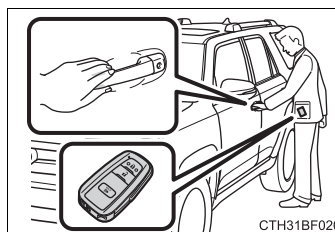
**■ Door lock buzzer**

If an attempt to lock the doors is made when a door is not fully closed, a buzzer sounds continuously. Fully close the door to stop the buzzer, and lock the vehicle once more.

■ Alarm (if equipped)

Locking the doors will set the alarm system. (→P. 79)

■ If the smart key system or the wireless remote control does not operate properly

Use the mechanical key to lock and unlock the doors. (→P. 512)

Replace the battery with a new one if it is depleted. (→P. 447)

Unlocking and locking the doors from the inside

◆ Door lock switches

- ① Locks all the doors
- ② Unlocks all the doors

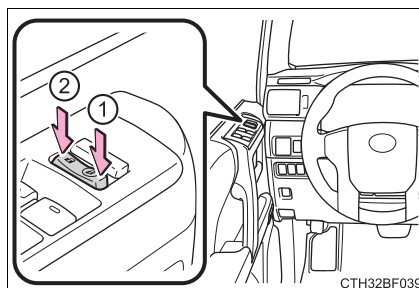

CTH32BF039

◆ Inside lock buttons

- ① Locks the door
- ② Unlocks the door

The front doors can be opened by pulling the inside handle even if the lock buttons are in the lock position.

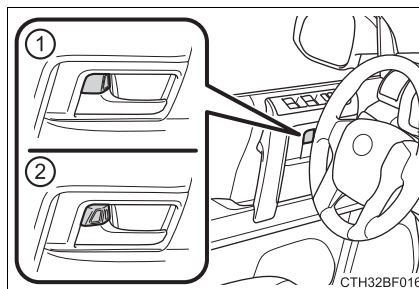

CTH32BF016

Locking the doors from the outside without a key

- 1 Move the inside lock button to the lock position.
- 2 Close the door.

The door cannot be locked if the engine switch is in ACCESSORY or IGNITION ON mode, or the electronic key is left inside the vehicle. However, the key may not be detected correctly and the door may be locked.

Rear door child-protector lock

The door cannot be opened from inside the vehicle when the lock is set.

- ① Unlock
- ② Lock

These locks can be set to prevent children from opening the rear doors. Push down on each rear door switch to lock both rear doors.

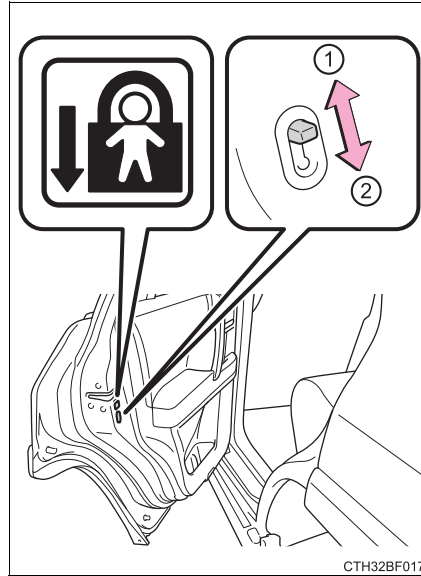

CTH32BF017

Automatic door locking and unlocking systems

The following functions can be set or canceled:

For instructions on customizing, refer to P. 549.

Function	Operation
Speed linked door locking function	All doors are automatically locked when vehicle speed is approximately 12 mph (20 km/h) or higher.
Shift position linked door locking function	All doors are automatically locked when shifting the shift lever to position other than P.
Shift position linked door unlocking function	All doors are automatically unlocked when shifting the shift lever to P.
Driver's door linked door unlocking function	All doors are automatically unlocked when driver's door is opened within 10 seconds after turning the engine switch off.

■ **Setting and canceling the functions**

To switch between setting and canceling, follow the procedure below:

- 1 Close all the doors and turn the engine switch to IGNITION ON mode. (Perform step 2 within 20 seconds.)

- 2 Shift the shift lever to P or N, and press and hold the driver's door lock switch (🔒 or 🔓) for approximately 5 seconds and then release.

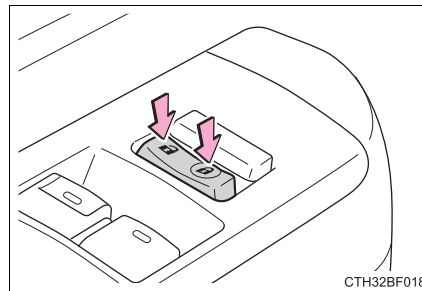

The shift lever and switch positions corresponding to the desired function to be set are shown in the following table.



Use the same procedure to cancel the function.

Function	Shift lever position	Driver's door lock switch position
Shift position linked door locking function	P	🔒
Shift position linked door unlocking function		🔓
Speed linked door locking function	N	🔒
Driver's door linked door unlocking function		🔓

When the setting or canceling operation is complete, all the doors are locked and then unlocked.

■ Switching the door unlock function

It is possible to set which doors the entry function unlocks using the wireless remote control.

- 1 Turn the power switch off.
- 2 When the indicator light on the key surface is not on, press and hold  or  for about 5 seconds while pressing and holding .

The setting changes each time an operation is performed, as shown below. (When changing the setting continuously, release the buttons, wait for at least 5 seconds, and repeat step 2.)

Unlocking doors	Beep
Holding the driver's door handle unlocks only the driver's door.	Exterior: Beeps 3 times Interior: Beeps once
Holding the front passenger's door handle unlocks all the doors.	
Holding either front door handle unlocks all the doors.	Exterior: Beeps twice Interior: Beeps once

■ Rear seat reminder function

In order to remind you not to forget luggage, etc. in the rear seat, when the engine switch is turned off after any of the following conditions are met, a buzzer will sound and a message will be displayed on the multi-information display for approximately 6 seconds.

- The engine is started within 10 minutes after opening and closing a rear door.
- A rear door has been opened and closed after the engine was started.

However, if a rear door is opened and then closed within approximately 2 seconds, the rear seat reminder function may not operate.

The rear seat reminder function determines that luggage, etc. has been placed in a rear seat based on opening and closing of a rear door. Therefore, depending on the situation, the rear seat reminder function may not operate and you may still forget luggage, etc. in the rear seat, or it may operate unnecessarily.

The rear seat reminder function can be enabled/disabled. (→P. 559)

■ Customization

Settings (e.g. unlocking function using a key) can be changed. (Customizable features: →P. 549)

 WARNING

■ **To prevent an accident**

Observe the following precautions while driving the vehicle.
Failure to do so may result in a door opening and an occupant throwing out of the vehicle, resulting in death or serious injury.

- Ensure that all doors are properly closed and locked.
- Do not pull the inside handle of the doors while driving.
Be especially careful for the front doors, as the doors may be opened even if the inside lock buttons are in locked position.
- Set the rear door child-protector locks when children are seated in the rear seats.

Smart key system

Function summary

The following operations can be performed simply by carrying the electronic key on your person, for example in your pocket. (The driver should always carry the electronic key.)

- Locks and unlocks the doors (→P. 106)
- Starts the engine (→P. 199)

■ Antenna location

- ① Antennas outside the cabin
- ② Antennas inside the cabin
- ③ Antenna outside the luggage compartment

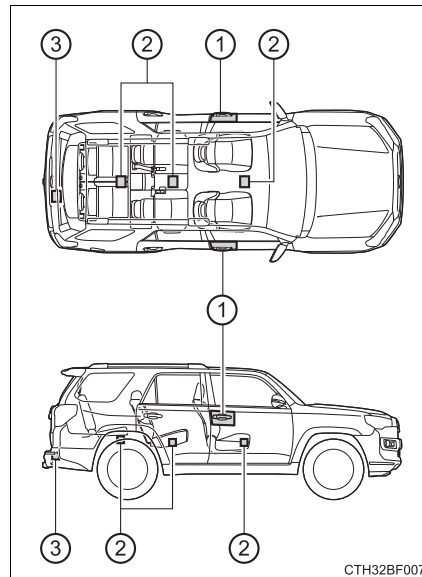

CTH32BF007

3

Operation of each component

■ **Effective range (areas within which the electronic key is detected)**

- When locking or unlocking the doors

The system can be operated when the electronic key is within about 2.3 ft. (0.7 m) either of the outside front door handles and back door. (Only the doors detecting the key can be operated.)

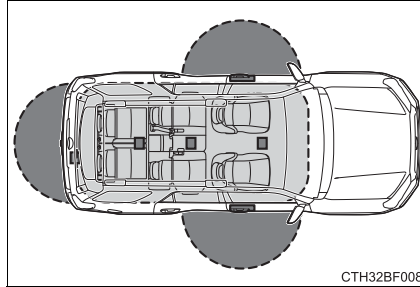

- When starting the engine or changing engine switch modes

The system can be operated when the electronic key is inside the vehicle.

■ Alarms and warning indicators

A combination of exterior and interior alarms as well as warning messages shown on the multi-information display are used to prevent theft of the vehicle and accidents resulting from erroneous operation. Take appropriate measures in response to any warning message on the multi-information display.

The following table describes circumstances and correction procedures when only alarms are sounded.

Alarm	Situation	Correction procedure
Exterior alarm sounds once for 5 seconds	An attempt was made to lock the doors using the smart key system while the electronic key was still inside the vehicle.	Retrieve the electronic key from the vehicle and lock the doors again.
	An attempt was made to lock either front door by opening a door and putting the inside lock button into the lock position, then closing the door by pulling on the outside door handle with the electronic key still inside the vehicle.	
	An attempt was made to lock the vehicle while a door was open.	Close all of the doors and lock the doors again.
Interior alarm sounds continuously	An attempt was made to open the door and exit the vehicle when the shift lever was not in P.	Shift the shift lever to P.
Interior alarm pings repeatedly	The engine switch was turned to ACCESSORY mode while the driver's door was open (The driver's door was opened when the engine switch was in ACCESSORY mode.)	Turn the engine switch off and close the driver's door.

Alarm	Situation	Correction procedure
Interior alarm sounds once.	The engine switch was pressed after the doors were unlocked with the mechanical key.	Touch the electronic key to the engine switch while depressing the brake pedal.
	The engine switch was pressed two consecutive times without the electronic key being present.	



■ Battery-saving function

The battery-saving function will be activated in order to prevent the electronic key battery and the vehicle battery from being discharged while the vehicle is not in operation for a long time.

- In the following situations, the smart key system may take some time to unlock the doors.
 - The electronic key has been left in an area of approximately 6 ft. (2 m) of the outside of the vehicle for 10 minutes or longer.
 - The smart key system has not been used for 5 days or longer.
- If the smart key system has not been used for 14 days or longer, the doors cannot be unlocked at any doors except the driver's door. In this case, take hold of the driver's door handle, or use the wireless remote control or the mechanical key, to unlock the doors.

■ Electronic key battery-saving function

When battery-saving mode is set, battery depletion is minimized by stopping the electronic key from receiving radio waves.

Press  twice while pressing and holding . Confirm that the electronic key indicator flashes 4 times.

While the battery-saving mode is set, the smart key system cannot be used. To cancel the function, press any of the electronic key buttons.

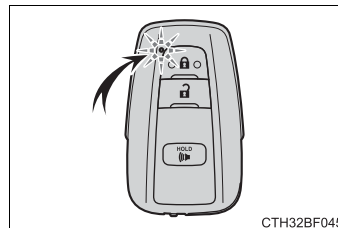

■ Conditions affecting operation

The smart key system uses weak radio waves. In the following situations, the communication between the electronic key and the vehicle may be affected, preventing the smart key system, wireless remote control and engine immobilizer system from operating properly. (Ways of coping: →P. 512)

- When the electronic key battery is depleted
- Near a TV tower, electric power plant, gas station, radio station, large display, airport or other facility that generates strong radio waves or electrical noise
- When carrying a portable radio, cellular phone, cordless phone or other wireless communication device
- When the electronic key is in contact with, or is covered by the following metallic objects
 - Cards to which aluminum foil is attached
 - Cigarette boxes that have aluminum foil inside
 - Metallic wallets or bags
 - Coins
 - Hand warmers made of metal
 - Media such as CDs and DVDs
- When multiple electronic keys are in the vicinity
- When other wireless keys (that emit radio waves) are being used nearby
- When carrying the electronic key together with the following devices that emit radio waves
 - Another vehicle's electronic key or a wireless key that emits radio waves
 - Personal computers or personal digital assistants (PDAs)
 - Digital audio players
 - Portable game systems
- If window tint with a metallic content or metallic objects are attached to the back window
- When the electronic key is placed near a battery charger or electronic devices
- When the vehicle is parked in a pay parking spot where radio waves are emitted.

If the doors cannot be locked/unlocked using the smart key system, lock/unlock the doors by performing any of the following:

- Bring the electronic key close to either front door handle and operate the entry function.
- Operate the wireless remote control.

If the doors cannot be locked/unlocked using the above methods, use the mechanical key. (→P. 512)

If the engine cannot be started using the smart key system, refer to P. 513.

■ Note for the entry function

- Even when the electronic key is within the effective range (detection areas), the system may not operate properly in the following cases:
 - The electronic key is too close to the window or outside door handle, near the ground, or in a high place when the doors are locked or unlocked.
 - The electronic key is on the instrument panel or floor, in the glove box, or in the auxiliary box of the instrument panel.
- Do not leave the electronic key on top of the instrument panel or near the door pockets when exiting the vehicle. Depending on the radio wave reception conditions, it may be detected by the antenna outside the cabin and the door will become lockable from the outside, possibly trapping the electronic key inside the vehicle.
- As long as the electronic key is within the effective range, the doors may be locked or unlocked by anyone. However, only the doors detecting the electronic key can be used to unlock the vehicle.
- The doors may lock or unlock if the electronic key is within the effective range and a large amount of water splashes on the door handle, such as in the rain or in a car wash. The doors will automatically be locked after approximately 60 seconds if a door is not opened and closed.
- If the wireless remote control is used to lock the doors when the electronic key is near the vehicle, there is a possibility that the door may not be unlocked by the entry function. (Use the wireless remote control to unlock the doors.)
- Whether or not the electronic key is inside the vehicle, the engine could be started if the electronic key is near the window.

■ Note for locking the doors

- Touching the door lock sensor while wearing gloves may delay or prevent lock operation. Remove the gloves and touch the lock sensor again.
- When the lock operation is performed using the lock sensor, recognition signals will be shown up to two consecutive times. After this, no recognition signals will be given.
- If the door handle becomes wet while the electronic key is within the effective range, the door may lock and unlock repeatedly. Place the electronic key in a location 6 ft. (2 m) or more away from the vehicle while the vehicle is being washed. (Take care to ensure that the key is not stolen.)
- If the electronic key is inside the vehicle and a door handle becomes wet during a car wash, a buzzer will sound outside the vehicle. To turn off the alarm, lock all the doors.
- The lock sensor may not work properly if it comes into contact with ice, snow, mud, etc. Clean the lock sensor and attempt to operate it again, or use the lock sensor on the lower part of the door handle.
- Fingernails may scrape against the door during operation of the door handle. Be careful not to injure fingernails or damage the surface of the door.

■ Note for the unlocking function

- Gripping the door handle when wearing a glove may not unlock the door.
- A sudden approach to the effective range or door handle may prevent the doors from being unlocked. In this case, return the door handle to the original position and check that the doors unlock before pulling the door handle again.
- If there is another electronic key in the detection area, it may take slightly longer to unlock the doors after the door handle is gripped.

■ When the vehicle is not driven for extended periods

- To prevent theft of the vehicle, do not leave the electronic key within 6 ft. (2 m) of the vehicle.
- The smart key system can be deactivated in advance. Ask your Toyota dealer for details.
- Setting the electronic key to battery- saving mode helps to reduce key battery depletion. (→P. 116)

■ To operate the system properly

- Make sure to carry the electronic key when operating the system. Do not get the electronic key too close to the vehicle when operating the system from the outside of the vehicle.
- Depending on the position and holding condition of the electronic key, the key may not be detected correctly and the system may not operate properly. (The alarm may go off accidentally, or the door lock prevention function may not operate.)

■ If the smart key system does not operate properly

- Locking and unlocking the doors: Use the mechanical key. (→P. 512)
- Starting the engine: →P. 513

■ Customization

Settings (e. g. operation signal) can be changed.
(Customizable features: →P. 549)

■ If the smart key system has been deactivated in a customized setting

- Locking and unlocking the doors: →P. 512
- Starting the engine and changing engine switch modes: →P. 513
- Stopping the engine: →P. 200

 **WARNING****■ Caution regarding interference with electronic devices**

- People with implantable cardiac pacemakers, cardiac resynchronization therapy-pacemakers or implantable cardioverter defibrillators should keep away from the smart key system antennas.

(→P. 113)

The radio waves may affect the operation of such devices. If necessary, the entry function can be disabled. Ask your Toyota dealer for details, such as the frequency of radio waves and timing of the emitted radio waves. Then, consult your doctor to see if you should disable the entry function.

- Users of any electrical medical device other than implantable cardiac pacemakers, cardiac resynchronization therapy-pacemakers or implantable cardioverter defibrillators should consult the manufacturer of the device for information about its operation under the influence of radio waves.

Radio waves could have unexpected effects on the operation of such medical devices.

Ask your Toyota dealer for details on disabling the entry function.

Automatic running boards*

The Automatic running boards are linked to the side door operations, extending and retracting when a side door is opened and closed. When a door is opened or closed, the board on the same side extends or retracts.

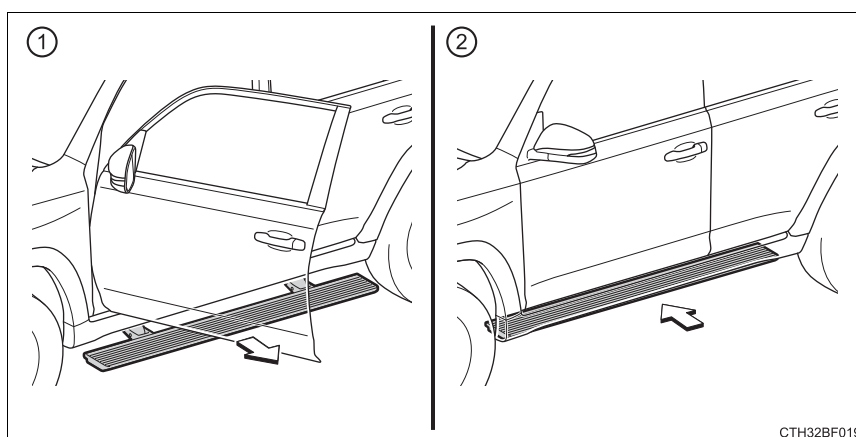

- ① Opening a door: The appropriate board extends
- ② Closing a door: The appropriate board retracts

Turning off the Automatic running boards system

Press "OFF" on the Automatic running boards switch to turn off the Automatic running boards system.

- ① On (Automatic mode)
- ② Off

The orange line at the top of the switch illuminates to indicate that the Automatic running boards system is on.

When extension of the boards is not necessary, or extension of a board is not desirable due to an obstacle, turn the Automatic running boards switch off before opening the side door.

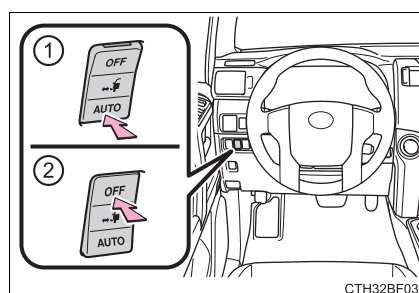

*: If equipped

■ Jam protection function

During Automatic running boards operation:

If a board contacts an obstacle when extending, it will retract. If an obstacle gets caught between a board and the vehicle when retracting, the board will extend.

If an obstacle is detected 3 times in a row during Automatic running boards operation, the board will stop at the position it contacts the obstacle. When a side door on the same side as the board is opened and closed one more time, the board will extend and retract, or retract and extend. After this, the board will resume normal operation.

■ Automatic retraction function

The boards will be automatically retracted, for safety, under the following conditions:

- A board is not completely retracted
- Vehicle speed is approximately 5 mph (8 km/h) or higher

The boards will not automatically extend again when vehicle speed returns to less than 5 mph (8 km/h).

■ If the Automatic running boards indicator comes on when driving first commences

A board has not completely retracted. Check that nothing is caught between the board and the vehicle.

Additionally, if the engine is started immediately after a door has been closed, the automatic running board may not retract completely and the automatic running boards indicator may illuminate. In this case, open and close the door to retract the running board and turn off the indicator.

■ If the Automatic running boards indicator light flashes

There may be a malfunction in the Automatic running boards system. Have the vehicle inspected by your Toyota dealer immediately.

■ When snow or mud is attached to the board or the board is frozen

The Automatic running boards may not operate correctly. Before stepping on a board, check that it is completely extended. If the Automatic running boards are not operating correctly, turn the Automatic running boards switch off and refrain from use.

When removing snow or mud, turn the Automatic running boards switch off.

■ After recharging/reconnecting the battery

If the Automatic running boards have not completely extended or retracted, the boards may not move in the intended direction the first time they are operated. However, from the second time onwards, the boards will resume normal operation.

■ When getting in and out of the vehicle

Take care because clothes and shoes may become dirty due to contact with the lower part of the vehicle body.

 **WARNING****■ Jam protection function**

Observe the following precautions.

Failure to do so may cause serious injury.

Never use any part of your body to intentionally activate the jam protection function.

The jam protection function may not work depending on the shape of the object that is caught. Be careful not to get fingers or other body parts caught.

■ Cautions regarding the Automatic running boards

Observe the following precautions.

Failure to do so may cause serious injury.

- Check to make sure that all passengers and people in the vehicle's surrounding area do not have a hand on a board or any part of their body in a position where it could be caught between a board and the vehicle when an Automatic running board is being operated.
- Confirm that the boards have completely extended or retracted before getting in or out of the vehicle. If someone gets in or out of the vehicle during Automatic running board operation, the boards may stop extending or retracting.
- Drive the vehicle after confirming that the boards have completely retracted. Driving with a board extended is dangerous because it may hit other people or objects.
- Take care when pressing the Automatic running boards switch. The board will extend or retract and may hit other people or objects.
- Always check that the Automatic running boards switch is turned off when cleaning a board.
- Do not allow children to operate the Automatic running boards. Operating Automatic running boards in a manner so that a board contacts someone can cause serious injury, and in some instances, even death.

Back door

Unlocking and locking the back door from the outside

◆ Smart key system

Carry the electronic key to enable this function.

- ① Press the button to unlock the door.
- ② Press the button to lock the door.

Check that the door is securely locked.

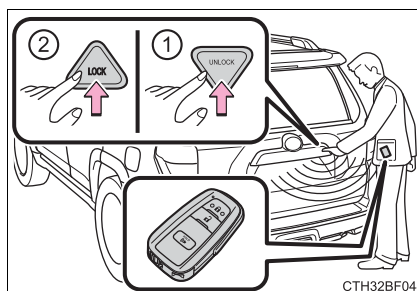

◆ Wireless remote control

→P. 106

Unlocking and locking the back door from the inside

- ① Locks all the doors
- ② Unlocks all the doors

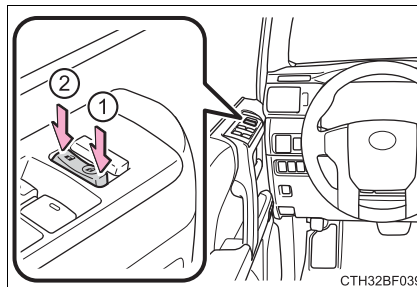

Opening the back door from outside the vehicle

Raise the back door while pushing up the back door opener switch.

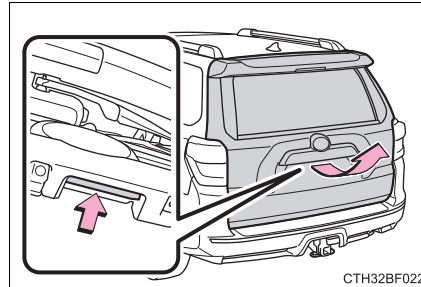
**Rear step bumper**

The rear step bumper is intended for rear end protection and easier step-up loading.

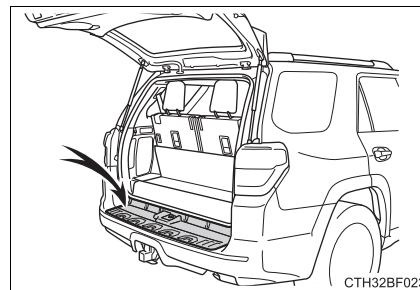
**When closing the back door**

Lower the back door using the back door strap and/or the back door handle, and make sure to push the back door down from the outside to close it.

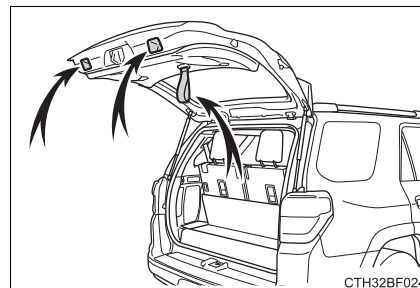

3

Operation of each component

■ Luggage compartment lights

Each luggage compartment light has the following 3 positions:

- ① Turns the light off
- ② Turns the light on
- ③ Turns the light on/off linked to back door position

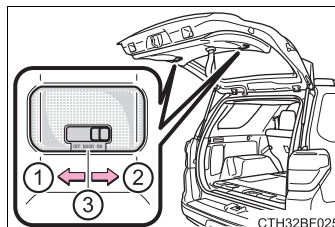

If the luggage compartment lights remain on, the lights will go off automatically after 20 minutes.

■ If the back door opener is inoperative or the battery is discharged

→P. 511

⚠ WARNING**■ Before driving**

Observe the following precautions.

Failure to do so may result in death or serious injury.

- Make sure that the back door is fully closed. If the back door is not fully closed, it may open unexpectedly while driving and hit near-by objects or luggage in the luggage compartment may be thrown out, causing an accident.
- Do not allow children to play in the luggage compartment.
If a child is accidentally locked in the luggage compartment, they could have heat exhaustion or other injuries.
- Do not allow a child to open or close the back door.
Doing so may cause the back door to move unexpectedly, or cause the child's hands, head, or neck to be caught by the closing back door.
- Do not get on the rear step bumper.

■ Important points while driving

Never let anyone sit in the luggage compartment. In the event of sudden braking or a collision, they are susceptible to death or serious injury.

⚠ WARNING**■ Operating the back door**

Observe the following precautions.

Failure to do so may cause parts of the body to be caught, resulting in death or serious injury.

- Remove any heavy loads, such as snow and ice, from the back door before opening it. Failure to do so may cause the back door to suddenly shut again after it is opened.
- When opening or closing the back door, thoroughly check to make sure the surrounding area is safe.
- If anyone is in the vicinity, make sure they are safe and let them know that the back door is about to open or close.
- Use caution when opening or closing the back door in windy weather as it may move abruptly in strong wind.

- The back door may suddenly shut if it is not opened fully. It is more difficult to open or close the back door on an incline than on a level surface, so beware of the back door unexpectedly opening or closing by itself. Make sure that the back door is fully open and secure before using the luggage compartment.

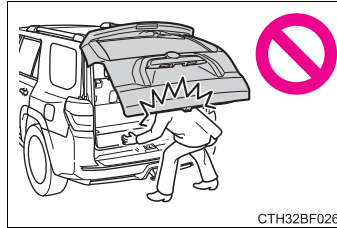

- When closing the back door, take extra care to prevent your fingers etc. from being caught.
- When closing the back door, make sure to press it lightly on its outer surface. If the back door handle or back door strap is used to fully close the back door, it may result in hands or arms being caught.

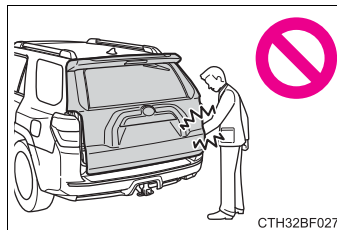

- Do not pull on the back door damper stay to close the back door, and do not hang on the back door damper stay. Doing so may cause hands to be caught or the back door damper stay to break, causing an accident.
- If a bicycle carrier or similar heavy object is attached to the back door, it may suddenly shut again after being opened, causing someone's hands, head or neck to be caught and injured. When installing an accessory part to the back door, using a genuine Toyota part is recommended.

 NOTICE**■ To prevent damage to the back door components**

Do not allow more than one person to get on the rear step bumper at a time.

■ Back door damper stays

The back door is equipped with damper stays that hold the back door in place.

Observe the following precautions.

Failure to do so may cause damage to the back door damper stay, resulting in malfunction.

- Do not attach any foreign objects, such as stickers, plastic sheets, or adhesives to the damper stay rod.
- Do not touch the damper stay rod with gloves or other fabric items.
- Do not attach any accessories other than genuine Toyota parts to the back door.
- Do not place your hand on the damper stay or apply lateral forces to it.

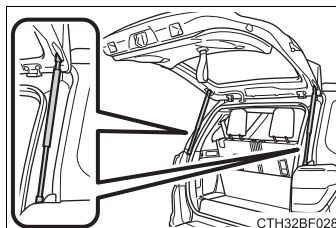

Front seats

Adjustment procedure

► Power seat

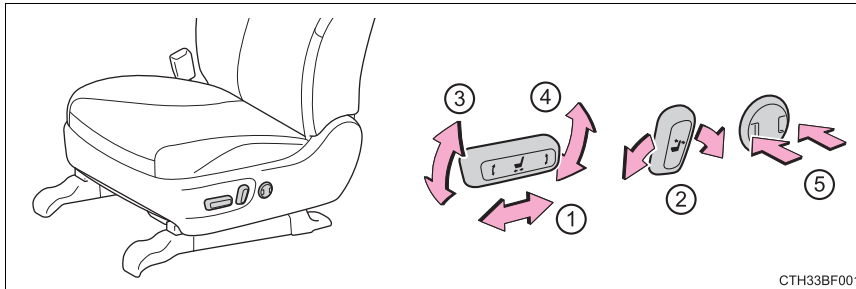

- ① Seat position adjustment switch ④ Vertical height adjustment switch (driver's side only)
- ② Seatback angle adjustment switch ⑤ Lumbar support adjustment switch (driver's side only)
- ③ Seat cushion (front) angle adjustment switch (driver's side only)

► Manual seat

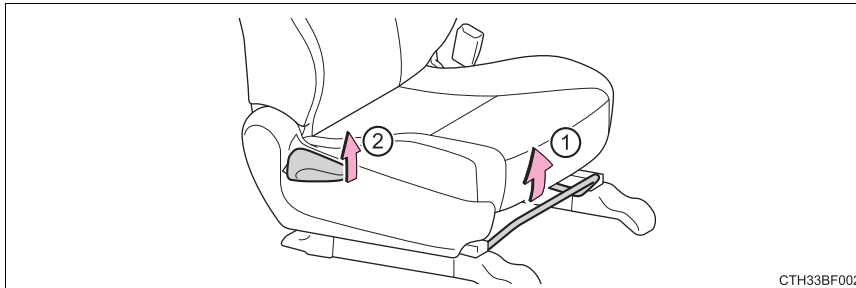

- ① Seat position adjustment lever ② Seatback angle adjustment lever

Active head restraints

When the occupant's lower back presses against the seatback during a rear-end collision, the head restraint moves slightly forward and upward to help reduce the risk of whiplash to the seat occupant.

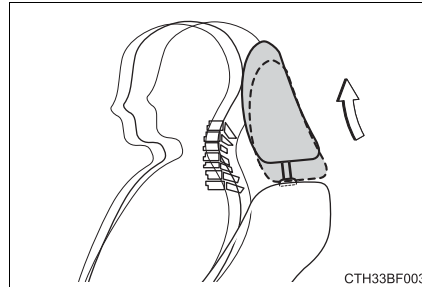

■ The auto away function for exiting the driver seat

If the seat is already close to the rearmost position, the auto away function may not operate when the driver exits the vehicle.

■ Active head restraints

Even small forces applied to the seatback may cause the head restraint to move. Pushing up a locked head restraint forcibly may appear the head restraint inner structure. These do not indicate problems.

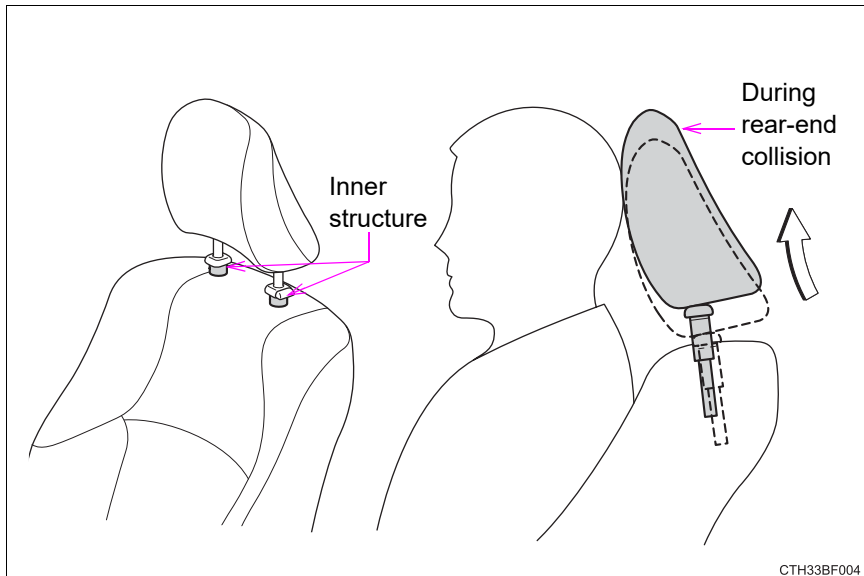

 **WARNING****■ When adjusting the seat position**

- Take care when adjusting the seat position to ensure that other passengers are not injured by the moving seat.
- Do not put your hands under the seat or near the moving parts to avoid injury.
Fingers or hands may become jammed in the seat mechanism.

■ Seat adjustment

- To reduce the risk of sliding under the lap belt during a collision, do not recline the seat more than necessary.
If the seat is too reclined, the lap belt may slide past the hips and apply restraint forces directly to the abdomen, or your neck may contact the shoulder belt, increasing the risk of death or serious injury in the event of an accident.
Adjustments should not be made while driving as the seat may unexpectedly move and cause the driver to lose control of the vehicle.
- After adjusting the seat, make sure that the seat is locked in position. (manual seat only)

■ When adjusting the seat positions

- Make sure to leave enough space around the feet so they do not get stuck.

Rear seats

Adjustment procedures

- ▶ Vehicles without third row seats

■ Rear seat

Pull up the seatback angle adjustment lever until the lock is released.

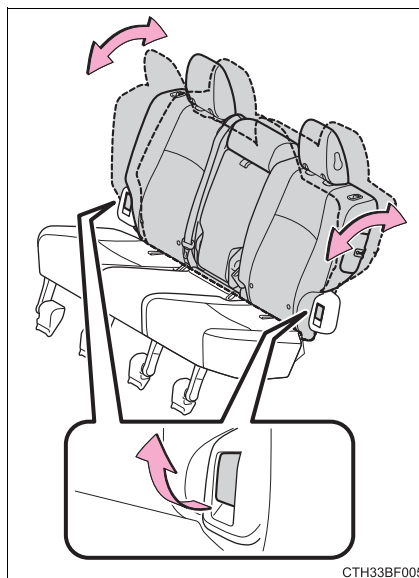

▶ Vehicles with third row seats

■ **Second row seats**

- ① Seat position adjustment lever
- ② Seatback angle adjustment lever

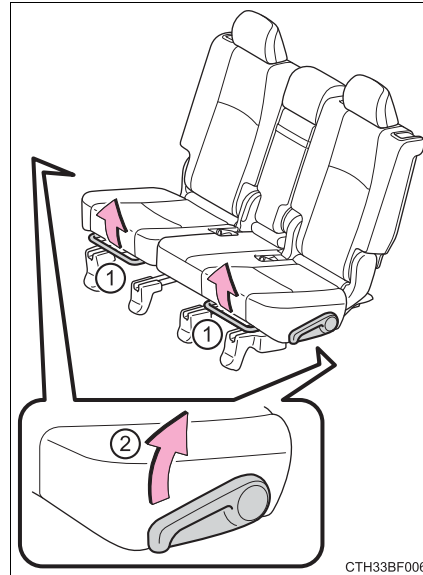

■ **Third row seats**

The third row seats do not have a seat adjustment function.

Folding down the rear seats (vehicles without third row seats)

■ **Before folding down the rear seats**

- 1 Adjust the head restraints to the downmost position.

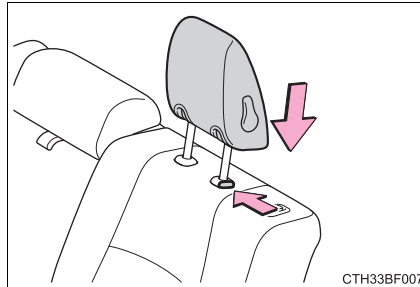

- 2 Fold down the head restraints.

When returning the head restraints to their original positions, make sure they are locked securely.

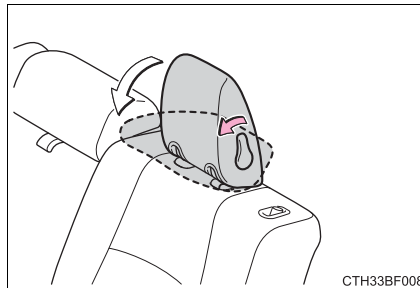

- 3 Stow the rear seat belt buckles.

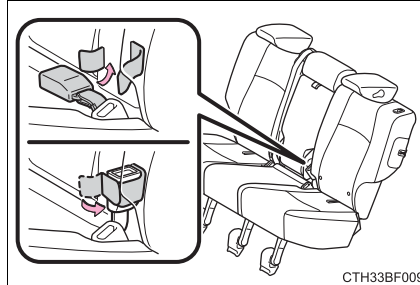

■ Folding down the rear seats

- 1 Swing the bottom cushions up by pulling the lock release strap.

When returning the rear seat cushions to their original positions, make sure they are locked securely.

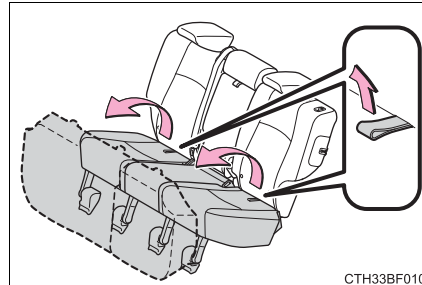

- 2 Push the lock release button and fold down the seatbacks.

To return the rear seatbacks to their original positions, lift them up until they lock.

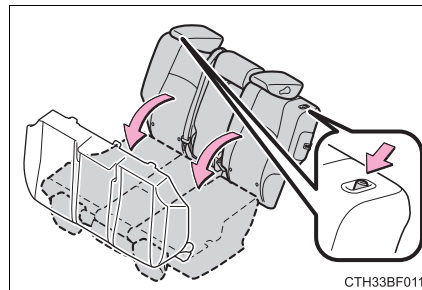

■ Folding down rear center seatback only

Pull the center seatback angle lever behind the seatback and fold the seatback down.

To return the rear center seatback to its original position, lift it up until it locks.

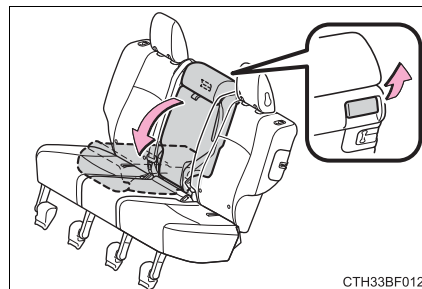

3

Operation of each component

Folding down the second row seats (vehicles with third row seats)

■ **Before folding down the second row seats**

- 1 Adjust the head restraints to the downmost position.

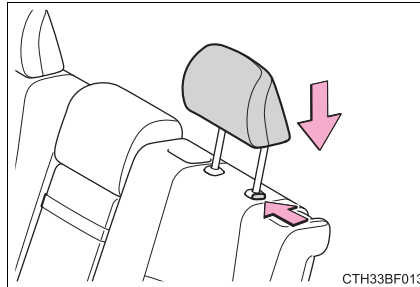

- 2 Stow the second row seat belt buckles.

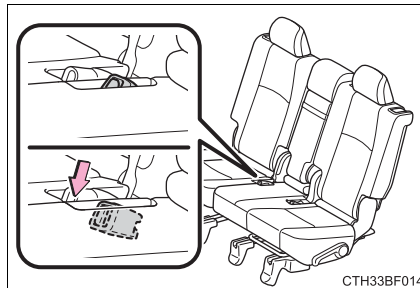

■ **Folding down the second row seats**

Pull the seatback lock release lever and fold the seatback down.

To return the second row seatbacks to their original positions, lift them up until they lock.

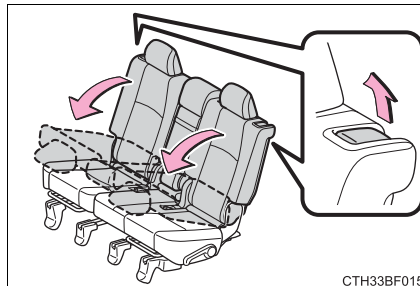

■ **Folding down the second row center seatback only**

Pull the center seatback angle lever behind the seatback and fold the seatback down.

To return the second row center seatback to its original position, lift it up until it locks.

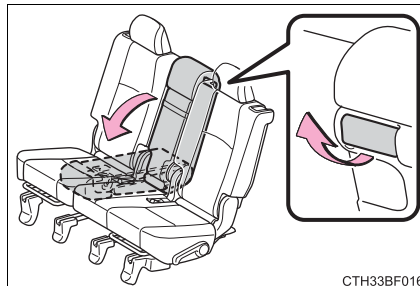

Moving a second row seat for access to the third row seats (vehicles with third row seats)

■ Getting in the vehicle (right side only)

Pull up the lever and fold down the seatback. The seat will slide forward.

Move the seat to the front-most position.

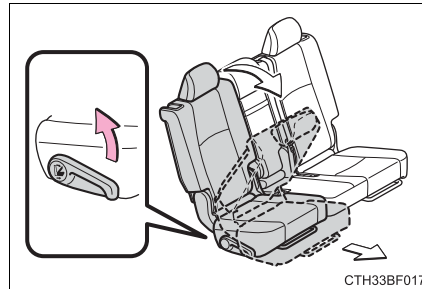

■ Getting out of the vehicle (right side only)

Lift the lever on the back of the seatback and fold down the seatback. The seat will slide forward.

Move the seat to the front-most position.

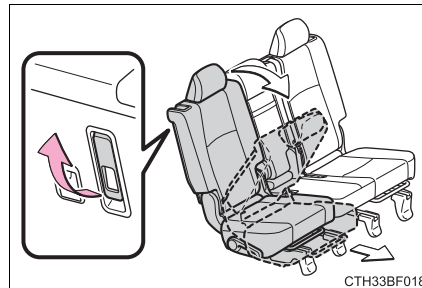

■ After passengers have entered/exited the vehicle

Lift up the seatback and slide the seat backward until it locks.

Folding down the third row seats (vehicles with third row seats)

■ Before folding down the third row seats

Pass the seat belts through the seat belt hangers and secure the seat belt plates.

This prevents the shoulder belts from being damaged.

Make sure that the seat belts are removed from the hangers before using them.

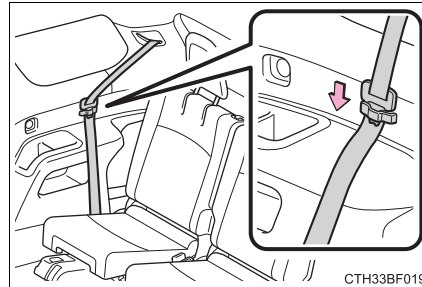

■ Folding down the third row seats

► From inside

- 1 Pull the strap to fold down the head restraint.

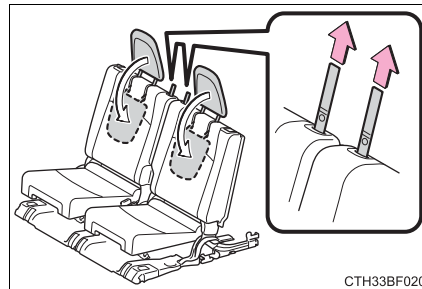

- 2 Pull the lever up. The seat cushion will slide backward.

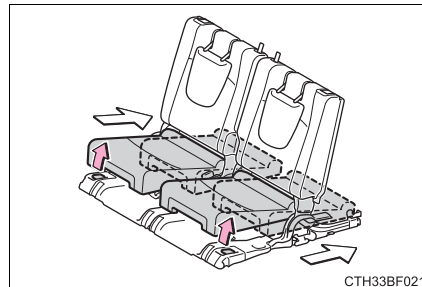

- 3 Pull the lever to unlock the seatback and then fold the seatback down.

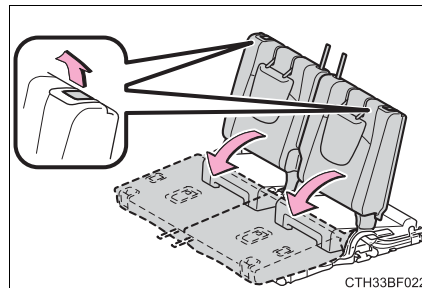

► From outside

- 1 Pull the strap to fold down the head restraint.

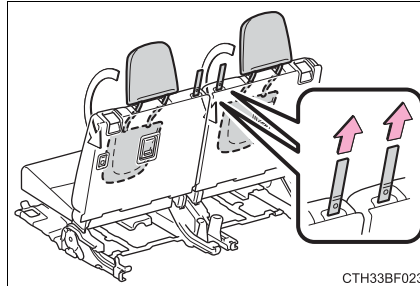

- 2 Pull the lever up.
The seat cushion will slide backward and the seatback will be unlocked.

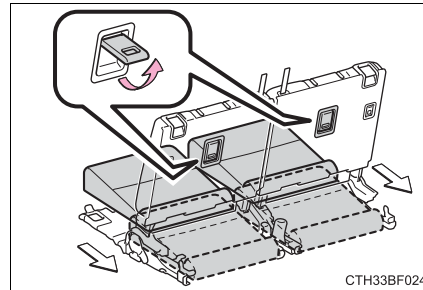

- 3 Fold the seatback down.

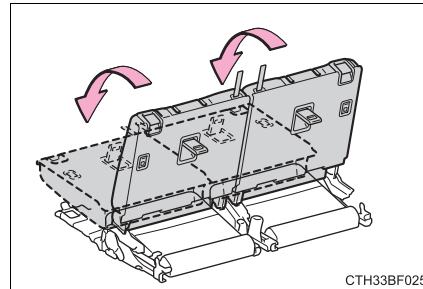

3

Operation of each component

■ **Returning the third row seats**

As the seat cushions cannot be pulled forward from outside, this operation can only be performed from inside.

- 1 Raise the seatbacks to their original positions.

Make sure they are locked securely.

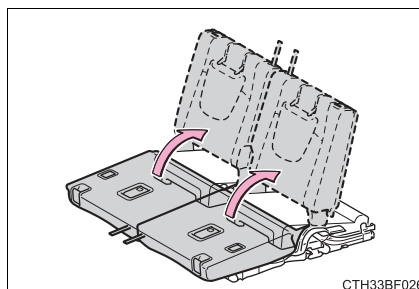

- 2 Pull the seat cushions forward.

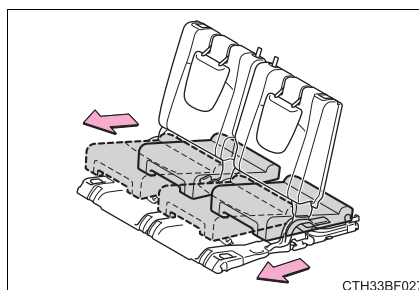

- 3 Raise the head restraints.

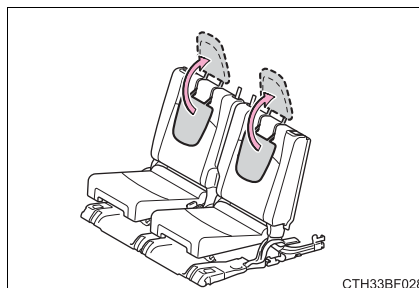

 WARNING**■ When folding the rear seatbacks down**

Observe the following precautions. Failure to do so may result in death or serious injury.

- Do not fold the seatbacks down while driving.
- Stop the vehicle on level ground, set the parking brake and shift the shift lever to P.
- Do not allow anyone to sit on a folded seatback or in the luggage compartment while driving.
- Do not allow children to enter the luggage compartment.

■ Seat adjustment

● To reduce the risk of sliding under the lap belt during a collision, do not recline the seat more than necessary.

If the seat is too reclined, the lap belt may slide past the hips and apply restraint forces directly to the abdomen, or your neck may contact the shoulder belt, increasing the risk of death or serious injury in the event of an accident.

Adjustments should not be made while driving as the seat may unexpectedly move and cause the driver to lose control of the vehicle.

- Take care when adjusting the seat position to ensure that other passengers are not injured by the moving seat.
- Do not put your hands under the seat or near the moving parts to avoid injury.
Fingers or hands may become jammed in the seat mechanism.

■ After returning the rear seatback to the upright position

Observe the following precautions. Failure to do so may result in death or serious injury.

- Make sure the seatback is securely locked by pushing it forward and rearward on the top.
- Check that the seat belts are not twisted or caught in the seatback.

 NOTICE**■ Stowing the seat belts**

The seat belts and the buckles must be stowed before you fold down the rear seatbacks.

Driving position memory*

This feature automatically adjusts the driver's seat to suit your preferences.

Driving position memory

Your preferred driving position (the position of the driver's seat) can be recorded and recalled by pressing a button. Two different driving positions can be recorded into memory.

■ Recording procedure

- 1 Check that the shift lever is in P.
- 2 Turn the engine switch to IGNITION ON mode.
- 3 Adjust the driver's seat to the desired positions.
- 4 While pressing the "SET" button, or within 3 seconds after the "SET" button is pressed, press button "1" or "2" until the buzzer sounds.

If the selected button has already been preset, the previously recorded position will be overwritten.

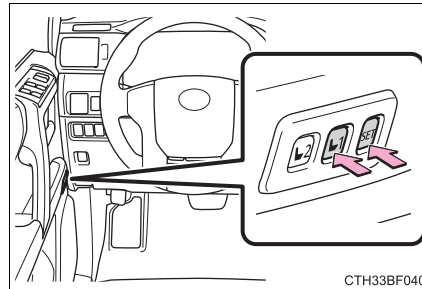

Recall procedure

- 1 Check that the shift lever is in P.
- 2 Turn the engine switch to IGNITION ON mode.
- 3 Press one of the buttons for the driving position you want to recall until the buzzer sounds.

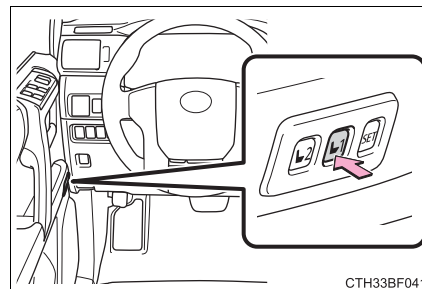

*: If equipped

■ To stop the position recall operation part-way through

Perform any of the following:

- Press the "SET" button.
- Press button "1" or "2".
- Operate any of the seat adjustment switches (only cancels seat position recall).

■ Seat positions that can be memorized (→P. 129)

All adjusted positions can be recorded.

■ Operating the driving position memory after turning the engine switch off

Recorded seat positions can be activated up to 180 seconds after the driver's door is opened and another 60 seconds after it is closed again.

■ In order to correctly use the driving position memory function

If a seat position is already in the furthest possible position and the seat is operated in the same direction, the recorded position may be slightly different when it is recalled.

Memory recall function

Each electronic key can be registered to recall your preferred driving position.

■ Registering procedure

Record your driving position to button "1" or "2" before performing the following:

Carry only the key you want to register, and then close the driver's door.

If 2 or more keys are in the vehicle, the driving position cannot be recorded properly.

- 1 Check that the shift lever is in P.
- 2 Turn the engine switch to IGNITION ON mode.
- 3 Recall the driving position that you want to record.

- 4 While pressing the recalled button, press and hold the door lock switch (either lock or unlock) until the buzzer sounds.

If the button could not be registered, the buzzer sounds continuously for approximately 3 seconds.

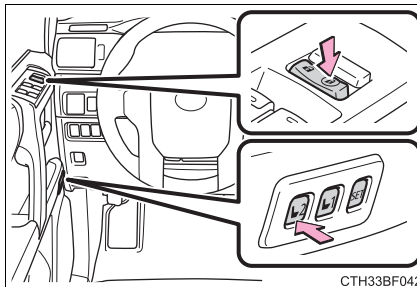

■ Recall procedure

Make sure that the doors are locked before recalling the driving position. Carry the electronic key that has been registered to the driving position, and then unlock and open the driver's door using the smart system or wireless remote control.

The driving position will move to the recorded position.

If the driving position is in a position that has already been recorded, the seat will not move.

■ Cancellation procedure

Carry only the key you want to cancel and then close the driver's door.

If 2 or more keys are in the vehicle, the driving position cannot be canceled properly.

- 1 Turn the engine switch to IGNITION ON mode.
- 2 While pressing the "SET" button, press and hold the door lock switch (either lock or unlock) until the buzzer sounds twice.

If the button could not be canceled, the buzzer sounds continuously for approximately 3 seconds.

■ Recalling the driving position using the memory recall function

- Different driving positions can be registered for each electronic key. Therefore, the driving position that is recalled may be different depending on the key being carried.
- If a door other than the driver's door is unlocked with the smart system, the driving position cannot be recalled. In this case, press the driving position button which has been set.

■ Customization

The unlock door settings of the memory recall function can be customized. (Customizable features: →P. 549)

 **WARNING****■ Seat adjustment caution**

Take care during seat adjustment so that the seat does not strike the rear passenger or squeeze your body against the steering wheel.

Head restraints

Head restraints are provided for all seats.

Front seats

Vertical adjustment

- ① Up
Pull the head restraints up.
- ② Down
Push the head restraint down while pressing the lock release button.

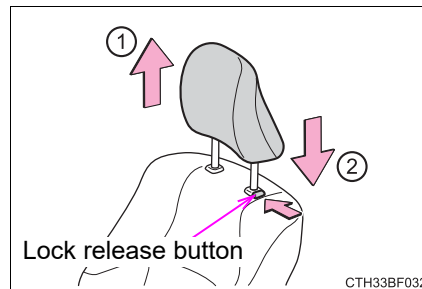

Second seats

Vertical adjustment

- ① Up
Pull the head restraints up.
- ② Down
Push the head restraint down while pressing the lock release button.

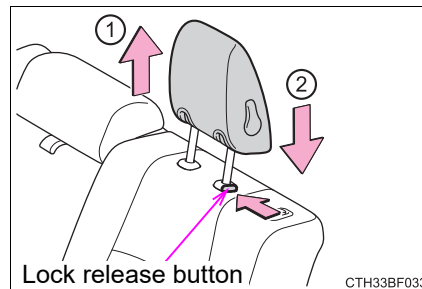

Folding the head restraints (vehicle without third row seats)

- ① To use
Lift up the head restraint until it locks.
- ② To fold
Pull the head restraint lock release lever to fold the head restraint.

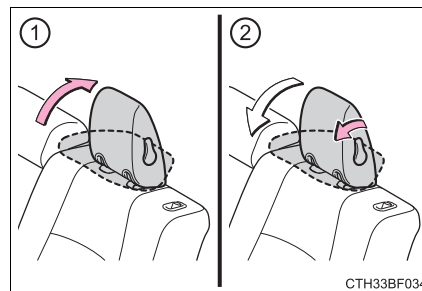

Third seats (vehicle with third row seats)

- ① To use
Lift up the head restraint until it locks.
- ② To fold
Pull the strap to fold the head restraint.

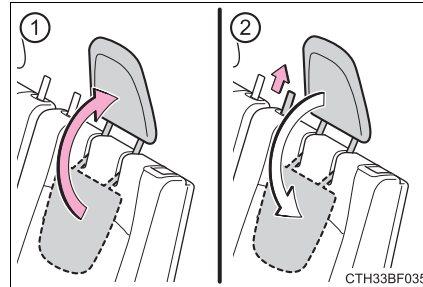

Removing the head restraints (except third row seats)

Pull the head restraint up while pressing the lock release button.

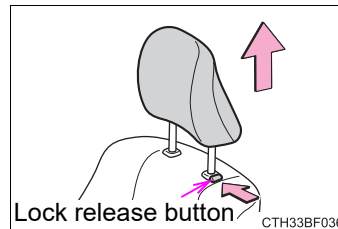

Installing the head restraints (except third row seats)

Align the head restraint with the installation holes and push it down to the lock position. Press and hold the lock release button when lowering the head restraint.

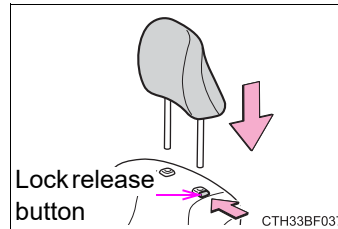

Adjusting the height of the head restraints (except third row seats)

Make sure that the head restraints are adjusted so that the center of the head restraint is closest to the top of your ears.

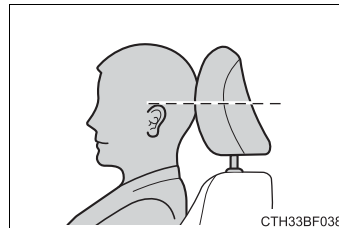

Adjusting the second center seat head restraint

Always raise the head restraint one level from the stowed position when using.

**WARNING****■ Head restraint precautions**

Observe the following precautions regarding the head restraints. Failure to do so may result in death or serious injury.

- Use the head restraints designed for each respective seat.
- Adjust the head restraints to the correct position at all times.
- After adjusting the head restraints, push down on them and make sure they are locked in position.
- Do not drive with the head restraints removed.

Steering wheel

The steering wheel can be adjusted to a comfortable position.

Adjustment procedure

- 1 Hold the steering wheel and push the lever down.

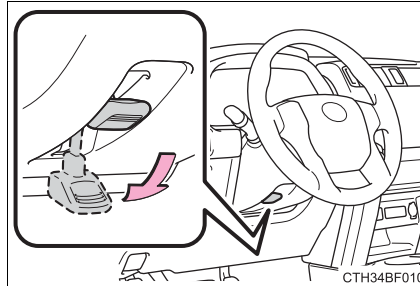

- 2 Adjust to the ideal position by moving the steering wheel horizontally and vertically.

After adjustment, pull the lever up to secure the steering wheel.

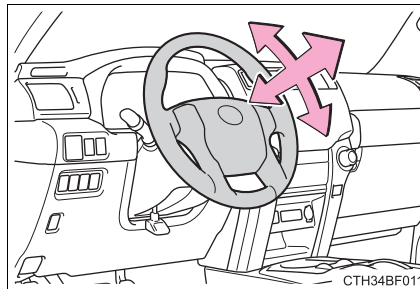

Horn

To sound the horn, press on or close to the  mark.

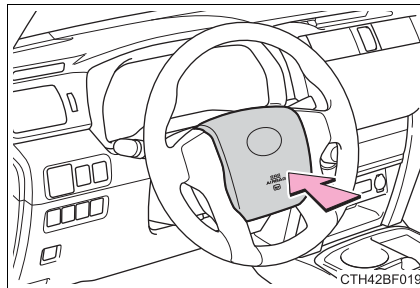

**WARNING****■ Caution while driving**

Do not adjust the steering wheel while driving.

Doing so may cause the driver to mishandle the vehicle and cause an accident, resulting in death or serious injury.

■ After adjusting the steering wheel

Make sure that the steering wheel is securely locked.

Otherwise, the steering wheel may move suddenly, possibly causing an accident, and resulting in death or serious injury. Also, the horn may not sound if the steering wheel is not securely locked.

Inside rear view mirror

The rear view mirror's position can be adjusted to enable sufficient confirmation of the rear view.

Adjusting the height of rear view mirror

The height of the rear view mirror can be adjusted to suit your driving posture.

Adjust the height of the rear view mirror by moving it up and down.

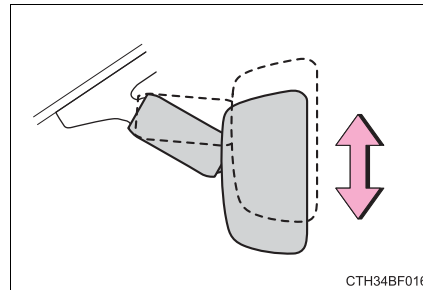

Anti-glare function

Responding to the level of brightness of the headlights of vehicles behind, the reflected light is automatically reduced.

Changing automatic anti-glare function mode
ON/OFF

When the automatic anti-glare function is in on mode, the indicator illuminates.

The function will set to on mode each time the engine switch is turned to IGNITION ON mode.

Pressing the button turns the function to off mode. (The indicator also turns off.)

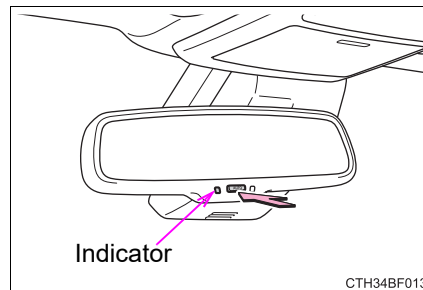

3

Operation of each component

■ **To prevent sensor error**

To ensure that the sensors operate properly, do not touch or cover them.

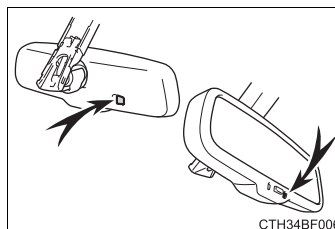

⚠ WARNING

Do not adjust the position of the mirror while driving. Doing so may lead to mishandling of the vehicle and cause an accident, resulting in death or serious injury.

Outside rear view mirrors

Adjustment procedure

- 1 To select a mirror to adjust, press the switch.

- ① Left
- ② Right

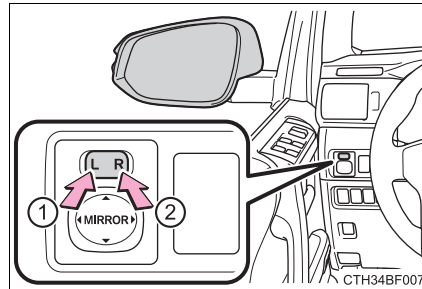

- 2 To adjust the mirror, press the switch.

- ① Up
- ② Right
- ③ Down
- ④ Left

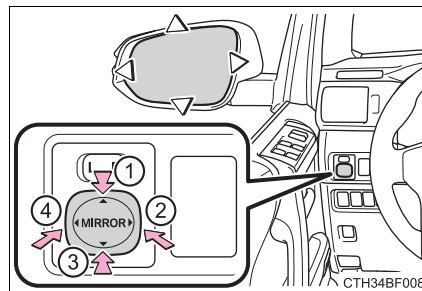

Folding the mirrors

Push the mirror back in the direction of the vehicle's rear.

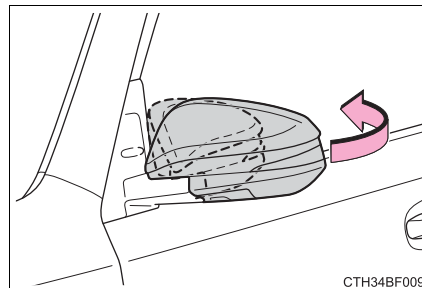

3

Operation of each component

■ Mirror angle can be adjusted when

The engine switch is in ACCESSORY or IGNITION ON mode.

■ When the mirrors are fogged up

The outside rear view mirrors can be cleared using the mirror defoggers. Turn on the rear window defogger to turn on the outside rear view mirror defoggers. (→P. 344, 351)

**WARNING****■ Important points while driving**

Observe the following precautions while driving.

Failure to do so may result in loss of control of the vehicle and cause an accident, resulting in death or serious injury.

- Do not adjust the mirrors while driving.
- Do not drive with the mirrors folded.
- Both the driver and passenger side mirrors must be extended and properly adjusted before driving.

■ When a mirror is moving

To avoid personal injury and mirror malfunction, be careful not to get your hand caught by the moving mirror.

■ When the mirror defoggers are operating

Do not touch the rear view mirror surfaces, as they can become very hot and burn you.

Power windows

Opening and closing procedures

The power windows can be opened and closed using the switches.

Operating the switch moves the windows as follows:

- ① Closing
- ② One-touch closing*
- ③ Opening
- ④ One-touch opening*

*: To stop the window partway, operate the switch in the opposite direction.

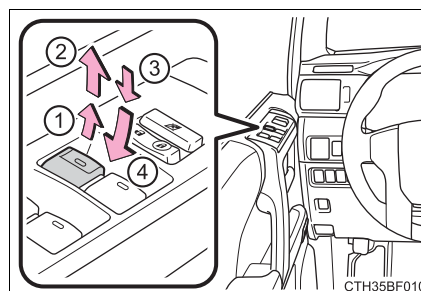

Window lock switch

Press the switch to lock the passenger window switches and back window switch.

Use this switch to prevent children from accidentally opening or closing a passenger window.

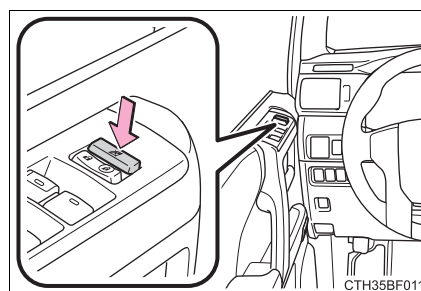

■ The power windows can be operated when

The engine switch is in IGNITION ON mode.

■ Operating the power windows after turning the engine off

The power windows can be operated for approximately 45 seconds even after the engine switch is turned to ACCESSORY mode or turned off. They cannot, however, be operated once either front door is opened.

■ Jam protection function

If an object becomes jammed between the window and the window frame while the window is closing, window movement is stopped and the window is opened slightly.

■ Catch protection function

If an object becomes caught between the door and window while the window is opening, window movement is stopped.

■ When the window cannot be opened or closed

When the jam protection function or catch protection function operates unusually and the door window cannot be opened or closed, perform the following operations with the power window switch of that door.

- Stop the vehicle. With the engine switch in IGNITION ON mode, within 4 seconds of the jam protection function or catch protection function activating, continuously operate the power window switch in the one-touch closing direction or one-touch opening direction so that the door window can be opened and closed.
- If the door window cannot be opened and closed even when performing the above operations, perform the following procedure for function initialization.
 - 1 Turn the engine switch to IGNITION ON mode.
 - 2 Pull and hold the power window switch in the one-touch closing direction and completely close the door window.
 - 3 Release the power window switch for a moment, resume pulling the switch in the one-touch closing direction, and hold it there for approximately 6 seconds or more.
 - 4 Press and hold the power window switch in the one-touch opening direction. After the door window is completely opened, continue holding the switch for an additional 1 second or more.
 - 5 Release the power window switch for a moment, resume pushing the switch in the one-touch opening direction, and hold it there for approximately 4 seconds or more.
 - 6 Pull and hold the power window switch in the one-touch closing direction again. After the door window is completely closed, continue holding the switch for a further 1 second or more.

If you release the switch while the window is moving, start again from the beginning.

If the window reverses and cannot be fully closed or opened, have the vehicle inspected by your Toyota dealer.

■ Door lock linked window operation

- The power windows can be opened and closed using the key or mechanical key.* (→P. 106, 512)
- The power windows can be opened using the wireless remote control.* (→P. 106)

*: These settings must be customized at your Toyota dealer.

■ Customization

Settings (e.g. key linked operation) can be changed.
(Customizable features →P. 549)

⚠ WARNING

Observe the following precautions.

Failure to do so may result in death or serious injury.

■ Closing the windows

- The driver is responsible for all the power window operations, including the operation for the passengers. In order to prevent accidental operation, especially by a child, do not let a child operate the power windows. It is possible for children and other passengers to have body parts caught in the power window. Also, when riding with a child, it is recommended to use the window lock switch. (→P. 155)
- Check to make sure that all passengers do not have any part of their body in a position where it could be caught when a window is being operated.
- When using the key or mechanical key and operating the power windows, operate the power window after checking to make sure that there is no possibility of any passenger having any of their body parts caught in the window. Also do not let a child operate window by the key or mechanical key. It is possible for children and other passengers to get caught in the power window.
- When exiting the vehicle, turn the engine switch off, carry the key and exit the vehicle along with the child. There may be accidental operation, due to mischief, etc., that may possibly lead to an accident.

■ Jam protection function

- Never use any part of your body to intentionally activate the jam protection function.
- The jam protection function may not work if something gets jammed just before the window is fully closed. Be careful not to get any part of your body jammed in the window.

■ Catch protection function

- Never use any part of your body or clothing to intentionally activate the catch protection function.
- The catch protection function may not work if something gets caught just before the window is fully opened. Be careful not to get any part of your body or clothing caught in the window.

Power back window

The power back window can be opened and closed using the switch or key.

Opening and closing procedures

► From inside the vehicle

- ① Closing
- ② One-touch closing*
- ③ Opening
- ④ One-touch opening*

*: To stop the window partway, operate the switch in the opposite direction.

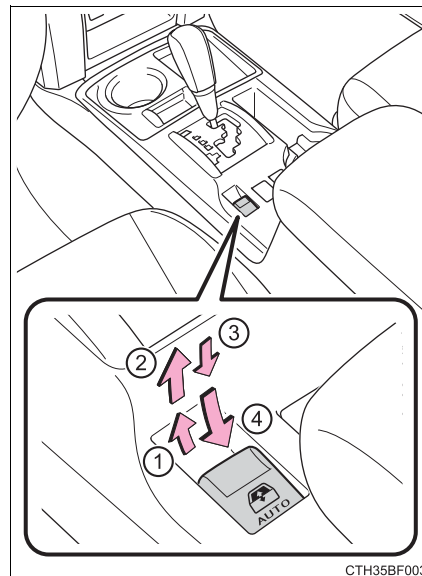

► From outside the vehicle

- ① Opening (push and hold)
- ② Closing (push and hold)

This operation can only be performed when the electronic key is within the detection range.

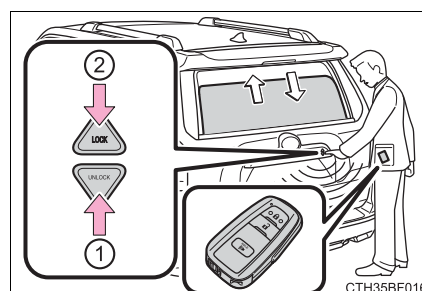

■ The power back window can be operated from inside the vehicle when

The engine switch is in IGNITION ON mode.

- The power back window can be opened when the rear window wiper is working, but the wiper stops working until the window is closed again. If the power back window is not fully closed, the rear window wiper, washer, and defogger will not work.
- If the back door is not fully closed, the power back window cannot be opened using the switch located in the cabin. (It is still possible to close the window.)
- If the back door is opened while the power back window is opening or closing, window operation will stop.

■ The power back window can be operated from outside the vehicle when

- The engine switch is off.
- The back door is closed.

■ Operating the power back window from inside the vehicle after turning the engine off

The power back window can be operated for approximately 45 seconds even after the engine switch is turned to ACCESSORY mode or turned off. It cannot, however, be operated once either front door is opened.

■ Jam protection function

If an object becomes caught between the window and the window frame, window travel is stopped and the window is opened slightly.

■ When the power back window does not close normally

If the jam protection function is operating abnormally and a window cannot be closed, perform the following operations using the power back window switch.

- After stopping the vehicle, the window can be closed by holding the power back window switch in the one-touch closing position while the engine switch is turned to IGNITION ON mode.
- If the window still cannot be closed even by carrying out the operation explained above, initialize the function by performing the following procedure.
 - 1 Hold the power back window switch in the one-touch closing position. Continue holding the switch for a further 6 seconds after the window has closed.
 - 2 Hold the power back window switch in the one-touch opening position. Continue holding the switch for a further 2 seconds after the window has opened completely.
 - 3 Hold the power back window switch in the one-touch closing position once again. Continue holding the switch for a further 2 seconds after the window has closed.

If you release the switch while the window is moving, start again from the beginning.

If the window continues to close but then re-open slightly even after performing the above procedure correctly, have the vehicle inspected by your Toyota dealer.

■ Customization

Settings (e.g. linked operation) can be changed.
(Customizable features →P. 549)

WARNING

Observe the following precautions.

Failure to do so may result in death or serious injury.

■ Caution while driving

Keep the back door and back window closed while driving. If the back door or the back window is left open, the back door may hit nearby objects while driving or luggage may be unexpectedly thrown out, causing an accident.

In addition, exhaust gases may enter the vehicle, causing death or a serious health hazard. Make sure to close the back door and back window before driving.

■ Closing the power back window

- The driver is responsible for power back window opening and closing operations.

In order to prevent accidental operation, especially by a child, do not let a child operate the power back window. It is possible for children and other passengers to have body parts caught in the power back window.

- Check to make sure that all passengers do not have any part of their body in a position where it could be caught when a window is being operated.

- When using the wireless remote control or key and operating the power back window, operate the power back window after checking to make sure that there is no possibility of any passenger having any of their body parts caught in the power back window. Also, do not let a child operate power back window by the wireless remote control or key. It is possible for children and other passengers to get caught in the power back window.

- When exiting the vehicle, turn the engine switch off, carry the key and exit the vehicle along with the child. There may be accidental operation, due to mischief, etc., that may possibly lead to an accident.

■ Jam protection function

- Never use any part of your body to intentionally activate the jam protection function.

- The jam protection function may not work if something gets caught just before the window fully closes.

Moon roof*

Use the overhead switches to open and close the moon roof and tilt it up and down.

Opening and closing

- ① Opens the moon roof*
The moon roof stops slightly before the fully open position to reduce wind noise.
Press the switch again to fully open the moon roof.
- ② Closes the moon roof*
*: Lightly press either way of the moon roof switch to stop the moon roof partway.

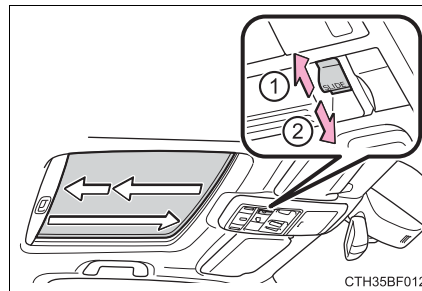

Tilting up and down

- ① Tilts the moon roof up*
- ② Tilts the moon roof down*
*: Lightly press either way of the moon roof switch to stop the moon roof partway.

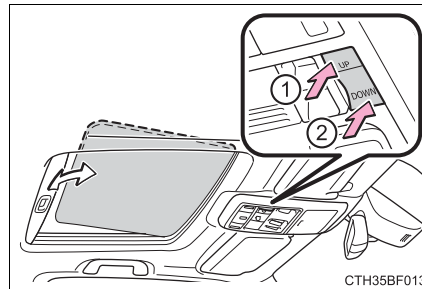

3

Operation of each component

*: If equipped

■ **The moon roof can be operated when**

The engine switch is in IGNITION ON mode.

■ **Operating the moon roof after turning the engine off**

The moon roof can be operated for approximately 45 seconds after the engine switch is turned to ACCESSORY mode or turned off. It cannot, however, be operated once either front door is opened.

■ **Jam protection function**

If an object is detected between the moon roof and the frame while the moon roof is closing or tilting down, travel is stopped and the moon roof opens slightly.

■ **To reduce moon roof wind noise**

When the moon roof is opened automatically, it will stop slightly before the fully open position. Driving with the moon roof in this position can help reduce wind noise.

■ **Sunshade**

The sunshade can be opened and closed manually. However, the sunshade will open automatically when the moon roof is opened.

■ When the moon roof does not close normally

Perform the following procedure:

- If the moon roof closes but then re-opens slightly

- 1 Stop the vehicle.
- 2 Press and hold the "SLIDE (open/close)" switch in the close position.^{*1}
The moon roof will close, reopen and pause for approximately 10 seconds.^{*2} Then it will close again, tilt up and pause for approximately 1 second. Finally, it will tilt down, open and close.
- 3 Check to make sure that the moon roof is completely closed and then release the switch.

- If the moon roof tilts down but then tilts back up

- 1 Stop the vehicle.
- 2 Press and hold the "UP" switch^{*1} until the moon roof moves into the tilt up position and stops.
- 3 Release the "UP" switch once and then press and hold the "UP" switch again.^{*1}
The moon roof will pause for approximately 10 seconds in the tilt up position.^{*2} Then it will adjust slightly and pause for approximately 1 second. Finally, it will tilt down, open and close.
- 4 Check to make sure that the moon roof is completely closed and then release the switch.

*1: If the switch is released at the incorrect time, the procedure will have to be performed again from the beginning.

*2: If the switch is released after the above mentioned 10 second pause, automatic operation will be disabled. In that case, press and hold the "UP" or "DOWN" switch, and the moon roof will tilt up and pause for approximately 1 second. Then it will tilt down, open and close. Check to make sure that the moon roof is completely closed and then release the switch.

If the moon roof does not fully close even after performing the above procedure correctly, have the vehicle inspected by your Toyota dealer.

■ Moon roof open reminder function

An alarm will sound when the driver's door is opened with the moon roof not fully closed and the engine switch off.

■ Door lock linked moon roof operation

- The moon roof can be opened and closed using the key or mechanical key.^{*}
(→P. 106, 512)
- The moon roof can be opened using the wireless remote control.^{*}
(→P. 106)

*: These settings must be customized at your Toyota dealer.

■ Customization that can be configured at Toyota dealer

Settings (e.g. key linked operation) can be changed.
(Customizable features →P. 549)

⚠ WARNING

Observe the following precautions.
Failure to do so may cause death or serious injury.

■ Opening the moon roof

- Do not allow any passengers to put their hands or heads outside the vehicle while it is moving.
- Do not sit on top of the moon roof.

■ Closing the moon roof

- The driver is responsible for moon roof opening and closing operations. In order to prevent accidental operation, especially by a child, do not let a child operate the moon roof. It is possible for children and other passengers to have body parts caught in the moon roof.
- Check to make sure that all passengers do not have any part of their body in a position where it could be caught when the moon roof is being operated.
- When using the key or mechanical key and operating the moon roof, operate the moon roof after checking to make sure that there is no possibility of any passenger having any of their body parts caught in the moon roof. Also, do not let a child operate moon roof by the key or mechanical key. It is possible for children and other passengers to get caught in the moon roof.
- When exiting the vehicle, turn the engine switch off, carry the key and exit the vehicle along with the child. There may be accidental operation, due to mischief, etc., that may possibly lead to an accident.

■ Jam protection function

- Never use any part of your body to intentionally activate the jam protection function.
- The jam protection function may not work if something gets caught just before the moon roof fully closes.

Driving

4

- 4-1. Before driving**
 - Driving the vehicle..... 166
 - Cargo and luggage 176
 - Vehicle load limits 181
 - Trailer towing..... 182
 - Dinghy towing 198
- 4-2. Driving procedures**
 - Engine (ignition) switch 199
 - Automatic transmission 205
 - Turn signal lever..... 210
 - Parking brake..... 211
- 4-3. Operating the lights and wipers**
 - Headlight switch 212
 - AHB (Automatic High Beam) 217
 - Fog light switch 221
 - Windshield wipers and washer 223
 - Rear window wiper and washer 226
- 4-4. Refueling**
 - Opening the fuel tank cap 229
- 4-5. Using the driving support systems**
 - Toyota Safety Sense P 232
 - PCS (Pre-Collision System)..... 239
 - LDA (Lane Departure Alert) 249
 - Dynamic radar cruise control 257
 - BSM (Blind Spot Monitor)..... 270
 - Intuitive parking assist..... 277
 - RCTA (Rear Cross Traffic Alert) 286
 - Four-wheel drive system (part-time 4WD models) 294
 - Four-wheel drive system (full-time 4WD models) 298
 - Active traction control system 302
 - AUTO LSD system (2WD models)..... 304
 - Rear differential lock system 306
 - Downhill assist control system 309
 - Crawl Control 312
 - Multi-terrain Select 315
 - Driving assist systems 322
- 4-6. Driving tips**
 - Winter driving tips 331
 - Off-road precautions 335

Driving the vehicle

The following procedures should be observed to ensure safe driving:

Starting the engine

→P. 199

Driving

- 1 With the brake pedal depressed, shift the shift lever to D. (→P. 205)
- 2 Release the parking brake. (→P. 211)
- 3 Gradually release the brake pedal and gently depress the accelerator pedal to accelerate the vehicle.

Stopping

- 1 With the shift lever in D, depress the brake pedal until the vehicle comes to a stop.
- 2 If necessary, set the parking brake.
If the vehicle is to be stopped for an extended period of time, shift the shift lever to P or N. (→P. 205)

Parking the vehicle

- 1 With the shift lever in D, depress the brake pedal.
- 2 Set the parking brake (→P. 211), and shift the shift lever to P (→P. 205).
- 3 Press the engine switch to stop the engine.
- 4 Lock the door, making sure that you have the key on your person.
If parking on a hill, block the wheels as needed.

Starting off on a steep uphill

- 1 Make sure that the parking brake is set and shift the shift lever to D.
- 2 Gently depress the accelerator pedal.
- 3 Release the parking brake.

Driving in the rain

- Drive carefully when it is raining, because visibility will be reduced, the windows may become fogged-up, and the road will be slippery.
- Drive carefully when it starts to rain, because the road surface will be especially slippery.
- Refrain from driving at high speeds in the rain, as there may be a layer of water between the tires and the road surface, preventing the steering and brakes from operating properly.

Engine speed while driving

In the following conditions, the engine speed may become high while driving. This is due to automatic up-shifting control or down-shifting implementation to meet driving conditions. It does not indicate sudden acceleration.

- The vehicle is judged to be driving uphill or downhill
- When the accelerator pedal is released

Restraining the engine output (Brake Override System)

- When the accelerator and brake pedals are depressed at the same time, the engine output may be restrained.
- A warning message is displayed on the multi-information display while the system is operating.

Restraining sudden start (Drive-Start Control)

- When the following unusual operation is performed, the engine output may be restrained.
 - When the shift lever is shifted from R to D, D to R, N to R, P to D, or P to R (D includes S) with the accelerator pedal depressed, a warning message appears on the multi-information display.
 - When the accelerator pedal is depressed too much while the vehicle is in reverse.
- While Drive-Start Control is being activated, your vehicle may have trouble escaping from the mud or fresh snow. In such case, perform the following actions to cancel Drive-Start Control so that the vehicle may become able to escape from the mud or fresh snow.
 - Deactivate TRAC (→P. 324, 325)
 - 2WD models: When the AUTO LSD system is turned on. (→P. 304)
 - Part-time 4WD models: The four-wheel drive control switch is in "L4" position. (→P. 294)
 - Full-time 4WD models: The four-wheel drive control switch is in "L4L" position. (→P. 298)

■ **Breaking in your new Toyota**

To extend the life of the vehicle, observing the following precautions is recommended:

- For the first 200 miles (300 km):
Avoid sudden stops.
- For the first 500 miles (800 km):
Do not tow a trailer.
- For the first 1000 miles (1600 km):
 - Do not drive at extremely high speeds.
 - Avoid sudden acceleration.
 - Do not drive continuously in low gears.
 - Do not drive at a constant speed for extended periods.

■ **Drum-in-disc type parking brake system**

Your vehicle has a drum-in-disc type parking brake system. This type of brake system needs bedding-down of the brake shoes periodically or whenever the parking brake shoes and/or drum are replaced. Have your Toyota dealer perform the bedding down operation.

■ **Operating your vehicle in a foreign country**

Comply with the relevant vehicle registration laws and confirm the availability of the correct fuel. (→P. 534)

■ **When turning off the engine**

The emission system operating sounds may continue for a short time after the engine is turned off. This is not a malfunction, and helps to ensure optimal performance of the emission system.

 WARNING
Observe the following precautions. Failure to do so may result in death or serious injury.
■ When starting the vehicle Always keep your foot on the brake pedal while stopped with the engine running. This prevents the vehicle from creeping.

⚠ WARNING

Observe the following precautions.

Failure to do so may result in death or serious injury.

■ When driving the vehicle

- Do not drive if you are unfamiliar with the location of the brake and accelerator pedals to avoid depressing the wrong pedal.
 - Accidentally depressing the accelerator pedal instead of the brake pedal will result in sudden acceleration that may lead to an accident.
 - When backing up, you may twist your body around, leading to a difficulty in operating the pedals. Make sure to operate the pedals properly.
 - Make sure to keep a correct driving posture even when moving the vehicle only slightly. This allows you to depress the brake and accelerator pedals properly.
 - Depress the brake pedal using your right foot. Depressing the brake pedal using your left foot may delay response in an emergency, resulting in an accident.
- Do not drive the vehicle over or stop the vehicle near flammable materials. The exhaust system and exhaust gases can be extremely hot. These hot parts may cause a fire if there is any flammable material nearby.

■ When driving the vehicle

- During normal driving, do not turn off the engine. Turning the engine off while driving will not cause loss of steering or braking control, but the power assist to these systems will be lost. This will make it more difficult to steer and brake, so you should pull over and stop the vehicle as soon as it is safe to do so.
However, in the event of an emergency, such as if it becomes impossible to stop the vehicle in the normal way: →P. 467
- Use engine braking (downshift) to maintain a safe speed when driving down a steep hill.
Using the brakes continuously may cause the brakes to overheat and lose effectiveness. (→P. 205)
- Do not adjust the positions of the steering wheel, the seat, or the inside or outside rear view mirrors while driving.
Doing so may result in a loss of vehicle control.
- Always check that all passengers' arms, heads or other parts of their body are not outside the vehicle.
- Do not drive in excess of the speed limit. Even if the legal speed limit permits it, do not drive over 85 mph (140 km/h) unless your vehicle has high-speed capability tires. Driving over 85 mph (140 km/h) may result in tire failure, loss of control and possible injury. Be sure to consult a tire dealer to determine whether the tires on your vehicle are high-speed capability tires or not before driving at such speeds.

 **WARNING**

Observe the following precautions.

Failure to do so may result in death or serious injury.

■ **When driving on slippery road surfaces**

- Sudden braking, acceleration and steering may cause tire slippage and reduce your ability to control the vehicle, resulting in an accident.
- Sudden acceleration, engine braking due to shifting, or changes in engine speed could cause the vehicle to skid, resulting in an accident.
- After driving through a puddle, lightly depress the brake pedal to make sure that the brakes are functioning properly. Wet brake pads may prevent the brakes from functioning properly. If the brakes on only one side are wet and not functioning properly, steering control may be affected, resulting in an accident.

■ **When shifting the shift lever**

- Do not let the vehicle roll backward while the shift lever is in a driving position, or roll forward while the shift lever is in R.
Doing so may cause the engine to stall or lead to poor brake and steering performance, resulting in an accident or damage to the vehicle.
- Do not shift the shift lever to P while the vehicle is moving.
Doing so can damage the transmission and may result in a loss of vehicle control.
- Do not shift the shift lever to R while the vehicle is moving forward.
Doing so can damage the transmission and may result in a loss of vehicle control.
- Do not shift the shift lever to a driving position while the vehicle is moving backward.
Doing so can damage the transmission and may result in a loss of vehicle control.
- Moving the shift lever to N while the vehicle is moving will disengage the engine from the transmission. Engine braking is not available when N is selected.
- Be careful not to shift the shift lever with the accelerator pedal depressed. Shifting the shift lever to a gear other than P or N may lead to unexpected rapid acceleration of the vehicle that may cause an accident and result in death or serious injury.

 **WARNING**

Observe the following precautions.

Failure to do so may result in death or serious injury.

■ **If you hear a squealing or scraping noise (brake pad wear limit indicators)**

Have the brake pads checked and replaced by your Toyota dealer as soon as possible.

Rotor damage may result if the pads are not replaced when needed.

It is dangerous to drive the vehicle when the wear limits of the brake pads and/or those of the brake discs are exceeded.

■ **When the vehicle is stopped**

- Do not race the engine.

If the vehicle is in any gear other than P or N, the vehicle may accelerate suddenly and unexpectedly, causing an accident.

- In order to prevent accidents due to the vehicle rolling away, always keep depressing the brake pedal while the engine is running, and apply the parking brake as necessary.

- If the vehicle is stopped on an incline, in order to prevent accidents caused by the vehicle rolling forward or backward, always depress the brake pedal and securely apply the parking brake as needed.

- Avoid revving or racing the engine.

Running the engine at high speed while the vehicle is stopped may cause the exhaust system to overheat, which could result in a fire if combustible material is nearby.

 **WARNING**

Observe the following precautions.

Failure to do so may result in death or serious injury.

■ **When the vehicle is parked**

- Do not leave glasses, cigarette lighters, spray cans, or soft drink cans in the vehicle when it is in the sun.
Doing so may result in the following:
 - Gas may leak from a cigarette lighter or spray can, and may lead to a fire.
 - The temperature inside the vehicle may cause the plastic lenses and plastic material of glasses to deform or crack.
 - Soft drink cans may fracture, causing the contents to spray over the interior of the vehicle, and may also cause a short circuit in the vehicle's electrical components.
- Do not leave cigarette lighters in the vehicle. If a cigarette lighter is in a place such as the glove box or on the floor, it may be lit accidentally when luggage is loaded or the seat is adjusted, causing a fire.
- Do not attach adhesive discs to the windshield or windows. Do not place containers such as air fresheners on the instrument panel or dashboard. Adhesive discs or containers may act as lenses, causing a fire in the vehicle.
- Do not leave a door or window open if the curved glass is coated with a metallized film such as a silver-colored one. Reflected sunlight may cause the glass to act as a lens, causing a fire.
- Always apply the parking brake, shift the shift lever to P, stop the engine and lock the vehicle.
Do not leave the vehicle unattended while the engine is running.
If the vehicle is parked with the shift lever in P but the parking brake is not set, the vehicle may start to move, possibly leading to an accident.
- Do not touch the exhaust pipes while the engine is running or immediately after turning the engine off.
Doing so may cause burns.

 **WARNING**

Observe the following precautions.

Failure to do so may result in death or serious injury.

■ **When taking a nap in the vehicle**

Always turn the engine off. Otherwise, if you accidentally move the shift lever or depress the accelerator pedal, this could cause an accident or fire due to engine overheating. Additionally, if the vehicle is parked in a poorly ventilated area, exhaust gases may collect and enter the vehicle, leading to death or a serious health hazard.

■ **When braking**

- When the brakes are wet, drive more cautiously.
Braking distance increases when the brakes are wet, and this may cause one side of the vehicle to brake differently than the other side. Also, the parking brake may not securely hold the vehicle.
- If the brake booster device does not operate, do not follow other vehicles closely and avoid hills or sharp turns that require braking.
In this case, braking is still possible, but the brake pedal should be depressed more firmly than usual. Also, the braking distance will increase.
- Do not pump the brake pedal if the engine stalls.
Each push on the brake pedal uses up the reserve for the power-assisted brakes.
- The brake system consists of 2 individual hydraulic systems; if one of the systems fails, the other will still operate. In this case, the brake pedal should be depressed more firmly than usual and the braking distance will increase.
If this happens, do not continue to drive the vehicle. Have your brakes fixed immediately.

 NOTICE

■ **When driving the vehicle**

- Do not depress the accelerator and brake pedals at the same time during driving, as this may restrain the engine output.
- Do not use the accelerator pedal or depress the accelerator and brake pedals at the same time to hold the vehicle on a hill.

■ **When parking the vehicle**

Always set the parking brake, and shift the shift lever to P. Failure to do so may cause the vehicle to move or the vehicle may accelerate suddenly if the accelerator pedal is accidentally depressed.

■ **Avoiding damage to vehicle parts**

- Do not turn the steering wheel fully in either direction and hold it there for an extended period of time.
Doing so may damage the power steering pump.
- When driving over bumps in the road, drive as slowly as possible to avoid damaging the wheels, underside of the vehicle, etc.

■ **If you get a flat tire while driving**

A flat or damaged tire may cause the following situations. Hold the steering wheel firmly and gradually depress the brake pedal to slow down the vehicle.

- It may be difficult to control your vehicle.
- The vehicle will make abnormal sounds or vibrations.
- The vehicle will behave abnormally.

Information on what to do in case of a flat tire (→P. 493)

 NOTICE**■ When encountering flooded roads**

Do not drive on a road that has flooded after heavy rain etc. Doing so may cause the following serious damage to the vehicle:

- Engine stalling
- Short in electrical components
- Engine damage caused by water immersion

In the event that you drive on a flooded road and the vehicle is flooded, be sure to have your Toyota dealer check the following:

- Brake function
- Changes in quantity and quality of oil and fluid used for the engine, transmission, transfer (4WD models), differentials, etc.
- Lubricant condition for the propeller shaft, bearings and suspension joints (where possible), and the function of all joints, bearings, etc.

Cargo and luggage

Take notice of the following information about storage precautions, cargo capacity and load:

- Stow cargo and luggage in the luggage compartment whenever possible.
- Be sure all items are secured in place.
- To maintain vehicle balance while driving, position luggage evenly within the luggage compartment.
- For better fuel economy, do not carry unnecessary weight.

Capacity and distribution

Cargo capacity depends on the total weight of the occupants.

(Cargo capacity) = (Total load capacity) — (Total weight of occupants)

Steps for Determining Correct Load Limit —

- (1) Locate the statement “The combined weight of occupants and cargo should never exceed XXX kg or XXX lbs.” on your vehicle’s placard.
- (2) Determine the combined weight of the driver and passengers that will be riding in your vehicle.
- (3) Subtract the combined weight of the driver and passengers from XXX kg or XXX lbs.
- (4) The resulting figure equals the available amount of cargo and luggage load capacity.
For example, if the “XXX” amount equals 1400 lbs. and there will be five 150 lb passengers in your vehicle, the amount of available cargo and luggage load capacity is 650 lbs. (1400 – 750 (5 × 150) = 650 lbs.)
- (5) Determine the combined weight of luggage and cargo being loaded on the vehicle. That weight may not safely exceed the available cargo and luggage load capacity calculated in Step 4.
- (6) If your vehicle will be towing a trailer, load from your trailer will be transferred to your vehicle. Consult this manual to determine how this reduces the available cargo and luggage load capacity of your vehicle.
(→P. 524)

Calculation formula for your vehicle

- ① Cargo capacity
- ② Total load capacity (vehicle capacity weight) (→P. 524)

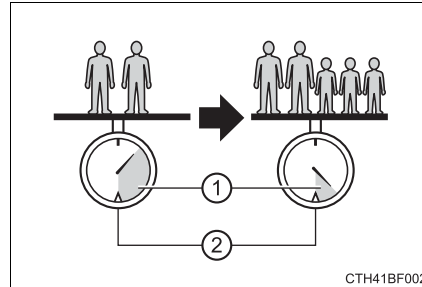

When 2 people with the combined weight of A lb. (kg) are riding in your vehicle, which has a total load capacity (vehicle capacity weight) of B lb. (kg), the available amount of cargo and luggage load capacity will be C lb. (kg) as follows:

$$B^{*2} \text{ lb. (kg)} - A^{*1} \text{ lb. (kg)} = C^{*3} \text{ lb. (kg)}$$

*1: A =Weight of people

*2: B =Total load capacity

*3: C =Available cargo and luggage load

In this condition, if 3 more passengers with the combined weight of D lb. (kg) get on, the available cargo and luggage load will be reduced E lb. (kg) as follows:

$$C \text{ lb. (kg)} - D^{*4} \text{ lb. (kg)} = E^{*5} \text{ lb. (kg)}$$

*4: D =Additional weight of people

*5: E =Available cargo and luggage load

As shown in the example above, if the number of occupants increases, the cargo and luggage load will be reduced by an amount that equals the increased weight due to the additional occupants. In other words, if an increase in the number of occupants causes an excess of the total load capacity (combined weight of occupants plus cargo and luggage load), you must reduce the cargo and luggage on your vehicle.

■ When using the roof rails (if equipped)

- To use the roof rails as a roof luggage carrier, you must fit the roof rails with two or more genuine Toyota cross rails or their equivalent.
- When there is no luggage on the roof luggage carrier Toyota recommends that the front and rear cross rails be secured in the positions indicated in the illustration. This may reduce wind noise while driving.

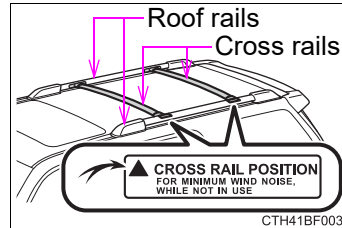

⚠ WARNING

■ Things that must not be carried in the luggage compartment

The following things may cause a fire if loaded in the luggage compartment:

- Receptacles containing gasoline
- Aerosol cans

■ Storage precautions

Observe the following precautions.

Failure to do so may prevent the pedals from being depressed properly, may block the driver's vision, or may result in items hitting the driver or passengers, possibly causing an accident.

- Stow cargo and luggage in the luggage compartment whenever possible.
- Do not stack cargo and luggage in the luggage compartment higher than the seatbacks.
- Do not place cargo or luggage in or on the following locations.
 - At the feet of the driver
 - On the front passenger or rear seats (when stacking items)
 - On the instrument panel
 - On the dashboard
- Secure all items in the occupant compartment.
- When you fold down the rear seats, long items should not be placed directly behind the front seats.
- Never allow anyone to ride in the luggage compartment. It is not designed for passengers. They should ride in their seats with their seat belts properly fastened. Otherwise, they are much more likely to suffer death or serious bodily injury, in the event of sudden braking, sudden swerving or an accident.

 **WARNING****■ Capacity and distribution**

- Do not exceed the maximum axle weight rating or the total vehicle weight rating.
- Even if the total load of occupant's weight and the cargo load is less than the total load capacity, do not apply the load unevenly. Improper loading may cause deterioration of steering or braking control which may cause death or serious injury.

■ When loading cargo on the roof luggage carrier

Observe the following precautions:

- Place the cargo so that its weight is distributed evenly between the front and rear axles.
- If loading long or wide cargo, never exceed the vehicle overall length or width. (→P. 524)
- Before driving, make sure the cargo is securely fastened on the roof luggage carrier.
- Loading cargo on the roof luggage carrier will make the center of gravity of the vehicle higher. Avoid high speeds, sudden starts, sharp turns, sudden braking or abrupt maneuvers, otherwise it may result in loss of control or vehicle rollover due to failure to operate this vehicle correctly and result in death or serious injury.
- If driving for a long distance, on rough roads, or at high speeds, stop the vehicle now and then during the trip to make sure the cross rails are fixed securely and that the cargo remains in its place.
- Do not exceed 120 lb. (54 kg) cargo weight on the roof luggage carrier.

 **NOTICE****■ When loading cargo on the roof luggage carrier**

Be careful not to scratch the surface of the moon roof (if equipped).

Vehicle load limits

Vehicle load limits include total load capacity, seating capacity, TWR (Trailer Weight Rating) and cargo capacity.

◆ Total load capacity (vehicle capacity weight): →P. 524

Total load capacity means the combined weight of occupants, cargo and luggage.

◆ Seating capacity: →P. 524

Seating capacity means the maximum number of occupants whose estimated average weight is 150 lb. (68 kg) per person.

◆ TWR (Trailer Weight Rating): →P. 187, 524

TWR means the maximum gross trailer weight (trailer weight plus its cargo weight) that you vehicle is able to tow.

◆ Cargo capacity

Cargo capacity may increase or decrease depending on the weight and the number of occupants.

■ Total load capacity and seating capacity

These details are also described on the tire and loading information label. (→P. 440)

⚠ WARNING

■ Overloading the vehicle

Do not overload the vehicle.
It may not only cause damage to the tires, but also degrade steering and braking ability, resulting in an accident.

Trailer towing

Your vehicle is designed primarily as a passenger-and-load-carrying vehicle. Towing a trailer can have an adverse impact on handling, performance, braking, durability, and fuel consumption. For your safety and the safety of others, you must not overload your vehicle or trailer. You must also ensure that you are using appropriate towing equipment, that the towing equipment has been installed correctly and used properly, and that you employ the requisite driving habits.

Vehicle-trailer stability and braking performance are affected by trailer stability, brake performance and setting, trailer brakes, the hitch and hitch systems (if equipped).

To tow a trailer safely, use extreme care and drive the vehicle in accordance with your trailer's characteristics and operating conditions.

Toyota warranties do not apply to damage or malfunction caused by towing a trailer for commercial purposes.

Contact your Toyota dealer for further information about additional requirements such as a towing kit, etc.

Towing related terms

■ GCWR (Gross Combination Weight Rating)

The maximum allowable gross combination weight. The gross combination weight is the sum of the total vehicle weight (including the occupants, cargo and any optional equipment installed on the vehicle) and the weight of the trailer being towed (including the cargo in the trailer).

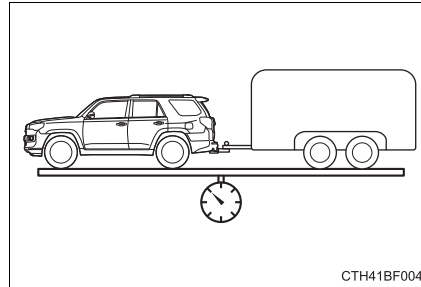

■ GVWR (Gross Vehicle Weight Rating)

The maximum allowable gross vehicle weight. The gross vehicle weight is the total weight of the vehicle. When towing a trailer, it is the sum of the vehicle weight (including the occupants, cargo and any optional equipment installed on the vehicle) and the tongue weight.

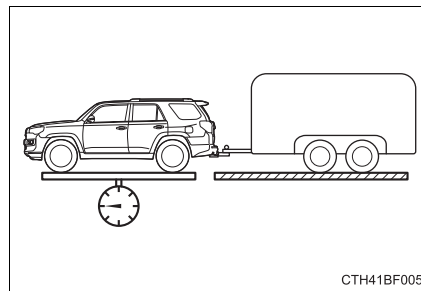

■ **GAWR (Gross Axle Weight Rating)**

The maximum allowable gross axle weight. The gross axle weight is the load placed on each axle (front and rear).

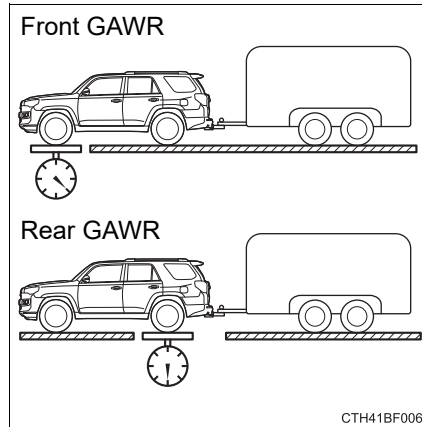

■ **TWR (Trailer Weight Rating)**

The maximum allowable gross trailer weight. The gross trailer weight is the sum of the trailer weight and the weight of the cargo in the trailer.

TWR is calculated assuming base vehicle with one driver, one front passenger, towing package (if available), hitch and hitch systems (if required).

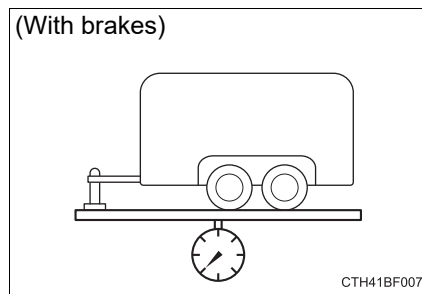

Additional optional equipment, passengers and cargo in the vehicle will reduce the trailer weight rating so as not to exceed GCWR, GVWR and GAWR.

If the gross trailer weight exceeds 3000 lb. (1360 kg), it is recommended to use a trailer with 2 or more axles.

■ Unbraked TWR (Unbraked Trailer Weight Rating)

The trailer weight rating for towing a trailer without a trailer service brake system.

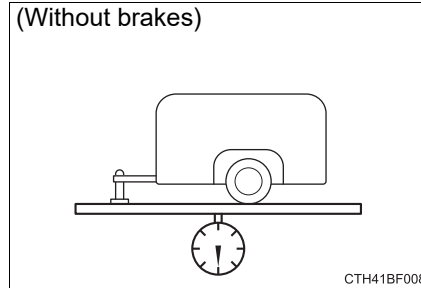
**■ Tongue Weight**

The load placed on the trailer hitch ball. (→P. 187)

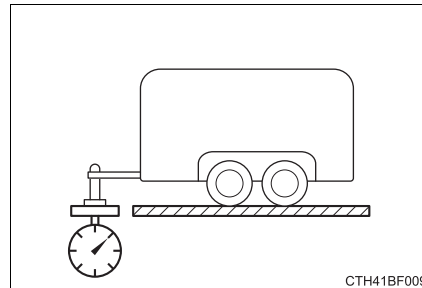

Weight limits

- The gross trailer weight must never exceed the TWR described in the table. (→P. 187)
- The gross combination weight must never exceed the GCWR described in the table. (→P. 187)
- The gross vehicle weight must never exceed the GVWR indicated on the Certification Label.
- The gross axle weight on each axle must never exceed the GAWR indicated on the Certification Label.
- If the gross trailer weight is over the unbraked TWR, trailer service brakes are required.
- If the gross trailer weight is over 2000 lb. (907 kg), a sway control device with sufficient capacity is required.

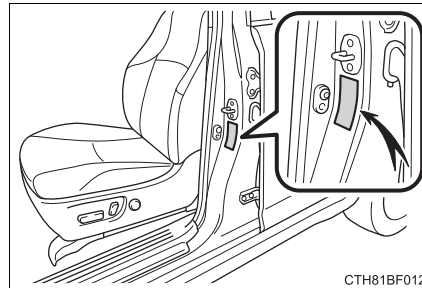

GCWR, TWR and Unbraked TWR

Confirm that the gross trailer weight, gross combination weight, gross vehicle weight, gross axle weight and tongue weight are all within the limits.

■ **GCWR* and TWR***

Driving system	Trailer Weight Rating	GCWR
2WD	5000 lb. (2270 kg)	11100 lb. (5035 kg)
4WD		11300 lb. (5125 kg)

■ **Unbraked TWR***

1655 lb. (750 kg)

*: These models meet the tow-vehicle trailering requirement of SAE International per SAE J2807.

Trailer Tongue Weight

- A recommended tongue weight varies in accordance with the types of trailers or towing as described below.
- To ensure the recommended values shown below, the trailer must be loaded by referring to the following instructions.

• Tongue Weight

The gross trailer weight should be distributed so that the tongue weight is 9% to 11%. (Tongue weight /Gross trailer weight x 100 = 9% to 11%)

- ① Gross trailer weight
- ② Tongue weight

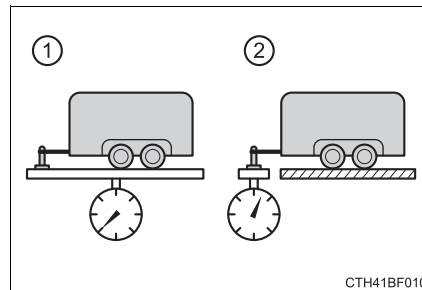

The gross trailer weight, gross axle weight and tongue weight can be measured with platform scales found at a highway weighing station, building supply company, trucking company, junk yard, etc.

Hitch

Trailer hitch assemblies have different weight capacities. Toyota recommends the use of Toyota hitch/bracket for your vehicle. For details, contact your Toyota dealer.

- If you wish to install a trailer hitch, contact your Toyota dealer.
- Use only a hitch that conforms to the gross trailer weight requirement of your vehicle.
- Follow the directions supplied by the hitch manufacturer.
- Lubricate the hitch ball with a light coating of grease.
- Remove the hitch ball whenever you are not towing a trailer. Remove the trailer hitch if you do not need it. After removing the hitch, seal any mounting hole in the vehicle body to prevent entry of any substances into the vehicle.

Selecting trailer ball

Use the correct trailer ball for your application.

- ① Trailer ball load rating
Matches or exceeds the gross trailer weight rating of the trailer.
- ② Ball diameter
Matches the size of the trailer coupler. Most couplers are stamped with the required trailer ball size.

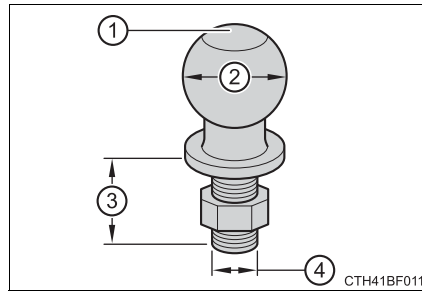

Trailer class	Typical trailer ball size
IV	2 5/16 in.
II and III	2 in.
I	1 7/8 in.

- ③ Shank length
Protrudes beyond the bottom of the lock washer and nut by at least 2 threads.
- ④ Shank diameter
Matches the ball mount hole diameter size.

4
Driving

Positions for towing hitch receiver and hitch ball

- ① Weight carrying ball position:
50.1 in. (1272 mm)
- ② Hitch receiver pin hole position:
43.7 in. (1109 mm)

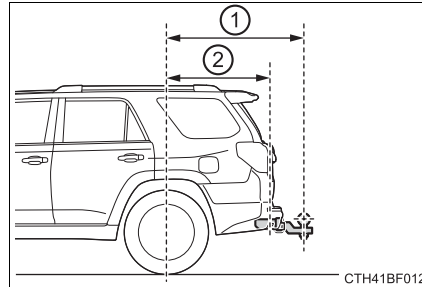

Connecting trailer lights

Use the wire harness stored in the rear end under body.

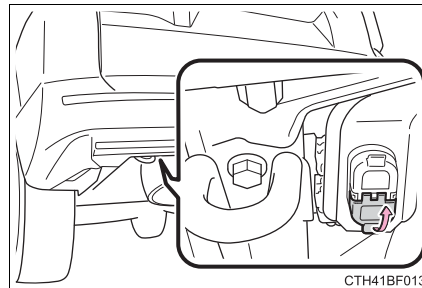

Please consult your dealer when installing trailer lights, as incorrect installation may cause damage to the vehicle's lights. Please take care to comply with your state's laws when installing trailer lights.

Service connector for towing brake controller

Your vehicle is equipped with a service connector for the trailer brake controller as shown.

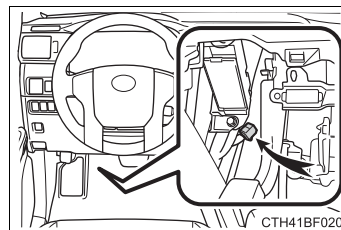

Trailer towing tips

Your vehicle will handle differently when towing a trailer. Help to avoid an accident, death or serious injury, keep the following in mind when towing:

- Speed limits for towing a trailer vary by state or province. Do not exceed the posted towing speed limit.
- Toyota recommends that the vehicle-trailer speed limit is 65 mph (104 km/h) on a flat, straight, dry road. Do not exceed this limit, the posted towing speed limit or the speed limit for your trailer as set forth in your trailer owner's manual, whichever is lowest. Instability of the towing vehicle-trailer combination (trailer sway) increases as speed increases. Exceeding speed limits may cause loss of control.
- Before starting out, check the trailer lights, tires and the vehicle-trailer connections. Recheck after driving a short distance.
- Practice turning, stopping and reversing with the trailer attached in an area away from traffic until you become accustomed to the feel of the vehicle-trailer combination.
- Reversing with a trailer attached is difficult and requires practice. Grip the bottom of the steering wheel and move your hand to the left to move the trailer to the left. Move your hand to the right to move the trailer to right. (This is generally opposite to reversing without a trailer attached.) Avoid sharp or prolonged turning. Have someone guide you when reversing to reduce the risk of an accident.
- As stopping distance is increased when towing a trailer, vehicle-to-vehicle distance should be increased. For each 10 mph (16 km/h) of speed, allow at least one vehicle and trailer length.
- Avoid sudden braking as you may skid, resulting in the trailer jackknifing and a loss of vehicle control. This is especially true on wet or slippery surfaces.

- Avoid jerky starts or sudden acceleration.
- Avoid jerky steering and sharp turns, and slow down before making turn.
- Note that when making a turn, the trailer wheels will be closer than the vehicle wheels to the inside of the turn. Compensate by making a wider than normal turning radius.
- Slow down before making a turn, in cross winds, on wet or slippery surfaces, etc.
Increasing vehicle speed can destabilize the trailer.
- Take care when passing other vehicles. Passing requires considerable distance. After passing a vehicle, do not forget the length of your trailer, and be sure you have plenty of room before changing lanes.
- To maintain engine braking efficiency and charging system performance when using engine braking, do not put the transmission in D.
- Instability happens more frequently when descending steep or long downhill grades. Before descending, slow down and downshift. Do not make sudden downshifts while descending steep or long downhill grades.
- Avoid holding the brake pedal down too long or applying the brakes too frequently. This could cause the brakes to overheat and result in reduced braking efficiency.
- Due to the added load of the trailer, your vehicle's engine may overheat on hot days (at temperatures over 85°F [30°C]) when driving up a long or steep grade. If the engine coolant temperature gauge indicates overheating, immediately turn off the air conditioning (if in use), pull your vehicle off the road and stop in a safe spot.
(→P. 519)

- Always place wheel blocks under both the vehicle's and the trailer's wheels when parking. Apply the parking brake firmly, and put the transmission in P. Avoid parking on a slope, but if unavoidable, do so only after performing the following:
 - 1 Apply the brakes and keep them applied.
 - 2 Have someone place wheel blocks under both the vehicle's and trailer's wheels.
 - 3 When the wheel blocks are in place, release the brakes slowly until the blocks absorb the load.
 - 4 Apply the parking brake firmly.
 - 5 Shift into P and turn off the engine.
- When restarting after parking on a slope:
 - 1 With the transmission in P, start the engine. Be sure to keep the brake pedal pressed.
 - 2 Shift into a forward gear. If reversing, shift into R.
 - 3 Release the parking brake and brake pedal, and slowly pull or back away from the wheel blocks. Stop and apply the brakes.
 - 4 Have someone retrieve the blocks.

■ Matching trailer ball height to trailer coupler height

No matter which class of tow hitch applies, for a more safe trailer hookup, the trailer ball setup must be the proper height for the coupler on the trailer.

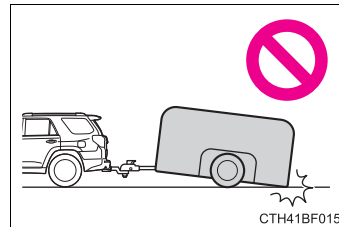

- ① Coupler
- ② Trailer ball

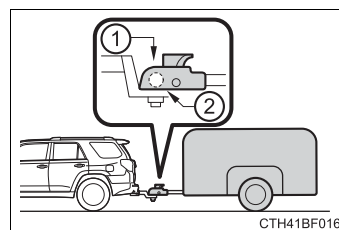

■ Before towing

Check that the following conditions are met:

- Ensure that your vehicle's tires are properly inflated. (→P. 532)
- Trailer tires are inflated according to the trailer manufacturer's recommendation.
- All trailer lights work as required by law.
- All lights work each time you connect them.
- The trailer ball is set at the proper height for the coupler on the trailer.
- The trailer is level when it is hitched.
Do not drive if the trailer is not level, and check for improper tongue weight, overloading, worn suspension, or other possible causes.
- The trailer cargo is securely loaded.
- The rear view mirrors conform to all applicable federal, state/provincial or local regulations. If they do not, install rear view mirrors appropriate for towing purposes.

■ When towing a trailer

Disable the following systems, as the systems may not operate properly.

- LDA (Lane Departure Alert) (→P. 249)
- Dynamic radar cruise control (→P. 257)
- BSM (Blind Spot Monitor) (→P. 270)
- Intuitive parking assist (→P. 277)
- RCTA (Rear Cross Traffic Alert) function (→P. 286)

■ Break-in schedule

If your vehicle is new or equipped with any new power train components (such as an engine, transmission, differential or wheel bearing), Toyota recommends that you do not tow a trailer until the vehicle has been driven for over 500 miles (800 km).

After the vehicle has been driven for over 500 miles (800 km), you can start towing. However, for the next 500 miles (800 km), drive the vehicle at a speed of less than 45 mph (72 km/h) when towing a trailer, and avoid full throttle acceleration.

■ Maintenance

- If you tow a trailer, your vehicle will require more frequent maintenance due to the additional load. (See "Scheduled Maintenance Guide" or "Owner's Manual Supplement".)
- Retighten the fixing bolts of the towing ball and bracket after approximately 600 miles (1000 km) of trailer towing.

■ If trailer sway occurs

One or more factors (crosswinds, passing vehicles, rough roads, etc.) can adversely affect handling of your vehicle and trailer, causing instability.

● If trailer swaying occurs:

- Firmly grip the steering wheel. Steer straight ahead.
Do not try to control trailer swaying by turning the steering wheel.
- Begin releasing the accelerator pedal immediately but very gradually to reduce speed.
Do not increase speed. Do not apply vehicle brakes.

If you make no extreme correction with the steering or brakes, your vehicle and trailer should stabilize. (if enabled, Trailer Sway Control can also help to stabilize the vehicle and trailer.)

● After the trailer swaying has stopped:

- Stop in a safe place. Get all occupants out of the vehicle.
- Check the tires of the vehicle and the trailer.
- Check the load in the trailer.
Make sure the load has not shifted.
Make sure the tongue weight is appropriate, if possible.
- Check the load in the vehicle.

Make sure the vehicle is not overloaded after occupants get in.

If you cannot find any problems, the speed at which trailer swaying occurred is beyond the limit of your particular vehicle-trailer combination.

Drive at a lower speed to prevent instability. Remember that swaying of the towing vehicle-trailer increases as speed increases.

 **WARNING****Trailer towing precautions**

To tow a trailer safely, use extreme care and drive the vehicle in accordance with the trailer's characteristics and operating conditions. Failure to do so could cause an accident resulting in death or serious injury. Vehicle stability and braking performance are affected by trailer stability, brake setting and performance, and the hitch. Your vehicle will handle differently when towing a trailer.

To avoid accident or injury

- Do not exceed the TWR, unbraked TWR, GCWR, GVWR or GAWR.
- If the gross trailer weight is over 2000 lb. (907 kg), a sway control device with sufficient capacity is required.
- Adjust the tongue weight within the appropriate range. Place heavier loads as close to the trailer axle as possible.
- Do not exceed 65 mph (104 km/h), the posted towing speed limit or the speed limit for your trailer as set forth in your trailer owner's manual, whichever is lowest. Slow down sufficiently before making a turn, in cross winds, on wet or slippery surface, etc. to help avoid an accident. If you experience a vehicle-trailer instability from reducing a certain speed, slow down and make sure you keep your vehicle speed under the speed of which you experience the instability.
- Do not make jerky, abrupt or sharp turns.
- Do not apply the brakes suddenly as you may skid, resulting in jackknifing and loss of vehicle control. This is especially true on wet or slippery surfaces.
- Do not exceed the trailer hitch assembly weight, gross vehicle weight, gross axle weight and trailer tongue weight capacities.
- Do not use cruise control when towing.
- Slow down and downshift before descending steep or long downhill grades. Do not make sudden downshifts while descending steep or long downhill grades.
- Vehicle-trailer instability is more likely on steep long downhills. Before descending steep or long downhill grades, slow down and downshift. Do not make sudden downshifts when descending steep or long downhill grades. Avoid holding the brake pedal down too long or applying the brakes too frequently. This could cause the brakes to overheat and result in reduced braking efficiency.

 **WARNING****■ Hitch**

Trailer hitch assemblies have different weight capacities established by the hitch manufacturer. Even though the vehicle may be physically capable of towing a higher weight, the operator must determine the maximum weight rating of the particular hitch assembly and never exceed the maximum weight rating specified for the trailer-hitch. Exceeding the maximum weight rating set by the trailer-hitch manufacturer can cause an accident resulting in death or serious personal injuries.

■ When towing a trailer

Toyota recommends trailers with brakes that conform to any applicable federal and state/provincial regulations.

- If the gross trailer weight exceeds unbraked TWR, trailer brakes are required. Toyota recommends trailers with brakes that conform to all applicable federal and state/provincial regulations.
- Never tap into your vehicle's hydraulic system, as this will lower the vehicle's braking effectiveness.
- Never tow a trailer without using a safety chain securely attached to both the trailer and the vehicle. If damage occurs to the coupling unit or hitch ball, there is danger of the trailer wandering into another lane.

 **NOTICE****■ When installing a trailer hitch**

Use only the position recommended by your Toyota dealer. Do not install the trailer hitch on the bumper; this may cause body damage.

■ Do not directly splice trailer lights

Do not directly splice trailer lights. Directly splicing trailer lights may damage your vehicle's electrical system and cause a malfunction.

Dinghy towing

Your vehicle is not designed to be dinghy towed (with 4 wheels on the ground) behind a motor home.

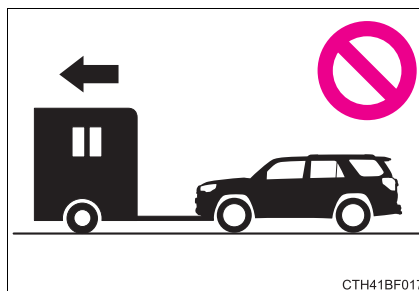

 NOTICE

- **To avoid serious damage to your vehicle**
Do not tow your vehicle with the four wheels on the ground.

Engine (ignition) switch

Performing the following operations when carrying the electronic key on your person starts the engine or changes engine switch modes.

Starting the engine

- 1 Check that the parking brake is set.
- 2 Check that the shift lever is set in P.
- 3 Firmly depress the brake pedal.

 and a message will be displayed on the multi-information display. If it is not displayed, the engine cannot be started.

- 4 Press the engine switch shortly and firmly.

When operating the engine switch, one short, firm press is enough. It is not necessary to press and hold the switch.

The engine will crank until it starts or for up to 30 seconds, whichever is less.

Continue depressing the brake pedal until the engine is completely started.

The engine can be started from any engine switch mode.

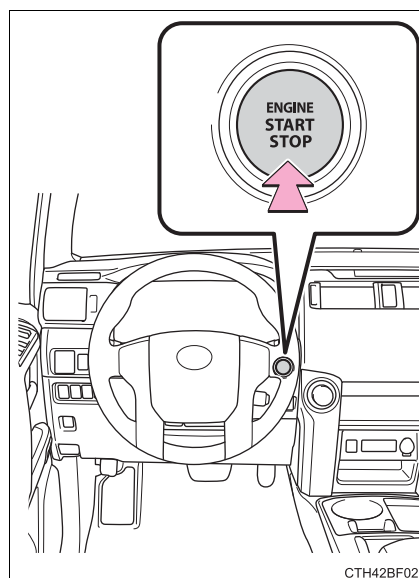

4

Driving

Stopping the engine

- 1 Stop the vehicle.
- 2 Set the parking brake (→P. 211), and shift the shift lever to P.
- 3 Press the engine switch.
- 4 Release the brake pedal and check that “ACCESSORY” or “IGNITION ON” is not shown on the meter.

Changing engine switch modes

Modes can be changed by pressing the engine switch with brake pedal released. (The mode changes each time the switch is pressed.)

- 1 Off*
The emergency flashers can be used.
- 2 ACCESSORY mode
Some electrical components such as the audio system can be used.
“ACCESSORY” will be displayed on the multi-information display.
- 3 IGNITION ON mode
All electrical components can be used.
“IGNITION ON” will be displayed on the multi-information display.

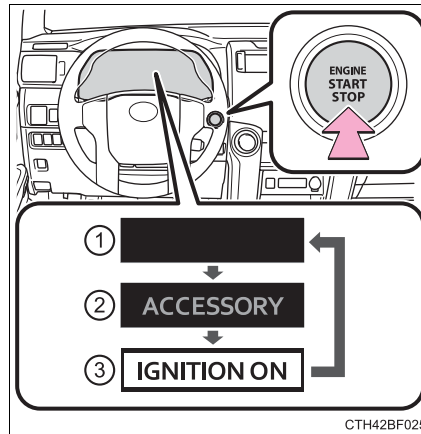

CTH42BF025

*: If the shift lever is in a position other than P when turning off the engine, the engine switch will be turned to ACCESSORY mode, not to off.

When stopping the engine with the shift lever in a position other than P

If the engine is stopped with the shift lever in a position other than P, the engine switch will not be turned off but instead be turned to ACCESSORY mode. Perform the following procedure to turn the switch off:

- 1 Check that the parking brake is set.
- 2 Shift the shift lever to P.
- 3 Check that "Turn Power Off" is displayed on the multi-information display and then press the engine switch once.
- 4 Check that "Turn Power Off" on the multi-information display is turned off.

Auto power off function

If the vehicle is left in ACCESSORY mode for more than 20 minutes or IGNITION ON mode (the engine is not running) for more than an hour with the shift lever in P, the engine switch will automatically turn off. However, this function cannot entirely prevent battery discharge. Do not leave the vehicle with the engine switch in ACCESSORY or IGNITION ON mode for long periods of time when the engine is not running.

Automatic engine shut off feature

- The vehicle is equipped with a feature that automatically shuts off the engine when the shift lever is in P with the engine running for an extended period.
- The engine will automatically shut off after approximately 1 hour if it has been left running while the shift lever is in P.
- The timer for the automatic engine shut off feature will reset if the brake pedal is depressed or if the shift lever is in a position other than P.
- After the vehicle is parked, if the door is locked with the door lock switch (→P. 108) from the inside or the mechanical key (→P. 512) from the outside, the automatic engine shut off feature will be disabled. The timer for the automatic engine shut off feature will be re-enabled if the driver's door is opened.

Electronic key battery depletion

→P. 104

Conditions affecting operation

→P. 117

Notes for the entry function

→P. 118

■ **If the engine does not start**

- The engine immobilizer system may not have been deactivated. (→P. 78)
Contact your Toyota dealer.
- Check that the shift lever is securely set in P. The engine may not start if the shift lever is displaced out of P.

■ **When a message requesting the smart key system be inspected is displayed on the multi-information display**

The system may be malfunctioning. Have the vehicle inspected by your Toyota dealer immediately.

■ **If the electronic key battery is depleted**

→P. 447

■ **Operation of the engine switch**

If the switch is not pressed shortly and firmly, the engine switch mode may not change or the engine may not start.

 **WARNING****■ When starting the engine**

Always start the engine while sitting in the driver's seat. Do not depress the accelerator pedal while starting the engine under any circumstances. Doing so may cause an accident resulting in death or serious injury.

■ Caution while driving

If engine failure occurs while the vehicle is moving, do not lock or open the doors until the vehicle reaches a safe and complete stop.

■ Stopping the engine in an emergency

● If you want to stop the engine in an emergency while driving the vehicle, press and hold the engine switch for more than 2 seconds, or press it briefly 3 times or more in succession. (→P. 467)

However, do not touch the engine switch while driving except in an emergency. Turning the engine off while driving will not cause loss of steering or braking control, but the power assist to these systems will be lost. This will make it more difficult to steer and brake, so you should pull over and stop the vehicle as soon as it is safe to do so.

● If the engine switch is operated while the vehicle is running, a warning message will be shown on the multi-information display and a buzzer sounds.

■ When parking

Exhaust gases include harmful carbon monoxide (CO), which is colorless and odorless. Observe the following precautions.

Failure to do so may cause exhaust gases to enter the vehicle and may lead to an accident caused by light-headedness, or may lead to death or a serious health hazard.

● If the vehicle is in a poorly ventilated area or a closed area, such as a garage, stop the engine.

● Do not leave the vehicle with the engine running for a long time. If such a situation cannot be avoided, park the vehicle in an open space and ensure that exhaust fumes do not enter the vehicle interior.

● Do not leave the engine running in an area with snow build-up, or where it is snowing. If snowbanks build up around the vehicle while the engine is running, exhaust gases may collect and enter the vehicle.



NOTICE

■ To prevent battery discharge

- Do not leave the engine switch in ACCESSORY or IGNITION ON mode for long periods of time without the engine running.
- If “ACCESSORY” or “IGNITION ON” is displayed on the multi-information display, the engine switch is not off. Exit the vehicle after turning the engine switch off.
- Do not stop the engine when the shift lever is in a position other than P. If the engine is stopped in another shift lever position, the engine switch will not be turned off but instead be turned to ACCESSORY mode. If the vehicle is left in ACCESSORY mode, battery discharge may occur.

■ When starting the engine

- Do not race a cold engine.
- If the engine becomes difficult to start or stalls frequently, have your vehicle checked by your Toyota dealer immediately.

■ Symptoms indicating a malfunction with the engine switch

If the engine switch seems to be operating somewhat differently than usual, such as the switch sticking slightly, there may be a malfunction. Contact your Toyota dealer immediately.

Automatic transmission

Shifting the shift lever

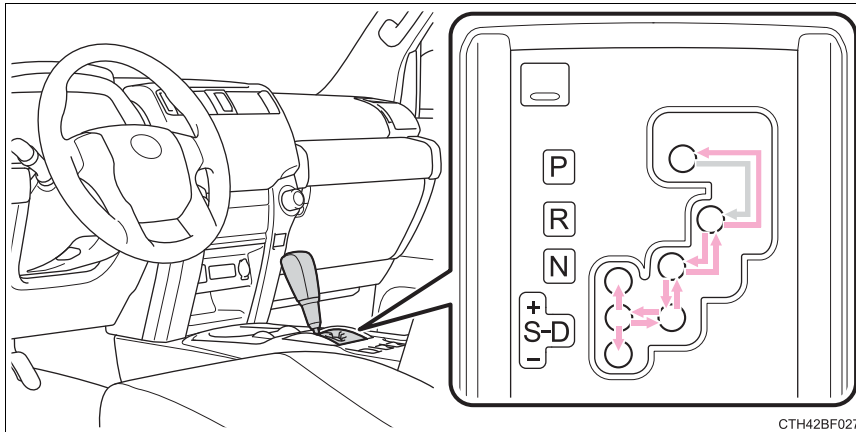

← While the engine switch is in IGNITION ON mode, move the shift lever with the brake pedal depressed.

When shifting the shift lever between P and D, make sure that the vehicle is completely stopped.

Shift position purpose

Shift position	Objective or function
P	Parking the vehicle/starting the engine
R	Reversing
N	Neutral
D	Normal driving ^{*1}
S	S mode driving ^{*2}

*1: To improve fuel efficiency and reduce noises, set the shift lever in the D position for normal driving.

*2: Selecting shift ranges using S mode restricts the upper limit of the possible gear ranges, controls engine braking forces, and prevents unnecessary upshifting

Changing shift ranges in S mode

When the shift lever is in the S position, the shift lever can be operated as follows:

- ① Upshifting
- ② Downshifting

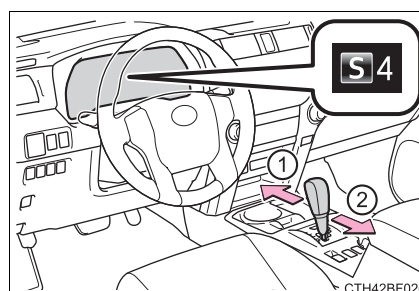

The initial shift range in S mode is set automatically to “4” according to vehicle speed. However, the initial shift range may be set to “3” if AI-SHIFT has operated while the shift lever was in the D position.

(→P. 207)

■ Shift ranges and their functions

You can choose from 5 levels of engine braking force.

A lower shift range will provide greater engine braking force than a higher shift range, and the engine speed will also increase.

■ S mode

When the shift range is “3” or lower, holding the shift lever toward “+” sets the shift range to “5”.

■ AI-SHIFT

AI-SHIFT automatically selects the optimal gear according to driver performance and driving conditions.

AI-SHIFT automatically operates when the shift lever is in the D position. (Shifting the shift lever to the S position or paddle shifting cancels the function.)

The engine speed may remain high after releasing the accelerator pedal. This does not indicate a malfunction.

■ When driving with Dynamic radar cruise control system

Engine braking will not occur in S mode, even when downshifting to “3”.
(→P. 257)

■ Restraining sudden start (Drive-start Control)

→P. 167

■ Shift lock system

The shift lock system is a system to prevent accidental operation of the shift lever in starting.

The shift lever can be shifted from P only when the engine switch is in the IGNITION ON mode the brake pedal is depressed and the shift release button is pushed.

■ **If the shift lever cannot be shifted from P**

First, check whether the brake pedal is being depressed.

If the shift lever cannot be shifted with your foot on the brake pedal, there may be a problem with the shift lock system. Have the vehicle inspected by your Toyota dealer immediately.

The following steps may be used as an emergency measure to ensure that the shift lever can be shifted.

Releasing the shift lock:

- 1 Set the parking brake.
- 2 Turn the engine switch is off.
- 3 Depress the brake pedal.
- 4 Pry the cover up with a flathead screwdriver or equivalent tool.

To prevent damage to the cover, cover the tip of the screwdriver with a rag.

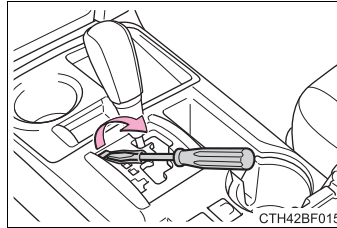

- 5 Press the shift lock override button.

The shift lever can be shifted while the button is pressed.

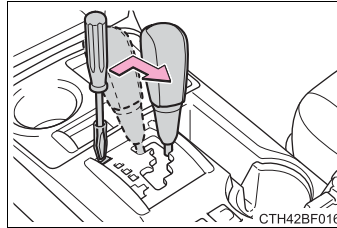

■ **If the “S” indicator does not come on even after shifting the shift lever to S**

This may indicate a malfunction in the automatic transmission system. Have the vehicle inspected by your Toyota dealer immediately.

(In this situation, the transmission will operate in the same manner as when the shift lever is in D.)

■ **Downshift restriction warning buzzer (S mode)**

To help ensure safety and driving performance, downshifting operation may sometimes be restricted. In some circumstances, downshifting may not be possible even when the shift lever is operated. (A buzzer will sound twice.)

 **WARNING****■ When driving on slippery road surfaces**

Be careful of downshifting and sudden acceleration, as this could result in the vehicle skidding to the side or spinning.

■ To prevent an accident when releasing the shift lock

Before pressing the shift lock override button, make sure to set the parking brake and depress the brake pedal.

If the accelerator pedal is accidentally depressed instead of the brake pedal when the shift lock override button is pressed and the shift lever is shifted out of P, the vehicle may suddenly start, possibly leading to an accident resulting in death or serious injury.

Turn signal lever

Operating instructions

The lever will return to its original position after operation.

- ① Right turn
- ② Lane change to the right (push and hold the lever partway)
The right hand signals will flash until you release the lever.
- ③ Lane change to the left (push and hold the lever partway)
The left hand signals will flash until you release the lever.
- ④ Left turn

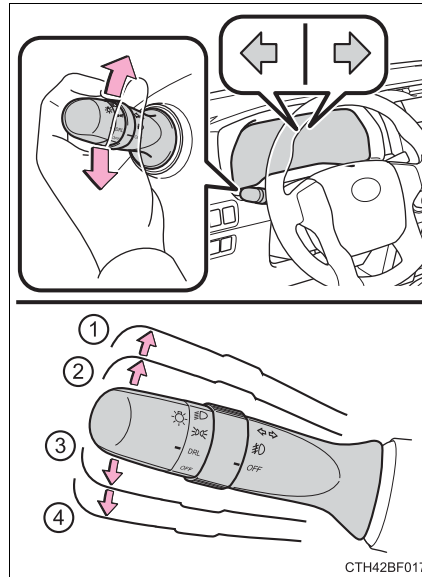

■ Turn signals can be operated when

The engine switch is in IGNITION ON mode.

■ If the indicator flashes faster than usual

Check that a light bulb in the front or rear turn signal lights has not burned out.

Parking brake

To set the parking brake, fully depress the parking brake pedal with your left foot while depressing the brake pedal with your right foot.

(Depressing the pedal again releases the parking brake.)

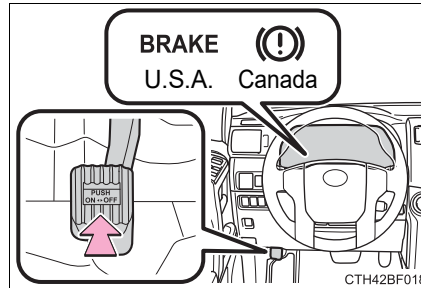

■ Parking the vehicle

→P. 166

■ Usage in winter time

→P. 332

⚠ NOTICE

■ Before driving

Fully release the parking brake.

Driving the vehicle with the parking brake set will lead to brake components overheating, which may affect braking performance and increase brake wear.



Headlight switch

The headlights can be operated manually or automatically.

Operating instructions



Operating the  switch turns on the lights as follows:

► Type A

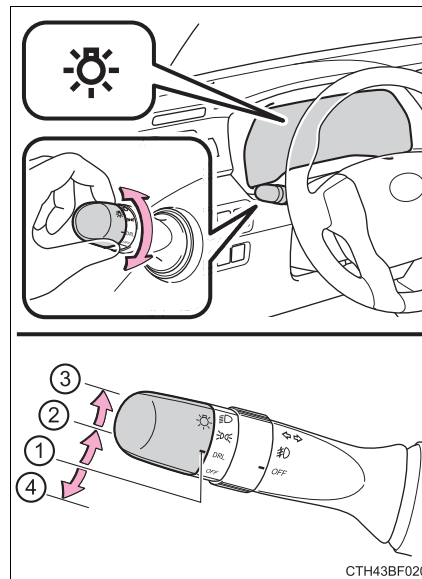
- ① **DRL** The daytime running lights turn on. (→P. 215)
- ②  The side marker, parking, tail, license plate, instrument panel lights, and daytime running lights (→P. 215) turn on.
- ③  The headlights and all the lights listed above (except daytime running lights) turn on.
- ④ **OFF** The daytime running lights turn off.



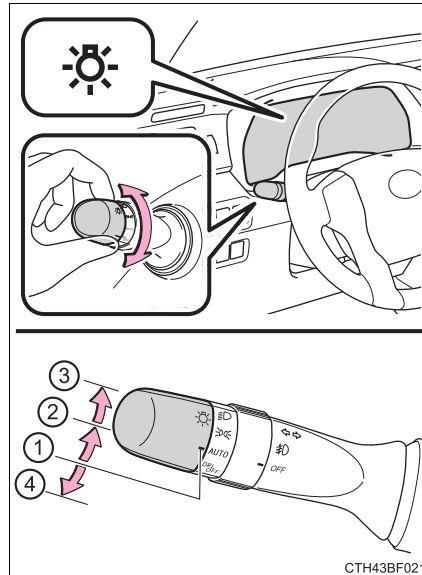

► Type B

- ① **AUTO** The headlights, parking lights, daytime running lights (→P. 215) and so on turn on and off automatically (when the engine switch is in IGNITION ON mode).
- ②  The side marker, parking, tail, license plate, instrument panel lights, and daytime running lights (→P. 215) turn on.
- ③  The headlights and all the lights listed above (except daytime running lights) turn on.
- ④  The daytime running lights turn off.



► Type C

- ① **AUTO** The headlights, parking lights, daytime running lights (→P. 215) and so on turn on and off automatically (when the engine switch is in IGNITION ON mode).
- ②  The side marker, parking, tail, license plate, instrument panel lights, and daytime running lights (→P. 215) turn on.
- ③  The headlights and all the lights listed above turn on.

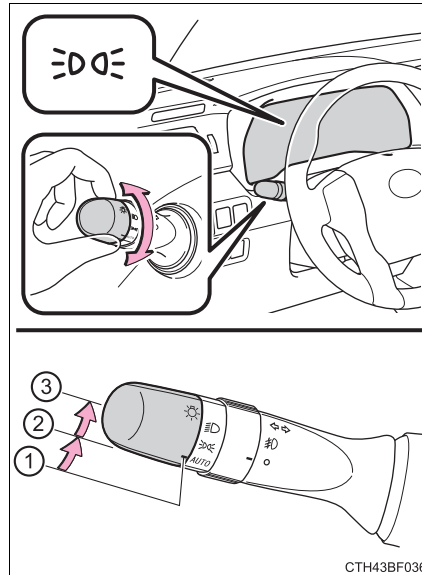

CTH43BF036

Turning on the high beam headlights

- ① With the headlights on, push the lever away from you to turn on the high beams.
Pull the lever toward you to the center position to turn the high beams off.
- ② Pull the lever toward you and release it to flash the high beams once.

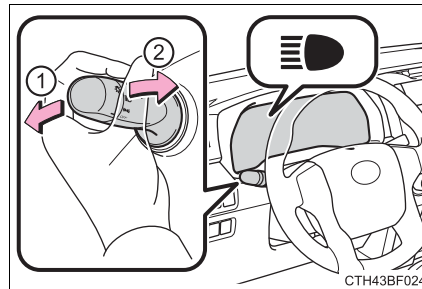

CTH43BF024

You can flash the high beams with the headlights on or off.

■ Daytime running light system

- Vehicles with a headlight high beam/daytime running lights: The daytime running lights illuminate using the same lights as the headlight high beam and illuminate dimmer than the headlight high beam.
- To make your vehicle more visible to other drivers during daytime driving, the daytime running lights turn on automatically when all of the following conditions are met. (The daytime running lights are not designed for use at night.)
 - The engine is running
 - The parking brake is released
 - The headlight switch is in the  , DRL (type A only), AUTO * (type B and C) position

*: When the surroundings are bright

The daytime running lights remain on after they illuminate, even if the parking brake is set again.

Type A and B: Daytime running lights can be turned off by operating the switch.

- Compared to turning on the headlights, the daytime running light system offers greater durability and consumes less electricity, so it can help improve fuel economy.

■ Headlight control sensor (if equipped)

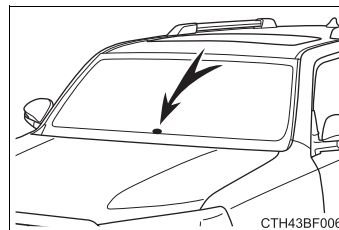

The sensor may not function properly if an object is placed on the sensor, or anything that blocks the sensor is affixed to the windshield.

Doing so interferes with the sensor detecting the level of ambient light and may cause the automatic headlight system to malfunction.



■ **Automatic light off system (if equipped)**

- When the headlights come on: The headlights and tail lights turn off 30 seconds after a door is opened and closed if the engine switch is turned to ACCESSORY mode or turned off. (The lights turn off immediately if  on the key is pressed after all the doors are locked.)
- When only the tail lights come on: The tail lights turn off automatically if the engine switch is turned off and the driver's door is opened.

To turn the lights on again, turn the engine switch to IGNITION ON mode, or turn the light switch off and then back to  or .

■ **Customization**

Settings (e.g. light sensor sensitivity) can be changed.
(Customizable features: →P. 549)



NOTICE

■ **To prevent battery discharge**

Do not leave the lights on longer than necessary when the engine is not running.

AHB (Automatic High Beam)

The Automatic High Beam uses a camera sensor located behind the upper portion of the windshield to assess the brightness of the lights of vehicles ahead, streetlights, etc., and automatically turns the high beams on or off as necessary.

⚠ WARNING

■ Limitations of the Automatic High Beam

Do not overly rely on the Automatic High Beam. Always drive safely, taking care to observe your surroundings and turning the high beams on or off manually if necessary.

■ To prevent incorrect operation of the Automatic High Beam system

Do not overload the vehicle.

Activating the Automatic High Beam

- 1 Push the lever away from you with the headlight switch in the **AUTO** or  position.

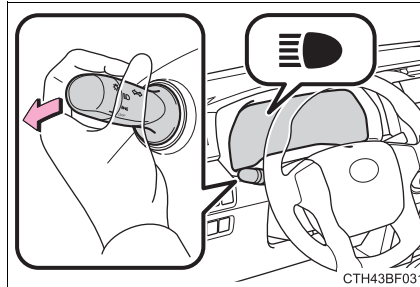

- 2 Press the Automatic High Beam switch.

The Automatic High Beam indicator will come on when the system is operating.

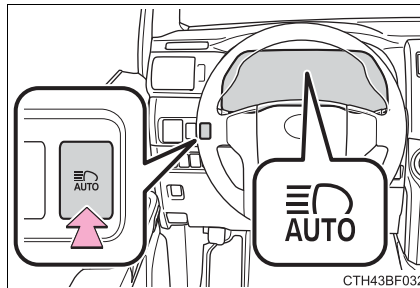

Turning the high beam on/off manually

■ Switching to low beam

Pull the lever to the original position.

The Automatic High Beam indicator will turn off.

Push the lever away from you to activate the Automatic High Beam system again.

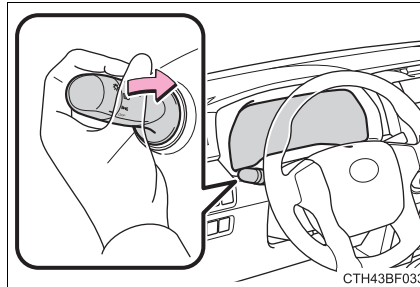

■ Switching to high beam

Press the Automatic High Beam switch.

The Automatic High Beam indicator will turn off and the high beam indicator will turn on.

Press the switch to activate the Automatic High Beam system again.

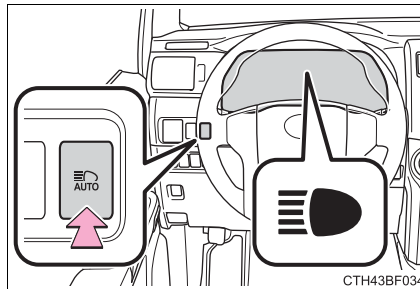

■ Conditions to turn the high beams on/off automatically

- When all of the following conditions are met, the high beams will be turned on automatically (after approximately 1 second):
 - The vehicle speed is approximately 21 mph (34 km/h) or more.
 - The area ahead of the vehicle is dark.
 - There are no vehicles ahead with headlights or tail lights turned on.
 - There are few streetlights on the road ahead.
- If any of the following conditions is met, the high beams will turn off automatically:
 - The vehicle speed is below approximately 17 mph (27 km/h).
 - The area ahead of the vehicle is not dark.
 - Vehicles ahead have their headlights or tail lights turned on.
 - There are many streetlights on the road ahead.

■ Camera sensor detection information

- The high beams may not be automatically turned off in the following situations:
 - When a vehicle suddenly appears from around a curve
 - When the vehicle is cut in front of by another vehicle
 - When vehicles ahead cannot be detected due to repeated curves, road dividers or roadside trees
 - When vehicles ahead appear in a faraway lane on a wide road
 - When the lights of vehicles ahead are not on
- The high beams may be turned off if a vehicle ahead that is using fog lights without its headlights turned on is detected.
- House lights, street lights, traffic signals, and illuminated billboards or signs and other reflective objects may cause the high beams to change to the low beams, or the low beams to remain on.
- The following factors may affect the amount of time taken for the high beams to turn on or off:
 - The brightness of the headlights, fog lights, and tail lights of vehicles ahead
 - The movement and direction of vehicles ahead
 - When a vehicle ahead only has operational lights on one side
 - When a vehicle ahead is a two-wheeled vehicle
 - The condition of the road (gradient, curve, condition of the road surface, etc.)
 - The number of passengers and amount of luggage in the vehicle
- The high beams may turn on or off unexpectedly.
- Bicycles or similar vehicles may not be detected.
- In the following situations the system may not be able to correctly detect the surrounding brightness level. This may cause the low beams to remain on or the high beams to flash or dazzle pedestrians or vehicles ahead. In such a case, it is necessary to manually switch between the high and low beams.

- When driving in inclement weather (heavy rain, snow, fog, sandstorms, etc.)
- When the windshield is obscured by fog, mist, ice, dirt, etc.
- When the windshield is cracked or damaged
- When the camera sensor is deformed or dirty
- When the temperature of the camera sensor is extremely high
- When the surrounding brightness level is equal to that of headlights, tail lights or fog lights
- When headlights or tail lights of vehicles ahead are turned off, dirty, changing color, or not aimed properly
- When the vehicle is hit by water, snow, dust, etc. from a preceding vehicle
- When driving through an area of intermittently changing brightness and darkness
- When frequently and repeatedly driving ascending/descending roads, or roads with rough, bumpy or uneven surfaces (such as stone-paved roads, gravel roads, etc.)
- When frequently and repeatedly taking curves or driving on a winding road
- When there is a highly reflective object ahead of the vehicle, such as a sign or mirror
- When the back of a preceding vehicle is highly reflective, such as a container on a truck
- When the vehicle's headlights are damaged or dirty, or are not aimed properly
- When the vehicle is listing or titling due to a flat tire, a trailer being towed, etc.
- When the headlights are changed between the high beams and low beams repeatedly in an abnormal manner
- When the driver believes that the high beams may be flashing or dazzling pedestrians or other drivers

■ Temporarily lowering sensor sensitivity

The sensitivity of the sensor can be temporarily lowered.

- 1 Turn the engine switch off while the following conditions are met.
 - The headlight switch is in AUTO or .
 - The headlight switch lever is in the high beam position.
 - Automatic High Beam switch is on.
- 2 Turn the engine switch to the IGNITION ON mode.
- 3 Within 60 seconds after 2, repeat pulling the headlight switch lever to the original position then pushing it to the high beam position quickly 10 times, then leave the lever in the high beam position.
- 4 If the sensitivity is changed, the Automatic High Beam indicator will turn on and off 3 times.

Automatic High Beam (headlights) may turn on even when the vehicle is stopped.

Fog light switch

The fog lights secure excellent visibility in difficult driving conditions, such as in rain and fog.

► Type A

- ① OFF Turns the front fog lights off
- ②  Turns the front fog lights on

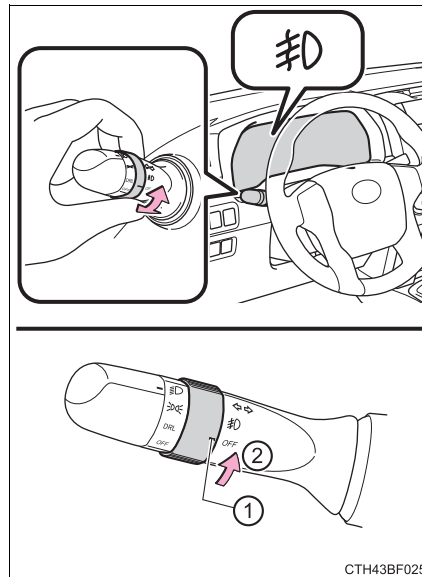

▶ Type B

- ① ○ Turns the front fog lights off
- ②  Turns the front fog lights on

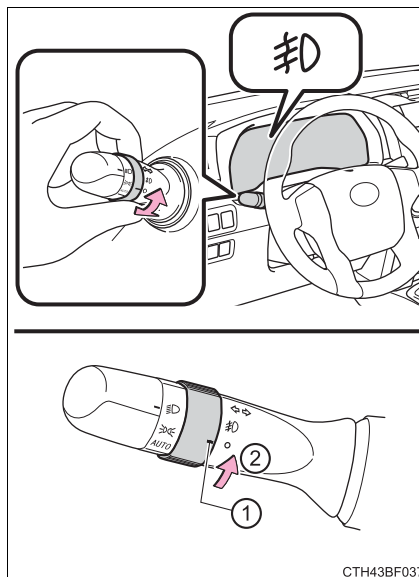

■ **Fog lights can be used when**
The headlights are on in low beam.

Windshield wipers and washer

Operating the wiper lever

Operating the  lever operates the wipers or washer as follows:

► Type A

Wiper intervals can be adjusted for intermittent operation (when INT is selected).

- ① INT Intermittent windshield wiper operation
- ② LO Low speed windshield wiper operation
- ③ HI High speed windshield wiper operation
- ④ MIST Temporary operation

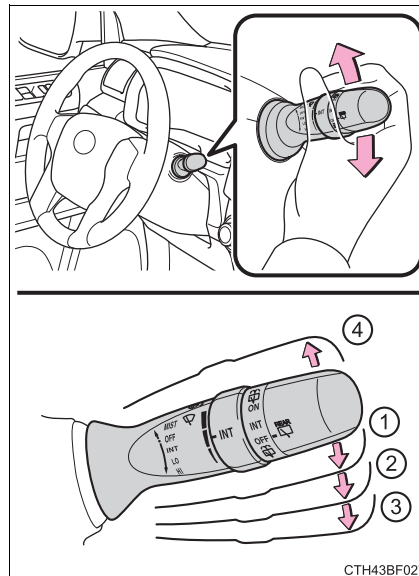



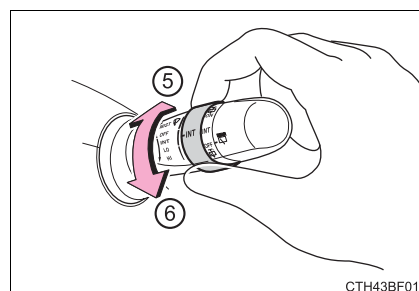

Wiper intervals can be adjusted when intermittent operation is selected.

- ⑤ Increases the intermittent windshield wiper frequency
- ⑥ Decreases the intermittent windshield wiper frequency



► Type B

Wiper intervals can be adjusted for intermittent operation (when  is selected).

- ①  Intermittent windshield wiper operation
- ②  Low speed windshield wiper operation
- ③  High speed windshield wiper operation
- ④  Temporary operation

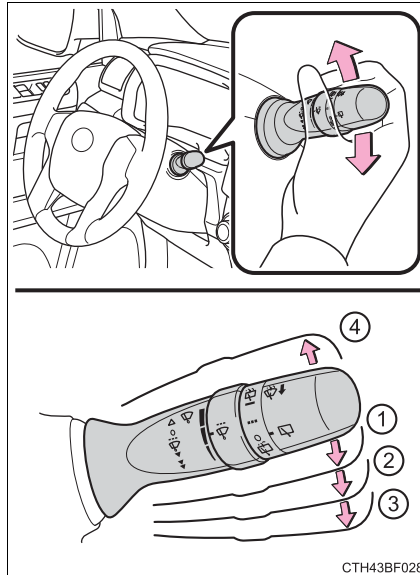

Wiper intervals can be adjusted when intermittent operation is selected.

- ⑤ Increases the intermittent windshield wiper frequency
- ⑥ Decreases the intermittent windshield wiper frequency

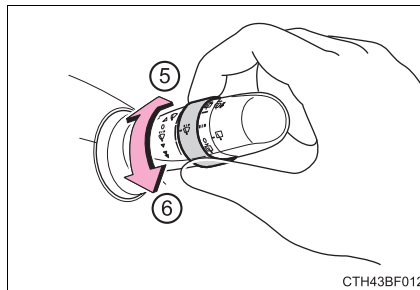

■  **Washer/wiper dual operation**

Pulling the lever operates the wipers and washer.

Wipers will automatically operate a couple of times after the washer squirts.

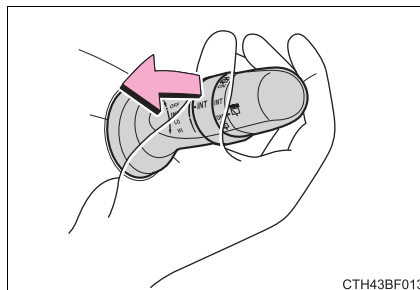

■ The windshield wiper and washer can be operated when

The engine switch is in IGNITION ON mode.

■ If no windshield washer fluid sprays

Check that the washer nozzles are not blocked if there is washer fluid in the washer fluid reservoir.

 **WARNING****■ Caution regarding the use of washer fluid**

When it is cold, do not use the washer fluid until the windshield becomes warm. The fluid may freeze on the windshield and cause low visibility. This may lead to an accident, resulting in death or serious injury.

 **NOTICE****■ When the windshield is dry**

Do not use the wipers, as they may damage the windshield.

■ When the washer fluid tank is empty

Do not operate the switch continually as the washer fluid pump may over-heat.

■ When a nozzle becomes blocked

In this case, contact your Toyota dealer.

Do not try to clear it with a pin or other object. The nozzle will be damaged.



Rear window wiper and washer

Before operating the rear window wiper and washer switch, make sure the back window is completely closed. (→P. 158)

Operating instructions

Operating the  switch operates the rear wiper or washer as follows:



▶ Type A

- ① **OFF** Off
- ② **INT** Intermittent window wiper operation
- ③ **ON** Normal window wiper operation
- ④  Washer/wiper dual operation
- ⑤  Washer/wiper dual operation

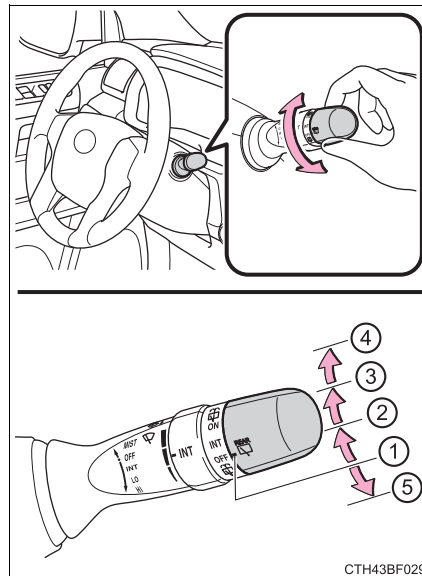
The wiper will automatically operate a couple of times after the washer squirts.
(After operating several times, the wiper operates one more time after a short delay to prevent dripping.)



▶ Type B

- ① ○ Off
- ② --- Intermittent window wiper operation
- ③ — Normal window wiper operation
- ④  Washer/wiper dual operation
- ⑤  Washer/wiper dual operation

The wiper will automatically operate a couple of times after the washer squirts.
(After operating several times, the wiper operates one more time after a short delay to prevent dripping.)

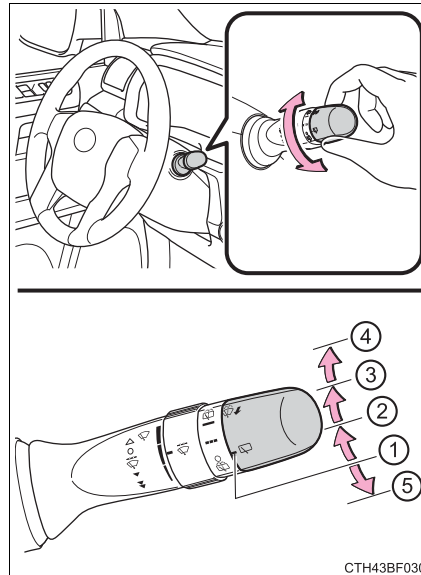

CTH43BF030

4

Driving

■ The rear window wiper and washer can be operated when

- The engine switch is in IGNITION ON mode.
- The back window is completely closed.

■ Intermittent window wiper operation

- When intermittent window wiper operation mode is selected, the wiper will operate a couple of times and then switch to intermittent operation.
- During intermittent operation, the wiper stops temporarily at the reversing position.

■ When the rear window wiper and washer switch is turned off

The rear wiper will stop operation, and return to the retracted position after approximately 3 seconds.

However, if the engine switch is turned to the engine switch is turned to ACCESSORY mode or turned off while the rear wiper is operating, the rear wiper will stop at that position and will not return to the retracted position.

■ If no washer fluid sprays

Check that the washer nozzle is not blocked if there is washer fluid in the washer fluid reservoir.

■ Customization

Settings (e.g. drip prevention function) can be changed.
(Customizable features →P. 549)



NOTICE

■ When the rear window is dry

Do not use the wiper, as it may damage the rear window.

■ When the washer fluid tank is empty

Do not operate the switch continually as the washer fluid pump may over-heat.

■ When a nozzle becomes blocked

In this case, contact your Toyota dealer.

Do not try to clear it with a pin or other object. The nozzle will be damaged.

Opening the fuel tank cap

Perform the following steps to open the fuel tank cap:

Before refueling the vehicle

- Close all the doors and windows, and turn the engine switch off.
- Confirm the type of fuel.

■ **Fuel types**

→P. 534

■ **Fuel tank opening for unleaded gasoline**

To help prevent incorrect fueling, your vehicle has a fuel tank opening that only accommodates the special nozzle on unleaded fuel pumps.

■ **If the malfunction indicator lamp illuminates**

The malfunction indicator lamp may illuminate erroneously if refueling is performed repeatedly when the fuel tank is nearly full.

 **WARNING****■ When refueling the vehicle**

Observe the following precautions while refueling the vehicle. Failure to do so may result in death or serious injury.

- After exiting the vehicle and before opening the fuel door, touch an unpainted metal surface to discharge any static electricity. It is important to discharge static electricity before refueling because sparks resulting from static electricity can cause fuel vapors to ignite while refueling.
- Always hold the grips on the fuel tank cap and turn it slowly to remove it. A whooshing sound may be heard when the fuel tank cap is loosened. Wait until the sound cannot be heard before fully removing the cap. In hot weather, pressurized fuel may spray out the filler neck and cause injury.
- Do not allow anyone that has not discharged static electricity from their body to come close to an open fuel tank.
- Do not inhale vaporized fuel.
Fuel contains substances that are harmful if inhaled.
- Do not smoke while refueling the vehicle.
Doing so may cause the fuel to ignite and cause a fire.
- Do not return to the vehicle or touch any person or object that is statically charged.
This may cause static electricity to build up, resulting in a possible ignition hazard.

■ When refueling

Observe the following precautions to prevent fuel overflowing from the fuel tank:

- Securely insert the fuel nozzle into the fuel filler neck.
- Stop filling the tank after the fuel nozzle automatically clicks off.
- Do not top off the fuel tank.

 **NOTICE****■ Refueling**

Do not spill fuel during refueling.

Doing so may damage the vehicle, such as causing the emission control system to operate abnormally or damaging fuel system components or the vehicle's painted surface.

Opening the fuel tank cap

- 1 Open the fuel filler door.

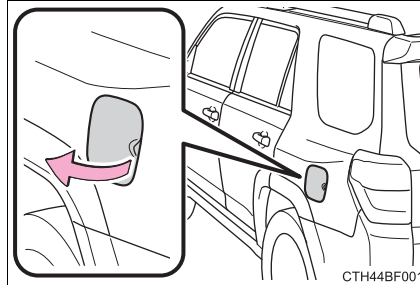

- 2 Turn the fuel tank cap slowly to open. Hang the fuel tank cap on the back of the fuel filler door.

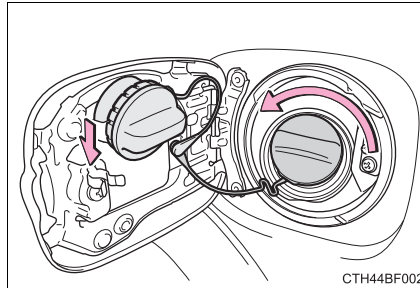
**Closing the fuel tank cap**

After refueling, turn the fuel tank cap until you hear a click. Once the cap is released, it will turn slightly in the opposite direction.

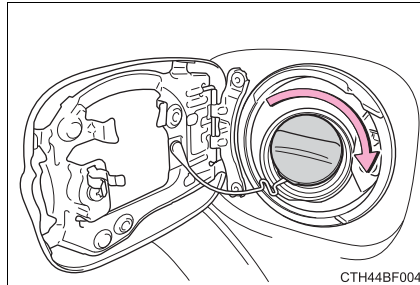
**⚠ WARNING****■ When replacing the fuel tank cap**

Do not use anything but a genuine Toyota fuel tank cap designed for your vehicle. Doing so may cause a fire or other incident which may result in death or serious injury.

Toyota Safety Sense P

The Toyota Safety Sense P consists of the following drive assist systems and contributes to a safe and comfortable driving experience:

Driving assist system

◆ **PCS (Pre-Collision System)**

→P. 239

◆ **LDA (Lane Departure Alert)**

→P. 249

◆ **AHB (Automatic High Beam)**

→P. 217

◆ **Dynamic radar cruise control**

→P. 257

 **WARNING**

■ **Toyota Safety Sense P**

The Toyota Safety Sense P is designed to operate under the assumption that the driver will drive safely, and is designed to help reduce the impact to the occupants and the vehicle in the case of a collision or assist the driver in normal driving conditions.

As there is a limit to the degree of recognition accuracy and control performance that this system can provide, do not overly rely on this system. The driver is always responsible for paying attention to the vehicle's surroundings and driving safely.

Sensors

Two types of sensors, located behind the front grille and windshield, detect information necessary to operate the drive assist systems.

- ① Radar sensor
- ② Front camera

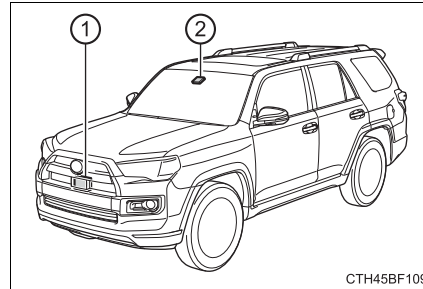

⚠ WARNING

■ To avoid malfunction of the radar sensor

Observe the following precautions.

Otherwise, the radar sensor may not operate properly, possibly leading to an accident resulting in death or serious injury.

● Keep the radar sensor and the radar sensor cover clean at all times.

- ① Radar sensor
- ② Radar sensor cover

If the front of the radar sensor or the front or back of the radar sensor cover is dirty or covered with water droplets, snow, etc., clean it.

Clean the radar sensor and radar sensor cover with a soft cloth to avoid damaging them.

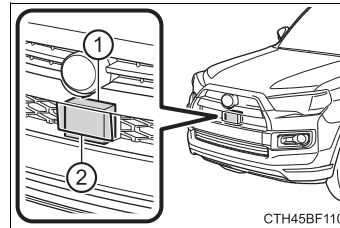

● Do not attach accessories, stickers (including transparent stickers) or other items to the radar sensor, radar sensor cover or surrounding area.

● Do not subject the radar sensor or its surrounding area to a strong impact. If the radar sensor, front grille, or front bumper has been subjected to a strong impact, have the vehicle inspected by your Toyota dealer.

● Do not disassemble the radar sensor.

● Do not modify or paint the radar sensor or radar sensor cover.

● In the following cases, the radar sensor must be recalibrated. Contact your Toyota dealer for details.

- When the radar sensor or front grille are removed and installed, or replaced
- When the front bumper is replaced

⚠ WARNING**■ To avoid malfunction of the front camera**

Observe the following precautions.

Otherwise, the front camera may not operate properly, possibly leading to an accident resulting in death or serious injury.

- Keep the windshield clean at all times.
 - If the windshield is dirty or covered with an oily film, water droplets, snow, etc., clean the windshield.
 - If a glass coating agent is applied to the windshield, it will still be necessary to use the windshield wipers to remove water droplets, etc. from the area of the windshield in front of the front camera.
 - If the inner side of the windshield where the front camera is installed is dirty, contact your Toyota dealer.

- Do not attach objects, such as stickers, transparent stickers, etc., to the outer side of the windshield in front of the front camera (shaded area in the illustration).

A: From the top of the windshield to approximately 0.4 in. (1 cm) below the bottom of the front camera

B: Approximately 7.9 in. (20 cm) (Approximately 4.0 in. [10 cm] to the right and left from the center of the front camera)

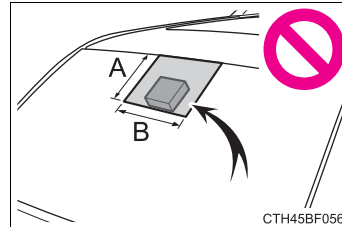

- If the part of the windshield in front of the front camera is fogged up or covered with condensation or ice, use the windshield defogger to remove the fog, condensation or ice. (→P. 344)
- If water droplets cannot be properly removed from the area of the windshield in front of the front camera by the windshield wipers, replace the wiper insert or wiper blade.
- Do not attach window tint to the windshield.
- Replace the windshield if it is damaged or cracked.
After replacing the windshield, the front camera must be recalibrated. Contact your Toyota dealer for details.
- Do not allow liquids to contact the front camera.
- Do not allow bright lights to shine into the front camera.

**WARNING**

- Do not dirty or damage the front camera.
When cleaning the inside of the windshield, do not allow glass cleaner to contact the lens of the front camera. Also, do not touch the lens.
If the lens is dirty or damaged, contact your Toyota dealer.
- Do not subject the front camera to a strong impact.
- Do not change the installation position or direction of the front camera or remove it.
- Do not disassemble the front camera.
- Do not modify any components of the vehicle around the front camera (inside rear view mirror, etc.) or ceiling.
- Do not attach any accessories to the hood, front grille or front bumper that may obstruct the front camera. Contact your Toyota dealer for details.
- If a surfboard or other long object is to be mounted on the roof, make sure that it will not obstruct the front camera.
- Do not modify the headlights or other lights.

■ **If a warning message is displayed on the multi-information display**

A system may be temporarily unavailable or there may be a malfunction in the system.

- In the following situations, perform the actions specified in the table. When the normal operating conditions are detected, the message will disappear and the system will become operational.

If the message does not disappear, contact your Toyota dealer.

Situation	Actions
When the area around a camera is covered with dirt, moisture (fogged up, covered with condensation, ice, etc.), or other foreign matter	Using the wiper and A/C function, remove the dirt and other attached matter. (→P. 344, 351)
When the temperature around the front camera is outside of the operational range, such as when the vehicle is in the sun or in an extremely cold environment	If the front camera is hot, such as after the vehicle had been parked in the sun, use the air conditioning system to decrease the temperature around the front camera. If a sunshade was used when the vehicle was parked, depending on its type, the sunlight reflected from the surface of the sunshade may cause the temperature of the front camera to become excessively high.
	If the front camera is cold, such as after the vehicle is parked in an extremely cold environment, use the air conditioning system to increase the temperature around the front camera.
The area in front of the front camera is obstructed, such as when the hood is open or a sticker is attached to the part of the windshield in front of the front camera.	Close the hood, remove the sticker, etc. to clear the obstruction.
When "Pre-Collision System Unavailable" is displayed.	Check whether there is attached materials on the radar sensor and radar sensor cover, and if there is, remove it.

- In the following situations, if the situation has changed (or the vehicle has been driven for some time) and the normal operating conditions are detected, the message will disappear and the system will become operational.

If the message does not disappear, contact your Toyota dealer.

- When the temperature around the radar sensor is outside of the operational range, such as when the vehicle is in the sun or in an extremely cold environment
- When the front camera cannot detect objects in front of the vehicle, such as when driving in the dark, snow, or fog, or when bright lights are shining into the front camera
- Depending on the conditions in the vicinity of the vehicle, the radar may judge the surrounding environment can not be properly recognized. In that case, "Pre-Collision System Unavailable" is displayed.

PCS (Pre-Collision System)

The pre-collision system uses a radar sensor and front camera to detect vehicles and pedestrians in front of your vehicle. When the system determines that the possibility of a frontal collision with a vehicle or pedestrian is high, a warning operates to urge the driver to take evasive action and the potential brake pressure is increased to help the driver avoid the collision. If the system determines that the possibility of a frontal collision with a vehicle or pedestrian is extremely high, the brakes are automatically applied to help avoid the collision or help reduce the impact of the collision.

The pre-collision system can be disabled/enabled and the warning timing can be changed. (→P. 242)

◆ Pre-collision warning

When the system determines that the possibility of a frontal collision is high, a buzzer will sound and a warning message will be displayed on the multi-information display to urge the driver to take evasive action.

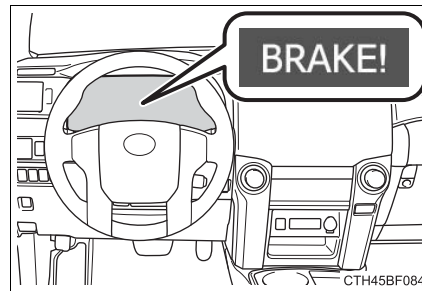

◆ Pre-collision brake assist

When the system determines that the possibility of a frontal collision is high, the system applies greater braking force in relation to how strongly the brake pedal is depressed.

◆ Pre-collision braking

When the system determines that the possibility of a frontal collision is high, the system warns the driver. If the system determines that the possibility of a frontal collision is extremely high, the brakes are automatically applied to help avoid the collision or reduce the collision speed.

 **WARNING****■ Limitations of the pre-collision system**

- The driver is solely responsible for safe driving. Always drive safely, taking care to observe your surroundings.

Do not use the pre-collision system instead of normal braking operations under any circumstances. This system will not prevent collisions or lessen collision damage or injury in every situation. Do not overly rely on this system. Failure to do so may lead to an accident, resulting in death or serious injury.

- Although this system is designed to help avoid a collision or help reduce the impact of the collision, its effectiveness may change according to various conditions, therefore the system may not always be able to achieve the same level of performance.

Read the following conditions carefully. Do not overly rely on this system and always drive carefully.

- Conditions under which the system may operate even if there is no possibility of a collision: →P. 244
- Conditions under which the system may not operate properly: →P. 246

- Do not attempt to test the operation of the pre-collision system yourself. Depending on the objects used for testing (dummies, cardboard objects imitating detectable objects, etc.), the system may not operate properly, possibly leading to an accident.

■ Pre-collision braking

- When the pre-collision braking function is operating, a large amount of braking force will be applied.
- If the vehicle is stopped by the operation of the pre-collision braking function, the pre-collision braking function operation will be canceled after approximately 2 seconds. Depress the brake pedal as necessary.
- The pre-collision braking function may not operate if certain operations are performed by the driver. If the accelerator pedal is being depressed strongly or the steering wheel is being turned, the system may determine that the driver is taking evasive action and possibly prevent the pre-collision braking function from operating.
- In some situations, while the pre-collision braking function is operating, operation of the function may be canceled if the accelerator pedal is depressed strongly or the steering wheel is turned and the system determines that the driver is taking evasive action.
- If the brake pedal is being depressed, the system may determine that the driver is taking evasive action and possibly delay the operation timing of the pre-collision braking function.

 **WARNING****■ When to disable the pre-collision system**

In the following situations, disable the system, as it may not operate properly, possibly leading to an accident resulting in death or serious injury:

- When the vehicle is being towed
- When your vehicle is towing another vehicle
- When transporting the vehicle via truck, boat, train or similar means of transportation
- When the vehicle is raised on a lift with the engine running and the tires are allowed to rotate freely
- When inspecting the vehicle using a drum tester such as a chassis dynamometer or speedometer tester, or when using an on vehicle wheel balancer
- When a strong impact is applied to the front bumper or front grille, due to an accident or other reasons
- If the vehicle cannot be driven in a stable manner, such as when the vehicle has been in an accident or is malfunctioning
- When the vehicle is driven in a sporty manner or off-road
- When the tires are not properly inflated
- When the tires are very worn
- When tires of a size other than specified are installed
- When tire chains are installed
- When a compact spare tire or an emergency tire puncture repair kit is used
- If equipment (snow plow, etc.) that may obstruct the radar sensor or front camera is temporarily installed to the vehicle

Changing settings of the pre-collision system

■ Enabling/disabling the pre-collision system

The pre-collision system can be enabled/disabled on  (→P. 96) of the multi-information display.

The system is automatically enabled each time the engine switch is turned to IGNITION ON mode.

If the system is disabled, the PCS warning light will turn on and a message will be displayed on the multi-information display.

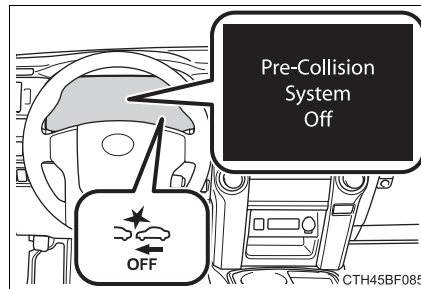

■ Changing the pre-collision warning timing

The pre-collision warning timing can be changed on  (→P. 96) of the multi-information display.

The operation timing setting is retained when the engine switch is turned off.

- ① Far
The warning will begin to operate earlier than with the default timing.
- ② Middle
This is the default setting.
- ③ Near
The warning will begin to operate later than with the default timing.

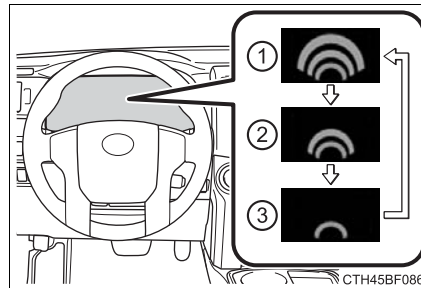

■ Operational conditions

The pre-collision system is enabled and the system determines that the possibility of a frontal collision with a vehicle or pedestrian is high.

Each function is operational at the following speeds:

- Pre-collision warning:
 - Vehicle speed is between approximately 7 and 110 mph (10 and 180 km/h). (For detecting a pedestrian, vehicle speed is between approximately 7 and 50 mph [10 and 80 km/h].)
 - The relative speed between your vehicle and the vehicle or pedestrian ahead is approximately 7 mph (10 km/h) or more.
- Pre-collision brake assist:
 - Vehicle speed is between approximately 20 and 110 mph (30 and 180 km/h). (For detecting a pedestrian, vehicle speed is between approximately 20 and 50 mph [30 and 80 km/h].)
 - The relative speed between your vehicle and the vehicle or pedestrian ahead is approximately 20 mph (30 km/h) or more.
- Pre-collision braking:
 - Vehicle speed is between approximately 7 and 110 mph (10 and 180 km/h). (For detecting a pedestrian, vehicle speed is between approximately 7 and 50 mph [10 and 80 km/h].)
 - The relative speed between your vehicle and the vehicle or pedestrian ahead is approximately 7 mph (10 km/h) or more.

The system may not operate in the following situations:

- If a battery terminal has been disconnected and reconnected and then the vehicle has not been driven for a certain amount of time
- If the shift lever is in R
- If VSC is disabled (only the pre-collision warning function will be operational)
- If the low speed four-wheel drive indicator is illuminated (only the pre-collision warning function will be operational)

■ Pedestrian detection function

The pre-collision system detects pedestrians based on the size, profile, and motion of a detected object. However, a pedestrian may not be detected depending on the surrounding brightness and the motion, posture, and angle of the detected object, preventing the system from operating properly. (→P. 248)

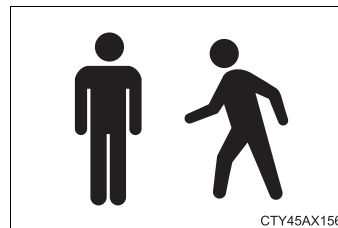

■ **Cancellation of the pre-collision braking**

If either of the following occur while the pre-collision braking function is operating, it will be canceled:

- The accelerator pedal is depressed strongly.
- The steering wheel is turned sharply or abruptly.

■ **Conditions under which the system may operate even if there is no possibility of a collision**

● In some situations such as the following, the system may determine that there is a possibility of a frontal collision and operate.

- When passing a vehicle or pedestrian
- When changing lanes while overtaking a preceding vehicle
- When overtaking a preceding vehicle that is changing lanes
- When overtaking a preceding vehicle that is making a left/right turn

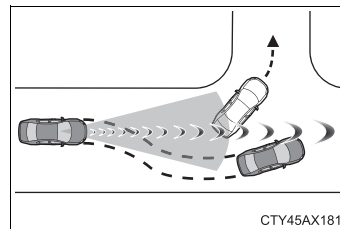

- When passing a vehicle in an oncoming lane that is stopped to make a right/left turn

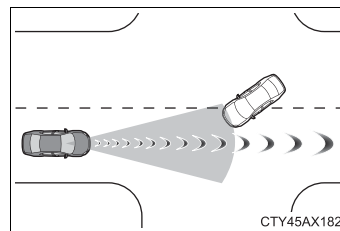

- When driving on a road where relative location to vehicle ahead in an adjacent lane may change, such as on a winding road

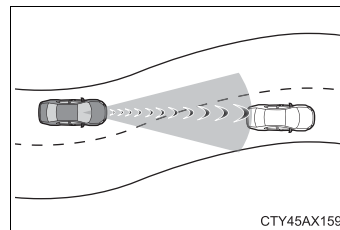

- When rapidly closing on a vehicle ahead
- If the front of the vehicle is raised or lowered, such as when the road surface is uneven or undulating
- When approaching objects on the roadside, such as guardrails, utility poles, trees, or walls

- When there is a vehicle, pedestrian, or object by the roadside at the entrance of a curve

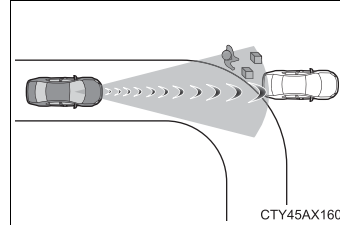

- When driving on a narrow path surrounded by a structure, such as in a tunnel or on an iron bridge
- When there is a metal object (manhole cover, steel plate, etc.), steps, or a protrusion on the road surface or roadside
- When a crossing pedestrian approaches very close to the vehicle

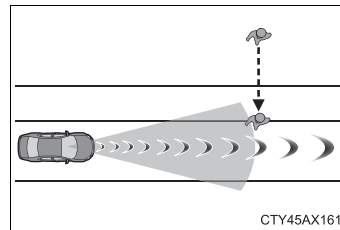

- When passing through a place with a low structure above the road (low ceiling, traffic sign, etc.)

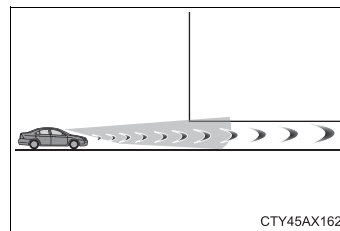

- When passing under an object (billboard, etc.) at the top of an uphill road

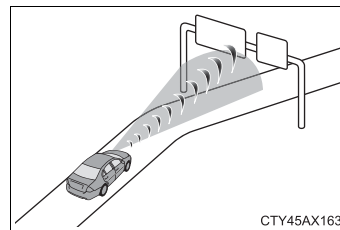

- When rapidly closing on an electric toll gate barrier, parking area barrier, or other barrier that opens and closes
- When using an automatic car wash

- When driving through or under objects that may contact the vehicle, such as thick grass, tree branches, or a banner

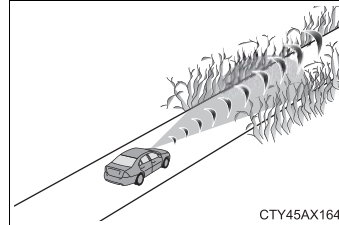

- When the vehicle is hit by water, snow, dust, etc. from a vehicle ahead
- When driving through steam or smoke
- When there are patterns or paint on the road or a wall that may be mistaken for a vehicle or pedestrian
- When driving near an object that reflects radio waves, such as a large truck or guardrail
- When driving near a TV tower, broadcasting station, electric power plant, or other location where strong radio waves or electrical noise may be present

■ **Situations in which the system may not operate properly**

- In some situations such as the following, a vehicle may not be detected by the radar sensor and front camera, preventing the system from operating properly:

- If an oncoming vehicle is approaching your vehicle
- If a vehicle ahead is a motorcycle or bicycle
- When approaching the side or front of a vehicle
- If a preceding vehicle has a small rear end, such as an unloaded truck
- If a preceding vehicle has a low rear end, such as a low bed trailer

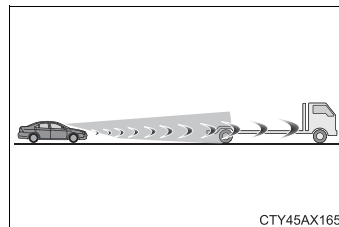

- If a vehicle ahead is carrying a load which protrudes past its rear bumper
- If a vehicle ahead has extremely high ground clearance

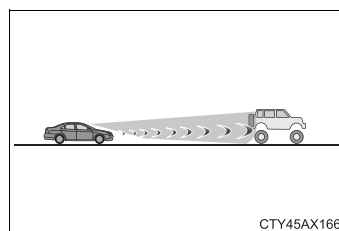

- If a vehicle ahead is irregularly shaped, such as a tractor or side car
- If the sun or other light is shining directly on a vehicle ahead
- If a vehicle cuts in front of your vehicle or emerges from beside a vehicle

- If a vehicle ahead makes an abrupt maneuver (such as sudden swerving, acceleration or deceleration)
- When suddenly cutting behind a preceding vehicle
- When a vehicle ahead is not directly in front of your vehicle

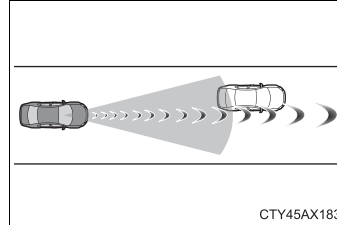

- When driving in inclement weather such as heavy rain, fog, snow or a sandstorm
- When the vehicle is hit by water, snow, dust, etc. from a vehicle ahead
- When driving through steam or smoke
- When driving in a place where the surrounding brightness changes suddenly, such as at the entrance or exit of a tunnel
- When a very bright light, such as the sun or the headlights of oncoming traffic, shines directly into the front camera
- When the surrounding area is dim, such as at dawn or dusk, or while at night or in a tunnel
- After the engine has started the vehicle has not been driven for a certain amount of time
- While making a left/right turn and for a few seconds after making a left/right turn
- While driving on a curve and for a few seconds after driving on a curve
- If your vehicle is skidding
- If the front of the vehicle is raised or lowered

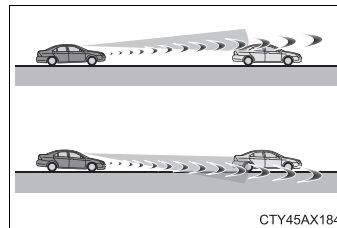

- If the wheels are misaligned
- If a wiper blade is blocking the front camera
- The vehicle is wobbling.
- The vehicle is being driven at extremely high speeds.
- When driving on a hill
- If the radar sensor or front camera is misaligned

- In some situations such as the following, sufficient braking force may not be obtained, preventing the system from performing properly:
 - If the braking functions cannot operate to their full extent, such as when the brake parts are extremely cold, extremely hot, or wet
 - If the vehicle is not properly maintained (brakes or tires are excessively worn, improper tire inflation pressure, etc.)
 - When the vehicle is being driven on a gravel road or other slippery surface
- Some pedestrians such as the following may not be detected by the radar sensor and front camera, preventing the system from operating properly:
 - Pedestrians shorter than approximately 3.2 ft. (1 m) or taller than approximately 6.5 ft. (2 m)
 - Pedestrians wearing oversized clothing (a rain coat, long skirt, etc.), making their silhouette obscure
 - Pedestrians who are carrying large baggage, holding an umbrella, etc., hiding part of their body
 - Pedestrians who are bending forward or squatting
 - Pedestrians who are pushing a stroller, wheelchair, bicycle or other vehicle
 - Groups of pedestrians which are close together
 - Pedestrians who are wearing white and look extremely bright
 - Pedestrians in the dark, such as at night or while in a tunnel
 - Pedestrians whose clothing appears to be nearly the same color or brightness as their surroundings
 - Pedestrians near walls, fences, guardrails, or large objects
 - Pedestrians who are on a metal object (manhole cover, steel plate, etc.) on the road
 - Pedestrians who are walking fast
 - Pedestrians who are changing speed abruptly
 - Pedestrians running out from behind a vehicle or a large object
 - Pedestrians who are extremely close to the side of the vehicle (outside rear view mirror, etc.)
- **If VSC is disabled**
 - If VSC is disabled (→P. 324, 325), the pre-collision brake assist and pre-collision braking functions are also disabled.
 - The PCS warning light will turn on and “VSC Turned Off Pre-Collision Brake System Unavailable” will be displayed on the multi-information display.

LDA (Lane Departure Alert)

Summary of functions

When driving on roads with white (yellow) lines, this function alerts the driver when the vehicle might depart from its lane.

The LDA system recognizes visible white (yellow) lines with the camera sensor on the upper portion of the windshield.

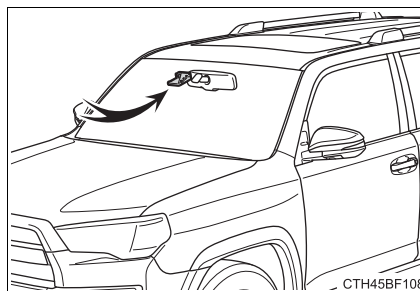

Functions included in LDA system

◆ Lane departure alert function

When the system determines that the vehicle might depart from its lane, a warning is displayed on the multi-information display and the warning buzzer sounds to alert the driver.

When the warning buzzer sounds, check the surrounding road situation and carefully operate the steering wheel to move the vehicle back to the center of the lane.

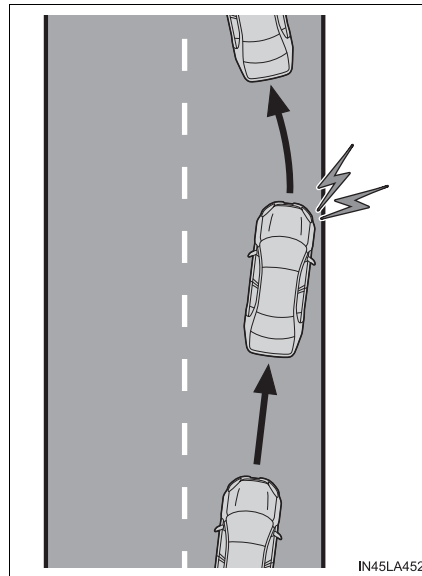

◆ Vehicle sway warning function

When the vehicle is swaying or appears as if it may depart from its lane multiple times, the warning buzzer sounds and a message is displayed on the multi-information display to alert the driver.

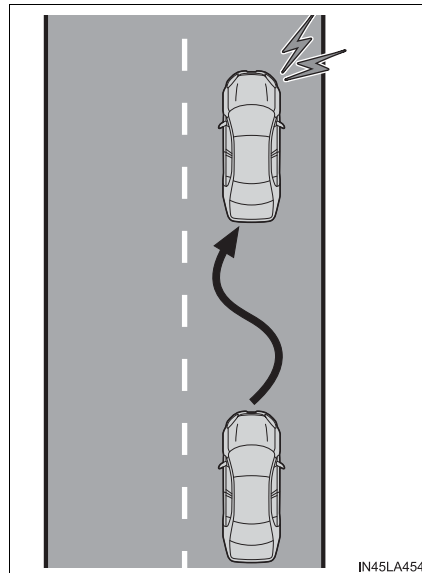

⚠ WARNING**■ Before using LDA system**

Do not rely solely upon the LDA system. The LDA system does not automatically drive the vehicle or reduce the amount of attention that must be paid to the area in front of the vehicle. The driver must always assume full responsibility for driving safely by paying careful attention to the surrounding conditions and operating the steering wheel to correct the path of the vehicle. Also, the driver must take adequate breaks when fatigued, such as from driving for a long period of time.

Failure to perform appropriate driving operations and pay careful attention may lead to an accident, resulting in death or serious injury.

■ To avoid operating LDA system by mistake

When not using the LDA system, use the LDA switch to turn the system off.

■ Situations unsuitable for LDA system

Do not use the LDA system in the following situations.

The system may not operate properly and lead to an accident, resulting in death or serious injury.

- A spare tire, tire chains, etc. are equipped.
- Objects or patterns that could be mistaken for white (yellow) lines are present on the side of the road (guardrails, curbs, reflective poles, etc.).
- Vehicle is driven on a snow-covered road.
- White (yellow) lines are difficult to see due to rain, snow, fog, dust, etc.
- Asphalt repair marks, white (yellow) line marks, etc. are present due to road repair.
- Vehicle is driven in a temporary lane or restricted lane due to construction work.
- Vehicle is driven in a construction zone.

■ Preventing LDA system malfunctions and operations performed by mistake

- Do not modify the headlights or place stickers, etc. on the surface of the lights.
- Do not modify the suspension etc. If the suspension etc. needs to be replaced, contact your Toyota dealer.
- Do not install or place anything on the hood or grille. Also, do not install a grille guard (bull bars, kangaroo bar, etc.).
- If your windshield needs repairs, contact your Toyota dealer.

Turning LDA system on

Press the LDA switch to turn the LDA system on.

The LDA indicator illuminates and a message is displayed on the multi-information display.

Press the LDA switch again to turn the LDA system off.

When the LDA system is turned on or off, operation of the LDA system continues in the same condition the next time the engine is started.

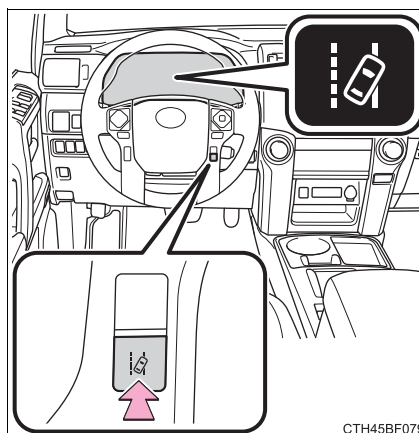

Indications on multi-information display

The illustration used is intended as an example, and may differ from the image that is actually displayed on the multi-information display.

① LDA indicator

The illumination condition of the indicator informs the driver of the system operation status.

Illuminated in green:
LDA system is operating.

Flashing in Yellow:
Lane departure alert function is operating.

② Lane departure alert function display

Displayed when the multi-information display is switched to the driving assist system information screen.

▶ Inside of displayed white lines is white

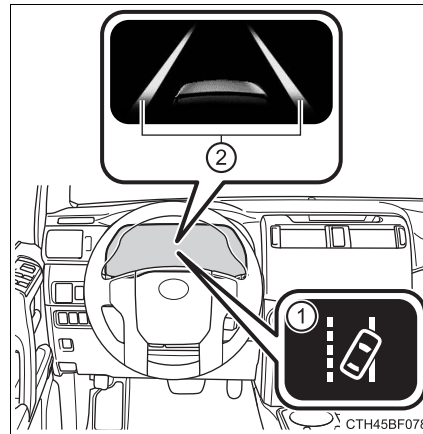

▶ Inside of displayed white lines is black



CTH45BF080

Indicates that the system is recognizing white (yellow) lines. When the vehicle departs from its lane, the white line displayed on the side the vehicle departs from flashes yellow.



CTH45BF081

Indicates that the system is not able to recognize white (yellow) lines or is temporarily canceled.

■ Operation conditions of each function

● Lane departure alert function

This function operates when all of the following conditions are met.

- LDA is turned on.
- Vehicle speed is approximately 32 mph (50 km/h) or more.
- System recognizes white (yellow) lines.
- Width of traffic lane is approximately 9.8 ft. (3 m) or more.
- Turn signal lever is not operated.
- Vehicle is driven on a straight road or around a gentle curve with a radius of more than approximately 492 ft. (150 m).
- No system malfunctions are detected. (→P. 256)

● Vehicle sway warning function

This function operates when all of the following conditions are met.

- Setting for “Sway Warning” in  of the multi-information display is set to “On”. (→P. 96)
- Vehicle speed is approximately 32 mph (50 km/h) or more.
- Width of traffic lane is approximately 9.8 ft. (3 m) or more.
- No system malfunctions are detected. (→P. 256)

■ Temporary cancellation of functions

When the operation conditions are no longer met, a function may be temporarily canceled. However, when the operation conditions are met again, operation of the function is automatically restored. (→P. 254)

■ Lane departure alert function

The warning buzzer may be difficult to hear due to external noise, audio playback, etc.

■ Vehicle sway warning function

When the system determines that the vehicle is swaying while the vehicle sway warning function is operating, a buzzer sounds and a warning message urging the driver to rest and the symbol shown in the illustration are simultaneously displayed on the multi-information display.

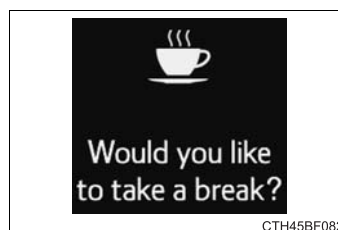

Depending on the vehicle and road conditions, the warning may not operate.

■ White (yellow) lines are only on one side of road

The LDA system will not operate for the side on which white (yellow) lines could not be recognized.

■ Conditions in which functions may not operate properly

In the following situations, the camera sensor may not detect white (yellow) lines and various functions may not operate normally.

- There are shadows on the road that run parallel with, or cover, the white (yellow) lines.
- The vehicle is driven in an area without white (yellow) lines, such as in front of a tollgate or checkpoint, or at an intersection, etc.
- The white (yellow) lines are cracked, “Botts’ dots”, “Raised pavement marker” or stones are present.
- The white (yellow) lines cannot be seen or are difficult to see due to sand, etc.
- The vehicle is driven on a road surface that is wet due to rain, puddles, etc.
- The traffic lines are yellow (which may be more difficult to recognize than lines that are white).
- The white (yellow) lines cross over a curb, etc.
- The vehicle is driven on a bright surface, such as concrete.
- The vehicle is driven on a surface that is bright due to reflected light, etc.
- The vehicle is driven in an area where the brightness changes suddenly, such as at the entrances and exits of tunnels, etc.
- Light from the headlights of an oncoming vehicle, the sun, etc. enters the camera.
- The vehicle is driven where the road diverges, merges, etc.
- The vehicle is driven on a slope.
- The vehicle is driven on a road which tilts left or right, or a winding road.
- The vehicle is driven on an unpaved or rough road.
- The vehicle is driven around a sharp curve.
- The traffic lane is excessively narrow or wide.
- The vehicle is extremely tilted due to carrying heavy luggage or having improper tire pressure.
- The distance to the preceding vehicle is extremely short.
- The vehicle is moving up and down a large amount due to road conditions during driving (poor roads or road seams).
- The headlight lenses are dirty and emit a faint amount of light at night, or the beam axis has deviated.
- The vehicle has just changed lanes or crossed an intersection.

■ Warning message

If the following warning message is displayed on the multi-information display and the LDA indicator illuminates in amber, follow the appropriate troubleshooting procedure.

Warning message	Details/Actions
“LDA Malfunction Visit Your Dealer”	The system may not be operating properly. → Have the vehicle inspected at your Toyota dealer.
“Front Camera Unavailable”	The operation conditions of the camera sensor (temperature, etc.) are not met. → When the operation conditions of the camera sensor (temperature, etc.) are met, the LDA system will become available. Turn the LDA system off, wait for a little while, and then turn the LDA system back on.
“LDA Unavailable”	The LDA system is temporarily canceled due to a malfunction in a sensor other than the camera sensor. → Turn the LDA system off and follow the appropriate troubleshooting procedures for the warning message. Afterward, wait for a little while, and then turn the LDA system back on.
“LDA Unavailable Below Approx 32MPH”	The LDA system cannot be used as the vehicle speed is less than approximately 32 mph (50 km/h). → Drive the vehicle at approximately 32 mph (50 km/h) or more.

If a different warning message is displayed, follow the instructions displayed on the screen.

■ Customization

Some functions can be customized. (→P. 549)

Dynamic radar cruise control

Summary of functions

In vehicle-to-vehicle distance control mode, the vehicle automatically accelerates and decelerates to match the speed changes of the preceding vehicle even if the accelerator pedal is not depressed. In constant speed control mode, the vehicle runs at a fixed speed.

Use the dynamic radar cruise control on freeways and highways.

- Vehicle-to-vehicle distance control mode (→P. 261)
- Constant speed control mode (→P. 266)

- ① Display
- ② Indicators
- ③ Set speed
- ④ Vehicle-to-vehicle distance switch
- ⑤ Cruise control switch

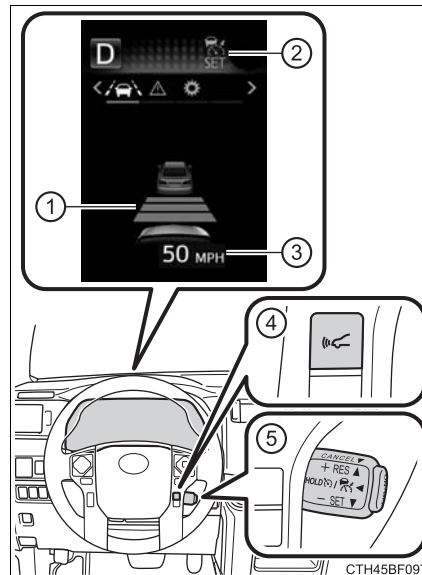

 **WARNING****■ Before using dynamic radar cruise control**

- Driving safely is the sole responsibility of the driver. Do not rely solely on the system, and drive safely by always paying careful attention to your surroundings.
- The dynamic radar cruise control provides driving assistance to reduce the driver's burden. However, there are limitations to the assistance provided. Read the following conditions carefully. Do not overly rely on this system and always drive carefully.
 - When the sensor may not be correctly detecting the vehicle ahead:
→P. 268
 - Conditions under which the vehicle-to-vehicle distance control mode may not function correctly: →P. 269
- Set the speed appropriately depending on the speed limit, traffic flow, road conditions, weather conditions, etc. The driver is responsible for checking the set speed.
- Even when the system is functioning normally, the condition of the preceding vehicle as detected by the system may differ from the condition observed by the driver. Therefore, the driver must always remain alert, assess the danger of each situation and drive safely. Relying on this system or assuming the system ensures safety while driving can lead to an accident, resulting in death or serious injury.
- Switch the dynamic radar cruise control off using the "ON-OFF" button when not in use.

 **WARNING****■ Cautions regarding the driving assist systems**

Observe the following precautions, as there are limitations to the assistance provided by the system.

Failure to do so may cause an accident resulting in death or serious injury.

● Assisting the driver to measure following distance

The dynamic radar cruise control is only intended to help the driver in determining the following distance between the driver's own vehicle and a designated vehicle traveling ahead. It is not a mechanism that allows careless or inattentive driving, and it is not a system that can assist the driver in low-visibility conditions. It is still necessary for driver to pay close attention to the vehicle's surroundings.

● Assisting the driver to judge proper following distance

The dynamic radar cruise control determines whether the following distance between the driver's own vehicle and a designated vehicle traveling ahead is within a set range. It is not capable of making any other type of judgement. Therefore, it is absolutely necessary for the driver to remain vigilant and to determine whether or not there is a possibility of danger in any given situation.

● Assisting the driver to operate the vehicle

The dynamic radar cruise control has limited capability to prevent or avoid a collision with a vehicle traveling ahead. Therefore, if there is ever any danger, the driver must take immediate and direct control of the vehicle and act appropriately in order to ensure the safety of all involved.

 **WARNING****■ Situations unsuitable for dynamic radar cruise control**

Do not use dynamic radar cruise control in any of the following situations. Doing so may result in inappropriate speed control and could cause an accident resulting in death or serious injury.

- Roads where there are pedestrians, cyclers, etc.
- In heavy traffic
- On roads with sharp bends
- On winding roads
- On slippery roads, such as those covered with rain, ice or snow
- On steep downhills, or where there are sudden changes between sharp up and down gradients
Vehicle speed may exceed the set speed when driving down a steep hill.
- At entrances to freeways and highways
- When weather conditions are bad enough that they may prevent the sensors from detecting correctly (fog, snow, sandstorm, heavy rain, etc.)
- When there is rain, snow, etc. on the front surface of the radar sensor or camera sensor
- In traffic conditions that require frequent repeated acceleration and deceleration
- When your vehicle is towing a trailer or during emergency towing
- When an approach warning buzzer is heard often

Driving in vehicle-to-vehicle distance control mode

This mode employs a radar sensor to detect the presence of vehicles up to approximately 320 ft. (100 m) ahead, determines the current vehicle-to-vehicle following distance, and operates to maintain a suitable following distance from the vehicle ahead.

Note that vehicle-to-vehicle distance will close in when traveling on long downhill slopes.

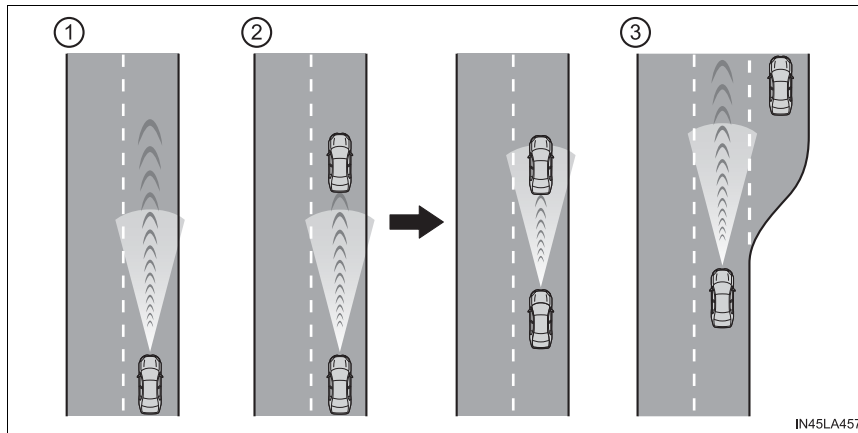

① Example of constant speed cruising

When there are no vehicles ahead

The vehicle travels at the speed set by the driver. The desired vehicle-to-vehicle distance can also be set by operating the vehicle-to-vehicle distance switch.

② Example of deceleration cruising and follow-up cruising

When a preceding vehicle driving slower than the set speed appears

When a vehicle is detected running ahead of you, the system automatically decelerates your vehicle. When a greater reduction in vehicle speed is necessary, the system applies the brakes (the stop lights will come on at this time). The system will respond to changes in the speed of the vehicle ahead in order to maintain the vehicle-to-vehicle distance set by the driver. Approach warning warns you when the system cannot decelerate sufficiently to prevent your vehicle from closing in on the vehicle ahead.

③ Example of acceleration

When there are no longer any preceding vehicles driving slower than the set speed

The system accelerates until the set speed is reached. The system then returns to constant speed cruising.

Setting the vehicle speed (vehicle-to-vehicle distance control mode)

- 1 Press the “ON-OFF” button to activate the cruise control.

Radar cruise control indicator will come on and a message will be displayed on the multi-information display.

Press the button again to deactivate the cruise control.

If the “ON-OFF” button is pressed and held for 1.5 seconds or more, the system turns on in constant speed control mode. (→P. 266)

- 2 Accelerate or decelerate, with accelerator pedal operation, to the desired vehicle speed (at or above approximately 30 mph [50 km/h]) and push the lever down to set the speed.

Cruise control “SET” indicator will come on.

The vehicle speed at the moment the lever is released becomes the set speed.

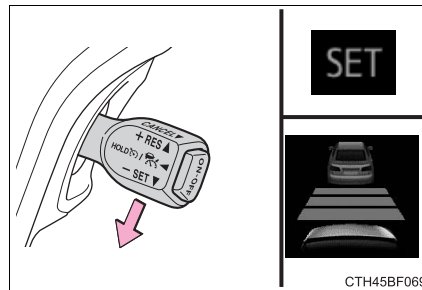
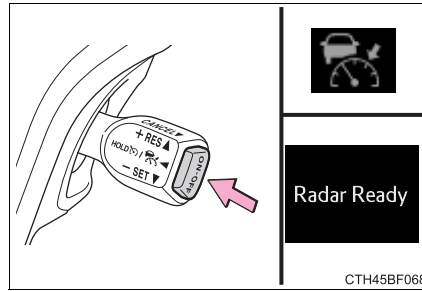

Adjusting the set speed

To change the set speed, operate the lever until the desired set speed is displayed.

- ① Increases the speed
- ② Decreases the speed

Fine adjustment: Momentarily move the lever in the desired direction.

Large adjustment: Hold the lever up or down to change the speed, and release when the desired speed is reached.

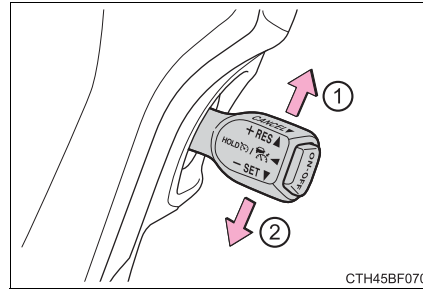

In the vehicle-to-vehicle distance control mode, the set speed will be increased or decreased as follows:

► For U.S. mainland and Hawaii

Fine adjustment: By 1 mph (1.6 km/h)^{*1} or 1 km/h (0.6 mph)^{*2} each time the lever is operated

Large adjustment: Increases or decreases in 1 mph (1.6 km/h)^{*1} or 1 km/h (0.6 mph)^{*2} increments for as long as the lever is held

► Except for U.S. mainland and Hawaii

Fine adjustment: By 1 mph (1.6 km/h)^{*1} or 1 km/h (0.6 mph)^{*2} each time the lever is operated

Large adjustment: Increases or decreases in 5 mph (8 km/h)^{*1} or 5 km/h (3.1 mph)^{*2} increments for as long as the lever is held

In the constant speed control mode (→P. 266), the set speed will be increased or decreased as follows:

Fine adjustment: By 1 mph (1.6 km/h)^{*1} or 1 km/h (0.6 mph)^{*2} each time the lever is operated

Large adjustment: The speed will continue to change while the lever is held.

*1: When the set speed is shown in "MPH"

*2: When the set speed is shown in "km/h"

Changing the vehicle-to-vehicle distance (vehicle-to-vehicle distance control mode)

Pressing the switch changes the vehicle-to-vehicle distance as follows:

- ① Long
- ② Medium
- ③ Short

The vehicle-to-vehicle distance is set automatically to long mode when the engine switch is turned to IGNITION ON mode.

If a vehicle is running ahead of you, the preceding vehicle mark will also be displayed.

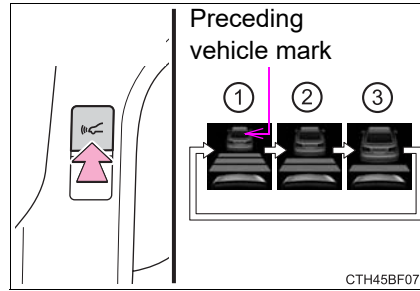

Vehicle-to-vehicle distance settings (vehicle-to-vehicle distance control mode)

Select a distance from the table below. Note that the distances shown correspond to a vehicle speed of 50 mph (80 km/h). Vehicle-to-vehicle distance increases/decreases in accordance with vehicle speed.

Distance options	Vehicle-to-vehicle distance
Long	Approximately 160 ft. (50 m)
Medium	Approximately 130 ft. (40 m)
Short	Approximately 100 ft. (30 m)

Canceling and resuming the speed control

- ① Pulling the lever toward you cancels the speed control.
The speed setting is also canceled when the brake pedal is depressed.
- ② Pushing the lever up resumes the cruise control and returns vehicle speed to the set speed.

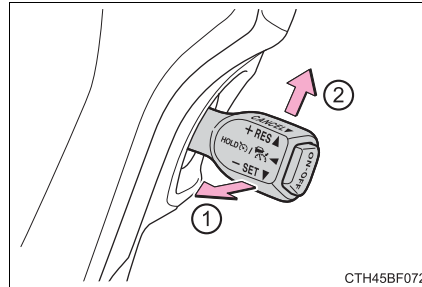

However, cruise control does not resume when the vehicle speed is approximately 25 mph (40 km/h) or less.

Approach warning (vehicle-to-vehicle distance control mode)

When your vehicle is too close to a vehicle ahead, and sufficient automatic deceleration via the cruise control is not possible, the display will flash and the buzzer will sound to alert the driver. An example of this would be if another driver cuts in front of you while you are following a vehicle. Depress the brake pedal to ensure an appropriate vehicle-to-vehicle distance.

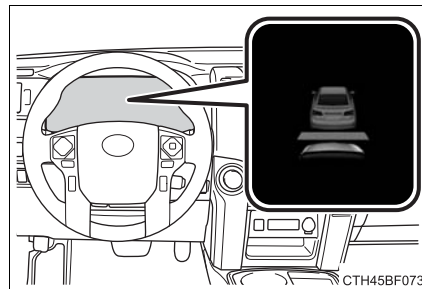

4

Driving

■ Warnings may not occur when

In the following instances, warnings may not occur even when the vehicle-to-vehicle distance is small.

- When the speed of the preceding vehicle matches or exceeds your vehicle speed
- When the preceding vehicle is traveling at an extremely slow speed
- Immediately after the cruise control speed was set
- When depressing the accelerator pedal

Selecting constant speed control mode

When constant speed control mode is selected, your vehicle will maintain a set speed without controlling the vehicle-to-vehicle distance. Select this mode only when vehicle-to-vehicle distance control mode does not function correctly due to a dirty radar sensor, etc.

- 1 With the cruise control off, press and hold the “ON-OFF” button for 1.5 seconds or more.

Immediately after the “ON-OFF” button is pressed, the radar cruise control indicator will come on. Afterwards, it switches to the cruise control indicator.

Switching to constant speed control mode is only possible when operating the lever with the cruise control off.

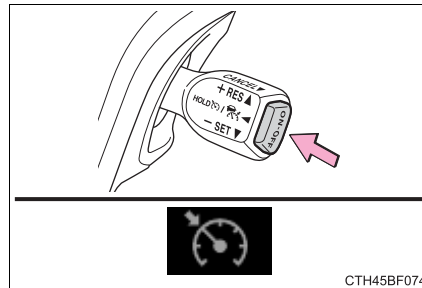

CTH45BF074

- 2 Accelerate or decelerate, with accelerator pedal operation, to the desired vehicle speed (at or above approximately 25 mph [40 km/h]) and push the lever down to set the speed.

Cruise control “SET” indicator will come on.

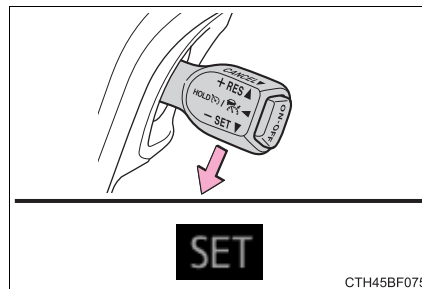

CTH45BF075

The vehicle speed at the moment the lever is released becomes the set speed.

Adjusting the speed setting: →P. 263

Canceling and resuming the speed setting: →P. 265

■ Dynamic radar cruise control can be set when

- The shift lever is in D or range 3 or higher of S has been selected.
- Vehicle speed is at or above approximately 30 mph (50 km/h).

■ Accelerating after setting the vehicle speed

The vehicle can accelerate by operating the accelerator pedal. After accelerating, the set speed resumes. However, during vehicle-to-vehicle distance control mode, the vehicle speed may decrease below the set speed in order to maintain the distance to the preceding vehicle.

■ Automatic cancelation of vehicle-to-vehicle distance control mode

Vehicle-to-vehicle distance control mode is automatically canceled in the following situations:

- Actual vehicle speed falls at or below approximately 25 mph (40 km/h).
- VSC is activated.
- TRAC is activated for a period of time.
- When the VSC or TRAC system is turned off.
- The sensor cannot detect correctly because it is covered in some way.
- Pre-collision braking is activated.

If vehicle-to-vehicle distance control mode is automatically canceled for any other reason, there may be a malfunction in the system. Contact your Toyota dealer.

■ Automatic cancelation of constant speed control mode

Constant speed control mode is automatically canceled in the following situations:

- Actual vehicle speed is more than approximately 10 mph (16 km/h) below the set vehicle speed.
- Actual vehicle speed falls below approximately 25 mph (40 km/h).
- VSC is activated.
- TRAC is activated for a period of time.
- When the VSC or TRAC system is turned off.
- Pre-collision braking is activated.

If constant speed control mode is automatically canceled for any other reason, there may be a malfunction in the system. Contact your Toyota dealer.

■ Brake system operation sound

If the brakes are applied automatically while the vehicle is in vehicle-to-vehicle distance control mode, a brake system operation sound may be heard. This does not indicate a malfunction.

■ Warning messages and buzzers for dynamic radar cruise control

Warning messages and buzzers are used to indicate a system malfunction or to inform the driver of the need for caution while driving. If a warning message is shown on the multi-information display, read the message and follow the instructions.

■ When the sensor may not be correctly detecting the vehicle ahead

In the case of the following and depending on the conditions, operate the brake pedal when deceleration of the system is insufficient or operate the accelerator pedal when acceleration is required.

As the sensor may not be able to correctly detect these types of vehicles, the approach warning (→P. 265) may not be activated.

- Vehicles that cut in suddenly
- Vehicles traveling at low speeds
- Vehicles that are not moving in the same lane
- Vehicles with small rear ends (trailers with no load on board, etc.)

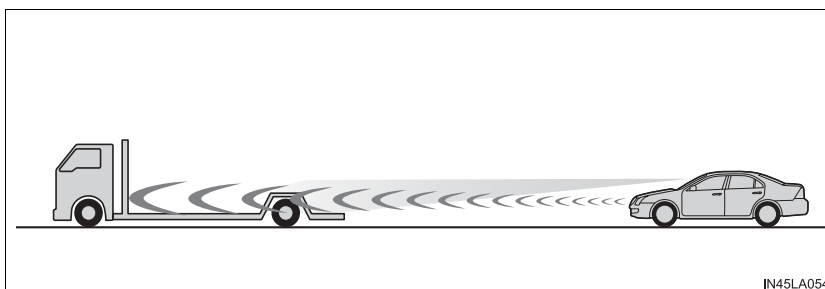

- Motorcycles traveling in the same lane

- When water or snow thrown up by the surrounding vehicles hinders the detecting of the sensor
- When your vehicle is pointing upwards (caused by a heavy load in the luggage compartment, etc.)

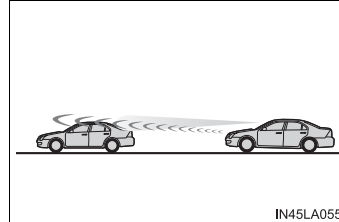

- Preceding vehicle has an extremely high ground clearance

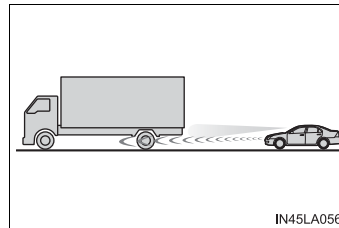

■ Conditions under which the vehicle-to-vehicle distance control mode may not function correctly

In the case of the following conditions, operate the brake pedal (or accelerator pedal, depending on the situation) as necessary.

As the sensor may not be able to correctly detect vehicles ahead, the system may not operate properly.

- When the road curves or when the lanes are narrow

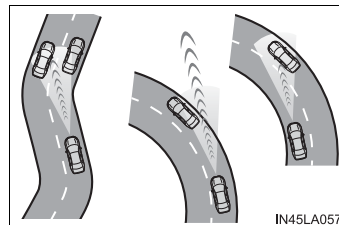

- When steering wheel operation or your position in the lane is unstable

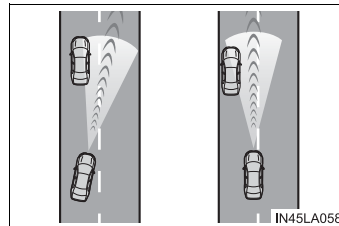

- When the vehicle ahead of you decelerates suddenly
- When driving on a road surrounded by a structure, such as in a tunnel or on a bridge
- While the vehicle speed is decreasing to the set speed after the vehicle accelerates by depressing the accelerator pedal

BSM (Blind Spot Monitor)

The **Blind Spot Monitor** is a system that uses rear side radar sensors installed on the inner side of the rear bumper on the left and right side to assist the driver in confirming safety when changing lanes.

System components

- ① Multi-information display
Turning the Blind Spot Monitor on/off.
- ② Outside rear view mirror indicators
When a vehicle is detected in a blind spot of the outside rear view mirrors or approaching rapidly from behind into a blind spot, the outside rear view mirror indicator on the detected side will illuminate. If the turn signal lever is operated toward the detected side, the outside rear view mirror indicator will flash.

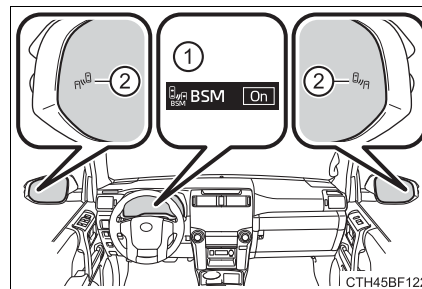

Turning the Blind Spot Monitor on/off

The Blind Spot Monitor can be enabled/disabled on  screen of the multi-information display. (→P. 95)

When the Blind Spot Monitor is disabled, the BSM OFF indicator (→P. 85) will come on. Each time the engine switch is turned to the off then changed to the IGNITION ON mode, the Blind Spot Monitor will be enabled automatically.

■ Outside rear view mirror indicator visibility

In strong sunlight, the outside rear view mirror indicator may be difficult to see.

■ When “BSM Unavailable See Owner’s Manual” is shown on the multi-information display

The sensor voltage has become abnormal, or water, snow, mud, etc., may be attached to the rear bumper around the sensors (→P. 272). Removing the water, snow, mud, etc., from the vicinity of the sensor area should return it to normal. Also, the sensor may not function normally when used in extremely hot or cold weather.

■ When “Blind Spot Monitor Malfunction Visit Your Dealer” is shown on the multi-information display

There may be a sensor malfunction or misaligned. Have the vehicle inspected by your Toyota dealer.

■ Customization

Some functions can be customized. (→P. 558)

⚠ WARNING**■ To ensure the system can operate properly**

Blind Spot Monitor sensors are installed behind the left and right sides of the rear bumper respectively. Observe the following to ensure the Blind Spot Monitor can function correctly.

- Keep the sensors and the surrounding areas on the rear bumper clean at all times.

If a sensor or its surrounding area on the rear bumper is dirty or covered with snow, the Blind Spot Monitor may not operate and a warning message (→P. 271) will be displayed. In this situation, clear off the dirt or snow and drive the vehicle with the operation conditions of the Blind Spot Monitor (→P. 275) satisfied for approximately 10 minutes. If the warning message does not disappear, have the vehicle inspected by your Toyota dealer.

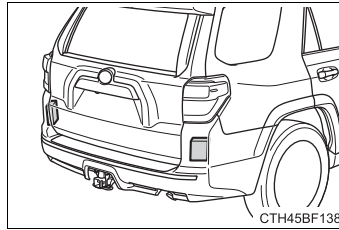

- Do not subject a sensor or its surrounding area on the rear bumper to a strong impact.
If a sensor is moved even slightly off position, the system may malfunction and vehicles may not be detected correctly. In the following situations, have your vehicle inspected by your Toyota dealer.
 - A sensor or its surrounding area is subject to a strong impact.
 - If the surrounding area of a sensor is scratched or dented, or part of them has become disconnected.
- Do not disassemble the sensor.
- Do not attach stickers or install accessories to the sensor or surrounding area on the rear bumper.
- If a sensor or the rear bumper needs to be removed/installed or replaced, contact any authorized Toyota retailer or Toyota authorized repairer, or any reliable repairer.
- Do not modify the sensor or surrounding area on the rear bumper.
- Do not paint the rear bumper any color other than an official Toyota color.

Blind Spot Monitor operation**■ Vehicles that can be detected by the Blind Spot Monitor**

The Blind Spot Monitor uses radar sensors to detect the following vehicles traveling in adjacent lanes and advises the driver of the presence of such vehicles via the indicators on the outside rear view mirrors.

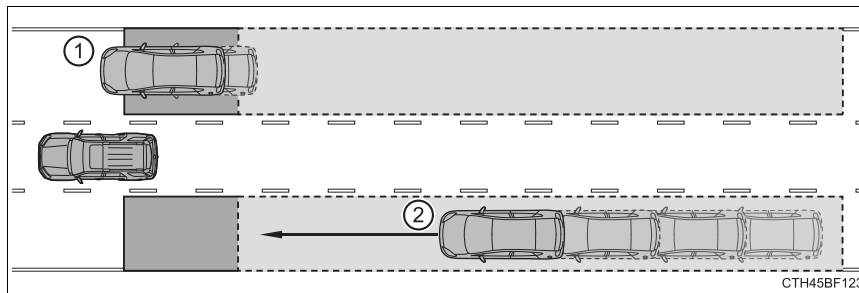

- ① Vehicles that are traveling in areas that are not visible using the outside rear view mirrors (the blind spots)
- ② Vehicles that are approaching rapidly from behind in areas that are not visible using the outside rear view mirrors (the blind spots)

■ **Blind Spot Monitor detection areas**

The areas that vehicles can be detected in are outlined below.

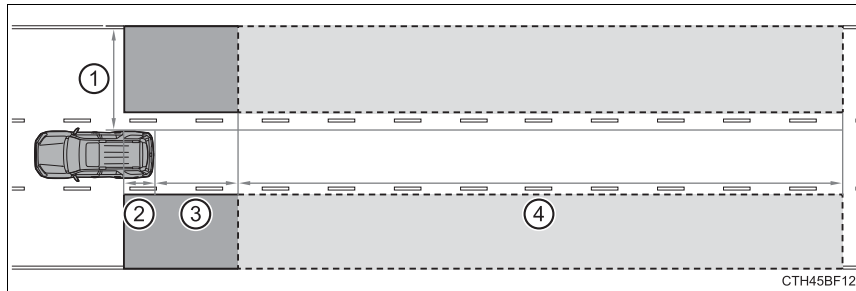

The range of each detection area is:

- ① Approximately 1.6 ft. (0.5 m) to 11.5 ft. (3.5 m) from either side of the vehicle*
- *: The area between the side of the vehicle and 1.6 ft. (0.5 m) from the side of the vehicle cannot be detected.
- ② Approximately 3.3 ft. (1 m) forward of the rear bumper
- ③ Approximately 9.8 ft. (3 m) from the rear bumper
- ④ Approximately 9.8 ft. (3 m) to 197 ft. (60 m) from the rear bumper*
- *: The greater the difference in speed between your vehicle and the detected vehicle is, the farther away the vehicle will be detected, causing the outside rear view mirror indicator to illuminate or flash.

⚠ WARNING

■ **Cautions regarding the use of the system**

The driver is solely responsible for safe driving. Always drive safely, taking care to observe your surroundings.

The Blind Spot Monitor is a supplementary function which alerts the driver that a vehicle is in a blind spot of the outside rear view mirrors or is approaching rapidly from behind into a blind spot. Do not overly rely on the Blind Spot Monitor.

As the function cannot judge if it is safe to change lanes, over reliance could lead to an accident resulting in death or serious injury. As the system may not function correctly under certain conditions, the driver's own visual confirmation of safety is necessary.

■ The Blind Spot Monitor is operational when

The Blind Spot Monitor is operational when all of the following conditions are met:

- The engine switch is in the IGNITION ON mode.
- The Blind Spot Monitor is on.
- The shift lever is in a position other than R.
- The vehicle speed is greater than approximately 10 mph (16 km/h).

■ The Blind Spot Monitor will detect a vehicle when

The Blind Spot Monitor will detect a vehicle present in the detection area in the following situations:

- A vehicle in an adjacent lane overtakes your vehicle.
- You overtake a vehicle in adjacent lane slowly.
- Another vehicle enters the detection area when it changes lanes.

■ Conditions under which the system will not detect a vehicle

The Blind Spot Monitor is not designed to detect the following types of vehicles and/or objects:

- Small motorcycles, bicycles, pedestrians, etc.*
- Vehicles traveling in the opposite direction
- Guardrails, walls, signs, parked vehicles and similar stationary objects*
- Following vehicles that are in the same lane*
- Vehicles traveling 2 lanes away from your vehicle*
- Vehicles which are being overtaken rapidly by your vehicle.*

*: Depending on the conditions, detection of a vehicle and/or object may occur.

■ Conditions under which the system may not function correctly

- The Blind Spot Monitor may not detect vehicles correctly in the following situations:
 - When the sensor is misaligned due to a strong impact to the sensor or its surrounding area
 - When mud, snow, ice, a sticker, etc. is covering the sensor or surrounding area on the rear bumper
 - When driving on a road surface that is wet with standing water during bad weather, such as heavy rain, snow, or fog
 - When multiple vehicles are approaching with only a small gap between each vehicle
 - When the distance between your vehicle and a following vehicle is short
 - When there is a significant difference in speed between your vehicle and the vehicle that enters the detection area
 - When the difference in speed between your vehicle and another vehicle is changing
 - When a vehicle enters a detection area traveling at about the same speed as your vehicle
 - As your vehicle starts from a stop, a vehicle remains in the detection area
 - When driving up and down consecutive steep inclines, such as hills, dips in the road, etc.
 - When driving on roads with sharp bends, consecutive curves, or uneven surfaces
 - When vehicle lanes are wide, or when driving on the edge of a lane, and the vehicle in an adjacent lane is far away from your vehicle
 - When an accessory (such as a bicycle carrier) or towing eyelet is installed to the rear of the vehicle
 - When there is a significant difference in height between your vehicle and the vehicle that enters the detection area
 - Immediately after the Blind Spot Monitor is turned on
- Instances of the Blind Spot Monitor unnecessarily detecting a vehicle and/or object may increase in the following situations:
 - When the sensor is misaligned due to a strong impact to the sensor or its surrounding area
 - When the distance between your vehicle and a guardrail, wall, etc. that enters the detection area is short
 - When driving up and down consecutive steep inclines, such as hills, dips in the road, etc.
 - When vehicle lanes are narrow, or when driving on the edge of a lane, and a vehicle traveling in a lane other than the adjacent lanes enters the detection area
 - When driving on roads with sharp bends, consecutive curves, or uneven surfaces
 - When the tires are slipping or spinning
 - When the distance between your vehicle and a following vehicle is short
 - When an accessory (such as a bicycle carrier) or towing eyelet is installed to the rear of the vehicle
 - When the vehicle throws up water or snow behind.

Intuitive parking assist*

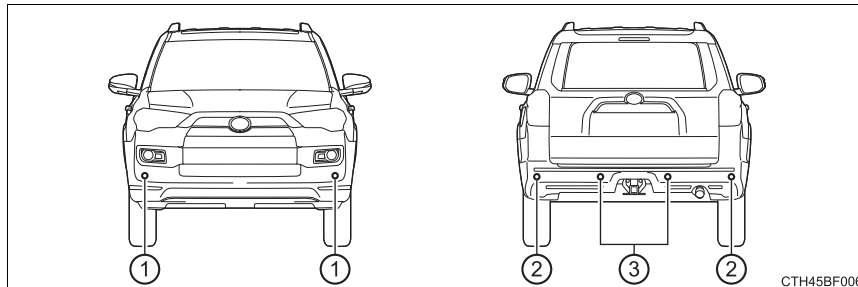

The distance from your vehicle to nearby obstacles when parallel parking or maneuvering into a garage is measured by the sensors and communicated via the multi-information display and a buzzer. Always check the surrounding area when using this system.

Types of sensors



- ① Front corner sensors
- ② Rear corner sensors
- ③ Rear center sensors

Turning the intuitive parking assist on/off

- 1 Press < / > of the meter control switches, select .
- 2 Press ^ / v of the meter control switches, select .
- 3 Press  of the meter control switch.

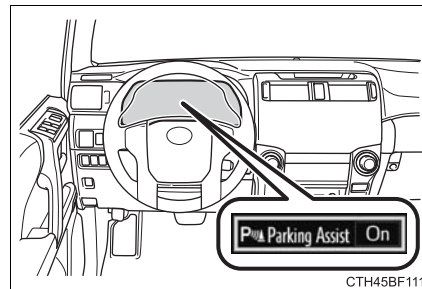

Each time  is pressed, the function changes on/off.

When on, the indicator light comes on to inform the driver that the system is operational.

*: If equipped

Display

■ Multi-information display



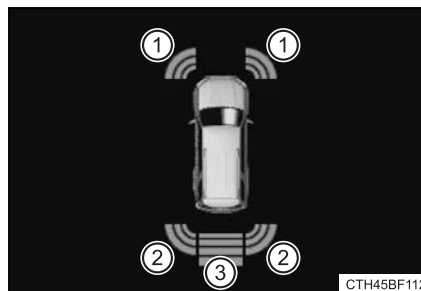

- ① Front corner sensor operation
- ② Rear corner sensor operation
- ③ Rear center sensor operation



Sensor detection display, obstacle distance

■ **Distance display**

Sensors that detect an obstacle will illuminate continuously or blink.

Multi-information display*		Approximate distance to obstacle	
		Rear center sensor	Front and rear corner sensor
 (continuous)	Far  Near	4.9 ft. (150 cm) to 2.0 ft. (60 cm)	—
 (continuous)		2.0 ft. (60 cm) to 1.5 ft. (45 cm)	2.0 ft. (60 cm) to 1.5 ft. (45 cm)
 (continuous)		1.5 ft. (45 cm) to 1.2 ft. (35 cm)	1.5 ft. (45 cm) to 1.2 ft. (35 cm)
 (blinking)		Less than 1.2 ft. (35 cm)	Less than 1.2 ft. (35 cm)

*: The images may differ from those shown in the illustrations. (→P. 278)

■ Buzzer operation and distance to an obstacle

A buzzer sounds when the sensors are operating.

- The buzzer sounds faster as the vehicle approaches an obstacle. When the vehicle comes within the following distance of the obstacle, the buzzer sounds continuously: Approximately 1.2 ft. (35 cm).
- When 2 or more obstacles are detected simultaneously, the buzzer system responds to the nearest obstacle. If one or both come within the above distances, the beep will repeat a long tone, followed by fast beeps.

Detection range of the sensors

- ① Approximately 2.0 ft. (60 cm)
- ② Approximately 4.9 ft. (150 cm)

The diagram shows the detection range of the sensors. Note that the sensors cannot detect obstacles that are extremely close to the vehicle.

The range of the sensors may change depending on the shape of the object etc.

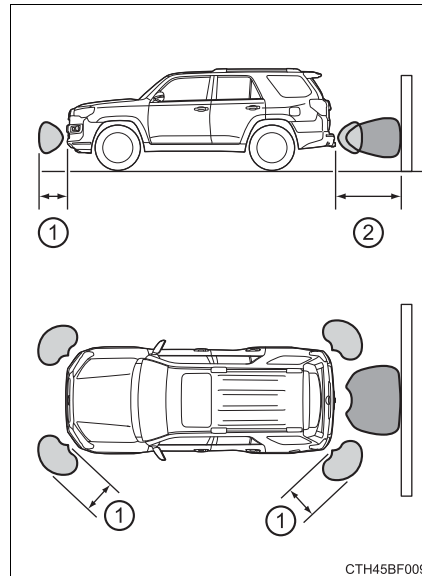

CTH45BF009

■ Intuitive parking assist can be operated when

- Front corner sensors:
 - The engine switch is in IGNITION ON mode.
 - The shift lever is in a position other than P.
 - The vehicle speed is less than approximately 6 mph (10 km/h).
- Rear corner and rear center sensors:
 - The engine switch is in IGNITION ON mode.
 - The shift lever is in R.

■ Intuitive parking assist display

When an obstacle is detected while the Toyota parking assist monitor is in use, the warning indicator will appear in the upper part of the screen even if the display setting has been set to off.

■ Sensor detection information

- The sensor's detection areas are limited to the areas around the vehicle's front corner and rear bumpers.
- The following situations may occur during use.
 - Depending on the shape of the obstacle and other factors, the detection distance may shorten, or detection may be impossible.
 - Obstacles may not be detected if they are too close to the sensor.
 - There will be a short delay between obstacle detection and display. Even at slow speeds, there is a possibility that the obstacle will come within the sensor's detection areas before the display is shown and the warning beep sounds.
 - Thin posts or objects lower than the sensor may not be detected for collision when approached, even if they have been detected once.
 - It might be difficult to hear beeps due to the volume of audio system or air flow noise of air conditioning system.

■ Objects which the system may not be properly detected

- Wires, fences, ropes, etc.
- Cotton, snow and other materials that absorb sound waves
- Sharply-angled objects
- Low obstacles
- Tall obstacles with upper sections projecting outwards in the direction of your vehicle

■ Situations in which the system may not operate properly

Certain vehicle conditions and the surrounding environment may affect the ability of a sensor to correctly detect objects. Particular instances where this may occur are listed below.

- There is dirt, snow, water drops or ice on a sensor. (Cleaning the sensors will resolve this problem.)
- A sensor is frozen. (Thawing the area will resolve this problem.)
In especially cold weather, if a sensor is frozen the sensor display may be displayed abnormally, or objects, such as a wall, may not be detected.
- When a sensor or the area around a sensor is extremely hot or cold.

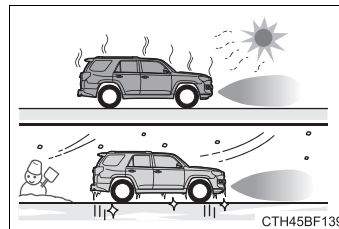

- On an extremely bumpy road, on an incline, on gravel, or on grass.
- When vehicle horns, vehicle detectors, motorcycle engines, air brakes of large vehicles, the clearance sonar of other vehicles or other devices which produce ultrasonic waves are near the vehicle
- A sensor is coated with a sheet of spray or heavy rain.
- If objects draw too close to the sensor.
- When a pedestrian is wearing clothing that does not reflect ultrasonic waves (ex. skirts with gathers or frills).
- When objects that are not perpendicular to the ground, not perpendicular to the vehicle traveling direction, uneven, or waving are in the detection range.
- Strong wind is blowing
- When driving in inclement weather such as fog, snow or a sandstorm
- When an object that cannot be detected is between the vehicle and a detected object
- If an object such as a vehicle, motorcycle, bicycle or pedestrian cuts in front of the vehicle or runs out from the side of the vehicle
- If the orientation of a sensor has been changed due to a collision or other impact
- When equipment that may obstruct a sensor is installed, such as a towing eyelet, bumper protector (an additional trim strip, etc.), bicycle carrier, or snow plow
- If the front of the vehicle is raised or lowered due to the carried load
- If the vehicle cannot be driven in a stable manner, such as when the vehicle has been in an accident or is malfunctioning
- When a tire chains, compact spare tire or an emergency tire puncture repair kit is used

■ Situations in which the system may operate even if there is no possibility of a collision

In some situations, such as the following, the system may operate even though there is no possibility of a collision.

- When driving on a narrow road

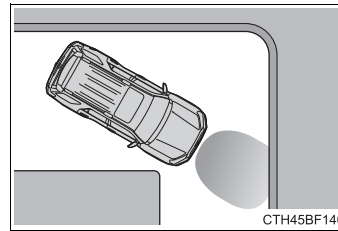

- When driving toward a banner, flag, low-hanging branch or boom barrier (such as those used at railroad crossings, toll gates and parking lots)
- When there is a rut or hole in the surface of the road
- When driving on a metal cover (grating), such as those used for drainage ditches
- When driving up or down a steep slope
- If a sensor is hit by a large amount of water, such as when driving on a flooded road
- There is dirt, snow, water drops or ice on a sensor. (Cleaning the sensors will resolve this problem.)
- A sensor is coated with a sheet of spray or heavy rain
- When driving in inclement weather such as fog, snow or a sandstorm
- When strong winds are blowing

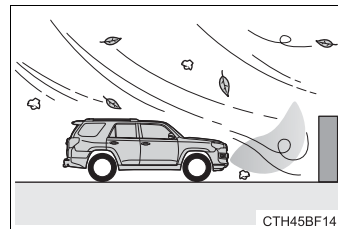

- When vehicle horns, vehicle detectors, motorcycle engines, air brakes of large vehicles, the clearance sonar of other vehicles or other devices which produce ultrasonic waves are near the vehicle
- If the front of the vehicle is raised or lowered due to the carried load
- If the orientation of a sensor has been changed due to a collision or other impact
- The vehicle is approaching a tall or curved curb
- Driving close to columns (H-shaped steel beams, etc.) in multi-story parking garages, construction sites, etc.
- If the vehicle cannot be driven in a stable manner, such as when the vehicle has been in an accident or is malfunctioning

- On an extremely bumpy road, on an incline, on gravel, or on grass



- When a tire chains, compact spare tire or an emergency tire puncture repair kit is used

■ **When the system malfunctions**

- If “Clean park sonar” is shown
A sensor may be dirty or covered with snow or ice. In such cases, if it is removed from the sensor, the system should return to normal. Also, due to the sensor being frozen at low temperatures, a malfunction display may appear or an obstacle may not be detected. If the sensor thaws out, the system should return to normal.
- If “Check park sonar system” is shown
Depending on the malfunction of the sensor, the device may not be working normally. Have the vehicle inspected by your Toyota dealer.

■ **Customization that can be configured at Toyota dealer**

Some functions can be customized. (Customizable features →P. 549)

■ **Certification**

- ▶ For vehicles sold in the U.S.A.

This device complies with Part 15 of the FCC Rules. Operation is subject to the following two conditions; (1) This device may not cause harmful interference, and (2) This device must accept any interference received, including interference that may cause undesired operation.

- ▶ For vehicles sold in Canada

This ISM device complies with Canadian ICES-001.
Cet appareil ISM est conforme a la norme NMB-001 du Canada.

⚠ WARNING**■ Cautions regarding the use of the system**

There is a limit to the degree of recognition accuracy and control performance that this system can provide, do not overly rely on this system. The driver is always responsible for paying attention to the vehicle's surroundings and driving safely.

■ To ensure the system can operate properly

Observe the following precautions.

Failing to do so may result in the vehicle being unable to be driven safely and possibly cause an accident.

- Do not damage the sensors, and always keep them clean.
- Do not attach a sticker or install an electronic component, such as a backlit license plate (especially fluorescent type), fog lights, fender pole or wireless antenna near a radar sensor.
- Do not subject the surrounding area of the sensor to a strong impact. If subjected to an impact, have the vehicle inspected by your Toyota dealer. If the front or rear bumper needs to be removed/installed or replaced, contact your Toyota dealer.
- Do not modify, disassemble or paint the sensors.
- Do not attach a license plate cover.
- Keep your tires properly inflated.

■ When to disable the function

In the following situations, disable the function as it may operate even though there is no possibility of a collision.

- Failing to observe the warnings above.
- A non-genuine Toyota suspension (lowered suspension, etc.) is installed.

■ Notes when washing the vehicle

Do not apply intensive bursts of water or steam to the sensor area.

Doing so may result in the sensor malfunctioning.

- When using a high pressure washer to wash the vehicle, do not spray the sensors directly, as doing so may cause a sensor to malfunction.
- When using steam to clean the vehicle, do not direct steam too close to the sensors as doing so may cause a sensor to malfunction.

RCTA (Rear Cross Traffic Alert)

The RCTA function uses the BSM radar sensors installed on the inner side of the rear bumper. This function is intended to assist the driver in checking areas that are not easily visible when backing up.

System components

① Multi-information display

Turning the RCTA function on/off.

② Outside rear view mirror indicators

When a vehicle approaching from the right or left at the rear of the vehicle is detected, both outside rear view mirror indicators will flash.

③ Navigation system screen

If a vehicle approaching from the right or left at the rear of the vehicle is detected, the RCTA icon (→P. 288) for the detected side will be displayed.

④ RCTA buzzer

If a vehicle approaching from the right or left at the rear of the vehicle is detected, a buzzer will sound.

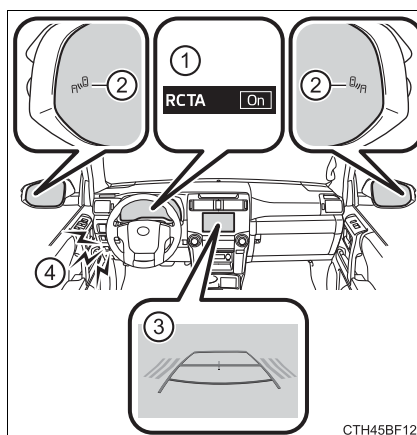

Turning the RCTA function on/off

The RCTA function can be enabled/disabled on  screen of the multi-information display. (→P. 95)

When the RCTA function is disabled, the “RCTA OFF” indicator will come on. Each time the engine switch is turned off then changed to the IGNITION ON mode, the RCTA function will be enabled automatically.

■ Outside rear view mirror indicator visibility

In strong sunlight, the outside rear view mirror indicator may be difficult to see.

■ Hearing the RCTA buzzer

The RCTA buzzer may be difficult to hear over loud noises, such as if the audio system volume is high.

■ When “RCTA Unavailable” is shown on the multi-information display

Water, snow, mud, etc., may be attached to the rear bumper around the sensors (→P. 272). Removing the water, snow, mud, etc., from the vicinity of the sensor area should return it to normal. Also, the sensor may not function normally when used in extremely hot or cold weather.

■ When “RCTA Malfunction Visit Your Dealer” is shown on the multi-information display

There may be a sensor malfunction or misaligned. Have the vehicle inspected by your Toyota dealer.

■ Radar sensors

→P. 272

■ Customization

Some functions can be customized. (→P. 558)

RCTA function

■ Operation of the RCTA function

The RCTA function uses radar sensors to detect vehicles approaching from the right or left at the rear of the vehicle and alerts the driver of the presence of such vehicles by flashing the outside rear view mirror indicators and sounding a buzzer.

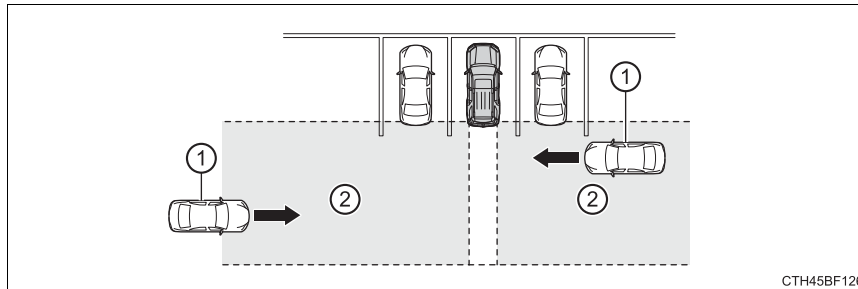

CTH45BF126

- ① Approaching vehicles
- ② Detection areas of approaching vehicles

■ RCTA icon display

When a vehicle approaching from the right or left at the rear of the vehicle is detected, the following will be displayed on the navigation system screen.

Example: Vehicles are approaching from both sides of the vehicle.

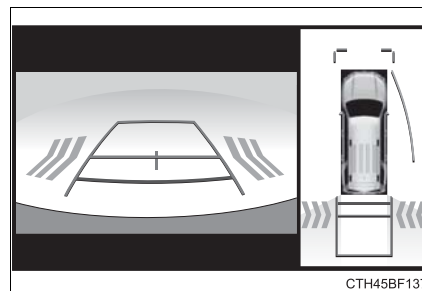

CTH45BF137

■ RCTA function detection areas

The areas that vehicles can be detected in are outlined below.

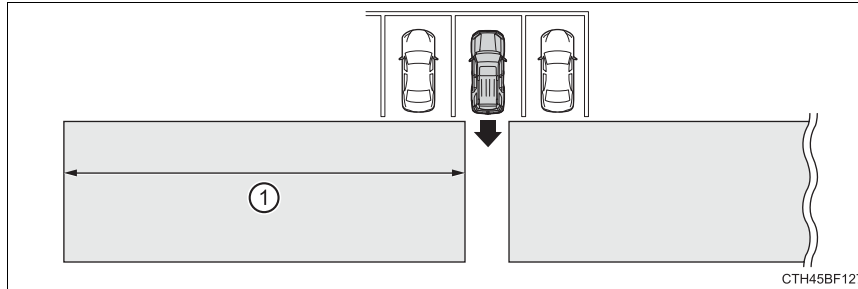

CTH45BF127

The buzzer can alert the driver of faster vehicles approaching from farther away.

Example:

Approaching vehicle	Speed	① Approximate alert distance
Fast	35 mph (56 km/h)	130 ft (40 m)
Slow	5 mph (8 km/h)	18 ft (5.5 m)

⚠ WARNING

■ Cautions regarding the use of the system

There is a limit to the degree of recognition accuracy and control performance that this system can provide, do not overly rely on this system. The driver is always responsible for paying attention to the vehicle's surroundings and driving safely. (→P. 274)

■ To ensure the system can operate properly

→P. 272

■ The RCTA function is operational when

The RCTA function operates when all of the following conditions are met:

- The engine switch is in the IGNITION ON mode.
- The RCTA function is on.
- The shift lever is in R.
- The vehicle speed is less than approximately 9 mph (15 km/h).
- The approaching vehicle speed is between approximately 5 mph (8 km/h) and 35 mph (56 km/h).

■ Muting a buzzer temporarily

A mute button will be displayed on the multi-information display when a vehicle or an object is detected. To mute the buzzer, press. The buzzers for the RCTA function and Toyota parking assist-sensor will be muted simultaneously.

Mute will be automatically canceled in the following situations:

- When the shift position is changed.
- When there is a malfunction in a sensor or the system is temporarily unavailable.
- When the function is disabled while it is operating.
- The engine switch is turned off.

■ Conditions under which the system will not detect a vehicle

The RCTA function is not designed to detect the following types of vehicles and/or objects:

- Vehicles approaching from directly behind
- Vehicles backing up in a parking space next to your vehicle
- Vehicles that the sensors cannot detect due to obstructions

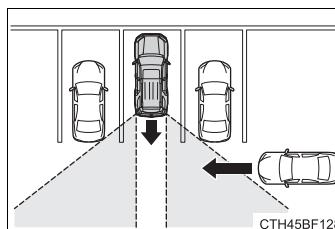

- Guardrails, walls, signs, parked vehicles and similar stationary objects*
- Small motorcycles, bicycles, pedestrians, etc.*
- Vehicles moving away from your vehicle
- Vehicles approaching from the parking spaces next to your vehicle*
- The distance between the sensor and approaching vehicle gets too close

*: Depending on the conditions, detection of a vehicle and/or object may occur.

■ Situations in which the system may not operate properly

The RCTA function may not detect vehicles correctly in the following situations:

- When the sensor is misaligned due to a strong impact to the sensor or its surrounding area
- When mud, snow, ice, a sticker, etc., is covering the sensor or surrounding area on the rear bumper
- When driving on a road surface that is wet with standing water during bad weather, such as heavy rain, snow, or fog
- When multiple vehicles are approaching with only a small gap between each vehicle
- When a vehicle is approaching at high speed
- When equipment that may obstruct a sensor is installed, such as a towing eyelet, bumper protector (an additional trim strip, etc.), bicycle carrier, or snow plow
- When backing up on a slope with a sharp change in grade

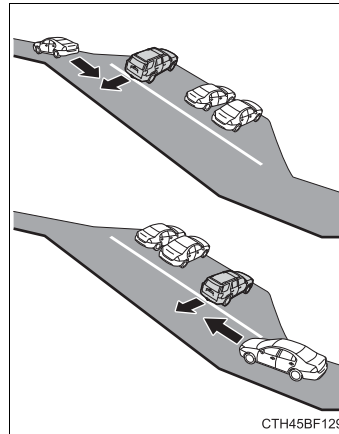

- When backing out of a sharp angle parking spot

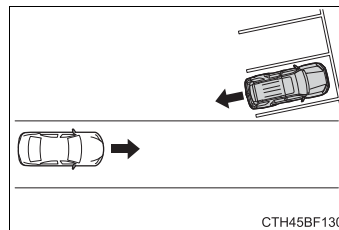

- When towing a trailer
- When there is a significant difference in height between your vehicle and the vehicle that enters the detection area
- When a sensor or the area around a sensor is extremely hot or cold
- If the suspension has been modified or tires of a size other than specified are installed
- If the front of the vehicle is raised or lowered due to the carried load

- When turning while backing up

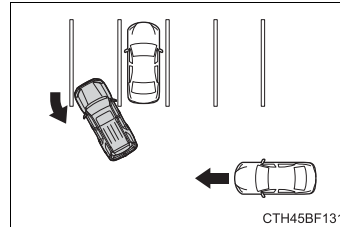

- When a vehicle turns into the detection area

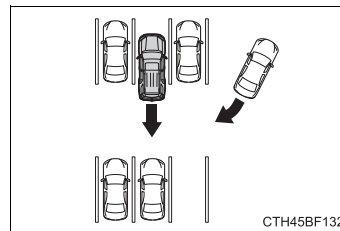

■ Situations in which the system may operate even if there is no possibility of a collision

Instances of the RCTA function unnecessarily detecting a vehicle and/or object may increase in the following situations:

- When the parking space faces a street and vehicles are being driven on the street

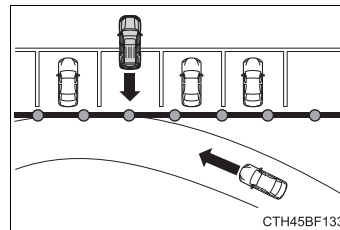

- When the distance between your vehicle and metal objects, such as a guardrail, wall, sign, or parked vehicle, which may reflect electrical waves toward the rear of the vehicle, is short

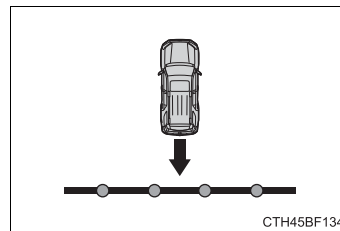

- When equipment that may obstruct a sensor is installed, such as a towing eyelet, bumper protector (an additional trim strip, etc.), bicycle carrier, or snow plow

- When a vehicle passes by the side of your vehicle

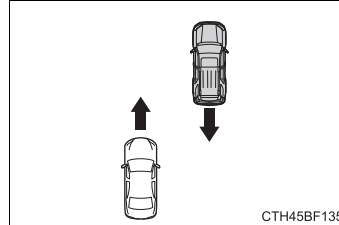

- When a detected vehicle turns while approaching the vehicle

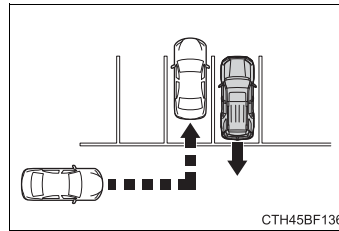

- When there are spinning objects near your vehicle such as the fan of an air conditioning unit
- When water is splashed or sprayed toward the rear bumper, such as from a sprinkler
- Moving objects (flags, exhaust fumes, large rain droplets or snowflakes, rain water on the road surface, etc.)
- When the distance between your vehicle and a guardrail, wall, etc., that enters the detection area is short
- Gratings and gutters
- When a sensor or the area around a sensor is extremely hot or cold
- If the suspension has been modified or tires of a size other than specified are installed
- If the front of the vehicle is raised or lowered due to the carried load

Four-wheel drive system (part-time 4WD models)

Use the front-wheel drive control lever or switch to select the following transfer modes:

► Type A

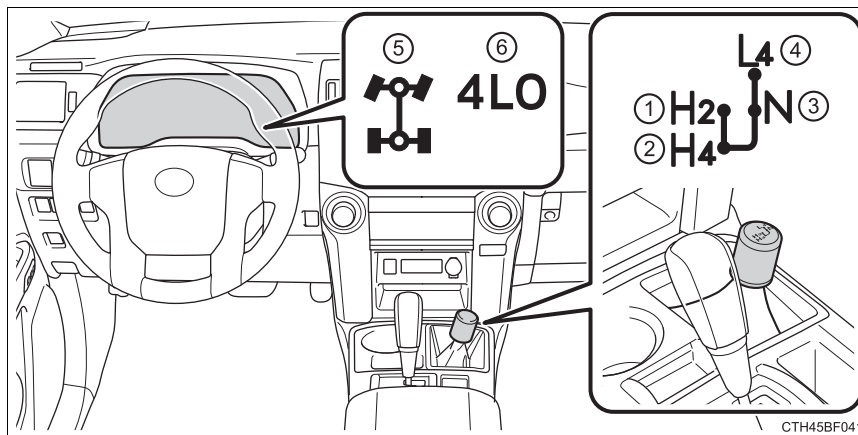

The four-wheel drive indicator comes on when H4, N or L4 mode is selected.

- ① H2 (high speed position, two-wheel drive)
Use this for normal driving on dry hard-surfaced roads. This position gives greater economy, quietest ride and least wear.
- ② H4 (high speed position, four-wheel drive)
Use this for driving only on tracks that permit the tires slide, like off-road, icy or snow-covered roads. This position provides greater traction than two-wheel drive.
- ③ N (neutral position)
No power is delivered to the wheels. The vehicle must be stopped.
- ④ L4 (low speed position, four-wheel drive)
Use this for maximum power and traction. Use "L4" for climbing or descending steep hills, off-road driving, and hard pulling in sand, mud or deep snow.
- ⑤ Four-wheel drive indicator
- ⑥ Low speed four-wheel drive indicator

► Type B

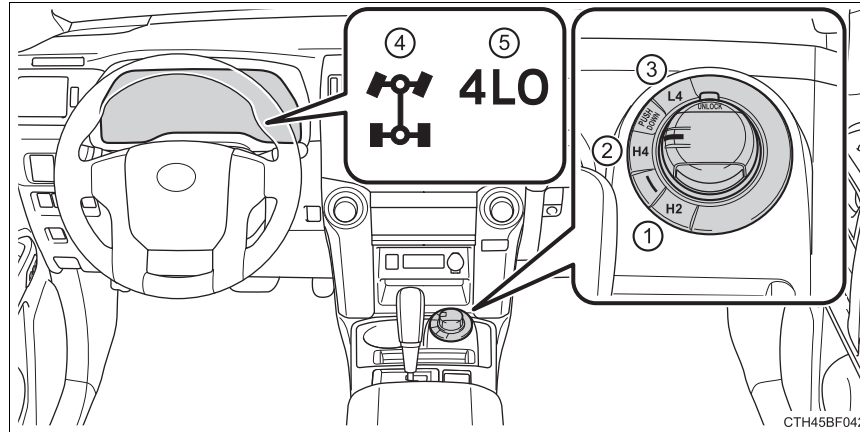

The four-wheel drive indicator comes on when H4 or L4 mode is selected.

- ① H2 (high speed position, two-wheel drive)
Use this for normal driving on dry hard-surfaced roads. This position gives greater economy, quietest ride and least wear.
- ② H4 (high speed position, four-wheel drive)
Use this for driving only on tracks that permit the tires slide, like off-road, icy or snow-covered roads. This position provides greater traction than two-wheel drive.
- ③ L4 (low speed position, four-wheel drive)
Use this for maximum power and traction. Use "L4" for climbing or descending steep hills, off-road driving, and hard pulling in sand, mud or deep snow.
- ④ Four-wheel drive indicator
- ⑤ Low speed four-wheel drive indicator

Shifting between H2 and H4

■ Shifting from H2 to H4

▶ Type A

- 1 Reduce vehicle speed to less than 50 mph (80 km/h).
- 2 Shift the front-wheel drive control lever to H4.

▶ Type B

- 1 Reduce vehicle speed to less than 62 mph (100 km/h).
- 2 Push the “UNLOCK” button and turn the front-wheel drive control switch to H4.

The four-wheel drive indicator will turn on.

■ Shifting from H4 to H2

▶ Type A

Shift the front-wheel drive control lever to H2.

▶ Type B

Push the “UNLOCK” button and turn the front-wheel drive control switch to H2.

This can be done at any speed.

The four-wheel drive indicator will go off.

Shifting between H4 and L4

■ Shifting from H4 to L4

- 1 Stop the vehicle completely and continue to depress the brake pedal.
- 2 Shift the shift lever to N.
 - ▶ Type A
- 3 Shift the front-wheel drive control lever to L4.
 - ▶ Type B
- 3 Push the “UNLOCK” button and then push and turn the front-wheel drive control switch to L4.

The low speed four-wheel drive indicator will turn on.

■ Shifting from L4 to H4

- 1 Stop the vehicle completely and continue to depress the brake pedal.
- 2 Shift the shift lever to N.
 - ▶ Type A
- 3 Shift the front-wheel drive control lever to H4.
 - ▶ Type B
- 3 Push the “UNLOCK” button and turn the front-wheel drive control switch to H4.

The low speed four-wheel drive indicator will go off.

■ When the front-wheel drive control lever or switch is shifted to L4

VSC and TRAC are automatically turned off.

■ If the four-wheel drive indicator flashes

The transfer mode may not successfully change. Drive straight ahead while accelerating or decelerating, or drive in reverse.

■ If the low speed four-wheel drive indicator continues to flash

The transfer mode may not successfully change. Operate the four-wheel drive control switch again.

■ If the low speed four-wheel drive indicator continues to flash and a buzzer sounds

The shift lever is not in N and/or the vehicle is moving. Stop the vehicle completely, shift the shift lever to N and make sure that the indicator stops flashing.

■ If the four-wheel drive or low speed four-wheel drive indicator flashes rapidly

There may be a malfunction in the four-wheel drive system. Have the vehicle inspected by your Toyota dealer immediately.

■ Four-wheel drive usage frequency

You should drive in four-wheel drive for at least 10 miles (16 km) each month. This will assure that the front drive components are lubricated.

WARNING

■ Shifting the front-wheel drive control lever or switch from H2 to H4 while driving

Never operate the front-wheel drive control lever or switch if the wheels are slipping. Stop the slipping or spinning before shifting.

Four-wheel drive system (full-time 4WD models)

Use the four-wheel drive control switch to select the following transfer modes:

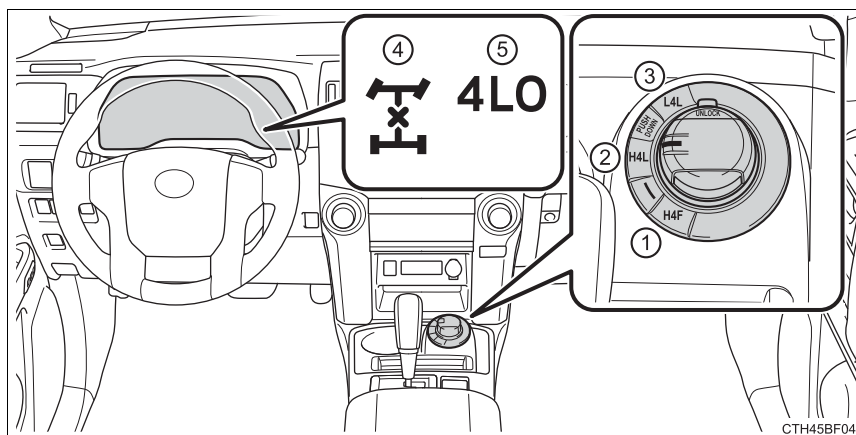

① H4F (high speed position)

Use this for normal driving on dry hard-surfaced roads. This position gives greater economy, quietest ride and least wear.

② H4L (high speed position, center differential locked)

Use this for driving only on tracks that permit the tires slide, like off-road, icy or snow-covered roads.

③ L4L (low speed position, center differential locked)

Use this for maximum power and traction. Use "L4L" for climbing or descending steep hills, off-road driving, and hard pulling in sand, mud or deep snow.

④ Center differential lock indicator

⑤ Low speed four-wheel drive indicator

Shifting between H4F and H4L

Push the “UNLOCK” button and turn the four-wheel drive control switch to H4L or H4F.

This can be done at any speed.

The center differential lock indicator will turn on (H4L) or go off (H4F).

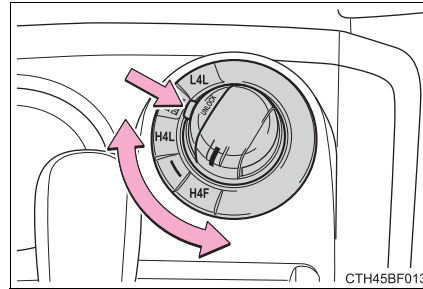

Shifting between H4L and L4L

■ Shifting from H4L to L4L

- 1 Stop the vehicle completely and continue to depress the brake pedal.
- 2 Shift the shift lever to N.
- 3 Push the “UNLOCK” button and then push and turn the four-wheel drive control switch to L4L.

Maintain this condition until the low speed four-wheel drive indicator turns on.

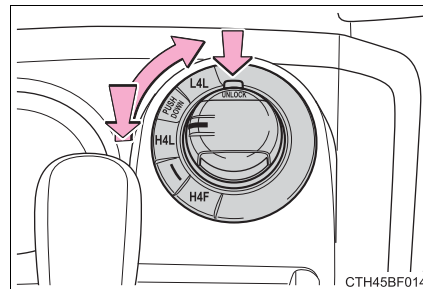

■ **Shifting from L4L to H4L**

- 1 Stop the vehicle completely and continue to depress the brake pedal.
- 2 Shift the shift lever to N.
- 3 Push the “UNLOCK” button and turn the four-wheel drive control switch to H4L.
Maintain this condition until the low speed four-wheel drive indicator goes off.

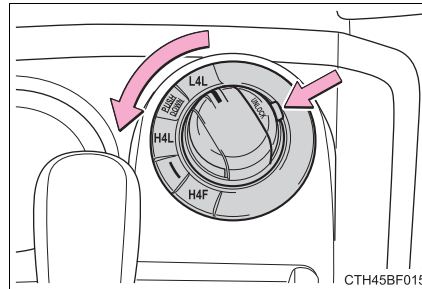

■ **The four-wheel drive control switch can be operated when**

The engine switch is in IGNITION ON mode.

■ **When the four-wheel drive control switch is turned to L4L**

VSC and TRAC are automatically turned off.

■ **If the center differential lock indicator flashes**

Locking or unlocking of the center differential is not complete. Drive straight ahead while accelerating or decelerating, or drive in reverse.

■ **If the center differential lock indicator flashes and a buzzer sounds**

Locking of the center differential is not complete. Stop the wheels from slipping or spinning and, if the indicator still flashes, operate the four-wheel drive control switch again.

■ **If the low speed four-wheel drive indicator continues to flash**

The transfer mode may not successfully change. Operate the four-wheel drive control switch again.

■ If the low speed four-wheel drive indicator continues to flash and a buzzer sounds

The shift lever is not in N and/or the vehicle is moving. Stop the vehicle completely, shift the shift lever to N and make sure that the indicator stops flashing.

■ If the low speed four-wheel drive indicator or the center differential lock indicator flashes rapidly

There may be a malfunction in the four-wheel drive system. Have the vehicle inspected by your Toyota dealer immediately.

 **WARNING****■ Operating the four-wheel drive control switch**

Never operate the four-wheel drive control switch if the wheels have lost traction. Doing so may cause an accident resulting in death or serious injury.

Stop the wheels from slipping or spinning before operating the switch.

 **NOTICE****■ To prevent damage to the center differential**

- For normal driving on dry and hard surface roads, unlock the center differential.
- Unlock the center differential after the wheels are out of the ditch or off the slippery or bumpy surface.
- Do not lock or unlock the center differential when the vehicle is turning or when its wheels are spinning freely off the ground.

Active traction control system*

The active traction control system automatically helps prevent the spinning of 4 wheels when the vehicle is started or accelerated on slippery road surfaces.

■ System operation

- 1 Part-time 4WD models:

Stop the vehicle, shift the shift lever to N and shift the front-wheel drive control lever into L4.

Full-time 4WD models:

Stop the vehicle, shift the shift lever to N and then push and turn the four-wheel drive control switch to L4L.

- 2 Press the “A-TRAC” switch to activate the system.

At this time, the “A-TRAC” indicator will come on.

To cancel the system, push the switch again.

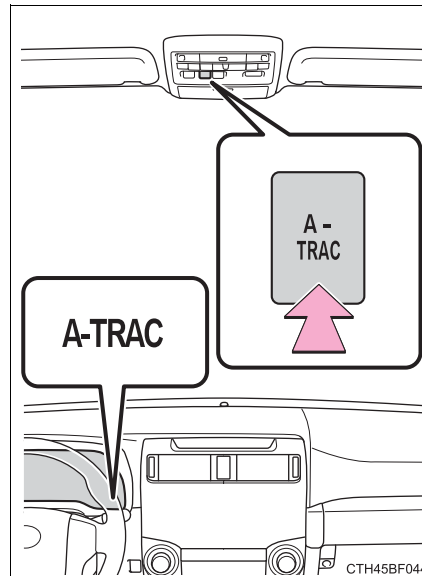

*: If equipped

When the active traction control system is operating

If all wheels spin, the slip indicator flashes to indicate that the active traction control system has been engaged.

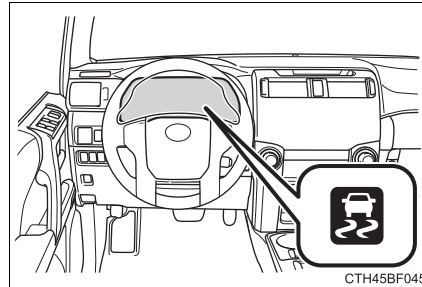

When the rear differential is locked (vehicles with a rear differential lock system)

The active traction control system is activated only when vehicle speed is less than 4 mph (6 km/h).

Sounds and vibrations caused by the active traction control system

- A sound may be heard from the engine compartment when the engine is started or just after the vehicle begins to move. This sound does not indicate that a malfunction has occurred in the system.
- Vibrations may be felt through the vehicle body and steering. This may occur when the system is operating.

If the brake system overheats

The system will cease operation and a buzzer will sound to alert the driver. At this time, the "A-TRAC" indicator will go off and the "TRAC OFF" indicator will come on. Stop the vehicle in a safe place. (There is no problem with continuing normal driving.)

The system will be automatically restored after a short time.

WARNING

■ The active traction control system may not operate effectively when

Directional control and power may not be achievable while driving on slippery road surfaces, even if the active traction control system is operating. Do not drive the vehicle in conditions where stability and power may be lost.

AUTO LSD system (2WD models)

The AUTO LSD system aids traction by using the traction control system to control engine performance and braking when one of the drive wheels begins to spin.

The system should be used only when one of the drive wheels spinning occurs in a ditch or rough surface.

System operation

The system can be used on 2WD models.

Press  to turn on the system.

At this time, the “AUTO LSD” and VSC OFF indicators will come on.

To turn off the system, press  again.

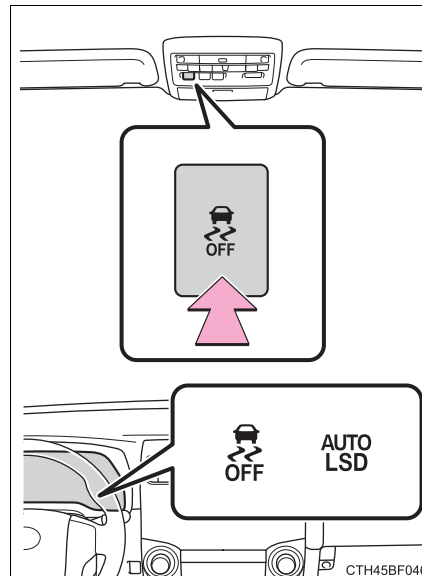

When the AUTO LSD system is operating

If the drive wheels spin, the slip indicator flashes to indicate that the AUTO LSD system has controlled the spinning of the drive wheels.

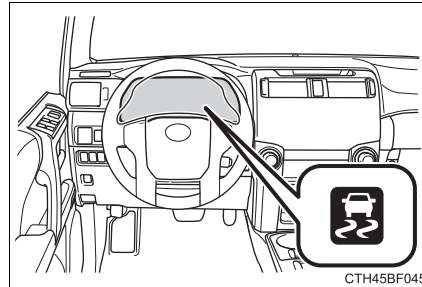

■ If the engine is turned off and restarted

The AUTO LSD system and the indicators are automatically turned off.

■ Reactivation of the VSC system linked to vehicle speed

When the AUTO LSD system is turned on, the VSC, TRAC and Trailer Sway Control systems will turn on automatically if vehicle speed increase.

■ If the brake system overheats

The system will cease operation and a buzzer will alert the driver. At this time, the "AUTO LSD" indicator will flash and the "TRAC OFF" indicator will come on. Stop the vehicle in a safe place. (There is no problem with continuing normal driving.) The system will be automatically restored after a short time.

⚠ WARNING

■ To avoid an accident

Failure to do so, a much greater steering effort and more careful cornering control will be required.

- Do not use the AUTO LSD system in conditions other than when one of the drive wheels spinning occurs in a ditch or rough surface.
- Do not drive with the AUTO LSD system continuously turned on.

⚠ NOTICE

■ Activating while driving

Do not activate the AUTO LSD system if the wheel is slipping. Stop the slipping or spinning before activating.

Rear differential lock system*

The rear differential lock system is provided for use only when wheel spinning occurs in a ditch or on a slippery or rugged surface.

The rear differential lock system is effective in case one of the rear wheels is spinning.

Press the switch to lock the rear differential.

At this time, the rear differential lock indicator will flash. Wait a few seconds for the system to complete operation. After the rear differential is locked, the indicator will stop flashing and remain on.

To unlock the rear differential, press the switch again.

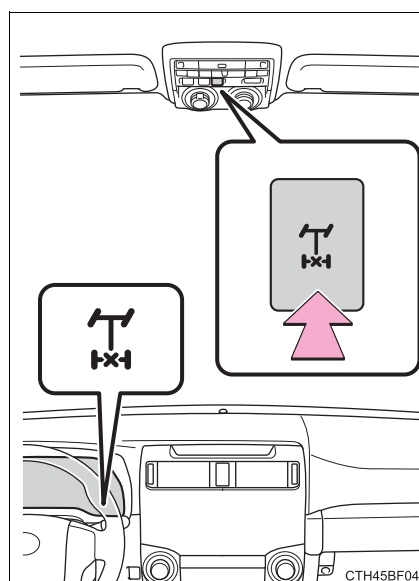

*: If equipped

Using the rear differential lock system

- 1 Before using the rear differential lock system:
Stop the vehicle, shift the shift lever to N and shift the front-wheel drive control lever into L4 to see if this is sufficient. If this has no effect, additionally use the rear differential lock system.
- 2 Be sure the wheels have stopped spinning.
- 3 Press the rear differential lock switch.
- 4 Gently depress the accelerator pedal.

After the rear differential is locked, the indicator will come on.
Unlock the rear differential as soon as the vehicle moves.
To unlock the rear differential, press the switch again.

Locking the rear differential

The following systems do not operate when the rear differential is locked. It is normal operation for the ABS warning light and VSC OFF indicator to be on at this time.

- ABS
- Multi Terrain ABS
- Brake assist system
- VSC
- Hill-start assist control

The rear differential lock is disengaged when

The front-wheel drive control lever or switch is shifted to H2 or H4.
Never forget to turn off the switch after using this feature.

After unlocking the rear differential

Check that the indicator goes off.

If the rear differential lock indicator flashes rapidly

There may be a malfunction in the rear differential lock system. Have the vehicle inspected by your Toyota dealer immediately.

 **WARNING****■ To avoid an accident**

- Do not use the rear differential lock system except when wheel spinning occurs in a ditch or on a slippery or rugged surface. Large steering effort and careful cornering control will be required.
- Do not lock the rear differential until the wheels have stopped spinning. Otherwise, the vehicle may move in an unexpected direction when the differential lock is engaged, resulting in an accident. This may also lead to possible damage to rear differential lock component parts.
- Do not drive over 5 mph (8 km/h) when the rear differential is locked.
- Do not keep driving with the rear differential lock switch on.

Downhill assist control system*

The downhill assist control system helps to prevent excessive speed on steep downhill slopes. The system will operate when the vehicle is traveling under 15 mph (25 km/h) with the accelerator and brake pedals released and the transfer mode is in L4 (part-time 4WD models) or L4L (full-time 4WD models).

System operation

Press the “DAC” switch.

The downhill assist control system indicator will come on and the system will operate. When the system is in operation, the slip indicator will flash, and the stop lights/high mounted stop lights will be lit. A sound may also occur during the operation. This does not indicate a malfunction.

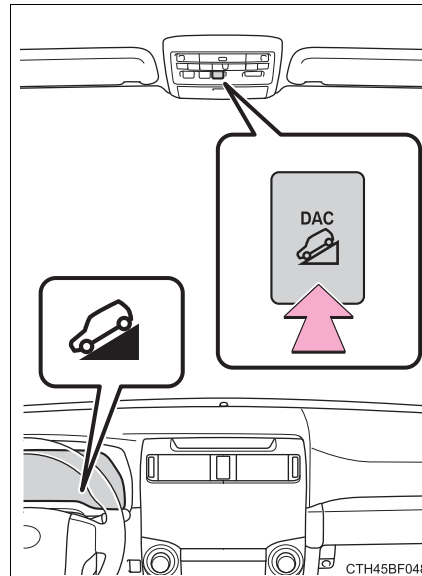

4

Driving

Turning off the system

Press the “DAC” switch while the system is in operation. The downhill assist control system indicator will flash as the system gradually ceases operation, and will turn off when the system is fully off. Press the “DAC” switch while the downhill assist control system indicator is flashing to start the system again.

*: If equipped

■ Operating tips

The system will operate when the shift lever is in a position other than P, however to make effective use of the system it is recommended to select a lower shift range.

■ The system will not operate when

- Part-time 4WD models: The transfer mode is in H2 or H4.
- Full-time 4WD models: The transfer mode is in H4L or H4F.

■ If the downhill assist control system indicator flashes

- In the following situations, the indicator flashes and the system will not operate:
 - The transfer mode is not in L4 (part-time 4WD models) or L4L (full-time 4WD models).
 - The shift lever is in P.
 - The accelerator or brake pedal is depressed.
 - The vehicle speed exceeds approximately 15 mph (25 km/h).
 - The brake system overheats.
- In the following situations, the indicator flashes to alert the driver, but the system will operate:
 - The shift lever is in N.
 - The “DAC” switch is turned off while the system is operating.
The system will gradually cease operation. The indicator will flash during operation, and then go off when the system is fully off.

■ When the downhill assist control system is operated continuously

This may cause the brake actuator to overheat. In this case, the downhill assist control system will stop operating, a buzzer will sound and the downhill assist control system indicator will start flashing, and the “TRAC OFF” indicator light will come on. Refrain from using the system until the downhill assist control system indicator stays on and “TRAC OFF” indicator light turns off. (The vehicle can be driven normally during this time.)

■ Sounds and vibrations caused by the downhill assist control system

- A sound may be heard from the engine compartment when the engine is started or just after the vehicle begins to move. This sound does not indicate that a malfunction has occurred in downhill assist control system.
- Either of the following conditions may occur when the downhill assist control system is operating. None of these are indicators that a malfunction has occurred.
 - Vibrations may be felt through the vehicle body and steering.
 - A motor sound may be heard after the vehicle comes to a stop.

■ System malfunction

In the following cases, have your vehicle checked by your Toyota dealer.

- The downhill assist control system indicator does not come on when the engine switch is turned to IGNITION ON mode.
- The downhill assist control system indicator does not come on when the “DAC” switch is pressed.
- The slip indicator comes on.

⚠ WARNING**■ When using downhill assist control system**

Do not rely overmuch on the downhill assist control system. This function does not extend the vehicle's performance limitations. Always thoroughly check the road conditions, and drive safely.

■ The system may not operate on the following surfaces, which may lead to an accident causing death or serious injury

- Slippery surfaces such as wet or muddy roads
- Icy surface
- Unpaved roads

Crawl Control*

Allows travel on extremely rough off-road surfaces at a fixed low speed without pressing the accelerator or brake pedal. Minimizes loss of traction or vehicle slip when driving on slippery road surfaces, allowing for stable driving.

■ Crawl Control switch

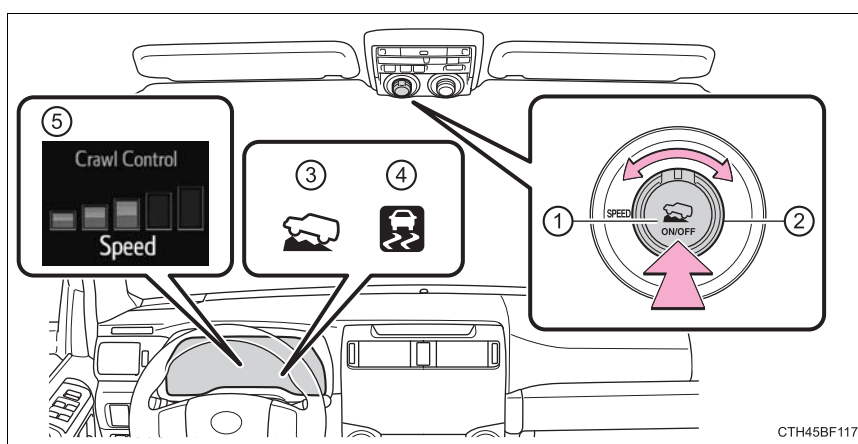

① "ON/OFF" switch

The Crawl Control indicator comes on and the slip indicator flashes when operating.

② Speed selector dial

Turn the dial clockwise to increase the speed and counterclockwise to decrease the speed.

③ Crawl Control indicator

④ Slip indicator

⑤ Multi-information display

The operating status and speed select status of the Crawl Control are shown on the multi-information display.

*: If equipped

■ Speed modes

The following table shows some typical terrains and the recommended speed modes.

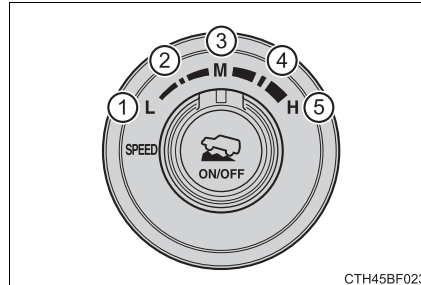

Mode		Road condition
①	L (Low)	Rock, mogul (downhill) and gravel (downhill)
②	Between L and M	Mogul (uphill)
③	M (Medium)	
④	Between M and H	Snow, mud, gravel (uphill), sand, dirt, mogul (uphill) and grass
⑤	H (High)	

■ Crawl Control can be operated when

- The engine is running.
- The shift lever is in any position other than P or N.
- The front-wheel drive control lever or switch is in L4.
- The driver's door is closed.

■ Crawl Control is temporarily canceled when

Vehicle speed exceeds 15 mph (25 km/h). The Crawl Control indicator flashes until the vehicle speed is reduced.

■ **Automatic system cancelation**

In the following situations, the system will cease operation and a buzzer will sound to alert the driver. The Crawl Control indicator will flash until the system is turned off completely.

- When the shift lever is shifted to P or N
- When the front-wheel drive control lever or switch is shifted to H4
- When the driver's door is opened
- When the system is malfunctioning
- When the brake system overheats
Stop the vehicle in a safe place. (There is no problem with continuing normal driving.)
- When the automatic transmission system overheats
Stop the vehicle in a safe place until the automatic transmission fluid temperature warning light goes off.

■ **Sounds and vibrations caused by the Crawl Control system**

- A sound may be heard from the engine compartment when the engine is started or just after the vehicle begins to move. This sound does not indicate that a malfunction has occurred in Crawl Control system.
- Either of the following conditions may occur when the Crawl Control system is operating. None of these indicates that a malfunction has occurred.
 - Vibrations may be felt through the vehicle body and steering.
 - A motor sound may be heard after the vehicle comes to a stop.

■ **When there is a malfunction in the system**

Warning lights and/or warning messages will turn on. (→P. 477, 488)

 WARNING
<p>■ When using Crawl Control</p> <ul style="list-style-type: none"> ● Do not overly rely on Crawl Control. This function does not extend the vehicle's performance limitations. Always check the terrain thoroughly and drive safely. ● The recommended speed modes for the listed terrains (→P. 313) are only a reference. The selected mode may not be suitable to actual off-road conditions due to factors such as the type or unevenness of the terrain or the degree of incline. Check the actual terrain thoroughly and drive safely. ● After activating Crawl Control, make sure that the Crawl Control indicator comes on. If the indicator flashes, the vehicle is not under system control. <p>■ Conditions under which the system may not operate correctly</p> <p>When driving on the following surfaces, the system may not be able to maintain a fixed low speed, which may result in an accident:</p> <ul style="list-style-type: none"> ● Extremely steep inclines ● Extremely uneven surfaces ● Snow-covered roads, or other slippery surfaces

Multi-terrain Select*

The Multi-terrain Select system has 4 terrain modes. When a terrain mode is selected in accordance with terrain conditions, engine power and active traction control system is controlled to enhance off-road drivability.

Additionally, guidance messages such as transfer mode selection advice are displayed on the multi-information display to assist the driver in operating the vehicle.

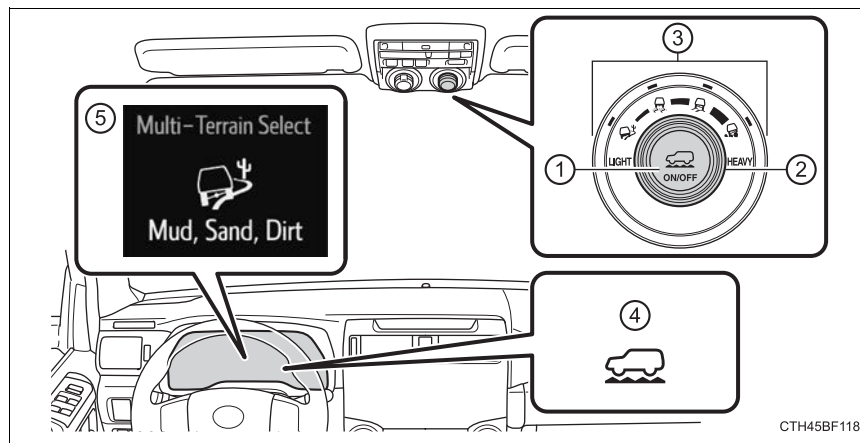

- ① "ON/OFF" switch
- ② Mode selector dial
- ③ Mode indicators
- ④ Multi-terrain Select indicator
- ⑤ Multi-information display

Displays status information including operating status and road type selection.

4



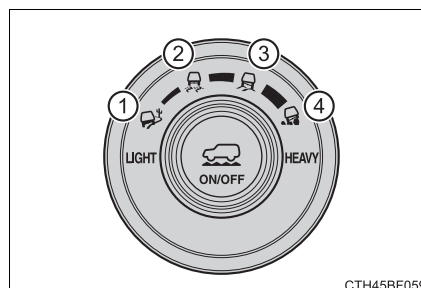

Driving

*: If equipped

■ Multi-terrain Select modes



CTH45BF059

	Symbol	Mode
①		MUD & SAND
②		LOOSE ROCK
③		MOGUL
④		ROCK

The following table shows some typical terrains and the recommended Multi-terrain Select modes.

Mode Road condition	ROCK	MOGUL	LOOSE ROCK	MUD & SAND
Rock	★			
Mogul		★		
Bump, groove		★		
Slope/ V-ditch		★		
Uphill/ downhill		★		
Riverbed			★	
Gravel			★	
Bush			★	
Deep snow				★
Sand				★
Mud				★
Dirt				★

■ **Multi-terrain Select can be activated when**

- Vehicle speed is approximately 7 mph (12 km/h) or less.
- MUD & SAND: The front-wheel drive control lever is in L4 or H4.
LOOSE ROCK, MOGUL and ROCK: The front-wheel drive control lever is in L4.
- Crawl Control is not operating.

Selecting modes

- 1 Press the "ON/OFF" switch.

All of the mode indicators will turn on and then off except the indicator for the current mode. The Multi-terrain Select indicator on the instrument cluster will remain illuminated while this system is enabled. The applicable road conditions will be displayed on the multi-information display for 10 seconds and then will go off.

When the "ON/OFF" switch is pressed to disable the system, a beep will sound.

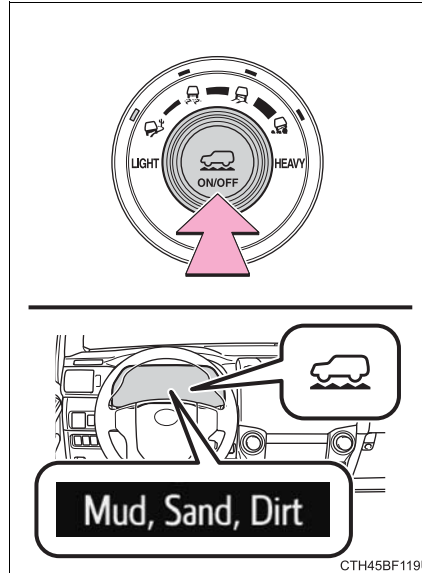

CTH45BF119U

- 2 Turn the dial to select the desired mode.

The indicator for the selected mode will turn on and the applicable road conditions will be displayed on the multi-information display for 10 seconds and then will go off.

If the mode indicator flashes, Multi-terrain Select cannot be operated. Follow the instructions displayed on the multi-information display and check that the mode indicator stops flashing. (→P. 319)

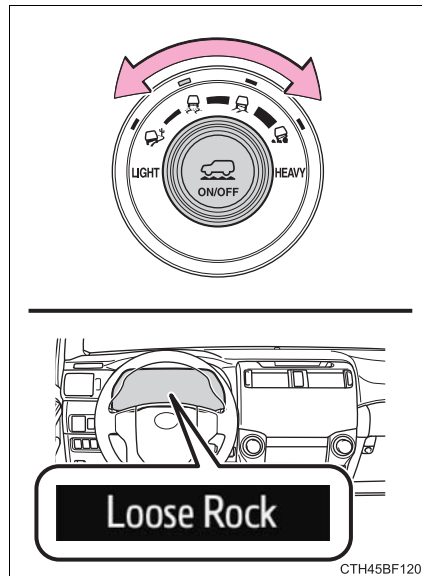

CTH45BF120U

Messages displayed on the multi-information display

Depending on switch operation, one of the following messages may appear on the multi-information display to provide guidance on transfer mode selection etc:

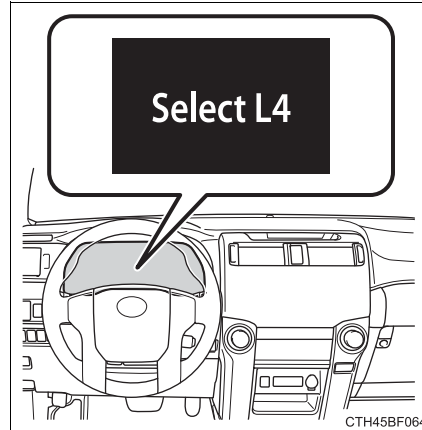

Message	Details	Procedure
"Select 4WD" (When selecting MUD & SAND mode)	Indicates that the transfer mode needs to be changed to H4 or L4.	Shift the front-wheel drive control lever to H4 or L4.
"Select L4" (When selecting LOOSE ROCK, MOGUL or ROCK mode)	Indicates that the transfer mode needs to be changed to L4.	Shift the front-wheel drive control lever to L4.
"Stop the Vehicle. Shift to N" (When selecting any mode)	Indicates that the transfer mode cannot be changed to H4 or L4.	Stop the vehicle completely and/or shift the shift lever to N.
"Accelerate or Decelerate" (When shifting the front-wheel control lever to H4 or H2)	Indicates that the transfer mode may not successfully change.	Drive straight ahead while accelerating or decelerating, or drive in reverse.
"Drive the Vehicle a Short Distance" (When pressing the rear differential lock switch)	Indicates that the rear differential is not locked.	Drive the vehicle forward or backward a short distance.

Message	Details	Procedure
“Operation not available while multi-terrain select active” (When pressing the VSC off switch or “A-TRAC” switch)	Indicates that VSC and active traction control cannot be disabled while Multi-terrain Select is operating.	-
“Return the Four-Wheel Drive Control Switch” (When shifting the front-wheel control lever)	Indicates that the transfer mode cannot be changed to H4 or L4.	Return the front-wheel control lever to H4 or L4.
“Cannot be Selected” (When pressing the “ON/OFF” switch)	Indicates that Multi-terrain Select cannot be operated because vehicle speed exceeds approximately 7 mph (12 km/h).	Reduce vehicle speed.
“Operation Not Possible When Crawl Control Activated” (When pressing the “ON/OFF” switch)	Indicates that Multi-terrain Select cannot be operated because Crawl Control is operating.	Turn Crawl Control off.
“Multi-terrain select has been cancelled” (When pressing the “ON/OFF” switch)	Indicates, along with a beep, that Multi-terrain Select has been disabled.	-
“Multi-terrain select not available” (When pressing the “ON/OFF” switch)	Indicates that Multi-terrain Select cannot be operated because the VSC and/or 4WD system may be malfunctioning.	Contact your Toyota dealer.

■ **Multi-terrain Select is temporarily canceled when**

The front-wheel drive control lever is shifted to H4 when Multi-terrain Select is in ROCK, MOGUL or LOOSE ROCK mode. The mode indicator will flash until the lever is shifted back to L4.

■ **If the Multi-terrain Select indicator continues to flash**

This may indicate a malfunction in the Multi-terrain Select system. In this case, Multi-terrain Select is automatically canceled. Have your vehicle inspected by your Toyota dealer.

■ **If the Multi-terrain Select indicator goes off while Multi-terrain Select is operating**

- One of the vehicle systems related to Multi-terrain Select may be malfunctioning.
Have your vehicle inspected by your Toyota dealer.
- The brake actuator may be at risk of overheating.
A buzzer will sound, the "A-TRAC" indicator will go off and the "TRAC OFF" indicator will come on. Stop the vehicle in a safe place. Refrain from using Multi-terrain Select until the "A-TRAC" indicator comes back on and the "TRAC OFF" indicator goes off. (The vehicle can still be driven, even if Multi-terrain Select is inoperative.)

In the above cases, Multi-terrain Select is automatically canceled.



WARNING

■ **Before driving**

To avoid an accident, observe the precautions relating to off-road driving. (→P. 335)

■ **When using Multi-terrain Select**

- Do not use the Multi-terrain Select system for normal (on-road) driving. The Multi-terrain Select system is designed for off-road use only.
- Do not overly rely on Multi-terrain Select. This function does not extend the vehicle's performance limitations. Always check the terrain thoroughly and drive safely.
- The recommended modes for the listed terrains (→P. 316) are only a reference. The selected mode may not be suitable to actual off-road conditions due to factors such as the type or unevenness of the terrain or the degree of incline. Check the actual terrain thoroughly and drive safely.
- After selecting a mode, make sure that the Multi-terrain Select indicator and the selected mode indicator come on. If any related indicator flashes, the vehicle is not under Multi-terrain Select control.

Driving assist systems

To keep driving safety and performance, the following systems operate automatically in response to various driving situations. Be aware, however, that these systems are supplementary and should not be relied upon too heavily when operating the vehicle.

◆ **ABS (Anti-lock Brake System)**

Helps to prevent wheel lock when the brakes are applied suddenly, or if the brakes are applied while driving on a slippery road surface

◆ **Multi Terrain ABS (Anti-lock Brake System) (if equipped)**

Helps to prevent wheel lock when the brakes are applied suddenly, or if the brakes are applied while driving on a slippery road surface, or in off-road conditions (such as rough roads, sand and mud)

The Multi Terrain ABS operates in synchronization with the Multi-terrain Select.

◆ **Brake assist**

Generates an increased level of braking force after the brake pedal is depressed when the system detects a panic stop situation

◆ **VSC (Vehicle Stability Control)**

Helps the driver to control skidding when swerving suddenly or turning on slippery road surfaces

◆ **Trailer Sway Control**

Helps the driver to control trailer sway by selectively applying brake pressure for individual wheels and reducing driving torque when trailer sway is detected.

◆ **TRAC (Traction Control)**

Helps to maintain drive power and prevent the drive wheels from spinning when starting the vehicle or accelerating on slippery roads

◆ **Hill-start assist control**

Helps to reduce the backward movement of the vehicle when starting on an uphill

◆ **LSD (Limited Slip Differential) (if equipped)**

Transfers drive power to the rear tires when front tires spin, and vice versa, in order to improve traction

◆ **KDSS (Kinetic Dynamic Suspension System) (if equipped)**

Enhances ride comfort and handling response by using a hydraulic control system to control the suspension stabilizer bars in response to road surface and driving conditions during cornering or off-road driving

When the TRAC/VSC/Trailer Sway Control systems are operating (2WD models)

The slip indicator light will flash while the TRAC/VSC/Trailer Sway Control systems are operating.

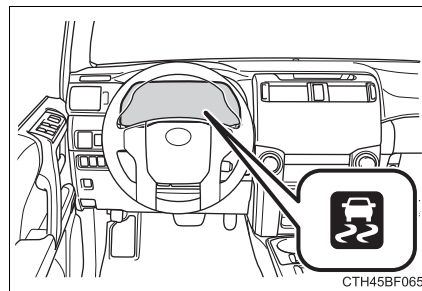

When the TRAC/VSC/Trailer Sway Control/hill-start assist control systems are operating (4WD models)

The slip indicator light will flash while the TRAC/VSC/Trailer Sway Control/hill-start assist control systems are operating.

A buzzer (intermittent) sounds when the hill-start assist control system is operating.

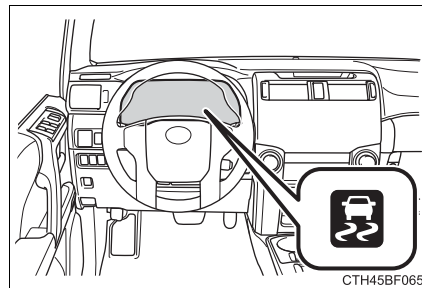

Disabling the TRAC system (2WD models)

If the vehicle gets stuck in mud, dirt or snow, the TRAC system may reduce power from the engine to the wheels. Pressing  to turn the system off may make it easier for you to rock the vehicle in order to free it.

■ Turning off the TRAC system (turning on the AUTO LSD system: →P. 304)

To turn the TRAC system off, quickly press and release



The VSC OFF and “AUTO LSD” indicators will come on.

Press  again to turn the system back on.

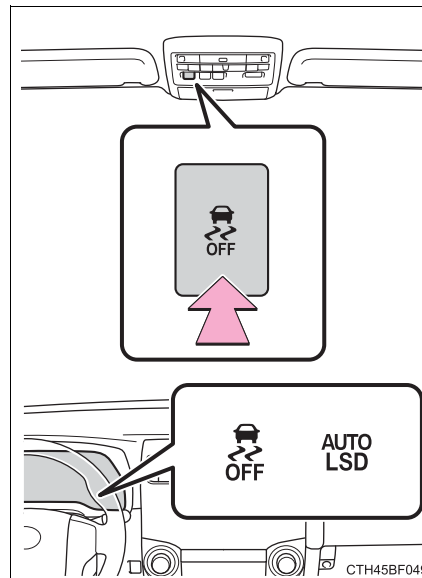

■ Turning off TRAC, VSC and Trailer Sway Control systems

To turn the TRAC, VSC and Trailer Sway Control systems

off, press and hold  for more than 3 seconds while the vehicle is stopped.

The “TRAC OFF” indicator light and the VSC OFF indicator light will come on.

Press  again to turn the systems back on.

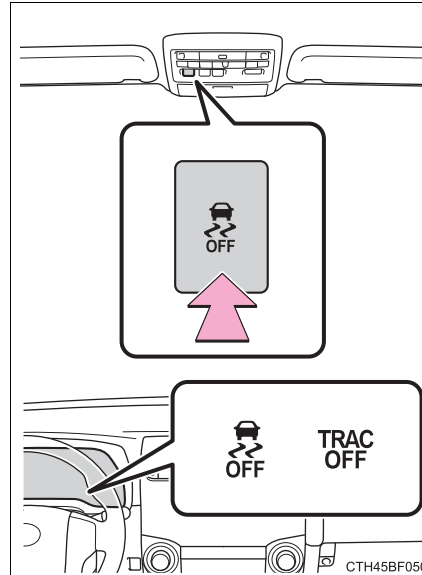

Disabling the TRAC system (4WD models)

If the vehicle gets stuck in mud, dirt or snow, the TRAC system may reduce power from the engine to the wheels. Pressing  to turn the system off may make it easier for you to rock the vehicle in order to free it.

■ Turning off the TRAC system

To turn the TRAC system off, quickly press and release



The "TRAC OFF" indicator light will come on.

Press  again to turn the system back on.

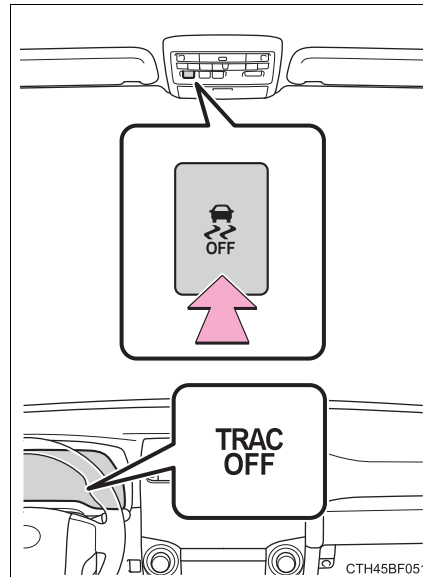

■ Turning off TRAC, VSC and Trailer Sway Control systems

To turn the TRAC, VSC and Trailer Sway Control systems

off, press and hold  for more than 3 seconds while the vehicle is stopped.

The "TRAC OFF" indicator light and the VSC OFF indicator light will come on.

Press  again to turn the systems back on.

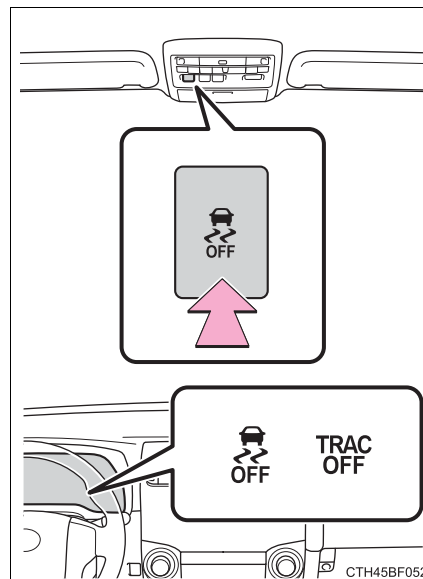

■ **When the “TRAC OFF” indicator light comes on even if  has not been pressed**

TRAC, hill-start assist control, downhill assist control and crawl control are temporary deactivated. If the indicator light continues to remain on, contact your Toyota dealer.

■ **When the VSC or TRAC system is turned off by pressing the VSC off switch**

On vehicles with pre-collision system, pre-collision brake assist and pre-collision braking will also be disabled. The PCS warning light will come on and the message will be shown on the multi-information display. (→P. 248)

■ **Operating conditions of hill-start assist control**

When the following conditions are met, the hill-start assist control will operate:

▶ 2WD models

- The shift lever is in a position other than P or N (when starting off forward/backward on an upward incline)
- The vehicle is stopped
- The accelerator pedal is not depressed
- The parking brake is not engaged

▶ 4WD models

- The system has detected that the vehicle is moving backward
- The shift lever is in a position other than P or N (when starting off forward/backward on an upward incline)
- The brake pedal is not depressed.
- The rear differential is not locked.(if equipped)

■ **Automatic system cancelation of hill-start assist control (2WD models)**

The hill-start assist control will turn off in any of the following situations:

- The shift lever is shifted to P or N
- The accelerator pedal is depressed
- The parking brake is engaged
- 2 seconds at maximum elapsed after the brake pedal is released

■ **When the brake system operates continuously**

The brake actuator may overheat. In this case, the TRAC and hill-start assist control systems will stop operating, a buzzer will sound and the “TRAC OFF” indicator will come on. Refrain from using the system until the “TRAC OFF” indicator turns off. (There is no problem with continuing normal driving.)

■ **Sounds and vibrations caused by the ABS, Multi Terrain ABS (if equipped), brake assist, VSC, Trailer Sway Control, TRAC and hill-start assist control systems**

- A sound may be heard from the engine compartment when the brake pedal is depressed repeatedly, when the engine is started or just after the vehicle begins to move. This sound does not indicate that a malfunction has occurred in any of these systems.
- Any of the following conditions may occur when the above systems are operating. None of these indicates that a malfunction has occurred.
 - Vibrations may be felt through the vehicle body and steering.
 - A motor sound may be heard also after the vehicle comes to a stop.
 - The brake pedal may pulsate slightly after the ABS or Multi Terrain ABS is activated.
 - The brake pedal may move down slightly after the ABS or Multi Terrain ABS is activated.

■ **Automatic reactivation of TRAC, Trailer Sway Control and VSC systems**

After turning the TRAC, Trailer Sway Control and VSC systems off, the systems will be automatically re-enabled in the following situations:

- When the engine switch is turned off
- 2WD models: If the AUTO LSD system is turned on, the VSC, TRAC and Trailer Sway Control systems will turn on when vehicle speed increases
- 4WD models: If only the TRAC system is turned off, the TRAC will turn on when vehicle speed increases

If both the TRAC and VSC systems are turned off, automatic re-enabling will not occur when vehicle speed increases.

 **WARNING****■ The ABS and Multi Terrain ABS do not operate effectively when**

- The limits of tire gripping performance have been exceeded (such as excessively worn tires on a snow covered road).
- The vehicle hydroplanes while driving at high speed on wet or slick roads.

■ Stopping distance when the ABS or Multi Terrain ABS is operating may exceed that of normal conditions

The ABS and Multi Terrain ABS are not designed to shorten the vehicle's stopping distance. Always maintain a safe distance from the vehicle in front of you, especially in the following situations:

- When driving on dirt, gravel or snow-covered roads
- When driving with tire chains
- When driving over bumps in the road
- When driving over roads with potholes or uneven surfaces

■ TRAC/VSC may not operate effectively when

Directional control and power may not be achievable while driving on slippery road surfaces, even if the TRAC/VSC system is operating.

Drive the vehicle carefully in conditions where stability and power may be lost.

■ Hill-start assist control does not operate effectively when**▶ 2WD models**

- Do not overly rely on the hill-start assist control. Hill-start assist control may not operate effectively on steep inclines and roads covered with ice.
- Unlike the parking brake, hill-start assist control is not intended to hold the vehicle stationary for an extended period of time. Do not attempt to use hill-start assist control to hold the vehicle on an incline, as doing so may lead to an accident.

▶ 4WD models

Do not overly rely on the hill-start assist control. The hill-start assist control may not operate effectively on a steep uphill and roads covered with ice.

 **WARNING****■ When the TRAC/VSC/Trailer Sway Control is activated**

The slip indicator light flashes. Always drive carefully.

Reckless driving may cause an accident. Exercise particular care when the indicator light flashes.

■ When TRAC/VSC/Trailer Sway Control systems are turned off

Be especially careful and drive at a speed appropriate to the road conditions. As these are systems to help ensure vehicle stability and driving force, do not turn the TRAC/VSC/Trailer Sway Control systems off unless necessary.

■ Replacing tires

Make sure that all tires are of the specified size, brand, tread pattern and total load capacity. In addition, make sure that the tires are inflated to the recommended tire inflation pressure level.

The ABS, Multi Terrain ABS, TRAC, VSC and Trailer Sway Control will not function correctly if different tires are installed on the vehicle.

Contact your Toyota dealer for further information when replacing tires or wheels.

■ Handling of tires and the suspension

Using tires with any kind of problem or modifying the suspension will affect the driving assist systems, and may cause a system to malfunction.

■ Trailer Sway Control precaution

The Trailer Sway Control system is not able to reduce trailer sway in all situations.

Depending on many factors such as the conditions of the vehicle, trailer, road surface and driving environment, the Trailer Sway Control system may not be effective. Refer to your trailer owner's manual for information on how to tow your trailer properly.

■ If trailer sway occurs

Observe the following precautions.

Failing to do so may cause death or serious injury.

● Firmly grip the steering wheel. Steer straight ahead.

Do not try to control trailer sway by turning the steering wheel.

● Begin releasing the accelerator pedal immediately but very gradually to reduce speed.

Do not increase speed. Do not apply vehicle brakes.

If you make no extreme correction with the steering or brakes, your vehicle and trailer should stabilize. (→P. 195)

Winter driving tips

Carry out the necessary preparations and inspections before driving the vehicle in winter. Always drive the vehicle in a manner appropriate to the prevailing weather conditions.

Preparation for winter

- Use fluids that are appropriate to the prevailing outside temperatures.
 - Engine oil
 - Engine coolant
 - Washer fluid
- Have a service technician inspect the condition of the battery.
- Have the vehicle fitted with four snow tires or purchase a set of tire chains for the rear tires.

Ensure that all tires are the same size and brand, and that chains match the size of the tires.

Before driving the vehicle

Perform the following according to the driving conditions:

- Do not try to forcibly open a window or move a wiper that is frozen. Pour warm water over the frozen area to melt the ice. Wipe away the water immediately to prevent it from freezing.
- To ensure proper operation of the climate control system fan, remove any snow that has accumulated on the air inlet vents in front of the windshield.
- Check for and remove any excess ice or snow that may have accumulated on the exterior lights, vehicle's roof, chassis, around the tires or on the brakes.
- Remove any snow or mud from the bottom of your shoes before getting in the vehicle.

When driving the vehicle

Accelerate the vehicle slowly, keep a safe distance between you and the vehicle ahead, and drive at a reduced speed suitable to road conditions.

When parking the vehicle

- Park the vehicle and move the shift lever to P without setting the parking brake. The parking brake may freeze up, preventing it from being released. If the vehicle is parked without setting the parking brake, make sure to block the wheels. Failure to do so may be dangerous because it may cause the vehicle to move unexpectedly, possibly leading to an accident.
- If the vehicle is parked without setting the parking brake, confirm that the shift lever cannot be moved out of P*.

*: The shift lever will be locked if it is attempted to be shifted from P to any other position without depressing the brake pedal. If the shift lever can be shifted from P, there may be a problem with the shift lock system. Have the vehicle inspected by your Toyota dealer immediately.

Selecting tire chains

Use the correct tire chain size when mounting the tire chains.
Chain size is regulated for each tire size.

- ① Side chain
(0.20 in. [5 mm] in diameter)
- ② Cross chain
(0.20 in. [5 mm] in diameter)

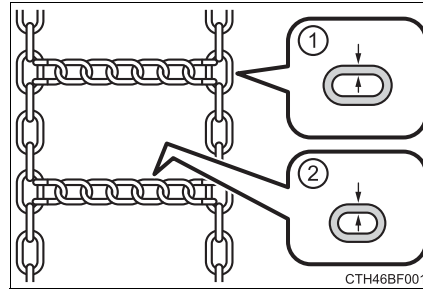

Regulations on the use of tire chains

Regulations regarding the use of tire chains vary depending on location and type of road. Always check local regulations before installing chains.

■ Tire chain installation

Observe the following precautions when installing and removing chains:

- Install and remove tire chains in a safe location.
- Install tire chains on the rear tires only. Do not install tire chains on the front tires.
- Install tire chains on rear tires as tightly as possible. Retighten chains after driving 1/4 — 1/2 mile (0.5 — 1.0 km).
- Install tire chains following the instructions provided with the tire chains.

 **WARNING****■ Driving with snow tires**

Observe the following precautions to reduce the risk of accidents. Failure to do so may result in a loss of vehicle control and cause death or serious injury.

- Use tires of the specified size.
- Maintain the recommended level of air pressure.
- Do not drive in excess of 75 mph (120 km/h), regardless of the type of snow tires being used.
- Use snow tires on all, not just some wheels.

■ Driving with tire chains

Observe the following precautions to reduce the risk of accidents. Failure to do so may result in the vehicle being unable to be driven safely, and may cause death or serious injury.

- Do not drive in excess of the speed limit specified for the tire chains being used, or 30 mph (50 km/h), whichever is lower.
- Avoid driving on bumpy road surfaces or over potholes.
- Avoid sudden acceleration, abrupt steering, sudden braking and shifting operations that cause sudden engine braking.
- Slow down sufficiently before entering a curve to ensure that vehicle control is maintained.

 **NOTICE****■ Repairing or replacing snow tires**

Request repairs or replacement of snow tires from Toyota dealers or legitimate tire retailers.

This is because the removal and attachment of snow tires affects the operation of the tire pressure warning valves and transmitters.

■ Fitting tire chains

The tire pressure warning valves and transmitters may not function correctly when tire chains are fitted.

Off-road precautions

This vehicle belongs to the utility vehicle class, which has higher ground clearance and narrower tread in relation to the height of its center of gravity to make it capable of performing in a wide variety of off-road applications.

Off-road vehicle feature

- Specific design characteristics give it a higher center of gravity than ordinary passenger cars. This vehicle design feature causes this type of vehicle to be more likely to rollover. And, utility vehicles have a significantly higher rollover rate than other types of vehicles.
- An advantage of the higher ground clearance is a better view of the road allowing you to anticipate problems.
- It is not designed for cornering at the same speeds as ordinary passenger cars any more than low-slung sports cars designed to perform satisfactorily under off-road conditions. Therefore, sharp turns at excessive speeds may cause rollover.

 **WARNING****Off-road vehicle precautions**

Always observe the following precautions to minimize the risk of death, serious injury or damage to your vehicle:

- In a rollover crash, an unbelted person is significantly more likely to die than a person wearing a seat belt. Therefore, the driver and all passengers should always fasten their seat belts.
- Avoid sharp turns or abrupt maneuvers, if at all possible.
Failure to operate this vehicle correctly may result in loss of control or vehicle rollover causing death or serious injury.
- Loading cargo on the roof luggage carrier will make the center of the vehicle gravity higher. Avoid high speeds, sudden starts, sharp turns, sudden braking or abrupt maneuvers, otherwise it may result in loss of control or vehicle rollover due to failure to operate this vehicle correctly.
- Always slow down in gusty crosswinds. Because of its profile and higher center of gravity, your vehicle is more sensitive to side winds than an ordinary passenger car. Slowing down will allow you to have better control.
- When driving off-road or in rugged terrain, do not drive at excessive speeds, jump, make sharp turns, strike objects, etc. This may cause loss of control or vehicle rollover causing death or serious injury. You are also risking expensive damage to your vehicle's suspension and chassis.
- Do not drive horizontally across steep slopes. Driving straight up or straight down is preferred. Your vehicle (or any similar off-road vehicle) can tip over sideways much more easily than forward or backward.

Off-road driving

When driving your vehicle off-road, please observe the following precautions to ensure your driving enjoyment and to help prevent the closure of areas to off-road vehicles:

- Drive your vehicle only in areas where off-road vehicles are permitted to travel.
- Respect private property. Get owner's permission before entering private property.
- Do not enter areas that are closed. Honor gates, barriers and signs that restrict travel.
- Stay on established roads. When conditions are wet, driving techniques should be changed or travel delayed to prevent damage to roads.

Additional information for off-road driving

For owners in U.S. mainland, Hawaii and Puerto Rico:

To obtain additional information pertaining to driving your vehicle off-road, consult the following organizations.

- State and Local Parks and Recreation Departments
- State Motor Vehicle Bureau
- Recreational Vehicle Clubs
- U.S. Forest Service and Bureau of Land Management

 **WARNING****■ Off-road driving precautions**

Always observe the following precautions to minimize the risk of death, serious injury or damage to your vehicle:

- Drive carefully when off the road. Do not take unnecessary risks by driving in dangerous places.
- Do not grip the steering wheel spokes when driving off-road. A bad bump could jerk the wheel and injure your hands. Keep both hands and especially your thumbs on the outside of the rim.
- Always check your brakes for effectiveness immediately after driving in sand, mud, water or snow.
- After driving through tall grass, mud, rock, sand, rivers, etc., check that there is no grass, bush, paper, rags, stone, sand, etc. adhering or trapped on the underbody. Clear off any such matter from the underbody. If the vehicle is used with these materials trapped or adhering to the underbody, a breakdown or fire could occur.
- In a rollover crash, an unbelted person is significantly more likely to die than a person wearing a seat belt. Therefore, the driver and all passengers should fasten their seat belts whenever the vehicle is moving.
- When driving off-road or in rugged terrain, do not drive at excessive speeds, jump, make sharp turns, strike objects, etc. This may cause loss of control or vehicle rollover causing death or serious injury. You are also risking expensive damage to your vehicle's suspension and chassis.

 NOTICE**■ To prevent water damage**

Take all necessary safety measures to ensure that water damage to the engine or other components does not occur.

- Water entering the engine air intake will cause severe engine damage.
- Water entering the automatic transmission will cause deterioration in shift quality, locking up of your transmission accompanied by vibration, and ultimately damage.
- Water can wash the grease from wheel bearings, causing rusting and premature failure, and may also enter the differentials, transmission and transfer case, reducing the gear oil's lubricating qualities.

■ When you drive through water

If driving through water, such as when crossing shallow streams, first check the depth of the water and the bottom of the riverbed for firmness. Drive slowly and avoid deep water.

■ Inspection after off-road driving

- Sand and mud that has accumulated in brake drums and around brake discs may affect braking efficiency and may damage brake system components.
- Always perform a maintenance inspection after each day of off-road driving that has taken you through rough terrain, sand, mud, or water. For scheduled maintenance information, refer to the "Scheduled Maintenance Guide" or "Owner's Manual Supplement".

Interior features

5

5-1. Using the air conditioning system and defogger

- Manual air conditioning system..... 342
- Automatic air conditioning system..... 349
- Heated steering wheel/
Seat heaters/
seat ventilators..... 357

5-2. Using the interior lights

- Interior lights list 360
 - Interior lights 361
 - Personal lights 361

5-3. Using the storage features

- List of storage features 363
 - Glove box..... 364
 - Console box..... 364
 - Cup holders 365
 - Auxiliary box 367
 - Coin holder/
tissue pocket/
pen holder..... 368
 - Bottle holders..... 369
- Luggage compartment features..... 370

5-4. Other interior features

- Other interior features 375
 - Sun visors..... 375
 - Vanity mirrors..... 375
 - Clock..... 376
 - Power outlets
(120 V AC)..... 377
 - Power outlets..... 381
 - USB charging ports..... 384
 - Armrest 386
 - Assist grips 386
- Garage door opener..... 387

Manual air conditioning system*

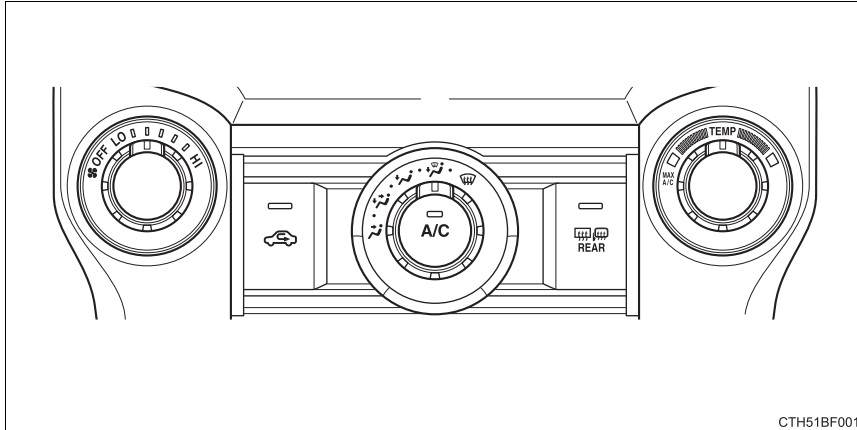

Air conditioning controls



■ Adjusting the temperature setting

To adjust the temperature setting, turn  clockwise (warm) or counterclockwise (cool).

If  is not pressed, the system will blow ambient temperature air or heated air.

For quick cooling, turn the temperature control knob to “MAX A/C”. The air conditioning will automatically turn on and, if an air outlet position other than  or  is selected, the system will be set to recirculated air mode. While “MAX A/C” is selected, it is not possible to turn off the air conditioning.

*: If equipped

■ Fan speed setting

To adjust the fan speed, turn  clockwise (increase) or counterclockwise (decrease).

Turning the knob to “OFF” turns off the fan.

■ Change the airflow mode

To select the air outlets, set  to the desired position.

The positions between the air outlet selections shown below can also be selected for more delicate adjustment.

■ Other functions

- Switching between outside air and recirculated air modes
- Defogging the windshield (→P. 344)
- Defogging the rear window and outside rear view mirrors (→P. 344)
- Windshield wiper de-icer (if equipped) (→P. 344)

Other functions

■ Switching between outside air and recirculated air modes

Press  .

The mode switches between outside air mode (introduces air from outside the vehicle) (indicator off) and recirculated air mode (recycles air inside the vehicle) (indicator on) each time the button is pressed.

■ Defogging the windshield

Defoggers are used to defog the windshield and front side windows.

Set the air outlet selector dial to  position.

If the recirculated air mode is used, it will automatically switch to outside air mode.

To defog the windshield and the side windows early, increase the air flow and temperature.

If the dehumidification function is not operating, press  to operate the dehumidification function.

■ Defogging the rear window and outside rear view mirrors

Defoggers are used to defog the rear window, and to remove rain-drops, dew and frost from the outside rear view mirrors.

Before operating the defoggers, make sure the back window is completely closed. (→P. 158)

Press 

The defoggers will automatically turn off after their operation time. The operation time varies depending on the ambient temperature and vehicle speed.

■ Windshield wiper de-icer (if equipped)

This feature is used to prevent ice from building up on the windshield and wiper blades.

Turns the windshield wiper de-icer on/off

The windshield wiper de-icer will automatically turn off after approximately 15 minutes.

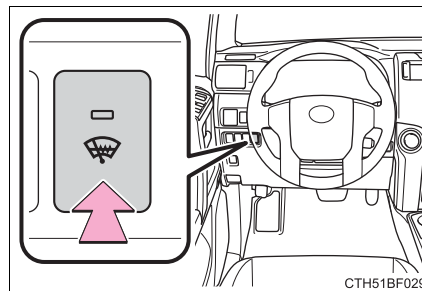

Air outlets

■ Location of air outlets

The air outlets and air volume changes according to the selected airflow mode.

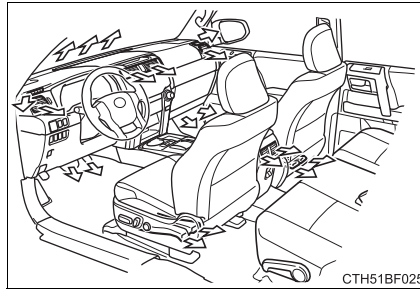

■ Adjusting the position of and opening and closing the air outlets

▶ Front center outlets

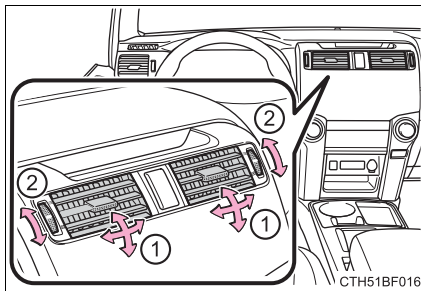

▶ Front side outlets

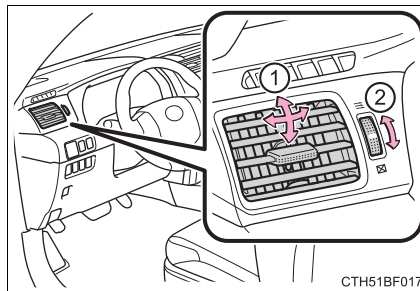

▶ Rear outlets

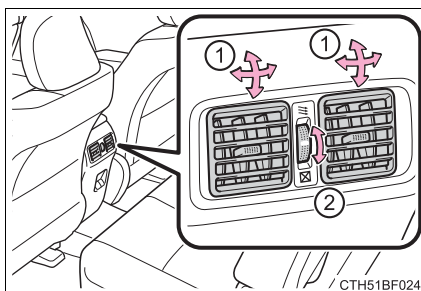

- ① Direct air flow to the left or right, up or down.
- ② Turn the knob to open or close the vent.

■ Fogging up of the windows

- The windows will easily fog up when the humidity in the vehicle is high.

Turning  on will dehumidify the air from the outlets and defog the windshield effectively.

- If you turn  off, the windows may fog up more easily.
- The windows may fog up if the recirculated air mode is used.

■ When driving on dusty roads

Close all windows. If dust thrown up by the vehicle is still drawn into the vehicle after closing the windows, it is recommended that the air intake mode be set to outside air mode and the fan speed to any setting except off.

■ Outside/recirculated air mode

Setting to the recirculated air mode temporarily is recommended in preventing dirty air from entering the vehicle interior and helping to cool the vehicle when the outside air temperature is high.

■ When the outside temperature exceeds 75°F (24°C) and the air conditioning system is on

- In order to reduce the air conditioning power consumption, the air conditioning system may switch to recirculated air mode automatically. This may also reduce fuel consumption.
- Recirculated air mode is selected as a default mode when the engine switch is turned to IGNITION ON mode.
- It is possible to switch to outside air mode at any time by pressing  .

■ When the indicator light on  flashes

Press  to turn off the cooling and dehumidification function and turn it on again. There may be a problem in the air conditioning system if the indicator light continues to flash. Turn the air conditioning system off and have it inspected by your Toyota dealer.

■ **When the outside temperature falls to nearly 32°F (0°C)**

The dehumidification function may not operate even when  is pressed.

■ **Ventilation and air conditioning odors**



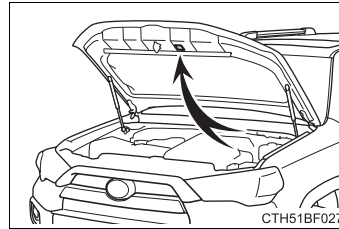

- To let fresh air in, set the air conditioning system to the outside air mode.
- During use, various odors from inside and outside the vehicle may enter into and accumulate in the air conditioning system. This may then cause odor to be emitted from the vents.
- To reduce potential odors from occurring:
It is recommended that the air conditioning system be set to outside air mode prior to turning the vehicle off.

■ **Air conditioning system refrigerant**

- A label regarding the refrigerant of the air conditioning system is attached to the hood at the location shown in the following illustration.



- The meaning of each symbol on the label are as follows:

	Caution
	Air conditioning system
	Air conditioning system lubricant type
	Requires registered technician to service air conditioning system
	Flammable refrigerant

⚠ WARNING**■ To prevent the windshield from fogging up**

- Do not use  during cool air operation in extremely humid weather. The difference between the temperature of the outside air and that of the windshield can cause the outer surface of the windshield to fog up, blocking your vision.
- Do not place anything on the instrument panel which may cover the air outlets. Otherwise, air flow may be obstructed, preventing the windshield defoggers from defogging.

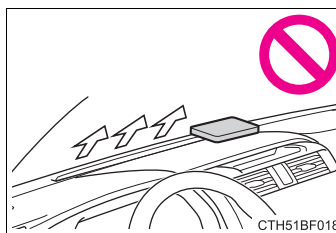
**■ To prevent burns**

- Do not touch the rear view mirror surfaces when the outside rear view mirror defoggers are on.
- Do not touch the glass at lower part of the windshield or to the side of the front pillars when the windshield wiper de-icer is on.

⚠ NOTICE**■ To prevent battery discharge**

Do not leave the air conditioning system on longer than necessary when the engine is stopped.

■ When repairing/replacing parts of the air conditioning system

Have repair/replacement performed by your Toyota dealer.

When a part of the air conditioning system, such as the evaporator, is to be replaced, it must be replaced with a new one.



Automatic air conditioning system*

Air outlets and fan speed are automatically adjusted according to the temperature setting.

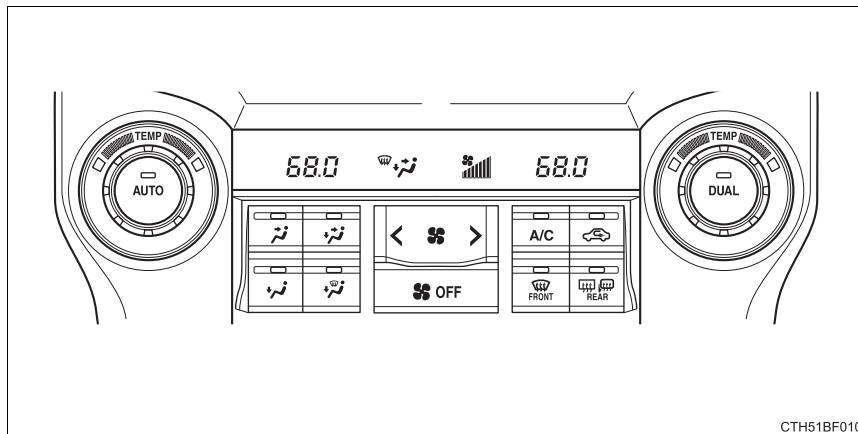
Air conditioning controls





■ Adjusting the temperature setting

To adjust the temperature setting, turn  clockwise to increase the temperature and turn  counterclockwise to decrease the temperature.

If  is not pressed, the system will blow ambient temperature air or heated air.

■ Fan speed setting

To adjust the fan speed, press “>” on  to increase the fan speed and “<” to decrease the fan speed.

Press  to turn the fan off.

*: If equipped

■ **Change the airflow mode**

To change the air outlets, press , ,  or .

■ **Other functions**

- Switching between outside air and recirculated air modes (→P. 351)
- Defogging the windshield (→P. 351)
- Defogging the rear window and outside rear view mirrors (→P. 351)
- Windshield wiper de-icer (if equipped) (→P. 352)

Using automatic mode

1 Press .

The air conditioning system begins to operate. Air outlets and fan speed are automatically adjusted according to the temperature setting.

2 Adjust the temperature setting.

3 To stop the operation, press .

■ **Automatic mode indicator**

If the fan speed setting or air flow modes are operated, the automatic mode indicator goes off. However, automatic mode for functions other than that operated is maintained.

■ **Adjusting the temperature for driver and passenger seats separately (“DUAL” mode)**

Perform the following procedures to turn on the “DUAL” mode:

● Press .

● Adjust the passenger’s side temperature setting.

The indicator comes on when the “DUAL” mode is on.

While in “DUAL” mode, the temperature of the rear air outlets is set at the right-hand side temperature setting.

Other functions

■ Switching between outside air and recirculated air modes

Press  .

The mode switches between outside air mode (the indicator is off) and recirculated air mode (the indicator is on) each time the button is pressed.

■ Defogging the windshield

Defoggers are used to defog the windshield and front side windows.

Press  .

The dehumidification function operates and fan speed increases. Set the outside/recirculated air mode button to the outside air mode if the recirculated air mode is used. (It may switch automatically.) To defog the windshield and the side windows early, turn the air flow and temperature up.

To return to the previous mode, press  again when the windshield is defogged.

■ Defogging the rear window and outside rear view mirrors

Defoggers are used to defog the rear window, and to remove rain-drops, dew and frost from the outside rear view mirrors.

Before operating the defoggers, make sure the back window is completely closed. (→P. 158)

Press  .

The defoggers will automatically turn off after their operation time. The operation time varies depending on the ambient temperature and vehicle speed.

■ Windshield wiper de-icer (if equipped)

This feature is used to prevent ice from building up on the windshield and wiper blades.

Turns the windshield wiper de-icer on/off

The windshield wiper de-icer will automatically turn off after approximately 15 minutes.

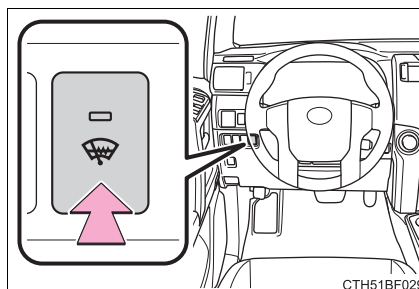
**Air outlets****■ Location of air outlets**

The air outlets and air volume changes according to the selected airflow mode.

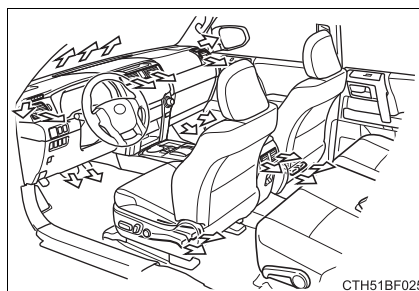

■ Adjusting the position of and opening and closing the air outlets

▶ Front center outlets

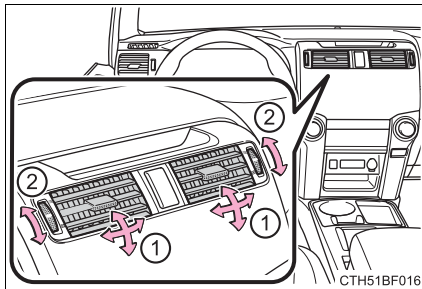

▶ Front side outlets

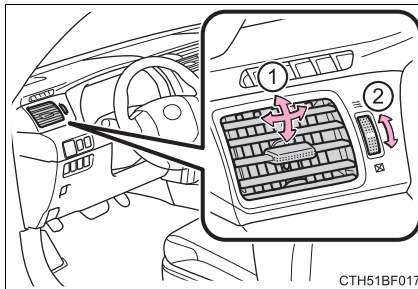

▶ Rear outlets

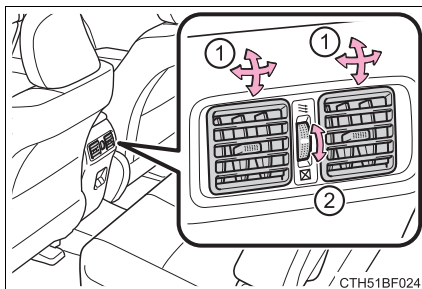

- ① Direct air flow to the left or right, up or down.
- ② Turn the knob to open or close the vent.

■ Using automatic mode

Fan speed is adjusted automatically according to the temperature setting and the ambient conditions.

Therefore, the fan may stop for a while until warm or cool air is ready to flow

immediately after  is pressed.

■ Fogging up of the windows

- The windows will easily fog up when the humidity in the vehicle is high.

Turning  on will dehumidify the air from the outlets and defog the windshield effectively.

- If you turn  off, the windows may fog up more easily.
- The windows may fog up if the recirculated air mode is used.

■ When driving on dusty roads

Close all windows. If dust thrown up by the vehicle is still drawn into the vehicle after closing the windows, it is recommended that the air intake mode be set to outside air mode and the fan speed to any setting except off.

■ Outside/recirculated air mode

- Setting to the recirculated air mode temporarily is recommended in preventing dirty air from entering the vehicle interior and helping to cool the vehicle when the outside air temperature is high.
- Outside/recirculated air mode may automatically switch depending on the temperature setting, outside temperature, pressure, engine coolant temperature or inside temperature.

■ When the outside temperature exceeds 75°F (24°C) and the air conditioning system is on

- In order to reduce the air conditioning power consumption, the air conditioning system may switch to recirculated air mode automatically. This may also reduce fuel consumption.
- Recirculated air mode is selected as a default mode when the engine switch is turned to IGNITION ON mode.
- It is possible to switch to outside air mode at any time by pressing .

■ When the outside temperature falls to nearly 32°F (0°C)

The dehumidification function may not operate even when  is pressed.

■ When driving on dusty roads

Close all windows. If dust thrown up by the vehicle is still drawn into the vehicle after closing the windows, it is recommended that the air intake mode be set to outside air mode and the fan speed to any setting except off.

■ When the indicator light on flashes

Press  to turn off the cooling and dehumidification function and turn it on again. There may be a problem in the air conditioning system if the indicator light continues to flash. Turn the air conditioning system off and have it inspected by your Toyota dealer.

■ **Ventilation and air conditioning odors**

- To let fresh air in, set the air conditioning system to the outside air mode.
- During use, various odors from inside and outside the vehicle may enter into and accumulate in the air conditioning system. This may then cause odor to be emitted from the vents.
- To reduce potential odors from occurring:
 - It is recommended that the air conditioning system be set to outside air mode prior to turning the vehicle off.
 - The start timing of the blower may be delayed for a short period of time immediately after the air conditioning system is started in automatic mode.

■ **Air conditioning filter**

→P. 445

■ **Air conditioning system refrigerant**

- A label regarding the refrigerant of the air conditioning system is attached to the hood at the location shown in the following illustration.

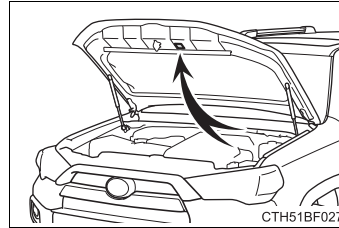

- The meaning of each symbol on the label are as follows:

	Caution
	Air conditioning system
	Air conditioning system lubricant type
	Requires registered technician to service air conditioning system
	Flammable refrigerant

 **WARNING**
■ To prevent the windshield from fogging up

- Do not use  during cool air operation in extremely humid weather.

The difference between the temperature of the outside air and that of the windshield can cause the outer surface of the windshield to fog up, blocking your vision.

- Do not place anything on the instrument panel which may cover the air outlets. Otherwise, air flow may be obstructed, preventing the windshield defoggers from defogging.

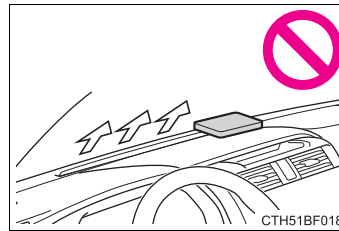
■ To prevent burns

- Do not touch the rear view mirror surfaces when the outside rear view mirror defoggers are on.
- Do not touch the glass at lower part of the windshield or to the side of the front pillars when the windshield wiper de-icer is on.

 **NOTICE**
■ To prevent battery discharge

Do not leave the air conditioning system on longer than necessary when the engine is stopped.

■ When repairing/replacing parts of the air conditioning system

Have repair/replacement performed by your Toyota dealer.

When a part of the air conditioning system, such as the evaporator, is to be replaced, it must be replaced with a new one.

Heated steering wheel*/Seat heaters*/seat ventilators*

Heated steering wheel and seat heaters heat the side grips of the steering wheel and seats, respectively. Seat ventilators maintain good ventilation by pulling air through the seat upholstery.

WARNING

- Care should be taken to prevent injury if anyone in the following categories comes in contact with the steering wheel and seats when the heater is on:
 - Babies, small children, the elderly, the sick and the physically challenged
 - Persons with sensitive skin
 - Persons who are fatigued
 - Persons who have taken alcohol or drugs that induce sleep (sleeping drugs, cold remedies, etc.)
- Observe the following precautions to prevent minor burns or overheating:
 - Do not cover the seat with a blanket or cushion when using the seat heater.
 - Do not use seat heater more than necessary.

NOTICE

- Do not put heavy objects that have an uneven surface on the seat and do not stick sharp objects (needles, nails, etc.) into the seat.
- To prevent battery discharge, do not use the functions when the engine is off.

*: If equipped

Heated steering wheel

Turns the heated steering wheel on/off

The indicator light comes on when the heated steering wheel is operating.

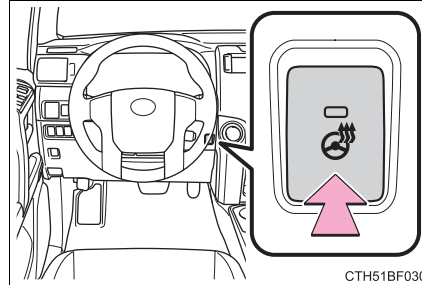

The heated steering wheel can be used when the engine switch is in IGNITION ON mode.

Seat heaters/ventilators

► Vehicles with ventilator

- ① Press the knob to release it, and turn the knob to the desired temperature setting.
- ② OFF
Press the knob to lock it when not in use.
- ③ Ventilation
- ④ Heat

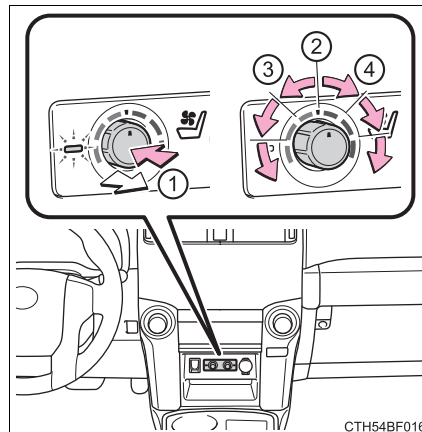

► Vehicles without ventilator

- ① On
The indicator light comes on.
- ② Adjusts the seat temperature
The further you move the dial forward, the warmer the seat becomes.
- ③ Off
Move the dial fully backward. The indicator light turns off.

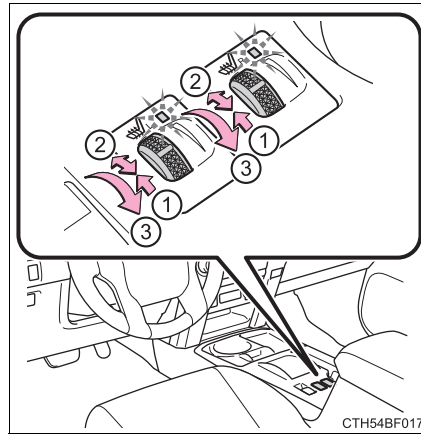

■ The seat heaters/seat ventilators can be used when

The engine switch is in IGNITION ON mode.

Interior lights list

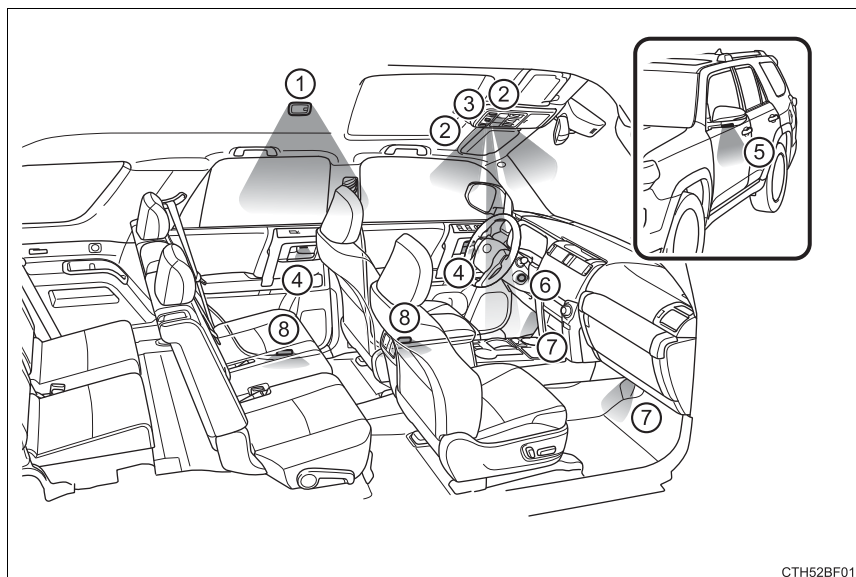

CTH52BF011

- ① Rear interior light (→P. 361)
- ② Front interior light/front personal lights (→P. 361)
- ③ Shift lever light (when the engine switch is in ACCESSORY or IGNITION ON mode)
- ④ Inside door handle lights (if equipped)
- ⑤ Outer foot lights (if equipped)
- ⑥ Engine switch light
- ⑦ Footwell lights (if equipped)
- ⑧ Door courtesy lights

Turning the instrument panel light control dial fully downward disables the inside door handle lights, footwell lights and shift lever light. (→P. 89)

Interior lights

■ **Front**

- ① Turns the lights off
- ② Turns the door position on

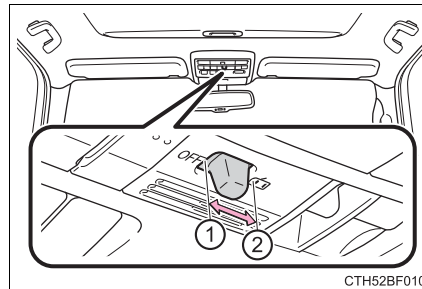

CTH52BF010

■ **Rear**

- ① Turns the door position on
- ② Turns the light off
- ③ Turns the light on

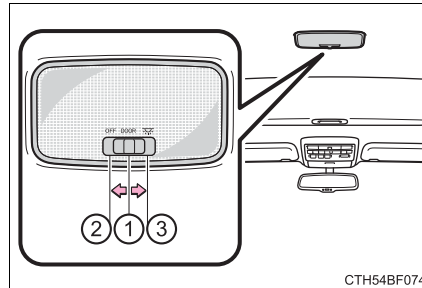

CTH54BF074

Personal lights

Turns the lights on/off

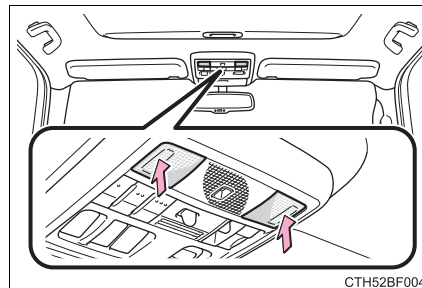

CTH52BF004

■ **Illuminated entry system**

The lights automatically turn on/off according to engine switch mode, the presence of the electronic key, whether the doors are locked/unlocked, and whether the doors are opened/closed.

■ **To prevent battery discharge**

If the following lights remain on, the lights will go off automatically after 20 minutes:

- Engine switch light
- Front interior light
- Rear interior light
- Personal lights
- Footwell lights
- Inside door handle lights
- Door courtesy lights

■ **Customization**

Setting (e.g. the time elapsed before lights turn off) can be changed.
(Customizable features: →P. 549)

 NOTICE

■ **To prevent battery discharge**

Do not leave the lights on longer than necessary when the engine is not running.

List of storage features

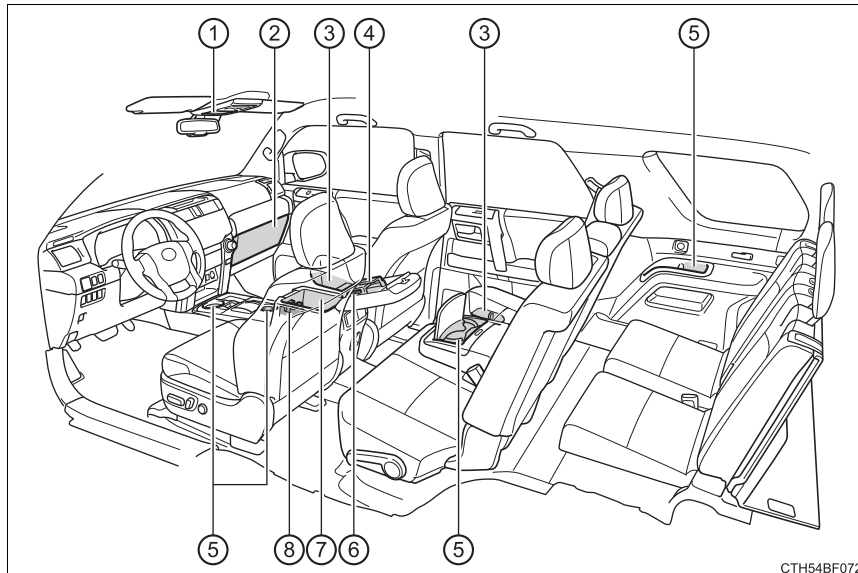

- | | |
|----------------------------|-------------------------|
| ① Auxiliary box (→P. 367) | ⑤ Cup holders (→P. 365) |
| ② Glove box (→P. 364) | ⑥ Pen holder (→P. 368) |
| ③ Bottle holders (→P. 369) | ⑦ Console box (→P. 364) |
| ④ Tissue pocket (→P. 368) | ⑧ Coin holder (→P. 368) |

⚠ WARNING

- Do not leave glasses, lighters or spray cans in the storage spaces, as this may cause the following when cabin temperature becomes high:
 - Glasses may be deformed by heat or cracked if they come into contact with other stored items.
 - Lighters or spray cans may explode. If they come into contact with other stored items, the lighter may catch fire or the spray can may release gas, causing a fire hazard.
- When driving or when the storage compartments are not in use, keep the lids closed. In the event of sudden braking or sudden swerving, an accident may occur due to an occupant being struck by an open lid or the items stored inside.

Glove box

The glove box can be opened by pressing the lock release button and can be locked and unlocked by using the mechanical key.

- ① Open
- ② Unlock
- ③ Lock

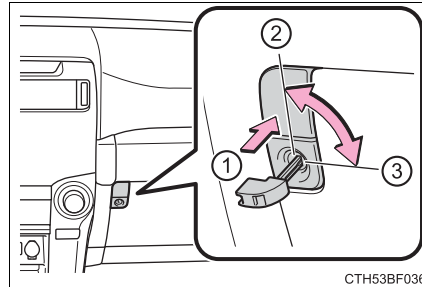

Console box

Lift the lid while pulling up the knob to release the lock.

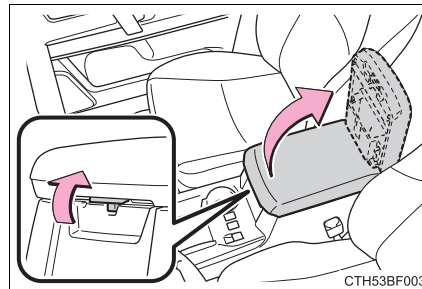

■ The separator can be used in either of the positions shown in the illustration

Change the separator position.

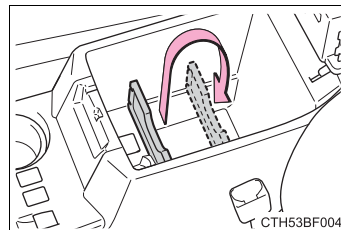

Cup holders

▶ Front seats

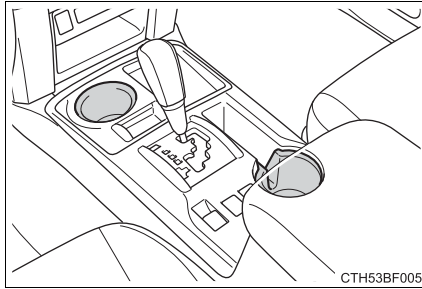

▶ Rear seats (without third row seats)

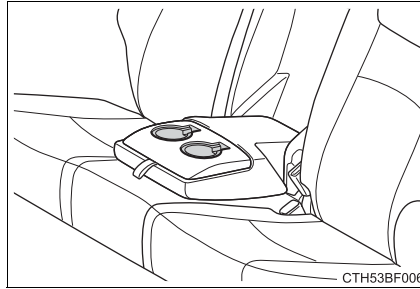

Pull down the rear seat center armrest.

▶ Second row seats (with third row seats)

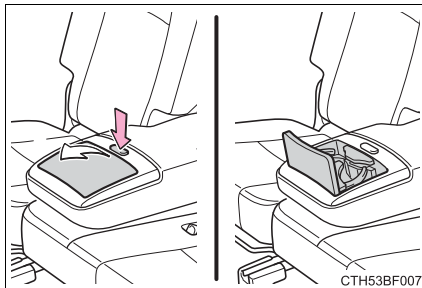

▶ Third row seats (if equipped)

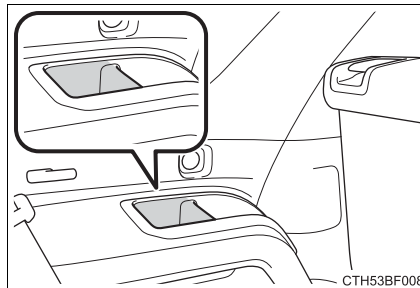

Pull down the second row seat center armrest and press down the button on the armrest.

■ Adjusting the size of the cup holders

▶ Front seats

Remove the adapter.

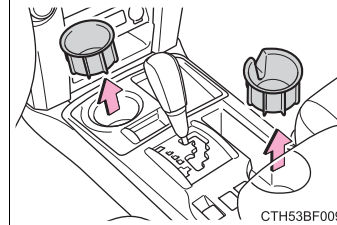

▶ Rear seats (without third row seats)

Remove the adapter.

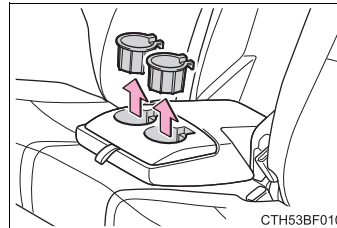

⚠ WARNING

■ Items unsuitable for the cup holders

Do not place anything other than cups or aluminum cans in the cup holders. Even with the lid is closed, items must not be stored in the cup holders. Other items may be thrown out of the holders in the event of an accident or sudden braking, causing injury. If possible, cover hot drinks to prevent burns.

■ When not in use (second row seat cup holders only)

Keep the cup holders closed. In the event of sudden braking, an accident may occur due to an occupant being struck by the open cup holders or the items stored inside.

⚠ NOTICE

■ To prevent damage to the rear cup holders (second row seats only)

Stow the cup holders before stowing the armrest.

Auxiliary box (if equipped)

Push the lid.

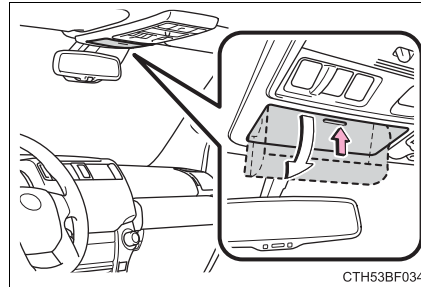
**⚠ WARNING****■ Items unsuitable for storing**

Do not store items heavier than 0.4 lb. (0.2 kg).
Doing so may cause the auxiliary box to open and the items inside may fall out, resulting in an accident.

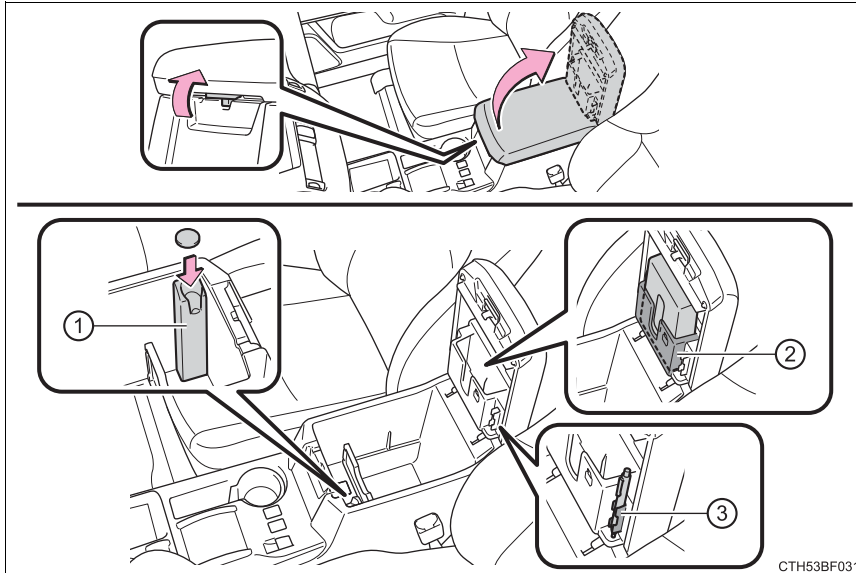
Coin holder/tissue pocket/pen holder

Lift the lid while pulling up the knob to release the lock.

- ① Coin holder
- ② Tissue pocket
- ③ Pen holder

Bottle holders

▶ Front seats

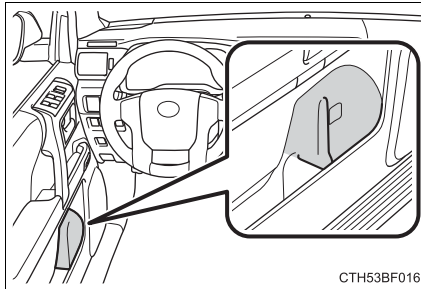

▶ Rear seats (without third row seats)/second row seats (with third row seats)

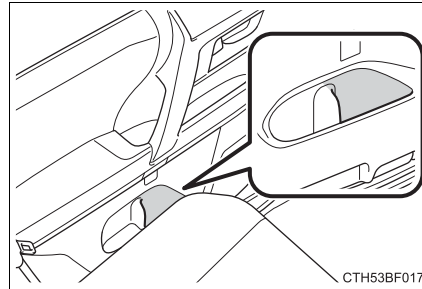

■ When using the bottle holder

- When storing a bottle, close the cap.
- The bottle may not be stored depending on its size or shape.

▲ WARNING

■ Items unsuitable for the bottle holder

Do not place anything other than a bottle in the bottle holders. Other items may be thrown out of the holders in the event of an accident or sudden braking and cause injury.

▲ NOTICE

■ Items that should not be stowed in the bottle holders

Put the cap on before stowing a bottle. Do not place open bottles in the bottle holders, or glasses and paper cups containing liquid. The contents may spill and glasses may break.

Luggage compartment features

■ Cargo hooks

▶ Vehicles with third seats

1 Fold down the third seats. (→P. 138)

2 Raise the hook to use.

The cargo hooks are provided for securing loose items.

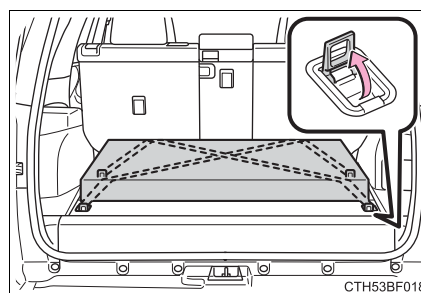

▶ Vehicles without third seats

Raise the hook to use.

The cargo hooks are provided for securing loose items.

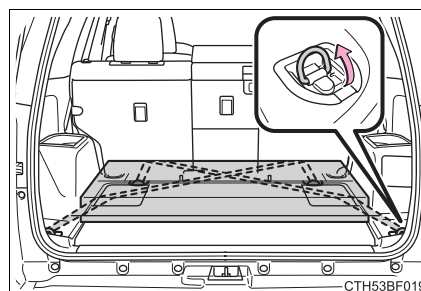

■ Cargo net hooks

The cargo net itself is not included as original equipment.

▶ Vehicles with third seats (pattern 1)

Raise the rear cargo hook to use.

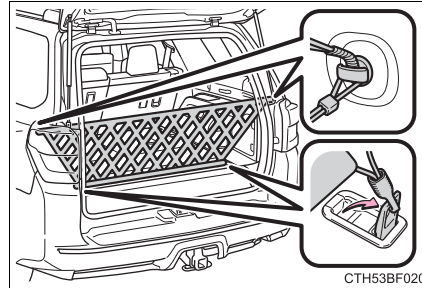

▶ Vehicles with third seats (pattern 2)

1 Fold down the third seats. (→P. 138)

2 Raise the cargo hook to use.

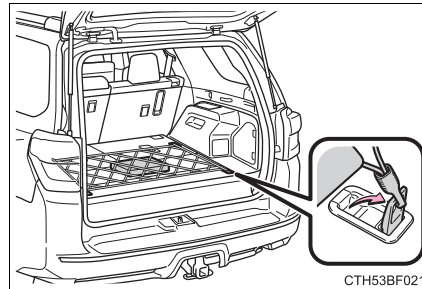

▶ Vehicles without third seats (pattern 1)

Raise the rear cargo hook to use.

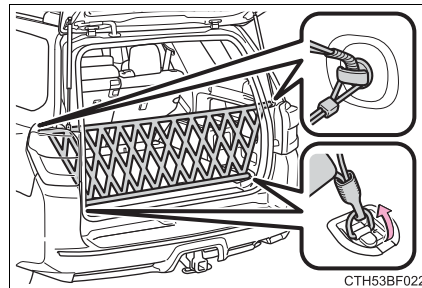

▶ Vehicles without third seats (pattern 2)

Raise the cargo hook to use.

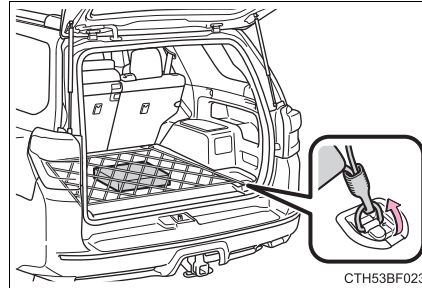

■ Storage compartment

▶ Type A (if equipped)

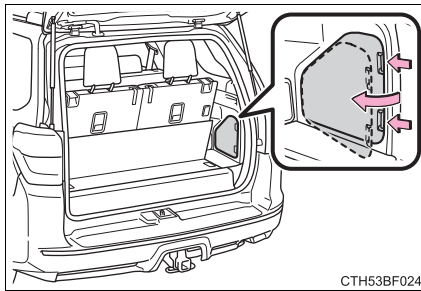

▶ Type B (if equipped)

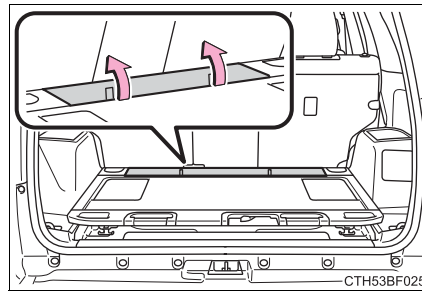

Open the storage compartment as shown.

■ **Slide deck (if equipped)**

Slide the deck while turning the lock release lever, and then release the lever after sliding the deck to the lock position.

- ① Half-slide locked position
- ② Full-slide locked position

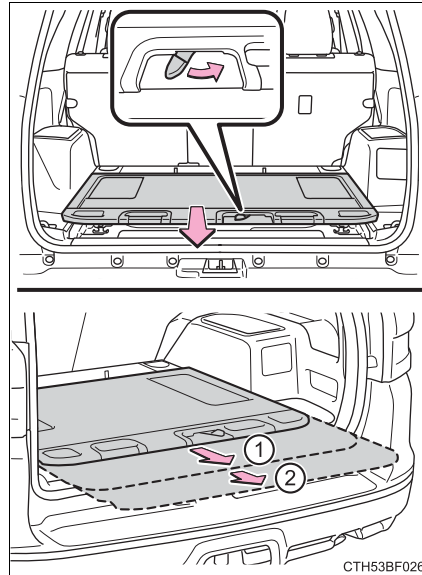

■ **Grocery bag hooks**

▶ Type A

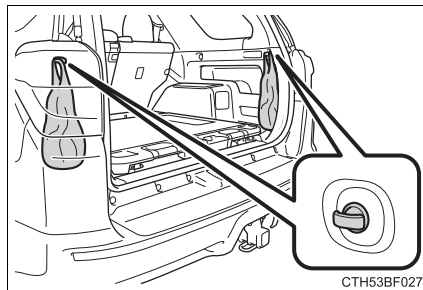

▶ Type B (if equipped)

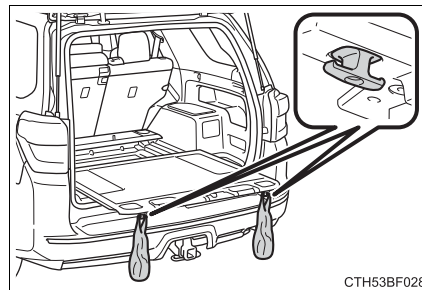

Type B only: To use the grocery bag hooks, slide the slide deck to the full-slide locked position.

 WARNING

■ **When the cargo hooks are not in use**

To avoid injury, always return the cargo hooks to their stowed positions.

■ **Slide deck operating precaution (if equipped)**

- Be careful not to get hands or feet pinched by the slide deck.
- Be careful not to allow the slide deck to hit any persons or luggage while sliding the deck.
- Do not operate the slide deck while someone is on it. Doing so may cause an accident.
- If operating the slide deck when the vehicle is stopped on an incline, the slide deck may move faster. Be careful not to allow the slide deck to hit you or pinch your fingers etc.
- After sliding the deck, make sure it is securely locked in position.
- Do not close the back door while any person is sitting on the slide deck or any person is between the slide deck and back door.
- Do not stow any objects into the space between the slide deck rails.

 NOTICE

■ **To prevent damage to the cargo net hooks**

Avoid hanging things other than a cargo net on them.

■ **Slide deck weight capacity (if equipped)**

Do not load anything heavier than 440 lb. (200 kg) on the sliding deck.

■ **Grocery bag hook weight capacity**

Do not hang any object heavier than 8.8 lb. (4 kg) on the grocery bag hooks.

■ **When using the slide deck (if equipped)**

- Do not close the back door while the slide deck is sliding out. Doing so may cause the back door or slide deck to break.
- If operating the slide deck when the vehicle is stopped on an incline, the slide deck may move faster. Be careful as luggage may become damaged or fly out and damage the cabin.

Other interior features

Sun visors

- ① To set the visor in the forward position, flip it down.
- ② To set the visor in the side position, flip down, unhook, and swing it to the side.
- ③ To use the side extender, place the visor in the side position, then slide it backward.

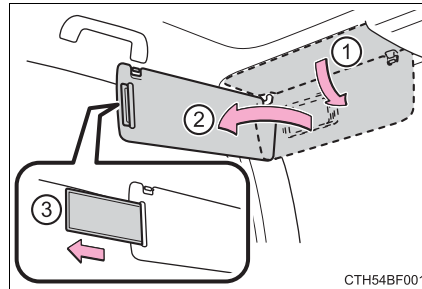

Vanity mirrors

Slide the cover to open.

The light turns on when the cover is opened.

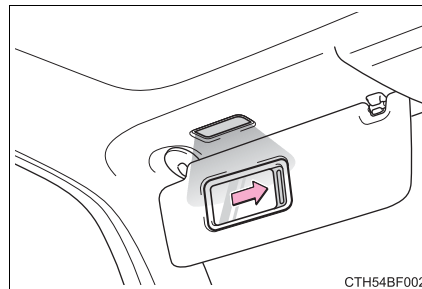

NOTICE

To prevent battery discharge

Do not leave the vanity lights on for extended periods while the engine is off.

Clock

The clock can be adjusted by pressing the buttons.

- ① Adjusts the hours
- ② Adjusts the minutes

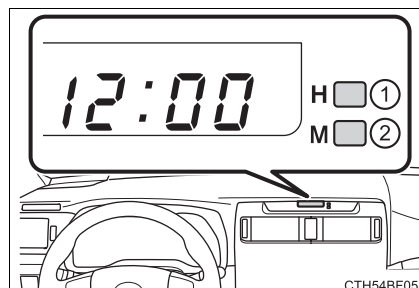

■ **The clock is displayed when**

The engine switch is in ACCESSORY or IGNITION ON mode.

■ **When disconnecting and reconnecting battery terminals**

The clock data will be reset.

Power outlets (120 V AC)

The power outlet can be used for electrical appliances.

► Main switch

To use the power outlet, turn on the main switch.

The power supply starts a few seconds after the main switch is pressed.

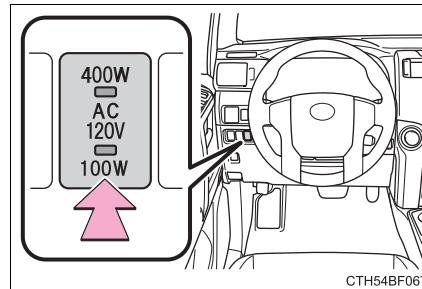

► Power outlet socket (luggage compartment)

Open the lid.

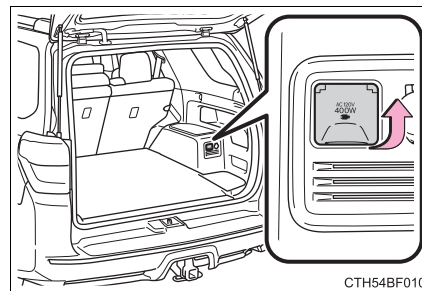

■ Maximum available capacity of the power outlet

● While the vehicle is being driven

The maximum capacity of the power outlet is always 120 V AC/100 W.

● When the vehicle is stationary

The maximum capacity of the power outlet varies depending on the position of the shift lever.

- The maximum capacity is 120 V AC/100 W when the shift lever is in any position other than P or N.
- The maximum capacity is 120 V AC/400 W when the shift lever is in P or N.

The maximum capacity of 400 W can only be restored by turning the power outlet main switch off and then on again with the shift lever in P or N.

■ **The power outlet can be used when**

The engine is running.

■ **The indicator light changes according to the maximum available capacity as follows:**

- ① 120 V AC/400 W
- ② 120 V AC/100 W

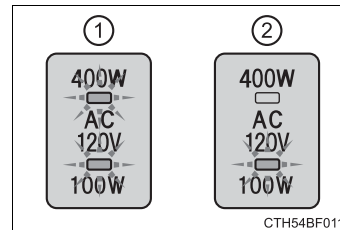

■ **When the power outlet is in operation**

The sound of the cooling fan may be heard from the right side of the luggage compartment. This is normal and does not indicate a malfunction.

■ **If the engine is started with the power outlet main switch on**

The maximum capacity of the power supply may decrease to below the standard, or may be cut off completely, even when the vehicle is stationary.

■ **The protection circuit may be activated to cut the power supply if any of the following conditions apply:**

- The engine is started with the power outlet main switch on.
- Use of electrical appliances exceeding the maximum capacity is attempted.
A sound may be heard when the protection circuit is activated. This is normal and does not indicate a malfunction.
- Electrical appliances, which consume power exceeding 100 W, have been used continuously for a long time period.
- The total power usage by all electrical features (headlights, air conditioning, etc.) has exceeded the total vehicle maximum for an extended period of time.

■ **If the protection circuit is activated and the power supply is cut, conduct the following procedure:**

- 1 Park the vehicle in a safe place, and then securely apply the parking brake.
- 2 Check and ensure that the shift lever is in P or N.
- 3 Make sure that the power consumption of the electric appliance is within the maximum capacity of the power outlet and the appliance is not broken.
- 4 Press the power outlet main switch again.

When the cabin temperature is high, open the windows to cool the temperature down. Once it reaches the normal temperature, turn the power outlet main switch on again.

If the power supply does not resume even after the above procedure has been performed, have the vehicle inspected by your Toyota dealer.

 **WARNING****■ Using a power outlet**

Observe the following precautions to reduce the risk of injury.

- Use of the power outlet when it is wet with water or snow may result in electrical shocks and is extremely dangerous. The power outlet must be thoroughly dried before use.
- Do not allow children to use or play with the power outlet.
- Be careful not to get any part of your body caught in the power outlet lid.
- When using electrical appliances, strictly follow any cautions and notices written on their labels and in the manufacturers' instruction manuals.
- Do not modify, disassemble or repair the power outlet or its inverter in any way. Doing so may result in unexpected malfunctions or accidents, which could cause serious damage or injuries. Contact your Toyota dealer for any necessary repairs.

■ To prevent injuries and accidents, secure all electric appliances before use and do not use any appliances that may do any of the following:

- Distract the driver while driving, or hamper safe driving.
- Result in a fire or burn injuries due to the appliance rolling, falling or overheating while driving.
- Emit steam while the windows of the cabin are closed.

■ To prevent unexpected accidents, such as electric shocks, do not perform any of the following actions:

- Using the power outlet for electric heaters while sleeping.
- Contaminating the power outlet with liquid substances or mud.
- Handling electrical appliance plugs at the power outlet with wet hands or feet.
- Inserting foreign objects into the power outlet.
- Using malfunctioning electric appliances.
- Inserting inappropriate or badly fitting plugs into the power outlet.

**NOTICE****■ To avoid damaging the power outlet and the plug**

- Close the power outlet lid when not in use.
- Do not allow foreign objects or liquids to enter the power outlet, as this may cause a short circuit.
- Do not use plug adaptors to connect too many plugs to the power outlet.
- After removing a plug, gently close the power outlet lid.

■ To prevent the fuse from being blown

Do not use a 120 V AC appliance that requires more than the maximum capacity of the power outlet. If a 120 V AC appliance that consumes more than the maximum capacity is used, the protection circuit will cut the power supply.

■ Appliances that may not operate properly (120 V AC)

The following 120 V AC appliances may not operate even if their power consumption is under maximum capacity.

- Appliances with high initial peak wattage
- Measuring devices that process precise data.
- Other appliances that require an extremely stable power supply

■ To prevent battery discharge

Turn off all the vehicle's electronic equipment and accessories, such as the headlights and air conditioning, when electrical appliances that consume in excess of 100 W are used continuously for long periods of time.

■ To prevent any damage caused by heat

- Do not use any electrical appliances that give off intense heat, such as toasters, in any locations including the internal or external trim, seats and deck.
- Do not use any electrical appliances that are easily affected by vibration or heat inside the vehicle. Vibration while driving, or the heat of the sun while parking, may result in damage to those electrical appliances.

 NOTICE

■ **If any electrical appliances are to be used while driving**

Securely fasten both the appliances and their cables to prevent them from falling or getting caught in any of the power train components.

■ **If the power outlet is loose when an electrical appliance plug is connected**

Replace the outlet. Contact your Toyota dealer for any necessary replacements.

■ **If the power outlet gets dirty**

Turn the main switch off and use a soft, clean cloth to wipe it gently. Do not use any cleansing materials, such as organic solvents, wax, or compound cleaners, as these may damage the power outlet or cause it to malfunction.

Power outlets

Please use as a power supply for electronic goods that use less than 12 VDC / 10 A (power consumption of 120 W).

When using electronic goods, make sure that the power consumption of all the connected power outlets is less than 120 W.

► Center panel

Open the lid.

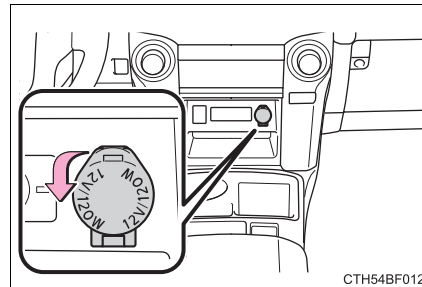

► Console box (inside)

- 1 Lift the lid while pulling up the knob to release the lock.

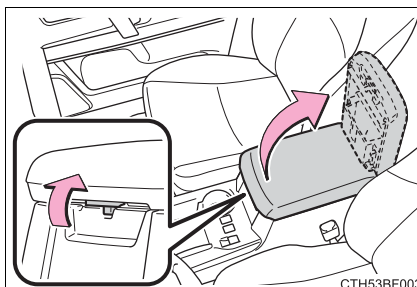

- 2 Open the lid.

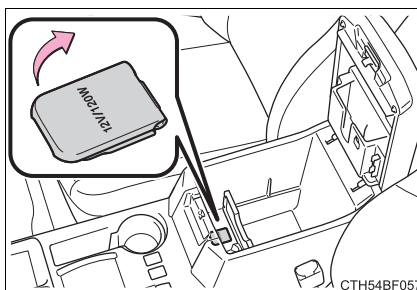

► Luggage compartment

Open the lid.

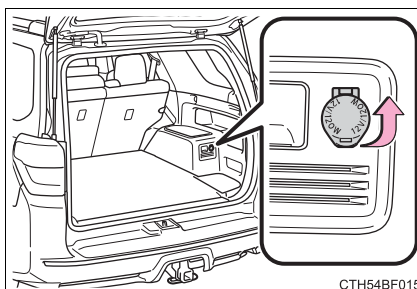

■ The power outlets can be used when

The engine switch is in ACCESSORY or IGNITION ON mode.

■ When turning the engine switch off

Disconnect electrical devices with charging functions, such as mobile battery packs.

If such devices are left connected, the engine switch may not be turned off normally.

**NOTICE****■ To avoid damaging the power outlets**

Close the power outlet lids when the power outlets are not in use.

Foreign objects or liquids that enter the power outlets may cause a short circuit.

■ To prevent battery discharge

Do not use the power outlets longer than necessary when the engine is off.

USB charging ports

The USB charging ports are used to supply 3.0 A of electricity at 5 V to external devices (power consumption of 15 W).

The USB charging ports are for charging only. They are not designed for data transfer or other purposes.

Depending on the external device, it may not charge properly. Refer to the manual included with the device before using a USB charging port.

■ Using the USB charging ports

Open the lid.

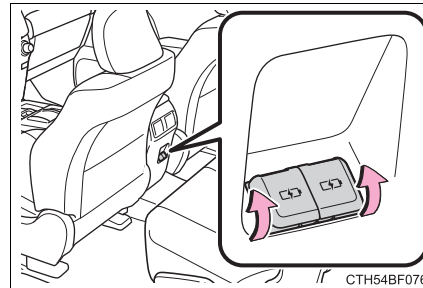

■ The USB charging ports can be used when

The engine switch is in ACCESSORY or IGNITION ON mode.

■ Situations in which the USB charging ports may not operate correctly

- If a device which consumes more than 3.0 A at 5 V (15 W) is connected
- If a device designed to communicate with a personal computer, such as a USB memory device, is connected
- If the connected external device is turned off (depending on device)
- If the temperature inside the vehicle is high, such as after the vehicle has been parked in the sun

■ About connected external devices

Depending on the connected external device, charging may occasionally be suspended and then start again. This is not a malfunction.

 NOTICE**■ To prevent damage to the USB charging ports**

- Do not insert foreign objects into the ports.
- Do not spill water or other liquids into the ports.
- When the USB charging ports are not in use, close the lids. If a foreign object or liquid enters a port may cause a short circuit.
- Do not apply excessive force to or impact the USB charging ports.
- Do not disassemble or modify the USB charging ports.

■ To prevent damage to external devices

- Do not leave external devices in the vehicle. The temperature inside the vehicle may become high, resulting in damage to an external device.
- Do not push down on or apply unnecessary force to an external device or the cable of an external device while it is connected.

■ To prevent battery discharge

Do not use the USB charging ports for a long period of time with the engine stopped.

Armrest

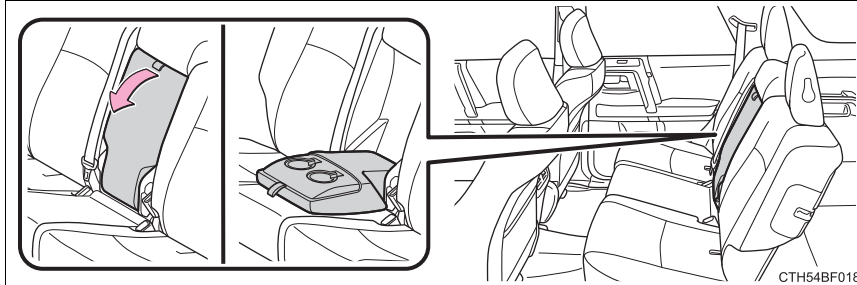

Pull down the armrest for use.

NOTICE

Do not apply too much load on the armrest.

Assist grips

An assist grip (type A) installed on the ceiling can be used to support your body while sitting on the seat.

An assist grip (type B) installed on the pillar can be used when getting in or out of the vehicle and others.

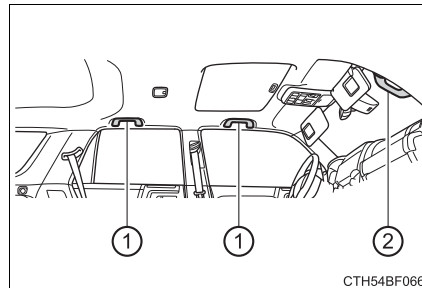

- ① Assist grip (type A)
- ② Assist grip (type B)

WARNING

■ Assist grip (type A)

Do not use the assist grip (type A) when getting in or out of the vehicle or rising from your seat.

NOTICE

Do not hang any heavy object or put a heavy load on the assist grip.

Garage door opener*

The garage door opener can be programmed to operate garage doors, gates, entry doors, door locks, home lighting systems, security systems, and other devices.

The garage door opener (HomeLink® Universal Transceiver) is manufactured under license from HomeLink®.

■ HomeLink® programming procedure

The programming procedures can also be found at the following URL.

Website: www.homelink.com/toyota

For support, contact customer support at the following. Help Line: 1-800-355-3515



■ Programming the HomeLink®

The HomeLink® compatible transceiver in your vehicle has 3 buttons which can be programmed to operate 3 different devices. Refer to the programming method below appropriate for the device.

- ① HomeLink® Indicator light
- ② Garage door operation indicators (→P. 392)
- ③ Buttons

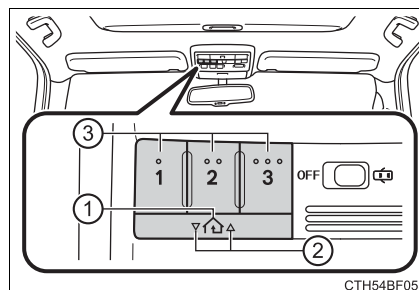

*: If equipped

■ Before programming HomeLink®

- During programming, it is possible that garage doors, gates, or other devices may operate. For this reason, make sure that people and objects are clear of the garage door or other devices to prevent injury or other potential harm.
- It is recommended that a new battery be placed in the remote control transmitter for more accurate programming.
- Garage door openers manufactured after 1995 may be equipped with rolling code protection. If this is the case, you will need a stepladder or other sturdy, safe device to reach the “learn” or “smart” button on the garage door opener motor.

■ Programming HomeLink®

Steps **1** through **3** must be performed within 60 seconds, otherwise the indicator light will stop flashing and programming will not be able to be completed.

- 1** Press and release the HomeLink® button you want to program and check that the HomeLink® indicator light flashes orange.

- 2** Point the remote control transmitter for the device 1 to 3 in. (25 to 75 mm) from the HomeLink® buttons.

Keep the HomeLink® indicator light in view while programming.

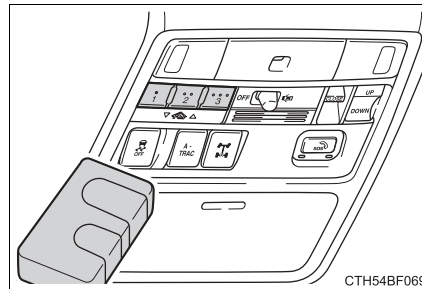

- 3** Program a device.

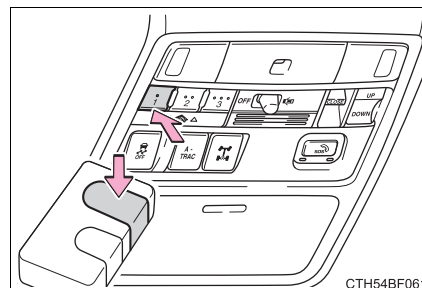

- ▶ Programming a device other than an entry gate (for U.S.A. owners)

Press and hold the HomeLink[®] button you want to program and the remote control transmitter button simultaneously. When the HomeLink[®] indicator light changes from slowly flashing orange to rapidly flashing green (rolling code) or continuously lit green (fixed code), release both buttons.

- ▶ Programming an entry gate (for U.S.A. owners)/Programming a device in the Canadian market

With one hand, press and hold the HomeLink[®] button you want to program. With your other hand, press and release the remote control transmitter button every 2 seconds and repeat this cycle until the HomeLink[®] indicator light starts to flash rapidly. Then, release the buttons.

- 4 Test the HomeLink[®] operation by pressing the newly programmed button and observing the indicator light:
 - If the indicator light is solid/continuous, programming has been completed and your device should activate when the HomeLink[®] button is pressed and released.
 - If the indicator light blinks rapidly for 2 seconds and then turns into a solid/continuous light, proceed to the heading "Programming a rolling code system".
- 5 Repeat the steps above to program another device for any of the remaining HomeLink[®] buttons.

■ **Programming a rolling code system**

2 or more people may be necessary to complete rolling code programming.

- 1 Locate the “learn” or “smart” button on the garage door opener motor in the garage.

This button can usually be found where the hanging antenna wire is attached to the unit. The name and color of the button may vary by manufacturer. Please refer to the owner’s manual supplied with the garage door opener motor for details.

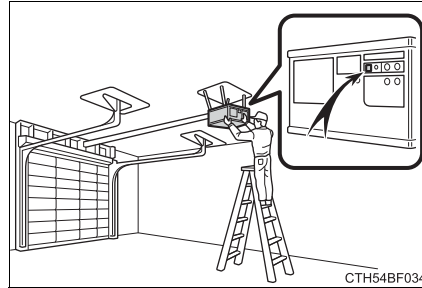

- 2 Press and release the “learn” or “smart” button.

Perform 3 within 30 seconds after performing 2.

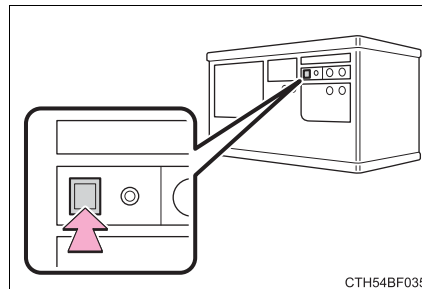

- 3 Press and hold the programmed HomeLink® button (located inside the vehicle) for 2 seconds and release it. Repeat this sequence (press/hold/release) up to 3 times to complete programming.

If the garage door opener motor activates when the HomeLink® button is pressed, the garage door opener motor recognizes the HomeLink® signal.

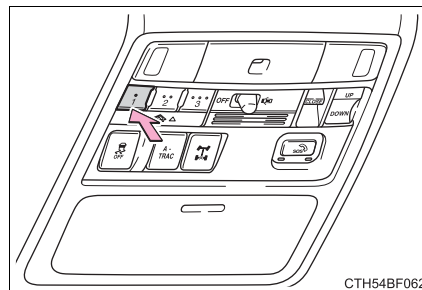

■ Enabling 2-way communication with a garage door (only available for compatible devices)

When enabled, 2-way communication allows you to check the status of the opening and closing of the garage door through indicators in your vehicle.

2-way communication is only available if the garage door opener motor used is a compatible device. (To check device compatibility, refer to the owner's manual supplied with the garage door opener motor.)

- 1 Press a programmed HomeLink® button to operate a garage door.
- 2 Within 1 minute of pressing the HomeLink® button, after the garage door operation has stopped, press the “learn” or “smart” button on the garage door opener motor. Within 5 seconds of the establishment of 2-way communication with the garage door opener, both garage door operation indicators in the vehicle will flash rapidly (green).

■ Reprogramming a single HomeLink® button

When the following procedure is performed, buttons which already have devices registered to them can be overwritten:

- 1 With one hand, press and hold the desired HomeLink® button.
- 2 When the HomeLink® indicator starts flashing, continue to hold the HomeLink® button and perform “Programming HomeLink®” from 1 (it takes 20 seconds for the HomeLink® indicator to start flashing).

Operating HomeLink®

Press the appropriate HomeLink® button. The HomeLink® indicator light should turn on.

Garage door operation indicators

The status of the opening and closing of a garage door is shown by the indicators.

- ① Opening
- ② Closing

This function is only available if the garage door opener motor used is a compatible device. (To check device compatibility, refer to the owner's manual supplied with the garage door opener motor.)

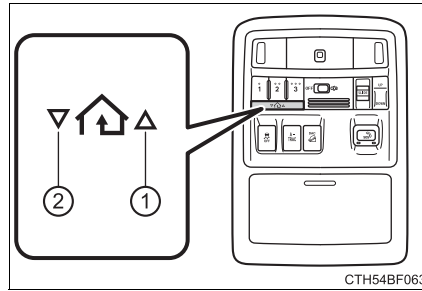

Color	Status
Orange (flashing)	Currently opening/closing
Green	Opening/closing has completed
Red (flashing)	Feedback signals cannot be received

The indicators can operate within approximately 820 ft. (250 m) of the garage door. However, if there are obstacles between the garage door and the vehicle, such as houses and trees, feedback signals from the garage door may not be received.

To recall the previous door operation status, press and release either HomeLink® buttons “1” and “2” or “2” and “3” simultaneously for 2 seconds. The last recorded status will be displayed for 5 seconds.

Erasing the entire HomeLink® memory (all three programs)

Press and hold the 2 outside buttons for 10 seconds until the HomeLink® indicator light changes from continuously lit (orange) to rapidly flashing (green).

If you sell your vehicle, be sure to erase the programs stored in the HomeLink® memory.

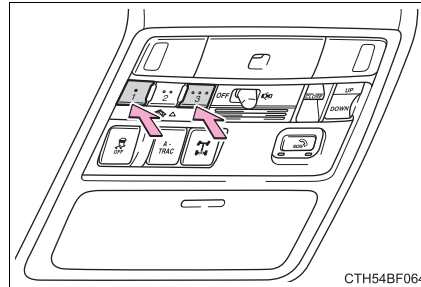

Programs stored in the HomeLink® memory

- The registered codes are not erased even if the 12-volt battery cable is disconnected.
- If learning failed when registering a different code to a HomeLink® button that already has a code registered to it, the already registered code is not erased.

Before programming

- Install a new battery in the transmitter.
- The battery side of the transmitter must be pointed away from the HomeLink®.

⚠ WARNING

■ When programming a garage door or other remote control device

The garage door may operate, so ensure people and objects are out of danger to prevent potential harm.

■ Conforming to federal safety standards

Do not use the HomeLink® Compatible Transceiver with any garage door opener or device that lacks safety stop and reverse features as required by federal safety standards.

This includes any garage door that cannot detect an obstruction object. A door or device without these features increases the risk of death or serious injury.

■ When operating or programming HomeLink®

Never allow a child to operate or play with the HomeLink® buttons.

Maintenance and care**6**

6-1. Maintenance and care	
Cleaning and protecting the vehicle exterior.....	396
Cleaning and protecting the vehicle interior.....	400
6-2. Maintenance	
Maintenance requirements	403
General maintenance.....	405
Emission inspection and maintenance (I/M) programs.....	408
6-3. Do-it-yourself maintenance	
Do-it-yourself service precautions	409
Hood	412
Engine compartment.....	413
Tires	427
Tire inflation pressure	440
Wheels	443
Air conditioning filter.....	445
Electronic key battery.....	447
Checking and replacing fuses	450
Light bulbs.....	453

Cleaning and protecting the vehicle exterior

Perform the following to protect the vehicle and maintain it in prime condition:

- Working from top to bottom, liberally apply water to the vehicle body, wheel wells and underside of the vehicle to remove any dirt and dust.
- Wash the vehicle body using a sponge or soft cloth, such as a chamois.
- For hard-to-remove marks, use car wash soap and rinse thoroughly with water.
- Wipe away any water.
- Wax the vehicle when the waterproof coating deteriorates.

If water does not bead on a clean surface, apply wax when the vehicle body is cool.

■ Automatic car washes

- Fold the mirrors before washing the vehicle. Start washing from the front of the vehicle. Make sure to extend the mirrors before driving.
- Brushes used in automatic car washes may scratch the vehicle surface, parts (wheel, etc.) and harm your vehicle's paint.
- In certain automatic car washes, the roof antenna (if equipped) or rear spoiler may interfere with machine operation. This may prevent the vehicle from being cleaned properly or result in damage to the antenna or rear spoiler.

■ High pressure car washes

As water may enter the cabin, do not bring the nozzle tip near the gaps around the doors or perimeter of the windows, or spray these areas continuously.

■ Wheels and wheel ornaments

- Remove any dirt immediately by using a neutral detergent.
- Wash detergent off with water immediately after use.
- To protect the paint from damage, make sure to observe the following precautions.
 - Do not use acidic, alkaline or abrasive detergent
 - Do not use hard brushes
 - Do not use detergent on the wheels when they are hot, such as after driving or parking in hot weather

■ Brake pads and calipers

Rust may form if the vehicle is parked with wet brake pads or disc rotors, causing them to stick. Before parking the vehicle after it is washed, drive slowly and apply the brakes several times to dry the parts.

■ Bumpers and side moldings

Do not scrub with abrasive cleaners.

■ Plated portions

If dirt cannot be removed, clean the parts as follows:

- Use a soft cloth dampened with an approximately 5% solution of neutral detergent and water to clean the dirt off.
- Wipe the surface with a dry, soft cloth to remove any remaining moisture.
- To remove oily deposits, use alcohol wet wipes or a similar product.

■ Notes for a smart key system

If the door handle becomes wet while the electronic key is within the effective range, the door may lock and unlock repeatedly. In this case, follow the following correction procedures to wash the vehicle:

- Place the electronic key in a location 6 ft. (2 m) or more away from the vehicle. (Take care to ensure that the key is not stolen.)
- Set the electronic key to battery-saving mode to disable the smart key system. (→P. 116)

WARNING

■ When washing the vehicle

Do not apply water to the inside of the engine compartment. Doing so may cause the electrical components etc. to catch fire.

■ Precautions regarding the exhaust pipe

Exhaust gases cause the exhaust pipe to become quite hot.

When washing the vehicle, be careful not to touch the pipe until it has cooled sufficiently, as touching hot exhaust pipe can cause burns.



NOTICE

■ To prevent paint deterioration and corrosion on the body and components (aluminum wheels etc.)

- Wash the vehicle immediately in the following cases:
 - After driving near the sea coast
 - After driving on salted roads
 - If coal tar or tree sap is present on the paint surface
 - If dead insects, insect droppings or bird droppings are present on the paint surface
 - After driving in an area contaminated with soot, oily smoke, mine dust, iron powder or chemical substances
 - If the vehicle becomes heavily soiled with dust or mud
 - If liquids such as benzene and gasoline are spilled on the paint surface
- If the paint is chipped or scratched, have it repaired immediately.
- To prevent the wheels from corroding, remove any dirt and store in a place with low humidity when storing the wheels.

■ Cleaning the exterior lights

- Wash carefully. Do not use organic substances or scrub with a hard brush. This may damage the surfaces of the lights.
- Do not apply wax to the surfaces of the lights. Wax may cause damage to the lenses.

 NOTICE**■ When using a high pressure car wash**

- Vehicles with rear view monitor system: When washing the vehicle, do not apply intensive bursts of water to the camera or camera area. Doing so may result in the camera malfunctioning.
- Do not spray water directly on the radar which is equipped behind the emblem. Otherwise it may cause the device to be damaged.
- Do not bring the nozzle tip close to boots (rubber or resin manufactured cover), connectors or the following parts. The parts may be damaged if they come into contact with high-pressure water.
 - Traction related parts
 - Steering parts
 - Suspension parts
 - Brake parts
- Keep the cleaning nozzle at least 11.9 in. (30 cm) away from the vehicle body. Otherwise resin section, such as moldings and bumpers, may be deformed and damaged. Also, do not continuously hold the nozzle in the same place.
- Do not spray the lower part of the windshield continuously. If water enters the air conditioning system intake located near the lower part of the windshield, the air conditioning system may not operate correctly.
- Do not wash the underside of the vehicle using a high pressure car washer.

Cleaning and protecting the vehicle interior

The following procedures will help protect your vehicle's interior and keep it in top condition:

Protecting the vehicle interior

- Remove dirt and dust using a vacuum cleaner. Wipe dirty surfaces with a cloth dampened with lukewarm water.
- If dirt cannot be removed, wipe it off with a soft cloth dampened with neutral detergent diluted to approximately 1%.
Wring out any excess water from the cloth and thoroughly wipe off remaining traces of detergent and water.

Cleaning the leather areas

- Remove dirt and dust using a vacuum cleaner.
- Wipe off any excess dirt and dust with a soft cloth dampened with diluted detergent.
Use a diluted water solution of approximately 5% neutral wool detergent.
- Wring out any excess water from the cloth and thoroughly wipe off all remaining traces of detergent.
- Wipe the surface with a dry, soft cloth to remove any remaining moisture. Allow the leather to dry in a shaded and ventilated area.

Cleaning the synthetic leather areas

- Remove dirt and dust using a vacuum cleaner.
- Wipe it off with a soft cloth dampened with neutral detergent diluted to approximately 1%.
- Wring out any excess water from the cloth and thoroughly wipe off remaining traces of detergent and water.

■ Caring for leather areas

Toyota recommends cleaning the interior of the vehicle at least twice a year to maintain the quality of the vehicle's interior.

■ Shampooing the carpets

There are several commercial foaming-type cleaners available. Use a sponge or brush to apply the foam. Rub in overlapping circles. Do not use water. Wipe dirty surfaces and let them dry. Excellent results are obtained by keeping the carpet as dry as possible.

■ Seat belts

Clean with mild soap and lukewarm water using a cloth or sponge. Also check the belts periodically for excessive wear, fraying or cuts.

⚠ WARNING**■ Water in the vehicle**

- Do not splash or spill liquid in the vehicle.
Doing so may cause electrical components etc. to malfunction or catch fire.
- Do not get any of the SRS components or wiring in the vehicle interior wet.
(→P. 38)
An electrical malfunction may cause the airbags to deploy or not function properly, resulting in death or serious injury.

■ Cleaning the interior (especially instrument panel)

Do not use polish wax or polish cleaner. The instrument panel may reflect off the windshield, obstructing the driver's view and leading to an accident, resulting in death or serious injury.

 NOTICE**■ Cleaning detergents**

- Do not use the following types of detergent, as they may discolor the vehicle interior or cause streaks or damage to painted surfaces:
 - Non-seat portions: Organic substances such as benzene or gasoline, alkaline or acidic solutions, dye, and bleach
 - Seats: Alkaline or acidic solutions, such as thinner, benzene, and alcohol
- Do not use polish wax or polish cleaner. The instrument panel's or other interior part's painted surface may be damaged.

■ Preventing damage to leather surfaces

Observe the following precautions to avoid damage to and deterioration of leather surfaces:

- Remove any dust or dirt from leather surfaces immediately.
- Do not expose the vehicle to direct sunlight for extended periods of time. Park the vehicle in the shade, especially during summer.
- Do not place items made of vinyl, plastic, or containing wax on the upholstery, as they may stick to the leather surface if the vehicle interior heats up significantly.

■ Water on the floor

Do not wash the vehicle floor with water.

Vehicle systems such as the audio system may be damaged if water comes into contact with electrical components such as the audio system above or under the floor of the vehicle. Water may also cause the body to rust.

■ When cleaning the inside of the windshield

Do not allow glass cleaner to contact the lens. Also, do not touch the lens. (→P. 233)

■ Cleaning the inside of the rear quarter windows and back window

- Do not use glass cleaner to clean the rear quarter windows and back window, as this may cause damage to the rear window defogger heater wires or antenna. Use a cloth dampened with lukewarm water to gently wipe the window clean. Wipe the window in strokes running parallel to the heater wires or antenna.
- Be careful not to scratch or damage the heater wires or antenna.

Maintenance requirements

To ensure safe and economical driving, day-to-day care and regular maintenance are essential. It is the owner's responsibility to perform regular checks. Toyota recommends the following maintenance:

General maintenance

General maintenance should be performed on a daily basis. This can be done by yourself or by a Toyota dealer.

Scheduled maintenance

Scheduled maintenance should be performed at specified intervals according to the maintenance schedule.

For details about maintenance items and schedules, refer to the "Scheduled Maintenance Guide" or "Owner's Manual Supplement".

Do-it-yourself maintenance

You can perform some maintenance procedures by yourself.

Please be aware that do-it-yourself maintenance may affect warranty coverage.

The use of Toyota Repair Manuals is recommended.

For details about warranty coverage, refer to the separate "Owner's Warranty Information Booklet" or "Owner's Manual Supplement".

Repair and replacement

It is recommended that genuine Toyota parts be used for repairs to ensure performance of each system. If non-Toyota parts are used in replacement or if a repair shop other than a Toyota dealer performs repairs, confirm the warranty coverage.

■ Resetting the message indicating maintenance is required (U.S.A. only)

After the required maintenance is performed according to the maintenance schedule, please reset the message.

To reset the message, follow the procedures described below:

- 1 Turn the engine switch off with the trip meter A reading shown. (→P. 89)
- 2 While pressing the display change button (→P. 89), turn the engine switch to the IGNITION ON mode (do not start the engine because otherwise the reset mode will be canceled).
- 3 Continue to press and hold the button until the trip meter displays "000000".

■ Allow inspection and repairs to be performed by a Toyota dealer

- Toyota technicians are well-trained specialists and are kept up to date with the latest service information. They are well informed about the operations of all systems on your vehicle.
- Keep a copy of the repair order. It proves that the maintenance that has been performed is under warranty coverage. If any problem should arise while your vehicle is under warranty, your Toyota dealer will promptly take care of it.

**WARNING****■ If your vehicle is not properly maintained**

Improper maintenance could result in serious damage to the vehicle and possible death or serious injury.

■ Handling of the battery

- Engine exhaust, some of its constituents, and a wide variety of automobile components contain or emit chemicals known to the State of California to cause cancer and birth defects and other reproductive harm. Work in a well ventilated area.
- Oils, fuels and fluids contained in vehicles as well as waste produced by component wear contain or emit chemicals known to the State of California to cause cancer and birth defects or other reproductive harm. Avoid exposure and wash any affected area immediately.
- Battery posts, terminals and related accessories contain lead and lead compounds which are known to cause brain damage. Wash your hands after handling. (→P. 422)

General maintenance

Listed below are the general maintenance items that should be performed at the intervals specified in the “Owner’s Warranty Information Booklet” or “Owner’s Manual Supplement/Scheduled Maintenance Guide”. It is recommended that any problem you notice should be brought to the attention of your Toyota dealer or qualified service shop for advice.

Engine compartment

Items	Check points
Battery	Check the connections. (→P. 422)
Brake fluid	Is the brake fluid at the correct level? (→P. 419)
Engine coolant	Is the engine coolant at the correct level? (→P. 417)
Engine oil	Is the engine oil at the correct level? (→P. 415)
Exhaust system	There should not be any fumes or strange sounds.
Power steering fluid	Is the power steering fluid at the correct level? (→P. 421)
Radiator/condenser	The radiator and condenser should be free from foreign objects. (→P. 419)
Washer fluid	Is there sufficient washer fluid? (→P. 425)

Vehicle interior

Items	Check points
Accelerator pedal	<ul style="list-style-type: none"> The accelerator pedal should move smoothly (without uneven pedal effort or catching).
Automatic transmission "Park" mechanism	<ul style="list-style-type: none"> When parked on a slope and the shift lever is in P, is the vehicle securely stopped?
Brake pedal	<ul style="list-style-type: none"> Does the brake pedal move smoothly? Does the brake pedal have appropriate clearance from the floor? (→P. 531) Does the brake pedal have the correct amount of free play? (→P. 531)
Brakes	<ul style="list-style-type: none"> The vehicle should not pull to one side when the brakes are applied. The brakes should work effectively. The brake pedal should not feel spongy. The brake pedal should not get too close to the floor when the brakes are applied.
Head restraints	<ul style="list-style-type: none"> Do the head restraints move smoothly and lock securely?
Indicators/buzzers	<ul style="list-style-type: none"> Do the indicators and buzzers function properly?
Lights	<ul style="list-style-type: none"> Do all the lights come on?
Parking brake	<ul style="list-style-type: none"> Does the parking brake pedal move smoothly? When parked on a slope and the parking brake is on, is the vehicle securely stopped?
Seat belts	<ul style="list-style-type: none"> Do the seat belts operate smoothly? The seat belts should not be damaged.
Seats	<ul style="list-style-type: none"> Do the seat controls operate properly?
Steering wheel	<ul style="list-style-type: none"> Does the steering wheel rotate smoothly? Does the steering wheel have the correct amount of free play? There should not be any strange sounds coming from the steering wheel.

Vehicle exterior

Items	Check points
Doors	<ul style="list-style-type: none"> • Do the doors operate smoothly?
Engine hood	<ul style="list-style-type: none"> • Does the engine hood lock system work properly?
Fluid leaks	<ul style="list-style-type: none"> • There should not be any signs of fluid leakage after the vehicle has been parked.
Tires	<ul style="list-style-type: none"> • Is the tire inflation pressure correct? • The tires should not be damaged or excessively worn. • Have the tires been rotated according to the maintenance schedule? • The wheel nuts should not be loose.
Windshield wipers/ rear window wiper	<ul style="list-style-type: none"> • The wiper blades should not show any signs of cracking, splitting, wear, contamination or deformation. • The wiper blades should clear the windshield/rear window without streaking or skipping.

⚠ WARNING**■ If the engine is running**

Turn the engine off and ensure that there is adequate ventilation before performing maintenance checks.

Emission inspection and maintenance (I/M) programs

Some states have vehicle emission inspection programs which include OBD (On Board Diagnostics) checks. The OBD system monitors the operation of the emission control system.

If the malfunction indicator lamp comes on

The OBD system determines that a problem exists somewhere in the emission control system. Your vehicle may not pass the I/M test and may need to be repaired. Contact your Toyota dealer to service the vehicle.

Your vehicle may not pass the I/M test in the following situations:

- When the battery is disconnected or discharged
Readiness codes that are set during ordinary driving are erased. Also, depending on your driving habits, the readiness codes may not be completely set.
- When the fuel tank cap is loose
The malfunction indicator lamp comes on indicating a temporary malfunction and your vehicle may not pass the I/M test.

When the malfunction indicator lamp still remains on after several driving trips

The error code in the OBD system will not be cleared unless the vehicle is driven 40 or more times.

If your vehicle does not pass the I/M test

Contact your Toyota dealer to prepare the vehicle for re-testing.

Do-it-yourself service precautions

If you perform maintenance by yourself, be sure to follow the correct procedure as given in these sections.

Items	Parts and tools
Battery condition (→P. 422)	<ul style="list-style-type: none"> • Warm water • Grease • Conventional wrench (for terminal clamp bolts) • Baking soda
Brake fluid level (→P. 419)	<ul style="list-style-type: none"> • FMVSS No.116 DOT 3 or SAE J1703 brake fluid • Rag or paper towel • Funnel (used only for adding brake fluid)
Engine coolant level (→P. 417)	<ul style="list-style-type: none"> • “Toyota Super Long Life Coolant” or a similar high quality ethylene glycol-based non-silicate, non-amine, non-nitrite and non-borate coolant with long-life hybrid organic acid technology For the U.S.A.: “Toyota Super Long Life Coolant” is pre-mixed with 50% coolant and 50% deionized water. For Canada: “Toyota Super Long Life Coolant” is pre-mixed with 55% coolant and 45% deionized water. • Funnel (used only for adding coolant)
Engine oil level (→P. 415)	<ul style="list-style-type: none"> • “Toyota Genuine Motor Oil” or equivalent • Rag or paper towel • Funnel (used only for adding engine oil)

Items	Parts and tools
Fuses (→P. 450)	<ul style="list-style-type: none"> • Fuse with same amperage rating as original
Light bulbs (→P. 453)	<ul style="list-style-type: none"> • Bulb with same number and wattage rating as original • Phillips-head screwdriver • Flathead screwdriver • Wrench
Power steering fluid level (→P. 421)	<ul style="list-style-type: none"> • Automatic transmission fluid DEXRON® II or III • Rag or paper towel • Clean funnel
Radiator and condenser (→P. 419)	—
Tire inflation pressure (→P. 440)	<ul style="list-style-type: none"> • Tire pressure gauge • Compressed air source
Washer fluid (→P. 425)	<ul style="list-style-type: none"> • Water or washer fluid containing antifreeze (for winter use) • Funnel (used only for adding water or washer fluid)

 **WARNING**

The engine compartment contains many mechanisms and fluids that may move suddenly, become hot, or become electrically energized. To avoid death or serious injury, observe the following precautions.

■ When working on the engine compartment

- Keep hands, clothing and tools away from the moving fan and engine drive belt.
- Be careful not to touch the engine, radiator, exhaust manifold, etc. right after driving as they may be hot. Oil and other fluids may also be hot.
- Do not leave anything that may burn easily, such as paper and rags, in the engine compartment.
- Do not smoke, cause sparks or expose an open flame to fuel or the battery. Fuel and battery fumes are flammable.
- Be extremely cautious when working on the battery. It contains poisonous and corrosive sulfuric acid.

■ Safety glasses

Wear safety glasses to prevent flying or falling material, fluid spray, etc. from getting in your eyes.

 **NOTICE****■ If you remove the air cleaner filter**

Driving with the air cleaner filter removed may cause excessive engine wear due to dirt in the air.

Hood

Release the lock from the inside of the vehicle to open the hood.

- 1 Pull the hood lock release lever.
The hood will pop up slightly.

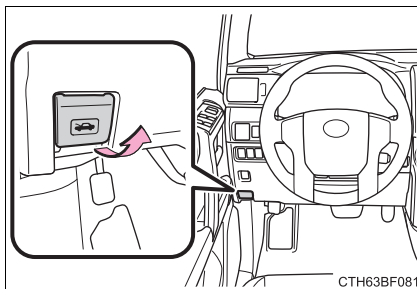

- 2 Push the auxiliary catch lever to the left and lift the hood.

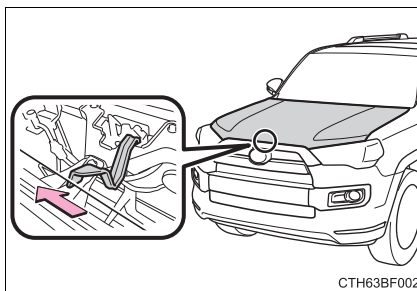

WARNING

■ Pre-driving check

Check that the hood is fully closed and locked.
If the hood is not locked properly, it may open while the vehicle is in motion and cause an accident, which may result in death or serious injury.

Engine compartment

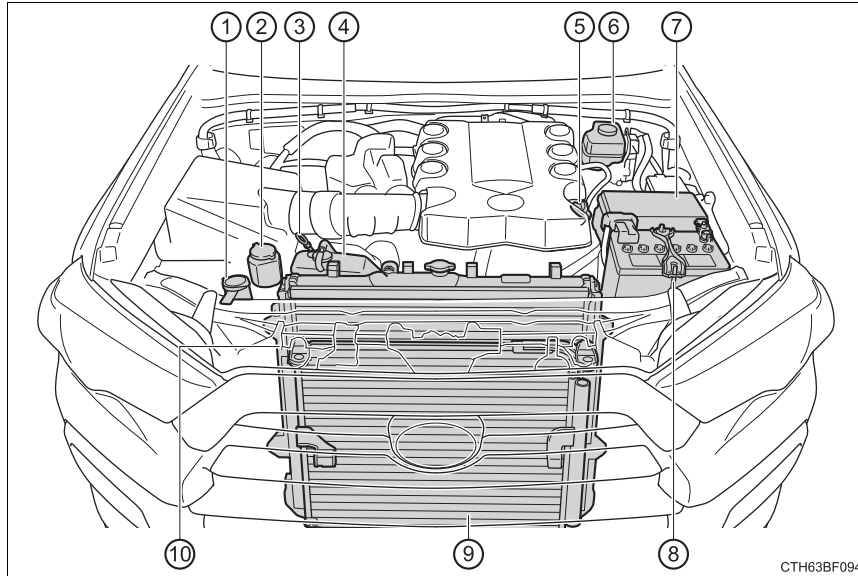

- | | |
|--|-----------------------------------|
| ① Washer fluid tank (→P. 425) | ⑥ Brake fluid reservoir (→P. 419) |
| ② Power steering fluid reservoir (→P. 421) | ⑦ Fuse box (→P. 450) |
| ③ Engine oil level dipstick (→P. 415) | ⑧ Battery (→P. 422) |
| ④ Engine coolant reservoir (→P. 417) | ⑨ Condenser (→P. 419) |
| ⑤ Engine oil filler cap (→P. 416) | ⑩ Radiator (→P. 419) |

Engine compartment cover

■ Removing the engine compartment cover

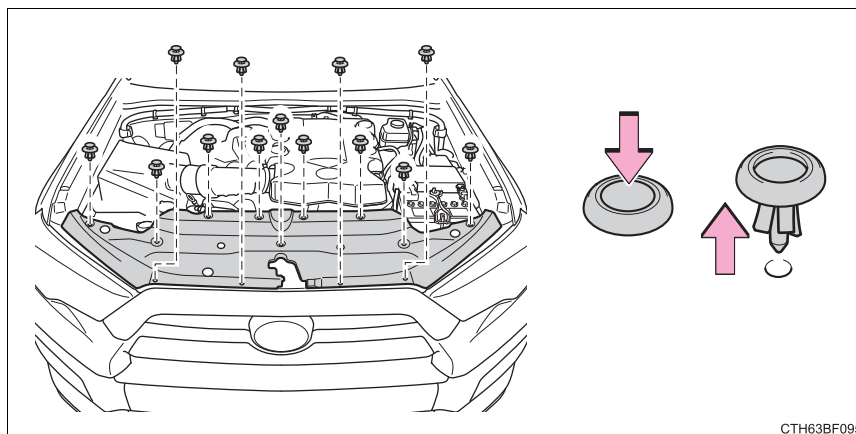

■ Installing the clips

- ① Push up center portion
- ② Insert
- ③ Press

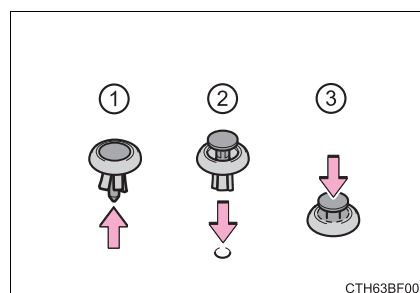

 NOTICE

■ **After installing an engine compartment cover**

Make sure that the cover is securely installed in its original position.

Engine oil

With the engine at operating temperature and turned off, check the oil level on the dipstick.

■ Checking the engine oil

- 1 Park the vehicle on level ground. After warming up the engine and turning it off, wait more than 5 minutes for the oil to drain back into the bottom of the engine.
- 2 Holding a rag under the end, pull the dipstick out.

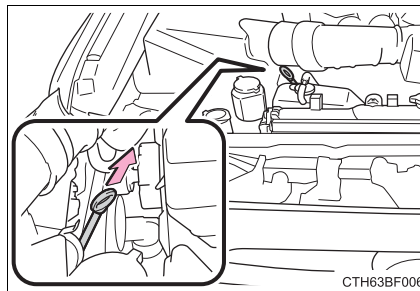

- 3 Wipe the dipstick clean.
- 4 Reinsert the dipstick fully.
- 5 Holding a rag under the end, pull the dipstick out and check the oil level.

- ① Low
- ② Normal
- ③ Excessive

The shape of the dipstick may differ depending on the type of vehicle or engine.

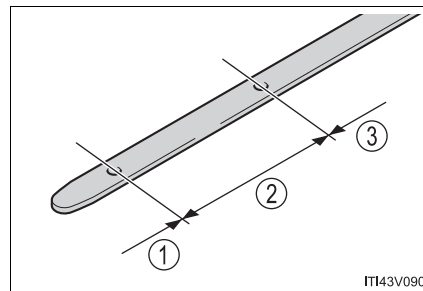

- 6 Wipe the dipstick and reinsert it fully.

■ Adding engine oil

If the oil level is below or near the low level mark, add engine oil of the same type as that already in the engine.

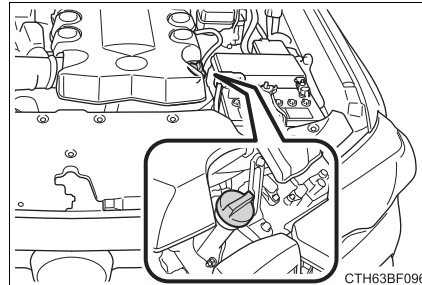

Make sure to check the oil type and prepare the items needed before adding oil.

Engine oil selection	→P. 527
Oil quantity (Low → Full)	1.8 qt. (1.7 L, 1.5 Imp. qt.)
Items	Clean funnel

- 1 Remove the oil filler cap by turning it counterclockwise.
- 2 Add engine oil slowly, checking the dipstick.
- 3 Install the oil filler cap by turning it clockwise.

■ Engine oil consumption

A certain amount of engine oil will be consumed while driving. In the following situations, oil consumption may increase, and engine oil may need to be refilled in between oil maintenance intervals.

- When the engine is new, for example directly after purchasing the vehicle or after replacing the engine
- If low quality oil or oil of an inappropriate viscosity is used
- When driving at high engine speeds or with a heavy load, when towing, or when driving while accelerating or decelerating frequently
- When leaving the engine idling for a long time, or when driving frequently through heavy traffic

⚠ WARNING**■ Used engine oil**

- Used engine oil contains potentially harmful contaminants which may cause skin disorders such as inflammation and skin cancer, so care should be taken to avoid prolonged and repeated contact. To remove used engine oil from your skin, wash thoroughly with soap and water.
- Dispose of used oil and filters only in a safe and acceptable manner. Do not dispose of used oil and filters in household trash, in sewers or onto the ground.
Call your Toyota dealer, service station or auto parts store for information concerning recycling or disposal.
- Do not leave used engine oil within the reach of children.

⚠ NOTICE**■ To prevent serious engine damage**

Check the oil level on a regular basis.

■ When replacing the engine oil

- Be careful not to spill engine oil on the vehicle components.
- Avoid overfilling, or the engine could be damaged.
- Check the oil level on the dipstick every time you refill the vehicle.
- Be sure the engine oil filler cap is properly tightened.

Engine coolant

The coolant level is satisfactory if it is between the “F” and “L” lines on the reservoir when the engine is cold.

- ① Reservoir cap
- ② “F” line
- ③ “L” line

If the level is on or below the “L” line, add coolant up to the “F” line.
(→P. 519)

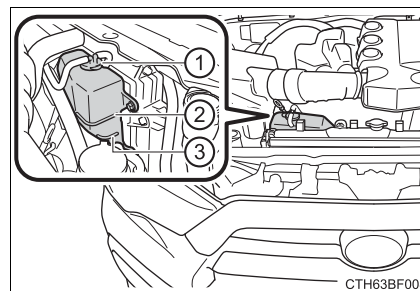

■ **Coolant selection**

Only use “Toyota Super Long Life Coolant” or a similar high quality ethylene glycol based non-silicate, non-amine, non-nitrite, and non-borate coolant with long-life hybrid organic acid technology.

U.S.A.:

“Toyota Super Long Life Coolant” is a mixture of 50% coolant and 50% deionized water. (Minimum temperature: -31°F [-35°C])

Canada:

“Toyota Super Long Life Coolant” is a mixture of 55% coolant and 45% deionized water. (Minimum temperature: -44°F [-42°C])

For more details about engine coolant, contact your Toyota dealer.

■ **If the coolant level drops within a short time of replenishing**

Visually check the radiator, hoses, engine coolant reservoir caps, drain cock and water pump.

If you cannot find a leak, have your Toyota dealer test the cap and check for leaks in the cooling system.

 **WARNING**

■ **When the engine is hot**

Do not remove the engine coolant reservoir cap or the radiator cap.

(→P. 520)

The cooling system may be under pressure and may spray hot coolant if the cap is removed, causing serious injuries, such as burns.

 **NOTICE**

■ **When adding coolant**

Coolant is neither plain water nor straight antifreeze. The correct mixture of water and antifreeze must be used to provide proper lubrication, corrosion protection and cooling. Be sure to read the antifreeze or coolant label.

■ **If you spill coolant**

Be sure to wash it off with water to prevent it from damaging parts or paint.

Radiator and condenser

Check the radiator and condenser and clear away any foreign objects. If either of the above parts is extremely dirty or you are not sure of their condition, have your vehicle inspected by your Toyota dealer.

WARNING

■ When the engine is hot

Do not touch the radiator or condenser as they may be hot and cause serious injuries, such as burns.

Brake fluid

■ Checking fluid level

The brake fluid level should be between the “MAX” and “MIN” lines on the tank.

- ① “MAX” line
- ② “MIN” line

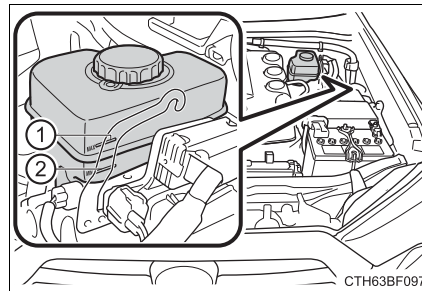

■ Adding fluid

Make sure to check the fluid type and prepare the necessary item.

Fluid type	FMVSS No.116 DOT 3 or SAE J1703 brake fluid
Items	Clean funnel

■ Refilling brake fluid

- 1 Turn the engine switch off.
- 2 Depress the brake pedal more than 40 times.
- 3 Remove the reservoir cap by hand. Add brake fluid up to the “MAX” line.

If you do not follow the procedure above, the reservoir may overflow.

■ Brake fluid can absorb moisture from the air

Excess moisture in the brake fluid can cause a dangerous loss of braking efficiency. Use only newly opened brake fluid.

 WARNING**■ When filling the reservoir**

Take care as brake fluid can harm your hands and eyes and damage painted surfaces.

If fluid gets on your hands or in your eyes, flush the affected area with clean water immediately.

If you still experience discomfort, see a doctor.

 NOTICE**■ If the fluid level is low or high**

It is normal for the brake fluid level to go down slightly as the brake pads wear out or when the fluid level in the accumulator is high.

If the reservoir needs frequent refilling, there may be a serious problem.

Power steering fluid

■ Fluid level

The fluid level should be within the appropriate range.

- ① Full (when cold)
- ② Add fluid (when cold)
- ③ Full (when hot)
- ④ Add fluid (when hot)

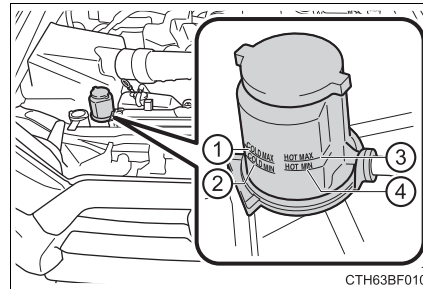

Hot: Vehicle has been driven around 50 mph (80 km/h) for 20 minutes, or slightly longer in frigid temperatures. (Fluid temperature, 140°F - 175°F [60°C - 80°C]).

Cold: Engine has not been run for about 5 hours. (Room temperature, 50°F - 85°F [10°C - 30°C]).

■ Checking the fluid level

Make sure to check the fluid type and prepare the necessary items.

Fluid type	Automatic transmission fluid DEXRON® II or III
Items	Rag or paper, clean funnel (only for adding fluid)

- ① Clean all dirt off the reservoir.
- ② Remove the cap by turning it counterclockwise.
- ③ Wipe the dipstick clean.
- ④ Reinstall the cap and remove it again.
- ⑤ Check the fluid level.

⚠ WARNING**■ When checking the reservoir**

Take care as the reservoir may be hot.

⚠ NOTICE**■ When adding fluid**

Avoid overfilling, or the power steering may be damaged.

■ After replacing the reservoir cap

Check the steering box case, vane pump and hose connections for leaks or damage.

Battery

Check the battery as follows.

■ Battery exterior

Make sure that the battery terminals are not corroded and that there are no loose connections, cracks, or loose clamps.

- ① Terminals
- ② Hold-down clamp

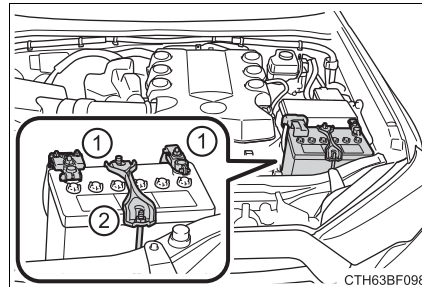
**■ Before recharging**

When recharging, the battery produces hydrogen gas which is flammable and explosive. Therefore, observe the following before recharging:

- If recharging with the battery installed on the vehicle, be sure to disconnect the ground cable.
- Make sure the power switch on the charger is off when connecting and disconnecting the charger cables to the battery.

■ After recharging/reconnecting the battery

The engine may not start. Follow the procedure below to initialize the system.

- 1 Shift the shift lever to P.
- 2 Open and close any of the doors.
- 3 Restart the engine.
 - Unlocking the doors using the smart key system may not be possible immediately after reconnecting the battery. If this happens, use the wireless remote control or the mechanical key to lock/unlock the doors.
 - Start the engine with the engine switch in ACCESSORY mode. The engine may not start when the engine switch turned from off. However, the engine will operate normally from the second attempt.
 - The engine switch mode is recorded by the vehicle. If the battery is reconnected, the vehicle will return the engine switch mode to the status it was in before the battery was disconnected. Make sure to turn off the engine before disconnect the battery. Take extra care when connecting the battery if the engine switch mode prior to discharge is unknown.

If the system will not start even after multiple attempts, contact your Toyota dealer.

WARNING

■ Chemicals in the battery

Batteries contain poisonous and corrosive sulfuric acid and may produce hydrogen gas which is flammable and explosive. To reduce the risk of death or serious injury, take the following precautions while working on or near the battery:

- Do not cause sparks by touching the battery terminals with tools.
- Do not smoke or light a match near the battery.
- Avoid contact with eyes, skin and clothes.
- Never inhale or swallow electrolyte.
- Wear protective safety glasses when working near the battery.
- Keep children away from the battery.

 **WARNING****■ Where to safely charge the battery**

Always charge the battery in an open area. Do not charge the battery in a garage or closed room where there is insufficient ventilation.

■ How to recharge the battery

Only perform a slow charge (5 A or less). The battery may explode if charged at a quicker rate.

■ Emergency measures regarding electrolyte

- If electrolyte gets in your eyes
Flush your eyes with clean water for at least 15 minutes and get immediate medical attention. If possible, continue to apply water with a sponge or cloth while traveling to the nearest medical facility.
- If electrolyte gets on your skin
Wash the affected area thoroughly. If you feel pain or burning, get medical attention immediately.
- If electrolyte gets on your clothes
It can soak through clothing on to your skin. Immediately take off the clothing and follow the procedure above if necessary.
- If you accidentally swallow electrolyte
Drink a large quantity of water or milk. Get emergency medical attention immediately.

 **NOTICE****■ When recharging the battery**

Never recharge the battery while the engine is running. Also, be sure all accessories are turned off.

Washer fluid

▶ Type A

If any washer does not work or the warning message appears on the multi-information display, the washer tank may be empty. Add washer fluid.

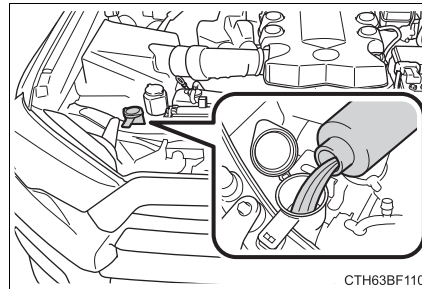

▶ Type B

If the washer fluid level is at "LOW", add washer fluid.

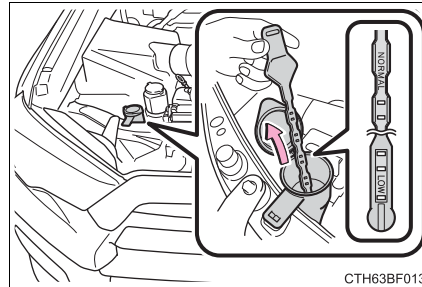

■ Using the gauge (Type B only)

The washer fluid level can be checked by observing the position of the level on the liquid-covered holes in the gauge. If the level falls below the second hole from the bottom (the "LOW" position), refill the washer fluid.

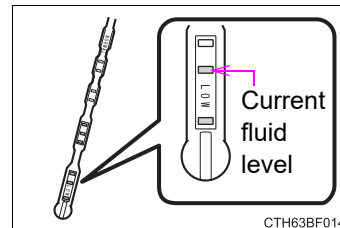

 **WARNING****■ When adding washer fluid**

Do not add washer fluid when the engine is hot or running as washer fluid contains alcohol and may catch fire if spilled on the engine etc.

 **NOTICE****■ Do not use any fluid other than washer fluid**

Do not use soapy water or engine antifreeze instead of washer fluid. Doing so may cause streaking on the vehicle's painted surfaces, as well as damaging the pump leading to problems of the washer fluid not spraying.

■ Diluting washer fluid

Dilute washer fluid with water as necessary.
Refer to the freezing temperatures listed on the label of the washer fluid bottle.

Tires

Replace or rotate tires in accordance with maintenance schedules and treadwear.

Checking tires

Check if the treadwear indicators are showing on the tires. Also check the tires for uneven wear, such as excessive wear on one side of the tread.

Check the spare tire condition and pressure if not rotated.

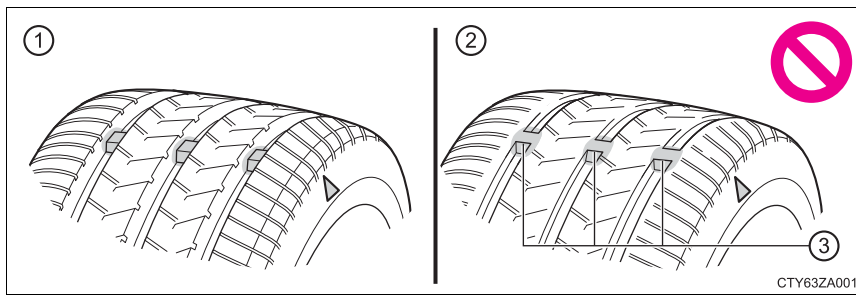

- ① New tread
- ② Worn tread
- ③ Treadwear indicator

The location of treadwear indicators is shown by a "TWI" or "Δ" mark, etc., molded into the sidewall of each tire.

Replace the tires if the treadwear indicators are showing on a tire.

Tire rotation

► Vehicles without P245/60R20 tires

Rotate the tires in the order shown.

To equalize tire wear and extend tire life, Toyota recommends that tire rotation is carried out at the same interval as tire inspection.

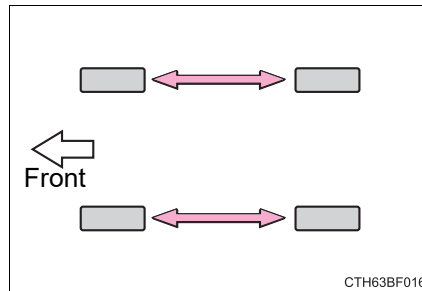

► Vehicles with P245/60R20 tires

Rotate the tires in the order shown.

To equalize tire wear and extend tire life, Toyota recommends that tire rotation is carried out at the same interval as tire inspection.

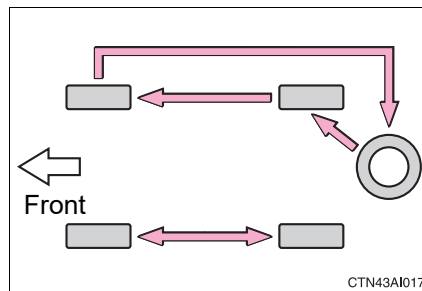

Tire pressure warning system

Your vehicle is equipped with a tire pressure warning system that uses tire pressure warning valve and transmitters to detect low tire inflation pressure before serious problems arise.

- The tire pressure detected by the tire pressure warning system can be displayed on the multi-information display.

*: If equipped

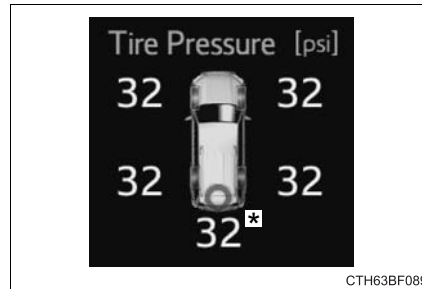

- If the tire pressure drops below a predetermined level, the driver is warned by a screen display and a warning light. (→P. 481)

*: If equipped

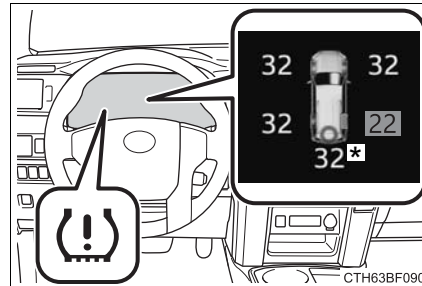

◆ Installing tire pressure warning valve and transmitters

When replacing the tires or wheels, the tire pressure warning valve and transmitters must be installed to the wheels which will be installed to the vehicle.

When new tire pressure warning valve and transmitters are installed, new ID codes must be registered in the tire pressure warning computer and the tire pressure warning system must be initialized. (→P. 431)



◆ Initializing the tire pressure warning system

■ The tire pressure warning system must be initialized in the following circumstances:

- When the tire inflation pressure is changed such as when changing traveling speed or load weight.
- When the tire inflation pressure is changed such as when the tire size is changed.
- When rotating the tires.
- After performing the transmitter ID code registration procedure. (→P. 431)

When the tire pressure warning system is initialized, the current tire inflation pressure is set as the benchmark pressure.

■ How to initialize the tire pressure warning system

- 1 Park the vehicle in a safe place and turn the engine switch off.
The initialization procedure cannot be started while the vehicle is moving.
- 2 Adjust the tire inflation pressure to the specified cold tire inflation pressure level. (→P. 532)
Make sure to adjust the tire pressure to the specified cold tire inflation pressure level. The tire pressure warning system will operate based on this pressure level.
- 3 Start the engine. (→P. 199)
- 4 Select  on the multi-information display using the meter control switches on the steering wheel. (→P. 96)
- 5 Select “Vehicle Settings” and then press and hold .
- 6 Select “TPWS” and then press .

- 7 Select "Set Pressure" then press and hold  until the tire pressure warning light blinks 3 times.

Then a message will be displayed on the multi-information display.

"---" will be displayed on the multi-information display for the inflation pressure of each tire while initialization is being performed.

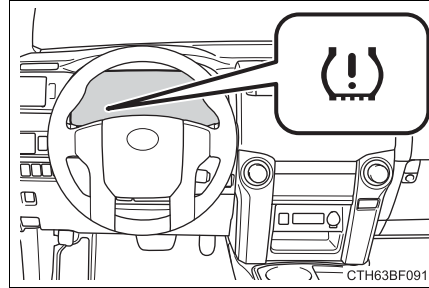

- 8 Drive straight (with occasional left and right turns) at approximately 25 mph (40 km/h) or more for approximately 10 to 30 minutes.

Initialization is complete when the position of each tire is determined and the inflation pressure of each tire is displayed on the multi-information display.



Initialization may take longer than approximately 1 hour in certain situations, such as when the vehicle is stopped for a long time at traffic lights, etc. (→P. 436)

◆ Registering ID codes

Every tire pressure warning valve and transmitter has a unique ID code. When replacing a tire pressure warning valve and transmitter, it is necessary to register the ID codes.

The ID codes can be registered on  of the multi-information display.

■ How to register the ID codes

- 1 Select  on the multi-information display using the meter control switches on the steering wheel. (→P. 96)
- 2 Select “Vehicle Settings” and then press and hold .
- 3 Select “TPWS” and then press .

- 4 Select “Change Wheel Set” then press and hold  until the tire pressure warning light blinks slowly 3 times.

Then a message will be displayed on the multi-information display.

When registration is being performed, the tire pressure warning light will blink for approximately 1 minute then illuminate and “---” will be displayed for the inflation pressure of each tire on the multi-information display.

- 5 Drive straight (with occasional left and right turns) at approximately 25 mph (40 km/h) or more for approximately 10 to 30 minutes.

Registration is complete when the tire pressure warning light turns off and the inflation pressure of each tire is displayed on the multi-information display.

Registration may take longer than approximately 1 hour in certain situations, such as when the vehicle is stopped for a long time at traffic lights, etc. (→P. 437)

After registering the ID codes, make sure to initialize the tire pressure warning system. (→P. 430)

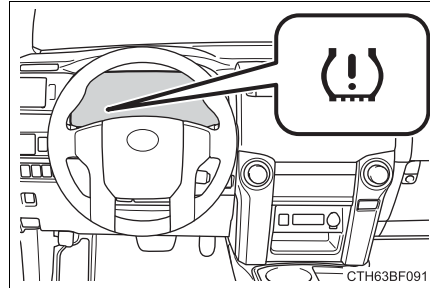

■ When to replace your vehicle's tires

Tires should be replaced if:

- The treadwear indicators are showing on a tire.
- You have tire damage such as cuts, splits, cracks deep enough to expose the fabric, and bulges indicating internal damage
- A tire goes flat repeatedly or cannot be properly repaired due to the size or location of a cut or other damage

If you are not sure, consult with your Toyota dealer.

■ Replacing tires and wheels

If the ID code of the tire pressure warning valve and transmitter is not registered, the tire pressure warning system will not work properly. After driving for about 20 minutes, the tire pressure warning light blinks for 1 minute and stays on to indicate a system malfunction.

■ Tire life

Any tire over 6 years old must be checked by a qualified technician even if it has seldom or never been used or damage is not obvious.

■ Routine tire inflation pressure checks

The tire pressure warning system does not replace routine tire inflation pressure checks. Make sure to check tire inflation pressure as part of your routine of daily vehicle checks.

■ Maximum load of tire

Check that the number given by dividing the maximum load by 1.10 of the replacement tire is greater than 1/2 of the Gross Axle Weight Ratings (GAWR) of either the front axle or the rear axle, whichever is greater.

For the GAWR, see the Certification Label. For the maximum load of the tire, see the load limit at maximum cold tire inflation pressure mentioned on the sidewall of the tire. (→P. 537)

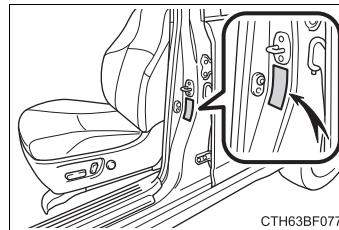

■ Tire types**● Summer tires**

Summer tires are high-speed performance tires best suited to highway driving under dry conditions. Since summer tires do not have the same traction performance as snow tires, summer tires are inadequate for driving on snow-covered or icy roads. For driving on snow-covered roads or icy roads, the use of snow tires is recommended. When installing snow tires, be sure to replace all four tires.

● All season tires

All season tires are designed to provide better traction in snow and to be adequate for driving in most winter conditions as well as for use year-round. All season tires, however, do not have adequate traction performance compared with snow tires in heavy or loose snow. Also, all season tires fall short in acceleration and handling performance compared with summer tires in highway driving.

● Snow tires

For driving on snow-covered roads or icy roads, we recommend using snow tires. If you need snow tires, select tires of the same size, construction and load capacity as the originally installed tires. Since your vehicle has radial tires as original equipment, make sure your snow tires also have radial construction. Do not install studded tires without first checking local regulations for possible restrictions. Snow tires should be installed on all wheels. (→P. 331)

■ If the tread on snow tires wears down below 0.16 in. (4 mm)

The effectiveness of the tires as snow tires is lost.

■ Warning performance of the tire pressure warning system

The warning of the tire pressure warning system will change in accordance with the conditions under which it was initialized. For this reason, the system may give a warning even if the tire pressure does not reach a low enough level, or if the pressure is higher than the pressure that was adjusted to when the system was initialized.

■ Situations in which the tire pressure warning system may not operate properly

- In the following cases, the tire pressure warning system may not operate properly.
 - If non-genuine Toyota wheels are used.
 - A tire has been replaced with a tire that is not an OE (Original Equipment) tire.
 - A tire has been replaced with a tire that is not of the specified size.
 - Tire chains etc. are equipped.
 - If a window tint that affects the radio wave signals is installed.
 - If there is a lot of snow or ice on the vehicle, particularly around the wheels or wheel housings.
 - If the tire inflation pressure is extremely higher than the specified level.
 - If the spare tire is in a location subject to poor radio wave signal reception.
 - If a large metallic object which can interfere with signal reception is put near the spare tire.
 - If tires not equipped with the tire pressure warning valves and transmitters are used.
 - If the ID code on the tire pressure warning valves and transmitters is not registered in the tire pressure warning computer.
- Performance may be affected in the following situations.
 - Near a TV tower, electric power plant, gas station, radio station, large display, airport or other facility that generates strong radio waves or electrical noise
 - When carrying a portable radio, cellular phone, cordless phone or other wireless communication device
- When the vehicle is parked, the time taken for the warning to start or go off could be extended.
- When tire inflation pressure declines rapidly for example when a tire has burst, the warning may not function.

■ The initialization operation

- Make sure to carry out initialization after adjusting the tire inflation pressure.
Also, make sure the tires are cold before carrying out initialization or tire inflation pressure adjustment.
- If you have accidentally turned the engine switch off during initialization, it is not necessary to press the reset switch again as initialization will restart automatically when the engine switch has been turned to IGNITION ON mode for the next time.
- If you accidentally press the reset switch when initialization is not necessary, adjust the tire inflation pressure to the specified level when the tires are cold, and conduct initialization again.
- While the position of each tire is being determined and the inflation pressures are not being displayed on the multi-information display, if the inflation pressure of a tire drops, the tire pressure warning light will come on.

■ When initialization of the tire pressure warning system has failed

- Do not move the vehicle backward during initialization. Initialization is started again from the beginning and it may take longer than usual.
 - Initialization may take longer to complete if the vehicle is driven on an unpaved road.
When performing initialization, drive on a paved road if possible. Depending on the driving environment and condition of the tires, initialization will be completed in approximately 10 to 30 minutes.
 - If initialization is not complete after driving approximately 30 minutes, continue driving for a while.
 - If initialization is not complete after driving approximately 1 hour, park the vehicle in a safe place for approximately 20 minutes. Then drive straight (with occasional left and right turns) at approximately 25 mph (40 km/h) or more* for approximately 10 to 30 minutes.
 - If initialization is still not complete, have the vehicle inspected by your Toyota dealer.
- *: Except when making a left/right turn
- In the following situations, the tire inflation pressure will not be recorded and the system will not operate properly. Perform initialization again.
 - When operating the tire pressure warning reset switch, the tire pressure warning light does not blink 3 times.
 - After performing initialization, the tire pressure warning light blinks for 1 minute then stays on after driving for about 20 minutes.

■ When ID code registration has failed

- Registration may take long time or the ID codes may not be registered in the following situations.
 - When the vehicle is moved backward during registration. Registration is started again from the beginning and it may take longer than usual.
 - When another vehicle is running the side of the vehicle such as in heavy traffic. It may take longer to detect the vehicle' tire pressure warning valves and transmitters.
 - If tire pressure warning valves and transmitters are in the vehicle. The ID codes may not be registered.
- When performing registration, drive on a paved road if possible. Depending on the driving environment and condition of the tires, registration will be completed in approximately 10 to 30 minutes.
 - If registration is not complete after driving approximately 30 minutes, continue driving for a while.
 - If registration is not complete after driving approximately 1 hour, park the vehicle in a safe place for approximately 20 minutes. Then drive straight (with occasional left and right turns) at approximately 40 km/h (25 mph) or more* for approximately 10 to 30 minutes. If registration is still not complete, have the vehicle inspected by your Toyota dealer.
- *: Except when making a left/right turn
- When the tire pressure warning light does not blink slowly 3 times, the ID code will not be registered and the system will not operate properly. Perform registration again.

■ When registering ID codes

- Initialize the tire pressure warning system after ID code registration. Initialization is disabled if the system was initialized before registration.
- After ID code registration, the tires are hot by driving. Initialize the tire pressure warning system after the tires become cold.

■ Canceling the change wheel set mode

- If turning the engine switch off when in the change wheel set mode before driving, the change wheel set mode is canceled.
- After driving when in the change wheel set mode, the change wheel set mode cannot be canceled. To cancel the mode, perform the procedure for ID code registration again and turn the engine switch off before driving.
- If the change wheel set mode is canceled, the ID codes that have already been registered are communicated. When communication is finished, the tire pressure warning light will turn off.

 **WARNING****■ When inspecting or replacing tires**

Observe the following precautions to prevent accidents.

Failure to do so may cause damage to parts of the drive train as well as dangerous handling characteristics, which may lead to an accident resulting in death or serious injury.

- Do not mix tires of different makes, models or tread patterns.
Also, do not mix tires of remarkably different treadwear.
- Do not use tire sizes other than those recommended by Toyota.
- Do not mix differently constructed tires (radial, bias-belted or bias-ply tires).
- Do not mix summer, all season and snow tires.
- Do not use tires that have been used on another vehicle.
Do not use tires if you do not know how they were used previously.

■ When initializing the tire pressure warning system

Do not operate the tire pressure warning reset switch without first adjusting the tire inflation pressure to the specified level. Otherwise, the tire pressure warning light may not come on even if the tire inflation pressure is low, or it may come on when the tire inflation pressure is actually normal.

 NOTICE**■ Repairing or replacing tires, wheels, tire pressure warning valves, transmitters and tire valve caps**

- When removing or fitting the wheels, tires or the tire pressure warning valves and transmitters, contact your Toyota dealer as the tire pressure warning valves and transmitters may be damaged if not handled correctly.
- Make sure to install the tire valve caps. If the tire valve caps are not installed, water could enter the tire pressure warning valves and the tire pressure warning valves could be bound.
- When replacing tire valve caps, do not use tire valve caps other than those specified. The cap may become stuck.

■ To avoid damage to the tire pressure warning valves and transmitters

When a tire is repaired with liquid sealants, the tire pressure warning valve and transmitter may not operate properly. If a liquid sealant is used, contact your Toyota dealer or other qualified service shop as soon as possible. Make sure to replace the tire pressure warning valve and transmitter when replacing the tire. (→P. 430)

■ Driving on rough roads

Take particular care when driving on roads with loose surfaces or pot-holes.

These conditions may cause losses in tire inflation pressure, reducing the cushioning ability of the tires. In addition, driving on rough roads may cause damage to the tires themselves, as well as the vehicle's wheels and body.

■ If tire inflation pressure of each tire becomes low while driving

Do not continue driving, or your tires and/or wheels may be ruined.

Tire inflation pressure

Tire inflation pressure

The recommended cold tire inflation pressure and tire size are displayed on the tire and loading information label. (→P. 537)

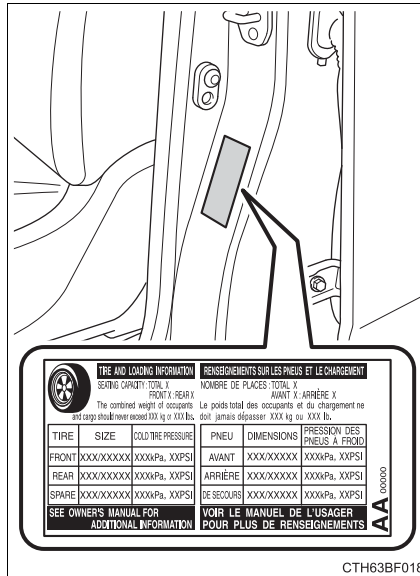

CTH63BF018

Inspection and adjustment procedure

- ① Tire valve
- ② Tire pressure gauge

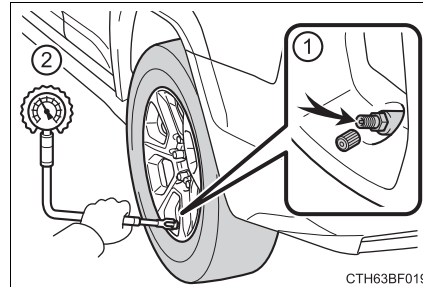

- 1 Remove the tire valve cap.
- 2 Press the tip of the tire pressure gauge onto the tire valve.
- 3 Read the pressure using the gauge gradations.
- 4 If the tire inflation pressure is not at the recommended level, adjust the pressure.
If you add too much air, press the center of the valve to deflate.
- 5 After completing the tire inflation pressure measurement and adjustment, apply soapy water to the valve and check for leakage.
- 6 Put the tire valve cap back on.

■ Tire inflation pressure check interval

You should check tire inflation pressure every two weeks, or at least once a month.

Do not forget to check the spare.

■ Effects of incorrect tire inflation pressure

Driving with incorrect tire inflation pressure may result in the following:

- Reduced fuel economy
- Reduced driving comfort and poor handling
- Reduced tire life due to wear
- Reduced safety
- Damage to the drive train

If a tire needs frequent inflating, have it checked by your Toyota dealer.

■ Instructions for checking tire inflation pressure

When checking tire inflation pressure, observe the following:

- Check only when the tires are cold.
If your vehicle has been parked for at least 3 hours or has not been driven for more than 1 mile or 1.5 km, you will get an accurate cold tire inflation pressure reading.
- Always use a tire pressure gauge.
It is difficult to judge if a tire is properly inflated based only on its appearance.
- It is normal for the tire inflation pressure to be higher after driving as heat is generated in the tire. Do not reduce tire inflation pressure after driving.
- Never exceed the vehicle capacity weight.
Passengers and luggage weight should be placed so that the vehicle is balanced.

⚠ WARNING**■ Proper inflation is critical to save tire performance**

Keep your tires properly inflated.

If the tires are not properly inflated, the following conditions may occur which could lead to an accident resulting in death or serious injury:

- Excessive wear
- Uneven wear
- Poor handling
- Possibility of blowouts resulting from overheated tires
- Air leaking from between tire and wheel
- Wheel deformation and/or tire damage
- Greater possibility of tire damage while driving (due to road hazards, expansion joints, sharp edges in the road, etc.)

⚠ NOTICE**■ When inspecting and adjusting tire inflation pressure**

Be sure to put the tire valve caps back on.

If a valve cap is not installed, dirt or moisture may get into the valve and cause an air leak, resulting in decreased tire inflation pressure.

Wheels

If a wheel is bent, cracked or heavily corroded, it should be replaced. Otherwise, the tire may separate from the wheel or cause a loss of handling control.

Wheel selection

When replacing wheels, care should be taken to ensure that they are equivalent to those removed in load capacity, diameter, rim width and inset*.

Replacement wheels are available at your Toyota dealer.

*: Conventionally referred to as "offset".

Toyota does not recommend using the following:

- Wheels of different sizes or types
- Used wheels
- Bent wheels that have been straightened

Aluminum wheel precautions

- Use only Toyota wheel nuts and wrenches designed for use with your aluminum wheels.
- When rotating, repairing or changing your tires, check that the wheel nuts are still tight after driving 1000 miles (1600 km).
- Be careful not to damage the aluminum wheels when using tire chains.
- Use only Toyota genuine balance weights or equivalent and a plastic or rubber hammer when balancing your wheels.

■ When replacing wheels

The wheels of your vehicle are equipped with tire pressure warning valves and transmitters that allow the tire pressure warning system to provide advance warning in the event of a loss in tire inflation pressure. Whenever wheels are replaced, tire pressure warning valves and transmitters must be installed. (→P. 430)

 **WARNING****■ When replacing wheels**

- Do not use wheels that are a different size from those recommended in the Owner's Manual, as this may result in a loss of handling control.
- Never use an inner tube in a leaking wheel which is designed for a tubeless tire. Doing so may result in an accident, causing death or serious injury.

■ When installing the wheel nuts

Never use oil or grease on the wheel bolts or wheel nuts. Oil and grease may cause the wheel nuts to be excessively tightened, leading to bolt or disc wheel damage. In addition, the oil or grease can cause the wheel nuts to loosen and the wheel may fall off, causing an accident and resulting in death or serious injury. Remove any oil or grease from the wheel bolts or wheel nuts.

 **NOTICE****■ Replacing tire pressure warning valves and transmitters**

- Because tire repair or replacement may affect the tire pressure warning valves and transmitters, make sure to have tires serviced by your Toyota dealer or other qualified service shop. In addition, make sure to purchase your tire pressure warning valves and transmitters at your Toyota dealer.
- Ensure that only genuine Toyota wheels are used on your vehicle. Tire pressure warning valves and transmitters may not work properly with non-genuine wheels.

Air conditioning filter

The air conditioning filter must be changed regularly to maintain air conditioning efficiency.

Removal method

- 1 Turn the engine switch off.
- 2 Open the glove box and remove the cover.

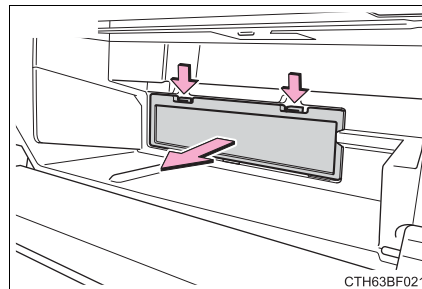

- 3 Remove the filter cover.

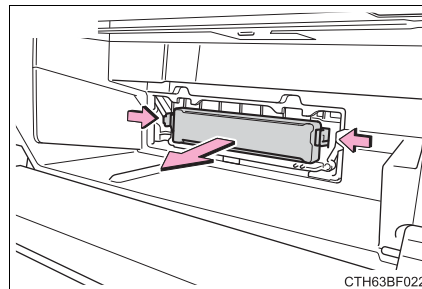

- 4 Remove the air conditioning filter and replace it with a new one.

The “↑UP” marks shown on the filter should be pointing up.

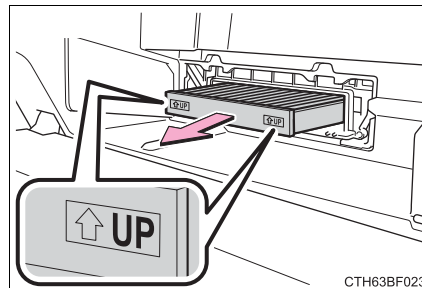

■ Checking interval

Inspect and replace the air conditioning filter according to the maintenance schedule. In dusty areas or areas with heavy traffic flow, early replacement may be required. (For scheduled maintenance information, please refer to the “Schedule maintenance guide” or “Owner’s Manual Supplement”.)

■ If air flow from the vents decreases dramatically

The filter may be clogged. Check the filter and replace if necessary.

**NOTICE****■ When using the air conditioning system**

Make sure that a filter is always installed.

Using the air conditioning system without a filter may cause damage to the system.

Electronic key battery

Replace the battery with a new one if it is depleted.

You will need the following items:

- Flathead screwdriver
- Small flathead screwdriver
- Lithium battery CR2032

Replacing the battery

- 1 Release the lock and remove the mechanical key.

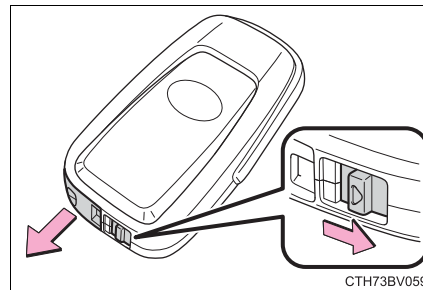

- 2 Remove the key cover.

To prevent damage to the key, cover the tip of the flathead screwdriver with a rag.

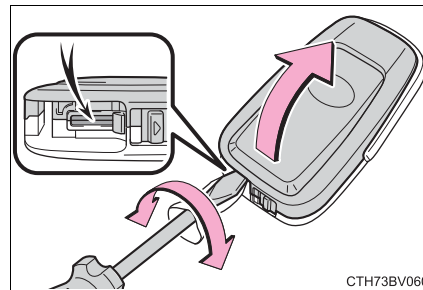

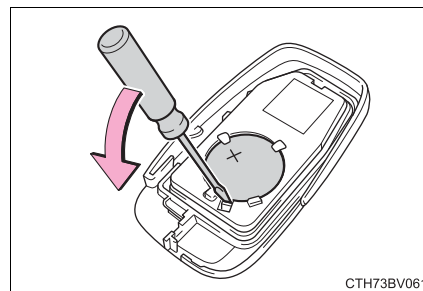

- 3 Remove the depleted battery using a small flathead screwdriver.

When removing the cover, the electronic key module may stick to the cover and the battery may not be visible. In this case, remove the electronic key module in order to remove the battery.



Insert a new battery with the "+" terminal facing up.

- 4 When installing the key cover and mechanical key, install by conducting 2 and 1 with the directions reversed.
- 5 Operate the  or  switch and check that the doors can be locked/unlocked.

■ When replacing the key battery

Be careful not to lose the battery or any other small parts.

■ Use a CR2032 lithium battery

- Batteries can be purchased at your Toyota dealer, local electrical appliance shops or camera stores.
- Replace only with the same or equivalent type recommended by the manufacturer.
- Dispose of used batteries according to local laws.

■ If the electronic key battery is depleted

The following symptoms may occur:

- The smart key system and wireless remote control will not function properly.
- The operational range will be reduced.

⚠ WARNING**■ Battery precautions**

Observe the following precautions.

Failure to do so may result in death or serious injury.

- Do not swallow the battery. Doing so may cause chemical burns.
- A coin battery or button battery is used in the wireless remote control/electronic key. If a battery is swallowed, it may cause severe chemical burns in as little as 2 hours and may result in death or serious injury.
- Keep away new and removed batteries from children.
- If the cover cannot be firmly closed, stop using the wireless remote control/electronic key and stow the key in the place where children cannot reach, and then contact your Toyota dealer.
- If you accidentally swallow a battery or put a battery into a part of your body, get emergency medical attention immediately.

■ To prevent battery explosion or leakage of flammable liquid or gas

- Replace the battery with a new battery of the same type. If a wrong type of battery is used, it may explode.
- Do not expose batteries to extremely low pressure due to high altitude or extremely high temperatures.
- Do not burn, break or cut a battery.

 NOTICE**■ For normal operation after replacing the battery**

Observe the following precautions to prevent accidents:

- Always work with dry hands.
Moisture may cause the battery to rust.
- Do not touch or move any other component inside the remote control.
- Do not bend either of the battery terminals.

Checking and replacing fuses

If any of the electrical components do not operate, a fuse may have blown. If this happens, check and replace the fuses as necessary.

- 1 Turn the engine switch off.
- 2 Open the Fuse box cover.

► Engine compartment

Push the tab in and lift the lid off.

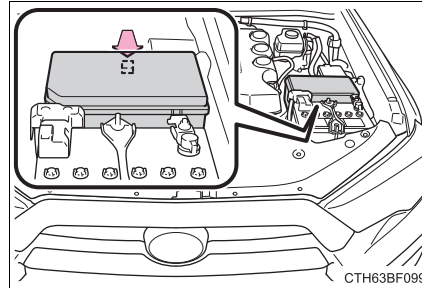

► Driver's side instrument panel

Remove the lid.

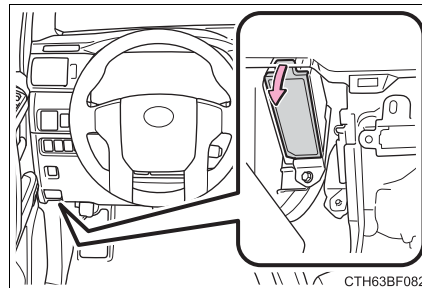

- 3 Remove the fuse with the pull-out tool.

Only type A fuse can be removed using the pullout tool.

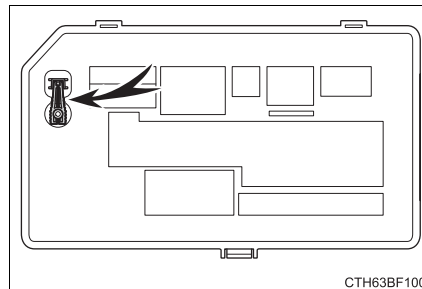

4 Check if the fuse is blown.

- ① Normal fuse
- ② Blown fuse

Type A, B, C, D, E:

Replace the blown fuse with a new fuse of an appropriate amperage rating. The amperage rating can be found on the fuse box lid.

Type F:

Contact your Toyota dealer.

▶ Type A

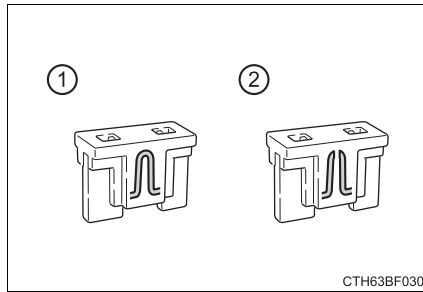

▶ Type B

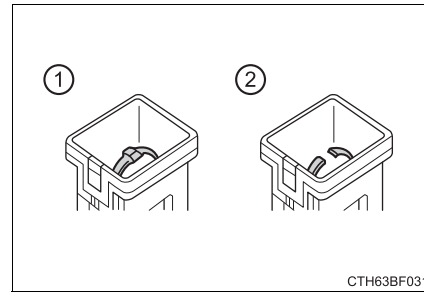

▶ Type C

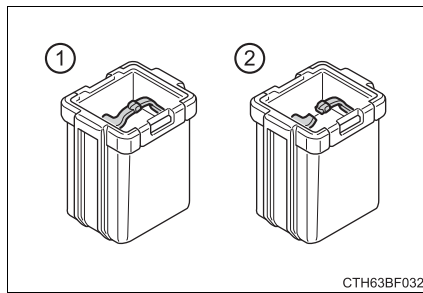

▶ Type D

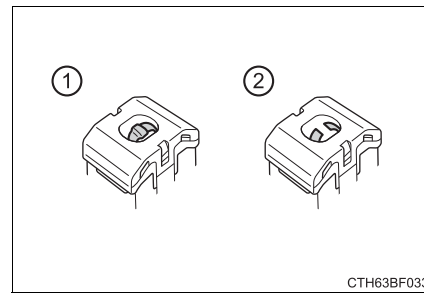

▶ Type E

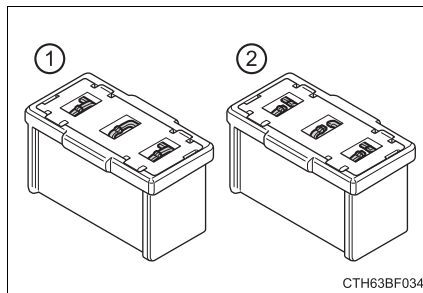

▶ Type F

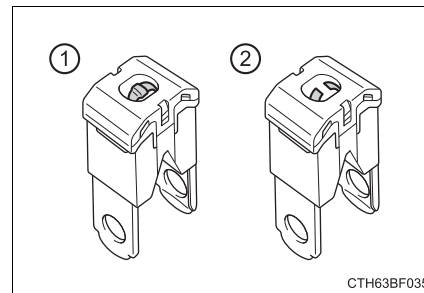

■ After a fuse is replaced

- If the lights do not turn on even after the fuse has been replaced, a bulb may need replacement. (→P. 453)
- If the replaced fuse blows again, have the vehicle inspected by your Toyota dealer.

■ If there is an overload in a circuit

The fuses are designed to blow, protecting the wiring harness from damage.

 **WARNING****■ To prevent system breakdowns and vehicle fire**

Observe the following precautions.

Failure to do so may cause damage to the vehicle, and possibly a fire or injury.

- Never use a fuse of a higher amperage rating than that indicated, or use any other object in place of a fuse.
- Always use a genuine Toyota fuse or equivalent.
Never replace a fuse with a wire, even as a temporary fix.
- Do not modify the fuses or fuse boxes.

 **NOTICE****■ Before replacing fuses**

Have the cause of electrical overload determined and repaired by your Toyota dealer as soon as possible.

Light bulbs

You may replace the following bulbs by yourself. The difficulty level of replacement varies depending on the bulb. If necessary bulb replacement seems difficult to perform, contact your Toyota dealer.

For more information about replacing other light bulbs, contact your Toyota dealer.

Preparing for light bulb replacement

Check the wattage of the light bulb to be replaced. (→P. 533)

Bulb locations

■ Front

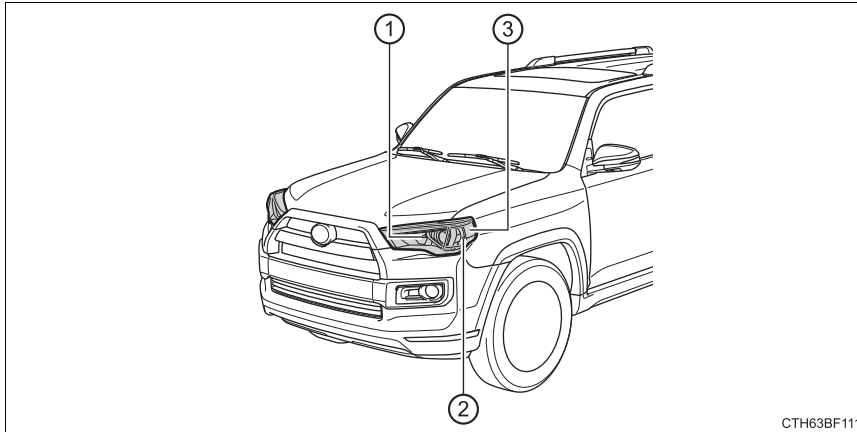

- ① Headlight high beam (if equipped)/daytime running light
- ② Front turn signal/parking light
- ③ Front side marker light

■ Rear

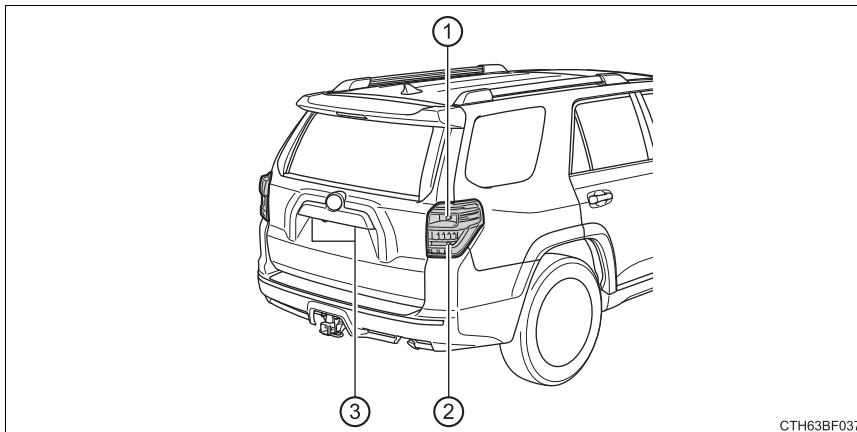

- ① Rear turn signal light
- ② Back-up light
- ③ License plate light

Replacing light bulbs

■ Headlight high beam (if equipped)/daytime running lights

- 1 Turn the bulb base counter-clockwise.

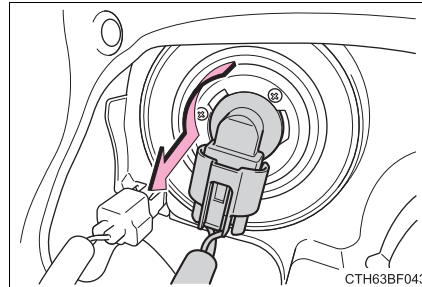

- 2 Pull the bulb out while pressing the lock release of the connector.

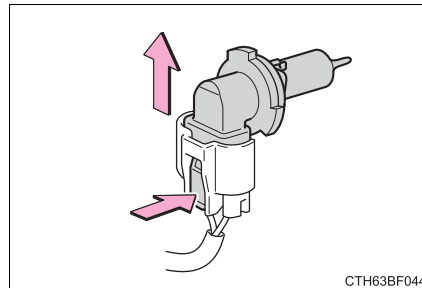

- 3 Replace the light bulb, and install the bulb base. Align the 3 tabs on the light bulb with the mounting and insert.

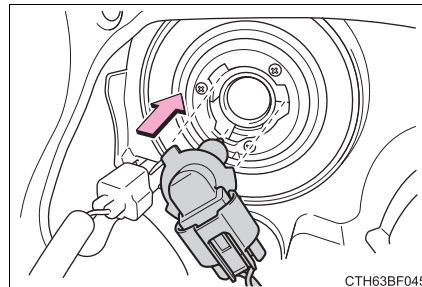

- 4 Turn and secure the bulb base.

Shake the bulb base gently to check that it is not loose, turn the headlights on once and visually confirm that no light is leaking through the mounting.

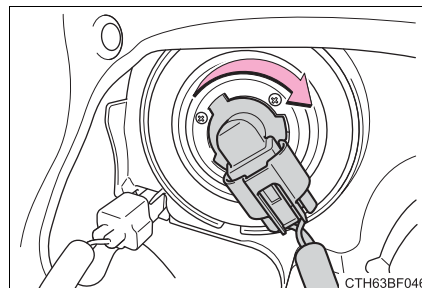

■ Front turn signal/parking light

- 1 Turn the steering wheel in the opposite direction of the front turn signal light and parking light that you wish to replace.

For example, if you wish to replace the front turn signal light and parking light on the right side, turn the steering wheel to the left.

- 2 Remove the fender liner screws.

- 3 Partly remove the fender liner.

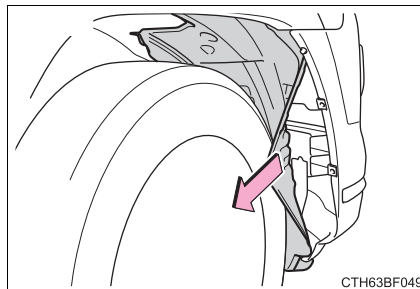
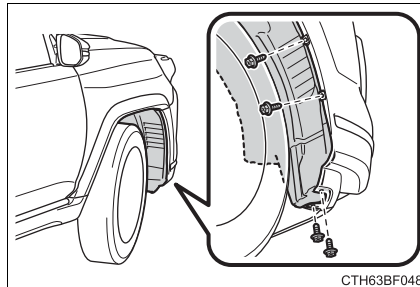
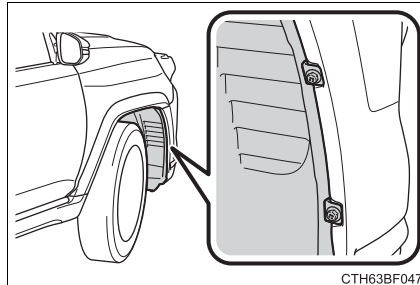

- 4 Turn the bulb base counter-clockwise.

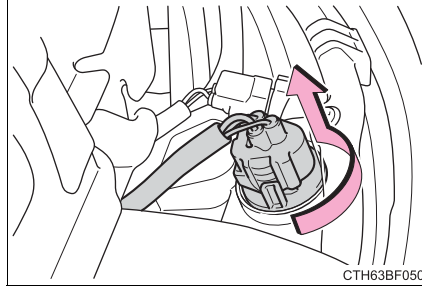

- 5 Remove the light bulb.

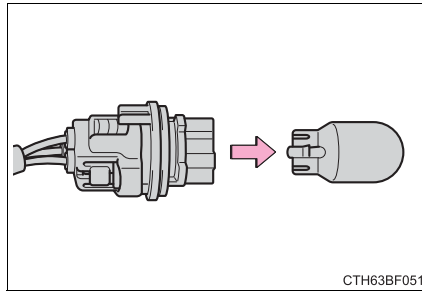

- 6 When installing, reverse the steps listed.

■ Front side marker lights

- 1 Turn the steering wheel in the opposite direction of the front side marker light that you wish to replace.

For example, if you wish to replace the front side marker light on the right side, turn the steering wheel to the left.

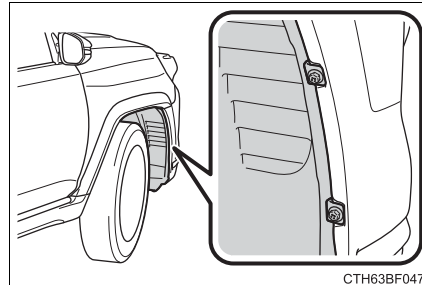

- 2 Remove the fender liner screws.

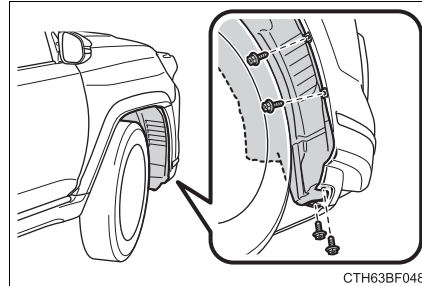

- 3 Partly remove the fender liner.

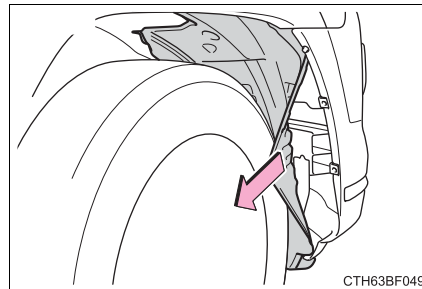

- 4 Turn the bulb base counter-clockwise.

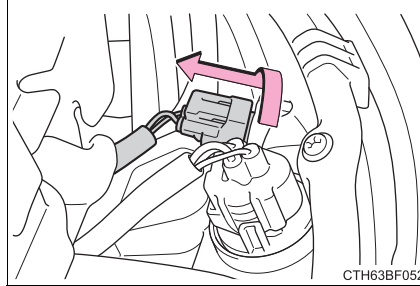

- 5 Remove the light bulb.

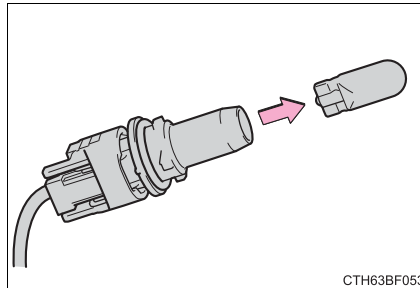

- 6 When installing, reverse the steps listed.

■ **Rear turn signal lights**

- 1 Open the back door and remove the cover.

To prevent damage to the vehicle, cover the tip of the screwdriver with a rag.

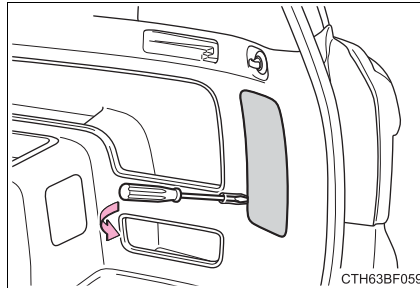

- 2 Turn the bulb base counter-clockwise.

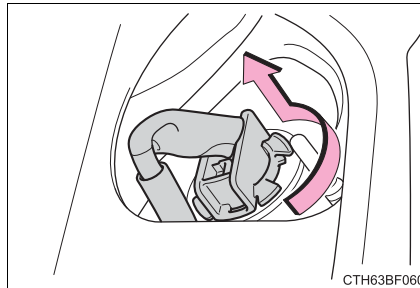

- 3 Remove the light bulb.

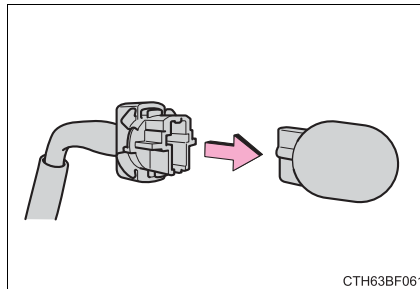

- 4 When installing, reverse the steps listed.

■ Back-up lights

- 1 Open the back door and remove the cover.

To prevent damage to the vehicle, cover the tip of the screwdriver with a rag.

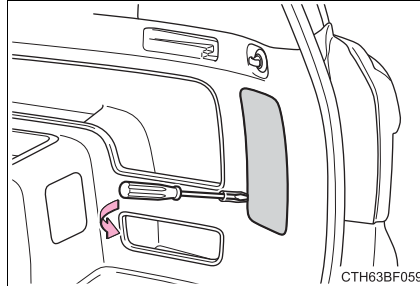

- 2 Turn the bulb base counter-clockwise.

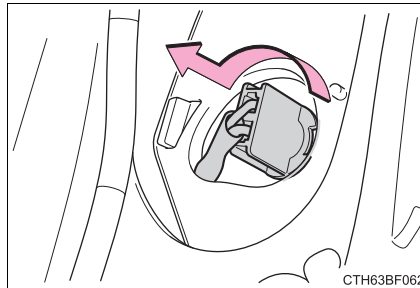

- 3 Remove the light bulb.

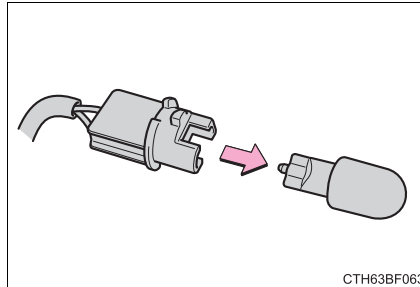

- 4 When installing, reverse the steps listed.

■ License plate lights

- 1 Remove the screws and lens.

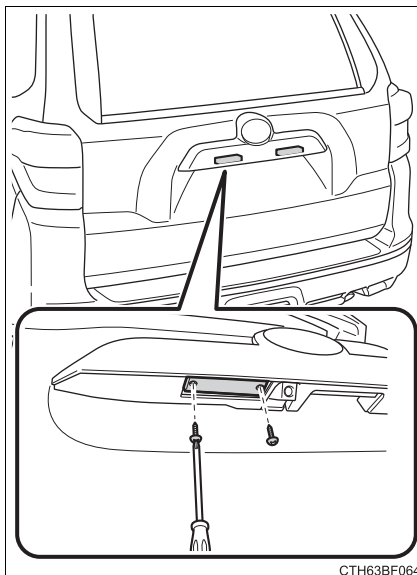

- 2 Remove the light bulb.

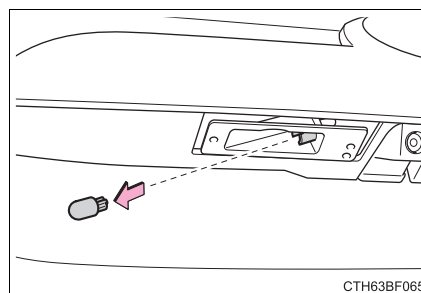

- 3 When installing, reverse the steps listed.

■ Replacing the following bulbs

If any of the lights listed below has burnt out, have it replaced by your Toyota dealer.

- Headlight low beams (if equipped)
- Headlight low/high beams (if equipped)
- Fog lights
- Side turn signal lights
- Stop/tail lights
- Rear side marker lights
- High mounted stoplight
- Outer foot lights (if equipped)

■ LED light bulbs

The headlight low beams (if equipped), headlight low/high beams (if equipped), fog lights, side turn signal lights, stop/tail lights, rear side marker lights, high mounted stoplight and outer foot lights consist of a number of LEDs. If any LEDs burn out, take your vehicle to your Toyota dealer to have the light replaced.

■ Condensation build-up on the inside of the lens

Temporary condensation build-up on the inside of the lens does not indicate a malfunction. Contact your Toyota dealer for more information in the following situations:

- Large drops of water have built up on the inside of the lens.
- Water has built up inside the lens.

WARNING

■ Replacing light bulbs

- Turn off the lights. Do not attempt to replace the bulb immediately after turning off the lights.

The bulbs become very hot and may cause burns.

- Do not touch the glass portion of the light bulb with bare hands. When it is unavoidable to hold the glass portion, use and hold with a clean dry cloth to avoid getting moisture and oils on the bulb.

Also, if the bulb is scratched or dropped, it may blow out or crack.

- Fully install light bulbs and any parts used to secure them. Failure to do so may result in heat damage, fire, or water entering the headlight unit. This may damage the headlights or cause condensation to build up on the lens.

■ To prevent damage or fire

- Make sure bulbs are fully seated and locked.
- Check the wattage of the bulb before installing to prevent heat damage.

When trouble arises**7****7-1. Essential information**

- Emergency flashers 466
- If your vehicle has
to be stopped in
an emergency 467
- If the vehicle is
submerged or water
on the road is rising 468

**7-2. Steps to take in
an emergency**

- If your vehicle needs
to be towed 469
- If you think something
is wrong 475
- Fuel pump shut off
system 476
- If a warning light turns
on or a warning
buzzer sounds 477
- If a warning message
is displayed 488
- If you have a flat tire..... 493
- If the engine will not
start..... 509
- If you cannot operate
back door opener 511
- If the electronic key
does not operate
properly 512
- If the vehicle battery
is discharged..... 515
- If your vehicle
overheats 519
- If the vehicle becomes
stuck 522

Emergency flashers

The emergency flashers are used to warn other drivers when the vehicle has to be stopped in the road due to a breakdown, etc.

Press the switch.

All the turn signals will flash.
To turn them off, press the switch
once again.

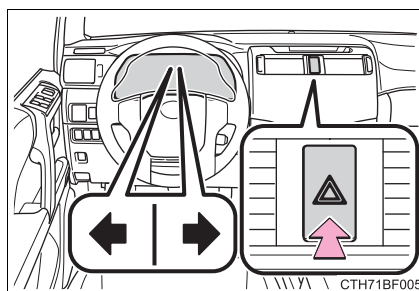

■ Emergency flashers

If the emergency flashers are used for a long time while the engine is not operating, the battery may discharge.

If your vehicle has to be stopped in an emergency

Only in an emergency, such as if it becomes impossible to stop the vehicle in the normal way, stop the vehicle using the following procedure:

- 1 Steadily step on the brake pedal with both feet and firmly depress it.
Do not pump the brake pedal repeatedly as this will increase the effort required to slow the vehicle.
- 2 Shift the shift lever to N.
 - ▶ If the shift lever is shifted to N
- 3 After slowing down, stop the vehicle in a safe place by the road.
- 4 Stop the engine.
 - ▶ If the shift lever cannot be shifted to N
- 3 Keep depressing the brake pedal with both feet to reduce vehicle speed as much as possible.
- 4 To stop the engine, press and hold the engine switch for 2 consecutive seconds or more, or press it briefly 3 times or more in succession.

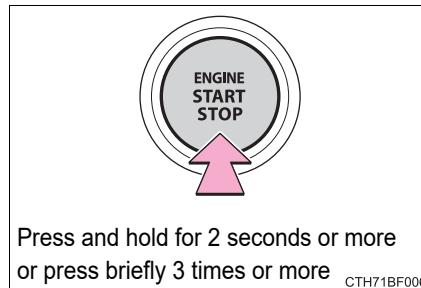

- 5 Stop the vehicle in a safe place by the road.

WARNING

■ If the engine has to be turned off while driving

Power assist for the brakes and steering wheel will be lost, making the brake pedal harder to depress and the steering wheel heavier to turn. Decelerate as much as possible before turning off the engine.

If the vehicle is submerged or water on the road is rising

This vehicle is not designed to be able to drive on roads that are deeply flooded with water. Do not drive on roads where the roads may be submerged or the water may be rising. It is dangerous to remain in the vehicle, if it anticipated that the vehicle will be flooded or set a drift. Remain calm and follow the following.

- If the door can be opened, open the door and exit the vehicle.
- If the door can not be opened, open the window using the power window switch and ensure an escape route.
- If the window can be opened, exit the vehicle through the window.
- If the door and window cannot be opened due to the rising water, remain calm, wait until the water level inside the vehicle rises to the point that the water pressure inside of the vehicle equals the water pressure outside of the vehicle and then open the door after waiting for the rising water to enter the vehicle, and exit the vehicle. When the outside water level exceeds half the height of the door, the door cannot be opened from the inside due to water pressure.

■ Water level exceeds the floor

When the water level exceeds the floor and time has passed, the electrical equipment will get damaged, the power windows will not operate, the engine stop, and the vehicle may not be able to get moving.

■ Using an emergency escape hammer*

Laminated glass is used in the windshield on this vehicle. Laminated glass cannot be shattered with an emergency hammer*.

Tempered glass is used in the windows on this vehicle.

*: Contact your Toyota dealer or aftermarket accessory manufacturer for further information about an emergency hammer.

WARNING

■ Caution while driving

Do not drive on roads where the roads may be submerged or the water may be rising. Otherwise the vehicle may be damaged and cannot move, as well as become flooded and set a drift, which may lead to death.

If your vehicle needs to be towed

If towing is necessary, we recommend having your vehicle towed by your Toyota dealer or commercial towing service, using a wheel-lift type truck or flatbed truck.

Use a safety chain system for all towing, and abide by all state/provincial and local laws.

WARNING

Observe the following precautions.

Failure to do so may result in death or serious injury.

■ When towing the vehicle

2WD models: Be sure to transport the vehicle with all four wheels raised off the ground. If the vehicle is towed with the tires contacting the ground, the drivetrain and related parts may be damaged or an accident may occur due to a change in direction of the vehicle.

4WD models: Be sure to transport the vehicle with all four wheels raised off the ground. If the vehicle is towed with the tires contacting the ground, the drivetrain or related parts may be damaged, the vehicle may fly off the truck.

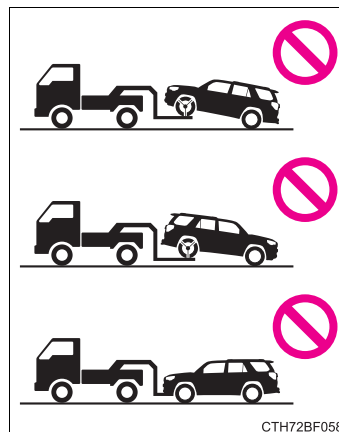

CTH72BF058

■ While towing

When towing using cables or chains, avoid sudden starts, etc. which place excessive stress on the towing eyelets, cables or chains. The towing eyelets, cables or chains may become damaged, broken debris may hit people, and cause serious damage.

 NOTICE

■ **To prevent damage to the vehicle when towing using a wheel-lift type truck**

- Do not tow the vehicle from the rear when the engine switch is off.
- When raising the vehicle, ensure adequate ground clearance for towing at the opposite end of the raised vehicle. Without adequate clearance, the vehicle could be damaged while being towed.

■ **To prevent damage to the vehicle when towing with a sling-type truck**

Do not tow with a sling-type truck, either from the front or rear.

■ **To prevent damage to the vehicle during emergency towing**

Do not secure cables or chains to the suspension components.

■ **Recreational towing (behind motor home, etc.) (4WD models)**

Never dinghy tow your vehicle to prevent causing serious damage to the transmission. (→P. 198)

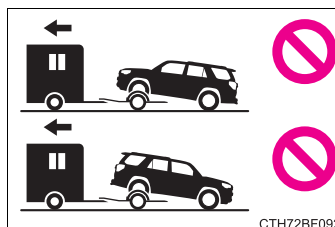

Situations when it is necessary to contact dealers before towing

The following may indicate a problem with your transmission. Contact your Toyota dealer or commercial towing service before towing.

- The engine is running but the vehicle does not move.
- The vehicle makes an abnormal sound.

Towing with a wheel-lift type truck

- ▶ From the front

Use a towing dolly under the rear wheels.

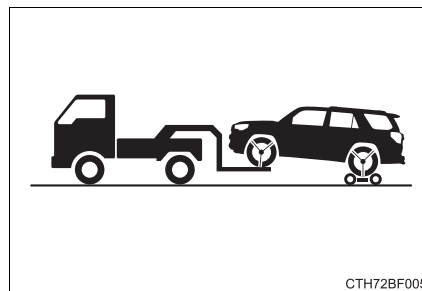

- ▶ From the rear

Use a towing dolly under the front wheels.

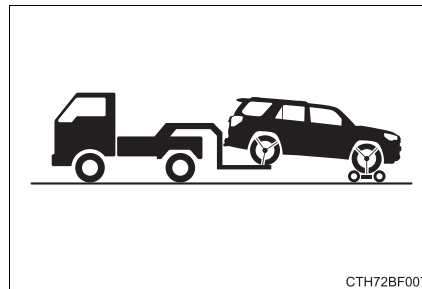

⚠ NOTICE

■ Towing with a sling-type truck

Do not tow with a sling-type truck to prevent body damage.

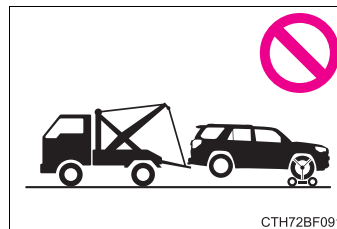

Using a flatbed truck

When using a flat-bed truck to transport the vehicle, use tire strapping belts. Refer to the owner's manual of the flat-bed truck for the tire strapping method.

In order to suppress vehicle movement during transportation, set the parking brake and turn the engine switch off.

Emergency towing

If a tow truck is not available in an emergency, your vehicle may be temporarily towed using cables or chains secured to the emergency towing hooks. This should only be attempted on hard surfaced roads for at most 50 miles (80 km) at under 18 mph (30 km/h).

A driver must be in the vehicle to steer and operate the brakes. The vehicle's wheels, drive train, axles, steering and brakes must be in good condition.

Emergency towing procedure

- 1 Vehicles with front covers only:
Before using the front emergency towing eyelet(s), remove the cover(s).

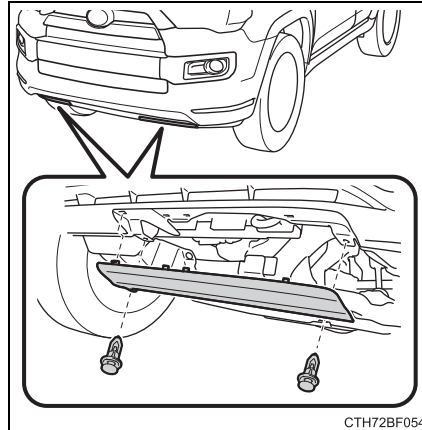

CTH72BF054

- ① Removing the clips
② Installing the clips

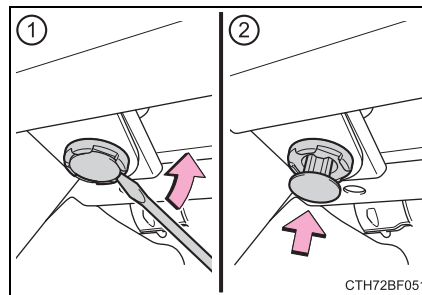

CTH72BF051

- 2 Securely attach cables or chains to the towing hook.
Take care not to damage the vehicle body.

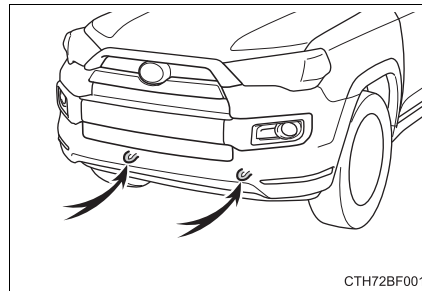

CTH72BF001

- 3 Enter the vehicle being towed and start the engine.
If the engine does not start, turn the engine switch to ON.

4 Part-time 4WD models:

▶ Type A

Shift the front-wheel drive control lever to H2.

▶ Type B

Push the “UNLOCK” button and turn the front-wheel drive control switch to H2.

Full-time 4WD models: Push the “UNLOCK” button and turn the four-wheel drive control switch to H4F. (The center differential is unlocked.)

5 Shift the shift lever to N and release the parking brake.

When the shift lever cannot be shifted: →P. 208

■ **While towing**

If the engine is not running, the power assist for the brakes and steering will not function, making steering and braking more difficult.

If you think something is wrong

If you notice any of the following symptoms, your vehicle probably needs adjustment or repair. Contact your Toyota dealer as soon as possible.

Visible symptoms

- Fluid leaks under the vehicle.
(Water dripping from the air conditioning after use is normal.)
- Flat-looking tires or uneven tire wear
- Engine coolant temperature gauge needle continually points higher than normal.

Audible symptoms

- Changes in exhaust sound
- Excessive tire squeal when cornering
- Strange noises related to the suspension system
- Pinging or other noises related to the engine

Operational symptoms

- Engine missing, stumbling or running roughly
- Appreciable loss of power
- Vehicle pulls heavily to one side when braking
- Vehicle pulls heavily to one side when driving on a level road
- Loss of brake effectiveness, spongy feeling, pedal almost touches the floor

Fuel pump shut off system

To minimize the risk of fuel leakage when the engine stalls or when an airbag inflates upon collision, the fuel pump shut off system stops the supply of fuel to the engine.

Follow the procedure below to restart the engine after the system is activated.

- 1 Turn the engine switch to ACCESSORY mode or turn it off.
- 2 Restart the engine.



NOTICE

■ **Before starting the engine**





Inspect the ground under the vehicle.







If you find that fuel has leaked onto the ground, the fuel system has been damaged and is in need of repair. Do not restart the engine.







If a warning light turns on or a warning buzzer sounds





Calmly perform the following actions if any of the warning lights comes on or flashes. If a light comes on or flashes, but then goes off, this does not necessarily indicate a malfunction in the system. However, if this continues to occur, have the vehicle inspected by your Toyota dealer.





Warning light and warning buzzer list



Warning light	Warning light/Details/Actions
 (U.S.A.)  (Canada)	Brake system warning light (warning buzzer) <ul style="list-style-type: none"> • Low brake fluid • Malfunction in the brake system This light also comes on when the parking brake is not released. If the light turns off after the parking brake is fully released the system is operating normally. → Immediately stop the vehicle in a safe place and contact your Toyota dealer. Continuing to drive the vehicle may be dangerous.
	High coolant temperature warning light (warning buzzer)*4 Indicates that the engine coolant temperature is too high → Immediately stop the vehicle in a safe place. Handling method (→P. 519)
	Charging system warning light Indicates a malfunction in the vehicle's charging system → Immediately stop the vehicle in a safe place and contact your Toyota dealer.
	Low engine oil pressure warning light*4 Indicates that the engine oil pressure is too low → Immediately stop the vehicle in a safe place and contact your Toyota dealer.

Warning light	Warning light/Details/Actions
 <p>(U.S.A.)</p>  <p>(Canada)</p>	<p>Malfunction indicator lamp Indicates a malfunction in:</p> <ul style="list-style-type: none"> • The emission control system; • The electronic engine control system; • The electronic throttle control system; or • The electronic automatic transmission control system <p>→ Have the vehicle inspected by your Toyota dealer immediately.</p>
	<p>SRS warning light Indicates a malfunction in:</p> <ul style="list-style-type: none"> • The SRS airbag system; • The front passenger occupant classification system; or • The seat belt pretensioner system <p>→ Have the vehicle inspected by your Toyota dealer immediately.</p>
<p>ABS</p> <p>(U.S.A.)</p>  <p>(Canada)</p>	<p>ABS warning light Indicates a malfunction in:</p> <ul style="list-style-type: none"> • The ABS; or • The brake assist system <p>→ Have the vehicle inspected by your Toyota dealer immediately.</p>
	<p>Slip indicator Indicates a malfunction in:</p> <ul style="list-style-type: none"> • The VSC system; • Trailer Sway Control system; • The TRAC system; • The active traction control system; • The AUTO LSD system; • The downhill assist control system; • The hill-start assist control system; or • The Crawl Control system <p>→ Have the vehicle inspected by your Toyota dealer immediately.</p>
 <p>(Flashes rapidly)</p>	<p>Rear differential lock indicator light (if equipped) Indicates a malfunction in the rear differential lock system</p> <p>→ Have the vehicle inspected by your Toyota dealer immediately.</p>

Warning light	Warning light/Details/Actions
 (Flashes rapidly)	Four-wheel drive indicator light (if equipped) Indicates a malfunction in the four-wheel drive system → Have the vehicle inspected by your Toyota dealer immediately.
 (Flashes rapidly)	Low speed four-wheel drive indicator light (if equipped) Indicates a malfunction in the four-wheel drive system → Have the vehicle inspected by your Toyota dealer immediately.
 (Flashes rapidly)	Center differential lock indicator light (if equipped) Indicates a malfunction in the four-wheel drive system → Have the vehicle inspected by your Toyota dealer immediately.
 (Flashes continuously)	Multi-terrain Select indicator light (if equipped)*4 Indicates a malfunction in the Multi-terrain Select system → Have the vehicle inspected by your Toyota dealer immediately.
	Power steering warning light Indicates a malfunction in the power steering system → Have the vehicle inspected by your Toyota dealer immediately.
	Unengaged "Park" warning light (if equipped) Indicates a malfunction in the transmission "Park" mechanism. → Have the vehicle inspected by your Toyota dealer immediately.
	KDSS warning light (if equipped) Indicates a malfunction in KDSS → Have the vehicle inspected by your Toyota dealer immediately.
 (Flashes)	Automatic running boards indicator light (if equipped) Indicates a malfunction in Automatic running boards → Have the vehicle inspected by your Toyota dealer immediately.
	Open door warning light (warning buzzer)*2 Indicates that a door is not fully closed → Check that all the doors are closed.

Warning light	Warning light/Details/Actions
	<p>Low fuel level warning light Indicates remaining fuel is approximately 3.5 gal. (13.1 L, 2.9 Imp. gal.) or less → Refuel the vehicle.</p>
	<p>Seat belt reminder light (warning buzzer)*3 Warns the driver and/or front passenger to fasten their seat belts → Fasten the seat belt. If the front passenger's seat is occupied, the front passenger's seat belt also needs to be fastened to make the warning light (warning buzzer) turn off.</p>
	<p>Brake Override System/Drive-Start Control warning light (warning buzzer)*4 When a buzzer sounds: • Brake Override System is malfunctioning; • Drive-Start Control is operating; • Drive-Start Control is malfunctioning; or → Follow the instructions displayed on the multi-information display. When a buzzer does not sound: Brake Override System is operating → Release the accelerator pedal and depress the brake pedal.</p>
<p>PARK (Flashes) (U.S.A.)</p>  <p>(Flashes) (Canada)</p>	<p>Parking brake indicator (warning buzzer)*1 Indicates that the parking brake is engaged → Release the parking brake.</p>

Warning light	Warning light/Details/Actions
 <p>(Flashes or illuminates)</p>	<p>PCS warning light When a buzzer sounds simultaneously: Indicates a malfunction has occurred in the PCS (Pre-Collision System). → Have the vehicle inspected by your Toyota dealer immediately.</p> <p>When a buzzer does not sound: The PCS (Pre-Collision System) has become temporarily unavailable, corrective action may be necessary. → Follow the instructions displayed on the multi-information display. (→P. 237, 488)</p> <p>If the PCS (Pre-Collision System) or VSC (Vehicle Stability Control) system is disabled, the PCS warning light will illuminate. → P. 248</p>
 <p>(Amber)</p>	<p>LDA indicator*4 Indicates a malfunction in the LDA → When “LDA Unavailable” is displayed on the multi-information display, turn the LDA system off, wait for a little while, and then turn the LDA system back on. (→P. 252) When a message other than above is displayed, follow the instructions displayed in the message.</p>
	<p>Master warning light A buzzer sounds and warning light comes on flashes to indicate that the master warning system has detected a malfunction. → P. 488</p>
	<p>Tire pressure warning light When the light comes on: Low tire inflation pressure such as • Natural causes (→P. 484) • Flat tire (→P. 493) → Adjust the tire inflation pressure (including the spare tire) to the specified level. The light will turn off after a few minutes. In case the light does not turn off even if the tire inflation pressure is adjusted, have the system checked by your Toyota dealer.</p> <p>When the light comes on after blinking for 1 minute: Malfunction in the tire pressure warning system (→P. 485) → Have the system checked by your Toyota dealer.</p>

Warning light	Warning light/Details/Actions
 <p>RCTA OFF (Flashes)</p>	<p>RCTA OFF indicator (warning buzzer) Indicates a malfunction in the RCTA (Rear Cross Traffic Alert) function → Have the vehicle inspected by your Toyota dealer immediately. Indicates that the rear bumper around the radar sensor is covered with dirt, etc. (→P. 272) → Follow the instructions displayed on the multi-information display. (→P. 287)</p>
 <p>BSM OFF</p>	<p>BSM OFF indicator (warning buzzer) Indicates a malfunction in the BSM (Blind Spot Monitor) function → Have the vehicle inspected by your Toyota dealer immediately. Indicates that the rear bumper around the radar sensor is covered with dirt, etc. (→P. 272) → Follow the instructions displayed on the multi-information display. (→P. 271)</p>

*1: Parking brake engaged warning buzzer:

A buzzer will sound if the vehicle is driven at a speed of approximately 3 mph (5 km/h) or more.

*2: Open door warning buzzer:

The open door warning buzzer sounds to alert one or more of the doors is not fully closed (with the vehicle having reached a speed of 3 mph [5 km/h]).

*3: Driver's seat belt buzzer:

The driver's seat belt warning buzzer sounds to alert the driver that his or her seat belt is not fastened. Once the engine switch is turned to ON, the buzzer sounds. If the seat belt is still unfastened, the buzzer sounds intermittently for a certain period of time after the vehicle reaches a certain speed.

Front passenger's seat belt warning buzzer:

The front passenger's seat belt warning buzzer sounds to alert the front passenger that his or her seat belt is not fastened. If the seat belt is unfastened, the buzzer sounds intermittently for a certain period of time after the vehicle reaches a certain speed.

*4: This light illuminates on the multi-information display.

■ SRS warning light

This warning light system monitors the airbag sensor assembly, front impact sensors, side impact sensors (front door), side impact sensors (rear), safing sensor (rear), driver's seat belt buckle switch, front passenger occupant classification system (ECU and sensors), "AIR BAG ON" and "AIR BAG OFF" indicator lights, front passenger's seat belt buckle switch, seat belt pretensioners, airbags, interconnecting wiring and power sources. (→P. 37)

■ Open moon roof reminder buzzer (if equipped)

The buzzer indicates that the moon roof is not fully closed with the engine off and the driver's door opened.

■ Front passenger detection sensor, passenger seat belt reminder and warning buzzer

- If luggage is placed on the front passenger seat, the front passenger detection sensor may cause the warning light to flash and the warning buzzer to sound even if a passenger is not sitting in the seat.
- If a cushion is placed on the seat, the sensor may not detect a passenger, and the warning light may not operate properly.

■ If the malfunction indicator lamp comes on while driving

First check the following:

- Is the fuel tank empty?
If it is, fill the fuel tank immediately.
- Is the fuel tank cap loose?
If it is, tighten it securely.

The light will go off after several driving trips.

If the light does not go off even after several trips, contact your Toyota dealer as soon as possible.

■ **When the tire pressure warning light comes on**

Inspect the appearance of the tire to check that the tire is not punctured.

If the tire is punctured: →P. 493

If the tire is not punctured:

Carry out the following procedure after the tire temperature has lowered sufficiently.

- Check the tire inflation pressure and adjust to the appropriate level.
- If the warning light does not go out even after several minutes, check that the tire inflation pressure is at the specified level and carry out initialization. (→P. 429)

The warning light may come on again if the above operations are conducted without first allowing the tire temperature to lower sufficiently.

■ **The tire pressure warning light may come on due to natural causes**

The tire pressure warning light may come on due to natural causes such as natural air leaks and tire inflation pressure changes caused by temperature. In this case, adjusting the tire inflation pressure will turn off the warning light (after a few minutes).

■ **When a tire is replaced with a spare tire**

▶ Vehicles without P245/60R20 tires

The spare tire is not equipped with a tire pressure warning valve and transmitter. If a tire goes flat, the tire pressure warning light will not turn off even though the flat tire has been replaced with the spare tire. Replace the spare tire with the repaired tire and adjust the tire inflation pressure. The tire pressure warning light will go off after a few minutes.

▶ Vehicles with P245/60R20 tires

The spare tire is also equipped with a tire pressure warning valve and transmitter. The tire pressure warning light will turn on if the tire inflation pressure of the spare tire is low. If a tire goes flat, the tire pressure warning light will not turn off even though the flat tire has been replaced with the spare tire. Replace the spare tire with the repaired tire and adjust the tire inflation pressure. The tire pressure warning light will go off after a few minutes.

■ If the tire pressure warning system is not functioning

The tire pressure warning system will be disabled in the following conditions:

(When the condition becomes normal, the system will work properly.)

- If tires not equipped with tire pressure warning valves and transmitters are used
- If the ID code on the tire pressure warning valves and transmitters is not registered in the tire pressure warning computer
- If the tire inflation pressure is 73 psi (500 kPa, 5.1 kgf/cm² or bar) or higher

The tire pressure warning system may be disabled in the following conditions:

(When the condition becomes normal, the system will work properly.)

- If electronic devices or facilities using similar radio wave frequencies are nearby
- If a radio set at a similar frequency is in use in the vehicle
- If a window tint that affects the radio wave signals is installed
- If there is a lot of snow or ice on the vehicle, particularly around the wheels or wheel housings
- If non-genuine Toyota wheels are used (Even if you use Toyota wheels, the tire pressure warning system may not work properly with some types of tires.)
- If tire chains are used
- Vehicles with P245/60R20 tires: If the spare tire is in a location subject to poor radio wave signal reception
- Vehicles with P245/60R20 tires: If a large metallic object which can interfere with signal reception is put in the luggage compartment

■ If the tire pressure warning light frequently comes on after blinking for 1 minute

If the tire pressure warning light frequently comes on after blinking for 1 minute when the engine switch is turned on, have it checked by your Toyota dealer.

■ Customization that can be configured at Toyota dealer

The vehicle speed linked seat belt reminder buzzer can be disabled.

(Customizable features →P. 549) However, Toyota recommends that the seat belt reminder buzzer be operational to alert the driver and front passenger when seat belts are not fastened.

 **WARNING****■ If the tire pressure warning light comes on**

Be sure to observe the following precautions. Failure to do so could cause a loss of vehicle control and result in death or serious injury.

- Stop your vehicle in a safe place as soon as possible. Adjust the tire inflation pressure immediately.
- If the tire pressure warning light comes on even after tire inflation pressure adjustment, it is probable that you have a flat tire. Check the tires. If a tire is flat, change it with the spare tire and have the flat tire repaired by the nearest Toyota dealer.
- Avoid abrupt maneuvering and braking. If the vehicle tires deteriorate, you could lose control of the steering wheel or the brakes.

■ If a blowout or sudden air leakage should occur

The tire pressure warning system may not activate immediately.

■ Maintenance of the tires

Each tire, including the spare (if provided), should be checked monthly when cold and inflated to the inflation pressure recommended by the vehicle manufacturer on the vehicle placard or tire inflation pressure label (tire and load information label). (If your vehicle has tires of a different size than the size indicated on the vehicle placard or tire inflation pressure label [tire and load information label], you should determine the proper tire inflation pressure for those tires.)

As an added safety feature, your vehicle has been equipped with a tire pressure monitoring system (TPMS-tire pressure warning system) that illuminates a low tire pressure telltale (tire pressure warning light) when one or more of your tires is significantly under-inflated. Accordingly, when the low tire pressure telltale (tire pressure warning light) illuminates, you should stop and check your tires as soon as possible, and inflate them to the proper pressure. Driving on a significantly under-inflated tire causes the tire to overheat and can lead to tire failure. Under-inflation also reduces fuel efficiency and tire tread life, and may affect the vehicle's handling and stopping ability.

Please note that the TPMS (tire pressure warning system) is not a substitute for proper tire maintenance, and it is the driver's responsibility to maintain correct tire pressure, even if under-inflation has not reached the level to trigger illumination of the TPMS low tire pressure telltale (tire pressure warning light).

 WARNING

Your vehicle has also been equipped with a TPMS (tire pressure warning system) malfunction indicator to indicate when the system is not operating properly. The TPMS (tire pressure warning system) malfunction indicator is combined with the low tire pressure telltale (tire pressure warning light). When the system detects a malfunction, the telltale will flash for approximately one minute and then remain continuously illuminated. This sequence will continue upon subsequent vehicle start-ups as long as the malfunction exists. When the malfunction indicator is illuminated, the system may not be able to detect or signal low tire pressure as intended.

TPMS (tire pressure warning system) malfunctions may occur for a variety of reasons, including the installation of replacement or alternate tires or wheels on the vehicle that prevent the TPMS (tire pressure warning system) from functioning properly. Always check the TPMS (tire pressure warning system) malfunction telltale after replacing one or more tires or wheels on your vehicle to ensure that the replacement or alternate tires and wheels allow the TPMS (tire pressure warning system) to continue to function properly.

 NOTICE

■ **To ensure the tire pressure warning system operates properly**

Do not install tires with different specifications or makers, as the tire pressure warning system may not operate properly.

If a warning message is displayed

The multi-information display shows warnings of system malfunctions, incorrectly performed operations, and messages that indicate a need for maintenance. When a message is shown, perform the correction procedure appropriate to the message.

① Master warning light

The master warning light also comes on or flashes in order to indicate that a message is currently being displayed on the multi-information display.

② Multi-information display

③ Handling method

Follow the instructions of the message on the multi-information display.

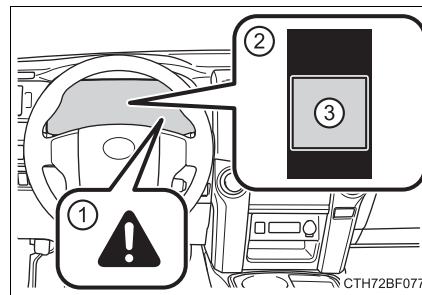

If any of the warning messages are shown again after the following actions have been performed, contact your Toyota dealer.

Messages and warnings

The warning lights and warning buzzers operate as follows depending on the content of the message. If a message indicates the need for inspection by a dealer, have the vehicle inspected by your Toyota dealer immediately.

	System warning light	Warning buzzer*	Warning
Comes on	Comes on	Sounds	Indicates an important situation, such as when a system related to driving is malfunctioning or that danger may result if the correction procedure is not performed
Comes on	—	Sounds	
—	Comes on or flashes	Sounds	Indicates an important situation, such as when the systems shown on the multi-information display may be malfunctioning
Flashes	—	Sounds	Indicates a situation, such as when damage to the vehicle or danger may result
Comes on	—	Does not sound	Indicates a condition, such as malfunction of electrical components, their condition, or indicates the need for maintenance
Flashes	—	Does not sound	Indicates a situation, such as when an operation has been performed incorrectly, or indicates how to perform an operation correctly

The operation of the warning lights and warning buzzers may differ from those stated. In this case, perform the correction procedure according to the displayed message.

*: A buzzer sounds the first time a message is shown on the multi-information display.

■ Warning messages

The warning messages explained below may differ from the actual messages according to operation conditions and vehicle specifications.

■ System warning lights

The master warning light does not come on or flash in the following cases. Instead, a separate system warning light will come on along with a message or image shown on the multi-information display.

● Malfunction in the ABS

The ABS warning light comes on. (→P. 478)

● Indicates that the PCS (Pre-Collision System) is not currently functional

The PCS warning light comes on or flashes. (→P. 481)

● Malfunction in the tire pressure warning system

The tire pressure warning light comes on. (→P. 481)

■ If a message instructing to refer to the Owner's Manual is displayed**● If the following message is shown, there may be a malfunction.**

Immediately stop the vehicle in a safe place and contact your Toyota dealer. Continuing to drive the vehicle may be dangerous.

- "Braking Power Low Stop in a Safe Place See Owner's Manual"
- "Oil Pressure Low Stop in a Safe Place See Owner's Manual"

● If "Engine Coolant Temp High Stop in a Safe Place See Owner's Manual" is displayed, follow the instructions accordingly. (→P. 519)**● If "Front Camera Unavailable See Owner's Manual" is displayed, follow the instructions accordingly. (→P. 237, 488)****● If the following message is shown, there may be a malfunction.**

Immediately have the vehicle inspected by your Toyota dealer.

- "Smart Key System Malfunction See Owner's Manual"

■ If "High transmission fluid temperature" is shown, it indicates that the automatic transmission fluid temperature is too high.

Immediately stop the vehicle in a safe place, shift the shift lever to P and wait until the warning message and light go off. If the warning message and light go off, you may start the vehicle again. If the warning message and light do not go off, contact your Toyota dealer.

- **If “Auto power off to conserve battery” is shown**
 Power was turned off due to the automatic power off function.
 Next time when starting the engine, increase the engine speed slightly and maintain that level for approximately 5 minutes to recharge the battery.
- **When a message that indicates the need for the shift lever operation is shown**
 To prevent the shift lever from being operated incorrectly or the vehicle from moving unexpectedly, a message that requires shifting the shift lever may be shown on the multi-information display. In that case, follow the instruction of the message and shift the shift lever.
- **When “Headlight System Malfunction Visit Your Dealer” is displayed on the multi-information display**
 The following system may be malfunctioning. Have the vehicle inspected by your Toyota dealer.

 - Automatic High Beam
- **If a message that indicates the malfunction of front camera is displayed**
 The following systems may be suspended until the problem shown in the message is resolved. (→P. 237, 488)

 - PCS (Pre-Collision System)
 - LDA (Lane Departure Alert)
 - Dynamic radar cruise control
 - Automatic High Beam
- **If a message that indicates the malfunction of radar sensor is displayed**
 The following systems may be suspended until the problem shown in the message is resolved. (→P. 237, 488)

 - PCS (Pre-Collision System)
 - LDA (Lane Departure Alert)
 - Dynamic radar cruise control
- **If a following message is shown, take appropriate action and confirm that the message has disappeared.***

 - “Crawl Not Available Select L4 and Shift to [D] or [R] Position”
 - “Crawl Not Available Check System Operation Conditions”

*: Refer to the “Off-road Driving Owner’s Manual”.
- **If “Oil Maintenance Required Soon” is displayed (U.S.A. only)**
 Indicates that all maintenance according to the driven distance on the maintenance schedule* should be performed soon.
 Comes on approximately 4500 miles (7200 km) after the message has been reset.
 If necessary, perform maintenance. Please reset the message after the maintenance is performed. (→P. 404)
 *: Refer to the separate “Scheduled Maintenance Guide” or “Owner’s Manual Supplement” for the maintenance interval applicable to your vehicle.

■ If “Oil Maintenance Required” is displayed (U.S.A. only)

Indicates that all maintenance is required to correspond to the driven distance on the maintenance schedule*.

Comes on approximately 5000 miles (8000 km) after the message has been reset.

(The indicator will not work properly unless the message has been reset.)

Perform the necessary maintenance. Please reset the message after the maintenance is performed. (→P. 404)

*: Refer to the separate “Scheduled Maintenance Guide” or “Owner’s Manual Supplement” for the maintenance interval applicable to your vehicle.

■ If “Visit Your Dealer” is shown

The system or part shown on the multi-information display is malfunctioning. Have the vehicle inspected by your Toyota dealer immediately.

■ Warning buzzer

In some cases, the buzzer may not be heard due to being in a noisy location or audio sound.

**NOTICE****■ While the engine oil level warning is displayed**

Continued engine operation with low engine oil will damage the engine.

If you have a flat tire

Your vehicle is equipped with a spare tire. The flat tire can be replaced with the spare tire.

For details about tires: →P. 427

WARNING

■ If you have a flat tire

Do not continue driving with a flat tire.

Driving even a short distance with a flat tire can damage the tire and the wheel beyond repair, which could result in an accident.

You will need the following item:

- Phillips screwdriver

Before jacking up the vehicle

- Stop the vehicle in a safe place on a hard, flat surface.
- Set the parking brake.
- Shift the shift lever to P.
- Stop the engine.
- Turn on the emergency flashers. (→P. 466)

Location of the spare tire, jack and tools

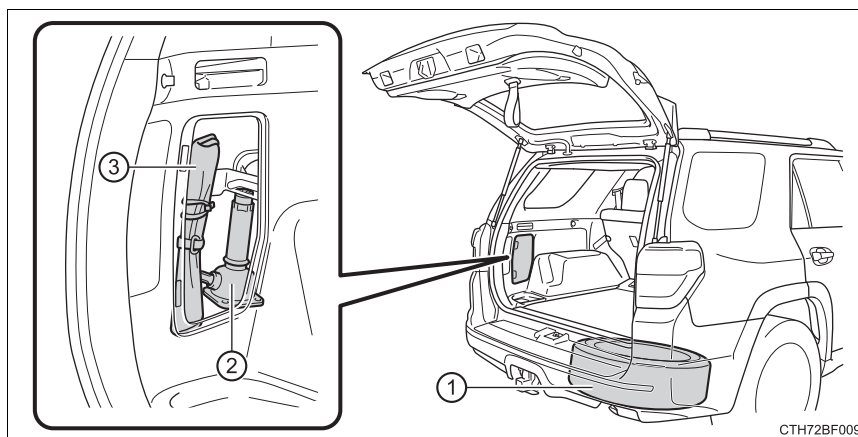

- ① Spare tire
- ② Jack
- ③ Tool bag

⚠ WARNING**■ Using the tire jack**

Improper use of the tire jack may cause the vehicle to suddenly fall off the jack, leading to death or serious injury.

- Do not use the tire jack for any purpose other than replacing tires or installing and removing tire chains.
- Only use the tire jack that comes with this vehicle for replacing a flat tire.
Do not use it on other vehicles, and do not use other tire jacks for replacing tires on this vehicle.
- Always check that the tire jack is securely set to the jack point.
- Do not put any part of your body under the vehicle while it is supported by the jack.
- Do not start or run the engine while your vehicle is supported by the jack.
- Do not raise the vehicle while someone is inside.
- When raising the vehicle, do not put an object on or under the jack.
- Do not raise the vehicle to a height greater than that required to replace the tire.
- Use a jack stand if it is necessary to get under the vehicle.
- ▶ Vehicles with Automatic running boards
- Observe the following precautions. Failure to do so may result in serious injury:
 - When jacking up the vehicle, always turn the Automatic running boards switch off.
 - When jacking up the vehicle, do not use an Automatic running board as a jack point. The Automatic running board may break, causing injuries.

Take particular care when lowering the vehicle to ensure that no one working on or near the vehicle may be injured.

■ Using the jack handle/wheel nut wrench (used with jack handle)

Tighten all the jack handle bolts securely to prevent the extension parts from coming apart unexpectedly.

Taking out the jack and tool bag

- 1 Remove the cover.

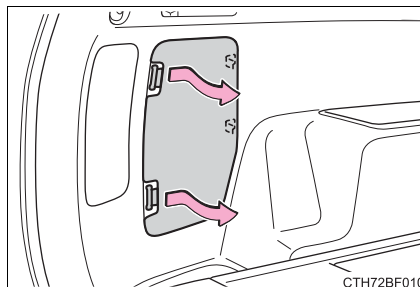

- 2 Unhook and take out the tool bag.

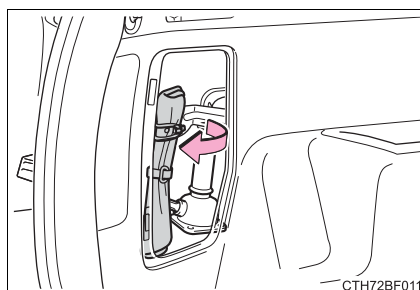

- 3 Take out the jack.

- ① For loosening
- ② For tightening

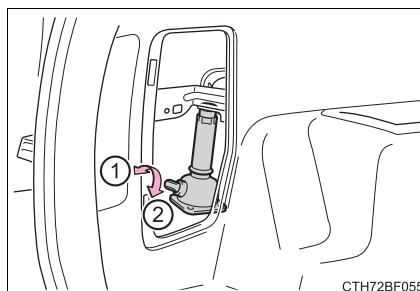

Taking out the spare tire

- 1 Vehicles without Jack handle: Assembling the wheel nut wrench (used with jack handle).

Remove the wheel nut wrench and the jack handle extension bar from the tool bag and assemble by following these steps.

- ① Loosen the bolt using a wheel nut wrench.

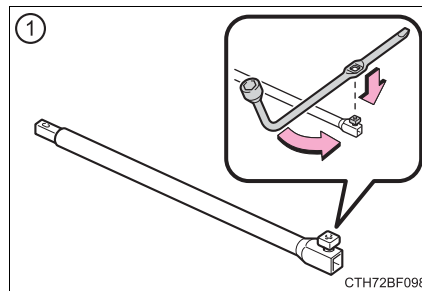

- ② Assemble the jack handle extension bar and wheel nut wrench and tighten the bolt.

Check that the bolts are firmly tightened.

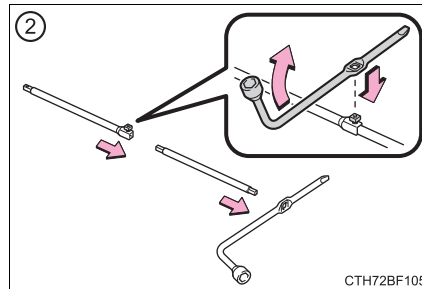

1 Vehicles with Jack handle: Assembling the jack handle.

Remove the jack handle and the jack handle extension bar from the tool bag and assembly by following these steps.

- ① Loosen the bolt and the screw using either the jack handle or a screwdriver.

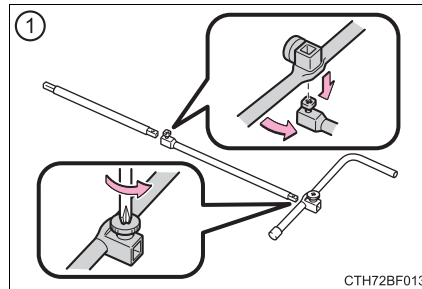

- ② Assemble the jack handle extension bars and tighten the bolt.

Check that the bolt is firmly tightened.

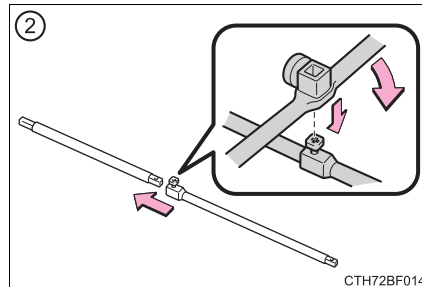

- ③ Assemble the jack handle and the jack handle extension bar and tighten the screw.

Check that the screw is firmly tightened.

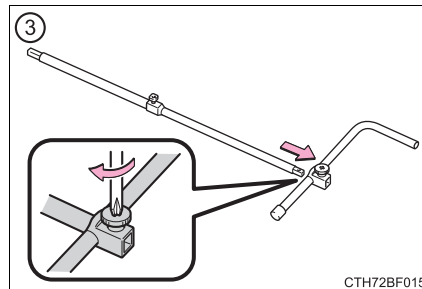

- 2 Insert the end of the jack handle extension into the lowering screw and turn it counterclockwise.

Lower the spare tire completely to the ground.

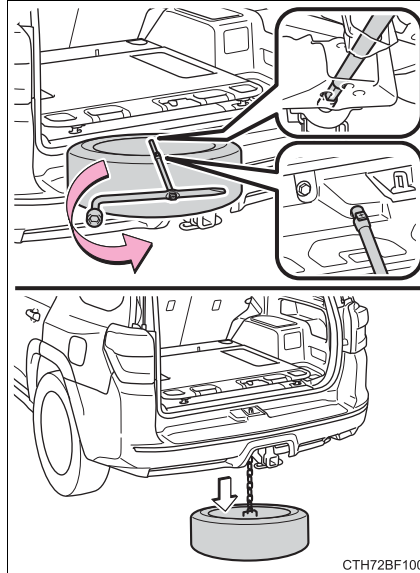

- 3 Pull out the spare tire and remove the holding bracket.

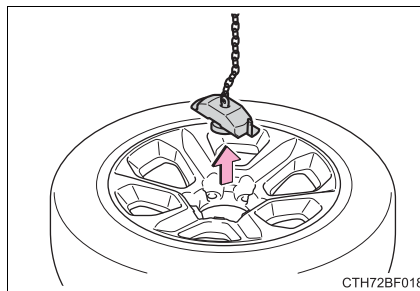

Replacing a flat tire

- 1 Check the tires.

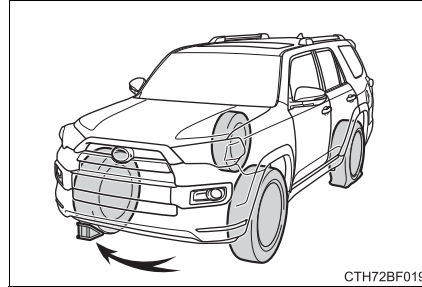

	Flat tire	Wheel chock positions
Front	Left-hand side	Behind the rear right-hand side tire
	Right-hand side	Behind the rear left-hand side tire
Rear	Left-hand side	In front of the front right-hand side tire
	Right-hand side	In front of the front left-hand side tire

- 2 Remove the wheel ornament using the wheel ornament remover.

To protect the wheel ornament, place a rag between the wheel ornament remover and the wheel ornament, as shown in the illustration.

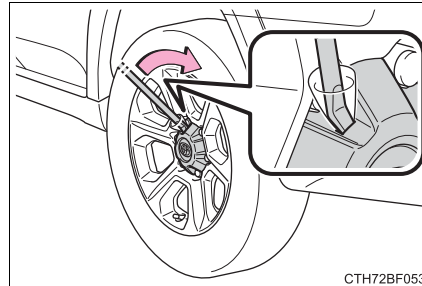

- 3 Slightly loosen the wheel nuts (one turn).

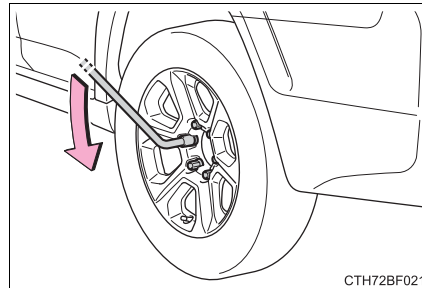

- 4 Vehicles without Jack handle: Assembling the wheel nut wrench (used with jack handle).

Remove the wheel nut wrench, jack handle extension bar and jack handle bar from the tool bag and assemble by following these steps.

- ① Loosen the bolt using a wheel nut wrench.

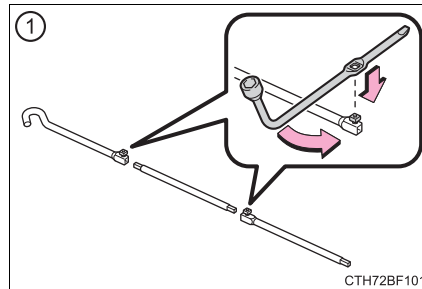

- ② Assemble the jack handle bar, jack handle extension bar and wheel nut wrench and tighten the bolts.

Check that the bolts are firmly tightened.

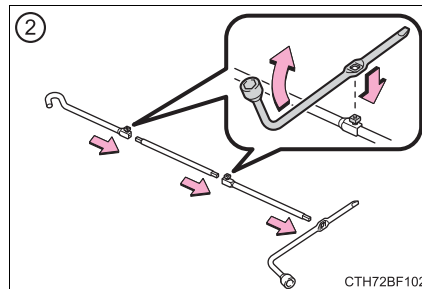

4 Vehicles with Jack handle: Assembling the jack handle.

Remove the jack handle, jack handle extension bar and jack handle bar from the tool bag and assemble by following these steps.

- ① Loosen the bolts and the screw using either the jack handle or a screwdriver.

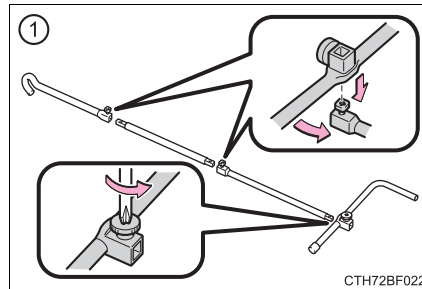

- ② Assemble the jack handle extension bars and the jack handle bar and tighten the bolts.

Check that the bolts are firmly tightened.

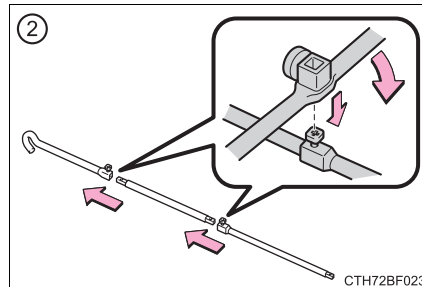

- ③ Assemble the jack handle extension bar and the jack handle and tighten the screw.

Check that the screw is firmly tightened.

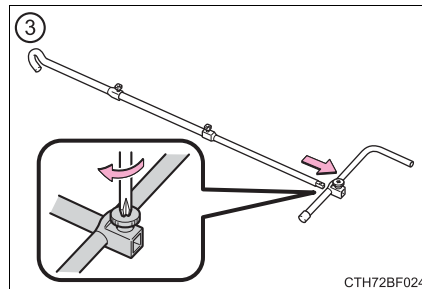

- 5 Position the jack at the jack points as shown.

Front - Under the chassis frame side rail

Rear - Under the rear axle housing

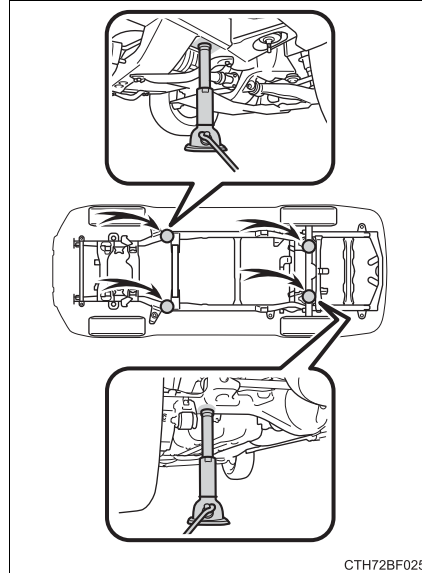

- 6 Raise the vehicle until the tire is slightly raised off the ground.

When positioning the jack under the rear axle housing, make sure the groove on the top of the jack fits with the rear axle housing.

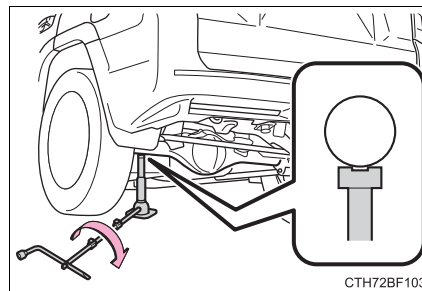

- 7 Remove all the wheel nuts and the tire.

When resting the tire on the ground, place the tire so that the wheel design faces up to avoid scratching the wheel surface.

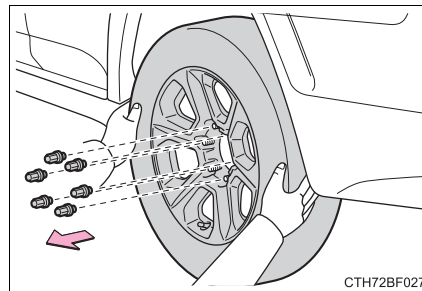

 **WARNING****■ Replacing a flat tire**

- Observe the following precautions.

Failure to do so may result in serious injury:

- Lower the spare tire completely to the ground before removing it from under the vehicle.
- Do not try to remove the wheel ornament by hand. Take due care in handling the ornament to avoid unexpected personal injury.
- Do not attach a heavily damaged wheel ornament, as it may fly off the wheel while the vehicle is moving.
- Do not touch the disc wheels or the area around the brakes immediately after the vehicle has been driven.

After the vehicle has been driven the disc wheels and the area around the brakes will be extremely hot. Touching these areas with hands, feet or other body parts while changing a tire, etc. may result in burns.

- Failure to follow these precautions could cause the wheel nuts to loosen and the tire to fall off, resulting in death or serious injury.
 - Have the wheel nuts tightened with a torque wrench to 83 ft•lbf (112 N•m, 11.4 kgf•m) steel wheels, 76 ft•lbf (103 N•m, 10.5 kgf•m) aluminum wheels, as soon as possible after changing wheels.
 - When installing a tire, only use wheel nuts that have been specifically designed for that wheel.
 - If there are any cracks or deformations in the bolt screws, nut threads or bolt holes of the wheel, have the vehicle inspected by your Toyota dealer.
 - When installing the wheel nuts, be sure to install them with the tapered ends facing inward.

Installing the spare tire

- 1 Remove any dirt or foreign matter from the wheel contact surface.

If foreign matter is on the wheel contact surface, the wheel nuts may loosen while the vehicle is in motion, causing the tire to come off.



- 2 Install the spare tire and loosely tighten each wheel nut by hand by approximately the same amount.

When replacing an aluminum wheel with a steel wheel, tighten the wheel nuts until the tapered portion comes into loose contact with the disc wheel seat.

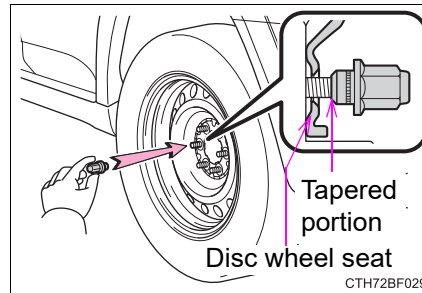

When replacing an aluminum wheel with an aluminum wheel, tighten the wheel nuts until the washers come into contact with the disc wheel.

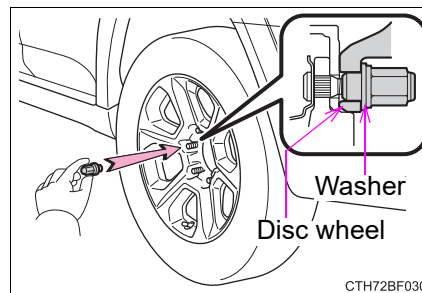

- 3 Lower the vehicle.

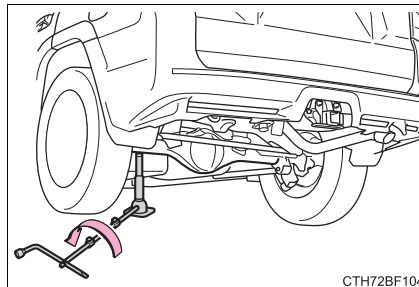

- 4 Firmly tighten each wheel nut two or three times in the order shown in the illustration.

Tightening torque

Steel wheels:
83 ft•lbf (112 N•m, 11.4 kgf•m)
Aluminum wheels:
76 ft•lbf (103 N•m, 10.5 kgf•m)

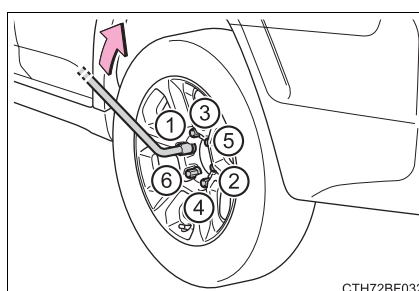

⚠ WARNING

■ **Stowing the flat tire**

Failure to follow steps listed under stowing the tire may result in damage to the spare tire carrier and lose of the tire, which could result in death or serious injury.

Stowing the flat/spare tire, jack and tools

- 1 Lay down the tire with the outer side facing up, and install the holding bracket, inserting the claw into the wheel lug nut hole. Turn the jack handle extension clockwise to take up slack in the chain.

Then, check to ensure the claw is in the wheel lug nut hole and the holding bracket is centered in the wheel hub.

- ① Holding bracket
- ② Claw

Vehicles without kinetic dynamic suspension: While raising, secure the tire, taking care that the tire goes straight up without catching on any surrounding part to prevent it from flying forward during a collision or sudden braking.

Vehicles with kinetic dynamic suspension: While raising, pull the tire towards the rear of the vehicle, taking care that the tire goes up without catching on any surrounding part to prevent it from flying forward during a collision or sudden braking.

Tightening torque:

34.4 ft•lbf (46.6 N•m, 4.8 kgf•m)

- 2 Confirm that the tire is not loose after tightening:

- ① Push and pull the tire
- ② Try rotating

Visually check to ensure the tire is not hung on surrounding parts. If looseness or misassembly exists, repeat step 1 and step 2.

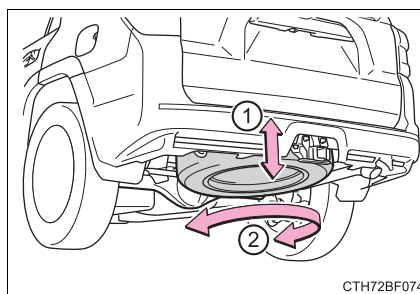
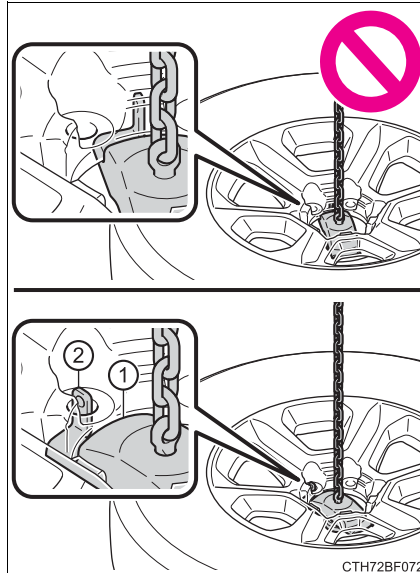

- 3 Repeat step 2 any time the tire is lowered or disturbed.
- 4 Stow the tools and jack securely.

■ **After completing the tire change**

The tire pressure warning system must be reset. (→P. 430)

■ **When using the spare tire (vehicles without P245/60R20 tires)**

As the spare tire is not equipped with a tire pressure warning valve and transmitter, low inflation pressure of the spare tire will not be indicated by the tire pressure warning system. Also, if you replace the spare tire after the tire pressure warning light comes on, the light remains on.

 NOTICE

■ **Do not drive the vehicle with a flat tire**

Do not continue driving with a flat tire.

Driving even a short distance with a flat tire can damage the tire and the wheel beyond repair.

■ **When stowing the flat tire**

Ensure that there is no object caught between the tire and the vehicle underbody.

■ **When replacing the tires**

● When removing or fitting the wheels, tires or the tire pressure warning valve and transmitter, contact your Toyota dealer as the tire pressure warning valve and transmitter may be damaged if not handled correctly.

● Replace the grommets for the tire pressure warning valves and transmitters as well.

■ **To avoid damage to the tire pressure warning valves and transmitters**

When a tire is repaired with liquid sealants, the tire pressure warning valve and transmitter may not operate properly. If a liquid sealant is used, contact your Toyota dealer or other qualified service shop as soon as possible. Make sure to replace the tire pressure warning valve and transmitter when replacing the tire. (→P. 430)

If the engine will not start

If the engine will not start even though correct starting procedures are being followed (→P. 199), consider each of the following points:

The engine will not start even though the starter motor operates normally.

One of the following may be the cause of the problem:

- There may not be sufficient fuel in the vehicle's tank.
Refuel the vehicle.
- The engine may be flooded.
Try to restart the engine again following correct starting procedures.
(→P. 199)
- There may be a malfunction in the engine immobilizer system.
(→P. 78)

The starter motor turns over slowly, the interior lights and headlights are dim, or the horn does not sound or sounds at a low volume.

One of the following may be the cause of the problem:

- The battery may be discharged. (→P. 515)
- The battery terminal connections may be loose or corroded.

The starter motor does not turn over

The engine starting system may be malfunctioning due to an electrical problem such as an open circuit or a blown fuse. However, an interim measure is available to start the engine. (→P. 510)

The starter motor does not turn over, the interior lights and headlights do not turn on, or the horn does not sound.

One of the following may be the cause of the problem:

- One or both of the battery terminals may be disconnected.
- The battery may be discharged. (→P. 515)

Contact your Toyota dealer if the problem cannot be repaired, or if repair procedures are unknown.

Emergency start function

When the engine does not start, the following steps can be used as an interim measure to start the engine if the engine switch is functioning normally:

- 1 Set the parking brake.
- 2 Shift the shift lever to P.
- 3 Turn the engine switch to ACCESSORY mode.
- 4 Press and hold the engine switch for about 15 seconds while depressing the brake pedal firmly.

Even if the engine can be started using the above steps, the system may be malfunctioning. Have the vehicle inspected by your Toyota dealer.

If you cannot operate back door opener

If the back door opener does not operate, there may be a problem with the back door opener system. Have the vehicle inspected by your Toyota dealer immediately.

The following steps may be used as an emergency measure to ensure that the back door can be opened from the inside.

- 1 Remove the cover on the back door trim.

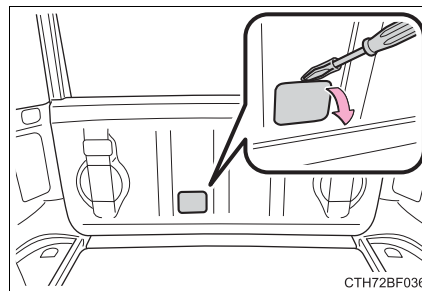

- 2 Tear the plastic film. Remove the cover.

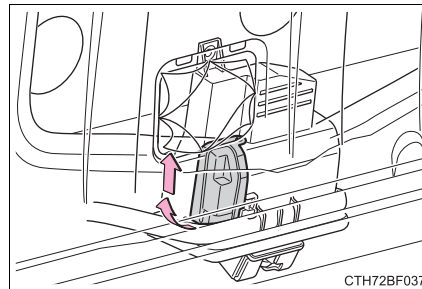

- 3 Pull the lever.

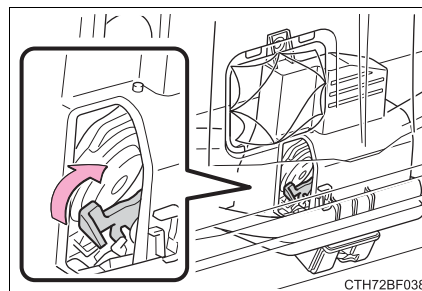

If the electronic key does not operate properly

If communication between the electronic key and vehicle is interrupted (→P. 117) or the electronic key cannot be used because the battery is depleted, the smart key system and wireless remote control cannot be used. In such cases, the doors can be opened and the engine can be started by following the procedure below.

Locking and unlocking the doors

Use the mechanical key (→P. 103) in order to perform the following operations:

- ① Locks all the doors
- ② Closes the windows and moon roof (turn and hold)* (→P. 156, 163)

- ③ Unlocks all the doors

Turning the key rearward unlocks the driver's door. Turning the key once again unlocks the other doors.

- ④ Opens the windows and moon roof (turn and hold)* (→P. 156, 163)

*: This setting must be customized at your Toyota dealer.

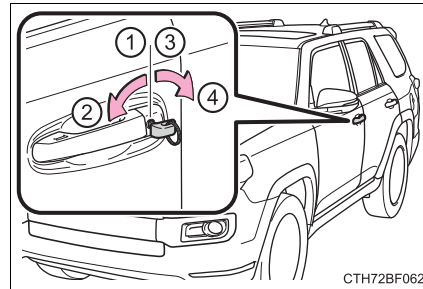

CTH72BF062

Starting the engine

- 1 Ensure that the shift lever is in P and depress the brake pedal.
- 2 Touch the Toyota emblem side of the electronic key to the engine switch.

When the electronic key is detected, a buzzer sounds and the engine switch will turn to IGNITION ON mode.

When the smart key system is deactivated in customization setting, the engine switch will turn to ACCESSORY mode.

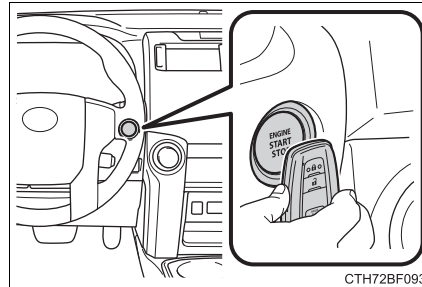

- 3 Firmly depress the brake pedal and check that  is displayed on the multi-information display.
- 4 Press the engine switch shortly and firmly.

In the event that the engine still cannot be started, contact your Toyota dealer.

■ Stopping the engine

Shift the shift lever to P and press the engine switch as you normally do when stopping the engine.

■ Replacing the key battery

As the above procedure is a temporary measure, it is recommended that the electronic key battery be replaced immediately when the battery is depleted. (→P. 447)

■ Changing engine switch modes

Within 10 seconds of the buzzer sounding, release the brake pedal and press the engine switch.

The engine does not start and modes will be changed each time the switch is pressed. (→P. 200)

■ When the electronic key does not work properly

- Make sure that the smart key system has not been deactivated in the customization setting. If it is off, turn the function on. (Customizable features: →P. 549)
- Check if battery-saving mode is set. If it is set, cancel the function. (→P. 116)

 **WARNING**

■ **When using the mechanical key and operating the power windows, power back window or moon roof**

Operate the power windows, power back window or moon roof after checking to make sure that there is no possibility of any passenger having any of their body parts caught in the window or moon roof.

Also, do not allow children to operate the mechanical key. It is possible for children and other passengers to get caught in the power windows, power back window or moon roof.

If the vehicle battery is discharged

The following procedures may be used to start the engine if the vehicle's battery is discharged.

You can also call your Toyota dealer or a qualified repair shop.

If you have a set of jumper (or booster) cables and a second vehicle with a 12-volt battery, you can jump start your vehicle by following the steps below.

- 1 Confirm that the electronic key is being carried.

When connecting the jumper (or booster) cables, depending on the situation, the alarm may activate and doors locked. (→P. 80)

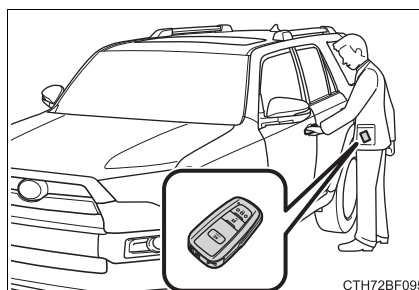

- 2 Open the hood (→P. 412)

- 3 Connect the jumper cables according to the following procedure:

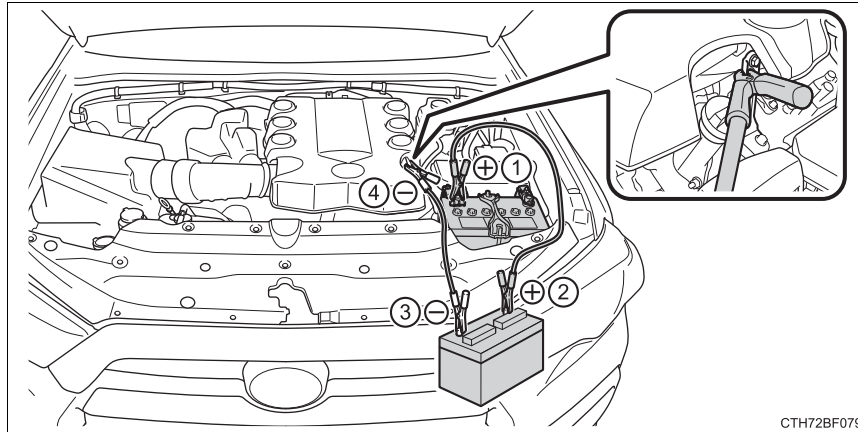

- ① Connect a positive jumper cable clamp to the positive (+) battery terminal on your vehicle.
- ② Connect the clamp on the other end of the positive cable to the positive (+) battery terminal on the second vehicle.
- ③ Connect a negative cable clamp to the negative (-) battery terminal on the second vehicle.
- ④ Connect the clamp at the other end of the negative cable to a solid, stationary, unpainted metallic point away from the battery and any moving parts, as shown in the illustration.
- 4 Start the engine of the second vehicle. Increase the engine speed slightly and maintain at that level for approximately 5 minutes to recharge the battery of your vehicle.
- 5 Open and close any of the doors of your vehicle with the engine switch off.
- 6 Maintain the engine speed of the second vehicle and turn the engine switch to IGNITION ON mode, then start the vehicle's engine.
- 7 Once the vehicle's engine has started, remove the jumper cables in the exact reverse order from which they were connected.

Once the engine starts, have the vehicle inspected at your Toyota dealer as soon as possible.

■ Starting the engine when the battery is discharged

The engine cannot be started by push-starting.

■ To prevent battery discharge

- Turn off the headlights and the audio system while the engine is off.
- Turn off any unnecessary electrical components when the vehicle is running at a low speed for an extended period, such as in heavy traffic.

■ Charging the battery

The electricity stored in the battery will discharge gradually even when the vehicle is not in use, due to natural discharge and the draining effects of certain electrical appliances. If the vehicle is left for a long time, the battery may discharge, and the engine may be unable to start. (The battery recharges automatically during driving.)

■ When recharging or replacing the battery

- In some cases, it may not be possible to unlock the doors using the smart key system when the battery is discharged. Use the wireless remote control or the mechanical key to lock or unlock the doors.
- The engine may not start on the first attempt after the battery has recharged but will start normally after the second attempt. This is not a malfunction.
- The engine switch mode is memorized by the vehicle. When the battery is reconnected, the system will return to the mode it was in before the battery was discharged. Before disconnecting the battery, turn the engine switch off. If you are unsure what mode the engine switch was in before the battery discharged, be especially careful when reconnecting the battery.
- Make sure that the key is not inside the vehicle when recharging or replacing the battery. The key may be locked in the vehicle if the alarm is activated. (→P. 80)

 **WARNING****■ Avoiding battery fires or explosions**

Observe the following precautions to prevent accidentally igniting the flammable gas that may be emitted from the battery:

- Make sure each jumper cable is connected to the correct terminal and that it is not unintentionally in contact with any other than the intended terminal.
- Do not allow the other end of the jumper cable connected to the “+” terminal to come into contact with any other parts or metal surfaces in the area, such as brackets or unpainted metal.
- Do not allow the + and - clamps of the jumper cables to come into contact with each other.
- Do not smoke, use matches, cigarette lighters or allow open flame near the battery.

■ Battery precautions

The battery contains poisonous and corrosive acidic electrolyte, while related parts contain lead and lead compounds. Observe the following precautions when handling the battery:

- When working with the battery, always wear safety glasses and take care not to allow any battery fluids (acid) to come into contact with skin, clothing or the vehicle body.
- Do not lean over the battery.
- In the event that battery fluid comes into contact with the skin or eyes, immediately wash the affected area with water and seek medical attention. Place a wet sponge or cloth over the affected area until medical attention can be received.
- Always wash your hands after handling the battery support, terminals, and other battery-related parts.
- Do not allow children near the battery.

 **NOTICE****■ When handling jumper cables**

When connecting the jumper cables, ensure that they do not become entangled in the cooling fans or engine drive belt.

If your vehicle overheats

The following may indicate that your vehicle is overheating:

- The needle of the engine coolant temperature gauge (→P. 88) enters the red zone or a loss of engine power is experienced. (For example, the vehicle speed does not increase.)
- Steam comes out from under the hood.

Correction procedures

- 1 Stop the vehicle in a safe place and turn off the air conditioning system, and then stop the engine.
- 2 If you see steam:
Carefully lift the hood after the steam subsides.
If you do not see steam:
Carefully lift the hood.
- 3 After the engine has cooled down sufficiently, inspect the hoses and radiator core (radiator) for any leaks.

- ① Radiator
- ② Cooling fan

If a large amount of coolant leaks, immediately contact your Toyota dealer.

- 4 The coolant level is satisfactory if it is between the “F” and “L” lines on the reservoir.

- ① Reservoir
- ② “F” line
- ③ “L” line
- ④ Radiator cap

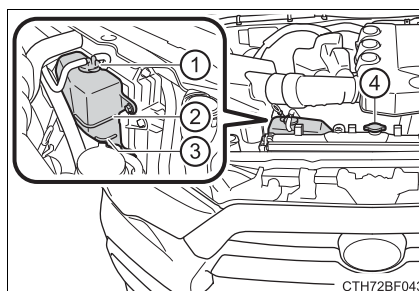
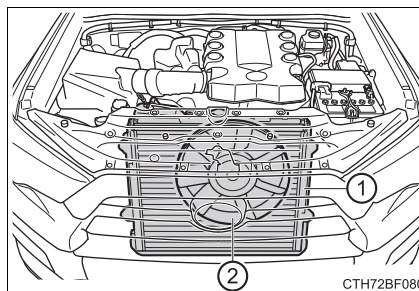

- 5 Add engine coolant if necessary. (→P. 414)

Water can be used in an emergency if engine coolant is unavailable.

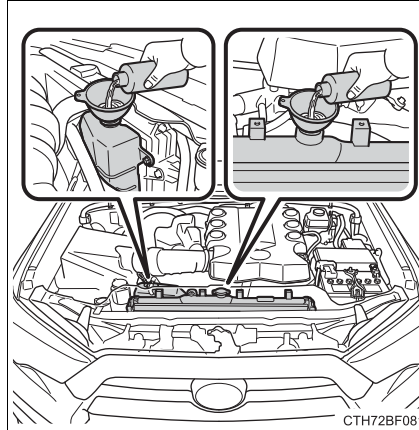

- 6 Start the engine to check that the radiator cooling fan operate and to check for coolant leaks from the radiator or hoses.

- 7 If the fan are not operating:
Stop the engine immediately and contact your Toyota dealer.

If the fan are operating:
Have the vehicle inspected at the nearest Toyota dealer.

⚠ WARNING

■ When inspecting under the hood of your vehicle

Observe the following precautions.

Failure to do so may result in serious injury such as burns.

- If steam is seen coming from under the hood, do not open the hood until the steam has subsided. The engine compartment may be very hot.
- Keep hands and clothing (especially a tie, a scarf or a muffler) away from the fans and belts.
- Do not loosen the radiator cap and the coolant reservoir cap while the engine and radiator are hot.
High temperature steam or coolant could spray out.

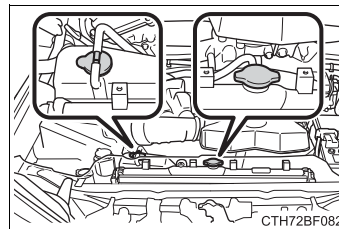

 NOTICE**■ When adding engine coolant**

Wait until the engine has cooled down before adding engine coolant. When adding coolant, do so slowly. Adding cool coolant to a hot engine too quickly can cause damage to the engine.

■ To prevent damage to the cooling system

Observe the following precautions:

- Avoid contaminating the coolant with foreign matter (such as sand or dust etc.).
- Do not use any coolant additives.

If the vehicle becomes stuck

Carry out the following procedures if the tires spin or the vehicle becomes stuck in mud, dirt or snow:

- 1 Stop the engine. Set the parking brake and shift the shift lever to P.
- 2 Remove the mud, snow or sand from around the stuck tire.
- 3 Place wood, stones or some other material under the tires to help provide traction.
- 4 Restart the engine.
- 5 Shift the shift lever to D or R position and carefully apply the accelerator to free the vehicle.

Turn off TRAC and VSC if these functions are hampering your attempts to free the vehicle. (→P. 324)

WARNING

■ When attempting to free a stuck vehicle

If you choose to push the vehicle back and forth to free it, make sure the surrounding area is clear to avoid striking other vehicles, objects or people. The vehicle may also lunge forward or lunge back suddenly as it becomes free. Use extreme caution.

■ When shifting the shift lever

Be careful not to shift the shift lever with the accelerator pedal depressed. This may lead to unexpected rapid acceleration of the vehicle that may cause an accident resulting in death or serious injury.

NOTICE

■ To avoid damaging the transmission and other components

- Avoid spinning the wheels and depressing the accelerator pedal more than necessary.
- If the vehicle remains stuck even after these procedures are performed, the vehicle may require towing to be freed.
- When a warning message for the automatic transmission fluid temperature is displayed while attempting to free a stuck vehicle, immediately remove your foot from the accelerator pedal and wait until the warning message disappears. Otherwise, the transmission may become damaged. (→P. 488)

Vehicle specifications

8

523

8-1. Specifications

- Maintenance data
(fuel, oil level, etc.)..... 524
- Fuel information 534
- Tire information 537

8-2. Customization

- Customizable features 549

8-3. Items to initialize

- Items to initialize 562

Maintenance data (fuel, oil level, etc.)

Dimensions and weights

Overall length	189.8 in. (4820 mm)	
Overall width	75.8 in. (1925 mm)	
Overall height *1	70.1 in. (1780 mm)	
Wheelbase	109.8 in. (2790 mm)	
Tread	Front	63.2 in. (1605 mm)
	Rear	63.2 in. (1605 mm)
Vehicle capacity weight (Occupants + luggage)	880 lb. (395 kg) ^{*2} 1000lb. (455 kg) ^{*4} 1165 lb. (525 kg) ^{*3}	
Trailer weight rating (trailer weight + cargo weight)	5000 lb. (2270 kg)	

*1: Unladen vehicle

*2: With 5 occupants

*3: With 7 occupants

*4: TRD-PRO

Seating capacity

Seating capacity	Vehicle without third seats	Vehicle with third seats
		5 (Front 2, Rear 3)

Vehicle identification

■ **Vehicle identification number**

The vehicle identification number (VIN) is the legal identifier for your vehicle. This is the primary identification number for your Toyota. It is used in registering the ownership of your vehicle.

This number is stamped on the top left of the instrument panel.

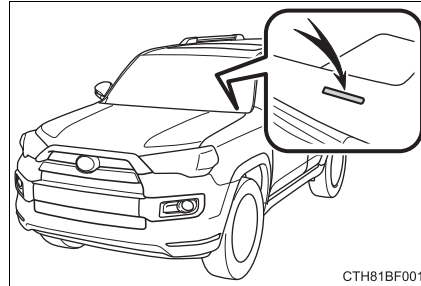

This number is also on the Certification Label.

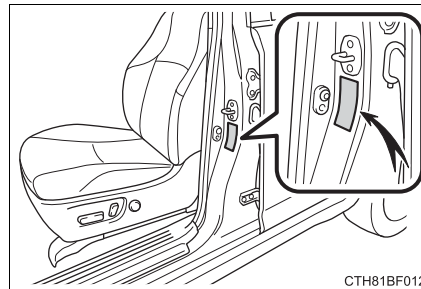

■ **Engine number**

The engine number is stamped on the engine block as shown.

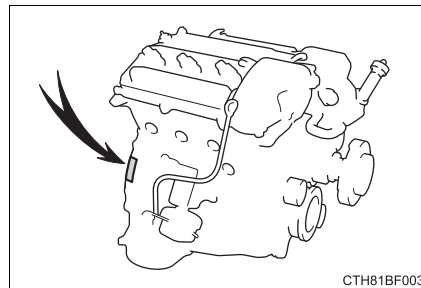

Engine

Model	1GR-FE
Type	6-cylinder V type, 4-cycle, gasoline
Bore and stroke	3.70 × 3.74 in. (94.0 × 95.0 mm)
Displacement	241.4 cu.in. (3956 cm ³)
Valve clearance (engine cold)	Automatic adjustment
Drive belt tension	Automatic adjustment

Fuel

Fuel type	Unleaded gasoline only
Octane rating	87 (Research octane number 91) or higher
Fuel tank capacity (Reference)	23.0 gal. (87.0 L, 19.1 Imp. gal.)

Lubrication system

Oil capacity (Drain and refill — reference [*])	
With filter	6.6 qt. (6.2 L, 5.5 Imp. qt.)
Without filter	6.0 qt. (5.7 L, 5.0 Imp. qt.)

^{*}: The engine oil capacity is a reference quantity to be used when changing the engine oil. Warm up and turn off the engine, wait more than 5 minutes, and check the oil level on the dipstick.

■ Engine oil selection

“Toyota Genuine Motor Oil” is used in your Toyota vehicle. Use Toyota approved “Toyota Genuine Motor Oil” or equivalent to satisfy the following grade and viscosity.

Oil grade: ILSAC GF-6A multigrade engine oil

Recommended viscosity: SAE 0W-20

SAE 0W-20 is the best choice for good fuel economy and good starting in cold weather.

If SAE 0W-20 is not available, SAE 5W-20 oil may be used. However, it must be replaced with SAE 0W-20 at the next oil change.

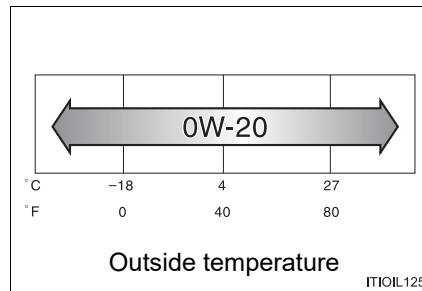

Oil viscosity (0W-20 is explained here as an example):

- The 0W in 0W-20 indicates the characteristic of the oil which allows cold startability. Oils with a lower value before the W allow for easier starting of the engine in cold weather.
- The 20 in 0W-20 indicates the viscosity characteristic of the oil when the oil is at high temperature. An oil with a higher viscosity (one with a higher value) may be better suited if the vehicle is operated at high speeds, or under extreme load conditions.

How to read oil container label:

The International Lubricant Specification Advisory Committee (ILSAC) Certification Mark is added to some oil containers to help you select the oil you should use.

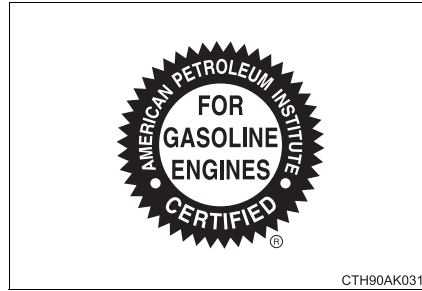

CTH90AK031

Cooling system

Capacity	11.1 qt. (10.5 L, 9.2 Imp. qt.)
Coolant type	<p>Use either of the following:</p> <ul style="list-style-type: none"> • “Toyota Super Long Life Coolant” • A similar high-quality ethylene glycol-based non-silicate, non-amine, non-nitrite, and non-borate coolant with long-life hybrid organic acid technology <p>Do not use plain water alone.</p>

Ignition system

Spark plug	
Make	DENSO SK16HR11
Gap	0.043 in. (1.1 mm)

 NOTICE

 **Iridium-tipped spark plugs**

Use only iridium-tipped spark plugs. Do not adjust the spark plug gap.

Electrical system

Battery	
Open voltage* at 68°F (20°C):	12.3 V or higher If the voltage is lower than the standard value, charge the battery.
Charging rates	5 A max.

*: Voltage checked 20 minutes after the engine and all the lights are turned off.

Transfer (4WD models)

Oil capacity	▶ Part-time 4WD models 1.1 qt. (1.0 L, 0.9 Imp. qt.) ▶ Full-time 4WD models 1.5 qt. (1.4 L, 1.2 Imp. qt.)
Oil type*	Toyota Genuine Transfer gear oil LF or equivalent
Recommended oil viscosity	SAE 75W

*: Your Toyota vehicle is filled with “Toyota Genuine Transfer Gear oil LF” at the factory. Use Toyota approved “Toyota Genuine Transfer Gear oil LF” or an equivalent of matching quality to satisfy the above specification. Please contact your Toyota dealer for further details.

Front differential (4WD models)

Oil capacity	<ul style="list-style-type: none"> ▶ Part-time 4WD models 1.6 qt. (1.55 L, 1.4 Imp. qt.) ▶ Full-time 4WD models 1.5 qt. (1.40 L, 1.2 Imp. qt.)
Oil type and viscosity*	Toyota Genuine Differential gear oil LT 75W-85 GL-5 or equivalent

*: Your Toyota vehicle is filled with “Toyota Genuine Differential Gear Oil” at the factory. Use Toyota approved “Toyota Genuine Differential Gear Oil” or an equivalent of matching quality to satisfy the above specification. Please contact your Toyota dealer for further details.

Rear differential

Oil capacity	<ul style="list-style-type: none"> ▶ Vehicles without a rear differential lock 2.9 qt. (2.70 L, 2.4 Imp. qt.) ▶ Vehicles with a rear differential lock 2.8 qt. (2.65 L, 2.3 Imp. qt.)
Oil type and viscosity*	Toyota Genuine Differential gear oil LT 75W-85 GL-5 or equivalent

*: Your Toyota vehicle is filled with “Toyota Genuine Differential Gear Oil” at the factory. Use Toyota approved “Toyota Genuine Differential Gear Oil” or an equivalent of matching quality to satisfy the above specification. Please contact your Toyota dealer for further details.

Automatic transmission

Fluid capacity*	11.3 qt. (10.7 L, 9.4 Imp. qt.)
Fluid type	Toyota Genuine ATF WS

*: The fluid capacity is a reference quantity. If replacement is necessary, contact your Toyota dealer.

NOTICE

■ Transmission fluid type

Using transmission fluid other than the above type may cause abnormal noise or vibration, or damage the transmission of your vehicle.

Brakes

Pedal clearance* ¹	▶ 2WD models 3.36 in. (86 mm) Min. ▶ 4WD models 3.54 in. (90 mm) Min.
Pedal free play	Less than 0.04 — 0.24 in. (1 — 6 mm)
Brake pad wear limit	0.04 in. (1.0 mm)
Parking brake lining wear limit	0.04 in. (1.0 mm)
Parking brake pedal travel* ²	5 — 7 clicks
Fluid type	SAE J1703 or FMVSS No.116 DOT 3

*¹: Minimum pedal clearance when depressed with a force of 110 lbf (490 N, 50 kgf) while the engine is running.

*²: Parking brake pedal travel when depressed with a force of 67 lbf (300 N, 30 kgf).

Chassis lubrication

Propeller shafts	Spider	Lithium base chassis grease, NLGI No.2
	Slide yoke	Molybdenum-disulfide lithium base chassis grease, NLGI No.2 or lithium base chassis grease, NLGI No.2

Steering

Free play	Less than 1.2 in. (30 mm)
Power steering fluid type	Automatic transmission fluid DEXRON® II or III

Tires and wheels

Tire size	P265/70R17 113S, P245/60R20 107H
Tire inflation pressure (Recommended cold tire inflation pressure)	Front: 32 psi (220 kPa, 2.2 kgf/cm ² or bar) Rear: 32 psi (220 kPa, 2.2 kgf/cm ² or bar) Spare: 32 psi (220 kPa, 2.2 kgf/cm ² or bar)
Wheel size	17 × 7J, 17 × 7 1/2J, 20 × 7J
Wheel nut torque	Steel wheels: 83 ft•lbf (112 N•m, 11.4 kgf•m) Aluminum wheels: 76 ft•lbf (103 N•m, 10.5 kgf•m)

Light bulbs

	Light bulbs	Bulb No.	W	Type
Exterior	Headlight high beam (if equipped) /daytime running lights	9005	60	A
	Front turn signal and parking lights	7444NA	28/8	C
	Front side marker lights	—	5	B
	Rear turn signal lights	—	21	C
	Back-up lights	—	16	B
	License plate lights	—	5	B
Interior	Front personal/ front interior lights	—	5	B
	Rear interior light	—	8	D
	Vanity lights	—	8	B
	Door courtesy lights	168	5	B
	Luggage compartment lights	—	8	D

A: HB3 halogen bulbs

C: Wedge base bulbs (amber)

B: Wedge base bulbs (clear)

D: Double end bulbs

Fuel information

You must only use unleaded gasoline.

Select octane rating 87 (Research Octane Number 91) or higher. Use of unleaded gasoline with an octane rating lower than 87 may result in engine knocking. Persistent knocking can lead to engine damage.

At minimum, the gasoline you use should meet the specifications of ASTM D4814 in the U.S.A..

■ Gasoline quality

In very few cases, driveability problems may be caused by the brand of gasoline you are using. If driveability problems persist, try changing the brand of gasoline. If this does not correct the problem, consult your Toyota dealer.

■ Recommendation of the use of gasoline containing detergent additives

- Toyota recommends the use of gasoline that contains detergent additives to avoid the build-up of engine deposits.
- All gasoline sold in the U.S.A. contains minimum detergent additives to clean and/or keep clean intake systems, per EPA's lowest additives concentration program.
- Toyota strongly recommends the use of Top Tier Detergent Gasoline. For more information on Top Tier Detergent Gasoline and a list of marketers, please go to the official website www.toptiergas.com.

■ Recommendation of the use of low emissions gasoline

Gasolines containing oxygenates such as ethers and ethanol, as well as reformulated gasolines, are available in some cities. These fuels are typically acceptable for use, providing they meet other fuel requirements.

Toyota recommends these fuels, since the formulations allow for reduced vehicle emissions.

■ Non-recommendation of the use of blended gasoline

- Use only gasoline containing up to 15% ethanol.
DO NOT use any flex-fuel or gasoline that could contain more than 15% ethanol, including from any pump labeled E30, E50, E85 (which are only some examples of fuel containing more than 15% ethanol).

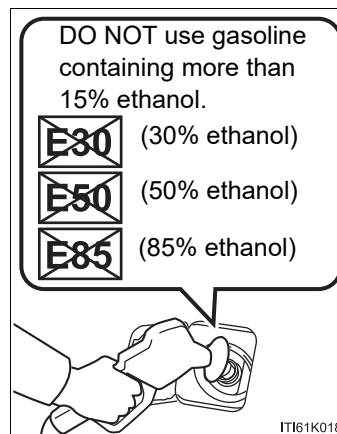

- If you use gasohol in your vehicle, be sure that it has an octane rating no lower than 87.
- Toyota does not recommend the use of gasoline containing methanol.

■ **Non-recommendation of the use of gasoline containing MMT**

Some gasoline contains an octane enhancing additive called MMT (Methylcyclopentadienyl Manganese Tricarbonyl).

Toyota does not recommend the use of gasoline that contains MMT. If fuel containing MMT is used, your emission control system may be adversely affected.

The malfunction indicator lamp on the instrument cluster may come on. If this happens, contact your Toyota dealer for service.

■ **If your engine knocks**

- Consult your Toyota dealer.
- You may occasionally notice light knocking for a short time while accelerating or driving uphill. This is normal and there is no need for concern.



NOTICE

■ **Notice on fuel quality**

- Do not use improper fuels. If improper fuels are used, the engine will be damaged.
- Do not use leaded gasoline.
Leaded gasoline can cause damage to your vehicle's three-way catalytic converters causing the emission control system to malfunction.
- Do not use gasohol other than the type previously stated.
Other gasohol may cause fuel system damage or vehicle performance problems.
- Using unleaded gasoline with an octane number or rating lower than the level previously stated will cause persistent heavy knocking.
At worst, this will lead to engine damage.

■ **Fuel-related poor driveability**

If poor driveability (poor hot starting, vaporization, engine knocking, etc.) is encountered after using a different type of fuel, discontinue the use of that type of fuel.

■ **When refueling with gasohol**

Take care not to spill gasohol. It can damage your vehicle's paint.

Tire information

Typical tire symbols

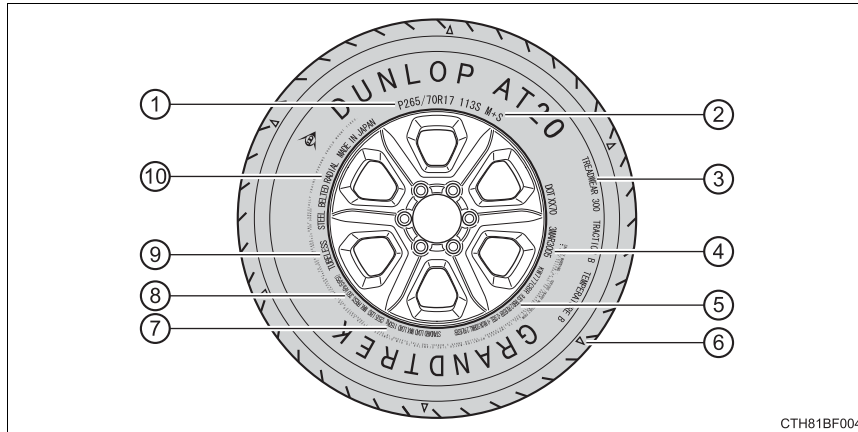

- ① Tire size (→P. 539)
- ② Summer tires or all season tires (→P. 434)
An all season tire has “M+S” on the sidewall. A tire not marked “M+S” is a summer tire.
- ③ Uniform tire quality grading
For details, see “Uniform Tire Quality Grading” that follows.
- ④ DOT and Tire Identification Number (TIN) (→P. 538)
- ⑤ Tire ply composition and materials
Plies are layers of rubber-coated parallel cords. Cords are the strands which form the plies in a tire.
- ⑥ Location of treadwear indicators (→P. 427)

- ⑦ Load limit at maximum cold tire inflation pressure (→P. 543)
- ⑧ Maximum cold tire inflation pressure (→P. 543)
This means the pressure to which a tire may be inflated.
- ⑨ TUBELESS or TUBE TYPE
A tubeless tire does not have a tube and air is directly put into the tire. A tube type tire has a tube inside the tire and the tube maintains the air pressure.
- ⑩ Radial tires or bias-ply tires
A radial tire has "RADIAL" on the sidewall. A tire not marked "RADIAL" is a bias-ply tire.

Typical DOT and Tire Identification Number (TIN)

▶ Type A

▶ Type B

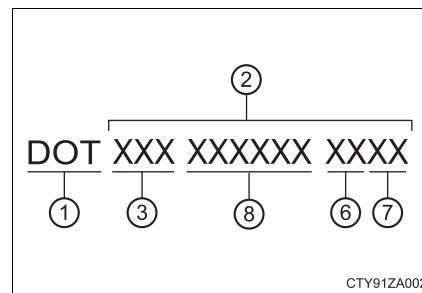
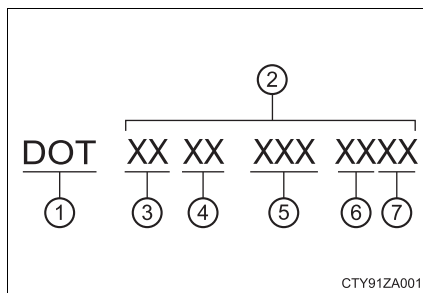

- ① DOT symbol*
- ② Tire Identification Number (TIN)
- ③ Tire manufacturer's identification mark
- ④ Tire size code
- ⑤ Manufacturer's optional tire type code (3 or 4 letters)
- ⑥ Manufacturing week
- ⑦ Manufacturing year
- ⑧ Manufacturer's code

*: The DOT symbol certifies that the tire conforms to applicable Federal Motor Vehicle Safety Standards.

Tire size

■ Typical tire size information

The illustration indicates typical tire size.

- ① Tire use (P = Passenger car, T = Temporary use)
- ② Section width (millimeters)
- ③ Aspect ratio (tire height to section width)
- ④ Tire construction code (R = Radial, D = Diagonal)
- ⑤ Wheel diameter (inches)
- ⑥ Load index (2 digits or 3 digits)
- ⑦ Speed symbol (alphabet with one letter)

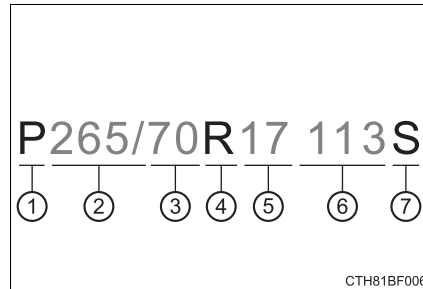

■ Tire dimensions

- ① Section width
- ② Tire height
- ③ Wheel diameter

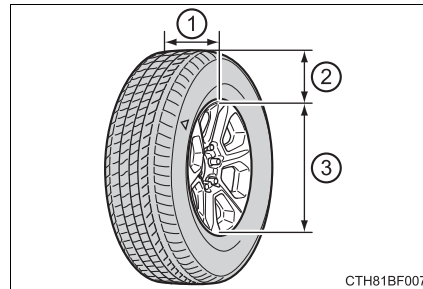

Tire section names

- ① Bead
- ② Sidewall
- ③ Shoulder
- ④ Tread
- ⑤ Belt
- ⑥ Inner liner
- ⑦ Reinforcing rubber
- ⑧ Carcass
- ⑨ Rim lines
- ⑩ Bead wires
- ⑪ Chafer

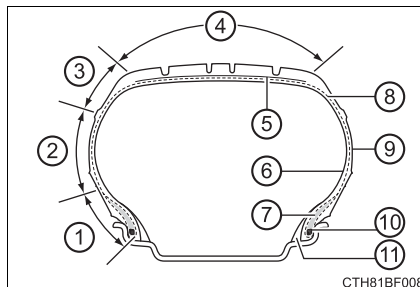

Uniform Tire Quality Grading

This information has been prepared in accordance with regulations issued by the National Highway Traffic Safety Administration of the U.S. Department of Transportation.

It provides the purchasers and/or prospective purchasers of Toyota vehicles with information on uniform tire quality grading.

Your Toyota dealer will help answer any questions you may have as you read this information.

■ DOT quality grades

All passenger vehicle tires must conform to Federal Safety Requirements in addition to these grades. Quality grades can be found where applicable on the tire sidewall between tread shoulder and maximum section width.

For example: Treadwear 200 Traction AA Temperature A

■ Treadwear

The treadwear grade is a comparative rating based on the wear rate of the tire when tested under controlled conditions on a specified government test course.

For example, a tire graded 150 would wear one and a half (1 - 1/2) times as well on the government course as a tire graded 100.

The relative performance of tires depends upon the actual conditions of their use. Performance may differ significantly from the norm due to variations in driving habits, service practices and differences in road characteristics and climate.

■ Traction AA, A, B, C

The traction grades, from highest to lowest, are AA, A, B and C, and they represent the tire's ability to stop on wet pavement as measured under controlled conditions on specified government test surfaces of asphalt and concrete.

A tire marked C may have poor traction performance.

Warning: The traction grade assigned to this tire is based on braking (straight ahead) traction tests and does not include cornering (turning) traction.

■ **Temperature A, B, C**

The temperature grades are A (the highest), B, and C, representing the tire's resistance to the generation of heat and its ability to dissipate heat when tested under controlled conditions on a specified indoor laboratory test wheel.

Sustained high temperature can cause the material of the tire to degenerate and reduce tire life, and excessive temperature can lead to sudden tire failure.

Grade C corresponds to a level of performance which all passenger car tires must meet under the Federal Motor Vehicle Safety Standard No. 109.

Grades B and A represent higher levels of performance on the laboratory test wheel than the minimum required by law.

Warning: The temperature grades of a tire assume that it is properly inflated and not overloaded.

Excessive speed, underinflation, or excessive loading, either separately or in combination, can cause heat buildup and possible tire failure.

Glossary of tire terminology

Tire related term	Meaning
Cold tire inflation pressure	Tire pressure when the vehicle has been parked for three hours or more, or has not been driven more than 1 mile or 1.5 km under that condition
Maximum inflation pressure	The maximum cold inflated pressure to which a tire may be inflated, shown on the sidewall of the tire
Recommended inflation pressure	Cold tire inflation pressure recommended by a manufacturer
Accessory weight	The combined weight (in excess of those standard items which may be replaced) of automatic transmission, power steering, power brakes, power windows, power seats, radio and heater, to the extent that these items are available as factory-installed equipment (whether installed or not)
Curb weight	The weight of a motor vehicle with standard equipment, including the maximum capacity of fuel, oil and coolant, and if so equipped, air conditioning and additional weight optional engine
Maximum loaded vehicle weight	The sum of: (a) Curb weight (b) Accessory weight (c) Vehicle capacity weight (d) Production options weight
Normal occupant weight	150 lb. (68 kg) times the number of occupants specified in the second column of Table 1* that follows
Occupant distribution	Distribution of occupants in a vehicle as specified in the third column of Table 1* below

Tire related term	Meaning
Production options weight	The combined weight of installed regular production options weighing over 5 lb. (2.3 kg) in excess of the standard items which they replace, not previously considered in curb weight or accessory weight, including heavy duty brakes, ride levelers, roof rack, heavy duty battery, and special trim
Rim	A metal support for a tire or a tire and tube assembly upon which the tire beads are seated
Rim diameter (Wheel diameter)	Nominal diameter of the bead seat
Rim size designation	Rim diameter and width
Rim type designation	The industry manufacturer's designation for a rim by style or code
Rim width	Nominal distance between rim flanges
Vehicle capacity weight (Total load capacity)	The rated cargo and luggage load plus 150 lb. (68 kg) times the vehicle's designated seating capacity
Vehicle maximum load on the tire	The load on an individual tire that is determined by distributing to each axle its share of the maximum loaded vehicle weight, and dividing by two
Vehicle normal load on the tire	The load on an individual tire that is determined by distributing to each axle its share of curb weight, accessory weight, and normal occupant weight (distributed in accordance with Table 1* below), and dividing by two
Weather side	The surface area of the rim not covered by the inflated tire
Bead	The part of the tire that is made of steel wires, wrapped or reinforced by ply cords and that is shaped to fit the rim
Bead separation	A breakdown of the bond between components in the bead

Tire related term	Meaning
Bias ply tire	A pneumatic tire in which the ply cords that extend to the beads are laid at alternate angles substantially less than 90 degrees to the centerline of the tread
Carcass	The tire structure, except tread and sidewall rubber which, when inflated, bears the load
Chunking	The breaking away of pieces of the tread or sidewall
Cord	The strands forming the plies in the tire
Cord separation	The parting of cords from adjacent rubber compounds
Cracking	Any parting within the tread, sidewall, or innerliner of the tire extending to cord material
CT	A pneumatic tire with an inverted flange tire and rim system in which the rim is designed with rim flanges pointed radially inward and the tire is designed to fit on the underside of the rim in a manner that encloses the rim flanges inside the air cavity of the tire
Extra load tire	A tire designed to operate at higher loads and at higher inflation pressures than the corresponding standard tire
Groove	The space between two adjacent tread ribs
Innerliner	The layer(s) forming the inside surface of a tubeless tire that contains the inflating medium within the tire
Innerliner separation	The parting of the innerliner from cord material in the carcass
Intended outboard sidewall	(a) The sidewall that contains a whitewall, bears white lettering, or bears manufacturer, brand, and/or model name molding that is higher or deeper than the same molding on the other sidewall of the tire, or (b) The outward facing sidewall of an asymmetrical tire that has a particular side that must always face outward when mounted on a vehicle

Tire related term	Meaning
Light truck (LT) tire	A tire designated by its manufacturer as primarily intended for use on lightweight trucks or multipurpose passenger vehicles
Load rating	The maximum load that a tire is rated to carry for a given inflation pressure
Maximum load rating	The load rating for a tire at the maximum permissible inflation pressure for that tire
Maximum permissible inflation pressure	The maximum cold inflation pressure to which a tire may be inflated
Measuring rim	The rim on which a tire is fitted for physical dimension requirements
Open splice	Any parting at any junction of tread, sidewall, or innerliner that extends to cord material
Outer diameter	The overall diameter of an inflated new tire
Overall width	The linear distance between the exteriors of the sidewalls of an inflated tire, including elevations due to labeling, decorations, or protective bands or ribs
Passenger car tire	A tire intended for use on passenger cars, multipurpose passenger vehicles, and trucks, that have a gross vehicle weight rating (GVWR) of 10,000 lb. or less.
Ply	A layer of rubber-coated parallel cords
Ply separation	A parting of rubber compound between adjacent plies
Pneumatic tire	A mechanical device made of rubber, chemicals, fabric and steel or other materials, that, when mounted on an automotive wheel, provides the traction and contains the gas or fluid that sustains the load
Radial ply tire	A pneumatic tire in which the ply cords that extend to the beads are laid at substantially 90 degrees to the centerline of the tread
Reinforced tire	A tire designed to operate at higher loads and at higher inflation pressures than the corresponding standard tire

Tire related term	Meaning
Section width	The linear distance between the exteriors of the sidewalls of an inflated tire, excluding elevations due to labeling, decoration, or protective bands
Sidewall	That portion of a tire between the tread and bead
Sidewall separation	The parting of the rubber compound from the cord material in the sidewall
Snow tire	A tire that attains a traction index equal to or greater than 110, compared to the ASTM E-1136 Standard Reference Test Tire, when using the snow traction test as described in ASTM F-1805-00, Standard Test Method for Single Wheel Driving Traction in a Straight Line on Snow-and Ice-Covered Surfaces, and which is marked with an Alpine Symbol () on at least one sidewall
Test rim	The rim on which a tire is fitted for testing, and may be any rim listed as appropriate for use with that tire
Tread	That portion of a tire that comes into contact with the road
Tread rib	A tread section running circumferentially around a tire
Tread separation	Pulling away of the tread from the tire carcass
Treadwear indicators (TWI)	The projections within the principal grooves designed to give a visual indication of the degrees of wear of the tread
Wheel-holding fixture	The fixture used to hold the wheel and tire assembly securely during testing

*: Table 1 — Occupant loading and distribution for vehicle normal load for various designated seating capacities

Designated seating capacity, Number of occupants	Vehicle normal load, Number of occupants	Occupant distribution in a normally loaded vehicle
2 through 4	2	2 in front
5 through 10	3	2 in front, 1 in second seat
11 through 15	5	2 in front, 1 in second seat, 1 in third seat, 1 in fourth seat
16 through 20	7	2 in front, 2 in second seat, 2 in third seat, 1 in fourth seat

Customizable features







Your vehicle includes a variety of electronic features that can be personalized to suit your preferences. The settings of these features can be changed by using the steering wheel switches, navigation system, multimedia system or at your Toyota dealer.

It is also possible to customize certain vehicle features yourself using the multi-information display.

Customizing vehicle features

When customizing vehicle features, ensure that the vehicle is parked in a safe place with the shift lever in P and the parking brake set.

■ Changing by using the multi-information display

- 1 Use the meter control switches to select  on the multi-information display.
- 2 Choose the desired item using  or , and then press .
- 3 Select the desired setting by operating  or , and then press .

To stop the selection, press  to return to the previous screen.

■ Changing on the audio system screen

- 1 Press the "MENU" button.
- 2 Select "Setup" on the "Menu" screen.
- 3 Select "General" or "Vehicle" on the "Setup" screen.

Various setting can be changed. Refer to the list of settings that can be changed for details.

Customizable features

Some function settings are changed simultaneously with other functions being customized. Contact your Toyota dealer for further details.

- ① Settings that can be changed using the meter control switches
- ② Settings that can be changed using the navigation system or the multimedia system
- ③ Settings that can be changed by your Toyota dealer

Definition of symbols: O = Available, – =Not available

■ Door lock (→P. 106, 124, 512)

Function	Default setting	Customized setting	①	②	③
Unlocking using a key	Driver's door unlocked in one step, all doors unlocked in two steps	All doors unlocked in one step	–	–	O
Automatic door lock	Shift position linked door locking operation	Off	–	O	O
		Speed linked door locking operation			
Automatic door unlock	Shift position linked door unlocking operation	Off	–	O	O
		Driver's door linked door unlocking operation			

■ **Smart key system and wireless remote control**
 (→P. 106, 113, 124)

Function	Default setting	Customized setting	①	②	③
Operation signal (buzzer)	Level 5	Off	-	O	O
		Level 1 to 7			
Operation signal (Emergency flashers)	On	Off	-	O	O
Time elapsed before the automatic door lock function is activated if a door is not opened after being unlocked	60 seconds	OFF	-	O	O
		30 seconds			
		120 seconds			
Open door warning function (When locking the vehicle)	On	Off	-	-	O

■ **Smart key system (→P. 106, 113, 124)**

Function	Default setting	Customized setting	①	②	③
Smart door unlocking	Driver's door	All the doors	-	O	O
Smart key system	On	Off	-	-	O
Number of consecutive door lock operations	2 times	As many as desired	-	-	O

■ Wireless remote control (→P. 102, 106, 124)

Function	Default setting	Customized setting	①	②	③
Wireless remote control	On	Off	–	–	○
Panic function	On	Off	–	–	○
Unlocking operation	Driver's door unlocked in one step, all doors unlocked in two steps	All doors unlocked in one step	–	○	○

■ Driving position memory* (→P. 142)

Function	Default setting	Customized setting	①	②	③
Selecting the door linking driving position memory with door unlock operation	Driver's door	All doors	–	–	○

*: If equipped

■ Automatic light control system* (→P. 212)

Function	Default setting	Customized setting	①	②	③
Time elapsed before headlights automatically turn off after doors are closed	30 seconds	Off	–	○	○
		60 seconds			
		90 seconds			
Light sensor sensitivity	Level 3	Levels 1 to 5	–	○	○

*: If equipped

■ Interior lights (→P. 360)

Function	Default setting	Customized setting	①	②	③
Time elapsed before the interior lights turn off	15 seconds	Off			
		7.5 seconds	–	○	○
		30 seconds			
Operation after the engine switch is turned to OFF	On	Off	–	–	○
Operation when the doors are unlocked with the smart key system or wireless remote control	On	Off	–	–	○
Operation when you approach the vehicle with the electronic key on your person	On	Off	–	–	○
Operation of the footwell lights*	On	Off	–	–	○
Lounge illumination control*	On	Off	–	–	○

*: If equipped

■ Exterior lights (→P. 212, 240)

Function	Default setting	Customized setting	①	②	③
Daytime running light system	On	Off*2	–	○	○
Time elapsed before the exterior lights turn off	15 seconds	Off	–	○	○
		7.5 seconds			
		30 seconds			
Operation of the outer foot lights*1 when you approach the vehicle with the electronic key on your person	On	Off	–	–	○
Operation of the outer foot lights*1 when the doors are unlocked with the power door lock switch	On	Off	–	–	○

*1: If equipped

*2: Except for Canada

■ Meters (→P. 88)

Function	Default setting	Customized setting	①	②	③
Sensitivity of the ambient light sensor used for dimming the meter lights etc.*	Standard	-2 to 2	-	-	0
Sensitivity of the ambient light sensor used for brightening the meter lights etc.*	Standard	-2 to 2	-	-	0

*: If equipped

■ Front automatic air conditioning system* (→P. 349)

Function	Default setting	Customized setting	①	②	③
Switching between outside air and recirculated air mode linked to automatic mode button operation	Auto	Manual	-	0	0
A/C automatic mode button operation	Auto	Manual	-	0	0

*: If equipped

■ Power windows (→P. 155)

Function	Default setting	Customized setting	①	②	③
Mechanical key linked operation (close)	Off	On	-	-	O
Mechanical key linked operation (open)	Off	On	-	-	O
Wireless remote control linked operation (open)	Off	On	-	-	O
Wireless remote control linked operation (buzzer)	On	Off	-	-	O

■ Moon roof* (→P. 161)

Function	Default setting	Customized setting	①	②	③
Mechanical key linked operation	Off	On	-	-	O
Mechanical key linked operation	Open and close	Open only	-	-	O
		Close only			
Linked operation of components when door key is used	Slide only	Tilt only	-	-	O
Wireless remote control linked operation (open only)	Off	On	-	-	O
Linked operation of components when wireless remote control is used (open only)	Slide only	Tilt only	-	-	O

*: If equipped

■ Rear window wiper and washer (→P. 223)

Function	Default setting	Customized setting	①	②	③
Wiper operates automatically when washer is operated	On	Off	–	–	○
Drip prevention function	On	Off	–	–	○
Wiper operation interval	3 seconds	2 seconds	–	–	○
		4 seconds			
		5 seconds			
Time elapsed before the rear wiper storage function activates	3 seconds	4 seconds	–	–	○
		5 seconds			
		6 seconds			

■ Power back window (→P. 124)

Function	Default setting	Customized setting	①	②	③
Close operation linked to door lock operation using the switch	On	Off	–	–	○
Open operation linked to door unlock operation using the switch	On	Off	–	–	○
Time required to press and hold the switch before the window begins to open/close	0.8 seconds	1 second	–	–	○
		1.2 seconds			
		1.4 seconds			

■ BSM (Blind Spot Monitor) (→P. 270)

Function	Default setting	Customized setting	①	②	③
BSM	On	Off	○	–	–
Outside rear view mirror indicator brightness	Bright	Dim	○	–	–
		Blank			
Sensitivity	Intermediate	Early	○	–	–
		Late			
		Only when in blind spot			

■ RCTA (Rear Cross Traffic Alert) (→P. 286)

Function	Default setting	Customized setting	①	②	③
RCTA	On	Off	○	–	–
RCTA buzzer volume	2	1 to 3	–	–	○

■ Toyota parking assist-sensor* (→P. 277)

Function	Default setting	Customized setting	①	②	③
Detection distance of the rear center sensor	Far	Near	–	○	○
Buzzer volume	Level 2	Level 1 to 3	–	○	○

*: If equipped

■ Seat belt reminder (→P. 477)

Function	Default setting	Customized setting	①	②	③
Vehicle speed linked seat belt reminder buzzer	On	Off	–	–	○

■ Multi-information display (→P. 90)

Function	Default setting	Customized setting	①	②	③
Language* ¹	English	French	○	–	○
		Spanish			
Units* ¹	miles (MPG)	km (L/100km)	○	–	○
Eco Driving Indicator Light	On	Off	○	–	○
 switch settings	After start	Desired status screen* ²	○	–	○
Pop-up display	On	Off	○	–	○
Rear seat reminder function	On	Off	○	–	–



*1: The default setting varies according to countries.

*2: Some status screens cannot be registered (indicated on multi-information display).

■ LDA (Lane Departure Alert) (→P. 249)

Function	Customized setting	①	②	③
Alert sensitivity	High, Standard	○	–	○
Vehicle sway warning function	On, Off	○	–	○
Vehicle sway warning sensitivity	High, Standard, Low	○	–	○

■ PCS (Pre-Collision System) (→P. 239)

Function	Customized setting	①	②	③
PCS (Pre-Collision System)*	On, Off	○	–	○
Alert timing	 (Far),  (Middle),  (Near)	○	–	○

*: The system is automatically enabled each time the engine switch is turned to ON.

■ **In the following situations, customize mode will automatically be turned off.**

- A warning message appears after the customize mode screen is displayed.
- The engine switch is turned to OFF.
- The vehicle begins to move while the customize mode screen is displayed.

 **WARNING**

■ **During customization**

As the engine needs to be running during customization, ensure that the vehicle is parked in a place with adequate ventilation. In a closed area such as a garage, exhaust gases including harmful carbon monoxide (CO) may collect and enter the vehicle. This may lead to death or a serious health hazard.

 **NOTICE**

■ **During customization**

To prevent battery discharge, ensure that the engine is running while customizing features.

Items to initialize

The following item must be initialized for normal system operation after such cases as the battery being reconnected, or maintenance being performed on the vehicle:

Item	When to initialize	Reference
Message indicating maintenance is required	After the maintenance is performed	P. 404
Tire pressure warning system	<ul style="list-style-type: none"> • When the tire inflation pressure is changed such as when changing traveling speed or load weight • When the tire inflation pressure is changed such as when the tire size is changed • When rotating the tires • After performing the transmitter ID code registration procedure 	P. 430

For owners

9

563

Reporting safety defects
for U.S. owners..... 564

Reporting safety defects
for Canadian owners 565

Seat belt instructions
for Canadian owners
(in French) 566

SRS airbag instructions
for Canadian owners
(in French) 568

Reporting safety defects for U.S. owners

If you believe that your vehicle has a defect which could cause a crash or could cause injury or death, you should immediately inform the National Highway Traffic Safety Administration (NHTSA) in addition to notifying Toyota Motor Sales, U.S.A., Inc. (Toll-free: 1-800-331-4331).

If NHTSA receives similar complaints, it may open an investigation, and if it finds that a safety defect exists in a group of vehicles, it may order a recall and remedy campaign. However, NHTSA cannot become involved in individual problems between you, your dealer, or Toyota Motor Sales, U.S.A., Inc.

To contact NHTSA, you may call the Vehicle Safety Hotline toll-free at 1-888-327-4236 (TTY: 1-800-424-9153); go to <http://www.safercar.gov>; or write to: Administrator, NHTSA, 1200 New Jersey Ave. SE., Washington, DC 20590. You can also obtain other information about motor vehicle safety from <http://www.safercar.gov>.

Reporting safety defects for Canadian owners

Canadian customers who wish to report a safety-related defect to Transport Canada, Defects Investigations and Recalls, may telephone the toll-free hotline 1-800-333-0510, mail Transport Canada - ASFAD, 330 Sparks Street, Ottawa, ON, K1A 0N5, or complete the online form at <https://www.tc.gc.ca/recalls>.

6

For owners

Seat belt instructions for Canadian owners (in French)

The following is a French explanation of seat belt instructions extracted from the seat belt section in this manual.

See the seat belt section for more detailed seat belt instructions in English.

Utilisation correcte des ceintures de sécurité

- Déroulez la sangle diagonale de telle sorte qu'elle passe bien sur l'épaule, sans pour autant être en contact avec le cou ou glisser de l'épaule.
- Placez la sangle abdominale le plus bas possible sur les hanches.
- Réglez la position du dossier de siège. Asseyez-vous le dos le plus droit possible et calez-vous bien dans le siège.
- Ne vrillez pas la ceinture de sécurité.

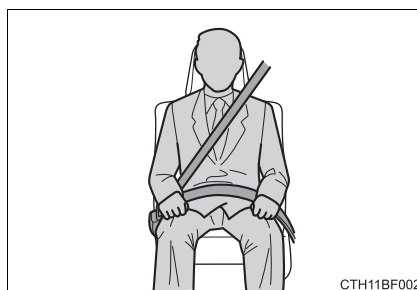

Entretien et soin

■ Ceintures de sécurité

Nettoyez avec un chiffon ou une éponge humectée d'eau savonneuse tiède. Vérifiez régulièrement que les ceintures ne sont pas effilochées, entaillées ou exagérément usées.

 WARNING**■ Détérioration et usure des ceintures de sécurité**

Inspectez les ceintures de sécurité périodiquement. Contrôlez qu'elles ne sont pas entaillées, effilochées et que leurs ancrages ne sont pas desserrés. N'utilisez pas une ceinture de sécurité défectueuse avant qu'elle ne soit remplacée. Une ceinture de sécurité défectueuse n'apporte aucune garantie de protection de l'occupant en cas d'accident.

SRS airbag instructions for Canadian owners (in French)

The following is a French explanation of SRS airbag instructions extracted from the SRS airbag section in this manual.

See the SRS airbag section for more detailed SRS airbag instructions in English.

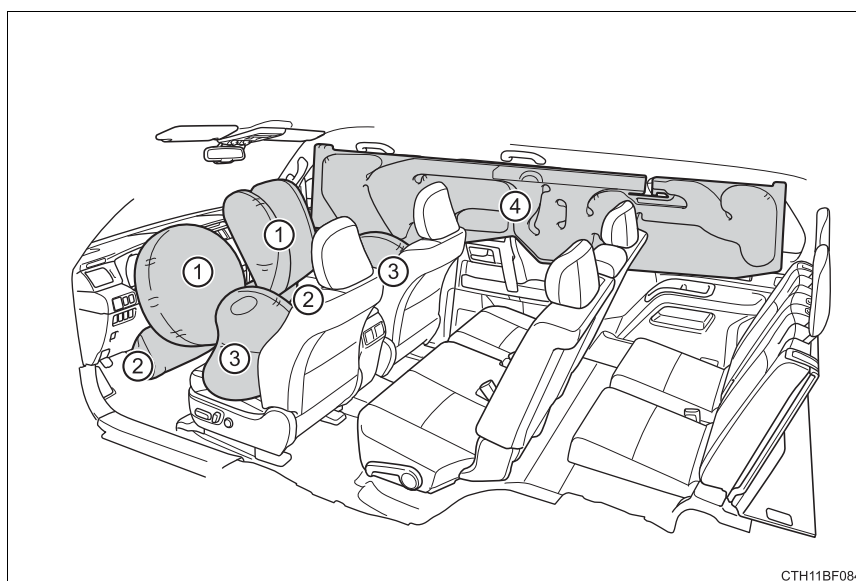

◆ Coussins gonflables avant SRS

- ① Coussin gonflable conducteur SRS/coussin gonflable passager avant
Participant à la protection de la tête et du thorax du conducteur et du passager avant contre les chocs avec les éléments intérieurs
- ② Coussins gonflables de genoux SRS
Participant à la protection du conducteur et du passager avant

◆ Coussins gonflables latéraux et rideaux SRS

- ③ Coussins gonflables latéraux SRS
Participent à la protection du torse des passagers du siège avant
- ④ Coussins gonflables rideaux SRS
 - Participent principalement à la protection de la tête des occupants assis aux places extérieures
 - Peut contribuer à empêcher les occupants d'être éjectés du véhicule en cas de tonneau

Composition du système de coussins gonflables SRS

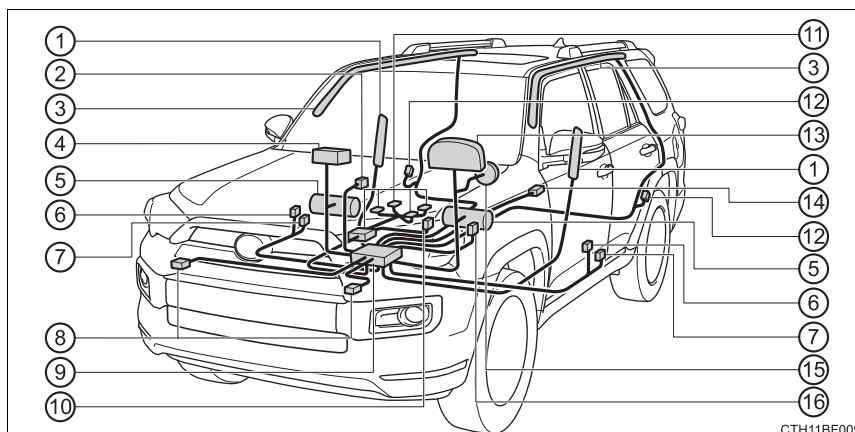

- | | |
|--|---|
| ① Coussins gonflables latéraux | ⑩ Commutateur de boucle de ceinture de sécurité du siège du passager avant |
| ② Témoins indicateurs "AIR BAG ON" et "AIR BAG OFF" | ⑪ Système de classification de l'occupant du siège passager avant (ECU et capteurs) |
| ③ Coussins gonflables rideaux | ⑫ Capteurs d'impact latéral (arrière) |
| ④ Coussin gonflable passager avant | ⑬ Témoin d'avertissement SRS |
| ⑤ Coussins gonflables de genoux | ⑭ Capteur de protection (arrière) |
| ⑥ Capteurs d'impact latéral (porte avant) | ⑮ Coussin gonflable conducteur |
| ⑦ Prétensionneurs de ceintures de sécurité et limiteurs de force | ⑯ Commutateur de boucle de ceinture de sécurité du conducteur |
| ⑧ Capteurs d'impact avant | |
| ⑨ Capteur de coussin gonflable | |

Votre véhicule est équipé de COUSSINS GONFLABLES INTELLIGENTS conçus selon les normes de sécurité américaines applicables aux véhicules à moteur (FMVSS208). Le boîtier électronique (ECU) des coussins gonflables régule le déploiement de ces derniers sur la base des informations qu'il reçoit des capteurs, etc., indiqués ci-dessus dans le schéma illustrant les composants du système. Parmi ces informations figurent la gravité du choc et l'occupation du véhicule par les passagers. Le déploiement rapide des coussins gonflables est obtenu au moyen d'une réaction chimique dans les dispositifs pyrotechniques, qui produit un gaz inoffensif permettant d'amortir le mouvement des occupants.

 **WARNING****■ Précautions avec le coussin gonflable SRS**

Respectez les précautions suivantes avec les coussins gonflables SRS. Autrement, des blessures graves, voire mortelles, pourraient s'ensuivre.

- Le conducteur et les passagers du véhicule doivent porter correctement leur ceinture de sécurité.

Les coussins gonflables SRS sont des dispositifs supplémentaires à utiliser avec les ceintures de sécurité.

- Le coussin gonflable conducteur SRS se déploie avec une violence considérable, qui peut être très dangereuse, voire mortelle, si le conducteur se trouve très près du coussin gonflable. L'autorité fédérale chargée de la sécurité routière aux États-Unis (NHTSA) conseille:

Sachant que la zone de danger pour le coussin gonflable conducteur se trouve dans les premiers 2 à 3 in. (50 - 75 mm) de déploiement, vous placer à 10 in. (250 mm) de votre coussin gonflable conducteur vous garantit une marge de sécurité suffisante. Cette distance est à mesurer entre l'axe du volant et le sternum. Si vous êtes assis à moins de 10 in. (250 mm), vous pouvez changer votre position de conduite de plusieurs façons:

- Reculez votre siège le plus possible, de manière à pouvoir encore atteindre confortablement les pédales.
- Inclinez légèrement le dossier du siège.
Bien que les véhicules puissent être différents les uns des autres, la plupart des conducteurs peuvent s'asseoir à une distance de 10 in. (250 mm), même avec le siège conducteur complètement avancé, simplement en inclinant un peu le dossier de siège. Si vous avez des difficultés à voir la route après avoir incliné votre siège, utilisez un coussin ferme et antidérapant pour vous rehausser ou, si votre véhicule est équipé du réglage en hauteur du siège, remontez-le.
- Si votre volant est réglable, inclinez-le vers le bas. Cela a pour effet d'orienter le coussin gonflable en direction de votre poitrine plutôt que de votre tête et de votre cou.

Réglez votre siège selon ces recommandations de la NHTSA, tout en conservant le contrôle des pédales, du volant et la visibilité des commandes du tableau de bord.

⚠ WARNING

■ Précautions avec le coussin gonflable SRS

● Si vous attachez une rallonge de ceinture de sécurité aux boucles de ceinture de sécurité avant, mais pas au pêne de la ceinture de sécurité, les coussins gonflables avant SRS détectent que le conducteur et le passager avant ont attaché leur ceinture de sécurité, alors même que ce n'est pas le cas. Dans ce cas, il se peut que les coussins gonflables avant SRS ne se déploient pas correctement en cas d'accident et vous risquez d'être tué ou grièvement blessé. Veillez à porter la ceinture de sécurité avec la rallonge de ceinture de sécurité.

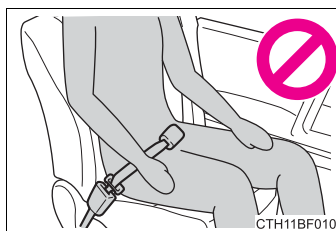

● Le coussin gonflable passager avant SRS se déploie également avec une violence considérable, qui peut être très dangereuse, voire mortelle, si le passager avant se trouve très près du coussin gonflable. Éloignez le siège du passager avant au maximum du coussin gonflable et réglez le dossier de siège de façon à être assis bien droit dans le siège.

● Les nourrissons et les enfants qui ne sont pas correctement assis et/ou protégés peuvent être grièvement blessés ou tués par le déploiement d'un coussin gonflable. Installez dans un siège de sécurité enfant les enfants trop jeunes pour pouvoir utiliser la ceinture de sécurité. Toyota recommande vivement que les nourrissons et les jeunes enfants soient installés sur le siège arrière du véhicule et convenablement attachés. Les sièges arrière sont plus sûrs pour les nourrissons et les enfants que le siège du passager avant.

● Ne vous asseyez pas sur le bord du siège et ne vous appuyez pas contre le tableau de bord.

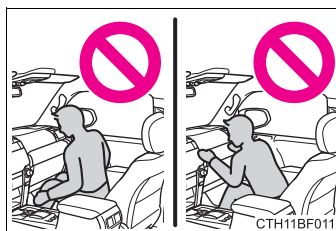

⚠ WARNING

■ Précautions avec le coussin gonflable SRS

- Ne laissez pas un enfant se tenir debout devant le coussin gonflable passager avant SRS ou bien s'asseoir sur les genoux du passager avant.
- Ne laissez pas les occupants des sièges avant voyager avec un objet sur les genoux.
- Ne vous appuyez pas contre la porte, contre le rail latéral de toit ou contre les montants avant, latéraux et arrière.

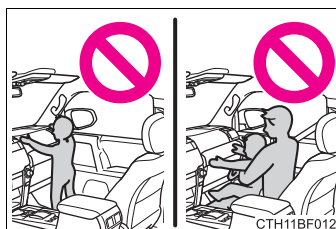

- Ne laissez personne s'agenouiller sur les sièges des passagers en appui contre la porte ou sortir la tête ou les mains à l'extérieur du véhicule.

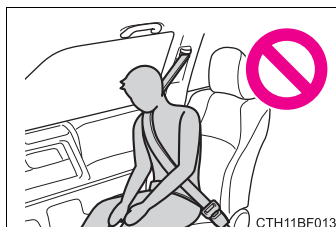

- Ne fixez ni ne posez aucun objet sur le tableau de bord, la garniture du volant de direction et la partie inférieure du tableau de bord.
Au déploiement des coussins gonflables conducteur SRS, passager avant et genoux, tout objet risque de se transformer en projectile.

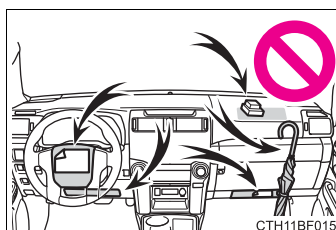

- Ne rien fixer aux portes, à la vitre du pare-brise, aux vitres latérales, aux montants avant et arrière, au rail latéral de toit et à la poignée d'assistance.

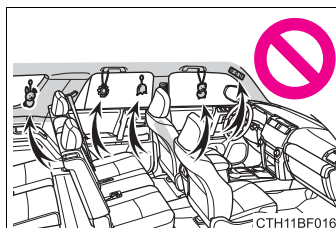

 **WARNING****■ Précautions avec le coussin gonflable SRS**

- Ne suspendez aucun cintre ou objets durs aux crochets à vêtements. En cas de déploiement des coussins gonflables rideaux SRS, tous ces objets pourraient se transformer en projectiles et causer des blessures graves, voire mortelles.
- Si un cache en vinyle recouvre la partie où le coussin gonflable de genoux SRS se déploie, veillez à l'enlever.
- N'utilisez aucun accessoire de siège venant recouvrir les zones de déploiement des coussins gonflables latéraux SRS, car il risquerait d'en gêner le déploiement. De tels accessoires peuvent empêcher les coussins gonflables latéraux de fonctionner correctement, désactiver le dispositif ou entraîner le déploiement accidentel des coussins gonflables latéraux, ce qui pourrait entraîner la mort ou des blessures graves.
- Évitez de faire subir des chocs ou des pressions excessives aux zones renfermant les composants des coussins gonflables SRS.
En effet, cela pourrait entraîner un fonctionnement anormal des coussins gonflables SRS.
- Ne touchez aucun composant du système immédiatement après le déploiement (gonflage) des coussins gonflables SRS, car ils peuvent être chauds.
- Si vous avez des difficultés à respirer après le déploiement des coussins gonflables SRS, ouvrez une porte ou une vitre pour faire entrer de l'air frais, ou bien descendez du véhicule si cela ne présente pas de danger. Essayez tout résidu dès que possible afin d'éviter d'éventuelles irritations de la peau.
- Si les parties renfermant les coussins gonflables SRS, telles que la garniture du volant et les garnitures de montants avant et arrière, sont abîmées ou craquelées, faites-les remplacer par votre concessionnaire Toyota.

 **WARNING****■ Précautions avec le coussin gonflable SRS**

- Ne placez rien sur le siège du passager avant, comme un coussin par exemple. Cela a pour conséquence de répartir le poids du passager sur toute la surface du siège, ce qui empêche le capteur de détecter correctement le poids du passager. En conséquence, les coussins gonflables frontaux SRS du passager avant risquent de ne pas se déployer en cas de collision.

■ Modification et mise au rebut des éléments du système de coussins gonflables SRS

Consultez impérativement votre concessionnaire Toyota si vous avez besoin d'intervenir sur votre véhicule ou de procéder à l'une des modifications suivantes. Les coussins gonflables SRS peuvent être défectueux ou se déployer (se gonfler) accidentellement, provoquant la mort ou de graves blessures.

- Installation, dépose, démontage et réparation des coussins gonflables SRS
- Réparations, modifications, démontage ou remplacement du volant, du tableau de bord, de la planche de bord, des sièges ou de leur garniture, des montants avant, latéraux et arrière ou des rails latéraux de toit
- Réparations ou modifications des ailes avant, du pare-chocs avant ou des flancs de l'habitacle
- Installation d'un protège-calandre (pare-buffle, pare-kangourou, etc.), de chasse-neiges, de treuils ou d'une galerie de pavillon
- Modifications du système de suspension du véhicule
- Installation d'appareils électroniques, tels qu'une radio émetteur/récepteur ou un lecteur CD
- Aménagements du véhicule visant à permettre sa conduite par une personne atteinte d'un handicap physique

Index

577

What to do if...
(Troubleshooting) 578
Alphabetical index 582

For details of equipment related to the audio/navigation system, refer to the “NAVIGATION AND MULTIMEDIA SYSTEM OWNER’S MANUAL”.

What to do if... (Troubleshooting)

If you have a problem, check the following before contacting your Toyota dealer.

The doors cannot be locked, unlocked, opened or closed



You lose your keys

- If you lose your keys or mechanical keys, new genuine mechanical keys can be made by your Toyota dealer. (→P. 103)
- If you lose your keys or electronic keys, the risk of vehicle theft increases significantly. Contact your Toyota dealer immediately. (→P. 105)



The doors cannot be locked or unlocked

- Is the key battery weak or depleted? (→P. 447)
- Is the engine switch in IGNITION ON mode?
When locking the doors, turn the engine switch off. (→P. 200)
- Is the electronic key left inside the vehicle?
When locking the doors, make sure that you have the electronic key on your person.
- The function may not operate properly due to the condition of the radio wave. (→P. 117)



The rear door cannot be opened

- Is the child-protector lock set?
The rear door cannot be opened from inside the vehicle when the lock is set. Open the rear door from outside and then unlock the child-protector lock. (→P. 109)

If you think something is wrong**The engine does not start**

- Did you press the engine switch while firmly depressing the brake pedal? (→P. 199)
- Is the shift lever in P? (→P. 202)
- Is the electronic key anywhere detectable inside the vehicle? (→P. 114)
- Is the electronic key battery weak or depleted?
In this case, the engine can be started in a temporary way. (→P. 513)
- Is the battery discharged? (→P. 515)

**The shift lever cannot be shifted from P even if you depress the brake pedal**

- Is the engine switch in IGNITION ON mode?
If you cannot release the shift lever by depressing the brake pedal with the engine switch in IGNITION ON mode. (→P. 208)

**The windows do not open or close by operating the power window switches**

- Is the window lock switch pressed?
The power window except for the one at the driver's seat cannot be operated if the window lock switch is pressed. (→P. 155)

**The engine switch is turned off automatically**

- The auto power off function will be operated if the vehicle is left in ACCESSORY or IGNITION ON mode (the engine is not running) for a period of time. (→P. 201)



A warning buzzer sounds during driving

- The seat belt reminder light is flashing
Are the driver and the front passenger wearing the seat belts?
(→P. 480)
- The brake system warning light is on
Is the parking brake released? (→P. 211)
- The open door warning indicator is on
Are all the doors closed? (→P. 106, 124)

Depending on the situation, other types of warning buzzer may also sound.
(→P. 477, 488)



An alarm is activated and the horn sounds

- Did anyone inside the vehicle open a door during setting the alarm?
The sensor detects it and the alarm sounds. (→P. 79)

To stop the alarm, turn the engine switch to IGNITION ON mode or start the engine.



A warning buzzer sounds when leaving the vehicle

- Is the electronic key left inside the vehicle?
Check the message on the multi-information display.



A warning light turns on or a warning message is displayed

- When a warning light turns on, refer to P. 477.
- When a warning light turns on or a warning message or indicator is displayed, refer to P. 477, 488.

When a problem has occurred**If you have a flat tire**

- Stop the vehicle in a safe place and replace the flat tire with the spare tire. (→P. 493)

**The vehicle becomes stuck**

- Try the procedure for when the vehicle becomes stuck in mud, dirt, or snow. (→P. 522)

Alphabetical index

A

- A/C** 342, 349
 - Air conditioning filter 445
- ABS**
 - (Anti-lock Brake System)**..... 322
 - Function 322
 - Warning light..... 478
- Active head restraints** 130
- Active traction control** 302
- Air conditioning filter** 445
- Air conditioning**
 - system**..... 342, 349
 - Air conditioning filter 445
- Airbags** 37
 - Airbag operating conditions 44
 - Airbag precautions
 - for your child 39
 - Airbag warning light 478
 - Correct driving posture 30
 - Curtain shield airbag
 - operating conditions 44
 - Curtain shield airbag
 - precautions..... 41
 - Front passenger occupant
 - classification system..... 48
 - General airbag precautions 39
 - Locations of airbags..... 37
 - Modification and disposal
 - of airbags..... 43
 - Side airbag operating
 - conditions 44
 - Side airbag precautions 39
 - Side and curtain shield airbags
 - operating conditions 44
 - Side and curtain shield
 - airbags precautions 39
 - SRS airbags..... 37
- Alarm** 79
 - Alarm 79
 - Warning buzzer 477
- Anchor brackets** 59
- Antennas**
 - (smart key system)** 113
- Anti-lock Brake System**
 - (ABS)**..... 322
 - Function 322
 - Warning light..... 478
- Armrest**..... 386
- Assist grip**..... 386
- Audio system***
- AUTO LSD system**..... 304
- Automatic air conditioning**
 - system**..... 349
- Automatic High Beam** 217
- Automatic light control**
 - system**..... 212
- Automatic running boards** 121
- Automatic transmission** 205
 - If the shift lever
 - cannot be shifted from P 208
 - S mode 206
- AUX port***
- Auxiliary boxes**..... 367

B

Back door
 Back door..... 124
 Back window..... 158
 Smart key system 113
 Wireless remote control 106
Back window..... 158
Back-up lights
 Replacing light bulbs..... 461
 Wattage 533
Battery 422
 Battery checking 422
 If the vehicle battery
 is discharged 515
 Preparing and checking
 before winter..... 331
 Warning light..... 477
Bottle holders 369
Brake
 Fluid 419
 Parking brake..... 211
 Warning light..... 477
Brake assist 322
Brake override system 167
Break-in tips 168
Brightness control
 Instrument panel light
 control..... 89

C

Care 396, 400
 Exterior 396
 Interior 400
 Seat belts..... 401
 Wheels and wheel
 ornaments 397
Cargo capacity..... 181
Cargo hooks 370
Cargo net hooks 371
Center differential lock 298
Chains 333
Child restraint system..... 55
 Booster seats, definition 56
 Booster seats, installation..... 67
 Convertible seats, definition ... 56
 Convertible seats,
 installation 64
 Front passenger occupant
 classification system 48
 Infant seats, definition..... 56
 Infant seats, installation 64
 Installing CRS
 with LATCH anchors 61
 Installing CRS with seat
 belts..... 64
 Installing CRS
 with top tether strap..... 68

*: Refer to the "NAVIGATION AND MULTIMEDIA SYSTEM OWNER'S MANUAL".

Child safety 54

- Airbag precautions 39
- Back door precautions 126
- Battery precautions 423, 518
- Child restraint system 55
- How your child should wear the seat belt 33
- Installing child restraints 59
- Moon roof precautions 164
- Power window lock switch 155
- Power window precautions ... 157
- Rear door child-protectors 109
- Removed electronic key battery precautions 448
- Seat belt extender precautions 36
- Seat belt precautions 58
- Seat heater precautions 357

Child-protectors 109

Cleaning 396, 400

- Exterior 396
- Interior 400
- Seat belts 401
- Wheels and wheel ornaments 397

Clock 376

Compass 92

Condenser 419

Console box 364

Cooling system

- Engine overheating 519

Crawl Control 312

Cruise control

- Dynamic radar cruise control 257

Cup holders 365

Curtain shield airbags 37

Customizable features 549

D

Daytime running light system 215

Defogger

- Front windshield 351
- Outside rear view mirrors 344, 351
- Rear window 344, 351

Dimension 524

Dinghy towing 198

Display

- Dynamic radar cruise control 257
- LDA (Lane Departure Alert) 249
- Multi-information display 90
- Trip information 90
- Warning message 488

Do-it-yourself maintenance 409

Door courtesy lights

- Wattage 533

Doors

- Automatic door locking and unlocking system 109
- Back door 124
- Door lock 108, 124
- Door windows 155
- Open door warning buzzer ... 115
- Open door warning light 479
- Outside rear view mirrors 153
- Rear door child-protector 109
- Side doors 106

Downhill assist control system 309

Drive-Start Control 167

Driver's seat position memory 142

Driving	166
Break-in tips	168
Correct driving posture	30
Driving assist systems	322
Off-road precautions	335
Procedures	166
Winter drive tips	331
Dynamic radar cruise control	257

E

Eco Driving Indicator	98
EDR (Event data recorder)	10
Electronic key	102
Battery-saving function	116
If the electronic key does not operate properly	512
Replacing the battery	447
Emergency, in case of	
If the electronic key does not operate properly	512
If the engine will not start	509
If the vehicle battery is discharged	515
If the warning buzzer sounds	477
If the warning light turns on	477
If a warning message is displayed	488
If the vehicle is submerged or water on the road is rising	468
If you cannot operate back door opener	511

If you have a flat tire	493
If you think something is wrong	475
If your vehicle becomes stuck	522
If your vehicle has to be stopped in an emergency ...	467
If your vehicle needs to be towed	469
If your vehicle overheats	519
Emergency flashers	466
Engine	
ACCESSORY mode	200
Compartment	413
Engine switch	199
Hood	412
How to start the engine	199
Identification number	525
If the engine will not start	509
Ignition switch (engine switch)	199
Overheating	519
Engine coolant	417
Capacity	528
Checking	417
Preparing and checking before winter	331
Engine coolant temperature gauge	88
Engine immobilizer system	78
Engine oil	415
Capacity	527
Checking	415
Preparing and checking before winter	331
Engine switch	199
Event data recorder (EDR)	10

F

Flat tire	493
Floor mats	28
Fluid	
Automatic transmission.....	531
Brake	531
Power steering.....	532
Washer	425
Fog lights	221
Replacing light bulbs.....	453
Switch	221
Wattage	533
Four-wheel drive	
system	294, 298
Front passenger occupant	
classification system	48
Front personal lights	361
Front seats	129
Adjustment.....	129
Cleaning.....	400
Correct driving posture	30
Driving position memory	142
Head restraints	146
Seat heaters	357
Seat position memory	142
Seat ventilators	357

Front side marker lights	212
Light switch.....	212
Replacing light bulbs	458
Wattage	533
Front turn signal lights	210
Replacing light bulbs	456
Turn signal lever	210
Wattage	533
Fuel	229
Capacity.....	526
Fuel gauge.....	88
Fuel pump shut off system ...	476
Information.....	534
Refueling	229
Type.....	229, 526
Warning light.....	480
Fuel filler door	229
Refueling	229
Fuel pump shut off system	476
Fuses	450

G

Garage door opener	387
Gauges	88
Glove box	364
Grocery bag hooks	373

H

Head restraints	146
Headlights	212
Automatic High Beam	
system	217
Light switch	212
Replacing light bulbs.....	455, 463
Wattage	533
Heaters	
Air conditioning	
system	342, 349
Outside rear view	
mirrors	344, 351
Seat heaters	357
Hill-start assist control.....	323
Hood	412
Hooks	
Cargo hooks	370
Cargo net hooks	371
Grocery bag hooks	373
Retaining hooks (floor mat).....	28
Horn	149

I

I/M test	408
Identification	
Engine	525
Vehicle	525
Ignition switch	
(engine switch).....	199
Illuminated entry system	362
Immobilizer system	78
Indicators	85
Initialization	
Maintenance	404
Moon roof	163
Power back window	159
Power windows	156
Inside rear view mirror.....	151
Instrument panel light	
control.....	89
Interior lights	360
Intuitive parking assist	277

J

Jack	
Vehicle-equipped jack.....	493
Jack handle.....	497
Jam protection function	
Moon roof.....	162
Power back window.....	159
Power windows.....	155

K

KDSS.....	323
Keyless entry.....	113
Smart key system.....	113
Wireless remote control.....	106
Keys.....	102
Battery-saving function.....	116
Electronic key.....	102
Engine switch.....	199
If the electronic key does not operate properly.....	512
Key number plate.....	102
Keyless entry.....	106
Mechanical key.....	103
Replacing the battery.....	447
Warning buzzer.....	115
Wireless remote control key.....	106
Knee airbags.....	37

L

LATCH anchors.....	61
Lever	
Auxiliary catch lever.....	412
Hood lock release lever.....	412
Shift lever.....	205
Turn signal lever.....	210
Wiper lever.....	223, 226
License plate lights.....	212
Light switch.....	212
Replacing light bulbs.....	462
Wattage.....	533
Light bulbs	
Replacing.....	455
Wattage.....	533
Lights	
Automatic High Beam system.....	217
Fog light switch.....	221
Front Interior light.....	361
Headlight switch.....	212
Interior lights list.....	360
Luggage compartment lights.....	126
Personal lights.....	361
Rear interior light.....	361
Replacing light bulbs.....	455
Turn signal lever.....	210
Vanity lights.....	375
Wattage.....	533
Limited slip differential.....	323
Load capacity.....	181
Luggage compartment features.....	370

M

Maintenance
 Do-it-yourself maintenance... 409
 General maintenance 405
 Maintenance data 524
 Maintenance requirements ... 403
 Resetting the message
 indicating maintenance is
 required 404
Malfunction indicator lamp..... 478
Manual air conditioning
 system..... 342
Master warning light..... 481, 488
Meter 88
 Indicators 85
 Instrument panel light
 control..... 89
 Meters..... 88
 Multi-information display 90
 Warning lights 83
Mirrors
 Inside rear view mirror 151
 Outside rear view mirror
 defoggers 344, 351
 Outside rear view mirrors..... 153
 Vanity mirrors..... 375
Moon roof 161
 Door lock linked
 moon roof operation 163
 Jam protection function..... 162
 Operation 161

Multi Terrain ABS 322
Multi-information display..... 90
 Driving information..... 93
 Dynamic radar cruise
 control 257
 Language..... 559
 LDA
 (Lane Departure Alert) 249
 Outside temperature..... 98
 PCS
 (Pre-Collision System) 239
 Settings..... 96
 Warning messages..... 488
Multi-terrain Select..... 315

N

Navigation system*
Noise from under vehicle 8

O

Odometer 88
Off-road precautions..... 335
Oil
 Engine oil..... 415
Opener
 Back door 124
 Hood 412
Outer foot lights 360
Outside rear view mirrors..... 153
 Adjusting and folding 153
 Outside rear view
 mirror defoggers..... 344, 351
Outside temperature
 display..... 98
Overhead console 367
Overheating, Engine 519

*: Refer to the "NAVIGATION AND MULTIMEDIA SYSTEM OWNER'S MANUAL".

P

Parking brake	211
Operation	211
Parking brake engaged warning buzzer	477
PCS (Pre-Collision System)	239
Warning light.....	201
Parking lights	212
Light switch.....	212
Replacing light bulbs.....	456
Wattage	533
Pen holder	368
Personal lights	361
Power back window	158
Jam protection function.....	159
Operation	158
Power outlets	377, 381
Power steering	
Fluid	421
Warning light.....	479
Power windows	155
Door lock linked window operation	156
Jam protection function.....	155
Operation	155
Window lock switch.....	155

R

Radiator	419
Rear differential lock system	306
Rear seats	
Adjustment.....	132
Folding down	134, 136, 138
Rear step bumper	125
Rear turn signal lights	210
Replacing light bulbs	460
Turn signal lever	210
Wattage	533
Rear view mirror	
Inside rear view mirror	151
Outside rear view mirrors	153
Rear view monitor system*	
Rear window	158
Rear window defoggers	344, 351
Rear window wiper	226
Refueling	229
Capacity.....	526
Fuel types	526
Opening the fuel tank cap.....	231
Replacing	
Fuses.....	450
Key battery	447
Light bulbs	453
Tires.....	493
Reporting safety defects for U.S. owners	564
Resetting the message indicating maintenance is required	404
Roof luggage carrier	176

S

Safety Connect 72
Seat belt reminder light..... 480
Seat belts..... 32
 Adjusting the seat belt 32
 Automatic Locking
 Retractor (ALR) 33
 Child restraint system
 installation 64
 Cleaning and maintaining
 the seat belt..... 401
 Emergency Locking
 Retractor (ELR) 33
 How to wear your seat belt 32
 How your child should wear
 the seat belt..... 33
 Pregnant women, proper
 seat belt use 34
 Reminder light and buzzer... 480
 Seat belt extender..... 33
 Seat belt pretensioners..... 33
 SRS warning light 478
Seat heaters 357
Seat position memory 142
Seat ventilators..... 357
Seating capacity 181

Seats..... 129, 132
 Adjustment..... 129, 132
 Adjustment
 precautions..... 131, 141
 Child seats/child restraint
 system installation..... 59
 Cleaning 400
 Driving position memory 142
 Head restraints 146
 Properly sitting in the seat 30
 Seat heaters 357
 Seat position memory..... 142
 Seat ventilators..... 357
Sensor
 Automatic headlight
 system..... 215
 Inside rear view mirror 152
 Intuitive parking assist 277
Service reminder indicators 82
Shift lever 205
 Automatic transmission 205
 If the shift lever
 cannot be shifted from P 208

*: Refer to the "NAVIGATION AND MULTIMEDIA SYSTEM OWNER'S MANUAL".

Shift lock system	207
Side airbags	37
Side marker lights	212
Light switch	212
Replacing light bulbs.....	458
Wattage	533
Side mirrors	153
Adjusting and folding	153
Side turn signal lights	210
Slide deck	373
Smart key system	113
Antenna location.....	113
Entry functions.....	106
Starting the engine.....	199
Snow tires	334
Spare tire	493
Inflation pressure	532
Storage location.....	494
Spark plug	528
Specifications	524
Speedometer	88
Steering wheel	149
Adjustment.....	149
Storage feature	363
Storage precautions	179
Stuck	
If the vehicle becomes	
stuck.....	522
Sun visors	375

Switches

Automatic High Beam	
switch	217
Cruise control switch	257
Door lock switches.....	108
Driving position memory	
switches	142
Emergency flashers switch...	466
Engine switch	199
Fog light switch.....	221
Garage door opener	
switches	387
Ignition switch	199
LDA (Lane Departure Alert)	
switch	249
Light switches	212
Moon roof switches.....	161
Outside rear view mirror	
switches	153
Power back window	
switch	158
Power door lock switch.....	108
Power window switches.....	155
Rear window and outside	
rear view mirror defoggers	
switch	344, 351
Rear window wiper and	
washer switch.....	226
Seat heater switches	357
Seat ventilator switches.....	357
“SOS” button.....	72
Telephone switches*	
VSC OFF switch	324
Window lock switch	155
Windshield wipers	
and washer switch.....	223

T

Tachometer	88
Tail lights	212
Light switch	212
Telephone switches*	
Theft deterrent system	
Alarm	79
Engine immobilizer system	78
Tire inflation pressure	440
Maintenance data	532
Warning light.....	481
Tire information	537
Glossary.....	543
Size.....	539
Tire identification number	538
Uniform Tire Quality Grading.....	541
Tire pressure warning system	429
Function	429
Installing tire pressure warning valves and transmitters	430
Registering ID codes	431
Warning light.....	481

Tires	427
Chains	333
Checking.....	427
If you have a flat tire	493
Inflation pressure	532
Information.....	537
Replacing.....	493
Rotating tires	428
Size.....	532
Snow tires.....	334
Spare tire	493
Tire pressure warning system.....	429
Warning light.....	481
Tools	494
Top tether strap	68
Total load capacity	181
Towing	
Dinghy towing	198
Emergency towing	472
Trailer towing	182
Toyota Safety Sense P	232
Automatic High Beam.....	217
Dynamic radar cruise control	257
LDA (Lane Departure Alert)	249
PCS (Pre-Collision System)	239

*: Refer to the "NAVIGATION AND MULTIMEDIA SYSTEM OWNER'S MANUAL".

TRAC (Traction Control) 322
Trailer Sway Control..... 322
Transmission 205
Trip information 88
Trip meters 88
Turn signal lights..... 210
 Replacing light bulbs..... 456, 460
 Turn signal lever 210
 Wattage 533

U

USB port*

V

Valet key 102
Vanity lights 375
 Wattage 533
Vanity mirrors 375
Vehicle data recordings 9
Vehicle identification
 number 525
Vehicle Stability Control
(VSC) 322
Ventilators
(seat ventilators) 357
VSC
(Vehicle Stability Control) 322

W

Warning buzzers
 Brake system 477
 Downshifting 208
 Intuitive parking assist 277
 Lane departure alert
 function 250
 Open door 479
 Open moon roof reminder 483
 Pre-collision warning 239
 Seat belt reminder 480
Warning lights 83
 ABS 478
 Automatic running boards
 indicator light 479
 Brake override system 480
 Brake system 477
 Center differential lock
 indicator light 479
 Charging system 477
 Drive-Start Control 480
 Four-wheel drive
 indicator light 479
 KDSS 479
 LDA indicator 481
 Low engine oil pressure 477
 Low fuel level 480
 Low speed four-wheel drive
 indicator light 479
 Malfunction indicator lamp 478
 Master warning light 481, 488
 Multi-terrain Select
 indicator light 479
 Open door 479
 PCS 481
 Power steering 479
 Rear differential lock
 indicator light 478
 Seat belt reminder light 480

Slip indicator	478
SRS	478
Tire pressure.....	481
Unengaged "Park"	479
Warning messages.....	488
Washer.....	223
Checking.....	425
Preparing and checking	
before winter.....	331
Switch	223, 226
Washing and waxing	396
Weight	
Cargo capacity.....	181
Load limits.....	181
Weight.....	524
Wheels	443
Replacing wheels.....	443
Size.....	532
Window glasses.....	155
Window lock switch	155
Windows.....	155
Power back window	158
Power windows.....	155
Rear window	
defogger	344, 351
Washer	223, 226
Windshield wiper	
de-icer	344, 352
Windshield wipers	223, 226
Intermittent wiper	223
Winter driving tips	331
Wireless remote control	
key	102
Locking/Unlocking.....	106
Replacing the battery.....	447

*: Refer to the "NAVIGATION AND MULTIMEDIA SYSTEM OWNER'S MANUAL".

Certification

► Engine Immobilizer system

FCC ID : MOZRI-57BTY

This device complies with part 15 of the FCC Rules. Operation is subject to the following two conditions: (1) This device may not cause harmful interference, and (2) this device must accept any interference received, including interference that may cause undesired operation.

Changes or modifications not expressly approved by the party responsible for compliance could void the user's authority to operate the equipment.

The FCC ID/IC Certification number is affixed inside the equipment. You can find the ID/number when replacing the battery.

This device complies with Industry Canada's licence-exempt RSSs. Operation is subject to the following two conditions: (1) This device may not cause interference; and (2) This device must accept any interference, including interference that may cause undesired operation of the device.

Le présent appareil est conforme aux CNR d'Industrie Canada applicables aux appareils radio exempts de licence. L'exploitation est autorisée aux deux conditions suivantes : 1) l'appareil ne doit pas produire de brouillage; 2) l'utilisateur de l'appareil doit accepter tout brouillage radioélectrique subi, même si le brouillage est susceptible d'en compromettre le fonctionnement.

The FCC ID/IC Certification number is affixed inside the equipment. You can find the ID/number when replacing the battery.

FCC ID : NI4TMIMB-3

This device complies with part 15 of the FCC Rules. Operation is subject to the following two conditions: (1) This device may not cause harmful interference, and (2) this device must accept any interference received, including interference that may cause undesired operation.

Changes or modifications not expressly approved by the party responsible for compliance could void the user's authority to operate the equipment.

This device complies with Industry Canada's licence-exempt RSSs. Operation is subject to the following two conditions: (1) This device may not cause interference; and (2) This device must accept any interference, including interference that may cause undesired operation of the device.

Le présent appareil est conforme aux CNR d'Industrie Canada applicables aux appareils radio exempts de licence. L'exploitation est autorisée aux deux conditions suivantes : 1) l'appareil ne doit pas produire de brouillage; 2) l'utilisateur de l'appareil doit accepter tout brouillage radioélectrique subi, même si le brouillage est susceptible d'en compromettre le fonctionnement.

► Wireless remote control

US

FCC ID:HYQ23ABE

FCC ID:HYQ12BEL

NOTE:

This device complies with part 15 of the FCC Rules. Operation is subject to the following two conditions: (1) This device may not cause harmful interference, and (2) this device must accept any interference received, including interference that may cause undesired operation.

FCC WARNING:

Changes or modifications not expressly approved by the party responsible for compliance could void the user's authority to operate the equipment.

<For 12BEL>

The FCC ID is affixed inside the equipment. You can find the ID when replacing the battery.

00

CA

NOTE:

This device contains licence-exempt transmitter(s)/receiver(s) that comply with Innovation, Science and Economic Development Canada's licence-exempt RSS(s).

Operation is subject to the following two conditions:

(1) This device may not cause interference.

(2) This device must accept any interference, including interference that may cause undesired operation of the device.

<For 12BEL>

The IC Certification number is affixed inside the equipment. You can find the number when replacing the battery.

02

CA

NOTE:

L'émetteur/récepteur exempt de licence contenu dans le présent appareil est conforme aux CNR d'Innovation, Sciences et Développement économique Canada applicables aux appareils radio exempts de licence.

L'exploitation est autorisée aux deux conditions suivantes :

- (1) L'appareil ne doit pas produire de brouillage;
- (2) L'appareil doit accepter tout brouillage radioélectrique subi, même si le brouillage est susceptible d'en compromettre le fonctionnement.

<Pour 12BEL>

Le numéro d'accréditation IC est apposé à l'intérieur de l'appareil. Ce numéro est visible au remplacement de la pile.

03

► Smart key system

US

FCC ID:HYQ23ABL

FCC ID:HYQ14FLA

NOTE:

This device complies with part 15 of the FCC Rules. Operation is subject to the following two conditions: (1) This device may not cause harmful interference, and (2) this device must accept any interference received, including interference that may cause undesired operation.

FCC WARNING:

Changes or modifications not expressly approved by the party responsible for compliance could void the user's authority to operate the equipment.

00

<p>NOTE: This device contains licence-exempt transmitter(s)/receiver(s) that comply with Innovation, Science and Economic Development Canada's licence-exempt RSS(s). Operation is subject to the following two conditions: (1) This device may not cause interference. (2) This device must accept any interference, including interference that may cause undesired operation of the device.</p>	CA
02	

<p>NOTE: L'émetteur/récepteur exempt de licence contenu dans le présent appareil est conforme aux CNR d'Innovation, Sciences et Développement économique Canada applicables aux appareils radio exempts de licence. L'exploitation est autorisée aux deux conditions suivantes : (1) L'appareil ne doit pas produire de brouillage; (2) L'appareil doit accepter tout brouillage radioélectrique subi, même si le brouillage est susceptible d'en compromettre le fonctionnement.</p>	CA
03	

FCC ID: NI4TMLF12-1

This device complies with part 15 of the FCC Rules. Operation is subject to the following two conditions: (1) This device may not cause harmful interference, and (2) this device must accept any interference received, including interference that may cause undesired operation.

Changes or modifications not expressly approved by the party responsible for compliance could void the user's authority to operate the equipment.

This device complies with Industry Canada's licence-exempt RSSs. Operation is subject to the following two conditions: (1) This device may not cause interference; and (2) This device must accept any interference, including interference that may cause undesired operation of the device.

Le présent appareil est conforme aux CNR d'Industrie Canada applicables aux appareils radio exempts de licence. L'exploitation est autorisée aux deux conditions suivantes : 1) l'appareil ne doit pas produire de brouillage; 2) l'utilisateur de l'appareil doit accepter tout brouillage radioélectrique subi, même si le brouillage est susceptible d'en compromettre le fonctionnement.

► Millimeter wave radar sensor

This device complies with the FCC Rules. Operation is subject to the following two conditions:

- (1) This device may not cause harmful interference, and
- (2) This device must accept any interference received, including interference that may cause undesired operation.

Radiofrequency radiation exposure Information:

This equipment complies with FCC radiation exposure limits set forth for an uncontrolled environment. This equipment should be installed and operated with minimum distance of 20 cm between the radiator and your body.

This transmitter must not be co-located or operating in conjunction with any other antenna or transmitter.

FCC Notice

Changes or modifications not expressly approved by the party responsible for compliance could void the user's authority to operate the equipment.

This device complies with Industry Canada licenceexempt RSS standard(s). Operation is subject to the following two conditions:

- (1) This device may not cause harmful interference, and
- (2) This device must accept any interference received, including interference that may cause undesired operation.

Radiofrequency radiation exposure Information:

This equipment complies with IC radiation exposure limits set forth for an uncontrolled environment. This equipment should be installed and operated with minimum distance of 20 cm between the radiator and your body.

This transmitter must not be co-located or operating in conjunction with any other antenna or transmitter.

Le présent appareil est conforme aux CNR d'Industrie Canada applicables aux appareils radio exempts de licence. L'exploitation est autorisée aux deux conditions suivantes:

- (1) l'appareil ne doit pas produire de brouillage, et
- (2) l'utilisateur de l'appareil doit accepter tout brouillage radioélectrique subi, même si le brouillage est susceptible d'en compromettre le fonctionnement.

Cet équipement est conforme aux limites d'exposition aux rayonnements IC établies pour un environnement non contrôlé. Cet équipement doit être installé et utilisé avec un minimum de 20 cm de distance entre la source de rayonnement et votre corps.

► Blind Spot Monitor

FCC ID : OAYSRR3A

This device complies with part 15 of the FCC Rules. Operation is subject to the following two conditions:

- (1) This device may not cause harmful interference, and
- (2) this device must accept any interference received, including interference that may cause undesired operation.

FCC Warning

Changes or modifications not expressly approved by the party responsible for compliance could void the user's authority to operate the equipment.

C3-002

This device contains licence-exempt transmitter(s)/receiver(s) that comply with Innovation, Science and Economic Development Canada's licence-exempt RSS(s). Operation is subject to the following two conditions:

1. This device may not cause interference.
2. This device must accept any interference, including interference that may cause undesired operation of the device.

Radiofrequency radiation exposure information:

This equipment complies with radiation exposure limits set forth for an uncontrolled environment. This equipment should be installed and operated with minimum distance of 20 cm between the radiator and your body.

C3-005

L'émetteur/récepteur exempt de licence contenu dans le présent appareil est conforme aux CNR d'Innovation, Sciences et Développement économique Canada applicables aux appareils radio exempts de licence. L'exploitation est autorisée aux deux conditions suivantes:

1. L'appareil ne doit pas produire de brouillage;
2. L'appareil doit accepter tout brouillage radioélectrique subi, même si le brouillage est susceptible d'en compromettre le fonctionnement.

Informations sur l'exposition aux rayonnements radiofréquences:

Cet équipement est conforme aux limites d'exposition aux rayonnements définies pour un environnement non contrôlé. Cet équipement doit être installé et utilisé avec un minimum de 20 cm de distance entre la source de rayonnement et votre corps.

C3-006

► Garage door opener

This device complies with FCC rules part 15 and Innovation, Science, and Economic Development Canada RSS-210. Operation is subject to the following two conditions: (1) This device may not cause harmful interference, and (2) This device must accept any interference that may be received including interference that may cause undesired operation. WARNING: The transmitter has been tested and complies with FCC and ISED rules. Changes or modifications not expressly approved by the party responsible for compliance could void the user's authority to operate the device.

This equipment complies with FCC and ISED radiation exposure limits set forth for an uncontrolled environment. End Users must follow the specific operating instructions for satisfying RF exposure compliance. This transmitter must be at least 20 cm from the user and must not be co-located or operating in conjunction with any other antenna or transmitter.

This device complies with FCC rules part 15 and Innovation, Science, and Economic Development Canada RSS-210. Operation is subject to the following two conditions: (1) This device may not cause harmful interference, and (2) This device must accept any interference that may be received including interference that may cause undesired operation. WARNING: The transmitter has been tested and complies with FCC and ISED rules. Changes or modifications not expressly approved by the party responsible for compliance could void the user's authority to operate the device.

This equipment complies with FCC and ISED radiation exposure limits set forth for an uncontrolled environment. End Users must follow the specific operating instructions for satisfying RF exposure compliance. This transmitter must be at least 20 cm from the user and must not be co-located or operating in conjunction with any other antenna or transmitter.

Cet appareil est conforme aux règlements de la FCC, section 15, et au CNR-210 d'Innovation, Sciences et Développement économique Canada. Le fonctionnement est assujéti aux deux conditions suivantes : (1) cet appareil ne doit pas causer d'interférences nuisibles et (2) cet appareil doit accepter toute interférence reçue, y compris celle qui pourrait entraîner un dysfonctionnement. MISE EN GARDE : L'émetteur a subi des tests et est conforme aux règlements de la FCC et d'ISDE. Les changements ou modifications non approuvés explicitement par la partie responsable de la conformité pourraient rendre caduque l'autorisation de l'utilisateur de se servir du dispositif.

Cet appareil est conforme aux limites d'exposition aux radiations de la FCC et d'ISDE établies pour un environnement non contrôlé. Les utilisateurs finaux doivent respecter les instructions d'utilisation spécifiques pour satisfaire aux exigences de conformité aux expositions de RF. L'émetteur doit se trouver à 20 cm au minimum de l'utilisateur et ne doit pas être situé au même endroit que tout autre émetteur ou antenne ni fonctionner avec un autre émetteur ou antenne.

► Tire pressure warning system

FCC ID: PAXPMVE000

NOTE

This device complies with part 15 of the FCC Rules. Operation is subject to the following two conditions:
(1) This device may not cause harmful interference, and (2) this device must accept any interference received, including interference that may cause undesired operation.

FCC WARNING

Changes or modifications not expressly approved by the party responsible for compliance could void the user's authority to operate the equipment.

FCC ID: PAXPMVE100

NOTE

This device complies with part 15 of the FCC Rules. Operation is subject to the following two conditions:
(1) This device may not cause harmful interference, and (2) this device must accept any interference received, including interference that may cause undesired operation.

FCC WARNING

Changes or modifications not expressly approved by the party responsible for compliance could void the user's authority to operate the equipment.

NOTE

This device complies with Industry Canada licence-exempt RSS standard(s). Operation is subject to the following two conditions: (1) this device may not cause interference, and (2) this device must accept any interference, including interference that may cause undesired operation of the device.

NOTE

Le présent appareil est conforme aux CNR d'Industrie Canada applicables aux appareils radio exempts de licence. L'exploitation est autorisée aux deux conditions suivantes : (1) l'appareil ne doit pas produire de brouillage, et (2) l'utilisateur de l'appareil doit accepter tout brouillage radioélectrique subi, même si le brouillage est susceptible d'en compromettre le fonctionnement.

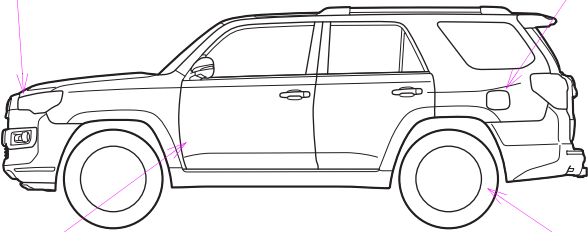
GAS STATION INFORMATION	
Auxiliary catch lever P. 412	Fuel filler door P. 231
 <p style="text-align: right; font-size: small;">CTHPIBF009</p>	
Hood lock release lever P. 412	Tire inflation pressure P. 532
Fuel tank capacity (Reference)	23.0 gal. (87.0 L, 19.1 Imp. gal.)
Fuel type	Unleaded gasoline only P. 229, 526
Cold tire inflation pressure	P. 532
Engine oil capacity (Drain and refill — reference)	P. 527
Engine oil type	P. 527