



# OWNER'S MANUAL

2025 MAZDA CX-70

## **WARNING**

### **California Proposition 65 Warning**

Operating, servicing and maintaining a passenger vehicle or off-highway motor vehicle can expose you to chemicals including engine exhaust, carbon monoxide, phthalates, and lead, which are known to the State of California to cause cancer and birth defects or other reproductive harm. To minimize exposure, avoid breathing exhaust, do not idle the engine except as necessary, service your vehicle in a well-ventilated area and wear gloves or wash your hands frequently when servicing your vehicle. For more information go to [www.P65Warnings.ca.gov/passenger-vehicle](http://www.P65Warnings.ca.gov/passenger-vehicle).

#### ***NOTE***

The following manuals are available on the website. Please read them as well (see the link on the last page).

- Mazda Connect Owner's manual
- Navigation manual

#### **Privacy**

For information about how Mazda may collect, use, share and store your personal information generally, please see our privacy policy located at [www.mazdausa.com/site/privacy](http://www.mazdausa.com/site/privacy).



For vehicles enabled with connectivity, see our Connectivity Privacy Policy for information about data collected as part of connectivity located at [www.mazdausa.com/site/privacy-connectedservices](http://www.mazdausa.com/site/privacy-connectedservices).

# Web Owner's Manual

You can view the Web Owner's manual using a Computer, Smartphone, or Tablet.

Feel free to use the Web Owner's manual as well.

The target country may differ depending on the vehicle specifications and the vehicle's period of manufacture.

## To Customers in U.S.A.

- Please go to the web site below, and select the desired material or model (model year).

<https://www.mazdausa.com/owners/how-to-use-my-mazda>



## To Customers in Puerto Rico

- Please go to the web site below.

<https://mazdapr.com/manual-de-propietario/>



## To Customers in Canada

- Please go to the web site below, and select the desired material or model (model year).

<https://www.mazda.ca/en/owners/manuals/>



## To Customers in Mexico

- Please go to the web site below.

<https://www.mazda.mx/mi-mazda/manuales>



## Limitations on use

- This Web Owner's manual may not display normally depending on the device being used and the contracted services available with the device.
- Communication fees may occur while connected (accessing).
- Access may not be available in poor network or communication environments.

# A Word to Mazda Owners

---

Thank you for choosing a Mazda product. We at Mazda design and build vehicles with complete customer satisfaction in mind.

To help ensure enjoyable and trouble-free operation of your Mazda vehicle, read this manual carefully and follow its recommendations.

Regular servicing of your vehicle by an expert technician helps maintain both its roadworthiness and its resale value. A world-wide network of Authorized Mazda Dealer can help you with their professional servicing expertise. Their specially trained personnel are best qualified to service your Mazda vehicle properly and precisely to original specifications. Also, they are supported by a wide range of highly specialized tools and equipment specially developed for servicing Mazda vehicles. When maintenance or service is necessary, consult an Authorized Mazda Dealer.

We assure you that all of us at Mazda have an ongoing interest in your motoring pleasure and in your full satisfaction with your Mazda product.

**Mazda Motor Corporation**  
**HIROSHIMA, JAPAN**

## **Important Notes About This Manual**

Keep this manual in the glove compartment as a handy reference for the safe and enjoyable use of your Mazda vehicle. Should you resell the vehicle, leave this manual with it for the next owner.

All specifications and descriptions are accurate at the time of printing. Because improvement is a constant goal at Mazda, we reserve the right to make changes in specifications at any time without notice and without obligation.

## **Air Conditioner and the Environment**

Your Mazda's genuine air conditioner is filled with a refrigerant that has been found not to damage the earth's ozone layer. If the air conditioner does not operate properly, consult an Authorized Mazda Dealer.

### **Perchlorate**

Certain components of this vehicle such as [air bag modules, seat belt pretensioners, lithium batteries,...] may contain Perchlorate Material-- Special handling may apply for service or vehicle end of life disposal. See [www.dtscc.ca.gov/hazardouswaste/perchlorate](http://www.dtscc.ca.gov/hazardouswaste/perchlorate).

**Please be aware that this manual applies to all models, equipment and options. As a result, you may find some explanations for equipment not installed on your vehicle.**

©2023 Mazda Motor Corporation  
October 2023(Print1)

# How to Use This Manual

---

We want to help you get the most driving pleasure from your vehicle. Your owner's manual, when read from beginning to end, can do that in many ways.

Illustrations complement the words of the manual to best explain how to enjoy your Mazda. By reading your manual, you can find out about the features, important safety information, and driving under various road conditions.

You'll find several **WARNINGS**, **CAUTIONS**, and **NOTES** in the manual.



A **WARNING** indicates a situation in which serious injury or death could result if the warning is ignored.



A **CAUTION** indicates a situation in which bodily injury or damage to your vehicle, or both, could result if the caution is ignored.

## **NOTE**

A **NOTE** provides information and sometimes suggests how to make better use of your vehicle.

The symbol below in this manual means "Do not do this" or "Do not let this happen".



The following symbol indicates the operation, such as a push or a turn.

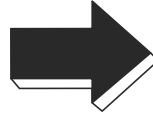

The following symbol indicates the order of the operation, such as a push or a turn.

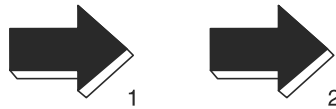

The following symbol indicates the location of parts.



The following symbol indicates a change of status.

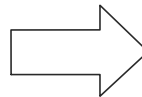

The following symbol, located on some parts of the vehicle, indicates that this manual contains information related to the part.

Please refer to the manual for a detailed explanation.



**Index:** A good place to start is the Index, an alphabetical listing of all information in your manual.

## Table of Contents

Name of Each Part	1
Read This First	2
Equipment to Protect Occupants/Pedestrians	3
Opening/closing	4
Driving	5
Equipment to Make Cabin More Comfortable	6
Other Equipment	7
What to Do in Case of Emergency	8
Inspection and Servicing/Cleaning	9
Specifications/Customer Information and Reporting Safety Defects	10
Index	11



# 1

## Name of Each Part

<b>Steering Wheel Area</b>		<b>Rear Cabin Overview.....</b>	<b>1-6</b>
<b>Overview.....</b>	<b>1-2</b>	Rear Cabin Overview.....	1-6
Steering Wheel Area			
Overview.....	1-2		
<b>Driver's Seat Area Overview.....</b>	<b>1-3</b>	<b>Luggage Compartment</b>	
Driver's Seat Area		<b>Overview.....</b>	<b>1-7</b>
Overview.....	1-3	Luggage Compartment	
		Overview.....	1-7
<b>Instrument Panel Area</b>		<b>Front Exterior Overview.....</b>	<b>1-8</b>
<b>Overview.....</b>	<b>1-4</b>	Front Exterior Overview.....	1-8
Instrument Panel Area			
Overview.....	1-4	<b>Rear Exterior Overview.....</b>	<b>1-9</b>
		Rear Exterior Overview.....	1-9
<b>Front Cabin Overview.....</b>	<b>1-5</b>		
Front Cabin Overview.....	1-5		



# Steering Wheel Area Overview

## Steering Wheel Area Overview

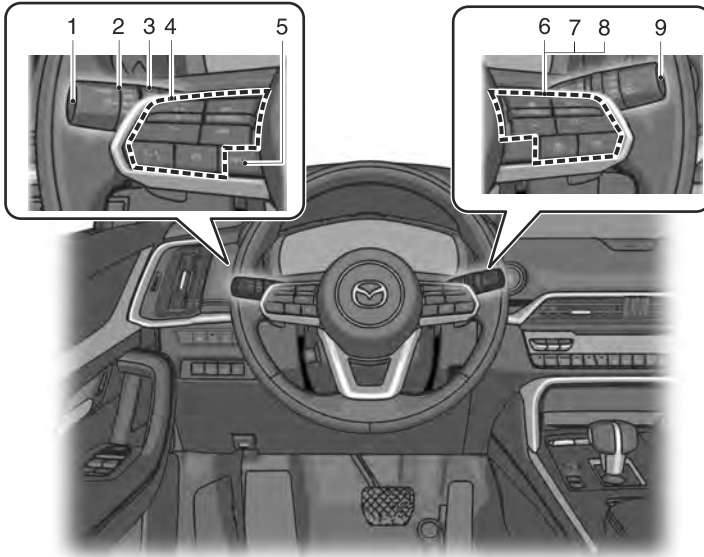

- ① High Beam Control System (HBC) switch..... page 5-141
- ② Lighting control..... page 5-76
- ③ Turn and lane-change signals..... page 5-80
- ④ Audio remote control switches..... page 7-8
- ⑤ INFO switch..... page 5-24
- ⑥ Mazda Radar Cruise Control (MRCC) switches..... page 5-171
- ⑦ Cruising & Traffic Support (CTS) switches.....page 5-184
- ⑧ Cruise control switches..... page 5-247
- ⑨ Wiper and washer lever..... page 5-82

**Driver's Seat Area Overview**

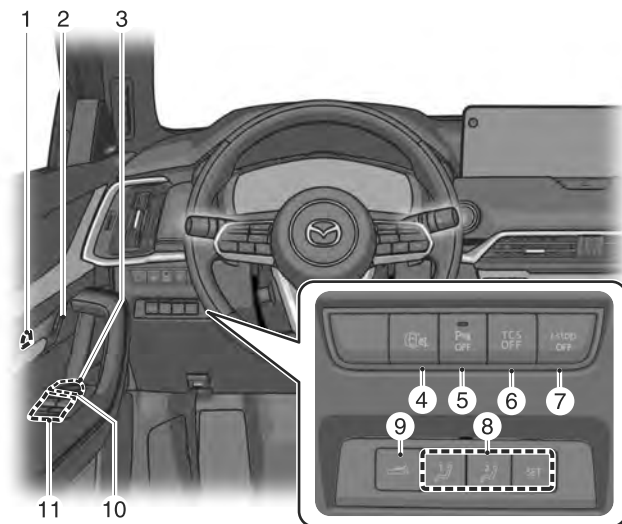

- ① Door-lock knob..... page 4-12
- ② Door-lock switch..... page 4-12
- ③ Outside mirror switches..... page 5-9
- ④ i-ACTIVSENSE mute switch..... page 5-124
- ⑤ Parking sensor OFF switch..... page 5-259
- ⑥ TCS OFF switch..... page 5-94
- ⑦ i-stop OFF switch..... page 5-21
- ⑧ Position memory buttons..... page 3-36
- ⑨ Power liftgate switch..... page 4-20
- ⑩ Power window switches..... page 4-28
- ⑪ Power window lock switch..... page 4-28

# Instrument Panel Area Overview

## Instrument Panel Area Overview

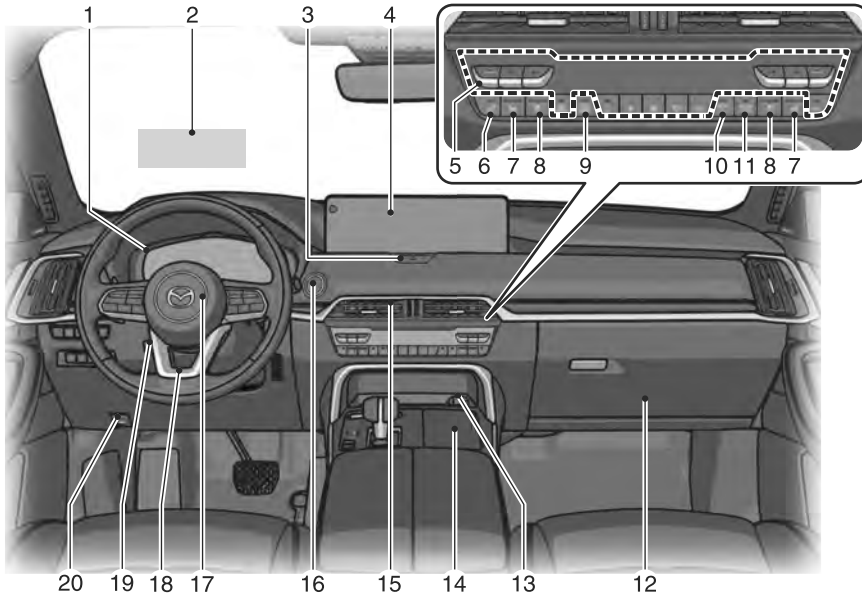

① Instrument cluster.....	page 5-23
② Active driving display.....	page 5-50
③ Hazard warning flasher.....	page 5-90
④ Mazda Connect.....	page 7-8
⑤ Climate control system (front).....	page 6-6
⑥ Heated steering wheel switch.....	page 6-23
⑦ Seat warmer switches.....	page 6-20
⑧ Seat ventilation switches.....	page 6-25
⑨ Rear window defogger switch.....	page 5-87
⑩ Rear climate control system power switch.....	page 6-16
⑪ Rear control switch.....	page 6-16
⑫ Glove compartment.....	page 7-30
⑬ Accessory socket.....	page 7-45
⑭ Cup holder.....	page 7-28
⑮ Vent.....	page 6-2
⑯ Push button start.....	page 5-14
⑰ Horn.....	page 5-91
⑱ Lock release lever.....	page 3-45
⑲ Tilt and telescopic switch.....	page 3-45
⑳ Hood release handle.....	page 4-26

**Front Cabin Overview**

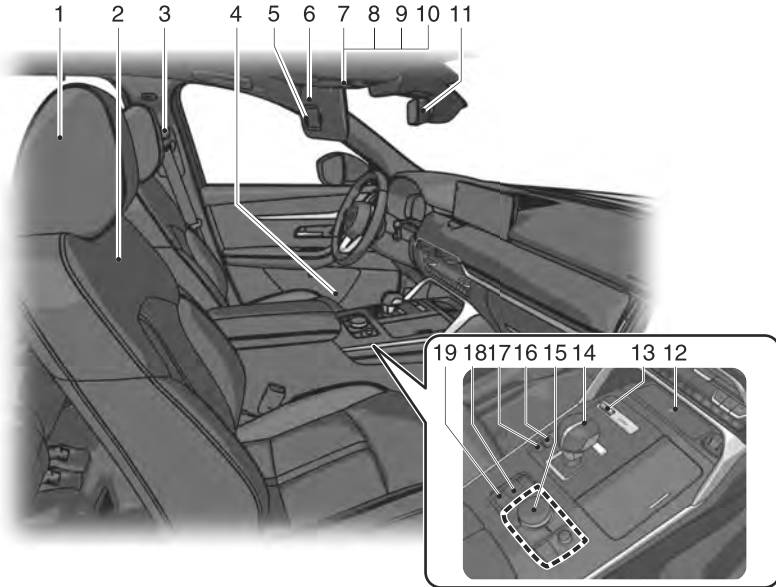

- ① Head restraint..... page 3-43
- ② Front seat..... page 3-33
- ③ Seat belt..... page 3-27
- ④ Bottle holder.....page 7-29
- ⑤ Vanity mirror.....page 7-37
- ⑥ Sunvisor..... page 7-36
- ⑦ Overhead light (front)..... page 7-40
- ⑧ Map lights..... page 7-41
- ⑨ Overhead console..... page 7-32
- ⑩ Panorama sunroof switch/Moonroof switch..... page 4-31, 4-35
- ⑪ Rearview mirror..... page 5-12
- ⑫ Wireless Charger (Qi)..... page 7-52
- ⑬ Mazda intelligent Drive Select (Mi-Drive) switch..... page 5-103
- ⑭ Selector lever..... page 5-54
- ⑮ Commander switch..... page 7-8
- ⑯ Hill descent control switch.....page 5-100
- ⑰ 360° View Monitor switch.....page 5-231
- ⑱ Electric Parking Brake (EPB) switch..... page 5-66
- ⑲ AUTOHOLD switch..... page 5-72

# Rear Cabin Overview

## Rear Cabin Overview

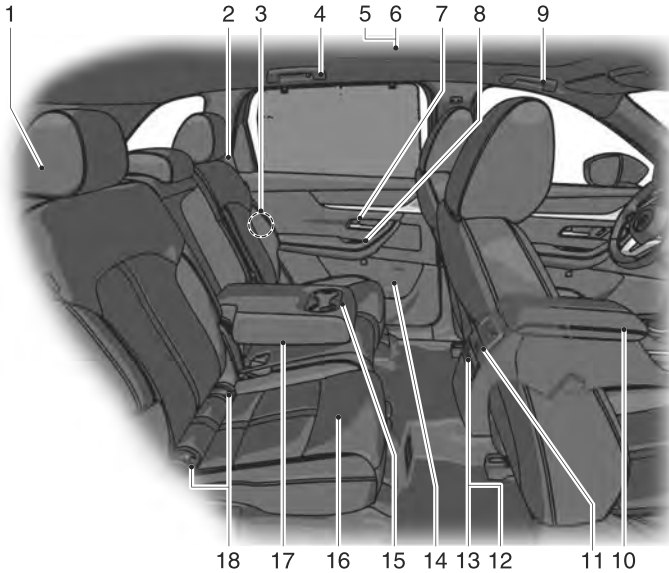

① Head restraint.....	page 3-43
② Seat belt.....	page 3-27
③ Child safety lock.....	page 4-12
④ Rear coat hook.....	page 7-33
⑤ Overhead light (rear).....	page 7-40
⑥ Map lights.....	page 7-41
⑦ Door-lock knob.....	page 4-12
⑧ Power window switch.....	page 4-28
⑨ Assist grip.....	page 7-54
⑩ Center console.....	page 7-31
⑪ USB power outlet.....	page 7-49
⑫ Seat warmer switches.....	page 6-20
⑬ Climate control system (rear).....	page 6-14
⑭ Bottle holder.....	page 7-29
⑮ Cup holder.....	page 7-28
⑯ Rear seat.....	page 3-39
⑰ Armrest.....	page 3-41
⑱ LATCH Lower Anchors.....	page 3-64

## Luggage Compartment Overview

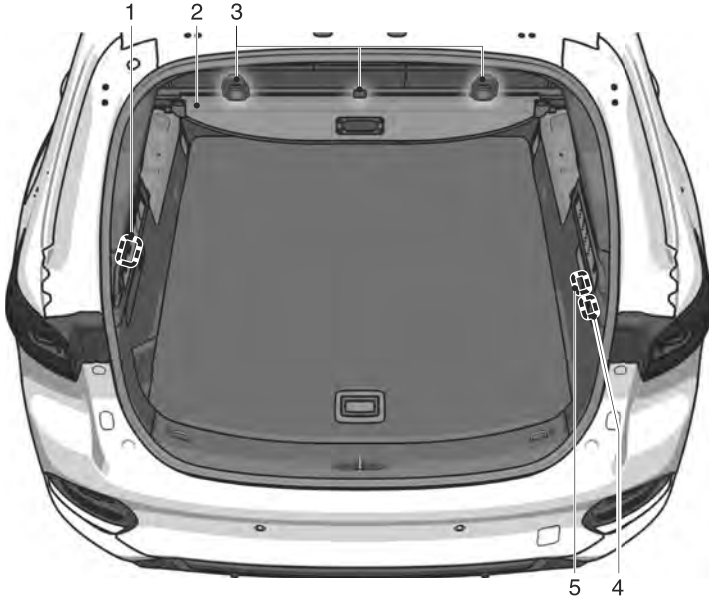

- ① Luggage compartment lights..... page 7-42
- ② Luggage compartment cover..... page 7-56
- ③ Anchor bracket..... page 3-55
- ④ Accessory socket..... page 7-45
- ⑤ AC power outlet..... page 7-47

# Front Exterior Overview

---

## Front Exterior Overview

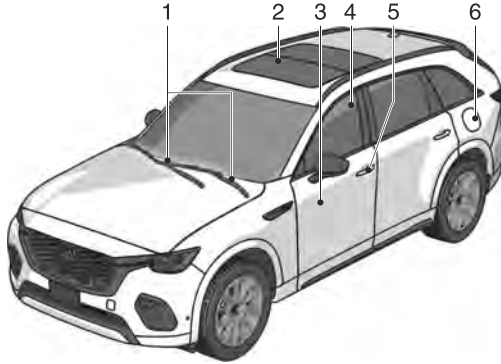

- ① Windshield wiper blades..... page 9-28
- ② Panorama sunroof/Moonroof..... page 4-30, 4-33
- ③ Door..... page 4-11
- ④ Window..... page 4-27
- ⑤ Touch sensor..... page 4-12
- ⑥ Fuel-filler lid..... page 5-112

**Rear Exterior Overview**

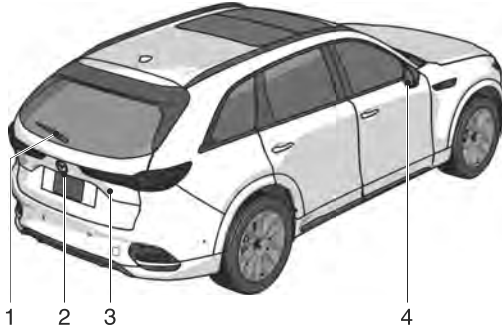

- ① Rear window wiper blade..... page 9-28
- ② Electric liftgate opener..... page 4-17
- ③ Liftgate..... page 4-16
- ④ Outside mirror..... page 5-8



# MEMO

# 2

## Read This First

**Things to Be Observed..... 2-2**  
  Things to Be Observed While  
  Driving..... 2-2  
  Things to Be Observed When  
  Parking or Stopping..... 2-3

**The Data Stored in The  
Vehicle..... 2-4**  
  Event Data Recorder (EDR) .....  
  ..... 2-4  
  A computer that records vehicle  
  data..... 2-5

Data handling..... 2-5

**Open Source Software  
Information..... 2-6**  
  Instrument Cluster (Type  
  A)..... 2-6  
  Active Driving Display..... 2-21  
  Driver Monitoring Camera .....  
  ..... 2-21  
  Cruising & Traffic Support  
  (CTS)..... 2-22

## Things to Be Observed

---

### Things to Be Observed While Driving



**Never stop the engine when going down a hill.**

Stopping the engine when going down a hill is dangerous. This causes the loss of power steering and power brake control, and may cause damage to the drivetrain. Any loss of steering or braking control could cause an accident.

**Be extremely careful if it is necessary to downshift on slippery surfaces.**

Downshifting into lower gear while driving on slippery surfaces is dangerous. The sudden change in tire speed could cause the tires to skid. This could lead to loss of vehicle control and an accident.

**Avoid sharp turns, excessive speed and abrupt maneuvers when driving this vehicle.**

Sharp turns, excessive speed and abrupt maneuvering of this vehicle are dangerous as it could result in the increased risk of loss of vehicle control, vehicle roll-over, personal injury or death.

This vehicle has a higher center of gravity. Vehicles with a higher center of gravity such as utility vehicles handle differently than vehicles with a lower center of gravity.

Utility vehicles are not designed for cornering at high speeds any more than low profile sports cars are designed to perform satisfactorily under off-road conditions.

In addition, utility vehicles have a significantly higher rollover rate than other types of vehicles.

In a rollover crash, an unbelted person is significantly more likely to die than a person wearing a seat belt.

**Dry off brakes that have become wet by driving slowly, releasing the accelerator pedal and lightly applying the brakes several times until the brake performance returns to normal.**

Driving with wet brakes is dangerous. Increased stopping distance or the vehicle pulling to one side when braking could result in a serious accident. Light braking will indicate whether the brakes have been affected.



Do not drive the vehicle on flooded roads as it could cause short circuiting of electrical/electronic parts, or engine damage or stalling from water absorption. If the vehicle has been immersed in water, consult an Authorized Mazda Dealer.

## Things to Be Observed When Parking or Stopping

### **WARNING**

**Never leave a child alone in the vehicle.**

The temperature inside the cabin could become extremely hot which could be life-threatening.

An unattended child could operate equipment or accelerate the vehicle resulting in an accident.

### **CAUTION**

- Do not leave any items in the vehicle that could cause a vehicle fire if they become hot.  
The temperature inside the cabin could become extremely hot.
- Stop the vehicle in a place where there are no flammable objects.
- Do not leave the engine running in a poorly ventilated area, such as in a garage or in a snow-covered area.  
If there is a malfunction in the exhaust pipe or exhaust noise, have the vehicle inspected.  
There is a risk of carbon monoxide poisoning.
- Do not sleep in the vehicle with the engine running.  
There is a risk that the vehicle may move unintentionally.

## The Data Stored in The Vehicle

---

### Event Data Recorder (EDR)

This vehicle is equipped with an event data recorder (EDR). The main purpose of an EDR is to record, in certain crash or near crash-like situations, such as an air bag deployment or hitting a road obstacle, data that will assist in understanding how a vehicle's systems performed. The EDR is designed to record data related to vehicle dynamics and safety systems for a short period of time, typically 30 seconds or less. The EDR in this vehicle is designed to record such data as:

- How various systems in your vehicle were operating;
- Whether or not the driver and passenger safety belts were buckled/ fastened;
- How far (if at all) the driver was depressing the accelerator and/or brake pedal; and,
- How fast the vehicle was traveling.

These data can help provide a better understanding of the circumstances in which crashes and injuries occur.

**NOTE:**

EDR data are recorded by your vehicle only if a non-trivial crash or near crash-like situation occurs; no data are recorded by the EDR under normal driving conditions and no personal data (e.g., name, gender, age, and crash location) are recorded. However, other parties, such as law enforcement, could combine the EDR data with the type of personally identifying data routinely acquired during a crash investigation.

To read data recorded by an EDR, special equipment is required, and access to the vehicle or the EDR is

needed. In addition to the vehicle manufacturer, other parties, such as law enforcement, that have the special equipment, can read the information if they have access to the vehicle or the EDR.

Mazda will not disclose any of the data recorded in an EDR to a third party unless:

- A written agreement from the vehicle owner or the lessee is obtained
- Officially requested by the police or other law enforcement authorities
- Used as a defense for Mazda in a lawsuit, claim, or arbitration
- Ordered by a judge or court

However, if necessary Mazda will:

- Use the data for research on Mazda vehicle performance, including safety.
- Disclose the data or the summarized data to a third party for research purposes without disclosing vehicle or owner identification information.

# The Data Stored in The Vehicle

---

## A computer that records vehicle data

A computer is equipped that records data related to the vehicle control, operation, and the driving environment.

This computer records information such as the following.

- Vehicle conditions such as engine speed and vehicle speed
- Driving operation conditions such as accelerator and brake pedals, and information related to the environmental circumstances while driving the vehicle
- Malfunction diagnosis information from on-vehicle computer
- Information related to controls of other on-vehicle computers

The recorded information differs depending on the vehicle grade and the equipment.

Personal information (name, sex, age, and collision location) is not recorded.

## Data handling

Mazda and its contractors may obtain and use data recorded in EDRs and computers that record vehicle data for the purpose of vehicle malfunction diagnosis, research and development, and quality improvement.

Mazda will not disclose or provide any of the obtained data to a third party unless:

- An agreement from the vehicle owner (agreements from lessor and lessee for leased vehicle) is obtained
- Officially requested by the police or other law enforcement authorities
- For statistical processing by a research institution after processing the data so that identification of the owner or the vehicle is impossible

## Instrument Cluster (Type A)

This product includes free/open sources. Information about the licensing and source code is available at the following URL.

<http://car.panasonic.jp/oss/j04ljmmb>

### Libunibreak License

Licence

-----

This library is released under an open-source licence, the zlib/libpng licence. Please check the file LICENCE for details.

Apart from using the algorithm, part of the code is derived from the data provided under

<URL:<http://www.unicode.org/Public/>>

And the Unicode Terms of Use may apply:

[URL:http://www.unicode.org/copyright.html](http://www.unicode.org/copyright.html)

LICENSE:

Copyright (C) 2008-2012 Wu Yongwei <wuyongwei at gmail dot com>

Copyright (C) 2012 Tom Hacothen <tom dot hacothen at samsung dot com>

This software is provided 'as-is', without any express or implied warranty. In no event will the author be held liable for any damages arising from the use of this software.

Permission is granted to anyone to use this software for any purpose, including commercial applications, and to alter it and redistribute it freely, subject to the following restrictions:

1. The origin of this software must not be misrepresented; you must not claim that you wrote the original software. If you use this software in a product, an acknowledgement in the product documentation would be appreciated but is not required.
2. Altered source versions must be plainly marked as such, and must not be misrepresented as being the original software.
3. This notice may not be removed or altered from any source distribution.

With respect to "Libunibreak Library", please be noted that this software includes the program altered from zlib.

## Lua Disclaimer

Copyright © 1994-2016 Lua.org, PUC-Rio.  
Permission is hereby granted, free of charge, to any person obtaining a copy of this software and associated documentation files (the "Software"), to deal in the Software without restriction, including without limitation the rights to use, copy, modify, merge, publish, distribute, sublicense, and/or sell copies of the Software, and to permit persons to whom the Software is furnished to do so, subject to the following conditions:

The above copyright notice and this permission notice shall be included in all copies or substantial portions of the Software.  
THE SOFTWARE IS PROVIDED "AS IS", WITHOUT WARRANTY OF ANY KIND, EXPRESS OR IMPLIED, INCLUDING BUT NOT LIMITED TO THE WARRANTIES OF MERCHANTABILITY, FITNESS FOR A PARTICULAR PURPOSE AND NONINFRINGEMENT. IN NO EVENT SHALL THE AUTHORS OR COPYRIGHT HOLDERS BE LIABLE FOR ANY CLAIM, DAMAGES OR OTHER LIABILITY, WHETHER IN AN ACTION OF CONTRACT, TORT OR OTHERWISE, ARISING FROM, OUT OF OR IN CONNECTION WITH THE SOFTWARE OR THE USE OR OTHER DEALINGS IN THE SOFTWARE.

## Bidi.cpp Disclaimer

Credits:

-----

Written by: Asmus Freytag  
Command line interface by: Rick McGowan  
Verification (v24): Doug Felt

Disclaimer and legal rights:

-----

Copyright (C) 1999-2009, ASMUS, Inc. All Rights Reserved.  
Distributed under the Terms of Use in  
<http://www.unicode.org/copyright.html>.

THIS SOFTWARE IS PROVIDED "AS IS", WITHOUT WARRANTY OF ANY KIND, EXPRESS OR IMPLIED, INCLUDING BUT NOT LIMITED TO THE WARRANTIES OF MERCHANTABILITY, FITNESS FOR A PARTICULAR PURPOSE AND NONINFRINGEMENT OF THIRD PARTY RIGHTS. IN NO EVENT SHALL THE COPYRIGHT HOLDER OR HOLDERS INCLUDED IN THIS NOTICE BE LIABLE FOR ANY CLAIM, OR ANY SPECIAL INDIRECT OR CONSEQUENTIAL DAMAGES, OR ANY DAMAGES WHATSOEVER RESULTING FROM LOSS OF USE, DATA OR PROFITS, WHETHER IN AN ACTION OF CONTRACT, NEGLIGENCE OR OTHER TORTIOUS ACTION, ARISING OUT OF OR IN CONNECTION WITH THE USE OR PERFORMANCE OF THE SOFTWARE.

The file bid.rc is included in the software covered by the above.



## Unicode.org Data Files Disclaimer

Copyright © 1991 - 2018 Unicode, Inc. All rights reserved.  
Distributed under the Terms of Use in  
<http://www.unicode.org/copyright.html>.

Permission is hereby granted, free of charge, to any person obtaining a copy of the Unicode data files and any associated documentation (the "Data Files") or Unicode software and any associated documentation (the "Software") to deal in the Data Files or Software without restriction, including without limitation the rights to use, copy, modify, merge, publish, distribute, and / or sell copies of the Data Files or Software, and to permit persons to whom the Data Files or Software are furnished to do so, provided that either

(a) this copyright and permission notice appear with all copies of the Data Files or Software, or

(b) this copyright and permission notice appear in associated Documentation.

THE DATA FILES AND SOFTWARE ARE PROVIDED "AS IS", WITHOUT WARRANTY OF ANY KIND, EXPRESS OR IMPLIED, INCLUDING BUT NOT LIMITED TO THE WARRANTIES OF MERCHANTABILITY, FITNESS FOR A PARTICULAR PURPOSE AND NONINFRINGEMENT OF THIRD PARTY RIGHTS.

IN NO EVENT SHALL THE COPYRIGHT HOLDER OR HOLDERS INCLUDED IN THIS NOTICE BE LIABLE FOR ANY CLAIM, OR ANY SPECIAL INDIRECT OR CONSEQUENTIAL DAMAGES, OR ANY DAMAGES WHATSOEVER RESULTING FROM LOSS OF USE, DATA OR PROFITS, WHETHER IN AN ACTION OF CONTRACT, NEGLIGENCE OR OTHER TORTIOUS ACTION, ARISING OUT OF OR IN CONNECTION WITH THE USE OR PERFORMANCE OF THE DATA FILES OR SOFTWARE.

Except as contained in this notice, the name of a copyright holder shall not be used in advertising or otherwise to promote the sale, use or other dealings in these Data Files or Software without prior written authorization of the copyright holder.

### Unicode® Terms of Use

Unicode Copyright.

Copyright © 1991-2018 Unicode, Inc. All rights reserved.

Certain documents and files on this website contain a legend indicating that "Modification is permitted." Any person is hereby authorized, without fee, to modify such documents and files to create derivative works conforming to the Unicode® Standard, subject to Terms and Conditions herein.

Any person is hereby authorized, without fee, to view, use, reproduce, and distribute all documents and files, subject to the Terms and Conditions herein.

Further specifications of rights and restrictions pertaining to the use of the particular set of data files known as the "Unicode Character Database" can be found in the [License](#).

Each version of the Unicode Standard has further specifications of rights and restrictions of use. For the book editions (Unicode 5.0 and earlier), these are found on the back of the [title page](#). The online code charts carry specific restrictions. All other files, including online documentation of the core specification for Unicode 6.0 and later, are covered under these general Terms of Use.

No license is granted to "mirror" the Unicode website where a fee is charged for access to the "mirror" site.

## Open Source Software Information

---

Modification is not permitted with respect to this document. All copies of this document must be verbatim.

Restricted Rights Legend. Any technical data or software which is licensed to the United States of America, its agencies and/or instrumentalities under this Agreement is commercial technical data or commercial computer software developed exclusively at private expense as defined in FAR 2.101, or DFARS 252.227-7014 (June 1995), as applicable. For technical data, use, duplication, or disclosure by the Government is subject to restrictions as set forth in DFARS 202.227-7015 Technical Data, Commercial and Items (Nov 1995) and this Agreement. For Software, in accordance with FAR 12-212 or DFARS 227-7202, as applicable, use, duplication or disclosure by the Government is subject to the restrictions set forth in this Agreement.

Warranties and Disclaimers.

This publication and/or website may include technical or typographical errors or other inaccuracies. Changes are periodically added to the information herein; these changes will be incorporated in new editions of the publication and/or website. Unicode may make improvements and/or changes in the product(s) and/or program(s) described in this publication and/or website at any time.

If this file has been purchased on magnetic or optical media from Unicode, Inc. the sole and exclusive remedy for any claim will be exchange of the defective media within ninety (90) days of original purchase.

EXCEPT AS PROVIDED IN SECTION C.2, THIS PUBLICATION AND/OR SOFTWARE IS PROVIDED "AS IS" WITHOUT WARRANTY OF ANY KIND EITHER EXPRESS, IMPLIED, OR STATUTORY, INCLUDING, BUT NOT LIMITED TO, ANY WARRANTIES OF MERCHANTABILITY, FITNESS FOR A PARTICULAR PURPOSE, OR NON-INFRINGEMENT. UNICODE AND ITS LICENSORS ASSUME NO RESPONSIBILITY FOR ERRORS OR OMISSIONS IN THIS PUBLICATION AND/OR SOFTWARE OR OTHER DOCUMENTS WHICH ARE REFERENCED BY OR LINKED TO THIS PUBLICATION OR THE UNICODE WEBSITE.

Waiver of Damages. In no event shall Unicode or its licensors be liable for any special, incidental, indirect or consequential damages of any kind, or any damages whatsoever, whether or not Unicode was advised of the possibility of the damage, including, without limitation, those resulting from the following: loss of use, data or profits, in connection with the use, modification or distribution of this information or its derivatives.

# Open Source Software Information

---

## Trademarks & Logos.

The Unicode Word Mark and the Unicode Logo are trademarks of Unicode, Inc. "The Unicode Consortium" and "Unicode, Inc." are trade names of Unicode, Inc. Use of the information and materials found on this website indicates your acknowledgement of Unicode, Inc.'s exclusive worldwide rights in the Unicode Word Mark, the Unicode Logo, and the Unicode trade names.

The Unicode Consortium Name and Trademark Usage Policy ("Trademark Policy") are incorporated herein by reference and you agree to abide by the provisions of the Trademark Policy, which may be changed from time to time in the sole discretion of Unicode, Inc.

All third party trademarks referenced herein are the property of their respective owners.

## Miscellaneous.

**Jurisdiction and Venue.** This server is operated from a location in the State of California, United States of America. Unicode makes no representation that the materials are appropriate for use in other locations. If you access this server from other locations, you are responsible for compliance with local laws. This Agreement, all use of this site and any claims and damages resulting from use of this site

are governed solely by the laws of the State of California without regard to any principles which would apply the laws of a different jurisdiction. The user agrees that any disputes regarding this site shall be resolved solely in the courts located in Santa Clara County, California. The user agrees said courts have personal jurisdiction and agree to waive any right to transfer the dispute to any other forum. Modification by Unicode. Unicode shall have the right to modify this Agreement at any time by posting it to this site. The user may not assign any part of this Agreement without Unicode's prior written consent.

Taxes. The user agrees to pay any taxes arising from access to this website or use of the information herein, except for those based on Unicode's net income.

Severability. If any provision of this Agreement is declared invalid or unenforceable, the remaining provisions of this Agreement shall remain in effect.

Entire Agreement. This Agreement constitutes the entire agreement between the parties.

### EXHIBIT 1

#### UNICODE, INC. LICENSE AGREEMENT - DATA FILES AND SOFTWARE

Unicode Data Files include all data files under the directories <http://www.unicode.org/Public/>, <http://www.unicode.org/reports/>, <http://www.unicode.org/cldr/data/>, <http://source.icu-project.org/repos/icu/>, and <http://www.unicode.org/utility/trac/browser/>.

Unicode Data Files do not include PDF online code charts under the directory <http://www.unicode.org/Public/>.

Software includes any source code published in the Unicode Standard or under the directories

<http://www.unicode.org/Public/>, <http://www.unicode.org/reports/>, <http://www.unicode.org/cldr/data/>, <http://source.icu-project.org/repos/icu/>, and <http://www.unicode.org/utility/trac/browser/>.

# Open Source Software Information

---

NOTICE TO USER: Carefully read the following legal agreement. BY DOWNLOADING, INSTALLING, COPYING OR OTHERWISE USING UNICODE INC.'S DATA FILES ("DATA FILES"), AND/OR SOFTWARE ("SOFTWARE"), YOU UNEQUIVOCALLY ACCEPT, AND AGREE TO BE BOUND BY, ALL OF THE TERMS AND CONDITIONS OF THIS AGREEMENT.

IF YOU DO NOT AGREE, DO NOT DOWNLOAD, INSTALL, COPY, DISTRIBUTE OR USE THE DATA FILES OR SOFTWARE.

## COPYRIGHT AND PERMISSION NOTICE

Copyright © 1991-2018 Unicode, Inc. All rights reserved.  
Distributed under the Terms of Use in  
<http://www.unicode.org/copyright.html>.

Permission is hereby granted, free of charge, to any person obtaining a copy of the Unicode data files and any associated documentation (the "Data Files") or Unicode software and any associated documentation (the "Software") to deal in the Data Files or Software without restriction, including without limitation the rights to use, copy, modify, merge, publish, distribute, and/or sell copies of the Data Files or Software, and to permit persons to whom the Data Files or Software are furnished to do so, provided that either (a) this copyright and permission notice appear with all copies of the Data Files or Software, or (b) this copyright and permission notice appear in associated Documentation.

THE DATA FILES AND SOFTWARE ARE PROVIDED "AS IS", WITHOUT WARRANTY OF ANY KIND, EXPRESS OR IMPLIED, INCLUDING BUT NOT LIMITED TO THE WARRANTIES OF MERCHANTABILITY, FITNESS FOR A PARTICULAR PURPOSE AND NONINFRINGEMENT OF THIRD PARTY RIGHTS. IN NO EVENT SHALL THE COPYRIGHT HOLDER OR HOLDERS INCLUDED IN THIS NOTICE BE LIABLE FOR ANY CLAIM, OR ANY SPECIAL INDIRECT OR CONSEQUENTIAL DAMAGES, OR ANY DAMAGES WHATSOEVER RESULTING FROM LOSS OF USE, DATA OR PROFITS, WHETHER IN AN ACTION OF CONTRACT, NEGLIGENCE OR OTHER TORTIOUS ACTION, ARISING OUT OF OR IN CONNECTION WITH THE USE OR PERFORMANCE OF THE DATA FILES OR SOFTWARE.

Except as contained in this notice, the name of a copyright holder shall not be used in advertising or otherwise to promote the sale, use or other dealings in these Data Files or Software without prior written authorization of the copyright holder.

## Khronos

\*\* Copyright (c) 2017 The Khronos Group Inc.  
\*\*  
\*\* Licensed under the Apache License, Version 2.0 (the "License");  
\*\* you may not use this file except in compliance with the License.  
\*\* You may obtain a copy of the License at  
\*\*  
\*\* <http://www.apache.org/licenses/LICENSE-2.0>  
\*\*  
\*\* Unless required by applicable law or agreed to in writing, software  
\*\* distributed under the License is distributed on an "AS IS" BASIS,  
\*\* WITHOUT WARRANTIES OR CONDITIONS OF ANY KIND, either express or implied,  
\*\* See the License for the specific language governing permissions and  
\*\* limitations under the License.  
\*\* Copyright (c) 2007-2016 The Khronos Group Inc.  
\*\* Copyright (c) 2008-2009 The Khronos Group Inc.  
\*\* Copyright (c) 2013-2016 The Khronos Group Inc.  
\*\* Copyright (c) 2013-2017 The Khronos Group Inc.  
\*\*  
\*\* Permission is hereby granted, free of charge, to any person obtaining a  
\*\* copy of this software and/or associated documentation files (the  
\*\* "Materials"), to deal in the Materials without restriction, including  
\*\* without limitation the rights to use, copy, modify, merge, publish,  
\*\* distribute, sublicense, and/or sell copies of the Materials, and to  
\*\* permit persons to whom the Materials are furnished to do so, subject to  
\*\* the following conditions:  
\*\*  
\*\* The above copyright notice and this permission notice shall be included  
\*\* in all copies or substantial portions of the Materials.  
\*\*  
\*\* THE MATERIALS ARE PROVIDED "AS IS", WITHOUT WARRANTY OF ANY KIND,  
\*\* EXPRESS OR IMPLIED, INCLUDING BUT NOT LIMITED TO THE WARRANTIES OF  
\*\* MERCHANTABILITY, FITNESS FOR A PARTICULAR PURPOSE AND NONINFRINGEMENT.  
\*\* IN NO EVENT SHALL THE AUTHORS OR COPYRIGHT HOLDERS BE LIABLE FOR ANY  
\*\* CLAIM, DAMAGES OR OTHER LIABILITY, WHETHER IN AN ACTION OF CONTRACT,  
\*\* TORT OR OTHERWISE, ARISING FROM, OUT OF OR IN CONNECTION WITH THE  
\*\* MATERIALS OR THE USE OR OTHER DEALINGS IN THE MATERIALS.

# Open Source Software Information

---

@Copyright Copyright (c) Imagination Technologies Ltd. All Rights Reserved  
@License MIT

The contents of this file are subject to the MIT license as set out below.

Permission is hereby granted, free of charge, to any person obtaining a copy of this software and associated documentation files (the "Software"), to deal in the Software without restriction, including without limitation the rights to use, copy, modify, merge, publish, distribute, sublicense, and/or sell copies of the Software, and to permit persons to whom the Software is furnished to do so, subject to the following conditions:

The above copyright notice and this permission notice shall be included in all copies or substantial portions of the Software.

THE SOFTWARE IS PROVIDED "AS IS", WITHOUT WARRANTY OF ANY KIND, EXPRESS OR IMPLIED, INCLUDING BUT NOT LIMITED TO THE WARRANTIES OF MERCHANTABILITY, FITNESS FOR A PARTICULAR PURPOSE AND NONINFRINGEMENT. IN NO EVENT SHALL THE AUTHORS OR COPYRIGHT HOLDERS BE LIABLE FOR ANY CLAIM, DAMAGES OR OTHER LIABILITY, WHETHER IN AN ACTION OF CONTRACT, TORT OR OTHERWISE, ARISING FROM, OUT OF OR IN CONNECTION WITH THE SOFTWARE OR THE USE OR OTHER DEALINGS IN THE SOFTWARE.



Apache License  
Version 2.0, January 2004  
<http://www.apache.org/licenses/>

## TERMS AND CONDITIONS FOR USE, REPRODUCTION, AND DISTRIBUTION

### 1. Definitions.

"License" shall mean the terms and conditions for use, reproduction, and distribution as defined by Sections 1 through 9 of this document.

"Licensor" shall mean the copyright owner or entity authorized by the copyright owner that is granting the License.

"Legal Entity" shall mean the union of the acting entity and all other entities that control, are controlled by, or are under common control with that entity. For the purposes of this definition, "control" means (i) the power, direct or indirect, to cause the direction or management of such entity, whether by contract or otherwise, or (ii) ownership of fifty percent (50%) or more of the outstanding shares, or (iii) beneficial ownership of such entity.

"You" (or "Your") shall mean an individual or Legal Entity exercising permissions granted by this License.

"Source" form shall mean the preferred form for making modifications, including but not limited to software source code, documentation source, and configuration files.

"Object" form shall mean any form resulting from mechanical transformation or translation of a Source form, including but not limited to compiled object code, generated documentation, and conversions to other media types.

"Work" shall mean the work of authorship, whether in Source or Object form, made available under the License, as indicated by a copyright notice that is included in or attached to the work (an example is provided in the Appendix below).

"Derivative Works" shall mean any work, whether in Source or Object form, that is based on (or derived from) the Work and for which the editorial revisions, annotations, elaborations, or other modifications represent, as a whole, an original work of authorship. For the purposes of this License, Derivative Works shall not include works that remain separable from, or merely link (or bind by name) to the interfaces of, the Work and Derivative Works thereof.

# Open Source Software Information

---

"Contribution" shall mean any work of authorship, including the original version of the Work and any modifications or additions to that Work or Derivative Works thereof, that is intentionally submitted to Licensor for inclusion in the Work by the copyright owner or by an individual or Legal Entity authorized to submit on behalf of the copyright owner. For the purposes of this definition, "submitted" means any form of electronic, verbal, or written communication sent to the Licensor or its representatives, including but not limited to communication on electronic mailing lists, source code control systems, and issue tracking systems that are managed by, or on behalf of, the Licensor for the purpose of discussing and improving the Work, but excluding communication that is conspicuously marked or otherwise designated in writing by the copyright owner as "Not a Contribution."

"Contributor" shall mean Licensor and any individual or Legal Entity on behalf of whom a Contribution has been received by Licensor and subsequently incorporated within the Work.

2. Grant of Copyright License. Subject to the terms and conditions of this License, each Contributor hereby grants to You a perpetual, worldwide, non-exclusive, no-charge, royalty-free, irrevocable copyright license to reproduce, prepare Derivative Works of, publicly display, publicly perform, sublicense, and distribute the Work and such Derivative Works in Source or Object form.
3. Grant of Patent License. Subject to the terms and conditions of this License, each Contributor hereby grants to You a perpetual, worldwide, non-exclusive, no-charge, royalty-free, irrevocable (except as stated in this section) patent license to make, have made, use, offer to sell, sell, import, and otherwise transfer the Work, where such license applies only to those patent claims licensable by such Contributor that are necessarily infringed by their Contribution(s) alone or by combination of their Contribution(s) with the Work to which such Contribution(s) was submitted. If You institute patent litigation against any entity (including a cross-claim or counterclaim in a lawsuit) alleging that the Work or a Contribution incorporated within the Work constitutes direct or contributory patent infringement, then any patent licenses granted to You under this License for that Work shall terminate as of the date such litigation is filed.

## Open Source Software Information

---

4. Redistribution. You may reproduce and distribute copies of the Work or Derivative Works thereof in any medium, with or without modifications, and in Source or Object form, provided that You meet the following conditions:
  - (a) You must give any other recipients of the Work or Derivative Works a copy of this License; and
  - (b) You must cause any modified files to carry prominent notices stating that You changed the files; and
  - (c) You must retain, in the Source form of any Derivative Works that You distribute, all copyright, patent, trademark, and attribution notices from the Source form of the Work, excluding those notices that do not pertain to any part of the Derivative Works; and
  - (d) If the Work includes a "NOTICE" text file as part of its distribution, then any Derivative Works that You distribute must include a readable copy of the attribution notices contained within such NOTICE file, excluding those notices that do not pertain to any part of the Derivative Works, in at least one of the following places: within a NOTICE text file distributed as part of the Derivative Works; within the Source form or documentation, if provided along with the Derivative Works; or, within a display generated by the Derivative Works, if and wherever such third-party notices normally appear. The contents of the NOTICE file are for informational purposes only and do not modify the License. You may add Your own attribution notices within Derivative Works that You distribute, alongside or as an addendum to the NOTICE text from the Work, provided that such additional attribution notices cannot be construed as modifying the License.

You may add Your own copyright statement to Your modifications and may provide additional or different license terms and conditions for use, reproduction, or distribution of Your modifications, or for any such Derivative Works as a whole, provided Your use, reproduction, and distribution of the Work otherwise complies with the conditions stated in this License.

# Open Source Software Information

---

5. **Submission of Contributions.** Unless You explicitly state otherwise, any Contribution intentionally submitted for inclusion in the Work by You to the Licensor shall be under the terms and conditions of this License, without any additional terms or conditions. Notwithstanding the above, nothing herein shall supersede or modify the terms of any separate license agreement you may have executed with Licensor regarding such Contributions.
6. **Trademarks.** This License does not grant permission to use the trade names, trademarks, service marks, or product names of the Licensor, except as required for reasonable and customary use in describing the origin of the Work and reproducing the content of the NOTICE file.
7. **Disclaimer of Warranty.** Unless required by applicable law or agreed to in writing, Licensor provides the Work (and each Contributor provides its Contributions) on an "AS IS" BASIS, WITHOUT WARRANTIES OR CONDITIONS OF ANY KIND, either express or implied, including, without limitation, any warranties or conditions of TITLE, NON-INFRINGEMENT, MERCHANTABILITY, or FITNESS FOR A PARTICULAR PURPOSE. You are solely responsible for determining the appropriateness of using or redistributing the Work and assume any risks associated with Your exercise of permissions under this License.
8. **Limitation of Liability.** In no event and under no legal theory, whether in tort (including negligence), contract, or otherwise, unless required by applicable law (such as deliberate and grossly negligent acts) or agreed to in writing, shall any Contributor be liable to You for damages, including any direct, indirect, special, incidental, or consequential damages of any character arising as a result of this License or out of the use or inability to use the Work (including but not limited to damages for loss of goodwill, work stoppage, computer failure or malfunction, or any and all other commercial damages or losses), even if such Contributor has been advised of the possibility of such damages.
9. **Accepting Warranty or Additional Liability.** While redistributing the Work or Derivative Works thereof, You may choose to offer, and charge a fee for, acceptance of support, warranty, indemnity, or other liability obligations and/or rights consistent with this License. However, in accepting such obligations, You may act only on Your own behalf and on Your sole responsibility, not on behalf of any other Contributor, and only if You agree to indemnify, defend, and hold each Contributor harmless for any liability incurred by, or claims asserted against, such Contributor by reason of your accepting any such warranty or additional liability.

END OF TERMS AND CONDITIONS

APPENDIX: How to apply the Apache License to your work.

To apply the Apache License to your work, attach the following boilerplate notice, with the fields enclosed by brackets “[ ]” replaced with your own identifying information. (Don't include the brackets!) The text should be enclosed in the appropriate comment syntax for the file format. We also recommend that a file or class name and description of purpose be included on the same “printed page” as the copyright notice for easier identification within third-party archives.

Copyright [yyyy] [name of copyright owner]

Licensed under the Apache License, Version 2.0 (the “License”);  
you may not use this file except in compliance with the License.  
You may obtain a copy of the License at

<http://www.apache.org/licenses/LICENSE-2.0>

Unless required by applicable law or agreed to in writing, software distributed under the License is distributed on an “AS IS” BASIS, WITHOUT WARRANTIES OR CONDITIONS OF ANY KIND, either express or implied. See the License for the specific language governing permissions and limitations under the License.

# Open Source Software Information

---

## Active Driving Display

This product includes free/open sources. Information about the licensing and source code is available at the following URL.

[https://www.nippon-seiki.co.jp/business\\_ic\\_meter/](https://www.nippon-seiki.co.jp/business_ic_meter/)

## Driver Monitoring Camera

### Free/Open Source Software Information

This product includes free/open source software. Information about licenses and source codes can be found at the following website.

[http://www.embedded-carmultimedia.jp/RTOS/License/oss/DMS\\_0201/](http://www.embedded-carmultimedia.jp/RTOS/License/oss/DMS_0201/)

## Cruising & Traffic Support (CTS)

### **Free/Open Source Software Information**

This product includes software created from free/open sources. Information about free/open source licenses can be found at the following website.  
<http://acado.github.io/licensing>

# 3

## Equipment to Protect Occupants/ Pedestrians

<b>SRS Air Bags</b> .....	<b>3-4</b>
SRS Air Bags.....	3-4
Warnings and Cautions for Using the SRS Air Bags.....	3-7
Deployment of SRS air bags.....	3-12
Driver and Front Passenger Occupant Classification System* .....	3-18
Warnings and Cautions for Using the Front Passenger Occupant Classification System.....	3-19
How to Use the Front Passenger Occupant Classification System.....	3-21
<b>Seat Belts</b> .....	<b>3-23</b>
Seat Belts.....	3-23
Warnings and Cautions for Using the Seat Belts.....	3-25
How to Use the Seat Belts....	3-27
Seat Belt Extender.....	3-29
Warnings and Cautions for Using the Seat Belt Extender.....	3-29
<b>Front Seats</b> .....	<b>3-31</b>
Warnings and Cautions for Using the Front Seats.....	3-31
How to Use the Front Seats.....	3-33
Driving Position Memory* .....	3-35
Warnings and Cautions for Using the Driving Position Memory.....	3-35

How to Use the Driving Position Memory.....	3-36
--	------

<b>Rear Seats</b> .....	<b>3-38</b>
Warnings and Cautions for Using the Rear Seats.....	3-38
How to Use the Rear Seats.....	3-39
Warnings and Cautions for Using the Armrests.....	3-40
How to Use the Armrests.....	3-41

<b>Head Restraints</b> .....	<b>3-42</b>
Head Restraints.....	3-42
Warnings and Cautions for Using the Head Restraints.....	3-42
How to Use the Head Restraints.....	3-43

<b>Steering Wheel</b> .....	<b>3-45</b>
Warnings and Cautions for Using the Steering Wheel.....	3-45
How to Use the Steering Wheel.....	3-45

<b>Child-restraint Systems</b> .....	<b>3-46</b>
Child-restraint Systems.....	3-46
Warnings and Cautions For Child- restraint Systems.....	3-47
Types of Child-restraint Systems.....	3-50
Child-Restraint System Suitability for Various Seat Positions Table.....	3-52



---

Installing Child-Restraint Systems.....	3-55
Anchor Bracket Overview.....	3-55
Warnings and Cautions for Using the Anchor Bracket.....	3-56
How to Use the Automatic Locking Mode (Except Mexico).....	3-57
If You Must Use the Front Seat for Children.....	3-58
Warnings and Cautions for Using the Front Seat for Children .....	3-59
How to Install a Child-Restraint System on the Front Passenger's Seat (With Front Passenger Occupant Classification System).....	3-61

Using the ISOFIX Lower Anchor (Mexico)/LATCH Lower Anchor (Except Mexico).....	3-63
Warnings and Cautions for Using the ISOFIX Lower Anchor (Mexico)/LATCH Lower Anchor (Except Mexico).....	3-63
How to Use the ISOFIX Lower Anchor (Mexico)/LATCH Lower Anchor (Except Mexico).....	3-64

# MEMO

## SRS Air Bags

### SRS Air Bags

If the vehicle receives a strong impact from the front or side of the vehicle when the vehicle power is switched ON, the air bags inflate instantaneously and lessen the impact on the head or chest of the driver or passenger.

The SRS air bag system protects occupants together with the seat belts and they are not a substitute for the seat belts.

There are 5 types of air bags. Vehicles with the Driver and Front Passenger Occupant Classification System have a sensor which detects an impending roll-over accident.

The air bag supplemental restraint systems are designed to provide supplemental protection in certain situations so seat belts are always important in the following ways:

Without seat belt usage, the air bags cannot provide adequate protection during an accident. Seat belt usage is necessary to:

- Keep the occupant from being thrown into an inflating air bag.
- Reduce the possibility of injuries during an accident that is not designed for air bag inflation, such as roll-over or rear impact.
- Reduce the possibility of injuries in frontal, near frontal or side collisions or roll-over accidents that are not severe enough to activate the air bags.
- Reduce the possibility of being thrown from your vehicle.
- Reduce the possibility of injuries to lower body and legs during an accident because the air bags provide no protection to these parts of the body.

### Driver's front air bag

The driver's front air bag is stored in the center of the steering wheel. When air bag crash sensors detect a frontal impact of greater than moderate force, the driver's air bag inflates quickly helping to reduce injury mainly to the driver's head or chest caused by directly hitting the steering wheel.

#### **(With Driver and Front Passenger Occupant Classification System)**

The inflation of the driver's dual-stage air bag is controlled in two energy stages depending on the driver's seat position. The driver's seat slide position sensor is located under the driver's seat. The sensor determines whether the driver's seat is forward of or behind a reference position and sends the seat position to the diagnostic module (SAS unit). The SAS unit is designed to control the deployment of the driver's air bag depending on how close the driver's seat is to the steering wheel.

During an impact of moderate severity, the driver's air bag deploys with lesser energy, whereas during more severe impacts and when the driver's seat is behind the reference position, it deploys with more energy.



### Front passenger's front air bag

The front passenger's front air bag is stored in the dashboard. The inflation mechanism for the front passenger air bag is the same as the driver's air bag.

#### **(With Driver and Front Passenger Occupant Classification System)**

In addition, the front passenger air bag is designed to only deploy in accordance with the total seated weight on the front passenger seat.



### Driver and Front Passenger Knee Air Bags\*

The knee air bag is stored under the dashboard. If the air bag crash sensors receive a frontal impact of greater than moderate force, the knee air bags deploy immediately to reduce impact to the driver and front passenger's legs.



### Side air bags

There are 2 types of side air bags including the side air bags for the driver and front passenger and rear passengers.

#### **Front seat side air bags**

The front seat side air bags are installed in the outboard sides of the driver and front passenger's seatbacks.

When the air bag crash sensors detect a side impact of greater than moderate force, the system inflates the side air bag only on the side in which the vehicle was hit. The side air bag inflates quickly to reduce injury to the driver or front passenger's chest caused by directly hitting interior parts such as a door or window.

#### **(With Driver and Front Passenger Occupant Classification System)**

In addition, the front passenger side air bag is designed to only deploy in accordance with the total seated weight on the front passenger seat.



\*Some models.

## SRS Air Bags

### Rear seat side air bags\*

The rear seat side air bags are installed in outboard sides of the rear seatbacks. The rear seat side air bags on the side where the vehicle is hit deploy regardless of whether or not an occupant is seated.

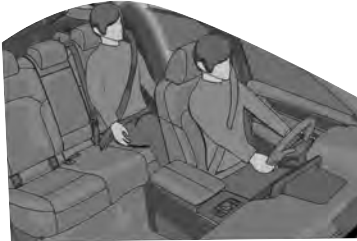

### Curtain air bags

The curtain air bags are stored in the front pillars, side edges of the roof, and the rear pillars. The curtain air bag on the side where the vehicle is hit deploys regardless of whether or not an occupant is seated.

When the air bag crash sensors detect a side impact of greater than moderate force, the curtain air bag inflates quickly and helps to reduce injury mainly to the driver and front and rear outboard passengers' heads caused by directly hitting interior parts such as a door or window.

#### In a side impact:

Greater than moderate impact to one side of the vehicle will cause the curtain air bag on that side only to inflate.



### (With roll-over sensor)

#### In a roll-over:

In response to a vehicle roll-over, both curtain air bags inflate.

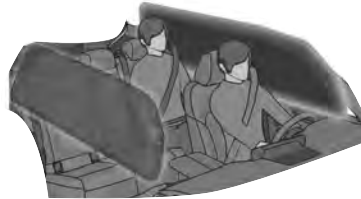

Both curtain air bags will deploy after the roll-over accident is detected.

### Constant Monitoring

The following components of the air bag systems are monitored by a diagnostic system:

- Front air bag sensors
- Crash sensors, and diagnostic module (SAS unit)
- Side crash sensors
- Air bag modules
- Seat belt pretensioners
- Air bag/Seat belt pretensioner system warning light
- Related wiring

### (With Driver and Front Passenger Occupant Classification System)

- Driver seat slide position sensor
- Front passenger occupant classification sensor
- Front passenger occupant classification module
- Front passenger air bag deactivation indicator light
- Front passenger seat belt buckle switch

The diagnostic module continuously monitors the system's readiness. This begins when the vehicle power is

switched ON and continues while the vehicle is being driven.

## Warnings and Cautions for Using the SRS Air Bags

### **WARNING**

#### **Seat belts must be worn in air bag equipped vehicles.**

Depending only on the air bags for protection during an accident is dangerous. Alone, air bags may not prevent serious injuries. The appropriate air bags can be expected to inflate only in the first accident, such as frontal, near frontal or side collisions or roll-over accidents that are at least moderate. Vehicle occupants should always wear seat belts.

#### **Children should not ride in the front passenger seat.**

Placing a child, 12 years or under, in the front seat is dangerous. The child could be hit by a deploying air bag and be seriously injured or even killed. A sleeping child is more likely to lean against the door and be hit by the side air bag in moderate collision to the front-passenger side of the vehicle. Whenever possible, always secure a child 12 years or under on the rear seats with an appropriate child-restraint system for the child's age and size.

## SRS Air Bags

---

### **Never use a rear-facing child-restraint system in the front seat with an air bag that could deploy.**

Rear-facing child-restraint systems on the front seat are particularly dangerous even though you may feel assured that a front passenger air bag will not deploy based on the fact that the front passenger air bag deactivation indicator light illuminates. The child-restraint system can be hit by a deploying air bag and moved violently backward resulting in serious injury or death to the child.



### **Do not sit too close to the driver and front passenger air bags.**

Sitting too close to the driver and front passenger air bag modules or placing hands or feet on them is extremely dangerous. The driver and front passenger air bags inflate with great force and speed. Serious injuries could occur if someone is too close. The driver should always hold onto only the rim of the steering wheel. The front seat passenger should keep both feet on the floor. Front seat occupants should adjust their seats as far back as possible and always sit upright against the seatbacks with seat belts worn properly.

### **Sit in the center of the seat and wear seat belts properly.**

Sitting too close to the side air bag modules or placing hands on them, or sleeping up against the door or hanging out the windows is extremely dangerous. The side and curtain air bags inflate with great force and speed directly expanding along the door on the side the car is hit. Serious injury could occur if someone is sitting too close to the door or leaning against a window, or if rear seat occupants grab the sides of the front seatbacks. Give the side and curtain air bags room to work by sitting in the center of the seat while the vehicle is moving with seat belts worn properly.

### **Do not attach objects on or around the area where air bags deploy.**

Attaching objects to the air bags or placing something in the area where the air bags deploy is dangerous. In an accident, an object could interfere with air bag inflation and injure the occupants. Furthermore, the bag could be damaged causing gases to release. Always keep the deployment area of the air bag modules free of any obstructions.

For example, you should not do any of the following as it may interfere with air bag deployment.

- Do not put a covering on or lean anything against areas such as the dashboard and lower portion of the instrument panel that blocks the passenger front air bag and knee air bags.
- Do not use seat covers on the front seats and rear seats equipped with in-seat side air bags.
- Do not hang any backpacks, bags or pouches that cover the sides of the seats that block the side air bags.

- Do not place any objects on the assist grips. Only hang clothes directly on the coat hooks.

**Do not touch the components of the supplemental restraint system after the air bags have inflated.**

Touching the components of the supplemental restraint system after the air bags have inflated is dangerous. Immediately after inflation, they are very hot. You could get burned.

**Never install any front-end equipment to your vehicle.**

Installation of front-end equipment, such as frontal protection bar (kangaroo bar, bull bar, push bar, or other similar devices), snowplow, or winches, is dangerous. The air bag crash sensor system could be affected. This could cause air bags to inflate unexpectedly, or it could prevent the air bags from inflating during an accident. Front occupants could be seriously injured.

**Do not modify the suspension.**

Modifying the vehicle suspension is dangerous. If the vehicle's height or the suspension is modified, the vehicle will be unable to accurately detect a collision or roll-over accident resulting in incorrect or unexpected air bag deployment and the possibility of serious injuries.

**To prevent false detection by the air bag sensor system, heed the following.**

- Do not use tires or wheels other than those specified for your Mazda:

Use of any tire or wheel other than those specified for your Mazda (page 10-69) is dangerous. Use of such wheels will prevent the vehicle's accident detections system from accurately detecting a collision or roll-over accident resulting in incorrect or unexpected air bag deployment and the possibility of serious injuries.

- Do not overload your vehicle: Overloading your vehicle is dangerous as it could prevent the air bag crash sensor system from accurately detecting a collision or roll-over accident resulting in incorrect or unexpected air bag deployment and the possibility of serious injuries. The gross axle weight rating (GAWR) and the gross vehicle weight rating (GVWR) for your vehicle are on the Motor Vehicle Safety Standard Label on the driver's door frame. Do not exceed these ratings.
- Do not drive the vehicle off-road. Driving your Mazda off-road is dangerous because the vehicle has not been designed to do so. Driving the vehicle off-road could prevent the air bag crash sensor system from accurately detecting a collision or roll-over accident resulting in incorrect or unexpected air bag deployment and the possibility of serious injuries.



## SRS Air Bags

---

**Do not modify a front door or leave any damage unrepaired. Always have an Authorized Mazda Dealer inspect a damaged front door.**

Modifying a front door or leaving any damage unrepaired is dangerous. Each front door has a side crash sensor as a component of the supplemental restraint system. If holes are drilled in a front door, a door speaker is left removed, or a damaged door is left unrepaired, the sensor could be adversely affected causing it to not detect the pressure of an impact correctly during a side collision. If a sensor does not detect a side impact correctly, the side and curtain air bags and the front seat belt pretensioner may not operate normally which could result in serious injury to occupants.

**Do not modify the supplemental restraint system.**

Modifying the components or wiring of the supplemental restraint system is dangerous. You could accidentally activate it or make it inoperable. Do not make any modifications to the supplemental restraint system. This includes installing trim, badges, or anything else over the air bag modules. It also includes installing extra electrical equipment on or near system components or wiring. An Authorized Mazda Dealer can provide the special care needed in the removal and installation of front seats and rear seats equipped with in-seat side air bags. It is important to protect the air bag wiring and connections to assure that the bags do not accidentally deploy, and that the front passenger occupant classification system and the seats retain an undamaged air bag connection.

**Do not place luggage or other objects under the front seats and rear seats.**

Placing luggage or other objects under the front or rear seats equipped with in-seat side air bags is dangerous. The components essential to the supplemental restraint system could be damaged, and in the event of a side collision, the appropriate air bags may not deploy, which could result in death or serious injury. To prevent damage to the components essential to the supplemental restraint system, do not place luggage or other objects under the front seats.

**Do not operate a vehicle with damaged air bag/seat belt pretensioner system components.**

Expendable or damaged air bag/seat belt pretensioner system components must be replaced after any collision which caused them to deploy or damage them. Only a trained Authorized Mazda Dealer can fully evaluate these systems to see that they will work in any subsequent accident. Driving with an expended or damaged air bag or pretensioner unit will not afford you the necessary protection in the event of any subsequent accident which could result in serious injury or death.

**Do not remove interior air bag parts.**

Removing any components such as the front seats, front dashboard, the steering wheel or parts on the front and rear window pillars and along the roof edge, containing air bag parts or sensors is dangerous. These parts contain essential air bag components. The air bag could accidentally activate and cause serious injuries. Always have an Authorized Mazda Dealer remove these parts.

**Properly dispose of the air bag system.**

Improper disposal of an air bag or a vehicle with live air bags in it can be extremely dangerous. Unless all safety procedures are followed, injury could result. Have an Authorized Mazda Dealer safely dispose of the air bag system or scrap an air bag equipped vehicle.

# SRS Air Bags

## Deployment of SRS air bags

### Deployment of SRS air bags

The driver's and front passenger's front air bags, and the driver's and front passenger's knee air bag\* deploy when a strong impact is applied to the vehicle in a frontal collision, and the side and curtain air bags deploy in side collisions. The air bags do not always deploy even if the vehicle receives an impact.

### Conditions in which air bags may not deploy

The air bags may not deploy under the following conditions depending on the level of the impact.

**Driver's and front passenger's air bags, driver's and front passenger's knee air bag\***  
(Impacts involving trees or poles)

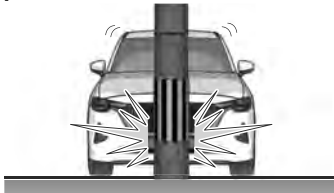

(Rear-ending or running under a truck's tail gate)



(Frontal offset impact to the vehicle)



**Side and curtain air bags**

(Frontal offset impact to the vehicle)

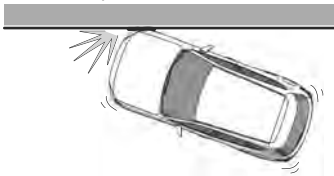

(Pitch end over end)

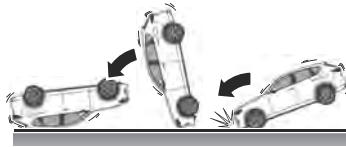

(Side impacts involving trees or poles from the vehicle side (around driver or front passenger))



(Side impacts with two-wheeled vehicles)

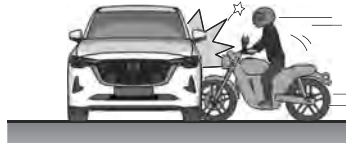

**Conditions in which air bags do not deploy**

The air bags do not deploy under the following conditions.

**Driver's and front passenger's air bags, driver's and front passenger's knee air bag\***

(Rear impact)



(Roll-over)

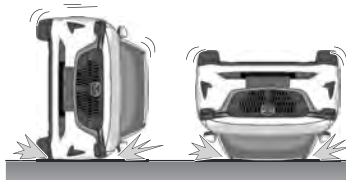

(Pitch end over end)

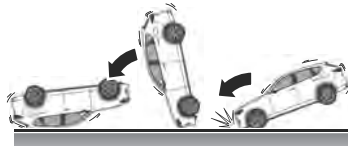

(Lateral direction side impact)

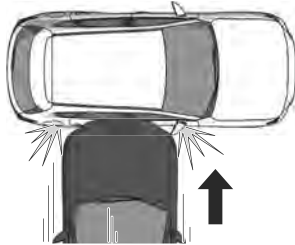

Side air bags

(Roll-over)

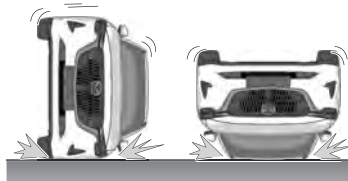

Curtain air bags

(Roll-over (Without roll-over sensor))

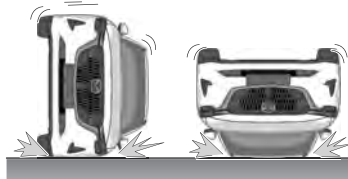

Side and curtain air bags

(Rear impact)



**(Frontal impact)**

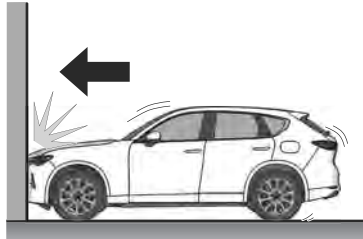

**NOTE**

- If it becomes necessary to have the components or wiring system for the supplementary restraint system modified to accommodate a person with certain medical conditions in accordance with a certified physician, contact an Authorized Mazda Dealer, refer to “Customer Assistance (U.S.A.)” (page 10-4).
- When an air bag deploys, a loud inflation noise can be heard and some smoke will be released. Neither is likely to cause injury, however, the texture of the air bags may cause light skin injuries on body parts not covered with clothing through friction.
- Should you sell your Mazda, we urge you to tell the new owner of its air bag systems and that familiarization with all instructions about them, from the Owner's Manual, is important.
- This highly-visible label is displayed which warns against the use of a rear-facing child-restraint system on the front passenger seat.

**(Mexico)**



**(Except Mexico)**



# SRS Air Bags

## Air bag structural view

(With Driver and Front Passenger Occupant Classification System)

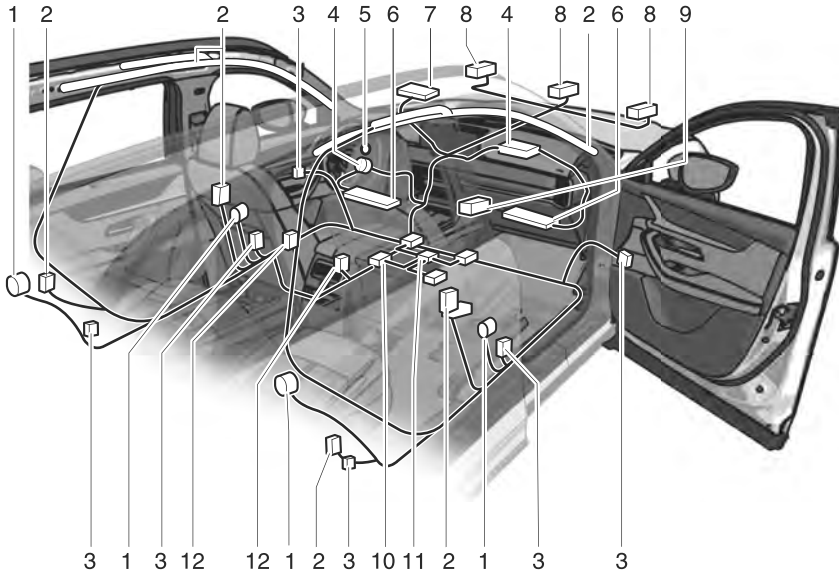

1. Seat belt pretensioners
2. Side and curtain inflators and air bags
3. Side crash sensors
4. Driver/Front passenger inflators and air bags
5. Air bag/seat belt pretensioner system warning indication/warning light
6. Driver/Front passenger knee inflators and air bags
7. Front passenger air bag deactivation indicator light
8. Front air bag sensors
9. Roll-over sensor, crash sensors, and diagnostic module (SAS unit)
10. Front passenger seat weight sensors
11. Front passenger seat weight sensor control module
12. Seat belt buckle switches

(Without Driver and Front Passenger Occupant Classification System)

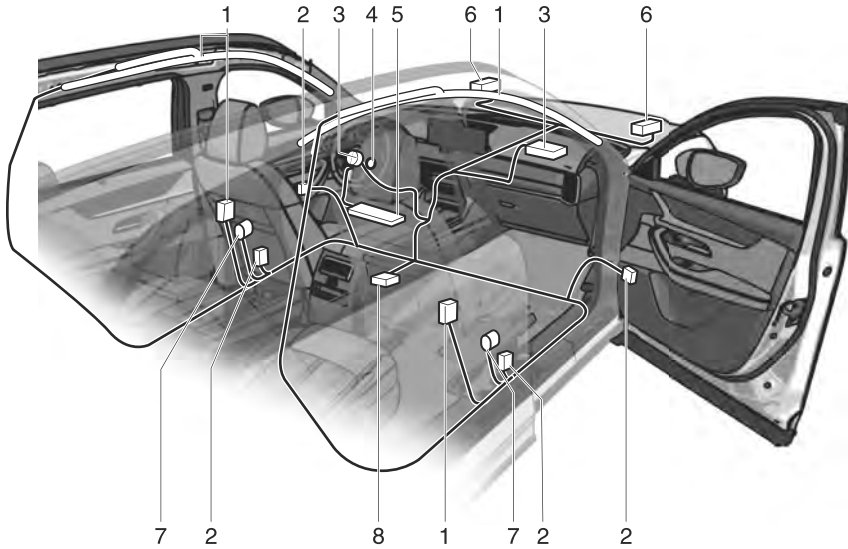

1. Side and curtain inflators and air bags
2. Side crash sensors
3. Driver/Front passenger inflators and air bags
4. Air bag/front seat belt pretensioner system warning indication/warning light
5. Driver knee inflator and air bag
6. Front air bag sensor
7. Seat belt pretensioners
8. Crash sensors and diagnostic module (SAS unit)



## SRS Air Bags

---

### Driver and Front Passenger Occupant Classification System\*

The Driver and Front Passenger Occupant Classification System reduces the possibility of injury due to the deployment of the driver air bag and the front passenger airbag by determining the deployment energy of the driver air bag and whether or not the front passenger airbag should be deployed based on the driver seat slide position sensor and the front passenger seat weight sensor.

#### Driver Seat Slide Position Sensor

Your vehicle is equipped with driver seat slide position sensor as a part of the supplemental restraint system. The sensor is located under the driver seat. The sensor determines whether the driver's seat is forward of or behind a reference position and sends the seat position to the diagnostic module (SAS unit). The SAS unit is designed to control the deployment of the driver's air bag depending on how close the driver's seat is to the steering wheel. During an impact of moderate severity, the driver's air bag deploys with lesser energy, whereas during more severe impacts and when the driver's seat is behind the reference position, it deploys with more energy.

#### Front Passenger Seat Weight Sensor

Your vehicle is equipped with a front passenger seat weight sensors as a part of the supplemental restraint system. These sensors are located under both of the front passenger seat rails. These sensors determine the total seated weight on the front passenger seat and monitor the seat belt buckle for the

front passenger seat. The SAS unit is designed to prevent the front passenger front and side air bags and knee air bags, and seat belt pretensioner system from deploying if the front passenger air bag deactivation indicator light illuminates. To reduce the chance of injuries caused by deployment of the front passenger air bag, the system deactivates the front passenger front and side air bags and knee air bags, and also the seat belt pretensioner system when the front passenger air bag deactivation indicator light illuminates.

## Warnings and Cautions for Using the Front Passenger Occupant Classification System

### **WARNING**

**Do not decrease the total seated weight on the front passenger seat.** When an adult or large child sits on the front passenger seat, decreasing the total seated weight on the front passenger seat required for air bag deployment is dangerous. The front passenger seat weight sensors will detect the reduced total seated weight condition and the front passenger front and side air bags and knee air bags, and the seat belt pretensioner system will not deploy during an accident. The front passenger will not have the supplementary protection of the air bag, which could result in serious injury. Decreasing the total seated weight on the front passenger seat could result in an air bag not deploying under the following conditions, for example.

- A front passenger is seated as shown in the following figure.



- A rear passenger pushes up on the front passenger seat with their feet.
- Luggage or other items placed under the front passenger seat or between the front passenger seat and driver seat that push up the front passenger seat bottom.

## SRS Air Bags

---

- Any accessories which might decrease the total seated weight on the front passenger seat are attached to the front passenger seat.

The front passenger front and side air bags and knee air bags, and the seat belt pretensioner system will deactivate if the front passenger air bag deactivation indicator light illuminates.

### **Do not increase the total seated weight on the front passenger seat.**

When an infant or small child sits on the front passenger seat, increasing the total seated weight on the front passenger seat is dangerous. The front passenger seat weight sensors will detect the increased total seated weight, which could result in the unexpected deployment of the front passenger front and side air bags and knee air bags, and seat belt pretensioner system in an accident and may cause serious injury. Increasing the total seated weight on the front passenger seat could result in the front passenger front and side air bags and knee air bags, and seat belt pretensioner system deployment in an accident under the following conditions, for example.

- Luggage or other items are placed on the seat with the child in the child-restraint system.
- A rear passenger or luggage push or pull down on the front passenger seatback.
- A rear passenger steps on the front passenger seat rails with their feet.
- Luggage or other items are placed on the seatback or hung on the head restraint.

- Heavy items are placed in the seatback map pocket.
- The seat is washed.
- Liquids are spilled on the seat.
- The front passenger seat is moved backward, pushing into luggage or other items placed behind it.
- The front passenger seatback contacts the rear seat.
- Luggage or other items are placed between the front passenger seat and driver seat.
- Any accessories which might increase the total seated weight on the front passenger seat are attached to the front passenger seat.

### **CAUTION**

- To assure proper deployment of the front air bag and to prevent damage to the sensors in the front seat bottoms.
  - Do not place sharp objects on the front seat bottoms or leave heavy luggage on them.
  - Do not spill any liquids on the front seats or under the front seats.
- To allow the sensors to function properly, always perform the following.
  - Adjust the front seats as far back as possible and always sit upright against the seatbacks with seat belts worn properly.
  - If you place your child on the front passenger seat, secure the child-restraint system properly and slide the front passenger seat as far back as possible (page 3-33).

## How to Use the Front Passenger Occupant Classification System

This system shuts off the front passenger front and side air bags and knee air bags, and seat belt pretensioner system, so make sure the front passenger air bag deactivation indicator light illuminates according to the following table.

The air bag/seat belt pretensioner system warning light turns on/flashes and the front passenger air bag deactivation indicator light illuminates if the sensors have a possible malfunction. If this happens, the front passenger front and side air bags and knee air bags, and seat belt pretensioner system will not deploy.

### Front passenger air bag deactivation indicator light

This indicator light illuminates to remind you that the front passenger front and side air bags and knee air bags, and seat belt pretensioners will not deploy during a collision.



If the front passenger weight sensors are normal, the indicator light illuminates when the vehicle power is switched ON. The light turns off after a few seconds. Then, the indicator light illuminates or is off under the following conditions:

### Front passenger air bag deactivation indicator light on/off condition chart

Condition detected by the front passenger occupant classification system	Front passenger air bag deactivation indicator light	Front passenger front and side and knee air bags	Front passenger seat belt pretensioner system
Empty (Not occupied)	On	Deactivated	Deactivated
Child or child-restraint system* <sup>1</sup>	On	Deactivated	Deactivated
Adult* <sup>2</sup>	Off	Ready	Ready

\*<sup>1</sup> If a larger child sits on the front passenger seat, the sensors might detect the child as being an adult depending on the child's physique.

\*<sup>2</sup> If a smaller adult sits on the front passenger seat, the sensors might detect the person as being a child depending on the person's physique.

The curtain air bag is ready for inflating regardless of what the front passenger air bag deactivation indicator light on/off condition chart indicates.

If the front passenger air bag deactivation indicator light does not illuminate when the vehicle power is switched ON and does not illuminate as indicated in the front passenger air bag deactivation indicator light on/off condition chart, do not allow a child to sit in the front passenger seat and consult an Authorized Mazda Dealer as soon as possible. The system may not work properly in an accident.

## SRS Air Bags

---

### NOTE

- The system requires about 10 seconds to alternate between turning the front passenger front and side air bags and knee air bags, and seat belt pretensioner system on or off.
  - The front passenger air bag deactivation indicator light may illuminate repeatedly if luggage or other items are put on the front passenger seat, or if the temperature of the vehicle's interior changes suddenly.
  - The front passenger air bag deactivation indicator light may illuminate for 10 seconds if the total seated weight on the front passenger seat changes.
  - The air bag/seat belt pretensioner system warning light might illuminate if the front passenger seat receives a severe impact.
  - If the front passenger air bag deactivation indicator light does not illuminate after installing a child-restraint system on the front passenger seat, first, re-install your child-restraint system according to the procedure in this owner's manual. Then, if the front passenger air bag deactivation indicator light still does not illuminate, install the child-restraint system on the rear seat and consult an Authorized Mazda Dealer as soon as possible.
- If the front passenger air bag deactivation indicator light illuminates when an adult is seated in the front passenger seat, have the passenger re-adjust their posture by sitting with their feet on the floor, and then re-fastening the seat belt. If the front passenger air bag deactivation indicator light still illuminates, move the passenger to the rear seat. If sitting in the rear seat is not possible, slide the front passenger seat as far back as possible. Consult an Authorized Mazda Dealer as soon as possible.

## Seat Belts

Seat belts help to decrease the possibility of severe injury during accidents and sudden stops. Mazda recommends that the driver and all passengers always wear seat belts.

### **(Mexico)**

All the seats have lap/shoulder belts. These belts have retractors with inertia locks that keep them out of the way when not in use. The locks allow the belts to remain comfortable on users, but they will lock in position during a collision.

### **(Except Mexico)**

All of the seat belt retractors are designed to keep the lap/shoulder belts out of the way when not in use. The driver's seat belt has no provisions for child-restraint systems and has only an emergency locking mode. The driver may wear it comfortably, and it will lock during a collision. However, the front passenger's seat and all rear lap/shoulder belt retractors operate in two modes: emergency locking mode, and for child-restraint systems, automatic locking mode. While we recommend you put all children in the rear seats, if you must use the front passenger seat for a child, slide the front passenger seat as far back as possible and make sure any child-restraint system is secured properly.

### **Emergency locking mode**

When the seat belt is fastened, it will always be in the emergency locking mode.

In the emergency locking mode, the belt remains comfortable on the occupant and the retractor will lock in position during a collision.

If the belt is locked and cannot be pulled out, retract the belt once, and then try pulling it out slowly. If this fails, pull the belt strongly 1 time and loosen, then pull it out again slowly.

### **(Seat belt with automatic lock mode)**

When the seat belt is fastened, it will always be in the emergency locking mode until it is switched to automatic locking mode by pulling it all the way out to its full length. If the belt feels tight and hinders comfortable movement while the vehicle is stopped or in motion, it may be in the automatic locking mode because the belt has been pulled too far out. To return the belt to the more comfortable emergency locking mode, wait until the vehicle has stopped in a safe, level area, retract the belt fully to convert it back to emergency locking mode and then extend it around you again.

### **Automatic locking mode (Except Mexico)**

Always use the automatic locking mode to keep the child-restraint system from shifting to an unsafe position in the event of an accident. To enable seat belt automatic locking mode, pull it all the way out and connect it as instructed on the child-restraint system. It will retract down to the child-restraint system and stay locked on it. See the section on child restraint (page 3-57).

### **Pretensioner system**

If the vehicle receives a strong impact from the front or side of the vehicle, the system retracts the seat belts to increase their effect.

When a collision is detected, the pretensioners deploy simultaneously with the air bags.

## Seat Belts

---

The pretensioners deploy simultaneously with the air bags when a roll-over is also detected.

The seat belt retractors remove slack quickly as the air bags are expanding. Any time the air bags and seat belt pretensioners have fired they must be replaced.

A system malfunction or operation conditions are indicated by a warning. Refer to Air Bag/Seat Belt Pretensioner System Warning Light on page 8-45.

### **(With Driver and Front Passenger Occupant Classification System)**

In addition, the pretensioner system for the front passenger, like the front and side passenger air bag, is designed to only deploy in accordance with the total seated weight on the front passenger seat.

For details, refer to the front passenger seat weight sensors (page 3-18).

### **Load limiting system**

If the vehicle receives a strong impact from the front of the vehicle, the load limiting system operates to prevent the seat belts from applying an excessive load. By maintaining the load applied to the seat belt to a specified level, the system reduces impact to an occupant's chest.

Even if the pretensioners have not fired, the load limiting function must be checked by an Authorized Mazda Dealer.

### **NOTE**

- The pretensioner system operates if the vehicle receives a strong impact from the vehicle front or side direction. The system may not operate if the impact is weak.

- Some smoke might be released when the pretensioner system operates, but this does not mean there is a fire. This gas normally has no effect on occupants. However, those with sensitive skin may experience light skin irritation. If residue from the operation of the pretensioner system gets on the skin or in the eyes, wash it off as soon as possible.

## Warnings and Cautions for Using the Seat Belts

### **WARNING**

**Always wear your seat belt and make sure all occupants are properly restrained.**

Not wearing a seat belt is extremely dangerous. During a collision, occupants not wearing seat belts could hit someone or things inside the vehicle or even be thrown out of the vehicle. They could be seriously injured or even killed. In the same collision, occupants wearing seat belts would be much safer.

In a rollover crash, an unbelted person is significantly more likely to die than a person wearing a seat belt.

**Do not wear twisted seat belts.**

Twisted seat belts are dangerous. In a collision, the full width of the belt is not available to absorb the impact. This puts more force on the bones beneath the belt, which could cause serious injury or death. So, if your seat belt is twisted, you must straighten the seat belt to remove any twists and to allow the full width of the belt to be used.

**Never use one seat belt on more than one person at a time.**

Using one seat belt for more than one person at a time is dangerous. A seat belt used in this way cannot spread the impact forces properly and the two passengers could be crushed together and seriously injured or even killed. Never use one belt for more than one person at a time and always operate the vehicle with each occupant properly restrained.

**Do not operate a vehicle with a damaged seat belt.**

Using a damaged seat belt is dangerous. An accident could damage the belt webbing of the seat belt in use. A damaged seat belt cannot provide adequate protection in a collision. Have an Authorized Mazda Dealer inspect all seat belt systems in use during an accident before they are used again.

**Have your seat belts changed immediately if the pretensioner or load limiter has been expended.**

Always have an Authorized Mazda Dealer immediately inspect the seat belt pretensioners and air bags after any collision. Like the air bags, the seat belt pretensioners and load limiters will only function once and must be replaced after any collision that caused them to deploy. A seat belt with an expended pretensioner or load limiter is still better than wearing no seat belt at all; however, if the seat belt pretensioners and load limiters are not replaced, the risk of injury in a collision will increase.



## Seat Belts

---

### **Positioning the Shoulder Portion of the Seat Belt.**

Improper positioning of the shoulder portion of the seat belt is dangerous. Always make sure the shoulder portion of the seat belt is positioned across your shoulder and near your neck, but never under your arm, on your neck, or on your upper arm.

### **Positioning the Lap Portion of the Seat Belt.**

The lap portion of the seat belt worn too high is dangerous. In a collision, this would concentrate the impact force directly on the abdominal area, causing serious injury. Wear the lap portion of the belt snugly and as low as possible.

### **Pregnant women and persons with a medical condition should always wear seat belts.**

However, ask your doctor about precautions in using a seat belt because a strong impact might be applied locally during sudden braking or a collision. The lap portion of the belt should fit the pelvis as low as possible avoiding abdominal area. In addition, the shoulder portion should be positioned on the shoulder and fitted to the chest avoiding the abdominal area.



### **Wear seat belts only as recommended in this owner's manual.**

Incorrect positioning of the seat belts is dangerous. Without proper positioning, the pretensioner and load limiting systems cannot provide adequate protection in an accident and this could result in serious injury. For more details about wearing seat belts, refer to "How to Use the Seat Belts" (page 3-27).

### **Do not modify the components or wiring, or use electronic testing devices on the pretensioner system.**

Modifying the components or wiring of the pretensioner system, including the use of electronic testing devices is dangerous. You could accidentally activate it or make it inoperable which would prevent it from activating in an accident. The occupants or person making the modification could be seriously injured.

### **Properly dispose of the pretensioner system.**

Improper disposal of the pretensioner system or a vehicle with non-deactivated pretensioners is dangerous. Unless all safety procedures are followed, injury could result. Have an Authorized Mazda Dealer safely dispose of the pretensioner system or scrap a pretensioner system equipped vehicle.

**⚠ CAUTION**

Belt retraction may become difficult if the belts and rings are soiled, so try to keep them clean. For more details about cleaning the seat belts, refer to "Seat Belt Maintenance" (page 9-46).

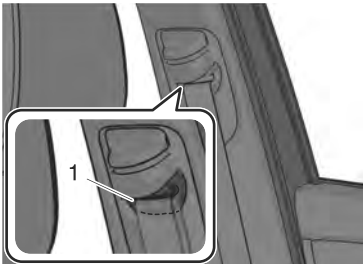

1. Ring

**How to Use the Seat Belts**

**Fastening a Seat Belt**

1. Sit back in the seat with your back upright.
2. Hold the plate and slowly pull out the seat belt.



**NOTE**

If the belt is locked and cannot be pulled out, retract the belt once, and then try pulling it out slowly. If this fails, pull the seat belt strongly one time and loosen it, then pull it out again slowly.

3. Make sure that the belt is not twisted.
4. Insert the plate into the buckle until it clicks.



# Seat Belts

- 5. The belt should fit the pelvis as low as possible.



- 6. The belt should not touch the neck, jaw, or face and it should pass over the shoulder.

### Seat belt indicator light (rear seat) (green)

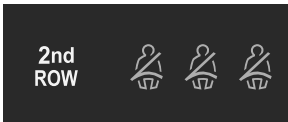

The light turns on when the rear seat belt is fastened while the vehicle power is switched ON, and it turns off after a certain period.

### Unfastening a Seat Belt

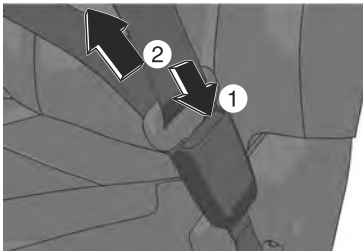

Make sure that the seat belt is not twisted, then let the seat belt retract slowly.

### Adjusting the Seat Belt Height

If the seat belt contacts your neck or it slips off the shoulder, adjust the seat belt height.

#### **To raise the seat belt**

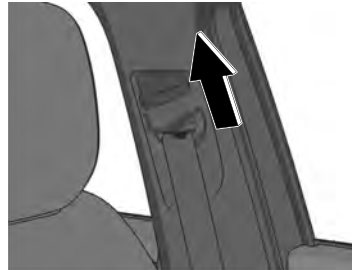

#### **To lower the seat belt**

- 1. Hold the seat belt anchor adjuster and press the knob down.

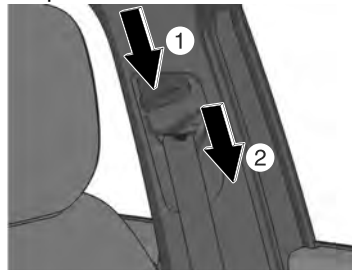

- 2. Make sure that the seat belt anchor adjuster is securely locked.

## Seat Belt Extender

If your seat belt is not long enough, even when fully extended, a seat belt extender may be available to you at no charge from your Authorized Mazda Dealer.

This extender will be only for you and for the particular vehicle and seat. Even if it plugs into other seat belts, it may not hold in the critical moment of a crash.

When ordering an extender, only order one that provides the necessary additional length to fasten the seat belt properly. Please contact your Authorized Mazda Dealer for more information.

### NOTE

When not in use, remove the seat belt extender and store it in the vehicle. If the seat belt extender is left connected, the seat belt extender might get damaged as it will not retract with the rest of the seat belt and can easily fall out of the door when not in use and be damaged. In addition, the seat belt warning light will not illuminate and function properly.

## Warnings and Cautions for Using the Seat Belt Extender

### WARNING

**Do not use a seat belt extender unless it is necessary.**

Using a seat belt extender when not necessary is dangerous. The seat belt will be too long and not fit properly. In an accident, the seat belt will not provide adequate protection and you could be seriously injured. Only use the extender when it is required to fasten the seat belt properly.

**Do not use an improper extender.**

Using a seat belt extender that is for another person or a different vehicle or seat is dangerous. The seat belt will not provide adequate protection and the user could be seriously injured in an accident. Only use the extender provided for you and for the particular vehicle and seat. NEVER use the extender in a different vehicle or seat. If you sell your Mazda, do not leave your seat belt extender in the vehicle. It could be used accidentally by the new owner of the vehicle. After removing the seat belt extender, discard it. Never use the seat belt extender in any other vehicle you may own in the future.

## Seat Belts

---

### **Do not use an extender that is too long.**

Using an extender that is too long is dangerous. The seat belt will not fit properly. In an accident, the seat belt will not provide adequate protection and you could be seriously injured. Do not use the extender or choose one shorter in length if the distance between the extender's buckle and the center of the user's body is less than 15 cm (6 in).

### **Do not leave a seat belt extender connected to the buckle.**

Leaving a seat belt extender connected to the buckle without using the seat belt is dangerous. When the seat belt extender is connected to the driver's seat belt buckle (or front passenger's seat belt buckle), the SRS driver's (or front passenger's) air bag system will determine that the driver (or front passenger) is wearing the seat belt even if the driver (or front passenger) is not wearing it. This condition could cause the driver's (or front passenger's) air bag to not activate correctly and result in death or serious injury in the event of collision. Always wear the seat belt with the seat belt extender.

### **Do not use the seat belt extender when installing a child-restraint system on the front or rear passenger seat.**

Using a seat belt extender to fasten a child-restraint system on any seat is dangerous. Always follow the child-restraint system manufacturer's installation instructions and never use a seat belt extender.

## Warnings and Cautions for Using the Front Seats

### **WARNING**

**Never allow children to adjust a seat.** Allowing children to adjust a seat is dangerous as it could result in serious injury if a child's hands or feet become caught in the seat.

#### **Do not drive with the seatback unlocked.**

All of the seatbacks play an important role in your protection in a vehicle. Leaving the seatback unlocked is dangerous as it can allow passengers to be ejected or thrown around and baggage to strike occupants in a sudden stop or collision, resulting in severe injury. After adjusting the seatback at any time, even when there are no other passengers, rock the seatback to make sure it is locked in place.

#### **Do not modify or replace the front seats.**

Modifying or replacing the front seats such as replacing the upholstery or loosening any bolts is dangerous. The front seats contain air bag components essential to the supplemental restraint system. Such modifications could damage the supplemental restraint system and result in serious injury. Consult an Authorized Mazda Dealer if there is any need to remove or reinstall the front seats.

#### **Adjust a seat only when the vehicle is stopped.**

If the seat is adjusted while the vehicle is being driven, the seating posture may become unstable and the seat could move unexpectedly resulting in injury.

#### **Do not drive with damaged front seats.**

Driving with damaged front seats, such as seat cushions torn or damaged down to the urethane, is dangerous. A collision, even one not strong enough to inflate the air bags, could damage the front seats which contain essential air bag components. If there was a subsequent collision, an air bag may not deploy which could lead to injuries. Always have an Authorized Mazda Dealer inspect the front seats, front seat belt pretensioners and air bags after a collision.

#### **Do not drive with either front seats reclined.**

Sitting in a reclined position while the vehicle is moving is dangerous because you do not get the full protection from seat belts. During sudden braking or a collision, you can slide under the lap belt and suffer serious internal injuries. For maximum protection, sit well back and upright.

#### **Do not place an object such as a cushion between the seatback and your back.**

Putting an object such as a cushion between the seatback and your back is dangerous because you will be unable to maintain a safe driving posture and the seat belt cannot function at its full capacity in a collision, which could result in a serious accident, injury or death.

## Front Seats

---

### **Do not place objects under the seat.**

The object could get stuck and cause the seat to not be fixed securely, and result in an accident.

### **Do not stack cargo higher than the seatbacks.**

Stacking luggage or other cargo higher than the seatbacks is dangerous. During sudden braking or a collision, objects can fly around and become projectiles that may hit and injure passengers.

### **Make sure the adjustable components of a seat are locked in place.**

Adjustable seats and seatbacks that are not securely locked are dangerous. In a sudden stop or collision, the seat or seatback could move, causing injury. Make sure the adjustable components of the seat are locked in place by attempting to slide the seat forward and backward and rocking the seatback.

### **Make sure luggage and cargo is secured before driving.**

Not securing cargo while driving is dangerous as it could move or be crushed during sudden braking or a collision and cause injury. Additionally, if the air bags deploy, the cargo may scatter which could result in serious injury or death.

### **Never allow a passenger to sit or stand on the folded seatback while the vehicle is moving.**

Driving with a passenger on the folded seatback is dangerous. Allowing a child to sit up on the folded seatback while the vehicle is moving is particularly dangerous. In a sudden stop or even a minor collision, a child not in a proper seat or child-restraint system and seat belt could be thrown forward, back or even out of the vehicle resulting in serious injuries or death. The child in the baggage area could be thrown into other occupants and cause serious injury.



- When operating a seat, be careful not to put your hands or fingers near the moving parts of the seat or on the side trim to prevent injury.
- When moving the seats, make sure there is no cargo in the surrounding area. If the cargo gets caught it could damage the cargo.
- **(Manual Seat)**  
When moving the seats forward and rearward or returning a rear-reclined seatback to its upright position, make sure you hold onto the seatback with your hand while operating. If the seatback is not held, the seat will move suddenly and could cause injury.
- When inserting your hand under the seat to clean the cabin or pick up something you dropped under the seat, be careful not to hurt yourself. If you contact the moving parts and surrounding parts around the seat rail, seat frame, and the bottom of the seat, it could result in injury.

## How to Use the Front Seats

### Driver's Seat

#### Manual seat

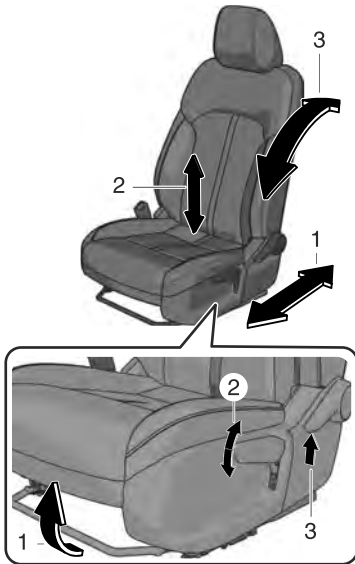

1. Seat Slide
2. Height Adjustment
3. Seat Recline

#### Power seat

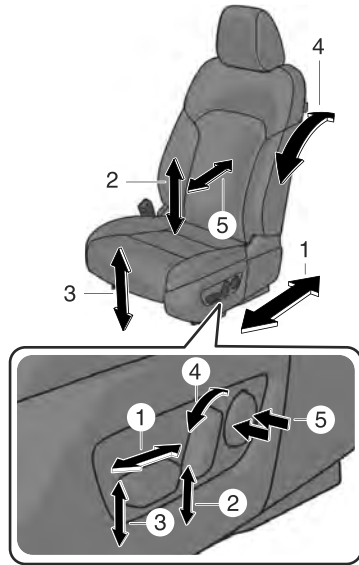

1. Seat Slide
2. Height Adjustment
3. Height Adjustment for Front Edge of Seat Bottom
4. Seat Recline
5. Lumbar Support Adjustment



**Passenger's seat**

**Manual seat**

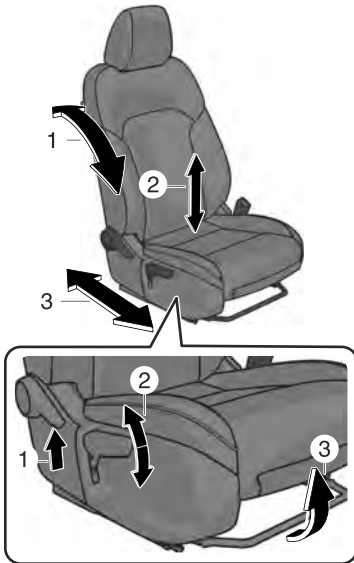

1. Seat Recline
2. Height Adjustment\*
3. Seat Slide

**Power seat**

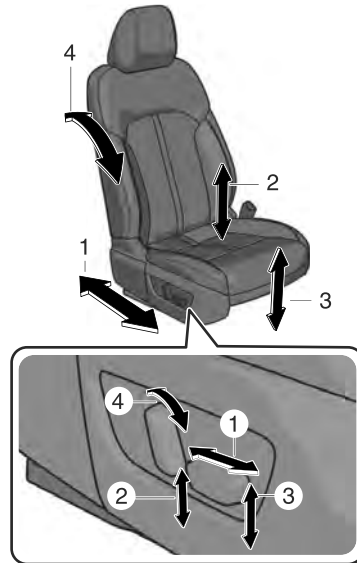

1. Seat Slide
2. Height Adjustment\*
3. Height Adjustment for Front Edge of Seat Bottom\*
4. Seat Recline

**NOTE  
(Power Seat)**

The seat-bottom power adjustment is operated by motors. Avoid extended operation because excessive use can damage the motors.

- To prevent the battery from running down, avoid using the power adjustment when the engine is stopped. The adjuster uses a large amount of electrical power.
- Do not use the switch to make more than one adjustment at a time.

## **Driving Position Memory\***

The desired driving position can be called up after programming the position.

- Driver's seat position (Seat slide, height adjustment, front edge of seat bottom, seat recline)
- Active driving display (Display position, brightness level, display information)
- Outside mirror angle
- Steering Wheel (Power type) (Up and down adjustment, forward and backward adjustment)

## **Warnings and Cautions for Using the Driving Position Memory**



Do not place hand, fingers, or feet around the bottom of the seat or around the bottom of the steering wheel while the seat memory function is operating. The seat or steering wheel moves automatically while the seat memory function is operating and hand, fingers, or feet could get pinched and injured.

## Front Seats

### How to Use the Driving Position Memory

A driving position can be programmed to the position memory switch and the key.

#### Programming

1. Switch the vehicle power ON.
2. Adjust the following driving positions to the desired positions.
  - Driver's seat
  - Active driving display
  - Outside mirrors
  - Steering wheel (Power type)
3. Continue pressing the SET switch until a sound is activated.



4. Do the following operation within 5 seconds after the sound is activated to program the driving position.
  - **Programming to a position memory button**  
Press the button you want to program, either 1 or 2 button.



- **Programming to the transmitter**  
Press the unlock button on the transmitter.

A sound is activated when the operation is completed correctly.

#### Adjusting to the Programmed Driving Position

##### **Operation Using the Position Memory Switch**

Press either switch 1 or 2 that you programmed to activate the seat adjustment to your position. A sound is activated when the adjustment to the programmed driving position is completed.

##### **Operation Using the Key**

1. Unlock the driver's door using one of the following methods.
  - Touch the sensing area of the door release touch sensor.
  - Press the key unlock button.
2. If the driver's door is opened within a certain period of time after unlocking, adjustment of the next driving position starts.
  - Driver's seat
  - Active driving display
  - Outside mirrors
  - Steering wheel (Power type)

A sound is activated when the adjustment to the programmed driving position is completed.

### **Deleting a Programmed Position**

#### **Erasing the Position Stored in the Position Memory Switch**

Program a new driving position.

#### **Deleting a Position Programmed to the Key**

1. Switch the vehicle power OFF.
2. Continue pressing the SET switch until a sound is activated.
3. Press the key lock button within 5 seconds after the sound is activated.

#### **NOTE**

- If the angle of the outer mirror is adjusted close to the limits of its range of motion, the angle of the outer mirrors may not be programmed correctly.
- When the adjustment to the programmed driving position has been completed, a sound is not activated.
- Under the following conditions, the driving position adjustment is canceled.
  - The seat adjustment switch/SET switch/steering wheel (power type)/outer mirrors/active driving display for the driver's seat is operated to adjust the position.
  - The key lock button or unlock button is operated.
  - The vehicle moves.
  - The selector lever is shifted to a position other than P.
  - When the seat operates, a load of a certain amount or more is detected and the safety function operates.

## Rear Seats

### Warnings and Cautions for Using the Rear Seats

#### **WARNING**

**Do not drive the vehicle with occupants on folded down seatbacks or in the luggage compartment.**

Putting occupants in the luggage compartment is dangerous because seat belts cannot be fastened which could lead to serious injury or death during sudden braking or a collision.

**Do not allow children to play inside the vehicle with the seatbacks lowered.**

Allowing children to play in the vehicle with the seatbacks folded down is dangerous. If a child enters the luggage compartment and the seatbacks were raised back up, the child may become trapped in the luggage compartment which could lead to an accident.

**Tightly secure cargo in the luggage compartment when it is transported with the seatbacks folded down.**

Driving without tightly securing cargo and luggage is dangerous as it could move and become an obstruction to driving during emergency braking or a collision resulting in an unexpected accident.

**When transporting cargo, do not allow the cargo to exceed the height of the seatbacks.**

Transporting cargo stacked higher than the seatbacks is dangerous as visibility to the rear and sides of the vehicle is reduced which could interfere with driving operations and lead to an accident.

**Always remove the child-restraint system from the rear seat before operating the remote switch for the rear seat.**

Operating the remote switch while a rear-facing child-restraint system is in the rear seat is dangerous. It could cause injury to a child seated in the child-restraint system when the seatback suddenly flips forward.

**Make sure there is nobody in the rear seat area before operating (pulling) the remote switch.**

Not checking the rear seat area for persons before folding the seatbacks with the remote switch is dangerous. The rear seat area is difficult to see from the rear of the vehicle. Operating (pulling) the remote switch without checking could cause injury to a person when a seatback suddenly flips forward.

#### **CAUTION**

- Check the position of a front seat before folding a rear seatback. Depending on the position of a front seat, it may not be possible to fold a rear seatback all the way down because it may hit the seatback of the front seat which could scratch or damage the front seat or its pocket. Lower or remove the head restraint on the rear outboard seat if necessary.
- When loading or unloading luggage in the luggage compartment, be careful not to press a remote switch by mistake. Otherwise, a rear seatback could fold down unexpectedly which could cause injury to a rear seat occupant or luggage could be damaged.

- Before folding the seatbacks down with the remote switch, make sure there is no cup in a rear cup holder. Folding the seatbacks with the remote switch while a cup is in the cup holder could soil or damage the seat bottom and seatback.
- Be careful of the following when using the remote switch:
  - On a downward slope, the seatback could flip forward faster than on a flat surface.
  - On an upward slope, the seatback may not fold down. When the seatbacks cannot be folded down with the remote switch, pull the rear seatback forward from inside the vehicle.

## How to Use the Rear Seats

### Seat Operation

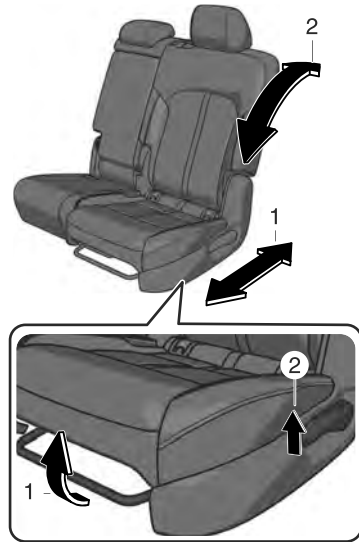

1. **Seat Slide (Forward-back adjustment)**
2. **Seat Recline**

### Folding the Seatbacks

#### **(Using remote switch)\***

1. After checking that the rear seats are clear, open the liftgate.
2. Lower the head restraint to the lowest position.
3. Shift the selector lever to the P position.
4. Press the remote switch on the side to be folded down.

## Rear Seats

The seatback folds forward.

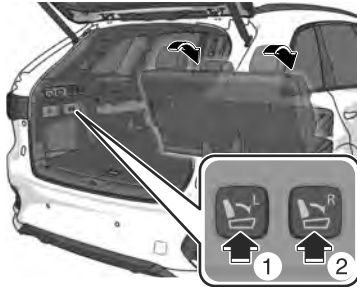

1. For left
2. For right

**(Using the lever)**

1. Lower the head restraint to the lowest position.
2. Pull up the lever on the side of the rear seat and fold the seatback.



### Raising the Seatbacks

1. Press the seatback rearward and lock it in place.



## Warnings and Cautions for Using the Armrests

### **⚠ WARNING**

**Never put your hands and fingers around the moving parts of the seat and armrest.**

Putting your hands and fingers around the moving parts of the seat and armrest is dangerous as they could get injured.

## How to Use the Armrests





## Head Restraints

---

### Head Restraints

Your vehicle is equipped with head restraints on all outboard seats and the rear center seat.

The head restraints are intended to help protect you and the passengers from neck injury.

### Warnings and Cautions for Using the Head Restraints

#### **WARNING**

**Always drive with the head restraints installed when seats are being used and make sure they are properly adjusted.**

Driving with the head restraints adjusted too low or removed is dangerous. With no support behind your head, your neck could be seriously injured in a collision.

**Always drive with the head restraints installed when seats are being used and make sure they are properly installed.**

Driving with the head restraints not installed is dangerous. With no support behind your head, your neck could be seriously injured in a collision.

**After installing a head restraint, try lifting it to make sure that it does not pull out.**

Driving with an unsecured head restraint is dangerous as the effectiveness of the head restraint will be compromised which could cause it to unexpectedly detach from the seat.

#### **CAUTION**

➤ When installing a head restraint, make sure that it is installed correctly with the front of the head restraint facing forward. If the head restraint is installed incorrectly, it could detach from the seat during a collision and result in injury.

➤ The head restraints on each of the front and rear seats are specialized to each seat. Do not switch around the head restraint positions. If a head restraint is not installed to its correct seat position, the effectiveness of the head restraint during a collision will be compromised which could cause injury.

## How to Use the Head Restraints

### Adjusting the Head Restraints

Adjust the head restraint so that the center is even with the top of the passenger's ears.

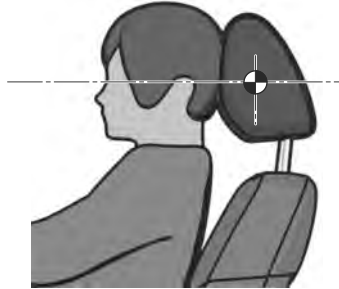

### **To Raise a Head Restraint**

Pull up a head restraint.

### **To Lower a Head Restraint**

Lower a head restraint while pressing the lock knob.

### **Front seats**

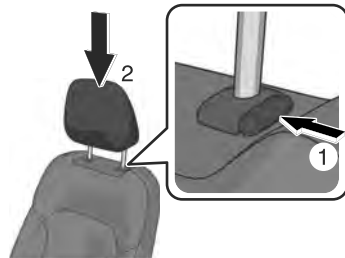

# Head Restraints

---

## Rear seats

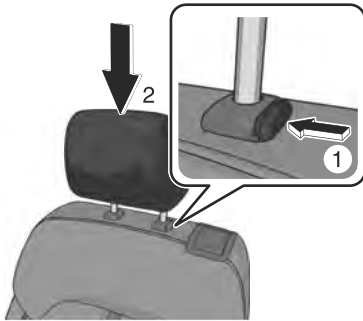

### Removing or Installing a Head Restraint

#### To Remove a Head Restraint

Pull up a head restraint while pressing the lock knob.

**(Rear center seat)**

Pull up the center seat head restraint while pressing both lock knobs.

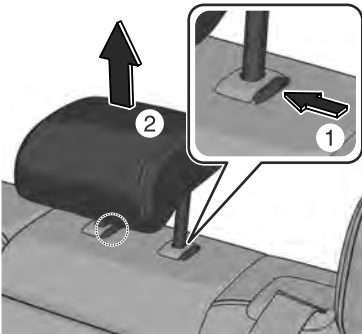

#### To Install a Head Restraint

Insert a head restraint while pressing the lock knob.

**(Rear center seat)**

Insert the center seat head restraint while pressing both lock knobs.

## Warnings and Cautions for Using the Steering Wheel

### **WARNING**

**Never adjust the steering wheel while the vehicle is moving.**

Adjusting the steering wheel while the vehicle is moving is dangerous. Moving it can very easily cause the driver to abruptly turn to the left or right. This can lead to loss of control or an accident.

**After adjusting the steering wheel position, make sure it is securely locked by trying to move it up and down.**

Driving with the steering wheel not securely locked in position is dangerous. If the steering wheel moves unexpectedly while driving, you could lose control of the steering resulting in an accident.

## How to Use the Steering Wheel

### Manual Type

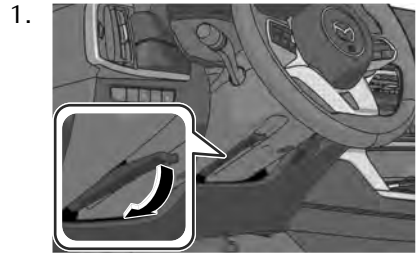

2. Adjust the steering wheel to the appropriate position.

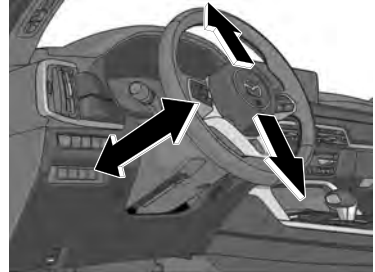

3. Pull up the lever to securely lock the steering wheel.

### Power Type

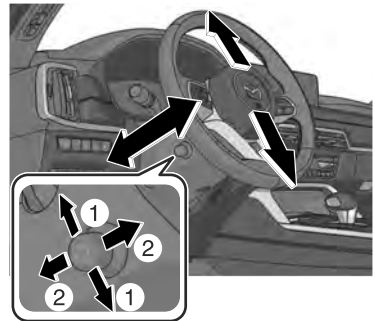

1. Up and down adjustment  
2. Forward and backward adjustment

### Child-restraint Systems

Mazda strongly urges the use of child-restraint systems for children small enough to use them.

You are required by law to use a child-restraint system for children in the U.S. and Canada.

Check your local and state or provincial laws for specific requirements regarding the safety of children riding in your vehicle.

Whatever child-restraint system you consider, please pick the appropriate one for the age and size of the child, obey the law and follow the instructions that come with the individual child-restraint system.

A child who has outgrown child-restraint systems should sit in the rear and use seat belts, both lap and shoulder. If the shoulder belt crosses the neck or face, move the child closer to the center of the vehicle in the outboard seats, and towards the buckle on the right if the child is seated on the center seat.

Statistics confirm that the rear seat is the best place for all children up to 12 years of age, and more so with a supplemental restraint system (air bags).

A rear-facing child-restraint system should **NEVER** be used on the front seat with the air bag system activated. The front passenger's seat is also the

least preferred seat for other child-restraint systems.

#### (With Driver and Front Passenger Occupant Classification System)

To reduce the chance of injuries caused by deployment of the front passenger air bag, the front passenger seat weight sensor works as a part of the supplemental restraint system. This system deactivates the front passenger front and side air bags and knee air bags, and also the front passenger seat belt pretensioner system when the front passenger air bag deactivation indicator light illuminates.

When an infant or small child sits on the front passenger seat, the system shuts off the front passenger front and side air bags and knee air bags, and seat belt pretensioner system, so make sure the front passenger air bag deactivation indicator light illuminates.

Even if the front passenger air bag is shut off, Mazda strongly recommends that children be properly restrained and child-restraint systems of all kinds are properly secured on the rear seats which are the best place for children. For more details, refer to "Driver and Front passenger occupant classification system" (page 3-18).

## Warnings and Cautions For Child-restraint Systems

### **WARNING**

#### **Use the correct size child-restraint system.**

For effective protection in vehicle accidents and sudden stops, a child must be properly restrained using a seat belt or child-restraint system depending on age and size. If not, the child could be seriously injured or even killed in an accident.

#### **Follow the manufacturer's instructions and always keep the child-restraint system buckled down.**

An unsecured child-restraint system is dangerous. In a sudden stop or a collision it could move causing serious injury or death to the child or other occupants. Make sure any child-restraint system is properly secured in place according to the child-restraint system manufacturer's instructions. When not in use, remove it from the vehicle or fasten it with a seat belt, or attach it to BOTH ISOFIX/LATCH\*1 lower anchors for ISOFIX/LATCH\*1 child-restraint systems and the corresponding tether anchor.

\*1 ISOFIX (Mexico)/LATCH (Except Mexico)

#### **Always secure a child in a proper child-restraint system.**

Holding a child in your arms while the vehicle is moving is extremely dangerous. No matter how strong the person may be, he or she cannot hold onto a child in a sudden stop or collision and it could result in serious injury or death to the child or other occupants. Even in a moderate accident, the child may be exposed to air bag forces that could result in serious injury or death to the child, or the child may be slammed into an adult, causing injury to both child and adult.

#### **Never use a rear-facing child-restraint system in the front seat with an air bag that could deploy.**

Rear-facing child-restraint systems on the front seat are particularly dangerous even though you may feel assured that a front passenger air bag will not deploy based on the fact that the front passenger air bag deactivation indicator light illuminates. The child-restraint system can be hit by a deploying air bag and moved violently backward resulting in serious injury or death to the child.



## Child-restraint Systems

### (Mexico)

NEVER use a rearward facing child restraint on a seat protected by an ACTIVE AIRBAG in front of it, DEATH or SERIOUS INJURY to the CHILD can occur.

Vehicles with a front passenger air bag have the following warning label. The warning label reminds you not to put a rear-facing child-restraint system on the front passenger seat at any time.



### (Except Mexico)

Vehicles with a front passenger air bag have the following warning label. The warning label reminds you not to put a rear-facing child-restraint system on the front passenger seat at any time.



**Do not install a front-facing child-restraint system on the front passenger seat unless it is unavoidable.**

In a collision, the force of a deploying air bag could cause serious injury or death to the child. If installing a front-facing child-restraint system on the front passenger seat is unavoidable, move the front passenger seat as far back as possible and adjust the seat bottom (height adjustable seat bottom) to the highest position at which the seat belt fastening the child-restraint system is securely tightened.



**Seating a child in a child-restraint system on the front passenger seat is dangerous under certain conditions (With Driver and Front Passenger Occupant Classification System).**

Your vehicle is equipped with front passenger seat weight sensors. Even with the front passenger seat weight sensors, if you must use the front passenger seat to seat a child, using a child-restraint system on the front passenger seat under the following conditions increases the danger of the front passenger air bag deploying and could result in serious injury or death to the child.

- The front passenger air bag deactivation indicator light does not illuminate when seating a child in the child-restraint system.
- Luggage or other items are placed on the seat with the child in the child-restraint system.

- A rear passenger or luggage pushing or pulling down on the front passenger seatback.
- Luggage or other items are placed on the seatback or hung on the head restraint.
- The seat is washed.
- Liquids are spilled on the seat.
- The front passenger seat is moved backward, pushing into luggage or other items placed behind it.
- The front passenger seatback contacts the rear seat.
- Luggage or other items are placed between the front passenger seat and driver seat.
- An electric device is put on the front passenger's seat.
- An additional electrical device, such as a seat warmer is installed to the surface of the front passenger seat.
- Any accessories, which might increase the total seated weight on the front passenger seat, are attached to the front passenger seat.

The designated positions with seat belts on the rear seats are the safest places for children. Always use seat belts and child restraints.

**Never use one seat belt on more than one person at a time.**

Using one seat belt for more than one person at a time is dangerous. A seat belt used in this way cannot spread the impact forces properly and the two passengers could be crushed together and seriously injured or even killed. Never use one belt for more than one person at a time and always operate the vehicle with each occupant properly restrained.

**Tethered Child-Restraint Systems Work Only on Tether-Equipped Rear Seats.**

Installation of a tether equipped child-restraint system in the front passenger's seat defeats the safety design of the system and will result in an increased chance of serious injury if the child-restraint system goes forward without benefit of being tethered. Place tether equipped child-restraint systems where there are tether anchors.



A seat belt or child-restraint system can become very hot in a closed vehicle during warm weather. To avoid burning yourself or a child, check them before you or your child touches them.



## Types of Child-restraint Systems

### Categories of Child-Restraint Systems

**NOTE**

When purchasing, ask the manufacturer of the child-restraint system which type of child-restraint system is appropriate for your child and vehicle.

**(Mexico)**

Child-restraint systems are classified into the following 5 groups according to the UN-R 44 and UN-R 129 regulation.

Group	Age	Weight	Size Classification/ Fixture (CRF)
0	Up to about 9 months old	Up to 10 kg (up to 22 lb)	ISO/L1
			ISO/L2
			ISO/R1
0+	Up to about 2 years old	Up to 13 kg (up to 29 lb)	ISO/R1
			ISO/R2
			ISO/R3
1	About 8 months to 4 years old	9 kg — 18 kg (20 lb — 40 lb)	ISO/R2
			ISO/R3
			ISO/F2
			ISO/F2X
2	About 3 to 7 years old	15 kg — 25 kg (33 lb — 55 lb)	ISO/F3
			—
3	About 6 to 12 years old	22 kg — 36 kg (48 lb — 79 lb)	—

**(Except Mexico)**

Please comply with the legal regulations concerning the use of child-restraint systems in your country.

### Child-Restraint System Types

In this owner's manual, explanation of child-restraint systems is provided for the following three types of popular child-restraint systems: infant seat, child seat, booster seat.

**NOTE**

- Installation position is determined by the type of child-restraint system. Always read the manufacturer's instructions and this owner's manual carefully.

- Due to variations in the design of child-restraint systems, vehicle seats and seat belts, all child-restraint systems may not fit all seating positions. Before purchasing a child-restraint system, it should be tested in the specific vehicle seating position (or positions) where it is intended to be used. If a previously purchased child-restraint system does not fit, you may need to purchase a different one that will.

**Infant seat**

An infant seat provides restraint by bracing the infant's head, neck and back against the seating surface. Equal to Group 0 and 0+ of the UN-R 44 and UN-R 129 regulation.



**Child seat**

A child seat restrains a child's body using the harness. Equal to Group 1 of the UN-R 44 and UN-R 129 regulation.



**Booster seat**

A booster seat is a child restraint accessory designed to improve the fit of the seat belt system around the child's body. Equal to Group 2 and 3 of the UN-R 44 and UN-R 129 regulation.



1. Full booster seat
2. Backless booster seat

When using a backless booster seat, always install the vehicle head restraint to the seat where the backless booster seat is installed.

### Child-Restraint System Suitability for Various Seat Positions Table

#### (Mexico)

Provided information in the table shows your child-restraint system suitability for various seating position. For installation suitability of other manufacturer child-restraint system, carefully consult the manufacturer's instructions which accompany the child-restraint system.

When installing a child-restraint system, the following points must be observed:

- Always remove the head restraint before installing a child-restraint system. However, when installing a backless booster seat, always install the vehicle head restraint to the seat where the backless booster seat is installed. In addition, always use a tether strap and attach it securely. Refer to How to Use the Head Restraints on page 3-43.
- When installing a child-restraint system to the front passenger seat, adjust the seat slide position as far back as possible. Adjust the seat bottom (height adjustable seat bottom) to the highest position so that the seat belt can securely fasten the child-restraint system. Refer to How to Use the Front Seats on page 3-33.
- When it is difficult to install a child-restraint system to the front passenger seat/rear seat, or the seat belt cannot be secured to the child-restraint system, perform the following operations to adjust the seat holding the child-restraint system so that the seat belt can be secured completely to it.
  - Move the seat forward or back.
  - Move the seatback forward or back.
  - Move the seat upward or downward. (Vehicles with height adjustment function)
- When installing a child-restraint system came equipped with a tether, remove the head restraint. Refer to How to Use the Head Restraints on page 3-43.
- When installing a child-restraint system using the ISOFIX lower anchors, if the connectors of the child-restraint system do not reach the lower anchorage and the child-restraint system cannot be installed, slightly tilt the seatback of the seat holding the child-restraint system rearward. If the seatback of a rear seat cannot be reclined due to interference with luggage on the rear seat, slide the seat forward once and then recline the seatback.
- If the tether strap does not reach the anchor bracket, use an extension strap.
- When installing a child-restraint system to the rear seat, adjust the seat position of the front seat so that the child-restraint system does not contact the front seat. Refer to How to Use the Front Seats on page 3-33.
- When installing a child-restraint system to the rear seat, refer to the How to Use the ISOFIX Lower Anchor (Mexico)/Using LATCH Lower Anchor (Except Mexico) on page 3-64.
- An i-Size child-restraint system refers to a child-restraint system which has acquired i-Size category certification for the UN-R 129 regulation.

Seating position	Passenger	Rear seat (Left)	Rear seat (Center)	Rear seat (Right)
Seating position suitable for universal belted (yes/no)	Yes (UF)	Yes (U) <sup>3</sup>	Yes (U)	Yes (U) <sup>3</sup>
i-Size seating position (yes/no)	No	Yes (i-U)	No	Yes (i-U)
Largest suitable rearward facing fixture (R1)	No	Yes (IL)	No	Yes (IL)
Largest suitable rearward facing fixture (R2)	No	Yes (IL)	No	Yes (IL)
Largest suitable rearward facing fixture (R2X)	No	Yes (IL)	No	Yes (IL)
Largest suitable rearward facing fixture (R3)	No	Yes (IL)	No	Yes (IL)
Largest suitable forward facing fixture (F2)	No	Yes (IUF)	No	Yes (IUF)
Largest suitable forward facing fixture (F2X)	No	Yes (IUF)	No	Yes (IUF)
Largest suitable forward facing fixture (F3)	No	Yes (IUF)	No	Yes (IUF)
Largest suitable lateral facing fixture (L1)	No	No	No	No
Largest suitable lateral facing fixture (L2)	No	No	No	No
Largest suitable booster fixture (B2)	No	Yes (IUF)	No	Yes (IUF)
Largest suitable booster fixture (B3)	No	Yes (IUF)	No	Yes (IUF)

# Child-restraint Systems

Seating position	Passenger	Rear seat (Left)	Rear seat (Center)	Rear seat (Right)
non i-size compatible with a support leg (yes/no)	Yes*1	Yes	Yes	Yes
lower ISOFIX anchorages but without Top Tether (yes/no)	No	No	No	No

U = Suitable for “universal” category restraints approved for use in all mass groups.

UF = Suitable for forward-facing “universal” category restraints approved for use in all mass groups.

IUF = Suitable for ISOFIX forward child restraints systems of universal category approved for use in the mass group.

L = Suitable for particular child restraints given on attached list. These restraints may be of the “specific vehicle”, “restricted” or “semi-universal” categories.\*2

IL = Suitable for particular ISOFIX child restraint systems (CRS) given in the attached list. These ISOFIX CRS are those of the “specific vehicle”, “restricted” or “semi-universal” categories.\*2

i-U = Suitable for i-Size “universal” Child Restraint Systems forward and rearward facing.

i-UF = Suitable for forward-facing i-Size “universal” Child Restraint Systems only.

Yes = Child-restraint system can be secured on the seat.

No = Child-restraint system cannot be secured on the seat, or there is no fixture.

X = Child-restraint system cannot be installed.

\*1 Child restraint system can only be installed in the forward-facing position.

\*2 A Mazda genuine child-restraint system can be installed. Regarding child-restraint systems which can be installed, refer to Child-Restraint System Types on page 3-50 or the accessories catalog.

\*3 When installing a child-restraint system on the center seat of the rear seat, do not seat occupants in the outboard seat positions of the rear seats.

**(Except Mexico)**

- Regarding child-restraint systems which can be installed to your Mazda, consult an Authorized Mazda Dealer.
- It is not able to set the child-restraint system with the support leg in the rear center seat.
- For the CRS which do not carry the ISO/XX size class identification (A to G), for the applicable mass group, the child seat manufacturer shall indicate the vehicle specific LATCH child-restraint systems recommended for each position.

## Installing Child-Restraint Systems

Accident statistics reveal that a child is safer in the rear seat. The front passenger's seat is clearly the worst choice for any child under 12, and with rear-facing child-restraint systems it is clearly unsafe due to air bags.

### NOTE

Even if your vehicle is equipped with front passenger occupant classification sensor (page 3-18), which automatically deactivates the front passenger air bag, a rear seat is the safest place for a child of any age or size.

Some child-restraint systems now come with tethers and therefore must be installed on the seats that take tethers to be effective.

Some child-restraint systems also employ specially designed ISOFIX/LATCH\*1 attachments; refer to "How to Use the ISOFIX Lower Anchor (Mexico)/LATCH Lower Anchor (Except Mexico)" (page 3-64).

\*1 ISOFIX (Mexico)/LATCH (Except Mexico)

## Anchor Bracket Overview

Anchor brackets for securing child-restraint systems are equipped in the vehicle. Locate each anchor position using the illustration.

To install a child-restraint system, if the seat is equipped with a head restraint, remove it. Always follow the instruction manual accompanying the child-restraint system.

### Anchor bracket location

Use the indicated anchor bracket locations when installing a child-restraint system equipped with a tether.

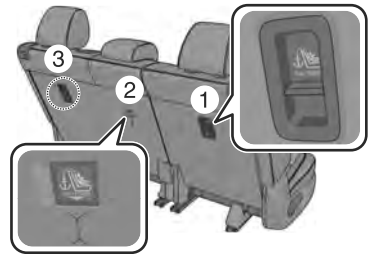

1. For right
2. For center\*
3. For left

## Warnings and Cautions for Using the Anchor Bracket

### **WARNING**

**Always attach the tether strap to the correct tether anchor position.** Attaching the tether strap to the incorrect tether anchor position is dangerous. In a collision, the tether strap could come off and loosen the child-restraint system. If the child-restraint system moves it could result in death or injury to the child.

**Use the tether and tether anchor only for a child-restraint system.** Using the tether or tether anchor to secure anything but a child-restraint system is dangerous. This could weaken or damage the tether or tether anchor and result in injury.

**Always remove the head restraint and install child-restraint system (except when installing a backless booster seat).**

Installing a child-restraint system without removing the head restraint is dangerous. The child-restraint system cannot be installed correctly which may result in death or injury to the child in a collision.

### (Mexico)

If the top tether strap does not reach the anchor bracket, purchase and use an extension strap provided by the CRS manufacturer.

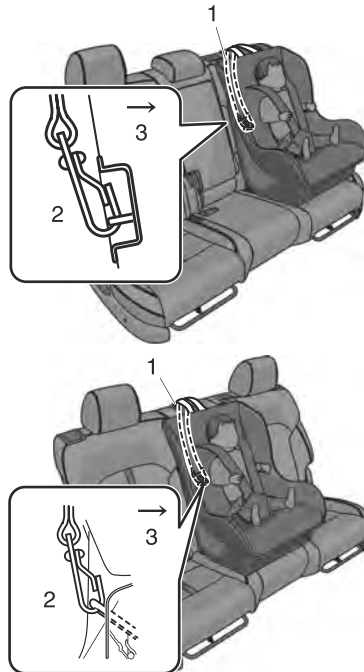

1. Tether strap
2. Anchor bracket
3. Forward

**Always install the head restraint and adjust it to the appropriate position after removing the child-restraint system (except when installing a backless booster seat).**

Driving with the head restraint removed is dangerous as impact to the occupant's head cannot be prevented during emergency braking or in a collision, which could result in a serious accident, injury or death. Refer to How to Use the Head Restraints on page 3-43.

## How to Use the Automatic Locking Mode (Except Mexico)

### NOTE

Follow the child-restraint system manufacturer's instructions carefully. If you are not sure whether you have a LATCH system or tether, check in the child-restraint system manufacturer's instructions and follow them accordingly. Depending on the type of child-restraint system, it may use LATCH system instead of seat belts or if the belt goes across the child's chest, may recommend against using automatic locking mode.

1. Adjust the rear seat position using the following procedure.
  1. Fold the rear seatback forward.
  2. Raise the rear seatback until a click sound is heard and it is locked in place.



2. Adjust the angle of the rear seatback so that there is no gap between the child-restraint system and the rear seatback.
3. Make sure the seatback is securely latched by pushing it back until it is fully locked.

4. Remove the head restraint. However, when installing a backless booster seat, always install the vehicle head restraint to the seat where the backless booster seat is installed.  
Refer to How to Use the Head Restraints on page 3-43.
5. Secure the child-restraint system with the lap portion of the lap/shoulder belt. See the manufacturer's instructions on the child-restraint system for belt routing instructions.
6. To get the retractor into the automatic locking mode, pull the shoulder belt portion of the seat belt until the entire length of the belt is out of the retractor.





## Child-restraint Systems

7. Push the child-restraint system firmly into the vehicle seat. Be sure the belt retracts as snugly as possible. A clicking noise from the retractor will be heard during retraction if the system is in the automatic locking mode. If the belt does not lock the seat down tight, repeat this step.



### NOTE

Inspect this function before each use of the child-restraint system. You should not be able to pull the shoulder belt out of the retractor while the system is in the automatic locking mode. When you remove the child-restraint system, be sure the belt fully retracts to return the system to emergency locking mode before occupants use the seat belts.

8. If your child-restraint system requires the use of a tether strap, refer to the manufacturer's instructions to hook and tighten the tether strap.

## If You Must Use the Front Seat for Children

If you cannot put all children in the rear seat, at least put the smallest children in the rear and be sure the largest child up front uses the shoulder belt over the shoulder.

NEVER put a rear-facing child-restraint system on the front passenger seat whether your vehicle is equipped with an occupant classification sensor or not.

This seat is also not set up for tethered child-restraint systems, put them in one of the rear seat positions set up with tether anchors.

Likewise the ISOFIX/LATCH<sup>\*1</sup> child-restraint system cannot be secured in the front passenger's seat and should be used in the rear seat.

Do not allow anyone to sleep against the side window since your vehicle has side and curtain air bags, it could cause serious injuries to an out of position occupant. As children more often sleep in cars, it is better to put them in the rear seat. If installing the child-restraint system on the front seat is unavoidable, follow these instructions when using a front-facing child-restraint system in the front passenger's seat.

<sup>\*1</sup> ISOFIX (Mexico)/LATCH (Except Mexico)

### NOTE

- To check if your front seats have side air bags:  
Mazda vehicles equipped with side air bag will have a "SRS AIRBAG" tag on the outboard shoulder of the front seats.
- To check if your vehicle has curtain air bags:

Mazda vehicles equipped with curtain air bag will have an "SRS AIRBAG" marking on the window pillars along the roof edge.

## Warnings and Cautions for Using the Front Seat for Children

### **WARNING**

**Always move the front passenger seat as far back as possible if installing a front-facing child-restraint system on it is unavoidable.**

As your vehicle has front air bags and doubly so because your vehicle has side air bags, a front-facing child-restraint system should be put on the front passenger seat only when it is unavoidable.

Even if the front passenger air bag deactivation indicator light illuminates, always move the seat as far back as possible, because the force of a deploying air bag could cause serious injury or death to the child.

**Never use a rear-facing child-restraint system in the front seat with an air bag that could deploy.**

Rear-facing child-restraint systems on the front seat are particularly dangerous.

Even in a moderate collision, the child-restraint system can be hit by a deploying air bag and moved violently backward resulting in serious injury or death to the child. Even though you may feel assured that the front passenger air bag will not deploy based on the fact that the front passenger air bag deactivation indicator light illuminates, you should not use a rear-facing child-restraint system in the front seat.

## Child-restraint Systems

---

**Always remove the head restraint and install child-restraint system (except when installing a backless booster seat).**

Installing a child-restraint system without removing the head restraint is dangerous. The child-restraint system cannot be installed correctly which may result in death or injury to the child in a collision.

**Always install the head restraint and adjust it to the appropriate position after removing the child-restraint system.**

Driving with the head restraint removed is dangerous as impact to the occupant's head cannot be prevented during emergency braking or in a collision, which could result in a serious accident, injury or death. Refer to How to Use the Head Restraints on page 3-43.

**Do not allow a child or anyone to lean over to or against the side window of a vehicle with side and curtain air bags.**

It is dangerous to allow anyone to lean over to or against the side window, the area of the front passenger seat, the front and rear window pillars and the roof edge along both sides from which the side and curtain air bags deploy, even if a child-restraint system is used. The impact of inflation from a side or curtain air bag could cause serious injury or death to an out of position child. Furthermore, leaning over to or against the door could block the side and curtain air bags and eliminate the advantages of supplemental protection. Because the front seats are equipped with front air bags, the rear seat is always a better location for children. Take special care not to allow a child to lean over to or against the side window, even if the child is seated in a child-restraint system.

## How to Install a Child-Restraint System on the Front Passenger's Seat (With Front Passenger Occupant Classification System)

1. Make sure the vehicle power is switched off.
2. Slide the seat as far back as possible.



3. Remove the head restraint. However, when installing a backless booster seat, always install the vehicle head restraint to the seat where the backless booster seat is installed.
4. Place the child-restraint system on the seat without putting your weight on the seat and fasten the seat belt. See the manufacturer's instructions on the child-restraint system for belt routing instructions.
5. To get the retractor into the automatic locking mode, pull the shoulder belt portion of the seat belt until the entire length of the belt is out of the retractor.

6. Push the child-restraint system firmly into the vehicle seat. Be sure the belt retracts as snugly as possible. A clicking noise from the retractor will be heard during retraction if the system is in automatic locking mode. If the belt does not lock the seat down tight, repeat the previous step and also this one.

### NOTE

- Inspect this function before each use of the child-restraint system. You should not be able to pull the shoulder belt out of the retractor while the system is in the automatic locking mode. When you remove the child-restraint system, be sure the belt fully retracts to return the system to emergency locking mode before occupants use the seat belts.
  - Follow the child-restraint system manufacturer's instructions carefully. Depending on the type of child-restraint system, it may not employ seat belts which are in automatic locking mode.
7. Seat your child safely in the child-restraint system and secure the child according to the instructions from the child-restraint system manufacturer.

## Child-restraint Systems

8. Switch the vehicle power ON and make sure the front passenger air bag deactivation indicator light illuminates after installing a child-restraint system on the front passenger seat.  
If the front passenger air bag deactivation indicator light does not illuminate, remove the child-restraint system, switch the vehicle power to OFF, and then re-install the child-restraint system (page 3-18).



### **WARNING**

**Do not seat a child in a child-restraint system on the front passenger seat if the front passenger air bag deactivation indicator light does not illuminate.**

While it is always better to install any child-restraint system on the rear seat, it is imperative that a child-restraint system **ONLY** be used on the front passenger seat if the deactivation indicator light illuminates when the child is seated in the child-restraint system (page 3-18). Seating a child in a child-restraint system installed on the front passenger seat with the front passenger air bag deactivation indicator light not illuminated is dangerous. If this indicator light does not illuminate, this means that the front passenger front and side air bags, and knee air bags, and seat belt pretensioners are ready for deployment. If an accident were to deploy an air bag, a child in a child-restraint system sitting in the front passenger seat could be seriously injured or killed. If the indicator light does not illuminate after seating a child in a child-restraint system on the front passenger seat, seat a child in a child-restraint system on the rear seat and consult an Authorized Mazda Dealer as soon as possible.

## Using the ISOFIX Lower Anchor (Mexico)/LATCH Lower Anchor (Except Mexico)

Your Mazda is equipped with ISOFIX/LATCH\*<sup>1</sup> lower anchors for attachment of specially designed ISOFIX/LATCH\*<sup>1</sup> child-restraint systems in the rear seats. Both anchors must be used, otherwise the seat will bounce around and put the child in danger. Most ISOFIX/LATCH\*<sup>1</sup> child-restraint systems must also be used in conjunction with a tether to be effective. If they have a tether you must use it to better assure your child's safety.

\*<sup>1</sup> ISOFIX (Mexico)/LATCH (Except Mexico)

## Warnings and Cautions for Using the ISOFIX Lower Anchor (Mexico)/LATCH Lower Anchor (Except Mexico)

### **WARNING**

#### **Follow the manufacturer's instructions for the use of the child-restraint system.**

An unsecured child-restraint system is dangerous. In a sudden stop or a collision it could move causing serious injury or death to the child or other occupants. Make sure the child-restraint system is properly secured in place according to the child-restraint system manufacturer's instructions.

#### **Never attach two child-restraint systems to the same ISOFIX/LATCH\*<sup>1</sup> lower anchor.**

Attaching two child-restraint systems to the same ISOFIX/LATCH\*<sup>1</sup> lower anchor is dangerous. In a collision, one anchor may not be strong enough to hold two child-restraint system attachments, and it may break, causing serious injury or death. If you use the seat position for another child-restraint system when an outboard ISOFIX/LATCH\*<sup>1</sup> position is occupied, use the center seat belts instead, and the tether if tether-equipped.

## Child-restraint Systems

### **Make sure the child-restraint system is properly secured.**

An unsecured child-restraint system is dangerous. In a sudden stop or a collision it could move causing serious injury or death to the child or other occupants. Follow the child-restraint system manufacturer's instructions on belt routing to secure the seat just as you would with a child in it so that nobody is tempted to put a child in an improperly secured seat later on. When not in use, remove it from the vehicle or fasten it with a seat belt, or attach it to BOTH ISOFIX/LATCH\*1 lower anchors for ISOFIX/LATCH\*1 child-restraint systems.

### **Make sure there are no seat belts or foreign objects near or around the ISOFIX/LATCH\*1 child-restraint system.**

Not following the child-restraint system manufacturer's instructions when installing the child-restraint system is dangerous. If seat belts or a foreign object prevent the child-restraint system from being securely attached to the ISOFIX/LATCH\*1 lower anchors and the child-restraint system is installed improperly, the child-restraint system could move in a sudden stop or collision causing serious injury or death to the child or other occupants. When installing the child-restraint system, make sure there are no seat belts or foreign objects near or around the ISOFIX/LATCH\*1 lower anchors. Always follow the child-restraint system manufacturer's instructions.

\*1 ISOFIX (Mexico)/LATCH (Except Mexico)

## How to Use the ISOFIX Lower Anchor (Mexico)/ LATCH Lower Anchor (Except Mexico)

### **Installation on rear outboard seat**

1. First, adjust the front seat to allow clearance between the child-restraint system and the front seat. Refer to How to Use the Front Seats on page 3-33.
2. Adjust the rear seat position using the following procedure.
  1. Fold the rear seatback forward.
  2. Raise the rear seatback until a click sound is heard and it is locked in place.



3. Adjust the angle of the rear seatback so that there is no gap between the child-restraint system and the rear seatback.
4. Make sure the seatback is securely latched by pushing it back until it is fully locked.
5. Remove the cover of the child-restraint system's ISOFIX/LATCH\*1 lower anchors to verify the

locations of the ISOFIX/LATCH\*1 lower anchors.

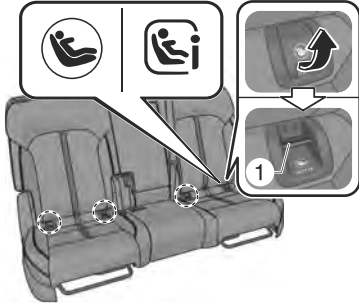

1. ISOFIX/LATCH lower anchor\*1

**NOTE**

- The ISOFIX/LATCH\*1 lower anchors marking on the cover indicates the position of the ISOFIX/LATCH\*1 lower anchors for the attachment of a child-restraint system.
6. Remove the head restraint. However, when installing a backless booster seat, always install the vehicle head restraint to the seat where the backless booster seat is installed. Refer to How to Use the Head Restraints on page 3-43.
  7. Secure the child-restraint system using BOTH ISOFIX/LATCH\*1 lower anchors, following the child-restraint system manufacturer's instruction. Pull on the child-restraint to be sure both anchors are engaged.
  8. If your child-restraint system came equipped with a tether, that means it is very important to properly secure the tether for child safety. Please carefully follow the child-restraint system manufacturer's instructions when installing tethers.

\*1 ISOFIX (Mexico)/LATCH (Except Mexico)

**Installation on rear center seat**

The ISOFIX/LATCH\*1 lower anchors at the center of the rear seat are much further apart than the sets of ISOFIX/LATCH\*1 lower anchors for child-restraint system installation at other seating positions. Child-restraint systems with rigid ISOFIX/LATCH\*1 attachments cannot be installed on the center seating position. Some ISOFIX/LATCH\*1 equipped child-restraint systems can be placed in the center position and will reach the nearest ISOFIX/LATCH\*1 lower anchors which are 500 mm (19.7 in) apart. ISOFIX/LATCH\*1 compatible child-restraint systems (with attachments on belt webbing) can be used at this seating position only if the child-restraint system manufacturer's instructions state that the child-restraint system can be installed to ISOFIX/LATCH\*1 lower anchors that are 500 mm (19.7 in) apart. Do not attach two child-restraint systems to the same ISOFIX/LATCH\*1 lower anchor. If your child-restraint system has a tether, it must also be used for your child's optimum safety.

The procedure for installation on the rear outboard seats is the same.

\*1 ISOFIX (Mexico)/LATCH (Except Mexico)



**ISOFIX/LATCH\*1 lower anchor location**



\*1 ISOFIX (Mexico)/LATCH (Except Mexico)

# 4

## Opening/closing

<b>Key</b> .....	<b>4-4</b>		
Key.....	4-4		
Warnings and Cautions for Using the Key.....	4-4		
How to Use the Key.....	4-5		
Convenient Ways to Use the Key.....	4-8		
<b>Advanced Keyless Entry System</b> .....	<b>4-9</b>		
Advanced Keyless Entry System* .....	4-9		
Warnings and Cautions for Using the Advanced Keyless Entry System.....	4-9		
How to Use the Advanced Keyless Entry System.....	4-10		
<b>Doors</b> .....	<b>4-11</b>		
Warnings and Cautions When Using the Doors.....	4-11		
How to Use the Door Lock .....	4-12		
Convenient Ways to Use the Doors.....	4-15		
<b>Liftgate</b> .....	<b>4-16</b>		
Warnings and Cautions for Using the Liftgate.....	4-16		
How to Use the Liftgate.....	4-17		
Power Liftgate* .....	4-18		
Warnings and Cautions for Using the Power Liftgate.....	4-18		
How to Use the Power Liftgate.....	4-20		
		Convenient Ways to Use the Power Liftgate.....	4-24
		<b>Hood</b> .....	<b>4-25</b>
		Warnings and Cautions for Using the Hood.....	4-25
		How to Use the Hood.....	4-26
		<b>Windows</b> .....	<b>4-27</b>
		Power Windows.....	4-27
		Warnings and Cautions for Using the Power Windows.....	4-27
		How to Use the Power Windows.....	4-28
		Convenient Ways to Use the Power Windows.....	4-29
		<b>Sunroof</b> .....	<b>4-30</b>
		Panorama Sunroof* .....	4-30
		Warnings and Cautions for Using the Panorama Sunroof.....	4-30
		How to Use the Panorama Sunroof.....	4-31
		Moonroof* .....	4-33
		Warnings and Cautions for Using the Moonroof.....	4-34
		How to Use the Moonroof.....	4-35
		<b>Security System</b> .....	<b>4-36</b>
		Security System.....	4-36
		Warnings and Cautions for Using the Security System.....	4-36
		Immobilizer System.....	4-37

---

Warnings and Cautions for Using  
the Immobilizer System..... 4-37  
How to Use the Immobilizer  
System..... 4-38  
Theft-Deterrent System\*.....4-39  
How to Use the Theft-Deterrent  
System..... 4-39

**Rear Seat Alert.....4-41**  
Rear Seat Alert\*..... 4-41  
Warnings and Cautions for Using  
the Rear Seat Alert..... 4-41  
How to Use the Rear Seat  
Alert..... 4-42

# MEMO

## Key

All doors, fuel-filler lid, and the liftgate can be locked/unlocked by pressing the key button.

The key must be carried by the driver.

### Key Code Number Plate

An auxiliary key can be ordered based on the key code number printed on the key code number plate at an Authorized Mazda Dealer.

- Store the key code number plate in a safe place (not in the vehicle).
- Do not divulge the key number to others.



## Warnings and Cautions for Using the Key

### **WARNING**

**Do not leave the key in your vehicle with children and keep them in a place where your children will not find or play with them.**

Leaving children in a vehicle with the key is dangerous. This could result in someone being badly injured or even killed. Children may find these keys to be an interesting toy to play with and could cause the power windows or other controls to operate, or even make the vehicle move.

### **CAUTION**

- Radio equipment like this is governed by laws in the United States. Changes or modifications not expressly approved by the party responsible for compliance could void the user's authority to operate the equipment.
- Because the key (transmitter) uses low-intensity radio waves, it may not function correctly under the following conditions:
  - The key (transmitter) is carried with communication devices such as cellular phones.
  - The key (transmitter) contacts or is covered by a metal object.
  - The key (transmitter) is near electronic devices such as personal computers.
  - Non-Mazda genuine electronic equipment is installed in the vehicle.

- There is equipment which discharges radio waves near the vehicle.
- The key (transmitter) may consume battery power excessively if it receives high-intensity radio waves. Do not place the key (transmitter) near electronic devices such as televisions or personal computers.
- To avoid damage to the key (transmitter), DO NOT:
  - Drop the key (transmitter).
  - Get the key (transmitter) wet.
  - Disassemble the key (transmitter).
  - Expose the key (transmitter) to high temperatures on places such as the dashboard, under direct sunlight.
  - Expose the key (transmitter) to any kind of magnetic field.
  - Place heavy objects on the key (transmitter).
  - Put the key (transmitter) in an ultrasonic cleaner.
  - Put any magnetized objects close to the key (transmitter).

## How to Use the Key

When pressing the button, the operation indicator light turns on.

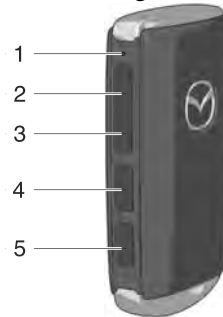

1. Operation indicator light
2. Lock button (🔒)
3. Unlock button (🔓)
4. Power liftgate button (🚗<sup>HOLD</sup>)\*
5. Panic button (📢<sup>HOLD</sup>)

### Lock button 🔒

Press the lock button with all of the following conditions met.

- The vehicle power is switched OFF.

The doors, liftgate, fuel-filler lid are locked, the hazard warning lights operate 1 time.

A beep sound will be heard once.

To confirm that all the doors, liftgate, and fuel-filler lid have been locked, press the lock button again within 5 seconds. If they are closed and locked, the horn will sound.

### NOTE

- The headlights turn on/off by operating the transmitter. Refer to Convenient Ways to Use the Light Switch on page 5-78

- When any door or the liftgate is open and the lock button is pressed, the closed doors can be locked. After that, any other open door or the liftgate can be locked by closing them.
- To prevent the key from being left in the vehicle, make sure that the driver carries the key when locking the doors with any door open.
- **(With theft-deterrent system)**  
If the lock button is pressed with all the doors, liftgate, and the hood are closed, the hazard warning lights will flash and the theft-deterrent system is armed.

### Unlock button

Press the unlock button while the vehicle power is switched OFF. The driver's door and the fuel-filler lid are unlocked, the hazard warning lights operate 2 times, and then a warning sound is activated 2 times. Press the unlock button again within 5 seconds to unlock the other doors.

**(With the advanced keyless function)**  
The hazard warning lights operate and a sound is activated 2 times at the same time.

### NOTE

- **(With the advanced keyless function)**  
The sound can be switched on/off using the Mazda Connect. Refer to the Settings section in the Mazda Connect Owner's Manual.
- The 2-step unlocking function can be set to on/off using Mazda Connect. Refer to the Settings section in the Mazda Connect Owner's Manual.

### Liftgate open/close button

#### Opening the liftgate

Press the liftgate open/close button on the key for about 1 second or longer when all of the following conditions are met.

- The vehicle power is switched OFF.

After the hazard warning lights flash 2 times is activated, the liftgate fully opens.

#### Closing the liftgate

Press the liftgate open/close button for about 1 second or longer when the vehicle power is switched OFF. After the hazard warning lights flash 2 times is activated, the liftgate fully closes.

### NOTE

If the liftgate open/close button is pressed while the liftgate is opening/closing automatically, a warning sound is activated and the liftgate stops. When pressing the liftgate open/close button again, the liftgate moves in the reverse direction.

### Panic button

If you witness from a distance someone attempting to break into or damage your vehicle, press and hold the panic button to activate the vehicle's alarm. Call emergency services if necessary.

### NOTE

The panic button will work whether any door or the liftgate is open or closed.

#### Turning on the alarm

Pressing the panic button for 1 second or more will trigger the alarm for about

2 minutes and 30 seconds, and the following will occur:

- The horn sounds intermittently.
- The hazard warning lights flash.

### Turning off the alarm

The alarm stops by pressing any button on the key.

### Operational Range

The system operates only when the driver is in the vehicle or within operational range while the key is being carried.

### Starting the engine

#### NOTE

- Starting the engine may be possible even if the key is outside of the vehicle and extremely close to a door and window, however, always start the engine from the driver's seat. If the vehicle is started and the key is not in the vehicle, the vehicle will not restart after it is shut off and the vehicle power is switched off.
- The luggage compartment is out of the assured operational range, however, if the key (transmitter) is operable the engine will start.

### With the advanced keyless function

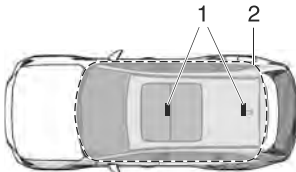

1. Interior antenna
2. Operational range

### Without the advanced keyless function

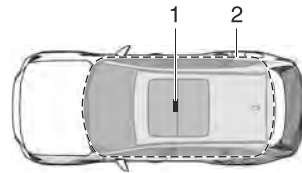

1. Interior antenna
2. Operational range

#### NOTE

The engine may not start if the key is placed in the following areas:

- Around the dashboard
- In the storage compartments such as the glove compartment or the center console



## Convenient Ways to Use the Key

### Sound function

The function that the sound notifies you of unlocking/locking can be turned on or off by changing the setting in Mazda Connect. The volume of the warning sound can also be changed.

### Auto re-lock function

All doors, the liftgate, and the fuel-filler lid are locked automatically if any of the following operations are not performed within about 60 seconds after they are unlocked by pressing the unlock button.

- Open any door or liftgate.
- The vehicle power is switched to any position other than off.

### **NOTE**

The time until the door is automatically locked can be changed.

Refer to the Settings section in the Mazda Connect Owner's Manual.

### Power Saving Function

By turning on the power saving function of the key, the advanced keyless entry and the function to start the engine without removing the key from a pocket or purse/case are turned off, and the battery power consumption of the key can be reduced.

The remote control function is still operational by pressing a button on the key even while the power saving function is turned on. However, the remote operation indicator light does not turn on or flash.

### **Turning on the power saving function**

1. Press the lock button on the key 4 times within 3 seconds.  
The key operation indicator light turns on.
2. Press the lock button for 2 seconds or longer while the key operation indicator light is turned on.  
The hazard warning lights and a warning sound operate 1 time, and the power saving function is turned on.

### **Turning off the power saving function**

1. Press the lock button on the key 4 times within 3 seconds.  
The key operation indicator light turns on.
2. Press the lock button for 2 seconds or longer while the key operation indicator light is turned on.  
The hazard warning lights and a warning sound operate 1 time, and the power saving function is turned off.

## Advanced Keyless Entry System\*

The advanced keyless function allows you to lock/unlock the doors, liftgate, and fuel-filler lid, open the liftgate, and starting the engine while carrying the key.

## Warnings and Cautions for Using the Advanced Keyless Entry System

### WARNING

**Radio waves from the key may affect medical devices such as pacemakers.** Before using the key near people who use medical devices, ask the medical device manufacturer or your physician if radio waves from the key will affect the device.

# Advanced Keyless Entry System

## How to Use the Advanced Keyless Entry System

The system operates only when the driver is in the vehicle or within operational range while the key is being carried.

### NOTE

- The advanced keyless entry system functions can be deactivated to prevent any possible adverse effect on a user wearing a pacemaker or other medical device. If the system is deactivated, you will be unable to start the engine by carrying the key. Consult an Authorized Mazda Dealer for details. If the advanced keyless entry system has been deactivated, you can start the engine by following the procedure indicated when the key battery goes dead. Refer to Starting the engine with a dead key battery on page 8-9.
- The advanced keyless entry system does not operate while the power saving function is operating.
- When the battery power is low, or in places where there are high-intensity radio waves or noise, the operational range may become narrower or the system may not operate.

### Locking/Unlocking Using Touch Sensor

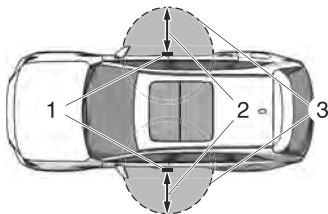

1. Exterior antenna

2. 80 cm (31 in)
3. Operational range

### NOTE

- The system may not operate if you are too close to the windows or door handles, or liftgate.
- If the key is left in the following areas and you leave the vehicle, the doors may be locked depending on the radio wave conditions even if the key is left in the vehicle.
  - Around the dashboard
  - In the storage compartments such as the glove compartment or the center console
  - Next to a communication device such as a mobile phone

### Locking Using Door-Lock Switch/Unlocking Using Electric Liftgate Opener

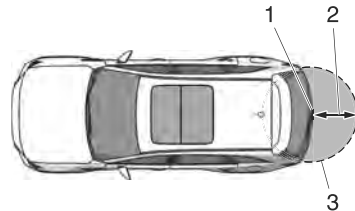

1. Exterior antenna
2. 80 cm (31 in)
3. Operational range

## Warnings and Cautions When Using the Doors

### **WARNING**

**Opening/closing of the doors must be done by an adult.**

If a person's hand, foot, or neck is pinched in a door, it could result in serious injury.

**Do not drive the vehicle with the door-ajar warning light/indication turned on/displayed.**

Otherwise, the door may open unexpectedly and result in an accident.

**Always take all children and pets with you or leave a responsible person with them.**

Leaving a child or a pet unattended in a parked vehicle is dangerous. In hot weather, temperatures inside a vehicle can become high enough to cause brain damage or even death.

**Do not leave the key in your vehicle with children and keep them in a place where your children will not find or play with them.**

Leaving children in a vehicle with the key is dangerous. This could result in someone being badly injured or even killed.

**Keep all doors locked when driving.**

Unlocked doors in a moving vehicle are dangerous. Passengers can fall out if a door is accidentally opened and can more easily be thrown out in an accident.

**Always close all the windows and Panorama sunroof/moonroof, lock the doors, fuel-filler lid, and liftgate and take the key with you when leaving your vehicle unattended.**

Leaving your vehicle unlocked is dangerous as children could lock themselves in a hot vehicle, which could result in death. Also, a vehicle left unlocked becomes an easy target for thieves and intruders.

**After closing the doors and the liftgate, always verify that they are securely closed.**

Doors and the liftgate not securely closed are dangerous, if the vehicle is driven with a door and the liftgate not securely closed, the door and the liftgate could open unexpectedly resulting in an accident.

**Always confirm the safety around the vehicle before opening a door and the liftgate.**

Suddenly opening a door and the liftgate is dangerous. A passing vehicle or a pedestrian could be hit and cause an accident.

### **CAUTION**

Always confirm the conditions around the vehicle during strong winds or when parked on an incline before opening/closing the doors. Neglecting to check the conditions around the vehicle could result in fingers getting caught in the door or a passing pedestrian being hit, resulting in an unexpected accident or injury.

## How to Use the Door Lock

To prevent the key from being left in the vehicle, make sure that you carry the key before locking.

### Locking/Unlocking Using the Key

Refer to How to Use the Key on page 4-5.

### Locking/Unlocking Using the Touch Sensor (Vehicles with Advanced Keyless Function)

#### Locking

Touch the sensing area of the door lock touch sensor when all of the following conditions are met.

- The vehicle power is switched OFF.
- All the doors are closed.
- Your fingers are on the sensing area of the touch sensor.

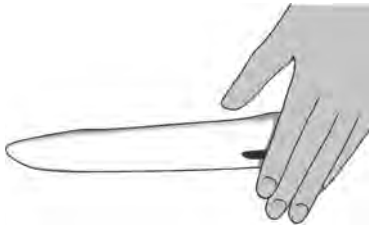

The hazard warning lights operate once, and all the doors, liftgate, fuel-filler lid are locked. A beep sound operates one time.

#### Unlocking

When all of the following conditions are met, touch the sensing area of the door release touch sensor.

- The vehicle power is switched OFF.
- The driver's door is locked.
- Three seconds or longer have passed since the doors were locked.

- Your fingers are on the sensing area of the touch sensor.

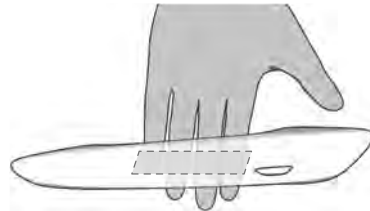

#### Unlocking from the driver's door

The following locations are unlocked by touching the sensing area of the door release touch sensor of the driver's door.

- Driver's door
- Fuel-filler lid

When unlocking, the hazard warning lights operate two times. A beep sound operates two times.

#### Unlocking from the front passenger's door

The following locations are unlocked by touching the sensing area of the door release touch sensor of the front passenger's door.

- All doors
- Fuel-filler lid
- Liftgate

When unlocking, the hazard warning lights operate two times. A beep sound operates two times.

#### NOTE

- The location to be unlocked can be changed. Refer to Settings section in the Mazda Connect Owner's Manual or consult an Authorized Mazda Dealer.
- The beep sound can be turned on/off using Mazda Connect.

Refer to Settings section in the Mazda Connect Owner's Manual or consult an Authorized Mazda Dealer.

- The system may not operate normally under the following conditions.
  - You touch the sensing area of the door lock touch sensor and the sensing area of the door release touch sensor at the same time.



- You touch the sensing area of the touch sensor while wearing gloves.
- Foreign matter such as water, ice, snow, or dirt is on the detection area of the touch sensor.
- The system may operate if the outer side door handle of a front door is splashed with water by a car wash or rain while the key is in the operation range.

### **Locking/Unlocking Using the Door-Lock Switch**

The following locations are locked/unlocked.

- All doors
- Liftgate

- Fuel-filler lid

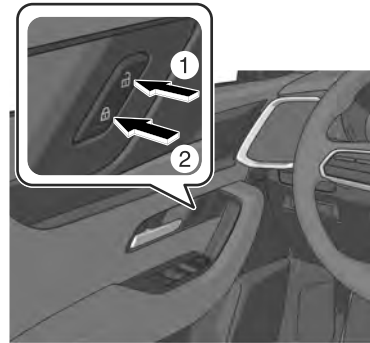

1. Unlocking
2. Locking

### **Locking the doors from the outside using the door-lock switch**

Doors can be locked from the outside of the vehicle without using the key. You can lock the doors by pressing the lock side of the door-lock switch with all of the following conditions met, and then closing all the doors.

- The vehicle power is switched OFF.
- Any door is open.
- The key is not in the vehicle.

After locking by pressing the door-lock switch, closing all the doors with the key left in the vehicle unlocks all doors, the liftgate, and the fuel-filler lid.

### **Door-lock switch on liftgate (With the advanced keyless function)**

#### **With power liftgate**

Refer to How to Use the Power Liftgate on page 4-20.

#### **Without power liftgate**

When all of the following conditions are met, press the door-lock switch and then close the liftgate.

- You are carrying the key.

- The vehicle power is switched OFF.
- All the doors are closed.

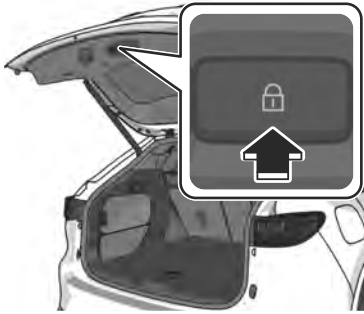

All the doors, liftgate, and the fuel-filler lid are locked.

When locking, the hazard warning lights and a beep sound operate 1 time.

### NOTE

- To prevent the key from being left in the vehicle, make sure that the driver carries the key when locking the doors with any door open.
- After locking by pressing the door-lock switch and if the liftgate is closed last with the key left in the vehicle, the liftgate will not be locked.

### Locking/Unlocking Using the Door-Lock Knob

Locking/unlocking only the door where the door-lock knob is operated.

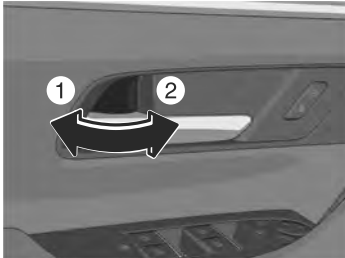

1. Unlocking
2. Locking

### Locking the doors from the outside using the door-lock knob

A door can be locked by turning the inside lock knob to the lock side and closing the door.

### NOTE

- After locking by pressing the door-lock switch, if the liftgate is closed last with the key left in the vehicle, the liftgate will not be locked.
- In the following cases, the doors are unlocked to prevent the key from being left in the vehicle.
  - When the vehicle power is switched to ACC or ON, and the lock knob on the driver's door is turned to the lock side while either a door or the liftgate is open.
  - The key is left in the vehicle.

### Locking Using the Vehicle Speed Sensing Auto Door Lock Function

- All the doors, the liftgate, the fuel-filler lid are locked when the vehicle speed exceeds 20 km/h (12 mph).
- All the doors, the fuel lid, and the liftgate are unlocked when the vehicle power is switched OFF.

Refer to Settings section in the Mazda Connect Owner's Manual or consult an Authorized Mazda Dealer.

### Using the Child Safety Lock

This will prevent the doors from being opened by a child while seated in the rear seat.

1. Open the rear door.
2. Remove the auxiliary key.
3. Turn the child safety lock to the lock side.

When the rear door is closed, it cannot be opened using the interior door handle.

When not using the child safety lock, turn the child safety lock to the unlock side.

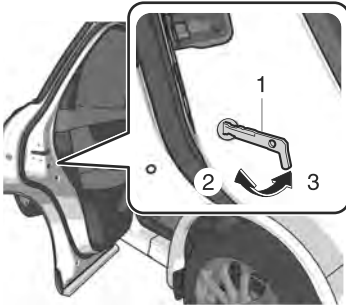

1. Auxiliary key
2. Locking
3. Unlocking

### **Impact detection door-lock unlock system**

This system automatically unlocks all the doors and the liftgate (vehicles without power liftgate) if the vehicle receives a strong impact such as from an accident. By unlocking automatically, occupants can be rescued from outside the vehicle. If the vehicle receives a strong impact while the vehicle power is switched ON, all the doors and the liftgate (vehicles without power liftgate) will be unlocked automatically after about 6 seconds.

The doors and liftgate may not unlock depending on how an impact is applied, the force of the impact, and other conditions of the accident.

## Convenient Ways to Use the Doors

### **Proximity Type Auto Lock Function (With the Advanced Keyless Function)**

You can set the vehicle to lock automatically when you leave the detection area of the touch sensor. Refer to Mazda Connect Owner's Manual or consult an Authorized Mazda Dealer.

A sound is activated one time when closing all the doors and the liftgate while the key is being carried.

If you proceed to leave the operation range, the vehicle is locked automatically (it is locked automatically after about 30 seconds even if you do not leave the operation range).

#### **NOTE**

However, they are not locked under the following conditions.

- Another key is left inside the vehicle.
- The driver's door is already locked.

### **Auto re-lock function**

The vehicle is locked automatically by the auto re-lock function if you do not perform any of the following operations within about 60 seconds after touching the detection area of the touch sensor or unlocking with the key.

- Open any door or liftgate.
- Switch the vehicle power to a position other than OFF.

The time required until automatic locking occurs can be changed. Refer to Mazda Connect Owner's Manual or consult an Authorized Mazda Dealer.



## Warnings and Cautions for Using the Liftgate

### WARNING

#### **Do not allow people to ride in the luggage compartment.**

During sudden braking or a collision, the person in the luggage compartment could be seriously injured or killed.

#### **Always drive the vehicle with the liftgate closed.**

If the liftgate opens while driving the vehicle, the luggage may fall out and lead to an accident. In addition, if the vehicle is driven with the liftgate open, the exhaust gas may penetrate the cabin and it could cause carbon monoxide poisoning.

#### **Do not stack or leave loaded luggage unsecured in the luggage compartment.**

Otherwise, the luggage may move or collapse, resulting in injury or an accident. In addition, do not load luggage higher than the seatbacks. It may affect the side or rear field of view. If the air bags deploy, the cargo may scatter which could result in serious injury or death.

#### **After closing the liftgate, make sure that it is securely closed.**

Driving the vehicle with the liftgate not fully closed is dangerous as a person or an object could fall out of the vehicle resulting in a serious accident, injury, or death.

#### **Do not drive the vehicle with the liftgate-ajar warning indication displayed.**

Otherwise, the liftgate may open unexpectedly and result in an accident.

### CAUTION

- Remove snow or ice on the liftgate before opening the liftgate. When opening the liftgate, it could slam shut by the weight of snow or ice, resulting in injury.
- Be careful when opening/closing the liftgate during strong winds. Otherwise, it could close suddenly resulting in injury.
- When opening the liftgate, fully open it and make sure that it stays open. If the liftgate is only opened partially, it could slam shut by vibration or wind gusts resulting in injury.
- Stop the engine when loading or unloading cargo in the luggage compartment. Otherwise, you could get burned by the heat of the exhaust gas.
- Be careful not to pinch your hand when closing the liftgate. It may result in an injury if your hand is caught.
- Be careful not to apply excessive force to the damper stay on the liftgate such as by putting your hand on the stay. Otherwise, the damper stay may bend and affect the liftgate operation.

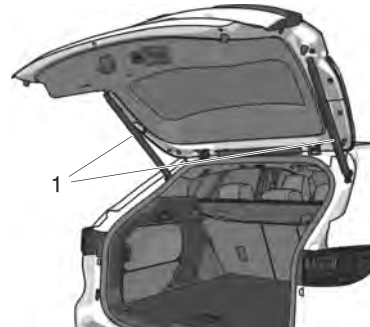

1. Damper stay
- Do not modify or replace the liftgate damper stay. Consult an Authorized Mazda Dealer if a liftgate damper stay is deformed or damaged for reasons such as a collision or if there is some other problem.

## How to Use the Liftgate

### Opening the Liftgate

#### Using the electric liftgate opener

1. Stop the vehicle.
2. Unlock the door.
3. Press the electric liftgate opener.

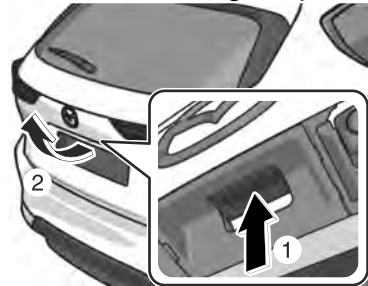

4. Lift the liftgate.

#### **NOTE** (Vehicles with advanced keyless function)

The liftgate can be opened even while the doors and the liftgate are locked by pressing the electric liftgate opener while carrying the key.

### Closing the Liftgate

1. Lower the liftgate slowly using the liftgate recess.
2. Press down the liftgate to close.



## Power Liftgate\*

The liftgate opens and closes automatically by operating the key switch or various switches for the vehicle.

### Hands-free function\*

The liftgate can be opened and closed by doing a kicking motion under the rear bumper when both hands are occupied, such as when holding groceries or luggage.

### Liftgate easy closure

The easy closure assists in closing the liftgate.

When you close the liftgate to the position where it is slightly ajar, it will finish closing automatically to the fully-closed position.

### **NOTE**

If the liftgate is opened/closed repeatedly in a short period of time, the easy closure function may not operate. Wait for about 2 seconds and then try again.

### Jam-safe function

The jam-safe function detects a person or obstruction to prevent the person or object from getting caught in the liftgate.

When the jam-safe function detects that a person or object is caught in the liftgate while it is opening/closing automatically, a warning sound is activated and the liftgate moves in the reverse direction, and then stops.

### **NOTE**

The jam-safe function does not operate while the easy closure is operating (from ajar position to fully closed position).

## Warnings and Cautions for Using the Power Liftgate

### **WARNING**

**Always check the safety of the area around the liftgate before operating/closing it automatically.**

Not checking the safety of the area around the liftgate for people before opening/closing the liftgate automatically is dangerous. A person could become caught between the liftgate and an obstruction while it is opening automatically or between the liftgate and vehicle while it is closing automatically, resulting in an accident and serious injury.

**Keep your eyes on the liftgate when opening/closing the liftgate automatically.**

If there is an obstruction, the liftgate may not fully close due to the jam-safe function. Driving the vehicle with the liftgate not fully closed is dangerous as a person or an object could fall out of the vehicle resulting in a serious accident, injury, or death.

**Do not let a child operate the switches.**

If the liftgate is opened/closed unexpectedly by a child operating the switches mistakenly, the child or another occupant's head or hands could get caught, resulting in an accident and serious injury.

**Always make sure that there is no person or obstruction around the liftgate before closing the liftgate.**

The jam-safe function detects a person or obstruction to prevent the person or object from getting caught. The system may not detect certain objects obstructing the liftgate depending on the way they are positioned and their shape. Be especially careful with children. It may result in an injury if a finger gets pinched.

**When closing a liftgate, always keep hands and fingers away from the liftgate.**

Placing hands or fingers around a liftgate is dangerous because the liftgate closes automatically from the near-shut position, which could cause hands and fingers to be pinched and injured.

**⚠ CAUTION**

- When closing the liftgate, make sure that there is no foreign matter around the striker. If foreign matter is obstructing the striker, the liftgate may not close properly.



1. Striker

- Do not install accessories to the liftgate other than those specified. Otherwise, the liftgate may not open/close automatically resulting in a malfunction.

- When the liftgate is switched from automatic to manual operation, the liftgate may open/close unexpectedly depending on its position, resulting in injury.
- Be careful that your fingers do not get pinched in a closing liftgate. The liftgate finishes closing to the fully-closed position automatically after you close it to where it is slightly ajar. If your fingers get pinched, it may result in an injury.
- Do not apply excessive force to the liftgate when closing it. Otherwise, it could cause a system malfunction.
- Sensors are installed on both ends of the liftgate. Be careful not to allow the sensors to be scratched or damaged by sharp objects. Otherwise, the liftgate may no longer open/close automatically. In addition, if the sensor is damaged while the liftgate is closing automatically, the liftgate stops.



1. Sensor

- Do not paint the rear bumper or install any add-on equipment to it. Otherwise, the hands-free sensor may not operate normally.

- If you are carrying the key around the liftgate or there is another person around the liftgate who is carrying a key, do not allow the following to occur. Otherwise, the hands-free sensor will operate and the liftgate may open/close unexpectedly resulting in an accident.

To prevent an unintended operation, place the key outside of its operation range or turn off the hands-free function using Mazda Connect.

- A person not carrying a key does the kicking motion.
- While the liftgate is open, a person sitting on the edge of the luggage compartment swings his or her legs.
- Installing/removing the body cover or removing snow around the rear bumper.
- Picking up something which was dropped under the rear bumper.
- Spraying water on the rear bumper using a high water pressure car washer.
- Pushing a shopping cart close to the rear bumper.
- A moving object such as an animal or a ball approaches the rear bumper.

## How to Use the Power Liftgate

### NOTE

- In the following cases, the liftgate may not open/close automatically.
  - The vehicle is parked on an incline.
  - There are strong winds.
  - There is snow on the liftgate.
- If the lead-acid battery is disconnected with the liftgate open, the liftgate cannot be opened/closed automatically. To restore the automatic open/close function, fully close the liftgate manually.
- If the system detects weight such as that caused by a snow-laden liftgate when it is opened automatically, a warning sound is activated, the liftgate moves in the reverse direction, and then stops.
- If the selector lever is shifted to another position and the vehicle is moved while the liftgate is opening/closing automatically, a warning sound is activated and the liftgate closes.
- The liftgate may close unexpectedly after opening it on slopes. Always make sure that the liftgate is stationary.

When the following operations are performed, the hazard warning lights flash 2 times, a warning sound is activated, and the liftgate automatically opens/closes fully.

### Opening/closing using the liftgate open/close button (HOLD) on the key

Press the liftgate open/close switch on the key for 1 second or longer when all of the following conditions are met.

- The vehicle power is switched OFF.

- The vehicle is stopped.

### **Opening/closing the liftgate using the power liftgate switch**

Press the power liftgate switch for 1 second or longer when all of the following conditions are met.

- The vehicle is stopped.
- The vehicle power is switched to a position other than ON, or the selector lever is in the P position with the vehicle power switched ON
- All the doors are unlocked (when opening)

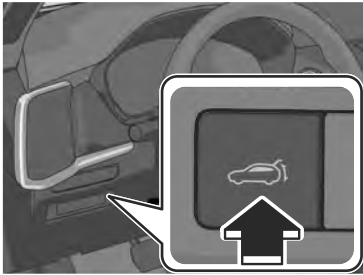

### **Opening the liftgate using the electric liftgate opener**

Press the electric liftgate opener when all of the following conditions are met.

- The vehicle power is switched to a position other than ON, or the selector lever is in the P position with the vehicle power switched ON
- All the doors are unlocked.

#### **NOTE**

The liftgate can be opened even while the doors are locked by pressing the electric liftgate opener while carrying the key.

### **Closing the liftgate using the power liftgate close switch**

Press the power liftgate close switch when all of the following conditions are met.

- The vehicle power is switched to a position other than ON, or the selector lever is in the P position with the vehicle power switched ON



#### **NOTE**

To prevent the key from being left in the vehicle, make sure that the driver carries the key when operating the power liftgate close switch.

### **Closing using the door-lock switch on the liftgate (With the advanced keyless function)**

Press the door-lock switch on the liftgate when all of the following conditions are met.

- You are carrying the key.
- The vehicle power is switched OFF.
- All the doors are closed.

- The liftgate is not automatically opening/closing.

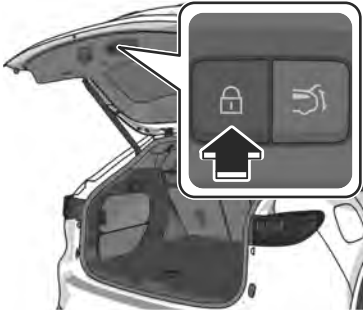

The doors, liftgate, and the fuel-filler lid are locked, the hazard warning lights operate 1 time. Then, the liftgate fully closes automatically.

### Opening/closing using the hands-free function

Do the kicking motion with all of the following conditions met while the vehicle is stopped.

- You are carrying the key.
- The hands-free function is on.
- The vehicle power is switched to a position other than ON, or the selector lever is in P with the vehicle power switched ON.



A : About 30—50 cm (12—19.7 in)

B : About 10 cm (3.9 in)

When the kicking motion is done correctly, the hazard warning lights flash 2 times, a beep sound is activated, and the liftgate opens/closes automatically. Be careful not to contact the liftgate.

Move your foot away from under the bumper within about 1 second after moving it under the bumper.

If the kicking motion is done while the liftgate is opening/closing automatically, the liftgate will stop. If the kicking motion is done again, the liftgate moves in the direction opposite to the direction it was moving before it stopped.

### **⚠ CAUTION**

- Do not do the kicking motion while wearing footwear which exposes the feet, such as sandals. If your foot contacts the hot exhaust pipe, it could cause serious burns.
- Do not do the kicking motion while the area where you are standing is unstable such as a slope or icy road. Otherwise, you could fall down, resulting in injury.

### **NOTE**

- The hands-free sensor detects in a range of about 30 cm on both the left and right sides from the center of the rear bumper.

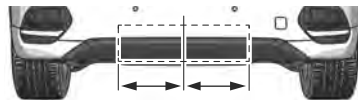

- The hands-free sensor may not operate normally under the following conditions.

- Your foot remains placed within the detection area.

- You move your foot left and right within the detection area.
- The kicking motion is too fast or too slow.
- Your foot contacts the rear bumper when doing the kicking motion.
- You are wearing shoes such as rubber boots which do not conduct electricity well.
- There is equipment emitting strong radio waves near the vehicle.
- The detection area of the hands-free sensor is dirty.
- When the detection area of the hands-free sensor is dirty, wipe it off with a clean cloth. Before cleaning the sensor, place the key outside of its operation range or turn off the hands-free function using Mazda Connect.
- If the operation using the hands-free sensor is not possible even though the operation conditions are met, consult an Authorized Mazda Dealer.

### **Hands-free function ON/OFF switching**

The hands-free function can be switched on/off.

Refer to Mazda Connect Owner's Manual or consult an Authorized Mazda Dealer.

To prevent an unintended operation, turn off the function.

### **Stopping the liftgate**

If any of the following operations is done, the automatic opening and closing of the liftgate stops.

- The liftgate open/close switch on the key is pressed.
- The power liftgate switch is pressed.
- The electric liftgate opener is pressed.
- The power liftgate close switch is pressed.

- The door-lock switch on the liftgate is pressed.
- The kicking motion is done.

### **NOTE**

The liftgate cannot be stopped when it is half open or lower. It moves in the close direction by the load weight of the liftgate itself.

The automatic opening/closing of the liftgate can be stopped using the kicking motion even if you do not have the key.

### **Moving the liftgate again**

If any of the following operations is done, the liftgate moves in the direction opposite to the direction it was moving before it stopped.

- The liftgate open/close switch on the key is pressed for 1 second or longer.
- The power liftgate switch is pressed for about 1 second or longer.
- The electric liftgate opener is pressed.
- The power liftgate close switch is pressed.

When the door-lock switch on the liftgate is pressed, the liftgate automatically fully closes.



## Convenient Ways to Use the Power Liftgate

The liftgate fully-open position can be changed according to the height of a garage.

Set the desired fully-open position of the liftgate at the position where it is open more than halfway. The liftgate fully-open position cannot be changed to a position that is less than half open.

### Changing the fully-open position

1. Stop the liftgate at the desired position.
2. Press and hold the power liftgate close switch for 3 seconds or longer.  
A warning sound is activated 2 times to indicate that the position change has been completed.

### Resetting the set fully-open position

1. Open the liftgate.
2. Press and hold the power liftgate close switch for 7 seconds or longer.  
A warning sound is activated 3 times to indicate that the reset has been completed.

#### **NOTE**

After 3 seconds have passed since the switch was pressed, a warning sound is activated 2 times to indicate that the liftgate fully-open position has changed. Continuously press the switch for 7 seconds to complete the reset.

## Warnings and Cautions for Using the Hood

### **WARNING**

#### **Always check that the hood is closed and securely locked.**

A hood that is not closed and securely locked is dangerous as it could fly open while the vehicle is moving and block the driver's vision which could result in a serious accident.

#### **Do not drive the vehicle with the door-ajar warning indication displayed.**

If the hood opens while driving the vehicle, it will obstruct the front view and could cause an accident.

### **CAUTION**

- Do not close the hood or open the hood to the fully-opened position with the engine cover open. The engine cover may be damaged resulting in injury.  
For details on opening and closing the engine cover.  
Refer to Checking the Inspection Locations and Inspection Items on page 9-14.
- When closing the hood, do not push it excessively such as by applying your weight. Otherwise, the hood could be deformed.
- Be careful not to pinch your hand when closing the hood. It may result in an injury if your hand is caught.

- When inspecting the engine compartment, do not misplace any tools or cloth. Misplacing any tools or cloth may result in engine damage, cause a fire, or cause an unexpected accident.
- Be careful not to apply excessive force to the damper stay on the hood such as by putting your hand on the stay. Otherwise, the damper stay may bend and affect the hood operation.
- Do not modify or replace the hood damper stay. Consult an Authorized Mazda Dealer if you find a problem.
- When opening the hood, make sure that the hood stops. If the hood is only opened partially, it could slam shut by vibration or wind gusts resulting in injury.

## How to Use the Hood

### Opening the Hood

1. Pull the hood release handle.  
The hood will raise slightly.



2. When the hood is raised by about 40 cm, it opens automatically. When the hood is opened to a certain position, it is held open.

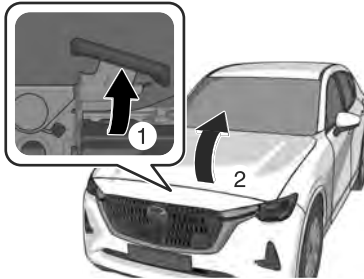

### NOTE

If you push up from the position where the hood has stopped, you can open the hood further.

### Closing the Hood

1. Make sure that there are no tools left in the engine compartment.
2. Lower the hood slowly and release it from a height of about 35 cm without applying excessive force. The hood closes.

### NOTE

When the hood is closed by pushing it with a hand, it may not be locked normally. If the hood does not close completely, open it again and operate it slightly more strongly using the same method.

## Power Windows

The power window has two functions.

### Auto-opening/Closing Function

The windows can be fully opened and closed without having to continue operating the power window switch.

### Jam-Safe Function

If a foreign object is detected between the window and the window frame while the window is closing, the window stops closing and opens slightly.

#### NOTE

- The power windows cannot be opened from the outside of the vehicle if the power window initialization has not been completed.  
Refer to Initializing the Power Window on page 8-30.
- **(A window cannot be closed)**  
If the jam-safe function has operated and the window cannot be closed, check around the window frame for a foreign object.  
If there is no foreign object around the window frame, forcibly close a window using the following procedure.
  1. After switching the vehicle power OFF, wait for 45 seconds or longer.
  2. Switch the vehicle power ON.
  3. Operate the switch in the direction to close the window until the jam-safe function operates and the window stops. Repeat this operation a total of 5 times.
  4. Continue pulling up the switch to fully close the window.

## Warnings and Cautions for Using the Power Windows

### WARNING

**When closing the windows, be careful that a passenger's hand or head does not get pinched.**

Be especially careful with children. If a hand or head becomes pinched, it could cause serious injury.

**Do not let a child operate the power window switches.**

If a hand or head becomes pinched, it could cause serious injury.

**Keep the power window lock switch in the lock position when carrying a child.**

If the child operates the power window switch incorrectly and a hand or head becomes pinched, it could cause serious injury.

**Make sure that there is nothing blocking the window just before it closes completely or while the power window switch is being pulled.**

The jam-safe function may not be able to prevent the window from closing completely. If a finger gets pinched, it could cause serious injury.

**Do not let a child put a hand or head out of the window.**

Be careful not to let a child put a hand or head out of the window while driving the vehicle. If the child's hand or head hits something outside the vehicle or sudden braking is applied, it could result in serious injury or death.

## How to Use the Power Windows

### Opening/Closing the Windows

1. Switch the vehicle power ON.
2. Operate the power window switch.  
To fully open the window automatically, press the power window switch all the way down and then release it.  
To fully close the window automatically, pull the power window switch all the way up and then release it.

#### Driver's Seat

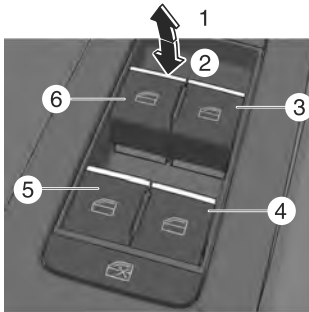

#### Front passenger/rear passenger seat



1. Close
2. Open
3. Front passenger's window
4. Right rear window
5. Left rear window
6. Driver's window

### Locking the Front Passenger/Rear Seat Windows

Switch the power window lock switch on the driver's door to the lock position.

The driver's switch can be operated, however, the front passenger/rear passenger switches are no longer operable.

The passenger windows may be opened or closed using the master control switches on the driver's door. Press the power window lock switch again to the unlock position to cancel it.

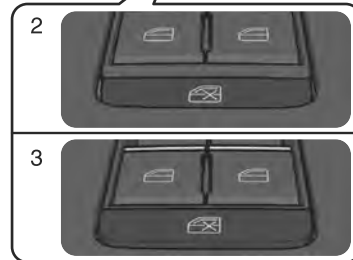
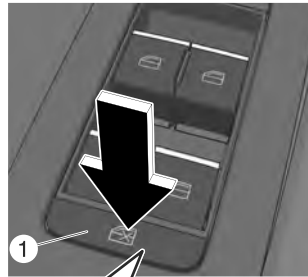

1. Power window lock switch
2. Lock position
3. Unlock position

## Convenient Ways to Use the Power Windows

### Operation Function After Vehicle power is Switched OFF

All the windows can be opened and closed for approximately 40 seconds after the vehicle power is switched to ACC or OFF with all doors closed. If any door is opened, the power window will stop operating.

### Remote Power Window Operation

All power windows can be opened from outside the vehicle after the doors are closed.

The power windows can be operated remotely when the power window lock button on the driver's door is in the lock or unlocked position.

Remote power window operation is activated under the following conditions.

- All the doors and liftgate are closed.
- The vehicle power is switched OFF.

### **NOTE**

The power windows cannot be opened from the outside of the vehicle if the power window initialization has not been completed.

### **Opening**

The windows can be opened for ventilating the cabin before getting in the vehicle.

Press the unlock button on the key quickly and briefly 3 times and then immediately afterwards, press and hold the unlock button to open the windows.



To stop the windows from opening, release the button. If the operation is performed from the beginning again, the windows open.

## Panorama Sunroof\*

The panorama sunroof can be opened or closed when operating the overhead tilt/slide switch at the front seats.

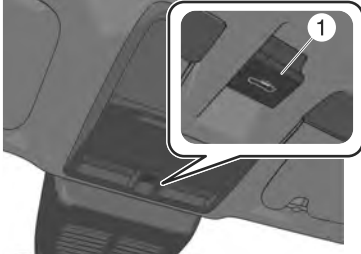

1. Tilt/slide switch

### Jam-safe function

If foreign matter caught between the panorama sunroof and the window frame is detected while it is closing automatically, the panorama sunroof stops and opens partway.

### **NOTE**

When the jam-safe function is inoperable, the panorama sunroof initial setting is not performed. Refer to Initializing the Panorama Sunroof on page 8-31.

## Warnings and Cautions for Using the Panorama Sunroof

### **⚠ WARNING**

**When closing the panorama sunroof, be careful that a passenger's hand or head does not get pinched.**

If a hand or head becomes pinched, it could cause serious injury.

**Do not let a child operate the tilt/slide switch.**

If a hand or head becomes pinched, it could cause serious injury.

**Do not allow a passenger to put a hand or head out of the area where the panorama sunroof opens while driving the vehicle.**

If the person's hand or head hits something outside the vehicle, or sudden braking is applied, it could result in serious injury or death.

**While driving, do not let occupants stand up and extend a part of their body out of the opening.**

Extending your head, arms, or other parts of your body from the panorama sunroof is dangerous. Your head or arm may hit something while driving, which could result in a fatal injury.

**Just before the panorama sunroof completely closes, make sure there is nothing obstructing the panorama sunroof.**

The jam-safe function may not prevent the panorama sunroof from closing completely. Getting your fingers pinched could cause serious injury.

**⚠ CAUTION**

- Do not sit on or put heavy items on the area where the panorama sunroof opens and closes. Otherwise, the panorama sunroof could be damaged.
- Do not open or close the panorama sunroof forcefully during freezing temperatures or snowfall. Otherwise, it could cause a malfunction.
- The sunshade does not tilt. To avoid damaging the sunshade, do not push it up.
- Do not close the sunshade while the panorama sunroof is opening. Trying to force the sunshade closed could damage it.

## How to Use the Panorama Sunroof

### Operating the Sunshade

The sunshade can be opened or closed electrically only.

1. Switch the vehicle power ON.
2. Press the tilt/slide switch rearward.  
The sunshade opens.



3. Press the tilt/slide switch forward.  
The sunshade closes.



To stop it partway, operate the switch in the direction opposite to the direction it is opening/closing.



### Tilt Operation

The panorama sunroof can be opened or closed electrically only.

1. Press the tilt/slide switch.

The rear side of the front glass panel of the panorama sunroof opens upwards.



2. Press the tilt/slide switch forward 2 times.

The sunshade and the panorama sunroof close.



To stop it partway, operate the switch in the direction opposite to the direction it is opening/closing.

### Slide Operation

1. Open the sunshade.
2. Press the tilt/slide switch rearward. The panorama sunroof opens.



3. Press the tilt/slide switch forward. The panorama sunroof closes.



To stop it partway, operate the switch in the direction opposite to the direction it is opening/closing.

## Moonroof\*

The moonroof can be opened or closed when operating the overhead tilt/slide switch at the front seats.

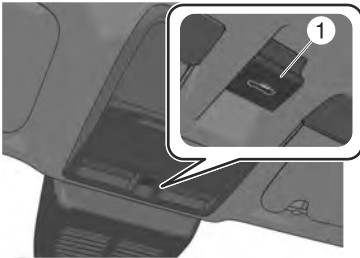

1. Tilt/slide switch

### Jam-safe function

If foreign matter caught between the moonroof and the window frame is detected while it is closing automatically, the moonroof stops and opens partway.

### **NOTE**

- Before leaving the vehicle or washing your Mazda, make sure the moonroof is completely closed so that water does not get inside the cabin area.
- After washing your Mazda or after it rains, wipe the water off the moonroof before operating it to avoid water penetration which could cause rust and water damage to your headliner.
- The jam-safe function may operate under the following conditions.
  - A strong impact is detected while the moonroof is closing automatically.
  - The moonroof is closing automatically during very low temperatures.

- In the event the jam-safe function activates and the moonroof cannot be closed automatically, press the tilt/slide switch and the moonroof will close.
- When the jam-safe function is inoperable, the moonroof initial setting is not performed. Refer to Initializing the moonroof on page 8-32.

## Warnings and Cautions for Using the Moonroof

### **WARNING**

**Do not let passengers stand up or extend part of the body through the open moonroof while the vehicle is moving.**

Extending the head, arms, or other parts of the body through the moonroof is dangerous. The head or arms could hit something while the vehicle is moving. This could cause serious injury or death.

**Never allow children to play with the tilt/slide switch.**

The tilt/slide switch would allow children to operate the moonroof unintentionally, which could result in serious injury if a child's hands, head or neck becomes caught by the moonroof.

**Make sure the opening is clear before closing the moonroof.**

A closing moonroof is dangerous. The hands, head, or even neck of a person, especially a child, could be caught in it as it closes, causing serious injury or even death.

**Make sure nothing blocks the moonroof just before it reaches the fully closed position.**

Blocking the moonroof just before it reaches the closed position is dangerous.

In this case, the jam-safe function cannot prevent the moonroof from closing. If fingers are caught, serious injuries could occur.

### **CAUTION**

- Do not sit on or put heavy items on the area where the moonroof opens and closes. Otherwise, the moonroof could be damaged.
- Do not open or close the moonroof forcefully during freezing temperatures or snowfall. Otherwise, the moonroof could be damaged.
- The sunshade does not tilt. To avoid damaging the sunshade, do not push it up.
- Do not close the sunshade while the moonroof is opening. Trying to force the sunshade closed could damage it.

## How to Use the Moonroof

### Operating the Sunshade

The sunshade can be opened and closed by hand.  
The sunshade opens at the same time as the moonroof slides open, but it must be closed by hand.

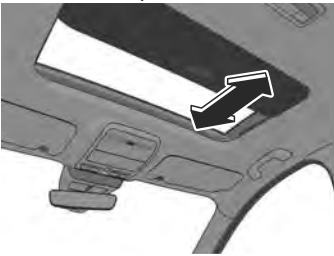

### Tilt Operation

The rear of the moonroof can be tilted open to provide more ventilation. When the moonroof is already slid open and you want to tilt it open, first close the moonroof and then do a tilt operation.

1. Switch the vehicle power ON.
2. Press the tilt/slide switch.

The rear side of the front glass panel of the moonroof opens upwards.

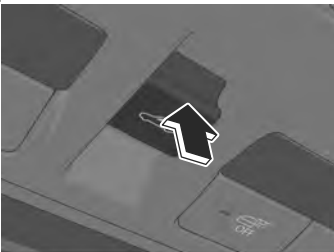

3. Press the tilt/slide switch forward.

The moonroof closes.



To stop it partway, press the tilt/slide switch.

### Slide Operation

When the moonroof is already tilted open and you want to slide it open, first close the moonroof and then do a slide operation.

1. Switch the vehicle power ON.
2. Press the tilt/slide switch rearward. The moonroof opens.



3. Press the tilt/slide switch forward. The moonroof closes.



To stop it partway, press the tilt/slide switch.

## Security System

Mazda cannot guarantee the immobilizer and the theft-deterrent system's operation if the system has been modified or if any add-on equipment has been installed.

## Warnings and Cautions for Using the Security System

 **CAUTION**

To avoid damage to the vehicle, do not modify the system or install any add-on equipment to the immobilizer and the theft-deterrent systems or the vehicle.

## Immobilizer System

The immobilizer system allows the engine to start only with a key the system recognizes.

### NOTE

- The keys carry a unique electronic code. For this reason, and to assure your safety, obtaining a replacement key requires security validation, this will add some delays in supplying a replacement key. They are only available through an Authorized Mazda Dealer.
- Always keep a spare key in case one is lost. If a key is lost, consult an Authorized Mazda Dealer as soon as possible.
- If you lose a key, an Authorized Mazda Dealer will reset the electronic codes of your remaining keys and immobilizer system. Bring all the remaining keys to an Authorized Mazda Dealer to reset.

## Warnings and Cautions for Using the Immobilizer System

### CAUTION

- Radio equipment like this is governed by laws in the United States. Changes or modifications not expressly approved by the party responsible for compliance could void the user's authority to operate the equipment.
- To avoid damage to the key, do not:
  - Drop the key.
  - Get the key wet.
  - Expose the key to any kind of magnetic field.
  - Expose the key to high temperatures on places such as the dashboard, under direct sunlight.
- If the engine does not start with the correct key, and the security indicator light keeps illuminating or flashing, the system may have a malfunction. Consult an Authorized Mazda Dealer.

## How to Use the Immobilizer System

### NOTE

- The engine may not start and security indicator light may illuminate or flash if the key is placed in an area where it is difficult for the system to detect the signal, such as on the dashboard or in the glove compartment. Move the key to a location within the signal range, switch the vehicle power off, and then restart the engine.
- Signals from a TV or radio station, or from a transceiver or mobile telephone could interfere with your immobilizer system. If you are using the proper key and the engine fails to start, check the security indicator light.

### Arming

The system is armed when the vehicle power is switched from ON to off.

The security indicator light  in the instrument cluster flashes every 2 seconds until the system is disarmed.

### Disarming

The system is disarmed when the vehicle power is switched ON with the correct programmed key. The security

indicator light  illuminates for about 3 seconds and then turns off.

If the engine does not start with the correct key, and the security indicator light remains illuminated or flashing, try the following:

Make sure the key is within the operational range for signal transmission. Switch the vehicle power off, and then restart the engine. If the engine does not start after 3 or more

tries, contact an Authorized Mazda Dealer.

## Theft-Deterrent System\*

If the theft-deterrent system detects an inappropriate entry into the vehicle, which could result in the vehicle or its contents being stolen, the alarm alerts the surrounding area of an abnormality by sounding the horn and flashing the hazard warning lights.

The system will not function unless it's properly armed. So when you leave the vehicle, follow the arming procedure correctly.

## How to Use the Theft-Deterrent System

### How to Arm the System

1. Close the windows and the panorama sunroof/moonroof<sup>\*</sup> securely.
2. Switch the vehicle power OFF.
3. Make sure the hood, the doors, and the liftgate are closed.
4. Press the lock button on the transmitter. The hazard warning lights will flash once.

The following method will also arm the theft-deterrent system:

Press the door-lock switch  while any door is open and then close all of the doors.

#### **(With the advanced keyless function)**

Touch the sensing area of the door lock touch sensor.

The security indicator light  in the instrument cluster flashes twice per second for 20 seconds.

5. After 20 seconds, the system is fully armed.

### **NOTE**

- The theft-deterrent system can also be armed by activating the auto relock function with all the doors, the liftgate and the hood closed. Refer to How to Use the Key on page 4-5.
- The system will disarm if one of the following operations takes place within 20 seconds after pressing the lock button:
  - Unlocking any door.
  - Opening any door.
  - Opening the hood.
  - Switching the vehicle power ON.



To rearm the system, do the arming procedure again.

- When the doors are locked by pressing the lock button on the key while the theft-deterrent system is armed, the hazard warning lights will flash once to indicate that the system is armed.

## Operation

### **Horn triggering conditions**

The horn sounds intermittently and the hazard warning lights flash for about 30 seconds when the system is triggered by any one of the following:

- Unlocking a door with the auxiliary key, door lock switch, or an inside door-lock knob.
- Forcing open a door, the hood or the liftgate.
- Opening the hood by operating the hood release handle.
- Switching the vehicle power ON without using the push button start.

If the system is triggered again, the lights and horn will activate until the driver's door or the liftgate is unlocked with the key.

### **(With the advanced keyless function)**

The lights and horn can also be deactivated by touching the sensing area of the door release touch sensor.

### **NOTE**

- The liftgate does not open while the theft-deterrent system is operating.
- If the lead-acid battery goes dead while the theft-deterrent system is armed, the horn will activate and the hazard warning lights will flash when the lead-acid battery is charged or replaced.

## To Stop the Alarm

A triggered alarm can be turned off using any one of the following methods:

- Pressing the unlock button on the key.
- Starting the engine with the push button start.
- **(With the advanced keyless function)**
  - Touching the sensing area of the door release touch sensor.
  - Pressing the electric liftgate opener while the key is being carried.

The hazard warning lights will flash twice.

## To Turn Off an Armed System

An armed system can be turned off using any one of the following methods:

- Pressing the unlock button on the key.
- Starting the engine with the push button start.
- **(With the advanced keyless function)**
  - Touching the sensing area of the door release touch sensor.

The hazard warning lights will flash twice.

### **NOTE**

When the doors are unlocked by pressing the unlock button on the key while the theft-deterrent system is turned off, the hazard warning lights will flash twice to indicate that the system is turned off.

## Rear Seat Alert\*

The Rear Seat Alert is a system that reminds the driver to check if any occupants or luggage have been left behind on the rear seats.

The Rear Seat Alert determines if there is the possibility that occupants or luggage are on rear seats based on the opening and closing history of the rear doors. For this reason, the system may operate differently from the actual conditions, such as it is not activated even if occupants or luggage are occupying a rear seat.

## Warnings and Cautions for Using the Rear Seat Alert

### **WARNING**

**Do not rely completely on the system.** The Rear Seat Alert is not a system that detects occupants and luggage using sensors. Over reliance on the system could lead to an accident. When leaving the vehicle, always visually check the conditions of the rear seats.

## How to Use the Rear Seat Alert

If any of the following operations is performed, a message appears in the instrument cluster to notify that the system is active. Make sure that a message appears. The message disappears after a short period of time. When the Rear Seat Alert is not needed, temporarily deactivate the system according to the message.

- A rear door is opened and the engine is started.
- The engine is started within about 10 minutes after a rear door is opened and closed.
- A rear door is opened after the engine is started.
- The vehicle power is switched ON while the system is active.

If the vehicle power is switched OFF while the system is active, a message in the instrument cluster and a warning sound indicate the possibility of occupants or luggage on a rear seat. The message disappears after a short period of time.

If the driver's door is opened/closed after the message in the instrument cluster disappears, notification is made again.

When deactivating the system, perform any of the following operations.

- Switch the vehicle power to ACC or OFF and open a rear door.
- Switch the vehicle power ON again and open a rear door before starting the engine.
- Open a rear door and switch the vehicle power to ACC or OFF.

- Temporarily deactivate the system according to the message in the instrument cluster.

### NOTE

The Rear Seat Alert determines if there is the possibility that occupants or luggage are on a rear seat based on the opening and closing history of the rear doors. For this reason, depending on the usage, it may not be activated even if occupants or luggage are on the rear seats, or it may activate even if no occupants or luggage are on the rear seats. The system will continue to be active until it is canceled.

### Examples of when the system does not activate even if occupants or luggage are on the rear seats.

- A rear door is opened and closed in a very short period of time.
- Remote engine starting via Connected Service is used\*.
- The lead-acid battery charge is low.
- The lead-acid battery connection was disconnected/connected.

### Examples of when the system activates even if no occupants or luggage are on the rear seats.

- A rear door is opened and closed, but no occupant or luggage is in the vehicle.
- Occupants and luggage are unloaded while the engine is running.
- A rear door is opened and closed in a very short period of time.

### Temporarily Deactivating the Rear Seat Alert

When the instrument cluster displays a message concerning the Rear Seat Alert, the driver can temporarily deactivate the system.

Operate according to the message displayed in the instrument cluster. When the message "Press and Hold INFO Switch to Deactivate Rear Seat Alert" is displayed in the instrument cluster, press and hold the INFO switch for 2 seconds or longer.

When the system is temporarily deactivated, a chime sounds and a message to notify that the operation was completed appears in the instrument cluster. The message disappears after a short period of time.

**NOTE**

When the vehicle power is switched OFF, the temporary deactivation is canceled.

**Turning the Rear Seat Alert Off**

The Rear Seat Alert can be set to off using Mazda Connect. Refer to Mazda Connect Owner's Manual or consult an Authorized Mazda Dealer.

**NOTE**

Under the following conditions, the warning light  turns on 2 times to indicate the system has been stopped when the vehicle power is switched ON, and then turns off after a short period of time.

- The Rear Seat Alert is turned off.
- The Rear Seat Alert is temporarily deactivated.
- Remote engine starting via Connected Service is used\*.
- The lead-acid battery charge is low.

# MEMO

# 5

## Driving

<b>Mirrors.....</b>	<b>5-8</b>
Mirrors.....	5-8
Warnings and Cautions for Using the Mirrors.....	5-8
How to Use the Outside Mirrors.....	5-9
Convenient Ways to Use the Outside Mirrors.....	5-10
Warnings and Cautions for the Rearview Mirror.....	5-11
How to Use the Rearview Mirror.....	5-12
Convenient Ways to Use the Rearview Mirror.....	5-12
<b>Push Button Start.....</b>	<b>5-13</b>
Push Button Start.....	5-13
Warning and Cautions for Using the Push Button Start.....	5-13
How to Use the Push Button Start.....	5-14
<b>M Hybrid Boost.....</b>	<b>5-16</b>
M Hybrid Boost.....	5-16
Warning and Cautions for Using the M Hybrid Boost.....	5-17
How to Use the M Hybrid Boost.....	5-20
<b>i-stop.....</b>	<b>5-21</b>
i-stop.....	5-21
How to Use the i-stop.....	5-21
<b>Instrument Cluster (Type A).....</b>	<b>5-23</b>
Instrument Cluster.....	5-23

How to Use the Instrument Cluster.....	5-24
Convenient Ways to Use the Instrument Cluster.....	5-27
Speedometer.....	5-27
Tachometer.....	5-28
Odometer/Trip Meter.....	5-28
How to Use the Odometer/Trip Meter.....	5-29
Engine Coolant Temperature Gauge.....	5-29
Fuel Gauge.....	5-30
Dashboard Illumination.....	5-30
How to Use the Dashboard Illumination.....	5-31
Outside Temperature Display.....	5-32
Maximum Driving Distance Display.....	5-32
Average Fuel Economy Display.....	5-33
How to Use the Average Fuel Economy Display.....	5-33
Instantaneous Fuel Economy Display.....	5-34
Deceleration Regeneration Charge Display.....	5-34
i-ACTIVSENSE Status Symbol (Warning/Risk Avoidance Support System).....	5-35
Compass Display.....	5-35
Message Display.....	5-36
<b>Instrument Cluster (Type B).....</b>	<b>5-37</b>
Instrument Cluster.....	5-37
Speedometer.....	5-37

Tachometer.....	5-38	<b>Selector Lever.....</b>	<b>5-53</b>
Multi-information Display....	5-39	Warning and Cautions for Using the Selector Lever.....	5-53
How to Use the Multi- information Display.....	5-40	How to Use the Selector Lever.....	5-54
Convenient Ways to Use the Multi-information Display....	5-41	Convenient Ways to Use the Selector Lever.....	5-56
Odometer/Trip Meter.....	5-41		
How to Use the Odometer/Trip Meter.....	5-42	<b>Steering Shift Switches.....</b>	<b>5-58</b>
Engine Coolant Temperature Gauge.....	5-42	Warnings and Cautions for Using the Steering Shift Switches .....	5-58
Fuel Gauge.....	5-43	.....	5-58
Dashboard Illumination.....	5-43	How to Use the Steering Shift Switches* .....	5-59
How to Use the Dashboard Illumination.....	5-44	Convenient Ways to Use the Steering Shift Switches.....	5-63
Outside Temperature Display.....	5-45		
Maximum Driving Distance Display.....	5-45	<b>Foot Brake.....</b>	<b>5-64</b>
Average Fuel Economy Display.....	5-46	Warning and Cautions for Using the Foot Brake.....	5-64
How to Use the Average Fuel Economy Display.....	5-46		
Instantaneous Fuel Economy Display.....	5-47	<b>Electric Parking Brake (EPB).....</b>	<b>5-65</b>
Deceleration Regeneration Charge Display.....	5-47	Electric Parking Brake (EPB) .....	5-65
i-ACTIVSENSE Display.....	5-48	.....	5-65
Compass Display.....	5-48	Warning and Cautions for Using the Electric Parking Brake (EPB).....	5-65
Message Display.....	5-49	How to Use the Electric Parking Brake (EPB).....	5-66
		Convenient Ways to Use the Electric Parking Brake (EPB) .....	5-67
		.....	5-67
<b>Active Driving Display.....</b>	<b>5-50</b>	<b>Brake Override System.....</b>	<b>5-69</b>
Active Driving Display* .....	5-50	Brake Override System.....	5-69
Warnings and Cautions for Using the Active Driving Display....	5-51	Warning and Cautions for Using the Brake Override System .....	5-69
Convenient Ways to Use the Active Driving Display.....	5-52	.....	5-69

---

How to Use the Brake Override System.....	5-70
<b>AUTOHOLD.....</b>	<b>5-71</b>
AUTOHOLD.....	5-71
Warning and Cautions for Using the AUTOHOLD.....	5-71
How to Use the AUTOHOLD.....	5-72
<b>Hill Launch Assist (HLA).....</b>	<b>5-74</b>
Hill Launch Assist (HLA).....	5-74
Warning and Cautions for Using the Hill Launch Assist (HLA).....	5-74
<b>Light Switch.....</b>	<b>5-75</b>
Light Switch.....	5-75
Warnings and Cautions for Using the Light Switch.....	5-75
How to Use the Light Switch.....	5-76
Convenient Ways to Use the Light Switch.....	5-78
<b>Turn Signal lever.....</b>	<b>5-80</b>
How to Use the Turn Signal Lever.....	5-80
<b>Windshield Wiper/Washer Switch.....</b>	<b>5-81</b>
Windshield Wiper/Washer Switch.....	5-81
Warning and Cautions for Using the Windshield Wiper/Washer Switch.....	5-81
How to Use the Windshield Wiper/Washer Switch.....	5-82

How to Use the Rear Wiper/Washer Switch.....	5-84
<b>Rear Window Defogger Switch.....</b>	<b>5-86</b>
Rear Window Defogger Switch.....	5-86
Warnings and Cautions for Using the Rear Window Defogger Switch.....	5-86
How to Use the Rear Window Defogger Switch.....	5-87
Mirror Defogger*.....	5-87
How to Use the Mirror Defogger.....	5-88
Windshield Wiper De-icer*.....	5-88
How to Use the Windshield Wiper De-icer.....	5-89
<b>Hazard Warning Lights.....</b>	<b>5-90</b>
Hazard Warning Lights.....	5-90
How to Use the Hazard Warning Lights.....	5-90
<b>Horn.....</b>	<b>5-91</b>
How to Use the Horn.....	5-91
<b>Antilock Brake System (ABS).....</b>	<b>5-92</b>
Antilock Brake System (ABS).....	5-92
Warning and Cautions for Using the Antilock Brake System (ABS).....	5-92
<b>Traction Control System (TCS).....</b>	<b>5-93</b>
Traction Control System (TCS).....	5-93



Warning and Cautions for Using the Traction Control System (TCS)..... 5-93  
 How to Use the Traction Control System (TCS)..... 5-94

**Dynamic Stability Control (DSC)..... 5-95**  
 Dynamic Stability Control (DSC)..... 5-95  
 Warning and Cautions for Using the Dynamic Stability Control (DSC)..... 5-95  
 How to Use the Dynamic Stability Control (DSC)..... 5-96

**Trailer Stability Control (TSC) ..... 5-97**  
 Trailer Stability Control (TSC)..... 5-97  
 Warning and Cautions for Using the Trailer Stability Control (TSC)..... 5-97  
 How to Use the Trailer Stability Control (TSC)..... 5-98

**Hill Descent Control.....5-99**  
 Hill Descent Control\*..... 5-99  
 Warnings and Cautions for Using the Hill Descent Control..... 5-99  
 How to Use the Hill Descent Control..... 5-100

**Mazda intelligent Drive Select (Mi-Drive)..... 5-102**  
 Mazda intelligent Drive Select (Mi-Drive)..... 5-102

Warning and Cautions for Using the Mazda intelligent Drive Select (Mi-Drive)..... 5-102  
 How to Use the Mazda intelligent Drive Select (Mi-Drive)..... 5-103

**i-ACTIV AWD..... 5-105**  
 i-ACTIV AWD..... 5-105  
 Warnings and Cautions for Using the i-ACTIV AWD..... 5-105

**Power Steering..... 5-106**  
 Power Steering..... 5-106

**Tire Pressure Monitoring System (TPMS)..... 5-107**  
 Tire Pressure Monitoring System (TPMS)..... 5-107  
 Warning and Cautions for Using the Tire Pressure Monitoring System (TPMS)..... 5-107  
 How to Use the Tire Pressure Monitoring System (TPMS) ..... 5-109

**Refueling..... 5-111**  
 Warnings and Cautions for When the Refueling..... 5-111  
 Refueling..... 5-112  
 Fuel Requirements..... 5-114  
 Warnings and Cautions for Using the Fuel Requirements..... 5-116  
 Emission Control System.... 5-116  
 Warnings and Cautions for Using the Emission Control System..... 5-117  
 Warnings and Cautions for Engine Exhaust (Carbon monoxide)..... 5-117

<b>i-ACTIVSENSE.....</b>	<b>5-119</b>
i-ACTIVSENSE.....	5-119
Warnings and Cautions for Using the i-ACTIVSENSE.....	5-119
Active Safety Technology....	5-120
Pre-crash Safety Technology.....	5-121
i-ACTIVSENSE Status Symbol (Warning/Risk Avoidance Support System).....	5-121
How to Use the i-ACTIVSENSE mute switch*.....	5-124
<b>Forward Sensing Camera (FSC).....</b>	<b>5-125</b>
Forward Sensing Camera (FSC).....	5-125
<b>Radar Sensors.....</b>	<b>5-129</b>
Radar Sensors.....	5-129
<b>Ultrasonic Sensors.....</b>	<b>5-133</b>
Ultrasonic Sensors*.....	5-133
<b>Cameras.....</b>	<b>5-135</b>
Cameras.....	5-135
<b>Driver Monitoring Camera.....</b>	<b>5-137</b>
Driver Monitoring Camera*.....	5-137
<b>Adaptive Front Lighting System (AFS).....</b>	<b>5-138</b>
Adaptive Front Lighting System (AFS).....	5-138
How to Use the High Adaptive Front Lighting System (AFS).....	5-138

<b>High Beam Control System (HBC).....</b>	<b>5-139</b>
High Beam Control System (HBC).....	5-139
Warnings and Cautions for Using the High Beam Control System (HBC).....	5-140
How to Use the High Beam Control System (HBC).....	5-141
<b>Lane Departure Warning System (LDWS).....</b>	<b>5-143</b>
Lane Departure Warning System (LDWS).....	5-143
Warnings and Cautions for Using the Lane Departure Warning System (LDWS).....	5-143
How to Use the Lane Departure Warning System (LDWS).....	5-144
<b>Blind Spot Monitoring (BSM)..</b>	<b>5-146</b>
Blind Spot Monitoring (BSM).....	5-146
Warnings and Cautions for Using the Blind Spot Monitoring (BSM).....	5-146
How to Use the Blind Spot Monitoring (BSM).....	5-147
<b>Traffic Sign Recognition System (TSR).....</b>	<b>5-151</b>
Traffic Sign Recognition System (TSR)*.....	5-151
Warnings and Cautions for Using the Traffic Sign Recognition System (TSR).....	5-151
How to Use the Traffic Sign Recognition System (TSR)...	5-152

Convenient Ways to Use the Traffic Sign Recognition System (TSR).....	5-153		How to Use the Front Cross Traffic Alert (FCTA).....	5-165
<b>Distance &amp; Speed Alert (DSA) .....</b>	<b>5-154</b>		<b>Rear Cross Traffic Alert (RCTA) .....</b>	<b>5-167</b>
Distance & Speed Alert (DSA).....	5-154		Rear Cross Traffic Alert (RCTA).....	5-167
Warnings and Cautions for Using the Distance & Speed Alert (DSA).....	5-154		Warnings and Cautions for Using the Rear Cross Traffic Alert (RCTA).....	5-167
How to Use the Distance & Speed Alert (DSA).....	5-155		How to Use the Rear Cross Traffic Alert (RCTA).....	5-168
<b>Driver Attention Alert (DAA)...</b>	<b>5-156</b>		<b>Mazda Radar Cruise Control (MRCC).....</b>	<b>5-169</b>
Driver Attention Alert (DAA).....	5-156		Mazda Radar Cruise Control (MRCC).....	5-169
Warnings and Cautions for Using the Driver Attention Alert (DAA).....	5-156		Warnings and Cautions for Using the Mazda Radar Cruise Control (MRCC).....	5-169
How to Use the Driver Attention Alert (DAA).....	5-157		How to Use the Mazda Radar Cruise Control (MRCC).....	5-171
<b>Driver Monitoring (DM).....</b>	<b>5-159</b>		<b>Cruising &amp; Traffic Support (CTS).....</b>	<b>5-182</b>
Driver Monitoring (DM)* ...	5-159		Cruising & Traffic Support (CTS)* .....	5-182
Warnings and Cautions for Using the Driver Monitoring (DM).....	5-160		Warnings and Cautions for Using Cruising & Traffic Support (CTS).....	5-182
How to Use the Driver Monitoring (DM).....	5-161		How to Use the Cruising & Traffic Support (CTS).....	5-184
<b>Front Cross Traffic Alert (FCTA) .....</b>	<b>5-164</b>		<b>Lane-keep Assist System (LAS).....</b>	<b>5-204</b>
Front Cross Traffic Alert (FCTA)* .....	5-164		Lane-keep Assist System (LAS).....	5-204
Warnings and Cautions for Using the Front Cross Traffic Alert (FCTA).....	5-164			

Warnings and Cautions for Using the Lane-keep Assist System (LAS).....	5-204	Warnings and Cautions for Using the Secondary Collision Reduction.....	5-244
How to Use the Lane-keep Assist System (LAS).....	5-205	How to Use the Secondary Collision Reduction.....	5-245
<b>Emergency Lane Keeping (ELK).....</b>	<b>5-207</b>	<b>Cruise Control.....</b>	<b>5-246</b>
Emergency Lane Keeping (ELK).....	5-207	Cruise Control*.....	5-246
Warnings and Cautions for Using the Emergency Lane Keeping (ELK).....	5-208	Warnings and Cautions for Using the Cruise Control.....	5-246
How to Use the Emergency Lane Keeping (ELK).....	5-209	How to Use the Cruise Control.....	5-247
<b>Smart Brake Support (SBS).....</b>	<b>5-214</b>	<b>Rear View Monitor.....</b>	<b>5-250</b>
Smart Brake Support (SBS).....	5-214	Rear View Monitor*.....	5-250
Warnings and Cautions for Using the Smart Brake Support (SBS).....	5-216	Warnings and Cautions for Using the Rear View Monitor.....	5-252
How to Use the Smart Brake Support (SBS).....	5-217	How to Use the Rear View Monitor.....	5-253
<b>360° View Monitor.....</b>	<b>5-224</b>	<b>Parking Sensor.....</b>	<b>5-258</b>
360° View Monitor*.....	5-224	Parking Sensor*.....	5-258
Warnings and Cautions for Using the 360° View Monitor.....	5-229	Warnings and Cautions for Using the Parking Sensor.....	5-258
How to Use the 360° View Monitor.....	5-231	How to Use the Parking Sensor.....	5-259
Convenient Ways to Use the 360° View Monitor.....	5-243	<b>Winter Driving.....</b>	<b>5-264</b>
<b>Secondary Collision Reduction.....</b>	<b>5-244</b>	Winter Driving.....	5-264
Secondary Collision Reduction.....	5-244	Snow Tires.....	5-265
		Tire Chains.....	5-266
		<b>Turbocharger.....</b>	<b>5-267</b>
		Turbocharger.....	5-267
		Warnings and Cautions for Using the Turbocharger.....	5-267
		How to Use the Turbocharger.....	5-268

## Mirrors

Before driving, adjust the inside and outside mirrors.

## Warnings and Cautions for Using the Mirrors

### **WARNING**

**Be sure to look over your shoulder before changing lanes.**

Changing lanes without taking into account the actual distance of a vehicle in the convex mirror is dangerous. You could have a serious accident. What you see in the convex mirror is closer than it appears.

**Always return the outside mirrors to the driving position before you start driving.**

Driving with the outside mirrors folded in is dangerous. Your rear view will be restricted, which could lead to an unexpected accident.

**(Vehicles with electric retractable mirrors)**

**Do not touch the outside mirrors while they are folding in and out.**

Touching an outside mirror while it is folding in or out is dangerous. Your hands could get caught which could cause an injury or the door mirror could be damaged.

**Use the switch to set the outside mirrors.**

Setting the outside mirrors manually is dangerous. The outside mirrors will not lock into place, which could obstruct visibility.

**Always operate the electric retractable mirrors with the vehicle parked in a safe place.**

Operating the electric retractable mirrors while driving is dangerous. Wind pressure could damage the outside mirrors, making it impossible to return them to the driving position and to see behind you.

**Do not adjust the outside mirrors while driving the vehicle.**

Adjusting the outside mirrors while driving the vehicle is dangerous as doing so could distract your attention from the road ahead and lead to an accident.



**(Vehicles with electric retractable mirrors)**

Operate the folding switch to fold in or out the outside mirrors. If you unfold the outside mirrors manually, they will not be in a secured position and you will be unable to check the view to the rear of the vehicle.

## How to Use the Outside Mirrors

### Folding in and out the outside mirrors

#### Manual type

Fold the outside mirror rearward until it is flush with the vehicle.

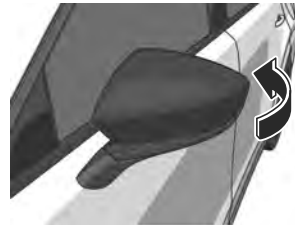

#### Electric type

1. Switch the vehicle power ACC or ON.
2. Press the folding mirror button to fold the mirror in. Press again to fold out.

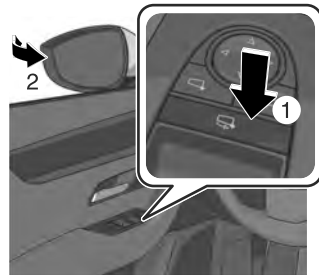

### Adjusting the Outside Mirror Angle

1. Switch the vehicle power ACC or ON.
2. Press the select button on the side of the outside mirror to be adjusted.

The indicator light turns on.

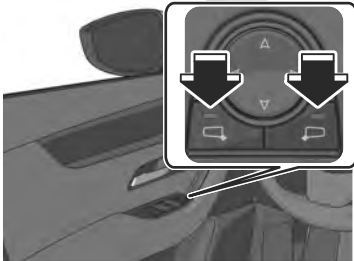

3. Press the adjustment switch to adjust the angle of the outside mirror.

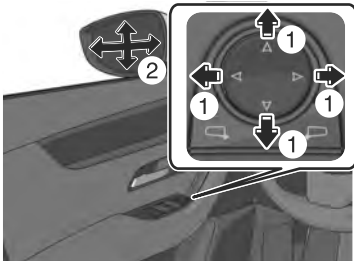

4. Press the select button on the side of the outside mirror that has been adjusted.  
The indicator light turns off.

## Convenient Ways to Use the Outside Mirrors

### Driving Position Memory\*

The angle of the outside mirrors can be programmed to the Driving Position Memory.

Refer to Driving Position Memory on page 3-36.

### Auto fold function\*

When locking/unlocking the doors while the vehicle power is switched OFF, the outside mirrors automatically fold in and out.

When the outside mirrors are folded in and the vehicle power is switched ON, or the engine is started, the outside mirrors fold out automatically.

Turn the auto fold function on using the center display.

Refer to Settings section in the Mazda Connect Owner's Manual or consult an Authorized Mazda Dealer.

### Operation function after engine is stopped

The angle of the outside mirrors can be adjusted and they can be folded in and out for about 40 seconds after the vehicle power is switched from ON or ACC to OFF.

### Auto tilt-down outside mirror function for reversing\*

The outside mirrors can be set to tilt downwards automatically when reversing the vehicle. When the vehicle is finished reversing, the outside mirrors return to their original angle.

1. Press the select switch on the side of the door mirror to be tilted down.

Turn on the indicator light of the select switch.

2. Shift the selector lever to the R position.  
The outside mirror on the side where you pressed the select switch will tilt downward.

**NOTE**

When any of the following condition is met, the outer mirrors return to their normal positions.

- The vehicle power is switched to a position other than ON.
- The shift selector lever is shifted to a position other than R.
- The select switch is pressed again.

**Automatic glare prevention function \***

In conjunction with the glare prevention function of the auto-type rearview mirror, only the driver's side outside mirror reduces the light from the headlights of on-coming vehicles.

**Warnings and Cautions  
for the Rearview Mirror**

** WARNING**

**Do not stack luggage higher than the seatback.**

Loading luggage higher than the seatback is dangerous. The rearview mirror visibility may be obstructed, which may result in a collision with another vehicle when changing lanes.



## How to Use the Rearview Mirror

Move and adjust the rearview mirror body.

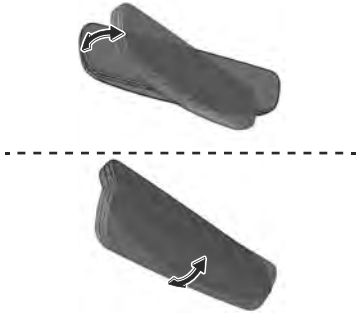

## Convenient Ways to Use the Rearview Mirror

### Glare prevention function

Prevents glare from the headlights of rear on-coming vehicles.

#### **Manual type**

Push the day/night lever forward for day driving. Pull it back to reduce glare of headlights from vehicles at the rear.



#### **Automatic type**

Automatically operates when the vehicle power is switched ON and the selector lever is in a position other than R.

## Push Button Start

Press the push button start to start/stop the engine or to switch the vehicle power position (OFF/ACC/ON).



### Vehicle power position

#### **OFF**

All electrical accessories cannot be used.

#### **ACC**

Some electrical accessories such as audio can be used.

#### **ON**

All electrical accessories can be used.

## Warning and Cautions for Using the Push Button Start

### **! WARNING**

**Before leaving the driver's seat, always switch the vehicle power off, set the parking brake, and make sure the selector lever is in the P position.** Leaving the driver's seat without switching the vehicle power off, setting the parking brake, and shifting the selector lever to the P position is dangerous. Unexpected vehicle movement could occur which could result in an accident. In addition, if your intention is to leave the vehicle for even a short period, it is important to switch the vehicle power position to OFF, as leaving it in another position will disable some of the vehicle's security systems and run the lead-acid battery down.

**Radio waves from the key may affect medical devices such as pacemakers.** Before using the key near people who use medical devices, ask the medical device manufacturer or your physician if radio waves from the key will affect the device.

**Other than for an emergency situation, do not attempt to stop the engine while driving the vehicle.** If the engine is stopped while driving the vehicle, loss of brake power and power steering functions could occur, making it difficult to control the vehicle which could result in an accident.

## CAUTION

- If the KEY warning light (red)  is displayed, or the push button start indicator light (amber) flashes, this could indicate a problem with the engine starting system. This may prevent the engine from starting or from switching the vehicle power position to ACC or ON. Have your vehicle inspected at an Authorized Mazda Dealer as soon as possible. Refer to KEY Warning Light (Red) on page 8-46.
- Before leaving the vehicle, make sure that the vehicle power is switched OFF.

## How to Use the Push Button Start

The push button start starts/stops the engine and switches the vehicle power position depending on the vehicle status and the driver's operation.

### Starting the Engine

1. Make sure that the parking brake is applied.
2. Make sure that the selector lever is in the P position.
3. Depress the brake pedal.  
The push button start indicator light (green) and the KEY indicator light (green)  in the instrument cluster turn on.
- 4.

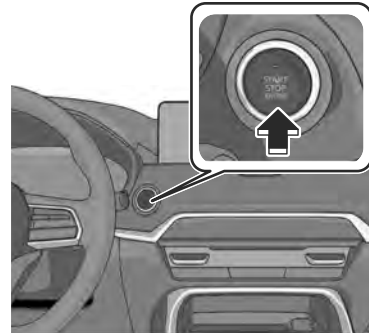

The engine starts and the KEY indicator light (green)  in the instrument cluster turns off.

The READY indicator light **READY** in the instrument cluster turns on.

### **NOTE**

Do not use high engine speeds until reaching the operating temperature.

### Stopping The Engine

1. Stop the vehicle.
2. Shift the selector lever to the P position.

3.

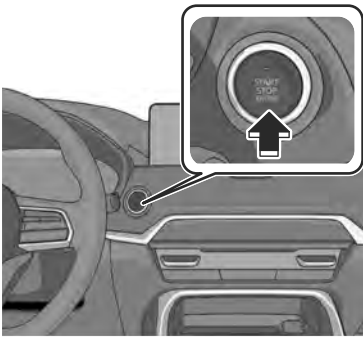

The engine stops and the vehicle power is switched OFF.

The READY indicator light **READY** in the instrument cluster turns off.

**NOTE**

If the engine is turned off while the selector lever is in a position other than P, the AUTO P (parking lock) function operates and the vehicle power is switched OFF. For safety, shift the selector lever to the P position and switch the vehicle power OFF.

**Switching the Vehicle power Position**

Press the push button start without depressing the brake pedal. Each time the push button start is pressed, the vehicle power position is switched in the order of ACC, ON, and OFF.

When the vehicle power is switched to ACC, the push button start indicator light (amber) turns on.

When the vehicle power is switched OFF and a door is opened/closed or locked, the push button start indicator light (amber) turns off.

**NOTE**

If you leave the vehicle power switched to ACC, the vehicle power is switched OFF in about 25 minutes.

## M Hybrid Boost

M Hybrid Boost is a system that improves driving performance and fuel economy by assisting the engine with the motor and charging with regenerative braking according to the driving conditions of the vehicle. Because the M Hybrid Boost Battery charges the vehicle while driving, charging from outside of the vehicle is not necessary.

## Warning and Cautions for Using the M Hybrid Boost

### **⚠ WARNING**

**Do not touch the high temperature or high current areas.**

The following areas are high temperature and high current and may cause serious burns and electrical shock if touched.

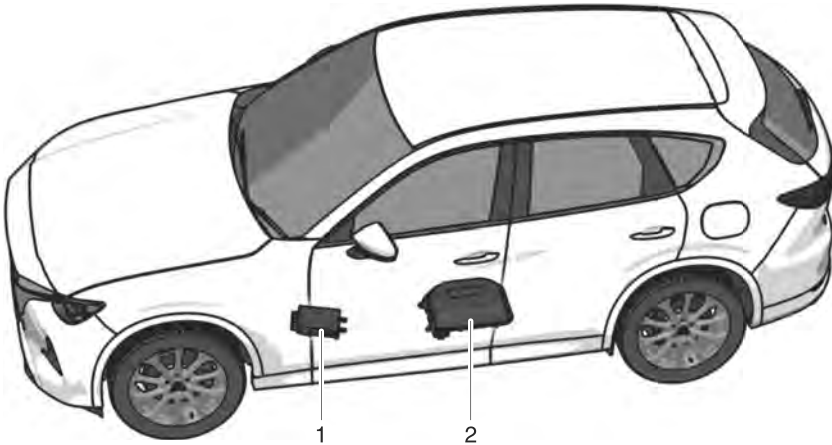

1. DC-DC converter
2. M Hybrid Boost Battery

**To reduce the risk of burns or electrical shock, always heed the following precautions.**

- Never remove and disassemble the brackets and connectors securing the terminal part, wiring harness, and the M Hybrid Boost Battery.
- Never touch the M Hybrid Boost Battery because it becomes extremely hot under direct sunlight or after driving.
- Never touch the M Hybrid Boost Battery when it is wet because it is especially dangerous.

**To ensure safe and correct handling of the M Hybrid Boost Battery, always heed the following.**

- Do not remove the M Hybrid Boost Battery.
- Do not resell, transfer, or modify the M Hybrid Boost Battery.
- Do not make secondary use of the M Hybrid Boost Battery.

**If the M Hybrid Boost Battery is not handled properly, the following may occur which could lead to serious injury or death.**

- Touching an unattended or illegally abandoned M Hybrid Boost Battery may cause electrocution.
- If the M Hybrid Boost Battery is used on a vehicle other than the one it came equipped on (including modified vehicles), accidents such as electric shock, heat generation, smoking, combustion, and explosions, or an electrolyte leakage may occur.

**Appropriate disposal of the M Hybrid Boost Battery.**

If the M Hybrid Boost Battery is not collected and disposed of appropriately, such as by leaving it unattended or illegally abandoning, some other person may touch it which could cause electrocution leading to serious injury.

**Never touch the areas where high current is flowing.**

Never touch an M Hybrid Boost system related part. Otherwise, it could result in serious injury such as burns and electrical shock.

**Never touch electrical wiring that may be protruding into or outside of the cabin.**

Otherwise, it could result in serious injury such as burns and electrical shock.

**Never touch any area where electrolyte is visible or electrolyte is leaking from the area.**

If electrolyte from the M Hybrid Boost Battery gets in the eyes or on the skin, it could cause loss of vision or skin reactions. If electrolyte comes into contact with the eyes, do not rub them, and after flushing with water for 15 minutes or longer, seek medical attention immediately. In addition, if electrolyte comes into contact with the skin, wash the areas with soap and water thoroughly. If you feel any abnormality in your body, seek medical attention immediately.

**Do not come near the vehicle if electrolyte is leaking from the M Hybrid Boost Battery.**

Even if the M Hybrid Boost Battery is damaged, large quantities of electrolyte will not flow out due to the internal structure of the M Hybrid Boost Battery, however, in the unlikely event that it does, it will produce steam. The steam contains properties that can irritate the eyes and skin, and could cause acute poisoning if absorbed.

**Never approach objects that are on fire or extremely hot.**

Electrolyte in the M Hybrid Boost Battery may cause a fire. If the vehicle catches fire, extinguish the fire using a fire extinguisher (type ABC, BC, or C). Only extinguish a fire with water when a large amount of water is available such as from a fire hydrant. Using a small amount of water may cause the fire to spread.

 **CAUTION**

- If the driver's door is opened under the following conditions, the vehicle determines that the driver is trying to leave the vehicle, a warning sound notifying the driver of possible danger is activated, and the warning indication is displayed.
  - The engine is running.
  - The selector lever is in a position other than P or N.
- If there is a problem with the M Hybrid Boost system, a warning is displayed.



## How to Use the M Hybrid Boost

M Hybrid Boost automatically switches between engine assist by the motor and charging by regenerative braking according to the driving conditions of the vehicle.

The M Hybrid Boost power generating status is displayed on the system operation status display of the fuel economy monitor.

Refer to the Mazda Connect Owner's Manual or consult an Authorized Mazda Dealer.

### **NOTE**

Drive the vehicle for about 30 minutes once every 2 to 3 months because self-discharge occurs gradually if the vehicle is not driven for a long period of time. If the M Hybrid Boost Battery discharges completely and the M Hybrid Boost system cannot be activated, contact an Authorized Mazda Dealer.

### **Replacement and Disposal of M Hybrid Boost Battery**

Technical knowledge and skill are necessary in handling the M Hybrid Boost Battery. The M Hybrid Boost Battery is collected and recycled to prevent accidents involving it. When scrapping your vehicle, replacing the M Hybrid Boost Battery, or disposing of the M Hybrid Boost Battery, consult an Authorized Mazda Dealer. Please cooperate in ensuring that the vehicle's M Hybrid Boost Battery is collected and recycled.

### **M Hybrid Boost Malfunction**

If the vehicle receives an impact of a certain level or greater in a collision, the M Hybrid Boost system stops. In

this case, the charging system warning light turns on and the M Hybrid Boost system may not activate. Park the vehicle in a safe place immediately and contact an Authorized Mazda Dealer.

## i-stop

i-stop is a function that automatically stops and restarts the engine to improve fuel economy, reduce exhaust emissions, and idling noise.

## How to Use the i-stop

### Enabling Operation of the i-stop Function

The i-stop function becomes operational when all of the following conditions are met.

- After engine warm-up.
- After starting the engine and driving once.
- Hood is closed.
- The air conditioner is not operated with the airflow mode in the  position.
- The vehicle's interior temperature and the set temperature for the air conditioner are nearly the same.
- The ambient temperature is not too low or too high.
- The atmospheric pressure is not low (when not driving at high altitudes).
- The selector lever is in the D position.
- The automatic transmission fluid has warmed up sufficiently.
- The automatic transmission fluid temperature is not abnormally high.
- The steering wheel is almost in the straight-ahead position (the i-stop function may not operate even with the steering wheel in the straight-ahead position if force is applied to the steering wheel).
- The vehicle is not on a steep slope.
- The vehicle is not stopped suddenly.
- The temperature and the state of charge of the M Hybrid Boost Battery are good.
- The motor and regenerative braking are in good condition.

### Operating the i-stop Function

#### **(Mazda Radar Cruise Control (MRCC)/Cruising & Traffic Support (CTS) is not in use)**

1. When the M Hybrid Boost system determines that the engine does not need power during driving, i-stop function operates and the i-stop indicator light (green) *i-stop* turns on.

When AUTOHOLD is operating, the i-stop function continues to operate even if you release the brake pedal.

2. Start driving the vehicle. The engine restarts when the M Hybrid Boost determines that engine power is required.

#### **(MRCC/CTS is in use)**

1. When the M Hybrid Boost system determines that the engine does not need power during driving, i-stop function operates and the i-stop indicator light (green) *i-stop* turns on.
2. Start driving the vehicle or press the RES switch on the steering switch. The engine restarts when the M Hybrid Boost determines that engine power is required.

#### **NOTE**

If the lead-acid battery terminals are disconnected, the i-stop function may not operate right after connecting the lead-acid battery terminals. In addition, if the lead-acid battery is replaced, the i-stop functions require checking. Consult an Authorized Mazda Dealer.

### Stopping the Operation of the i-stop Function

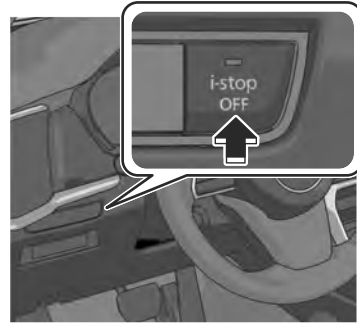

The i-stop function stops and the i-stop OFF switch indicator light turns on.

#### **NOTE**

When the i-stop function is stopped and the engine is stopped, the i-stop function becomes operational again the next time the engine is started.

## Instrument Cluster

The screen display informs you of the vehicle information.

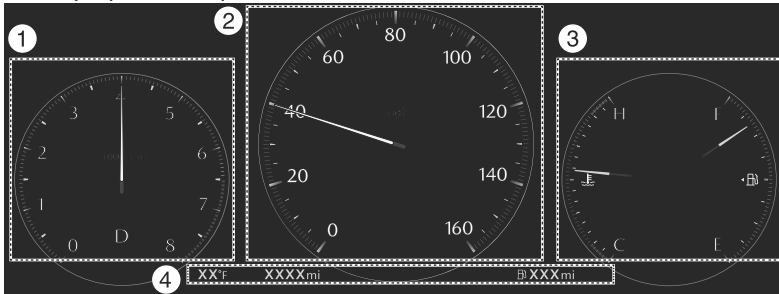

- ① Displays the tachometer.  
The display differs depending on the drive mode.
- ② Displays the speedometer and vehicle information using messages.  
Changes depending on the drive mode and the system being used.
- ③ Displays the engine coolant temperature gauge and the fuel gauge.  
The display is changed using the INFO switch.
- ④ Displays the ambient temperature/odometer/trip meter, maximum driving distance, and vehicle information using messages.

## How to Use the Instrument Cluster

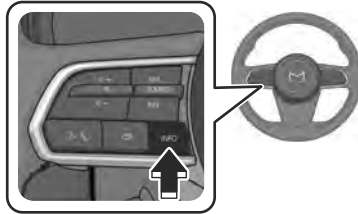

The display changes each time the INFO switch is pressed.

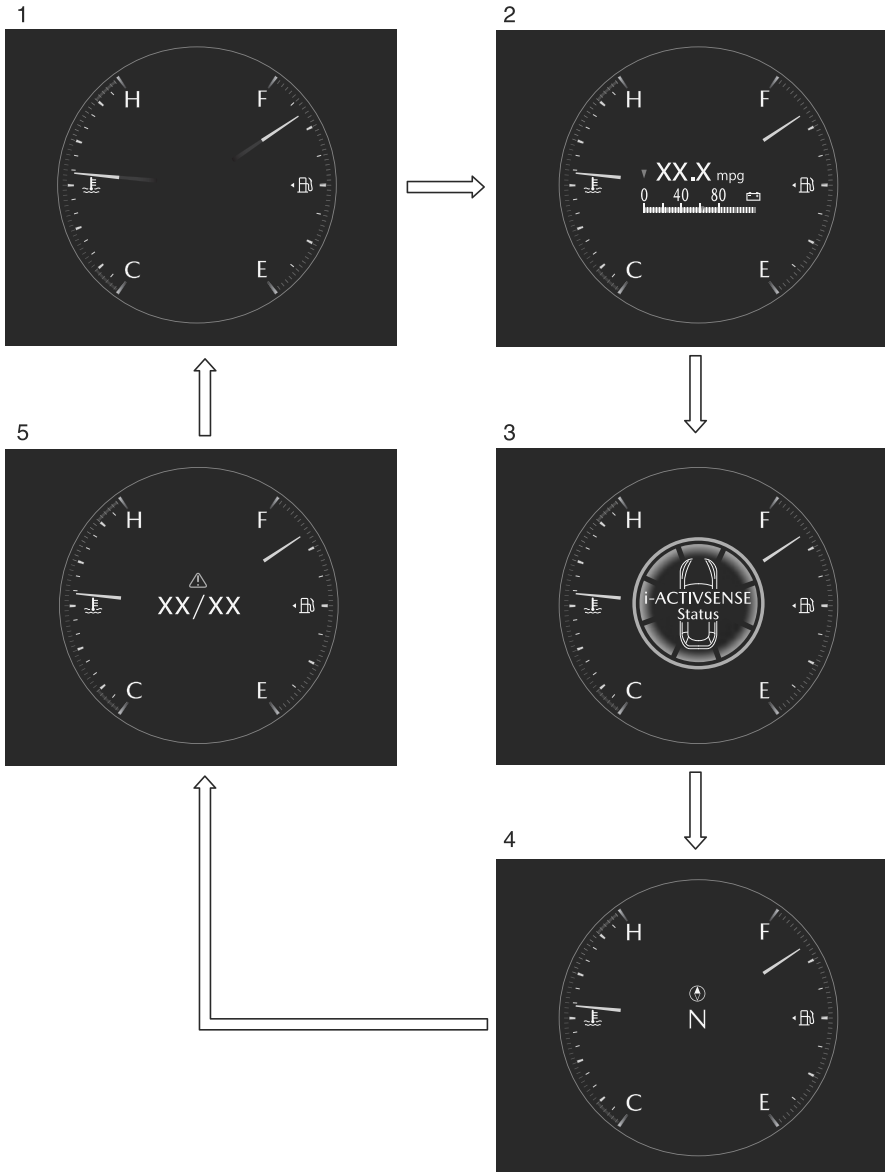

1. Basic display
2. Average fuel economy display

## Instrument Cluster (Type A)

---

Instantaneous fuel economy display

Deceleration regeneration charge display

3. i-ACTIVSENSE status symbol (Warning/Risk avoidance support system)
4. Compass display
5. Message display<sup>\*1</sup>

<sup>\*1</sup> Displayed only when a warning occurs.

The screen will switch automatically when some i-ACTIVSENSE systems are used.

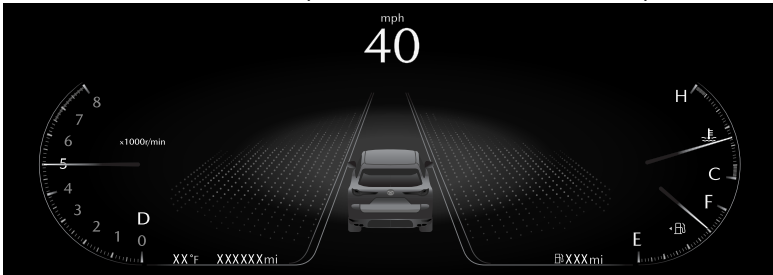

## Convenient Ways to Use the Instrument Cluster

Display information can be switched using Settings in Mazda Connect. Refer to the Settings section in the Mazda Connect Owner's Manual.

## Speedometer

The speedometer indicates the speed of the vehicle.



# Instrument Cluster (Type A)

## Tachometer

The tachometer shows engine speed in thousands of revolutions per minute (rpm).



Do not run the engine with the tachometer needle in the RED ZONE. This may cause severe engine damage.

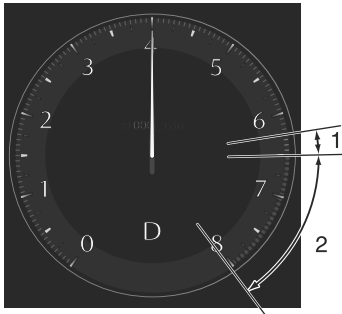

- 1. STRIPED ZONE
- 2. RED ZONE

### NOTE

When the tachometer needle enters the STRIPED ZONE, this indicates to the driver that the gears should be shifted before entering the RED ZONE.

## Odometer/Trip Meter

### Odometer

The odometer records the total distance the vehicle has been driven.

### Trip meter

The driving distance for a specified interval is indicated. Two types (TRIP A, TRIP B) of interval distance can be measured.

## How to Use the Odometer/Trip Meter

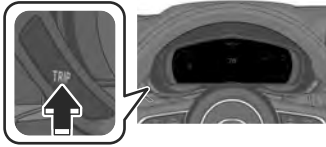

The display changes each time the TRIP switch is pressed.

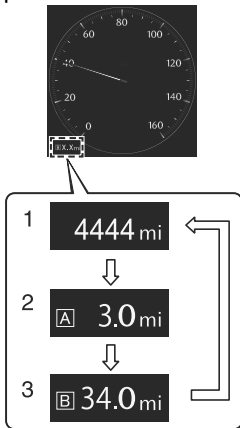

1. Odometer display
2. Trip meter A display
3. Trip meter B display

When returning the trip meter to "0", press the TRIP switch for 2 seconds or longer while the trip meter is displayed.

### NOTE

If the lead-acid battery is disconnected for vehicle maintenance or other reasons, the trip meter display returns to "0".

## Engine Coolant Temperature Gauge

Displays the engine coolant temperature. The blue range of the gauge indicates that the engine coolant temperature is low, and the red range of the gauge indicates that the engine coolant temperature is high and overheating.

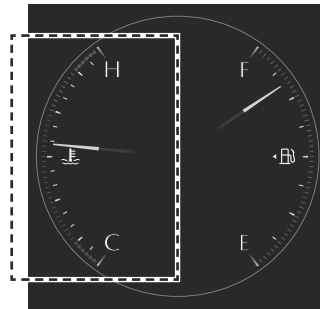

### CAUTION

If the engine coolant temperature gauge needle is in the red range, there is the possibility of overheating. Drive slowly to reduce engine load. Refer to Taking Action with Overheating on page 8-19.

## Instrument Cluster (Type A)

### Fuel Gauge

The fuel gauge shows approximately how much fuel is remaining in the tank when the vehicle power is switched ON.

When the fuel tank is full, F (Full) is indicated, and as the level lowers the needle approaches E (Empty).

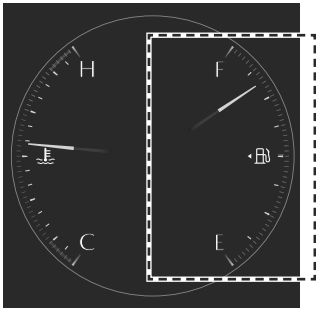

#### NOTE

- After refueling, it may require some time for the indicator to stabilize. In addition, the indicator may deviate while driving on a slope or curve since the fuel moves in the tank.
- The direction of the arrow  indicates that the fuel-filler lid is on the left side of the vehicle.

### Dashboard Illumination

#### (Without auto-light control)

When the lights are turned on with the vehicle power switched ON, the brightness of the dashboard illumination is dimmed.

#### (With auto-light control)

When the lights are turned on with the vehicle power switched ON, the brightness of the dashboard illumination is dimmed. However, when the light sensor detects that the surrounding area is bright such as when the lights are turned on in the daytime, the dashboard illumination does not dim.

#### NOTE

#### (With auto-light control)

When the vehicle power is switched ON in the early evening or at dusk, the dashboard illumination is dimmed for several seconds until the light sensor detects the brightness of the surrounding area, however, the dimming may cancel after the brightness is detected.

## How to Use the Dashboard Illumination

### Brightening the dashboard illumination

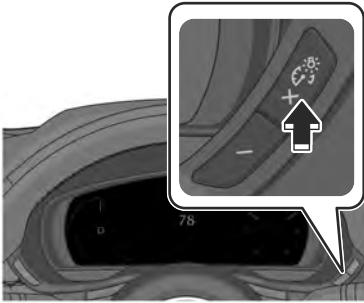

press the + switch again while the illumination dimmer is canceled, a sound is activated to notify you that it is canceled. If the instrument cluster's visibility is reduced due to glare from surrounding brightness, cancel the illumination dimmer.

### Dimming the dashboard illumination

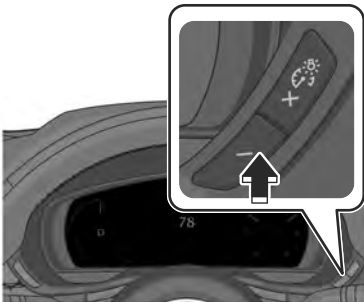

If you press the - switch again while the dashboard illumination is at maximum dimness, a sound is activated to notify you that the dimmer setting is at maximum dimness.

### Function for canceling illumination dimmer

The illumination dimmer can be canceled by pressing the + switch while the instrument cluster is at maximum dimness and while the vehicle power is switched ON. If you

## Outside Temperature Display

When the vehicle power is switched ON, the outside temperature is displayed.



### NOTE

The outside temperature display may differ from the actual outside temperature depending on the surroundings and vehicle conditions.

## Maximum Driving Distance Display

The maximum driving distance is calculated and displayed based on the current remaining fuel tank level and the fuel economy. When the maximum driving distance is 50 km (30 miles) or farther, the maximum driving distance indication decreases in 10 km (10 mile) increments, and when the maximum driving distance is shorter than 50 km (30 miles), it decreases in 1 km (1 mile) increments.

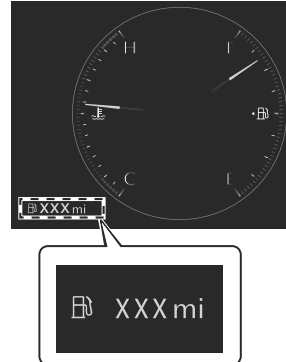

### NOTE

The maximum driving distance is just an approximate numerical value and differs from the actual driving distance. Drive the vehicle while checking the fuel gauge.

## Average Fuel Economy Display

This mode displays the average fuel economy by calculating the total traveled distance and the total fuel consumption since the vehicle was purchased or the past data was reset. The average fuel economy is calculated and displayed every 30 seconds.

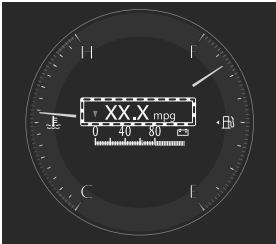

The average fuel economy is also displayed by a red arrow in the instantaneous fuel economy display.

## How to Use the Average Fuel Economy Display

To reset the displayed average fuel economy data, press the INFO switch for 2 seconds or longer.

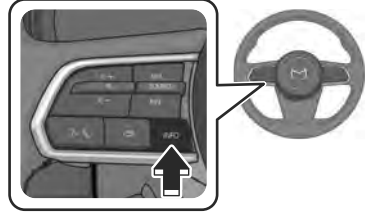

After resetting the data, --- L/100 km (--- mpg) is displayed until the average fuel economy is recalculated and displayed.

## Instantaneous Fuel Economy Display

This displays the current fuel economy by calculating the amount of fuel consumption and the distance traveled.

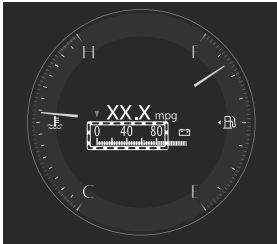

### NOTE

- Displays the 0 position when the vehicle speed decreases to a constant speed or slower.
- The arrow on the scale indicates the average fuel economy.

## Deceleration Regeneration Charge Display

This displays the status of the charging produced by deceleration regeneration.

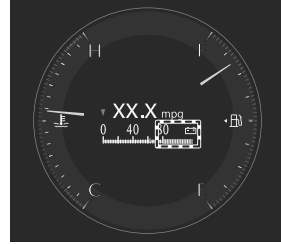

### i-ACTIVSENSE Status Symbol (Warning/Risk Avoidance Support System)

Displays the on/off status of each i-ACTIVSENSE system.

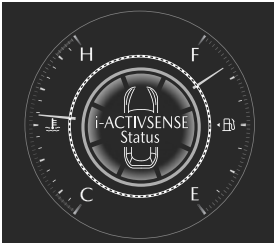

### Compass Display

The direction the vehicle is moving is displayed in one of eight directions while the vehicle is being driven.





### Message Display

Displays a message to notify the user of the system operation status and malfunctions or abnormalities.

Follow the instructions indicated on the display.

Refer to How to Use the Instrument Cluster on page 5-24.

## Instrument Cluster

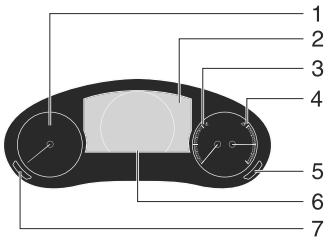

- ① Tachometer
- ② Multi-information Display
- ③ Engine Coolant Temperature Gauge
- ④ Fuel Gauge
- ⑤ Dashboard Illumination Switch
- ⑥ Speedometer
- ⑦ TRIP Switch

## Speedometer

The speedometer indicates the speed of the vehicle.

## Tachometer

The tachometer shows engine speed in thousands of revolutions per minute (rpm).



Do not run the engine with the tachometer needle in the RED ZONE. This may cause severe engine damage.

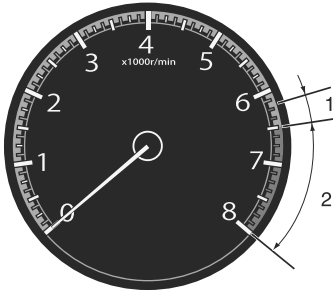

- 1. STRIPED ZONE
- 2. RED ZONE

### NOTE

When the tachometer needle enters the STRIPED ZONE, this indicates to the driver that the gears should be shifted before entering the RED ZONE.

## Multi-information Display

The screen display informs you of the vehicle information.

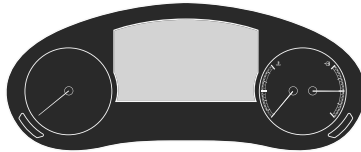

The multi-information display indicates the following information.

- Speedometer
- Odometer
- Trip meter
- Outside temperature
- Maximum driving distance
- Average fuel economy
- Current fuel economy
- Deceleration regeneration charge display
- i-ACTIVSENSE display
- Compass display
- Door-ajar/liftgate-open/hood-open warning indication\*<sup>1</sup>
- Message display

\*<sup>1</sup> Displayed when opening door/liftgate/hood.

## How to Use the Multi-information Display

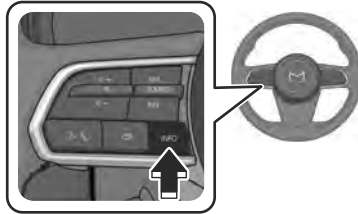

The screen content changes each time the INFO switch is pressed.

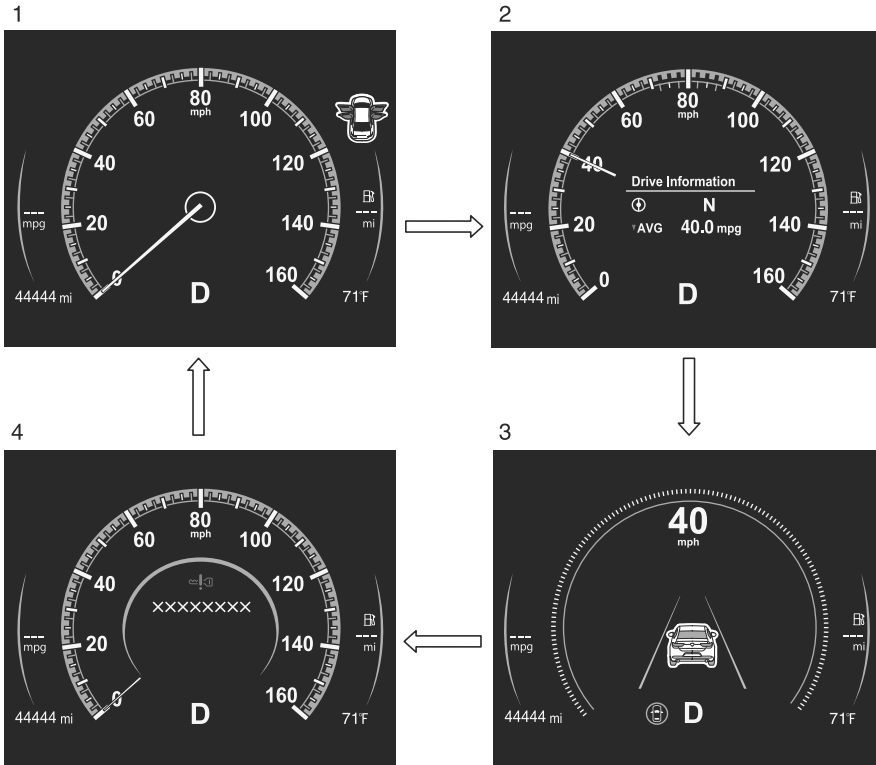

1. Basic display
2. Drive information display
3. i-ACTIVSENSE display
4. Message display<sup>\*1</sup>

\*1 Displayed only when a warning occurs.

## Convenient Ways to Use the Multi-information Display

The type of display for the fuel economy and the maximum driving distance can be changed. Refer to the Settings section in the Mazda Connect Owner's Manual.

## Odometer/Trip Meter

### Odometer

The odometer records the total distance the vehicle has been driven.

### Trip meter

The driving distance for a specified interval is indicated. Two types (TRIP A, TRIP B) of interval distance can be measured.

# Instrument Cluster (Type B)

## How to Use the Odometer/Trip Meter

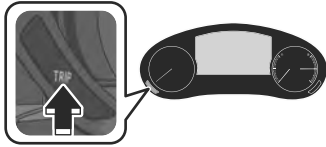

The display changes each time the TRIP switch is pressed.

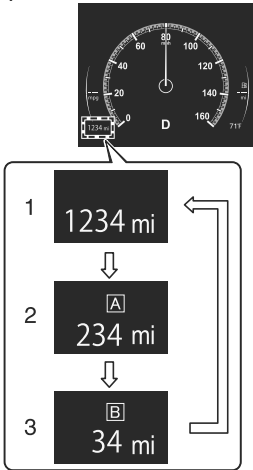

1. Odometer display
2. Trip meter A display
3. Trip meter B display

When returning the trip meter to "0", press the TRIP switch for 2 seconds or longer while the trip meter is displayed.

**NOTE**

If the lead-acid battery is disconnected for vehicle maintenance or other reasons, the trip meter display returns to "0".

## Engine Coolant Temperature Gauge

Displays the engine coolant temperature. The blue range of the gauge indicates that the engine coolant temperature is low, and the red range of the gauge indicates that the engine coolant temperature is high and overheating.

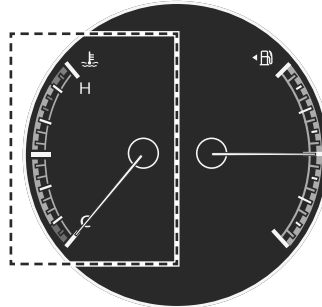

**CAUTION**

If the engine coolant temperature gauge needle is in the red range, there is the possibility of overheating. Drive slowly to reduce engine load. Refer to Taking Action with Overheating on page 8-19.

## Instrument Cluster (Type B)

### Fuel Gauge

The fuel gauge shows approximately how much fuel is remaining in the tank when the vehicle power is switched ON.

When the fuel tank is full, F (Full) is indicated, and as the level lowers the needle approaches E (Empty).

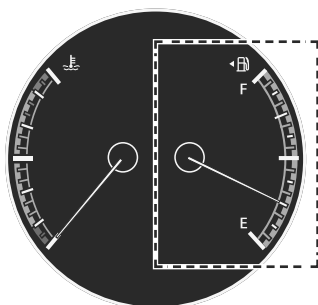

#### NOTE

- After refueling, it may require some time for the indicator to stabilize. In addition, the indicator may deviate while driving on a slope or curve since the fuel moves in the tank.
- The direction of the arrow  indicates that the fuel-filler lid is on the left side of the vehicle.

### Dashboard Illumination

#### (Without auto-light control)

When the lights are turned on with the vehicle power switched ON, the brightness of the dashboard illumination is dimmed.

#### (With auto-light control)

When the lights are turned on with the vehicle power switched ON, the brightness of the dashboard illumination is dimmed. However, when the light sensor detects that the surrounding area is bright such as when the lights are turned on in the daytime, the dashboard illumination does not dim.

#### NOTE

#### (With auto-light control)

When the vehicle power is switched ON in the early evening or at dusk, the dashboard illumination is dimmed for several seconds until the light sensor detects the brightness of the surrounding area, however, the dimming may cancel after the brightness is detected.



## How to Use the Dashboard Illumination

### Brightening the dashboard illumination

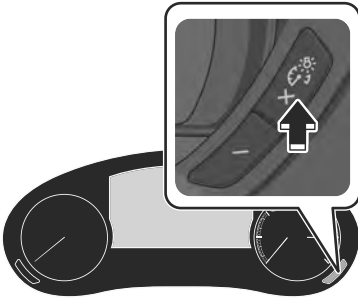

### Dimming the dashboard illumination

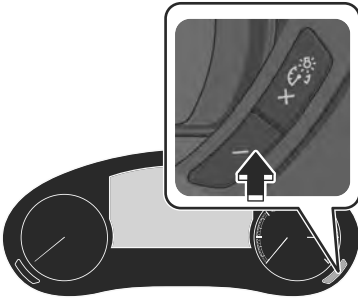

If you press the - switch again while the dashboard illumination is at maximum dimness, a sound is activated to notify you that the dimmer setting is at maximum dimness.

### Function for canceling illumination dimmer

The illumination dimmer can be canceled by pressing the + switch while the instrument cluster is at maximum dimness and while the vehicle power is switched ON. If you press the + switch again while the illumination dimmer is canceled, a sound is activated to notify you that it

is canceled. If the instrument cluster's visibility is reduced due to glare from surrounding brightness, cancel the illumination dimmer.

## Outside Temperature Display

When the vehicle power is switched ON, the outside temperature is displayed.

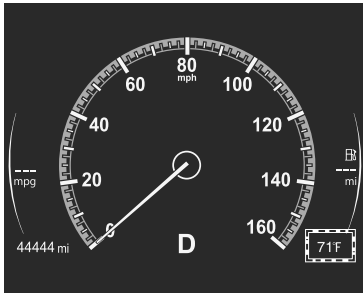

### NOTE

The outside temperature display may differ from the actual outside temperature depending on the surroundings and vehicle conditions.

## Maximum Driving Distance Display

The maximum driving distance is calculated and displayed based on the current remaining fuel tank level and the fuel economy. When the maximum driving distance is 50 km (30 miles) or farther, the maximum driving distance indication, the maximum driving distance indication decreases in 10 km (10 mile) increments, and when the maximum driving distance is shorter than 50 km (30 miles), it decreases in 1 km (1 mile) increments.

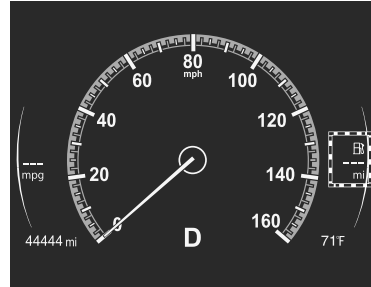

### NOTE

The maximum driving distance is just an approximate numerical value and differs from the actual driving distance. Drive the vehicle while checking the fuel gauge.

# Instrument Cluster (Type B)

## Average Fuel Economy Display

This mode displays the average fuel economy by calculating the total traveled distance and the total fuel consumption since the vehicle was purchased or the past data was reset. The average fuel economy is calculated and displayed every 30 seconds.

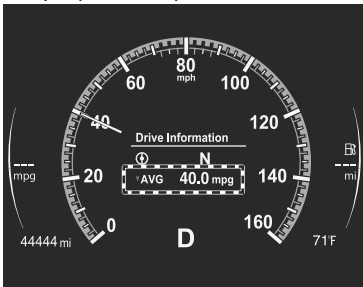

## How to Use the Average Fuel Economy Display

To reset the displayed average fuel economy data, press the INFO switch for 2 seconds or longer.

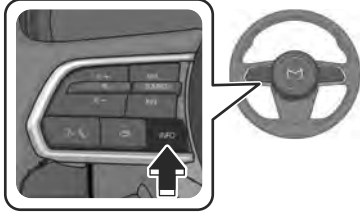

After resetting the data, - - - L/100 km (- - - mpg) is displayed until the average fuel economy is recalculated and displayed.

## Instantaneous Fuel Economy Display

This displays the current fuel economy by calculating the amount of fuel consumption and the distance traveled.

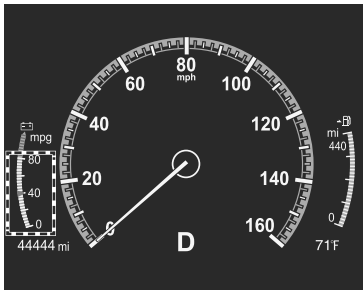

### NOTE

- Displays the 0 position when the vehicle speed decreases to a constant speed or slower.
- The arrow on the scale indicates the average fuel economy.

## Deceleration Regeneration Charge Display

This displays the status of the charging produced by deceleration regeneration.

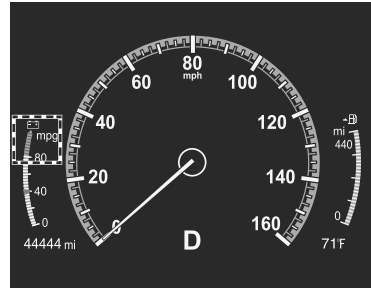

# Instrument Cluster (Type B)

## i-ACTIVSENSE Display

Displays the system status.

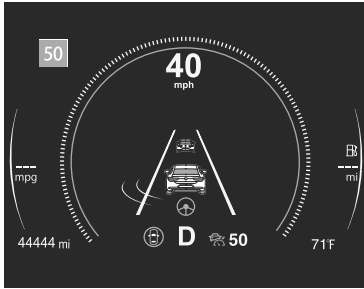

## Compass Display

The direction the vehicle is moving is displayed in one of eight directions while the vehicle is being driven.

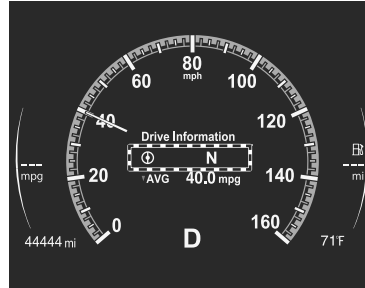

## Message Display

Displays a message to notify the user of the system operation status and malfunctions or abnormalities.

Follow the instructions indicated on the display.

Refer to How to Use the Multi-information Display on page 5-40.

## Active Driving Display\*

The active driving display indicates vehicle information and navigation information.

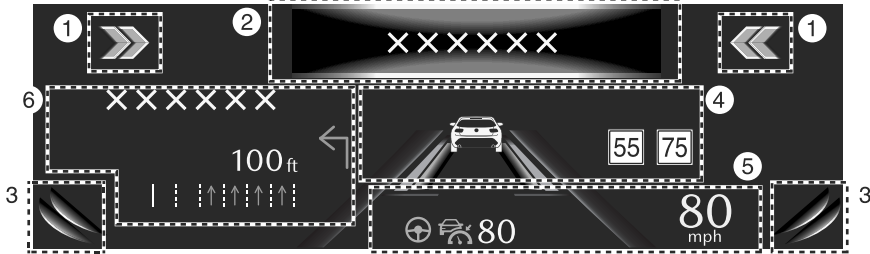

1. Front Cross Traffic Alert (FCTA) warning display area
2. Warning guidance display area
3. Blind Spot Monitoring (BSM) warning display area
4. i-ACTIVSENSE information display area
5. Vehicle speed display area and setting speed display area
6. Navigation information display area

### NOTE

- Wearing polarized sunglasses will reduce the visibility of the active driving display due to the characteristics of the display.
- If the lead-acid battery has been removed and re-installed or the lead-acid battery voltage is low, the adjusted position may deviate.
- The display may be difficult to view or temporarily affected by weather conditions such as rain, snow, light, and temperature.

## Warnings and Cautions for Using the Active Driving Display

### WARNING

**Always adjust the display brightness and position with the vehicle stopped.** Adjusting the display brightness and position while driving the vehicle is dangerous as doing so could distract your attention from the road ahead and lead to an accident.

### CAUTION

- Do not place beverages near the dust-proof sheet of the active driving display. If water or other liquids are splashed on the dust-proof sheet, it could cause damage.
- Do not place objects or apply stickers to the dust-proof sheet as they will cause interference.



1. Dust-proof sheet



## Convenient Ways to Use the Active Driving Display

The active driving display settings can be changed or adjusted.

Refer to the Settings section in the Mazda Connect Owner's Manual.

### **NOTE**

The desired driving position (display position, brightness level, display information) can be called up after programming the position.

Refer to How to Use the Driving Position Memory on page 3-36.

## Warning and Cautions for Using the Selector Lever

### **WARNING**

**Always apply the parking brake when the selector lever is in the P position.** When parking the vehicle, only shifting the selector lever to the P position is dangerous as the vehicle may move unexpectedly and result in an accident.

**Do not move the selector lever from the N or P position while the engine speed is high.** Otherwise, the vehicle will move suddenly which could lead to an unexpected accident.

**When operating the selector lever, shift the selector lever with the brake pedal firmly depressed and the vehicle completely stopped.** Operating the selector lever while the vehicle is moving could lead to an unexpected accident.

**Do not shift the selector lever with the accelerator pedal depressed when the selector lever is in the P or N position.** Always operate the selector lever with the brake pedal depressed when the selector lever is in the P or N position. Otherwise, the vehicle will suddenly accelerate which could lead to an accident.

**Do not shift the selector lever to the N position while driving.** Otherwise, it could result in the loss of the engine braking power and cause an accident.

**Do not depress the accelerator pedal unnecessarily while the vehicle is stopped.**

If the accelerator pedal is mistakenly depressed when the selector lever is in a position other than the P or N position, the vehicle could suddenly accelerate resulting in an accident.

**After stopping the vehicle, check the shift position indication in the instrument cluster before re-accelerating.**

If the vehicle were to move unexpectedly, it could lead to an accident.

**Do not allow the vehicle to move in reverse on an upslope while the selector lever is in forward drive, or move forward on a downslope while the selector lever is in reverse drive.** Otherwise, the engine could stop, making the steering wheel difficult to control, which could result in an accident.

### **CAUTION**

- When visually checking at the rear of the vehicle while reversing the vehicle, your body twists around to the rear. Be careful and make sure that the brake pedal can be firmly depressed.
- Completely stop the vehicle before shifting the selector lever to the P position. If the selector lever is shifted to P position before the vehicle is completely stopped, unnecessary force will be applied to the transmission which could cause damage.

# Selector Lever

- On roads with high driving resistance such as deep-snowy or sandy roads, or on steep slopes, a high load is applied to the transmission, causing excessive heat generation. Under these driving conditions, pay attention to the following points.
  - Stop and hold the vehicle on a steep slope with the brake pedal, not the accelerator pedal. Do not use the accelerator pedal to prevent the vehicle from rolling.
  - Avoid using the accelerator pedal and the brake pedal at the same time.
  - Start driving the vehicle in the D or R position according to the direction of travel (avoid starting in manual mode).

If you do not follow the above precautions, the transmission may overheat. If a message, such as transmission cooling, is displayed, it is necessary to temporarily stop the vehicle to cool the transmission.

## How to Use the Selector Lever

### Operating the Selector Lever

1. Start the engine.
2. Operate the selector lever.

Selector lever operation	Operation condition
Shift from P position to R position	Depress the brake pedal and press the selector lever button to operate.
Shift from R position to N position	Shift the lever without pressing the selector lever button.
Shift from N position to D position	
Shift from D position to N position	
Shift from N position to R position	Press the selector lever button to shift the lever.
Shift from R position to P position	

The shift indicator turns on at the same position as the shift position displayed in the instrument cluster.

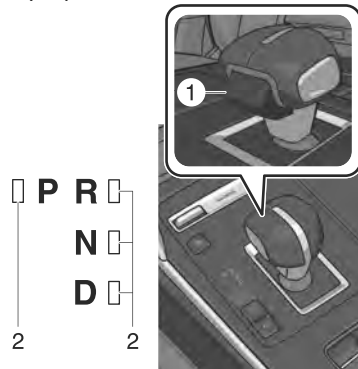

1. Selector lever button
2. Shift indicator

The shift position is displayed in the instrument cluster.

# P

### Shift position restrictions

The shift position changes to the N position for safety when the following operations are performed. Once action is taken, the selector lever position and the shift position become the same.

Operation/driving conditions	Action
When the brake pedal is not depressed or the accelerator pedal is depressed while the vehicle is stopped, the selector lever is shifted from the N position to the R or D position.*1	Release your foot from the accelerator pedal and depress the brake pedal.
When the vehicle speed is 5 km/h (3 mph) or faster, the selector lever is shifted from the R or D position to the P position.	<p><b>(Action 1)</b> Reduce the vehicle speed to less than 5 km/h (3 mph).</p> <p><b>(Action 2)</b> Shift the selector lever to the prior operation position (R or D position).</p>

Operation/driving conditions	Action
When the vehicle speed is 10 km/h (6.2 mph) faster, the selector lever is shifted from the R position to the D position, or from the D position to the R position.	<p><b>(Action 1)</b> Reduce the vehicle speed to less than 10 km/h (6.2 mph).</p> <p><b>(Action 2)</b> Shift the selector lever to the prior operation position (R or D position).</p>

\*1 The parking brake is applied automatically.

### Shift guide indication

In the following cases, the shift position is displayed in the instrument cluster even if the vehicle power is in a position other than ON.

- The AUTO P (parking lock) function is operating.
- Neutral hold mode is operating.

When the shift position and the selector lever position differ, the shift position and the selector lever position are displayed.



1. Selector lever position
2. Shift position

### NOTE

- If the selector lever cannot be shifted from the P position, the lead-acid battery could be depleted.

- When the selector lever is shifted from the N position to the D/R position without depressing the brake pedal, the shift position and the selector lever position differ, however, the shift guide indication is not displayed.
- When the vehicle power is switched from ON to ACC or OFF, the shift guide indication displayed after operating the AUTO P (parking lock) function turns on for a certain period of time and then it turns off.

### Operating the AUTO P (Parking Lock) Function

Meet the following conditions while the vehicle is stopped.

- Switch the vehicle power from ON to OFF.
- Unfasten the driver's seat belt and open the driver's door while the shift position is in the D/R position.

The AUTO P (parking lock) function operates and the shift position automatically changes to P.

#### NOTE

When the AUTO P (parking lock) function operates, only the transmission shift position changes to the P position automatically. The shift position indication in the instrument cluster will differ from the selector lever position because the selector lever position does not change. Check the shift position indication in the instrument cluster and shift the selector lever to the P position.

## Convenient Ways to Use the Selector Lever

### Using Neutral Hold Mode

When in neutral hold mode, a condition is maintained for about 25 minutes in which the vehicle power is switched to ACC, the shift position is in the N position, and the parking brake is released. Use this mode when it is necessary to release the parking brake and change the shift position to the N position, such as in an automatic car wash that moves the vehicle by placing the front and rear tires on one side of the vehicle on a belt conveyor.

#### Neutral Hold Mode activation method 1

1. Start the engine.
2. Release the parking brake.
3. Shift the selector lever to the N position.
4. Turn off the AUTOHOLD.
5. Press the electric parking brake (EPB) switch continuously until a sound is activated.
6. Press the push button start immediately after the sound is activated.  
Neutral hold mode operates.

#### Neutral Hold Mode activation method 2

1. Start the engine.
2. Release the parking brake.
3. Shift the selector lever to the N position.
4. Turn off the AUTOHOLD.
5. Press the push button start while pressing the electric parking brake (EPB) switch.  
Neutral hold mode operates.

### **Canceling Neutral Hold Mode**

If any of the following operations is performed, neutral hold mode is canceled.

- Switch the vehicle power ON.
- Shift the selector lever to the P position.

#### **NOTE**

Neutral hold mode is canceled automatically after about 25 minutes have passed since it was operated, and the vehicle power is switched OFF. At this time, the AUTO P (parking lock) function operates and the shift position changes to the P position.

## Warnings and Cautions for Using the Steering Shift Switches

### **WARNING**

**Avoid using sudden engine braking (shift-down).**

If you apply sudden engine braking (shift-down) while driving at high speed or on wet roads, snow-covered roads, or icy roads, the tires may slip and cause an unexpected accident.

## How to Use the Steering Shift Switches\*

### Using Direct Mode

Pull the up switch (+/OFF) or the down switch (-) of the steering shift switches toward you when the selector lever is in the D position.

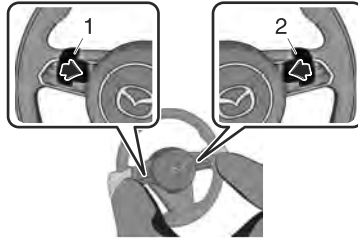

1. Down switch (-)
2. Up switch (+/OFF)

The gear position can be temporarily switched manually in direct mode. The direct mode indication and the gear position are displayed in the instrument cluster.

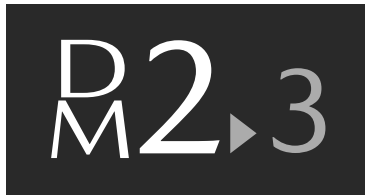

### Shifting up/down

Pull the up switch (+/OFF) or the down switch (-) of the steering shift switches toward you.

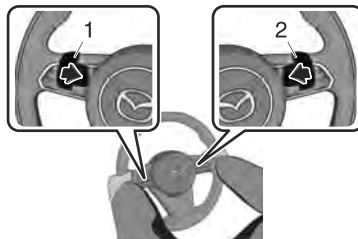

1. Down switch (-)
  2. Up switch (+/OFF)
- Shifts up or down.



## NOTE

- If the automatic transmission fluid (ATF) temperature becomes too high, the mode will not switch to direct mode. In addition, if the ATF temperature becomes too high while in direct mode, the mode may be canceled. If the mode is switched to direct mode again, it is necessary to operate the steering shift switches.
- While the vehicle is stopped, direct mode cannot be set even if the DOWN switch (-) is pulled.
- When fully depressing the accelerator pedal even while in direct mode, the transmission kicks down, but it does not kick down while the Traction Control System (TCS) is turned off. However, if the vehicle is continuously driven at a high rpm, the gears may automatically shift up to protect the engine.
- When the vehicle is driven at low speed or decelerating quickly during EV driving, the mode may not be able to be switched to direct mode using the UP switch (+/OFF) of the steering shift switches.
- If NORMAL mode is in use while the motor is running, operating the steering shift switches will start the engine.

## Canceling Direct Mode

Direct mode can be canceled by performing the following operations.

- The UP switch (+/OFF) is pulled toward you for a certain period of time or longer.
- The vehicle is driven for a certain period of time or longer (time differs depending on the driving conditions while operating).
- The vehicle is stopped.
- The vehicle is driven at a low speed.

## Using Manual Shift Mode

1. Select manual shift mode (M) from AT shift modes under Settings in Mazda Connect.
2. Pull the up switch (+/OFF) or the down switch (-) of the steering shift switches toward you when the selector lever is in the D position.

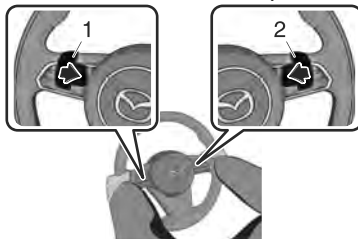

1. Down switch (-)
2. Up switch (+/OFF)

The gear position can be switched manually in manual shift mode.

### Shifting up/down

Pull the up switch (+/OFF) or the down switch (-) of the steering shift switches toward you.

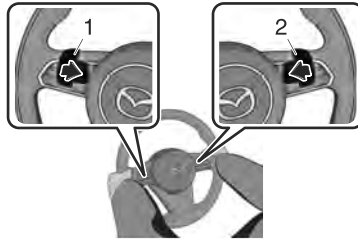

1. Down switch (-)
  2. Up switch (+/OFF)
- Shifts up or down.

### NOTE

- If the automatic transmission fluid (ATF) temperature becomes too high, the mode will not switch to manual shift mode. In addition, if the ATF temperature becomes too high while in manual shift mode, the mode may be canceled. If the mode is switched to manual shift mode again, it is necessary to operate the steering shift switches.
- When fully depressing the accelerator pedal even while in manual mode, the transmission kicks down, but it does not kick down while the Traction Control System (TCS) is turned off. However, if the vehicle is continuously driven at a high rpm, the gears may automatically shift up to protect the engine.
- When the vehicle is driven at low speed or decelerating quickly during EV driving, the mode may not be able to be switched to manual shift mode using the UP switch (+/OFF) of the steering shift switches.
- If NORMAL mode is in use while the motor is running, operating the steering shift switches will start the engine.

### Canceling Manual Shift Mode

The UP switch (+/OFF) of the steering shift switches is pulled and held for a certain period of time or longer.  
Manual shift mode is canceled.

## Shift gear (shifting) speed limit

The gear is shifted when the steering shift switches are operated within the speed limit ranges.

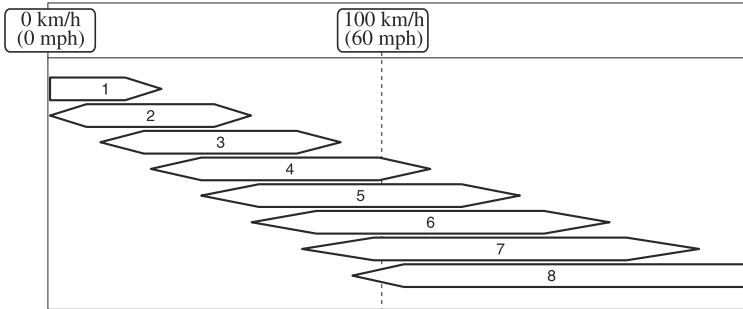

1. 1st gear
2. 2nd gear
3. 3rd gear
4. 4th gear
5. 5th gear
6. 6th gear
7. 7th gear
8. 8th gear

When shifting down is not possible depending on the vehicle speed, the gear position indication displayed in the instrument cluster flashes 2 times.

## Using Second Gear Fixed Mode

Changing to second gear fixed mode facilitates, accelerating from a stop and driving on slippery roads such as snow-covered roads.

The UP switch (+/OFF) of the steering shift switches is pulled while driving the vehicle at about 10 km/h (6.2 mph) or slower.

Second gear fixed mode is activated.

### **NOTE**

When using second gear fixed mode, the vehicle stops at the 2 gear position.

## Canceling Second Gear Fixed Mode

Second gear fixed mode can be canceled by performing the following operations.

- Pull the UP switch (+/OFF) of the steering shift switches toward you and shift into a gear other than second gear.
- Drive the vehicle at a speed of about 30 km/h (18 mph) or faster.

## Convenient Ways to Use the Steering Shift Switches

You can select AT shift mode under Settings in Mazda Connect.

- Direct mode (DM)
- Manual shift mode (M)

Refer to the Mazda Connect Owner's Manual or consult an Authorized Mazda Dealer.

When the vehicle power is switched OFF with manual shift mode (M) selected, the AT shift mode setting switches automatically to direct mode (DM) the next time the vehicle power is switched ON.

## Warning and Cautions for Using the Foot Brake

### WARNING

#### **Do not coast with the engine turned off, find a safe place to stop.**

Coasting with the engine turned off is dangerous. Braking will require more effort, and the brake's power-assist could be depleted if you pump the brake. This will cause longer stopping distances or even an accident.

#### **Shift to a lower gear when going down steep hills.**

Driving with your foot continuously on the brake pedal or steadily applying the brakes for long distances is dangerous. This causes overheated brakes, resulting in longer stopping distances or even total brake failure. This could cause loss of vehicle control and a serious accident. Avoid continuous application of the brakes.

#### **Dry off brakes that have become wet by driving slowly, releasing the accelerator pedal and lightly applying the brakes several times until the brake performance returns to normal.**

Driving with wet brakes is dangerous. Increased stopping distance or the vehicle pulling to one side when braking could result in a serious accident. Light braking will indicate whether the brakes have been affected.

#### **Do not drive with worn disc pads.**

Driving with worn disc pads is dangerous. The brakes could fail and cause a serious accident. As soon as you hear a screeching noise consult an Authorized Mazda Dealer.

### CAUTION

- Do not drive with your foot held on the brake pedal. Doing so could result in the following:
  - The brake parts will wear out more quickly.
  - The brakes can overheat and adversely affect brake performance.
- Always depress the brake pedal with the right foot. Applying the brakes with the unaccustomed left foot could slow your reaction time to an emergency situation resulting in insufficient braking operation.



- Wear shoes appropriate for driving in order to avoid your shoe contacting the brake pedal when depressing the accelerator pedal.

## Electric Parking Brake (EPB)

The EPB system applies the parking brake using a motor.

### NOTE

If the parking brake is applied with the vehicle power switched to OFF or ACC, the EPB indicator light  in the instrument cluster and the indicator light in the switch may turn on for a certain period of time.

## Warning and Cautions for Using the Electric Parking Brake (EPB)

### WARNING

#### **Do not drive the vehicle with the parking brake applied.**

If the vehicle is driven with the parking brake applied, the brake parts may generate heat and the brake system may not operate, leading to an accident. Before driving the vehicle, release the parking brake and make sure that the EPB indicator light  in the instrument cluster turns off.

#### **Apply the parking brake when leaving the vehicle.**

Not applying the parking brake when parking the vehicle is dangerous as the vehicle may move unexpectedly and result in an accident. Before leaving the vehicle, apply the parking brake and make sure that the EPB indicator light  in the instrument cluster turns on.

### CAUTION

- Depress the brake pedal firmly before doing a shift operation as the vehicle may start moving unexpectedly.
- If something such as the driver's foot contacts the accelerator pedal while the engine is operating and the parking brake is applied, the parking brake may be released automatically and the vehicle may move unexpectedly. If you do not intend to start driving the vehicle immediately, shift the selector lever to the P or N position.

## How to Use the Electric Parking Brake (EPB)

### Applying the Parking Brake Manually

1. Depress the brake pedal.
- 2.



The parking brake is applied and the EPB indicator light  in the instrument cluster and the EPB switch indicator light turn on.

### Releasing the Parking Brake Manually

1. Depress the brake pedal with the vehicle power switched ON or the engine operating.
- 2.



When the parking brake is released, the EPB indicator light  in the instrument cluster and the EPB switch indicator light turn off.

### NOTE

- To release the parking brake when the vehicle power is switched OFF, it is necessary to cancel the parking brake auto operation. If the parking brake is likely to freeze such as during cold weather conditions, cancel the parking brake auto operation.
- When the charging system warning light in the instrument cluster turns on, the parking brake cannot be applied after the vehicle power is switched OFF. Before switching the vehicle power OFF, apply the parking brake manually.

### Applying the Parking Brake Automatically

Switch the vehicle power from ON to ACC or OFF.

The parking brake is applied and the EPB indicator light  in the instrument cluster and the EPB switch indicator light turn on.

### Releasing the Parking Brake Automatically

#### Shift-linked release

Shift the selector lever from the P position to a position other than P when all of the following conditions are met.

- Engine is operating.
- Driver's door is closed.
- Brake pedal is firmly depressed.

When the parking brake is released, the EPB indicator light  in the instrument cluster and the EPB switch indicator light turn off.

#### Accelerator-linked release

Depress the accelerator pedal when all of the following conditions are met.

- Engine is operating.
- Driver's door is closed.
- Driver's seat belt is fastened.
- The selector lever is in the D or R position.

When the parking brake is released, the EPB indicator light  in the instrument cluster and the EPB switch indicator light turn off.

## Convenient Ways to Use the Electric Parking Brake (EPB)

### Enabling/Disabling Shift-Linked Release

1. Switch the vehicle power ON.
2. Make sure that the parking brake is applied (EPB indicator light  is turned on).
3. Continue pulling the EPB switch for 4 seconds or longer.



4. Release the EPB switch once.
5. Immediately continue pulling the EPB switch for 4 seconds or longer.

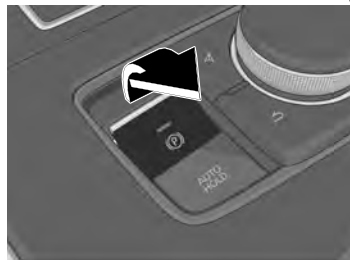

When the shift-linked release is enabled, a sound is activated 2 times, the EPB switch indicator light switches to fast flashing, and then flashes for a certain period of time. When the shift-linked release is disabled, a sound is activated 1 time, the EPB switch indicator light switches to slow flashing, and then flashes for a certain period of time.



## Canceling the Parking Brake Automatic Operation

The parking brake automatic operation returns to automatic operation when the vehicle power is switched ON. When canceling the parking brake auto operation and parking the vehicle, shift the selector lever to the P position for an automatic transmission and use wheel blocks on the tires. If one of the following operations is performed, the parking brake automatic operation can be canceled when the vehicle power is switched from ON to OFF.

### Operation method 1

1. Switch the vehicle power ON.
2. Release the parking brake manually.
3. Turn off the AUTOHOLD.
4. Press the EPB switch continuously until a sound is activated.

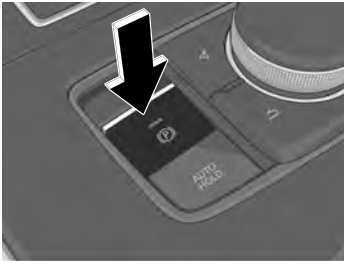

5. Release the EPB switch.
6. Switch the vehicle power OFF immediately after a sound is activated.  
After the parking brake auto operation is canceled, a warning sound is activated one time, and the EPB switch indicator light switches from illumination to flashing, and then turns off after a certain period of time has passed.

### Operation method 2

1. Switch the vehicle power ON.
2. Release the parking brake manually.

3. Turn off the AUTOHOLD.
4. With the EPB switch pressed, switch the vehicle power OFF without depressing the brake pedal.

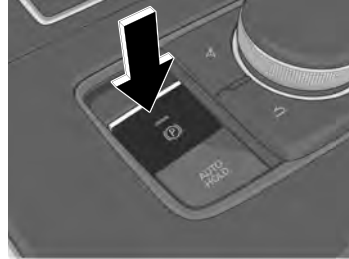

After the parking brake auto operation is canceled, a warning sound is activated one time, and the EPB switch indicator light switches from illumination to flashing, and then turns off after a certain period of time has passed.

### NOTE

- The auto operation may not cancel if the vehicle is parked on a steep slope.
- When using an automatic car wash which moves the vehicle with the front tires mounted, it is necessary to cancel the parking brake automatic operation.

## Brake Override System

The brake override system applies the brake first for safety if the brake pedal and the accelerator pedal are depressed at the same time. If the brake override system operates, the brake override warning light  in the instrument cluster turns on.

## Warning and Cautions for Using the Brake Override System

### CAUTION

Do not drive with your foot held on the brake pedal. The brake override system may not operate normally.

## How to Use the Brake Override System

You can use the Mazda Connect setting to disable the brake override system warning.

Set in the Mazda Connect "Settings" or consult an Authorized Mazda Dealer.

## AUTOHOLD

AUTOHOLD is a function to keep the vehicle stopped by applying the brakes even if you take your foot off the brake pedal while the vehicle is stopped. This function reduces the burden on the driver while the vehicle is stopped, such as at traffic lights.

## Warning and Cautions for Using the AUTOHOLD

### WARNING

#### **Do not rely completely on the AUTOHOLD function.**

The AUTOHOLD function is only designed to assist the brake operation while the vehicle is stopped. Neglecting to operate the brakes and relying only on the AUTOHOLD system is dangerous and could result in an unexpected accident if the vehicle were to suddenly move. Operate the brakes appropriately in accordance with the road and surrounding conditions. Note that the vehicle may move suddenly depending on the vehicle's load or if it is towing something.

#### **Do not release your foot from the brake pedal while the vehicle is stopped on a steep grade.**

Because there is a possibility of the vehicle not being held in the stopped position by the AUTOHOLD function, the vehicle may move unexpectedly and result in an accident.

#### **Refrain from using the AUTOHOLD function on slippery roads such as icy or snow-covered roads, or unpaved roads.**

Even if the vehicle is held in the stopped position by the AUTOHOLD function, the vehicle may move unexpectedly and result in an accident. Operate the accelerator pedal, brakes, or steering wheel appropriately as necessary.

**Immediately depress the brake pedal in the following case.**

Because the AUTOHOLD function is canceled forcibly, the vehicle may move unexpectedly and result in an accident.

- The message “Depress Brake Pedal. Brake Hold Disabled” is displayed on the instrument cluster and the warning sound is activated at the same time.

**When parking and before leaving the vehicle, apply the parking brake.**

Otherwise, the vehicle may move unexpectedly and result in an accident. When parking and before leaving the vehicle, shift the selector lever to the P position and apply the parking brake.



If you stop operating the accelerator pedal before the vehicle starts moving, the brake may be released. Firmly depress the brake pedal or depress the accelerator pedal to start driving the vehicle.

## How to Use the AUTOHOLD

### Operating the AUTOHOLD

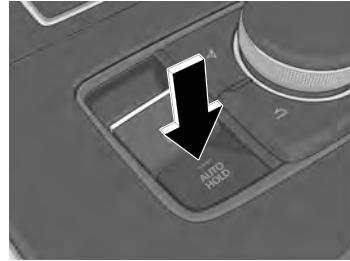

The AUTOHOLD becomes operational and the AUTOHOLD standby indicator light turns on.

### Using the AUTOHOLD

1. Stop the vehicle.  
When all of the following conditions are met, the AUTOHOLD operates and the AUTOHOLD active indicator light **HOLD** in the instrument cluster turns on.
  - The engine is operating.
  - The driver's seat belt is fastened.
  - The driver's door is closed.
  - The parking brake is released.
2. Start driving the vehicle.  
The brakes are released and the AUTOHOLD active indicator light **HOLD** in the instrument cluster turns off.

### **NOTE**

- When about 10 minutes or longer have passed since the AUTOHOLD operated, the parking brake is applied automatically. When the parking brake is released, the AUTOHOLD operates again.

- When the vehicle power is switched OFF while the AUTOHOLD is operating, the parking brake is applied automatically.
- If the selector lever is shifted to the R position with the vehicle tilted rearward or on level ground, the AUTOHOLD is canceled. Operate the brakes if necessary.
- Under the following conditions, the parking brake is automatically applied and the AUTOHOLD is released. The AUTOHOLD is re-enabled when the conditions before the AUTOHOLD is released are restored.
  - The driver's seat belt is unfastened.
  - The driver's door is opened.

### **Canceling the AUTOHOLD Operation**

1. Depress the brake pedal with the AUTOHOLD operating.
- 2.

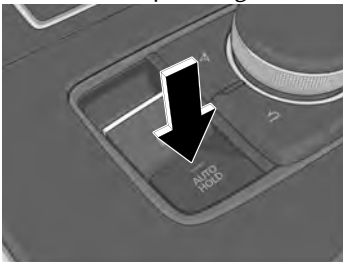

The AUTOHOLD operation is canceled and the AUTOHOLD standby indicator light turns off.

### **NOTE**

- The AUTOHOLD can be turned off by pressing the AUTOHOLD switch while driving.
- When the vehicle power is switched OFF while the AUTOHOLD is operating, the parking brake is applied automatically and the AUTOHOLD is turned off.

## Hill Launch Assist (HLA)

---

### Hill Launch Assist (HLA)

The HLA prevents the vehicle from rolling backward or forward, such as when releasing the brake pedal while on a slope.

#### NOTE

- The HLA may not operate on a gentle slope or depending on the vehicle's load.
- The HLA does not operate if the parking brake is applied or the vehicle has not stopped completely.
- When the TCS/DSC operation indicator light  turns on, the HLA may not operate.
- The HLA does not turn off even if the TCS is turned off.

### Warning and Cautions for Using the Hill Launch Assist (HLA)

#### WARNING

#### **Do not rely completely on the HLA.**

The HLA is designed only to assist the driver in accelerating from a stop on a slope. The HLA only operates for about 2 seconds and therefore, if the accelerator and brake pedals are not operated correctly the vehicle may move (roll) unexpectedly and cause an accident. Always confirm the safety around the vehicle before starting to drive the vehicle. Note that the vehicle may move suddenly depending on the vehicle's load or if it is towing something.

## Light Switch

Each light turns on/off when the switch is operated.

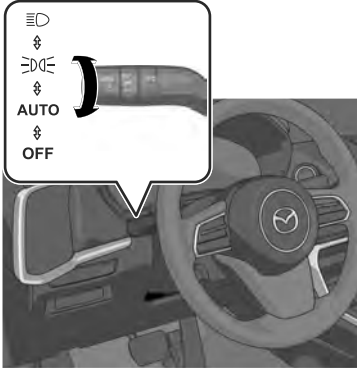

## Warnings and Cautions for Using the Light Switch

### CAUTION

Do not cover the light sensor by applying stickers or labels to the windshield. Otherwise the sensor cannot detect the surrounding light correctly.

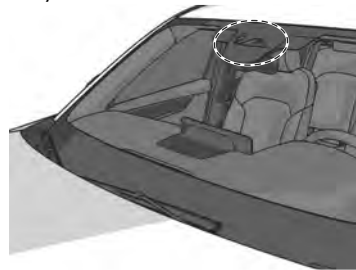



## How to Use the Light Switch

### NOTE

Headlights which do not blind drivers approaching in the opposite direction have been adopted. Therefore, it is not necessary to adjust the optical axis of the headlights even when traveling temporarily in a country where vehicles are driven on the right-hand side of the road.

### Using the Lights Automatically

#### Using the Auto Light

Make sure that the light switch is in the **AUTO** position.

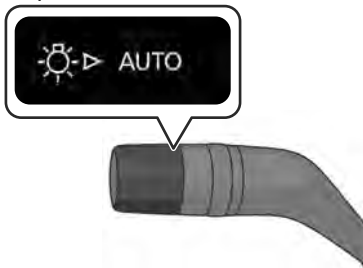

The daytime running lights turn on automatically when it is bright, and the headlights, parking lights, taillights, side-marker lights, and the license plate lights turn on automatically when it is dark.

When the parking lights, taillights, side-marker lights, and the license plate lights are turned on, the parking lights indicator light  in the instrument cluster turns on.

### NOTE

- If the surroundings remain dark for several minutes even during daytime, the light sensor determines that it is nighttime, and the lights may not turn off immediately even if the surroundings become bright.
- The illumination timing for the headlights can be changed. Refer to the Mazda Connect Owner's Manual or consult an Authorized Mazda Dealer.

### Using the Daytime Running Lights

The daytime running lights turn on while driving in bright surroundings such as during the day.

### NOTE

**(Only in regions where daytime running lights are not mandatory)**

The daytime running lights can be set so that they do not turn on. Refer to the Mazda Connect Owner's Manual or consult an Authorized Mazda Dealer.

### Using the Lights Manually

#### Using the Parking lights, Taillights, Side-Marker Lights, and License Plate Lights

(The vehicle power is switched to ON)

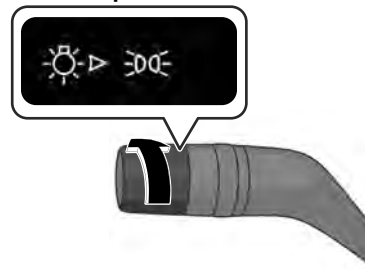

The parking lights, taillights, side-marker lights, and license plate lights turn on, and the parking lights indicator light  in the instrument cluster turns on.

When the vehicle power is switched from ON to OFF, the parking lights, taillights, side-marker lights, and the license plate lights are turned on by the auto headlight off function for a certain period of time.

**(The vehicle power is switched to ACC or OFF)**

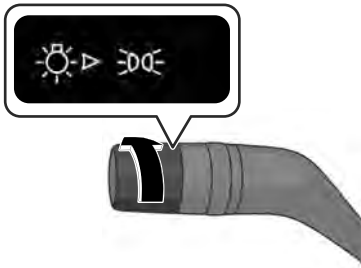

The parking lights, taillights, side-marker lights, and license plate lights turn on, and the parking lights indicator light  in the instrument cluster turns on.

The parking lights, taillights, side-marker lights, and the license plate lights are turned on by the auto headlight off function for a certain period of time.

**NOTE**

Do not leave the lights on while the engine is turned off. Otherwise, the lead-acid battery power could be depleted.

**Using the Headlights**

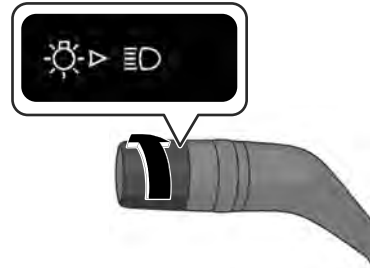

The headlights, parking lights, taillights, side-marker lights, and the license plate lights turn on, and the parking lights indicator light  in the instrument cluster turns on.

**Switching the Headlights to High Beams**



The headlights are switched to high beams and the headlight high-beam indicator light  in the instrument cluster turns on.

When the lever is returned to its original position, the headlights are switched to low beams.

**Flash-to-pass**



While the lever is being operated, the headlight high beams turn on and the headlight high-beam indicator light  in the instrument cluster turns on.

### Turning off the Lights

Turn the light switch to the **OFF** position when the vehicle is stopped.

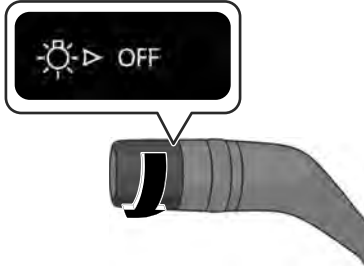

The light switch returns to the **AUTO** position automatically.

All the lights that are turned on turn off, and the parking lights indicator light  in the instrument cluster turns off.

### Headlight Leveling

The number of passengers and weight of cargo in the luggage compartment change the angle of the headlights. The angle of the headlights will be automatically adjusted when turning on the headlights. A system malfunction or operation conditions are indicated by a warning. Refer to Exterior Lights Warning Light on page 8-48.

## Convenient Ways to Use the Light Switch

### Coming Home Light

After the vehicle power is switched OFF, the headlights can be turned on for a while.

### Using the coming home light

1. Switch the vehicle power to ACC or OFF.
- 2.



The headlights turn on, and then turn off when any of the following conditions is met.

- A certain amount of time has passed since occupants got out of the vehicle and all the doors closed.
- Three minutes have passed since the headlights turned on.
- The light switch was operated after the headlights turned on.

### **NOTE**

The time until the headlights turn off can be changed. Refer to the Mazda Connect Owner's Manual or consult an Authorized Mazda Dealer.

### Leaving Home Light

The lights of your vehicle parked at a distance can be turned on by operating the key.

### Using the leaving home light

Press the unlock button on the key while the vehicle power is switched OFF.



When the vehicle receives a key operation signal, the headlights, parking lights, taillights, side-marker lights, and the license plate lights turn on.

The lights turn off when any of the following conditions is met.

- Thirty seconds have passed since the lights turned on.
- The light switch is set to the **OFF** position.
- The lock button on the key is pressed.



#### **NOTE**

The leaving home light can be set so that it does not operate. Refer to the Mazda Connect Owner's Manual or consult an Authorized Mazda Dealer.

## How to Use the Turn Signal Lever

When the lever is operated, the turn signal lights flash/turn off.

### Using the Turn Signal Lever

#### Turning left or right

Operate the lever to the 1 or 4 position.

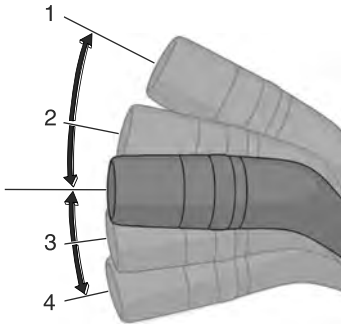

Each turn signal light flashes and the turn signal light  in the instrument cluster flashes. The lever returns to its original position in conjunction with the steering wheel operation. If it does not return, return it by hand.

#### Changing lanes

Operate the lever to the 2 or 3 position.

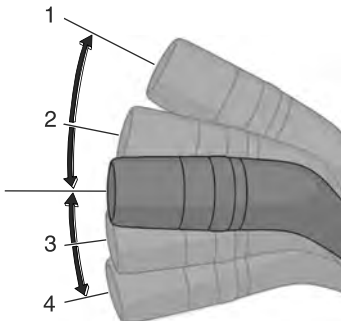

While the lever is in the 2 or 3 position, each turn signal light flashes and the turn signal light  in the instrument cluster flashes. If you move the lever to the 2 or 3 position and release it immediately, the three-flash turn signal operates and the turn signal light flashes 3 times.

#### NOTE

- The volume of the turn signal lever sound can be changed. Refer to the Mazda Connect Owner's Manual or consult an Authorized Mazda Dealer.
- The three-flash turn signal can be turned on/off. Refer to the Mazda Connect Owner's Manual or consult an Authorized Mazda Dealer.

## Windshield Wiper/ Washer Switch

When the switch or lever is operated, the windshield wiper/washer operates.

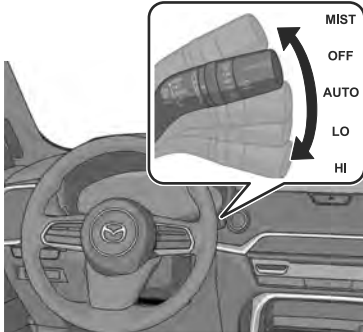

## Warning and Cautions for Using the Windshield Wiper/Washer Switch

### **! WARNING**

**In cold regions, use washer fluid containing anti-freeze. In addition, warm the windshield glass before spraying washer fluid during cold temperatures.**

If washer fluid not containing anti-freeze is used during cold temperatures, it will freeze on the windshield causing reduced visibility which may lead to an accident. Before spraying washer fluid, use the defroster to make sure that the windshield is sufficiently warmed up.

### **! CAUTION**

- When the windshield wipers are not used during freezing temperatures or for a long time, the wiper rubber may freeze to the glass. If the wipers are operated while frozen to the glass, it could damage the wiper rubber and motor.
- If the windshield wipers are operated while the windshield glass is dry, the glass could be scratched and the wiper rubber damaged. When the window glass is dry, spray washer fluid before operating the wipers.
- If the amount of washer fluid spray is insufficient, do not use the windshield washer switch. If the washer switch continues to be operated with no washer fluid being sprayed, it could lead to pump damage.

## Windshield Wiper/Washer Switch

- Do not cover the rain sensor by applying stickers or labels to the windshield. Otherwise, the sensor cannot detect the amount of rainfall.

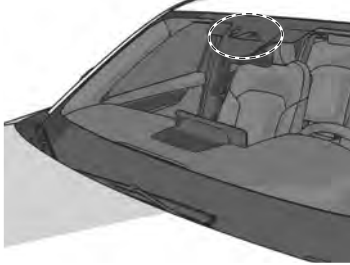

- When the vehicle power is switched ON and the wiper lever is in the AUTO position, the windshield wipers may operate automatically in the following cases:
  - The area of the windshield above the rain sensor is touched or wiped with a cloth.
  - The windshield or the rain sensor area in the cabin is hit.

When the vehicle power is switched ON and the wiper lever is in the AUTO position, do not touch the windshield or the windshield wipers. Otherwise, the windshield wipers will operate automatically which could catch your fingers or damage the windshield wipers. When removing ice or snow, or cleaning the windshield, always make sure the wiper lever is in the OFF position.

### How to Use the Windshield Wiper/Washer Switch

#### Using the Auto Wipers



#### 1. Indicator light

The indicator light of the lever turns on.

The windshield wipers operate automatically according to the rainfall amount.

#### **CAUTION**

Even if it is not raining, the windshield wipers may operate automatically in the following cases.

- The area of the windshield above the rain sensor is touched or wiped with a cloth.
- The windshield or the rain sensor area in the cabin is hit.

#### NOTE

- If a water repellent coating other than a genuine product is used, the rain sensor may not detect the rainfall amount correctly and the auto wipers may not operate normally. Do not use a water repellent coating other than a genuine product.

- If dirt or ice adheres to the top of the rain sensor on the windshield and the windshield wipers cannot remove the dirt or ice even after the wipers operate several times, the auto wipers will stop operating. If the auto wipers stopped, remove the dirt and ice from the windshield.
- The auto wipers could operate from the effect of strong light sources, electromagnetic waves, or infrared light because the rain sensor uses an optical sensor. It is recommended that the auto-wiper lever be switched to the **OFF** position other than when driving the vehicle under rainy conditions.

### Changing sensitivity of auto wipers

The rain sensitivity level can be adjusted by rotating the switch.

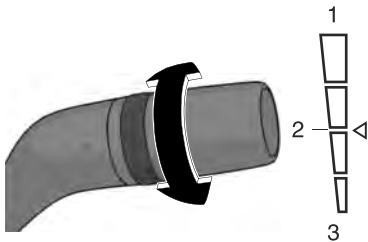

1. Higher sensitivity
2. Normal
3. Less sensitivity

### Using the Windshield Wipers

#### Using continuously



In the LO position, the windshield wipers operate at low speed. In the HI position, the wipers operate at high speed.

#### Using temporarily



The windshield wipers operate while the lever is in the MIST position. Set the lever to the MIST position and immediately release it to operate the windshield wipers only once.

### Stopping the Windshield Wipers

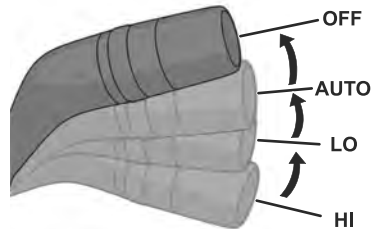

The windshield wipers stop.

### Using the Windshield Washer



While the windshield wipers move out of their stowed positions to the point where they start reversing back, the washer fluid is sprayed and the wipers operate several times.



# Windshield Wiper/Washer Switch

---

## NOTE

If you pull the wiper lever while the windshield wipers are reversing back to their stowed positions, the next time the washer fluid is sprayed is during the next cycle.

## How to Use the Rear Wiper/Washer Switch

### Using the Rear Wiper

#### Using intermittent operation



The wiper operates at regular intervals.

#### Using continuous operation



The wiper operates continuously.

### Stopping the Rear Wiper



The rear wiper stops.

### Using the Rear Washer



While the switch is in the  position, the washer fluid is sprayed and the wiper operates.

**NOTE**

When the windshield washer fluid is being sprayed, the rear washer fluid will not be sprayed even if the switch is operated.

## Rear Window Defogger Switch

---

### Rear Window Defogger Switch

The rear window defogger warms the rear window and removes fog. When the rear window defogger is operated, the following equipment operates in conjunction with it.

- Mirror defogger\*  
Refer to How to Use the Mirror Defogger on page 5-88.
- Windshield wiper de-icer\*  
Refer to How to Use the Windshield Wiper De-icer on page 5-89.

### Warnings and Cautions for Using the Rear Window Defogger Switch

#### CAUTION

- Be careful not to scratch the filaments when washing the rear window. The filaments are installed inside the rear window.
- Use the rear window defogger while the engine is running. In addition, do not use the rear window defogger for a long time. Otherwise, the lead-acid battery power could be depleted.

## How to Use the Rear Window Defogger Switch

### Using the Rear Window Defogger Switch

1. Start the engine.
- 2.



The rear window defogger operates and the switch indicator light turns on. The rear window defogger stops automatically after it operates for about 15 minutes.

#### **NOTE**

The rear window defogger operation time can be changed. Refer to the Mazda Connect Owner's Manual or consult an Authorized Mazda Dealer.

### Stopping the Rear Window Defogger

Press the rear window defogger switch while the rear window defogger is operating.

The rear window defogger stops and the switch indicator light turns off.

## Mirror Defogger\*

The mirrors are heated using heat filaments to remove fog.

## Rear Window Defogger Switch

---

### How to Use the Mirror Defogger

The mirror defoggers operate in conjunction with the rear window defogger.

For the operation method, refer to How to Use the Rear Window Defogger on page 5-87.

### Windshield Wiper De-icer\*

A part of the windshield is heated using heat filaments to melt the ice on the glass and wipers.

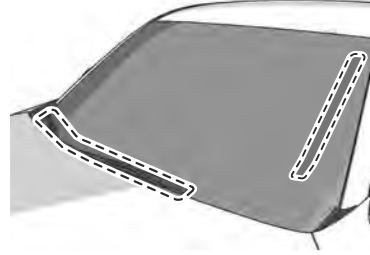

## How to Use the Windshield Wiper De-icer

The windshield wiper de-icers operate in conjunction with the rear window defogger.

For the operation method, refer to How to Use the Rear Window Defogger on page 5-87.

# Hazard Warning Lights

## Hazard Warning Lights



The hazard warning light switch is used when it is necessary to park the vehicle on a roadside due to a vehicle breakdown or other emergency.

## How to Use the Hazard Warning Lights

### Instrument Cluster (Type A)



**(The vehicle power is switched ON)**

All the turn signal lights flash, and the turn signal light  and the hazard warning light  in the instrument cluster flash.

**(The vehicle power is switched to ACC or OFF)**

All the turn signal lights flash and the hazard warning light  in the instrument cluster flashes.

Press the switch again to turn off the lights.

### Instrument Cluster (Type B)



All the turn signal lights flash and the turn signal light  in the instrument cluster flashes.

Press the switch again to turn off the lights.

## How to Use the Horn

Press the area around the  mark on the steering wheel.  
The horn sounds while it is pressed.



## Antilock Brake System (ABS)

The ABS prevents the wheels from locking, caused by braking on slippery roads, and maintains driving directional stability and ensures steerability.

### NOTE

- When depressing the brake pedal, slight vibration might be felt from the pedal. This vibration is a normal occurrence when the ABS operates.
- ABS does not operate at low speeds (about 10 km/h (6.2 mph) or slower).

## Warning and Cautions for Using the Antilock Brake System (ABS)

### **WARNING**

**Do not rely on the ABS as a substitute for safe driving.**

The ABS cannot compensate for unsafe and reckless driving, excessive speed, tailgating (following another vehicle too closely), driving on ice and snow, and hydroplaning (reduced tire friction and road contact because of water on the road surface). You can still have an accident.

### **CAUTION**

Always use tires of the specified size and type for the front and rear wheels. If a tire other than the specified size or type is installed, the ABS system may not operate normally.

## Traction Control System (TCS)

The TCS prevents drive-wheel spinning which occurs during acceleration from a stop or acceleration during cornering on slippery roads, such as wet or snow-covered roads, and assures optimum drive force and steerability.

## Warning and Cautions for Using the Traction Control System (TCS)

### WARNING

**Do not rely on the Traction Control System (TCS) as a substitute for safe driving.**

The Traction Control System (TCS) cannot compensate for unsafe and reckless driving, excessive speed, tailgating (following another vehicle too closely), and hydroplaning (reduced tire friction and road contact because of water on the road surface). You can still have an accident.

**Use snow tires or tire chains and drive at reduced speeds when roads are covered with ice and/or snow.**

Driving without proper traction devices on snow and/or ice-covered roads is dangerous. The Traction Control System (TCS) alone cannot provide adequate traction and you could still have an accident.

## How to Use the Traction Control System (TCS)

Switch the vehicle power ON.  
The TCS is operable.

When the TCS operates, the TCS/DSC operation indicator light  flashes.

### Stopping the TCS Operation

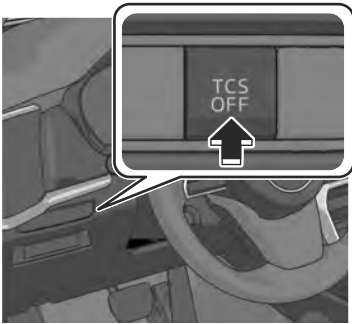

The TCS operation is canceled and the TCS OFF indicator light  in the instrument cluster and the TCS OFF switch indicator light turn on. Press the TCS OFF switch again to enable the TCS operation.

### NOTE

- If the engine is stopped while the TCS operation is canceled, the TCS becomes operational when the engine is started the next time.
- When the TCS is on and you attempt to free the vehicle from being stuck, the TCS will activate. Depressing the accelerator will not increase engine power and freeing the vehicle from being stuck might be difficult. When this happens, turn off the TCS.
- If the TCS is canceled and the following systems are operated, the TCS becomes operational.
  - Smart Brake Support (SBS)

- Mazda Radar Cruise Control (MRCC)
- Cruising & Traffic Support (CTS)
- If the TCS OFF switch is pressed and held for 10 seconds or longer, the TCS operation can no longer be turned off even if the TCS OFF switch is pressed. In this case, the TCS OFF switch will operate normally when the vehicle power is switched ON again after being switched OFF.

## Dynamic Stability Control (DSC)

The DSC automatically controls braking and engine power output in conjunction with systems such as the ABS and TCS to help control side slip when driving on slippery surfaces, or during sudden or evasive steering, which enhances vehicle stability. Also refer to Antilock Brake System (ABS) 5-92, Traction Control System (TCS) 5-93.

## Warning and Cautions for Using the Dynamic Stability Control (DSC)

### WARNING

**Do not rely on the Dynamic Stability Control as a substitute for safe driving.**

The Dynamic Stability Control (DSC) cannot compensate for unsafe and reckless driving, excessive speed, tailgating (following another vehicle too closely), and hydroplaning (reduced tire friction and road contact because of water on the road surface). You can still have an accident.

### CAUTION

- Heed the following cautions so that the DSC can operate normally.
  - Use the specified tire size and the same type of tire on all 4 wheels.
  - Do not use tires with significantly different wear patterns on the same vehicle.
- When using tires where the tire diameter is changed due to the installation of tire chains, or when installing an emergency spare tire, the DSC may not operate normally.

### How to Use the Dynamic Stability Control (DSC)

Drive the vehicle at a speed of about 20 km/h (13 mph) or faster.

The DSC is operable.

When the DSC operates, the TCS/DSC operation indicator light  flashes.

## Trailer Stability Control (TSC)

The TSC is a system that increases the stability of the vehicle during towing. When vehicle sway occurs during towing, the TSC controls the output of the brakes and the engine to suppress swaying.

## Warning and Cautions for Using the Trailer Stability Control (TSC)

### WARNING

#### **Do not rely solely on the Trailer Stability Control (TSC).**

Vehicle stability can be limited even if the Trailer Stability Control (TSC) is operating. Drive carefully to prevent accidents. In particular, if the TCS/DSC indicator light is flashing, drive the vehicle carefully as it is in a less stable condition and could sway more easily. Drive with caution and in accordance with the road, vehicle and trailer conditions.

### CAUTION

- The Trailer Stability Control (TSC) may not operate correctly unless the following are observed:
  - Use the specified tire size and the same type of tire on all 4 wheels.
  - Do not use tires with significantly different wear patterns on the same vehicle.
- The Trailer Stability Control (TSC) may not operate correctly when tire chains are used or a temporary spare tire is installed because the tire diameter changes.

### How to Use the Trailer Stability Control (TSC)

Drive the vehicle at a speed of 65 km/h (40 mph) or faster.

The TSC is operable.

When the TSC operates, the TCS/DSC operation indicator light  flashes.

#### NOTE

- The Trailer Stability Control (TSC) does not operate if there is a malfunction in the TCS/DSC (the TCS/DSC operation indicator light  turns on).
- When the Trailer Stability Control (TSC) is operating, the brake lights may turn on.
- For information regarding trailer towing, refer to Towing on page 7-57.

## Hill Descent Control\*

The hill descent control is a system that maintains a constant vehicle speed when the vehicle descends a steep slope, off-road or on a snowy road. As the low speed can be maintained without operating the accelerator pedal or the brake pedal, the driver can concentrate on the steering wheel operation.

## Warnings and Cautions for Using the Hill Descent Control

### WARNING

**Do not rely completely on the hill descent control.**

If necessary, depress the brake pedal on a slippery road surface such as extremely steep slopes, icy roads, or mud or gravel roads. Failure to maintain a constant low speed may result in an unexpected accident. Always drive carefully.





## How to Use the Hill Descent Control

### Using the Hill Descent Control

1. When the vehicle speed is about 25 km/h (15 mph) or slower, press the hill descent control switch.



The hill descent control is operable, and the hill descent control indicator light (white)  turns on.

2. Depress the accelerator pedal or the brake pedal to drive the vehicle at a speed between about 3 km/h and 20 km/h (2 and 12 mph).
3. Release the accelerator pedal or the brake pedal when the desired target speed is reached. The hill descent control operates, the hill descent control indicator light (white)  changes to the hill descent control indicator light (green) , and then the target speed is displayed.

The brake lights turn on while the hill descent control is operating.

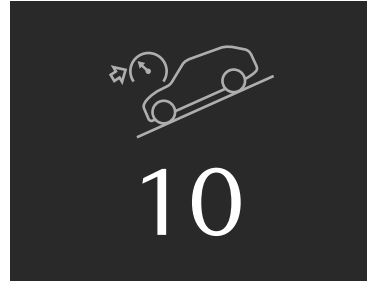

### NOTE

- If the braking system is overheated after using the hill descent control for a long time, the operation of the hill descent control may be temporarily stopped. When the operation of the hill descent control stops, a warning sound is activated and the hill descent control indicator light turns off.
- The hill descent control may not be available due to a system malfunction in the following cases. Have your vehicle inspected by an Authorized Mazda Dealer.
  - The hill descent control indicator light does not turn on even if the hill descent control switch is pressed.
  - The TCS/DSC operation indicator light turns on.
- The hill descent control is not available while Mazda Radar Cruise Control (MRCC) or Cruising & Traffic Support (CTS) is operating.

### **Canceling the Hill Descent Control**

Perform the following operations to cancel the hill descent control.

- Press the hill descent control switch.  
If the hill descent control switch is pressed while the hill descent control is operating, the hill descent control will be gradually released.
- Drive the vehicle at a vehicle speed of about 30 km/h (18 mph) or faster.

## Mazda intelligent Drive Select (Mi-Drive)

### Mazda intelligent Drive Select (Mi-Drive)

Mi-Drive is a system which switches the vehicle's drive mode depending on the driving conditions, road conditions, and vehicle conditions. Mi-Drive has the following driving modes.

#### TOWING Mode\*

This mode optimizes power performance. It reduces the loss of driving performance due to increased weight when towing a trailer and improves the vehicle stability.

#### SPORT Mode

This mode maximizes responsiveness. It increases vehicle response when the accelerator pedal is depressed and accelerates powerfully.

#### NORMAL Mode

This mode optimizes fuel efficiency.

#### OFF-ROAD Mode

This mode maximizes running performance. It prevents the drive wheels from spinning during off-road driving and improves the running performance. Use Off-road mode when driving on slippery roads such as muddy, sandy, or deep-snowy roads.

### Warning and Cautions for Using the Mazda intelligent Drive Select (Mi-Drive)

#### **WARNING**

#### **Do not rely completely on the Mi-Drive system.**

Vehicle stability is limited even when Mi-Drive is activated. Always drive the vehicle safely. Do not drive the vehicle recklessly, otherwise it may result in an accident.

#### **CAUTION**

- Do not use the sport mode when driving on slippery roads such as wet or snow-covered roads. It may cause tire slipping.
- Heed the following cautions so that the system can operate normally.
  - Use the specified tire size and the same type of tire on all 4 wheels.
  - Do not use tires with significantly different wear patterns on the same vehicle.
- Drive carefully when using tire chains. Because the diameter of the tires differs, the system may not operate normally.

## How to Use the Mazda intelligent Drive Select (Mi-Drive)

1. Push the Mi-Drive switch forward or pull it toward you.



2. While checking the list displayed in the instrument cluster, push the Mi-Drive switch forward or pull it toward you to select a drive mode.

### Instrument cluster (Type A)



### Instrument cluster (Type B)

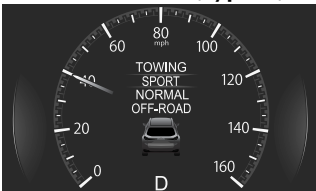

When the drive mode is set, the display in the instrument cluster changes.

### (TOWING Mode)\* Instrument cluster (Type A)



### Instrument cluster (Type B)

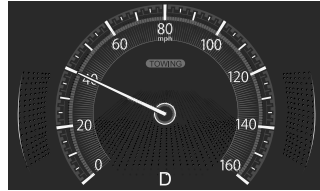

### (SPORT Mode) Instrument cluster (Type A)



### Instrument cluster (Type B)



### (NORMAL Mode) Instrument cluster (Type A)



### Instrument cluster (Type B)

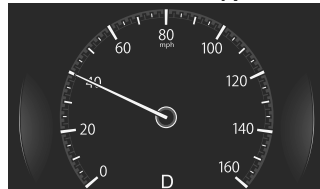

## Mazda intelligent Drive Select (Mi-Drive)

### (OFF-ROAD Mode) Instrument cluster (Type A)

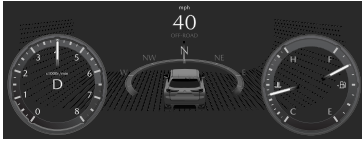

### Instrument cluster (Type B)

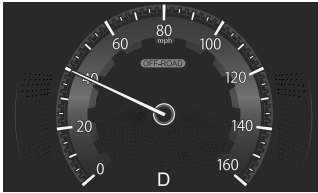

### NOTE

- TOWING mode can be selected only when electrically connected to the trailer using a Mazda genuine trailer hitch. In addition, it may take some time until the connection is detected and TOWING mode is displayed. Consult an Authorized Mazda Dealer for details.
- Depending on driving conditions when selecting TOWING mode/SPORT mode/OFF-ROAD mode, the vehicle may perform shift-down or accelerate slightly.
- When SPORT mode/OFF-ROAD mode is selected, driving the vehicle at higher engine speeds increases and fuel economy may worsen. Canceling SPORT mode/OFF-ROAD mode during normal driving is recommended.
- When setting the Mazda Radar Cruise Control (MRCC) while driving in SPORT mode, the mode is switched to NORMAL mode. In addition, while the MRCC is being used, the mode cannot be switched to SPORT mode.
- The drive mode cannot be switched in the following cases.

- The Antilock Brake System (ABS) is operating.
- The Traction Control System (TCS) is operating.
- The Dynamic Stability Control (DSC) is operating.
- The steering wheel is being operated abruptly.
- The driving mode in which the display in the instrument cluster is grayed out cannot be selected.
- When the vehicle power is switched OFF, the mode returns to NORMAL mode. However, TOWING mode before switching the vehicle power OFF is maintained only when the trailer is connected in TOWING mode.

## i-ACTIV AWD

AWD demonstrates superior driving performance on slippery surfaces such as snow-covered roads, sandy areas, mud, and steep slopes.

## Warnings and Cautions for Using the i-ACTIV AWD

### WARNING

**Do not rotate wheels that have left the ground due to the vehicle being stuck or in a ditch.**

The drive component can be seriously damaged, resulting in an accident. It can also lead to overheating, oil leakage, and fire.

### CAUTION

- This vehicle is not designed for off-road and rally driving. Do not drive over rough rocky roads and river beds.
- Unevenly worn tires, mismatched manufacturers, models, or brands can be different in size even if the printed size on the tire is the same. AWD functionality may be limited or potential damage to the AWD system may occur with tires of different sizes.
- Heed the following cautions so that the system can operate normally.
  - Use the specified tire size and the same type of tire on all 4 wheels.
  - Do not use tires with significantly different wear patterns on the same vehicle.

## Power Steering

The power steering operates while the engine is operating.

Even when the engine is stopped or the power steering system does not operate, steering is possible but the operation may feel heavier compared to normal.

## Tire Pressure Monitoring System (TPMS)

The TPMS monitors the air pressure of each tire and informs the driver of a decrease in the tire air pressure when it becomes lower than the specified air pressure.

For the TPMS, the air pressure data sent from the tire pressure sensors installed on each wheel via radio signal is received by the receiver unit in the vehicle to monitor the tire pressures.

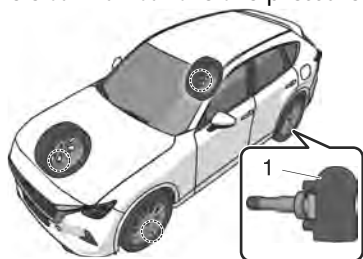

1. Tire pressure sensor

## Warning and Cautions for Using the Tire Pressure Monitoring System (TPMS)

### WARNING

**Do not drive the vehicle at high speeds if the TPMS warning light  is turned on or flashing.**

Driving the vehicle at high speeds while the TPMS warning light is turned on or flashing is dangerous because the brake performance and the steering wheel operability will be reduced. If the vehicle is driven at high speeds or the brakes are suddenly applied, it could lead to an accident. Gradually apply the brake and reduce the vehicle speed.

**Do not ignore the TPMS warning light  when it is turned on or flashing.**

Continuing to drive the vehicle while ignoring the illumination/flashing of the TPMS warning light is dangerous because a tire may burst which could lead to an accident. Take appropriate measures as soon as possible.



**⚠ CAUTION**

- Each tire, including the spare (if provided), should be checked monthly when cold and inflated to the inflation pressure recommended by the vehicle manufacturer on the vehicle placard or tire inflation pressure label. (If your vehicle has tires of a different size than the size indicated on the vehicle placard or tire inflation pressure label, you should determine the proper tire inflation pressure for those tires.) As an added safety feature, your vehicle has been equipped with a tire pressure monitoring system (TPMS) that illuminates a low tire pressure telltale when one or more of your tires is significantly under-inflated. Accordingly, when the low tire pressure telltale illuminates, you should stop and check your tires as soon as possible, and inflate them to the proper pressure. Driving on a significantly under-inflated tire causes the tire to overheat and can lead to tire failure. Under-inflation also reduces fuel efficiency and tire tread life, and may affect the vehicle's handling and stopping ability. Please note that the TPMS is not a substitute for proper tire maintenance, and it is the driver's responsibility to maintain correct tire pressure, even if under-inflation has not reached the level to trigger illumination of the TPMS low tire pressure telltale. Your vehicle has also been equipped with a TPMS malfunction indicator to indicate when the system is not operating properly.

The TPMS malfunction indicator is combined with the low tire pressure telltale. When the system detects a malfunction, the telltale will flash for approximately one minute and then remain continuously illuminated. This sequence will continue upon subsequent vehicle start-ups as long as the malfunction exists. When the malfunction indicator is illuminated, the system may not be able to detect or signal low tire pressure as intended. TPMS malfunctions may occur for a variety of reasons, including the installation of replacement or alternate tires or wheels on the vehicle that prevent the TPMS from functioning properly. Always check the TPMS malfunction telltale after replacing one or more tires or wheels on your vehicle to ensure that the replacement or alternate tires and wheels allow the TPMS to continue to function properly.

- To avoid false readings, the system samples for a little while before indicating a problem. As a result it will not instantaneously register a rapid tire deflation or blow out.

## How to Use the Tire Pressure Monitoring System (TPMS)

### Check the tire pressure

The current tire pressure can be checked on the center display. Refer to the Mazda Connect Owner's Manual or consult an Authorized Mazda Dealer.

### Low tire pressure warning

When a tire pressure of the specified air pressure or lower is detected, the TPMS warning light (⚠) turns on and a warning indication is displayed in the instrument cluster.

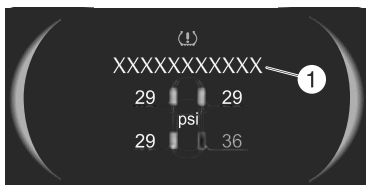

1. Message is displayed.

### **Action**

1. Adjust the tire pressure to the appropriate pressure. Refer to the Tires on page 10-69.



If the tire pressure is adjusted when the tire is warm, the tire pressure may lower below the specified pressure after cooling and the warning light may turn on. Adjust the air pressure of the tires when they are cold.

2. Make sure that the TPMS warning light (⚠) is turned off.
3. If the TPMS warning light (⚠) does not turn off, drive the vehicle for 3

- minutes or longer at a speed of 25 km/h (16 mph) or faster.
4. Make sure that the TPMS warning light (⚠) is turned off. If the TPMS warning light remains on even after adjusting the tire pressure, there is a possibility that the tire is flat.



When inspecting/adjusting the tire pressures, do not apply excessive force to the air valve of the tire pressure sensor. Otherwise, the tire pressure sensor could be damaged.

### When changing tires and wheels

When changing the tires or wheels (such as installing winter tires), it will be necessary to register the ID signal code of the tire pressure sensor to the TPMS.

Have an Authorized Mazda Dealer do the registration or register the ID signal codes of the tire pressure sensors using the following procedure.

### **NOTE**

The tire pressure sensors on each wheel have a unique ID signal code. For the TPMS to operate correctly, the ID signal codes of the tire pressure sensors need to be registered to the system.

1. Wait more than 19 minutes after changing a tire or wheel.
2. After more than 19 minutes have passed, drive the vehicle at a speed of 25 km/h (16 mph) or faster for 3 minutes or longer. While driving, the ID signal codes of the tire pressure sensors are automatically registered.

**NOTE**

If you drive the vehicle within 19 minutes of changing a tire or wheel, the TPMS warning light  will flash because the ID signal codes for the tire pressure sensors were not registered. In this case, stop the vehicle and register the ID signal codes of the tire pressure sensors following the procedure.

**When replacing tires and wheels**

- When replacing the tires and wheels, consult an Authorized Mazda Dealer. Otherwise, the tire pressure sensors could be damaged when replacing them.
- Do not install non-genuine wheels. If wheels other than genuine ones are installed, it may not be possible to install the tire pressure sensors.

When replacing a tire or wheel, always install the tire pressure sensor. The following combinations of tires, wheels, or tires and wheels are possible.

- The tire pressure sensor from the old wheel is removed and it is installed to the new wheel.
- Only a tire is replaced without replacing the tire pressure sensor and wheel.
- A new tire pressure sensor is installed to a new wheel.

**NOTE**

When installing a new tire pressure sensor, the ID signal code for the tire pressure sensor needs to be registered. For details on purchasing a tire pressure sensor and registering the ID signal of the tire pressure sensor, consult an Authorized Mazda Dealer.

## Warnings and Cautions for When the Refueling

### **WARNING**

**Always heed the following when refueling.**

- Turn off the engine.
- Keep sparks and flames away from the fuel-filler port.
- Wipe off any spilled fuel as soon as possible.

Otherwise, it could cause a fire or explosion because fuel or fuel vapor could ignite easily.

**Before refueling, make sure to discharge the static electricity in your body by touching a metal object on the vehicle body.**

An electrical discharge could ignite the fuel or cause serious burns.

**Always heed the following while refueling.**

- Always refuel the vehicle by yourself and do not allow other people to come close to the fuel-filler port.
- Do not go back inside the cabin or touch a person or object charged with static electricity.
- Do not use any electronic devices such as a mobile phone or Smartphone.

It could ignite the fuel or cause serious burns caused by the charged static electricity in your body again.

**When opening/closing the fuel-filler cap, always turn the fuel-filler cap by holding the knob of the fuel-filler cap.**

An electrical discharge could ignite the fuel or cause serious burns.

**Slowly open the fuel-filler cap, wait for any hissing to stop, then open the cap.**

If the fuel-filler cap is opened quickly, fuel may spray out and cause a fire. Spraying fuel can also be harmful if it gets in the eyes or on the skin.

**Do not breath fuel vapors.**

Toxic substances might be included in the fuel.

**Insert the refueling nozzle into the fuel-filler port securely.**

If the nozzle is not inserted sufficiently, it may delay the auto stop when the tank is full, resulting in the fuel spilling over and a possible fire.

**Do not continue fueling after it is stopped automatically.**

If you continue fueling, fuel may spill over causing a fire.

**Do not pull out the refueling nozzle immediately after the fuel is stopped automatically.**

The fuel remaining in the refueling nozzle may spill out and cause a fire.

**Securely close the fuel-filler cap.**

If the fuel-filler cap is not closed securely, fuel may leak while driving the vehicle which could cause a fire.

### **CAUTION**

- Follow the fueling instructions indicated at the gas station when refueling.

- Always close the door and windows when refueling. If a fire occurs with the doors or windows open, the flames may spread into cabin.
  - Do not spill fuel on the vehicle while refueling. It may cause discoloration, stains, or paint damage.
  - Do not use any non-genuine fuel-filler cap. Use of a non-genuine fuel-filler cap may lead to a malfunction in the fuel system or emission system.
- (U.S.A. and Canada)  
It may also cause the check engine light in the instrument cluster to illuminate.
- When using an automatic car wash or a high water pressure car wash, make sure that the fuel-filler lid is closed and lock the doors. Otherwise, the fuel-filler lid may open unexpectedly and become damaged.

- **(U.S.A. and Canada)**  
If the check fuel-filler cap warning light illuminates, the fuel-filler cap may not be properly installed. If the warning light illuminates, park your vehicle safely off the right-of-way, remove the fuel-filler cap and reinstall it correctly. After the cap has been correctly installed, the fuel-filler cap warning light may continue to illuminate until a number of driving cycles have been completed. A drive cycle consists of starting the engine (after four or more hours with the engine off) and driving the vehicle on city and highway roads. Continuing to drive with the check fuel-filler cap warning light illuminated could cause the check engine light to illuminate as well.

## Refueling

1. Close all the doors, and the liftgate.
2. Switch the vehicle power OFF.
3. Unlock the driver's door.
4. Press the fuel-filler lid.  
The fuel-filler lid opens.

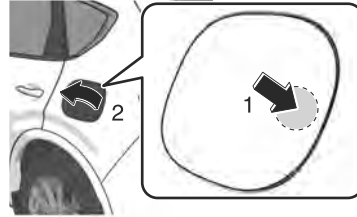

5. Slowly turn the fuel-filler cap.  
The fuel-filler cap opens.

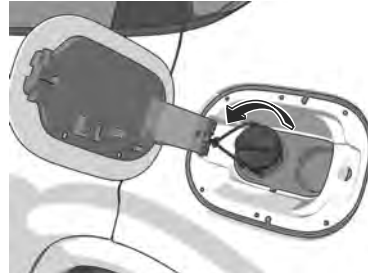

6. Place the fuel-filler cap on the fuel-filler lid holder.

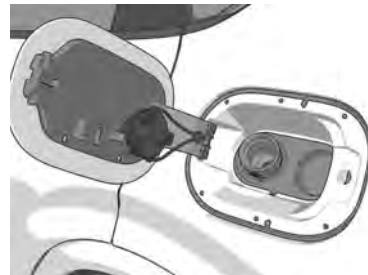

7. Insert the refueling nozzle all the way and begin refueling.
8. Turn the fuel-filler cap until a click sound is heard.
9. Close the fuel-filler lid.

**NOTE**

- If the fuel-filler lid is closed after locking the doors, the fuel-filler lid will not be locked.
- If the doors are locked by any of the following functions, the fuel-filler lid is also locked at the same time.
  - Vehicle speed sensing auto door lock function
  - Auto re-lock function

## Fuel Requirements

Vehicles with catalytic converters or oxygen sensors must use **ONLY UNLEADED FUEL**, which will reduce exhaust emissions and keep spark plug fouling to a minimum.

To achieve maximum engine performance, use the specified fuel.  
**(e-SKYACTIV G (STANDARD POWER))**

Fuel	Octane Rating* <sup>1</sup> (Anti-knock index)
Regular unleaded fuel	87 [(R+M)/2 method] or above (91 RON or above)

Fuel with a rating lower than 87 octane (91 RON) will negatively affect the emission control system performance and could also cause engine knocking and serious engine damage.

**(e-SKYACTIV G (HIGH POWER))**

Fuel	Octane Rating* <sup>1</sup> (Anti-knock index)
Premium unleaded fuel	91 [(R+M)/2 method] or above (96 RON or above)

Regular unleaded fuel with an octane rating from 87 to 90 (91 to 95 RON) can be used, but this will reduce performance slightly, such as reduced engine output, and engine knocking.

Fuel with a rating lower than 87 octane (91 RON) will negatively affect the emission control system performance and could also cause engine knocking and serious engine damage.

\*1 U.S. federal law requires that octane ratings be posted on gas station pumps.



➤ **USE ONLY UNLEADED FUEL.**

- Led fuel is harmful to the catalytic converter and oxygen sensors and will lead to deterioration of the emission control system and or failures.
- This vehicle can only use oxygenated fuels containing no more than 10 % ethanol by volume. Damage to the vehicle may occur when ethanol exceeds this recommendation, or if the gasoline contains any methanol. Stop using gasohol of any kind if your vehicle engine is performing poorly.
- Never add fuel system additives other than a Mazda genuine product, otherwise the emission control system could be damaged. Consult an Authorized Mazda Dealer for details.

Gasoline blended with oxygenates such as alcohol or ether compounds are generally referred to as oxygenated fuels. The common gasoline blend that can be used with

your vehicle is ethanol blended at no more than 10 %. Gasoline containing alcohol, such as ethanol or methanol, may be marketed under the name "Gasohol".

Vehicle damage and drivability problems resulting from the use of the following may not be covered by the warranty.

- Gasohol containing more than 10 % ethanol.
- Gasoline or gasohol containing methanol.
- Leaded fuel or leaded gasohol.



## Warnings and Cautions for Using the Fuel Requirements

### CAUTION

- **USE ONLY UNLEADED FUEL.**  
Leaded fuel is harmful to the catalytic converter and oxygen sensors and will lead to deterioration of the emission control system and/or failures.
- This vehicle can only use oxygenated fuels containing no more than 10 % ethanol by volume. Damage to the vehicle may occur when ethanol exceeds this recommendation, or if the gasoline contains any methanol. Stop using gasohol of any kind if your vehicle engine is performing poorly.
- Never add fuel system additives other than a Mazda genuine product, otherwise the emission control system could be damaged. Consult an Authorized Mazda Dealer for details.

## Emission Control System

This vehicle is equipped with an emission control system (the catalytic converter is part of this system) that enables the vehicle to comply with existing exhaust emissions requirements.

### NOTE

- Under U.S. federal law, any modification to the original-equipment emission control system before the first sale and registration of a vehicle is subject to penalties. In some states, such modification made on a used vehicle is also subject to penalties.
- While the engine is off, the sound of a valve opening and closing can be heard at the rear of the vehicle, however this does not indicate an abnormality. The vehicle has a self-checking device and it operates while the engine is off.

## Warnings and Cautions for Using the Emission Control System

### WARNING

**Never park over or near anything flammable.**

Parking over or near anything flammable, such as dry grass, is dangerous. Even with the engine turned off, the exhaust system remains very hot after normal use and could ignite anything flammable. A resulting fire could cause serious injury or death.

### CAUTION

Ignoring the following precautions could cause lead to accumulate on the catalyst inside the converter or cause the converter to get very hot. Either condition will damage the converter and cause poor performance.

- USE ONLY UNLEADED FUEL.
- Do not drive your Mazda with any sign of engine malfunction.
- Do not coast if the vehicle power is switched OFF.
- Do not descend steep grades in gear if the vehicle power is switched OFF.
- Do not operate the engine at high idle for more than 2 minutes.
- Do not tamper with the emission control system. All inspections and adjustments must be made by a qualified technician.
- Do not push-start or pull-start this vehicle.

## Warnings and Cautions for Engine Exhaust (Carbon monoxide)

### WARNING

**Do not drive your vehicle if you smell exhaust gas inside the vehicle:**

Engine exhaust gas is dangerous. This gas contains carbon monoxide (CO), which is colorless, odorless, and poisonous. When inhaled, it can cause loss of consciousness and death. If you smell exhaust gas inside the vehicle, keep all windows fully open and contact an Authorized Mazda Dealer immediately.

**Do not run the engine when inside an enclosed area:**

Running the engine inside an enclosed area, such as a garage, is dangerous. Exhaust gas, which contains poisonous carbon monoxide, could easily enter the cabin. Loss of consciousness or even death could occur.

**Open the windows or adjust the heating or cooling system to draw fresh air when idling the engine:**

Exhaust gas is dangerous. When the vehicle is stopped with the windows closed and the engine running for a long time even in an open area, exhaust gas, which contains poisonous carbon monoxide, could enter the cabin. Loss of consciousness or even death could occur.

**Clear snow from underneath and around your vehicle, particularly the tail pipe, before starting the engine:**

Running the engine when a vehicle is stopped in deep snow is dangerous. The exhaust pipe could be blocked by the snow, allowing exhaust gas to enter the cabin. Because exhaust gas contains poisonous carbon monoxide, it could cause loss of consciousness or even death to occupants in the cabin.

## i-ACTIVSENSE

i-ACTIVSENSE is a collective term covering a series of advanced safety and driver support systems. i-ACTIVSENSE consists of two technologies, active safety and pre-crash safety technologies.

## Warnings and Cautions for Using the i-ACTIVSENSE

### WARNING

**Do not rely completely on the i-ACTIVSENSE system.**

The i-ACTIVSENSE system is designed to assist the driver in safer driving by reducing the load on the driver and helping to avert collisions or reduce their severity.

Because each i-ACTIVSENSE system has its limitations, always drive carefully.

## **Active Safety Technology**

Active safety technology supports driver's safer driving and helps to prevent accidents from occurring. Active safety technology includes driver awareness support systems and driving support systems.

### **Driver Awareness Support Systems**

Driver awareness support systems assist in the recognition of roads, signs, vehicle surroundings, and driver fatigue.

Driver awareness support systems include the following systems.

#### **Nighttime visibility**

Adaptive Front Lighting System (AFS)..... page 5-138  
High Beam Control System (HBC)..... page 5-139

#### **Left/right side and rear detection**

Lane Departure Warning System (LDWS)..... page 5-143  
Blind Spot Monitoring (BSM).....  
..... page 5-146

#### **Road sign recognition**

Traffic Sign Recognition System (TSR)..... page 5-151

#### **Inter-vehicle distance recognition**

Distance & Speed Alert (DSA) .....  
..... page 5-154

#### **Forward obstruction detection when accelerating at an intersection**

Front Cross Traffic Alert (FCTA) .....  
..... page 5-164

#### **Rear obstruction detection when leaving a parking space**

Rear Cross Traffic Alert (RCTA).....  
..... page 5-167

#### **Full-surround recognition**

360° View Monitor..... page 5-224

#### **Driver fatigue detection**

Driver Attention Alert (DAA) .....  
..... page 5-156  
Driver Monitoring (DM).... page 5-159

#### **Driver Support Systems**

Driver support systems assist in acceleration, deceleration, and steering operations while driving. Driver support systems include the following systems.

#### **Inter-vehicle distance**

Mazda Radar Cruise Control (MRCC)..... page 5-169

#### **Inter-vehicle distance and lane keeping**

Cruising & Traffic Support (CTS).....  
..... page 5-182

#### **Lane departure**

Lane Keep Assist System (LAS) .....  
..... page 5-204

#### **Lane keeping**

Emergency Lane Keeping (ELK) .....  
..... page 5-207

## Pre-crash Safety Technology

Pre-crash safety technology is designed to assist in collision avoidance in situations where it is difficult for the driver to avert it, and to reduce damage from a collision if it occurs. Pre-crash safety technology includes the following systems.

### Collision avoidance support and damage reduction

Smart Brake Support (SBS) .....  
..... page 5-214

### Collision damage reduction

Secondary Collision Reduction .....  
..... page 5-244

## i-ACTIVSENSE Status Symbol (Warning/Risk Avoidance Support System)

### Instrument cluster (Type A)

The i-ACTIVSENSE Status Symbol (Warning/Risk Avoidance Support System) indicates the status of some i-ACTIVSENSE systems.

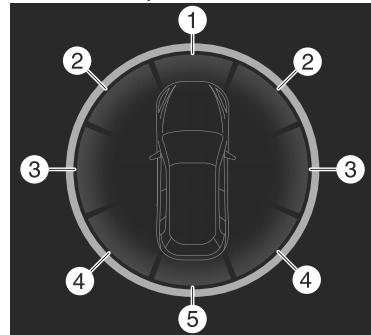

1. Front related system status
2. Front-side related system status
3. Side related system status
4. Rear-side related system status
5. Rear related system status

### Target system display of the i-ACTIVSENSE status symbol (Warning/risk avoidance support system)

#### **Front related systems**

The following systems are front related systems.

- Traffic Sign Recognition System (TSR)
- Distance & Speed Alert (DSA)
- Smart Brake Support (SBS) forward detection function
- Smart Brake Support (SBS) Turn-Across Traffic
- Smart Brake Support (SBS) Head-on collision mitigation

- Emergency Lane Keeping (ELK)  
Head-on traffic avoidance assist

### Front-side related system

The following systems are front-side related systems.

- Front Cross Traffic Alert (FCTA)
- Smart Brake Support (SBS) Front Crossing

### Side related system

The following systems are side related systems.

- Lane Departure Warning System (LDWS)
- Lane-keep Assist System (LAS)
- Emergency Lane Keeping (ELK) Road Keep Assist

### Rear-side related system

The following systems are rear-side related systems.

- Blind Spot Monitoring (BSM)
- Blind Spot Monitoring (BSM) Vehicle Exit Warning
- Rear Cross Traffic Alert (RCTA)
- Emergency Lane Keeping (ELK) Blind Spot Assist
- Smart Brake Support (SBS) Rear Crossing

### Rear related system

The following system is a rear related system.

- Smart Brake Support (SBS) rearward detection function

### How to view the i-ACTIVSENSE status symbol (Warning/risk avoidance support system)

If all target systems are on.

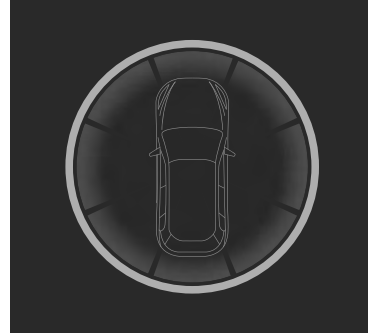

Display example if all target systems are not on.

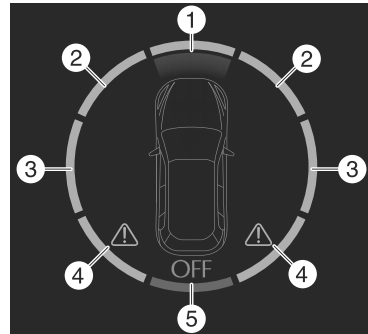

1. All front related systems are on.
2. Some front-side related systems have stopped functioning (amber).
3. Some side related systems are off (green).
4. Some rear-side related systems are malfunctioning.
5. All rear related systems are off.

The warning sounds are muted by the i-ACTIVSENSE mute switch.

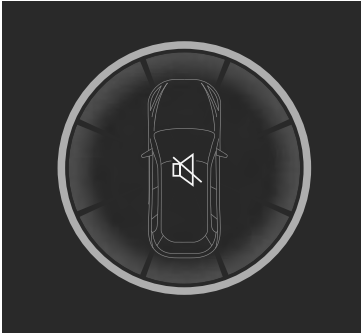

The warning sounds are not muted by the i-ACTIVSENSE mute switch.

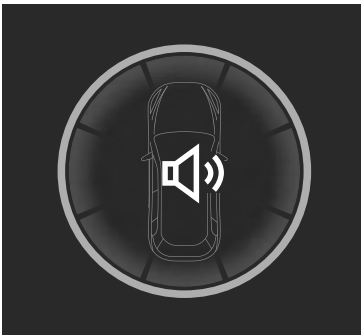





### **Instrument cluster (Type B)**



The i-ACTIVSENSE status symbol (Warning/risk avoidance support system) indicates the operating status of the following systems using the color or OFF indication.



- Blind Spot Monitoring (BSM)
- Blind Spot Monitoring (BSM) Vehicle Exit Warning
- Traffic Sign Recognition System (TSR)
- Distance & Speed Alert (DSA)
- Front Cross Traffic Alert (FCTA)
- Rear Cross Traffic Alert (RCTA)
- Lane Departure Warning System (LDWS)

- Lane-keep Assist System (LAS)
- Emergency Lane Keeping (ELK) Road Keep Assist
- Emergency Lane Keeping (ELK) Blind Spot Assist
- Emergency Lane Keeping (ELK) Head-on traffic avoidance assist
- Smart Brake Support (SBS) forward detection function
- Smart Brake Support (SBS) Turn-Across Traffic
- Smart Brake Support (SBS) Front Crossing
- Smart Brake Support (SBS) Head-on collision mitigation
- Smart Brake Support (SBS) rearward detection function
- Smart Brake Support (SBS) Rear Crossing

**i-ACTIVSENSE status symbol (Warning/risk avoidance support system) (white)**  /  (system standby status)

If all systems do not meet the operation conditions, or if any system has stopped functioning, the i-ACTIVSENSE status symbol (Warning/risk avoidance support system) (white)  /  is displayed.



**i-ACTIVSENSE status symbol (Warning/risk avoidance support system) (green)**  /  (system operation status)



If any system meets the operation conditions, the i-ACTIVSENSE status symbol (Warning/risk avoidance support system) (green)  /  is displayed.







**NOTE**

Even if the i-ACTIVSENSE status symbol (Warning/risk avoidance support system) (green) is displayed, systems which do not meet the operation conditions will not operate.

**i-ACTIVSENSE status symbol (Warning/risk avoidance support system) (amber)**  /  (system malfunction status)

If any system has a malfunction, the i-ACTIVSENSE status symbol (Warning/risk avoidance support system) (amber) \*1 /  is displayed.

**i-ACTIVSENSE OFF symbol (Warning/risk avoidance support system)**  /  (system stop status)

If all systems are turned off using Mazda Connect, the i-ACTIVSENSE OFF symbol (Warning/risk avoidance support system) \*1 /  is displayed.

\*1 Displays when i-ACTIVSENSE warning sound is switched off.  
Refer to How to Use the i-ACTIVSENSE mute switch on page 5-124.

**How to Use the i-ACTIVSENSE mute switch\***



When the i-ACTIVSENSE mute switch is pressed while the following systems are operating, the warning sound deactivates.

- Lane Departure Warning System (LDWS)
- Blind Spot Monitoring (BSM)
- Blind Spot Monitoring (BSM) Vehicle Exit Warning
- Traffic Sign Recognition System (TSR)
- Front Cross Traffic Alert (FCTA)
- Rear Cross Traffic Alert (RCTA)

Press the i-ACTIVSENSE mute switch again to return to the previous operation status.

**NOTE**

If the vehicle power is switched OFF with each system warning sound turned off using the i-ACTIVSENSE mute switch, each system automatically turns on the next time the vehicle power is switched ON.

## Forward Sensing Camera (FSC)

The Forward Sensing Camera (FSC) determines the conditions ahead of the vehicle and detects the white (yellow) lines on the traffic lane.

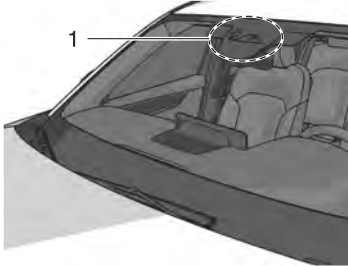

1. Forward Sensing Camera (FSC)

The following systems utilize the Forward Sensing Camera (FSC).

- High Beam Control System (HBC)
- Lane Departure Warning System (LDWS)
- Traffic Sign Recognition System (TSR)
- Distance & Speed Alert (DSA)
- Driver Attention Alert (DAA)
- Mazda Radar Cruise Control (MRCC)
- Cruising & Traffic Support (CTS)
- Lane-keep Assist System (LAS)
- Emergency Lane Keeping (ELK)
- Smart Brake Support (SBS) forward drive detection

### **! WARNING**

**Do not modify the suspension:**

If the vehicle height or inclination is changed, the system will not be able to correctly detect vehicles ahead. This will result in the system not operating normally or mistakenly operating, which could cause a serious accident.

### **! CAUTION**

Heed the following cautions to operate the system correctly.

- Do not hit or apply strong force to the Forward Sensing Camera (FSC) or the area around it. If the Forward Sensing Camera (FSC) received a strong impact, stop using the following systems and consult an Authorized Mazda Dealer.
  - High Beam Control System (HBC)
  - Lane Departure Warning System (LDWS)
  - Traffic Sign Recognition System (TSR)
  - Distance & Speed Alert (DSA)
  - Driver Attention Alert (DAA)
  - Mazda Radar Cruise Control (MRCC)
  - Cruising & Traffic Support (CTS)
  - Lane-keep Assist System (LAS)
  - Emergency Lane Keeping (ELK)
  - Smart Brake Support (SBS) forward drive detection
- Do not remove the Forward Sensing Camera (FSC) cover.
- Be careful not to scratch the Forward Sensing Camera (FSC) lens or allow it to get dirty. Also, do not take the camera apart. Otherwise, it may cause a malfunction or mis-operation.
- The direction of the Forward Sensing Camera (FSC) has been finely adjusted, therefore do not change the installation position or remove the Forward Sensing Camera (FSC). Otherwise, it may cause a malfunction or mis-operation.
- Consult an Authorized Mazda Dealer regarding cleaning of the camera lens.
- Do not place objects on the dashboard which reflect light.

## Forward Sensing Camera (FSC)

---

- Do not apply accessories, stickers, or film to the windshield near the Forward Sensing Camera (FSC). If the area in front of the Forward Sensing Camera (FSC) lens is obstructed, it will cause the system to not operate correctly even if it is transparent.
- Always keep the windshield glass around the Forward Sensing Camera (FSC) clean by removing dirt or fogging. If the windshield is fogged, press the windshield defroster switch.
- The Forward Sensing Camera (FSC) includes a function for detecting a soiled windshield and informing the driver, however, depending on the conditions, it may not detect plastic shopping bags, water or snow on the windshield. In such cases, the system cannot accurately determine a vehicle or obstruction in front and may not be able to operate normally. Always drive carefully and pay attention to the road ahead.
- When cleaning the windshield, do not allow glass cleaners or similar cleaning fluids to get on the Forward Sensing Camera (FSC) lens. In addition, do not touch the Forward Sensing Camera (FSC) lens.
- Consult an Authorized Mazda Dealer regarding cleaning the interior side of the windshield around the Forward Sensing Camera (FSC).
- If there are cracks or damage caused by flying gravel or debris on the windshield, always have the windshield replaced. Consult an Authorized Mazda Dealer before replacing the windshield.
- Consult an Authorized Mazda Dealer before doing repairs around the Forward Sensing Camera (FSC).

- When doing repairs around the rearview mirror, consult an Authorized Mazda Dealer.
- Use the specified tire size and the same type of tire on all 4 wheels. In addition, do not use tires with significantly different wear patterns or tire pressures on the same vehicle (including temporary spare tire).

### NOTE

- If the Forward Sensing Camera (FSC) does not function normally due to fog or the vehicle being driven towards the sun, the functions related to the Forward Sensing Camera (FSC) are temporarily stopped. In this case, the following warning indications turn on. However, this does not indicate a problem.
  - HBC warning indication
  - i-ACTIVSENSE warning indication
  - SBS OFF indication
- If the Forward Sensing Camera (FSC) does not function normally due to high temperatures, the functions related to the Forward Sensing Camera (FSC) are temporarily stopped. In this case, the following warning indications turn on. However, this does not indicate a problem. Cool down the area around the Forward Sensing Camera (FSC) such as by turning on the air conditioner.
  - HBC warning indication
  - i-ACTIVSENSE warning indication
  - SBS OFF indication

- When the Forward Sensing Camera (FSC) detects that the windshield is dirty or foggy, the functions related to the Forward Sensing Camera (FSC) are temporarily stopped. In this case, the following warning indications turn on. However, this does not indicate a problem. Remove the dirt from the windshield or press the windshield defroster switch.
  - HBC warning indication
  - i-ACTIVSENSE warning indication
  - SBS OFF indication

### **Detection of pedestrians**

The Forward Sensing Camera (FSC) detects pedestrians when all of the following conditions are met.

- The height of a pedestrian is about 1 to 2 meters.
- The outline of a pedestrian is recognized such as the head, both shoulders, or the feet.

The Forward Sensing Camera (FSC) may not be able to detect pedestrians when any of the following conditions is met.

- There are multiple pedestrians.
- A pedestrian is close to a separate object.
- A pedestrian is crouching, lying, or slouching.
- A pedestrian suddenly jumps into the road.
- A pedestrian is holding something (such as an open umbrella or large baggage).
- A pedestrian blends into the background (such as in a dark location at night or by wearing clothes matching the background color).

### **Detection of objects**

When any of the following conditions is met, the Forward Sensing Camera (FSC) may not be able to detect target objects correctly, and each system may not operate normally.

- You are driving your vehicle at the same speed as the vehicle ahead.
- The headlights of your vehicle are not turned on during the night or in a tunnel.
- The target object is in the blind spot of the Forward Sensing Camera (FSC).
- A person or object bursts onto the road from the shoulder or cuts right in front of you.
- The distance between your vehicle and the target object is extremely close or extremely far.
- You change the course and approach a target object.
- The target object (vehicle ahead, white line (yellow line), sign) is dirty or worn.
- A vehicle ahead has a special shape (such as a vehicle carrier).
- A vehicle ahead is a truck with a low loading platform.
- A vehicle ahead has an extremely low or high profile.
- A vehicle ahead is outside the illumination range of the headlights.
- The illumination area of the taillights of the vehicle ahead is small.
- The taillights of a vehicle ahead are dim or turned off.
- The headlights of an on-coming vehicle are dim or turned off.
- Under bad weather conditions (rain, fog, and snow).
- Front visibility is reduced (due to a vehicle ahead casting off water, snow, or sand).

## Forward Sensing Camera (FSC)

---

- Strong light is directed at the front of your vehicle (such as backlight and high-beam headlights).
  - The surrounding area is dark (such as during the night, early evening, or early morning, or in a tunnel or indoor parking lot).
  - There are light sources in the surrounding area (such as street lamps, illuminated signboards, and traffic signals).
  - There are objects which reflect light (such as reflective plates and signs) in the surrounding area.
  - The surrounding brightness suddenly changes (such as when entering or exiting a tunnel).
  - The brightness of the headlights of your vehicle is insufficient (such as the illumination is weakened due to a dirty lens or the optical axis is deviated).
  - Tires other than the specified size are used on your vehicle (such as when tire chains or temporary spare tires are used).
  - The tires on your vehicle have significantly different wear.
  - Foreign matter is stuck to the windshield (such as ice, fog, snow, frost, raindrops, dirt, or a piece of plastic).
  - The windshield is dirty or fogged.
  - The Forward Sensing Camera (FSC) is blocked by an obstruction, causing poor forward visibility (such as when roof rails are installed to the vehicle and a long object is loaded).
  - The windshield washer is being used.
  - The windshield wipers are not used when it is raining.
  - Your vehicle is tilted (such as when heavy luggage is in the luggage compartment or on the rear seat).
- The vehicle is making a sharp curve, or ascending or descending a steep slope.
  - The vehicle is driven on a road with sharp curves or up and down (wavy) slopes.
  - The vehicle is driven on uneven roads.
  - The vehicle is driven next to walls with no patterning (including fences and longitudinally striped walls).
  - There is a strong reflection of light from the road surface.

## Radar Sensors

The radar sensor detects objects by sending radio waves in a specific direction and receiving the reflected waves back.

### Vehicle front



1. Front radar sensor
2. Front side radar sensors\*

### Vehicle rear



1. Rear side radar sensors

### **⚠ CAUTION**

- Heed the following cautions so that the radar sensors can function normally.
  - Do not modify the suspensions.
  - Use the specified tire size and the same type of tire on all 4 wheels. In addition, do not use tires with significantly different wear patterns or tire pressures on the same vehicle (including temporary spare tire).

- Do not spray highly pressurized water against the radar sensors or rub them strongly.
- Do not apply stickers on parts near the radar sensors.
- If foreign matter adheres to parts near the radar sensors, remove it and switch the vehicle power OFF. The foreign matter detection status is reset by switching the vehicle power OFF.
- Consult an Authorized Mazda Dealer if you need to repair, replace, or paint parts near the radar sensors.
- Do not install any parts that cover the front of the radar sensors.
- Do not replace the radiator grille and emblem with anything other than genuine products.
- If strong force is applied to parts near the radar sensors, the direction of the radar sensor may become deviated and each system may not operate normally. Stop each system immediately and have the vehicle inspected by an Authorized Mazda Dealer.

### NOTE

- The radar sensors include a function for detecting abnormalities in the sensor, soiling of the sensor's front surface, and informing the driver. If a message appears on the screen that can be addressed, follow the directions of the message.

### Front radar sensor

The following systems utilize the front radar sensor.

- Distance & Speed Alert (DSA)
- Mazda Radar Cruise Control (MRCC)
- Cruising & Traffic Support (CTS)

- Smart Brake Support (SBS) forward drive detection

## NOTE

- When driving on roads with few vehicles ahead, a message may temporarily be displayed on the screen indicating that the front radar sensor is dirty.
- When the vehicle is driven on roads in which there is an elevated road on one side, the front radar sensor function may be restricted temporarily.
- If the lead-acid battery power is weak, the front radar sensor detection function may decrease and each system may not operate normally.
- When any of the following conditions is met, the front radar sensor may not be able to detect vehicles ahead or obstructions correctly.
  - During inclement weather.
  - Front visibility is reduced.
  - The vehicle is driven near facilities or objects emitting strong radio waves.
  - The rear surface of a vehicle ahead does not reflect radio waves effectively.
  - A vehicle ahead has limited areas that can reflect radio waves.
  - Your vehicle is tilted.
  - Foreign matter is adhering to parts near the front radar sensor.
- When any of the following conditions is met, the front radar sensor may detect vehicles in the adjacent lane or surrounding obstructions, or it may not be able to detect vehicles ahead or obstructions.

- The vehicle is entering or exiting a curve.
- The vehicle is driven on a continuously curving road.
- The vehicle is driven on roads with repeated up and downslopes.
- The vehicle is driven on roads with narrow lanes.
- The vehicle is driven on poor roads or unpaved roads.
- The vehicle ahead enters the front radar sensor's blind spot.
- The distance to the vehicle ahead is extremely close.
- The vehicle ahead is being driven in an unstable condition.
- A vehicle suddenly comes close such as by cutting into your lane.

## Front side radar sensors

The following system utilizes front side radar sensors.

- Front Cross Traffic Alert (FCTA)
- Smart Brake Support (SBS) Front Crossing

## NOTE

- When any of the following conditions is met, the front side radar sensors may not be able to detect target objects.
  - During inclement weather.
  - The vehicle is driven on a sharp curve or on bumpy roads.
  - Radar sensor from an adjacent vehicle causes radio wave interference.
  - The detection range of a front side radar sensor is obstructed by an adjacent wall or vehicle, or the radar is reflected.
  - A vehicle suddenly enters the detection range from the front or side of your vehicle.

- The target object is extremely small.
- The target object is extremely low/high.
- A vehicle approaches while turning.
- A vehicle that has stopped suddenly starts to move.
- Multiple objects move at the same time.
- The bumper around a front side radar sensor is deformed.
- Foreign matter is adhering to the bumper around a front side radar sensor.
- The temperature near a front side radar sensor is extremely hot.
- The front side radar sensors may not detect the following target objects.
  - Animals.
  - Pedestrians.
  - Bicycles and small motorcycles moving at a low speed.
  - Shopping carts.
  - Stationary objects on the road or roadside.
  - Vehicles with shapes that may not reflect radar waves.

### **Rear side radar sensors**

The following systems utilize rear side radar sensors.

- Blind Spot Monitoring (BSM)
- Blind Spot Monitoring (BSM) Vehicle Exit Warning
- Rear Cross Traffic Alert (RCTA)
- Smart Brake Support (SBS) Rear Crossing
- Emergency Lane Keeping (ELK) Blind Spot Assist

### **NOTE**

- When any of the following conditions is met, the rear side radar sensors may not be able to detect target objects.
  - During inclement weather.
  - The vehicle is driven on a sharp curve or on bumpy roads.
  - Radar sensor from an adjacent vehicle causes radio wave interference.
  - The detection range of a front side radar sensor is obstructed by an adjacent wall or vehicle, or the radar is reflected.
  - A vehicle suddenly enters the detection range from the front or side of your vehicle.
  - The target object is extremely small.
  - The target object is extremely low/high.
  - A vehicle approaches while turning.
  - A vehicle that has stopped suddenly starts to move.
  - Multiple objects move at the same time.
  - The bumper around a rear side radar sensor is deformed.
  - Foreign matter is adhering to the bumper around a rear side radar sensor.
  - The temperature near a rear side radar sensor is extremely hot.
  - When towing a trailer.
- The rear side radar sensors may not detect the following target objects.
  - Animals.
  - Pedestrians.
  - Bicycles and small motorcycles moving at a low speed.
  - Shopping carts.
  - Stationary objects on the road or roadside.



## Radar Sensors

---

- Vehicles with shapes that may not reflect radar waves.
- A vehicle is traveling alongside your vehicle at nearly the same speed for an extended period of time.

## Ultrasonic Sensors\*

The ultrasonic sensors detect objects by sending ultrasonic waves in a specific direction and receiving the reflected waves back.

### Front ultrasonic sensors\*



### Rear ultrasonic sensors



### Detection ranges of ultrasonic sensors

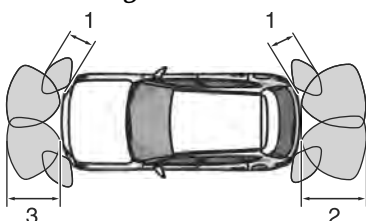

1. About 50 cm (20 in)
2. About 1 m 50 cm (59 in)
3. About 1 m (39.3 in)

## CAUTION

- Heed the following cautions so that the ultrasonic sensors can function normally.
  - Do not modify the suspensions.
  - Do not spray highly pressurized water against the ultrasonic sensors or rub them strongly.
  - Do not apply stickers on the ultrasonic sensors.
  - Consult an Authorized Mazda Dealer if you need to repair, replace, or paint the bumper.
- Depending on the type of target object and surrounding conditions, the distance at which the ultrasonic sensors can detect target objects may be shortened or the target objects may not be detected. Always confirm the safety around the vehicle visually when driving.
- If strong force is applied to parts near the ultrasonic sensors, the direction of the ultrasonic sensor may become deviated and each system may not operate normally. Stop each system immediately and have the vehicle inspected by an Authorized Mazda Dealer.

## NOTE

- The ultrasonic sensors include a function for detecting abnormalities in the sensor, soiling of the sensor's front surface, and informing the driver. If a message appears on the screen that can be addressed, follow the directions of the message.
- When any of the following conditions is met, the ultrasonic sensors may not be able to detect target objects, and each system may not operate normally.

- Target object is thin such as wire, rope, or poles.
- Target object absorbs waves easily such as cotton or snow.
- Target object has an angular shape.
- Target object is tall and wide at the upper part.
- Target object height is low.
- There are multiple target objects.
- Target objects are too close to the sensors.
- Ice, snow, or mud is adhering to the sensor area.
- Heavy rainfall or pressurized water is applied to the sensor area.
- The sensor areas are frozen.
- You cover the sensor with your hand.
- The area around the sensor has received a strong impact.
- The vehicle is excessively tilted.
- Under extremely hot or cold weather.
- Approached by an object that generates ultrasonic waves, such as the horn of another vehicle, the engine noise of a motorcycle, the air brake noise of a large vehicle, or the sensor of another vehicle.
- A commercially-available fender pole or an antenna for a radio transmitter is installed to the vehicle.
- The vehicle is moving towards a tall or square curbstone, or a steep grade.
- The vehicle is moving towards an uneven wall or stairs.
- The vehicle is driven in a place with low ceilings.
- The vehicle is driven on bumpy roads, inclines, gravel roads, dense grass, or grating.

- The ultrasonic sensor does not detect target objects directly beneath the bumper. Even if target objects which are located at a position lower than an ultrasonic sensor have been detected, the ultrasonic sensor may suddenly stop detecting as the vehicle approaches the target object.

### Front ultrasonic sensors

The following systems utilize front ultrasonic sensors.

- Parking Sensor

### Rear ultrasonic sensors

The following systems utilize rear ultrasonic sensors.

- Smart Brake Support (SBS) reverse drive detection
- Parking Sensor

## Cameras

The cameras shoot images of the area surrounding the vehicle.

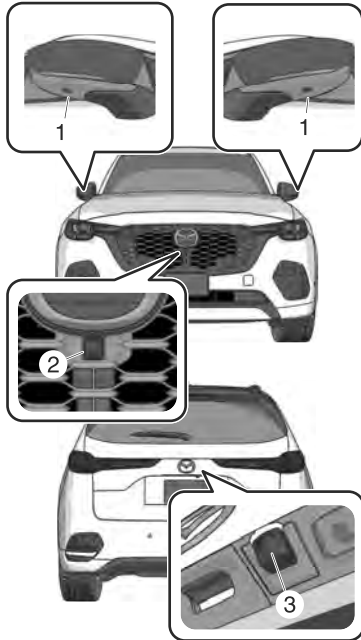

1. Side cameras\*
2. Front camera\*
3. Rear camera

### **⚠ CAUTION**

- Do not disassemble, modify, or remove a camera.
- Consult an Authorized Mazda Dealer if you need to repair, replace, or paint parts near the cameras.
- If strong force is applied to a camera, the camera position and the installation angle may shift. Have your vehicle inspected by an Authorized Mazda Dealer.
- Heed the following cautions so that the cameras can function normally.
  - Do not modify the suspensions.

- Always use wheels of the specified size for the front and rear wheels. Consult an Authorized Mazda Dealer for tire replacement.
- Do not apply oil film remover, organic solvents, wax or coating agents, because the camera cover is made of hard plastic. If any such agent is applied, wipe it off using a soft cloth immediately.
- Do not rub a camera cover forcefully with an abrasive or hard brush. The camera cover or lens might be scratched which might affect the images.
- If the lens of the camera is badly damaged by flying gravel, replace the camera. For the camera replacement, consult an Authorized Mazda Dealer.
- Depending on the type of target object and surrounding conditions, the distance at which the camera can detect target objects may be shortened or the target objects may not be detected. Always confirm the safety around the vehicle visually when driving.

### NOTE

- Do not apply stickers and do not install accessories or illuminated number/character license plates to the area around a camera. Otherwise, the camera may not correctly display the surrounding conditions.
- If a camera is affected by excessive changes in temperature such as pouring hot water on the camera during cold weather, the camera may not operate normally.

- The cameras include a function for detecting abnormalities in the camera, soiling of the camera's front surface, and informing the driver. If a message appears on the screen that can be addressed, follow the directions of the message.
- If there are water droplets, snow, or mud on the camera lens, wipe it off using a soft cloth. If the camera lens is especially dirty, wash it off with mild detergent.

### **Front camera**

The following system uses the front camera.

- 360° View Monitor

### **Side cameras**

The following system uses the side cameras.

- 360° View Monitor

### **Rear camera**

The following systems use the rear camera.

- Smart Brake Support (SBS) reverse drive detection
- 360° View Monitor
- Rear View Monitor

### **Detection of pedestrians**

The rear camera detects pedestrians when all of the following conditions are met.

- The height of a pedestrian is about 1 to 2 meters.
- The outline of a pedestrian is recognized such as the head, both shoulders, or the feet.

If any of the following conditions is met, the rear camera may not be able to accurately detect pedestrians and the Smart Brake Support (SBS) reverse

drive detection may not operate correctly.

- There are multiple pedestrians.
- A pedestrian is close to a separate object.
- A pedestrian is crouching, lying, or slouching.
- A pedestrian suddenly jumps into the road.
- A pedestrian is holding something (such as an open umbrella or large baggage).
- A pedestrian blends into the background (such as in a dark location at night or by wearing clothes matching the background color).
- The surrounding area is dark (such as during the night, early evening, or early morning, or in a tunnel or indoor parking lot).
- Foreign matter is adhering to the rear camera (water droplets, snow, mud).
- The rear camera is exposed to strong light (sunlight, vehicle headlights).

## Driver Monitoring Camera\*

The driver monitoring camera detects changes in the driver's facial features and estimates the driver's condition.

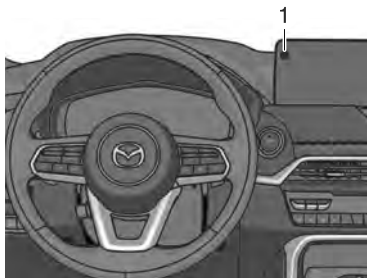

### 1. Driver monitoring camera

The following systems use the driver monitoring camera.

- Driver Monitoring (DM)
- Smart Brake Support (SBS) forward detection function
- Driver Personalization System
- Cruising & Traffic Support (CTS)

### NOTE

- Each system may not operate normally if any of the following conditions is met.
  - You are wearing glasses or sunglasses
  - A cap or hat you are wearing partially blocks the driver monitoring camera's view of your eyes, you have long bangs partially covering your eyes, or a part of your face is invisible due to a scarf, face mask, beard, or hand.
  - The lighting conditions change significantly (such as backlight, light from the side, direct light from the setting sun, or the headlights of on-coming vehicles)

- Device that emits near-infrared light is used in the cabin.
- The temperature in the cabin is high.
- The driver monitoring camera is blocked by hands or arms.
- There is more than one face in the detection range of the driver monitoring camera, such as when the front passenger or a rear seat passenger leans forward.
- The driver's face is far out of the detection range of the driver monitoring camera, such as when the driver's face is put outside of the window.
- The camera does not take photographic images and operates on numeric information only.

## Adaptive Front Lighting System (AFS)

The adaptive front lighting system (AFS) automatically adjusts the headlight beams to the left or right in conjunction with the operation of the steering wheel after the headlights have been turned on.

## How to Use the High Adaptive Front Lighting System (AFS)

### Operating the AFS

The AFS operates when all of the following conditions are met.

- The vehicle speed is about 2 km/h (2 mph) or higher.

### Turning off the AFS

The AFS can be turned off using Mazda Connect.

Refer to the Settings section in the Mazda Connect Owner's Manual.

## High Beam Control System (HBC)

The HBC determines the conditions in front of the vehicle while driving at night to automatically switch the headlights between high and low beams.

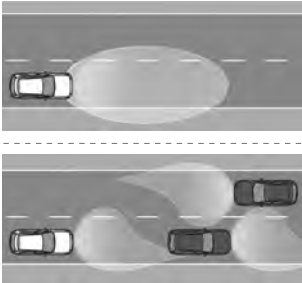



### Warnings and Cautions for Using the High Beam Control System (HBC)



#### CAUTION

- Heed the following cautions so that the HBC can operate normally.
  - Do not modify the suspensions.
  - Do not modify the headlight units.
  - Do not remove the Forward Sensing Camera (FSC).
- Do not rely completely on the system and switch the headlights between the high and low beams manually if necessary.

## How to Use the High Beam Control System (HBC)

### NOTE

- The distance in which the HBC can detect objects varies depending on the surrounding conditions.
- The Forward Sensing Camera (FSC) may not be able to detect target objects correctly, and the HBC may not operate normally.  
Refer to Forward Sensing Camera (FSC) on page 5-125.

### Using the HBC

Make sure that the light switch is in the AUTO position.



The HBC determines the surrounding conditions and operates automatically. When the HBC operates, the HBC indicator light (green)  in the instrument cluster turns on.

### **Switching the headlights to high beams**

The HBC switches the headlights to high beams when all of the following conditions are met.

- The vehicle speed is about 30 km/h (19 mph) or faster.
- The system does not detect a vehicle ahead.

### **Switching the headlights to low beams**

The HBC switches the headlights to low beams when any of the following conditions is met.

- The vehicle speed is less than about 20 km/h (12 mph).
- When driving in areas with a continuous line of street lamps or on roads in well-lit cities and towns.
- The system detects the headlights of a vehicle ahead.

### Canceling the HBC during operation

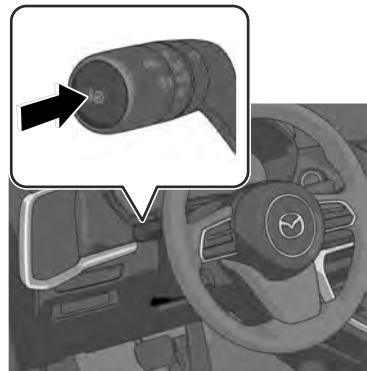

When the HBC is canceled, the HBC indicator light (green)  in the instrument cluster turns off. Press the HBC switch again to make the HBC operable.

### NOTE

If the vehicle power is switched OFF with the HBC turned off, the HBC automatically turns on the next time the vehicle power is switched ON.

## High Beam Control System (HBC)

---

### Turning off the HBC

The HBC can be turned off using Mazda Connect.

Refer to the Settings section in the Mazda Connect Owner's Manual.

## Lane Departure Warning System (LDWS)

The LDWS notifies the driver that the vehicle might be deviating from its lane. If there is a possibility of your vehicle deviating from the vehicle lane, a screen display and a warning sound notify the driver of the danger.

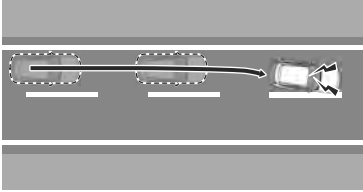

## Warnings and Cautions for Using the Lane Departure Warning System (LDWS)

### **WARNING**

**Do not rely completely on the LDWS.**

- The LDWS has limitations. Do not rely completely on the system and always stay on course using the steering wheel.
- The LDWS is not designed to compensate for a driver's lack of caution and relying on the system could lead to an accident.

### **CAUTION**

Heed the following cautions so that the LDWS can operate normally.

- Do not modify the suspensions.
- Always use wheels of the specified size for the front and rear wheels. Consult an Authorized Mazda Dealer for tire replacement.

## How to Use the Lane Departure Warning System (LDWS)

### LDWS operates

The LDWS operates when all of the following conditions are met.

- The vehicle speed is about 64 km/h (40 mph) or faster.
- The system detects white (yellow) lane lines.
- The CTS steering assist function is not operating.
- The system determines that the vehicle may depart from the lane.

When the LDWS is operating, a screen display and a warning sound (steering wheel vibration and warning sound) notify the driver of the danger.

### Instrument cluster (Type A)

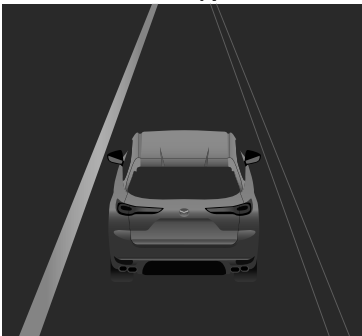

### Instrument cluster (Type B)

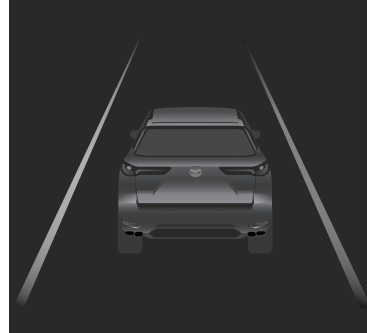

### Active driving display



### NOTE

- The LDWS operates only on the side that detects white lines (yellow lines).
- The forward sensing camera (FSC) may not be able to detect target objects correctly, and the LDWS may not operate normally. Refer to Forward Sensing Camera (FSC) on page 5-125.
- The LDWS warning type can be changed using Mazda Connect. Refer to the Settings section in the Mazda Connect Owner's Manual.

### LDWS is temporarily canceled

If any of the following conditions is met, the LDWS is canceled. In addition, the LDWS is automatically enabled when the condition changes and the system is operable.

- The turn signal lever is operated.
- The accelerator pedal is operated.
- The steering wheel is operated.
- The brake pedal is depressed.

## **Turning off the warning sound**

There are 2 ways to turn off the warning sound while the LDWS is operating.

- Turn off the warning sound using Mazda Connect.  
Refer to the Settings section in the Mazda Connect Owner's Manual.
- Turn off the warning sound using the i-ACTIVSENSE mute switch.  
Refer to How to Use the i-ACTIVSENSE mute switch on page 5-124.

## **Turning off the LDWS**

The LDWS can be turned off using the Mazda Connect.  
Refer to the Settings section in the Mazda Connect Owner's Manual.

When the LDWS is turned off, the LAS & LDWS OFF indicator  turns on.

## Blind Spot Monitoring (BSM)

### Blind Spot Monitoring (BSM)

The BSM is a system that assists the driver in checking for vehicles at your rear when making a lane change. When a vehicle approaching from the rear is detected, various screen displays and warning sounds notify the driver of the danger.

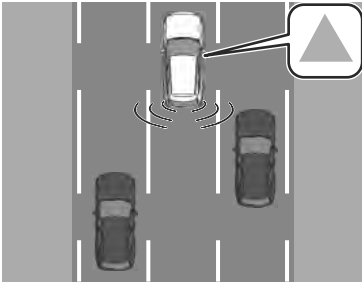

#### With Vehicle Exit Warning\*

The vehicle exit warning is a system that assists the driver in checking the rear of the vehicle when exiting the vehicle. When a vehicle or bicycle approaching from the rear is detected, various screen displays and warning sounds notify the driver of the danger.

### Warnings and Cautions for Using the Blind Spot Monitoring (BSM)

#### **! WARNING**

#### **Always check the surrounding area visually before making a lane change.**

The BSM is a system to assist the driver in checking the area to the rear of the vehicle when making a lane change. Due to certain limitations with the operation of system, the BSM warning lights may not flash or it might be delayed even though a vehicle is in an adjacent lane. Always make it your responsibility as a driver to check the rear.

#### **Always check the surrounding area visually when getting out of the vehicle.**

The vehicle exit warning is a system that assists the driver in checking the area to the rear of the vehicle when exiting the vehicle. Due to certain limitations with the operation of system, the BSM warning lights may not flash or it might be delayed even though a vehicle is in the area around your vehicle. Always make it your responsibility as a driver to check the rear.

## How to Use the Blind Spot Monitoring (BSM)

### When the BSM operates

The BSM operates when all of the following conditions are met.

- The vehicle speed is about 10 km/h (6.2 mph) or faster.
- The system detects an approaching vehicle.

When the BSM operates, the driver is notified of the presence of an approaching vehicle using the BSM warning lights and a screen display (white)<sup>\*1</sup>.

### BSM warning light

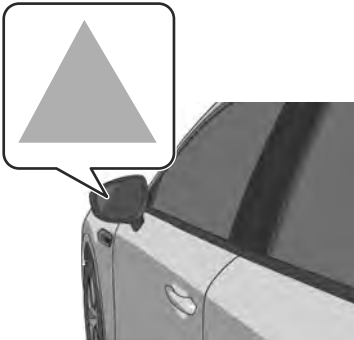

### Instrument cluster (Type A)

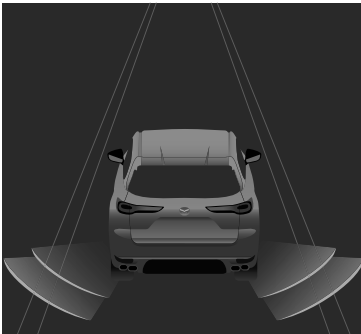

### Instrument cluster (Type B)

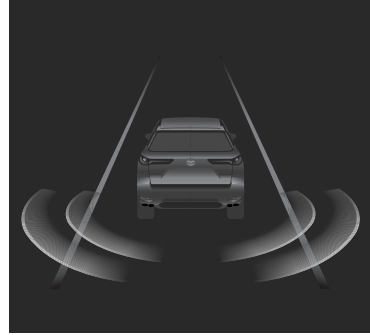

### Active driving display



\*1 The instrument cluster screen display (white) is displayed only when the instrument cluster is set to the i-ACTIVSENSE display.

When the turn signal lever is operated in the direction in which an approaching vehicle is detected, the driver is notified of the danger by flashing of the BSM warning lights, the warning sound, and the warning indication (amber).

### BSM warning light

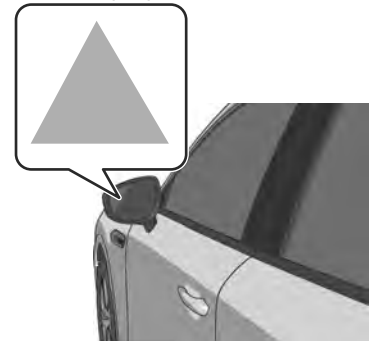



## Blind Spot Monitoring (BSM)

### Instrument cluster (Type A)

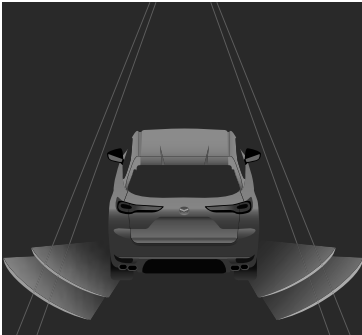

### Instrument cluster (Type B)

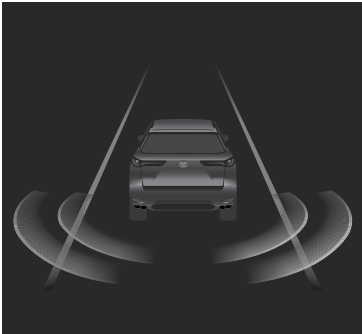

### Active driving display



### NOTE

- The BSM may not operate normally if any of the following conditions is met.
  - The rear side radar sensors cannot detect an object.  
Refer to Radar Sensors on page 5-129.
  - The road is on a steep slope.
  - The road is extremely wide.
  - You make a lane change 2 lanes or more.

- The BSM may operate when turning at intersections in urban areas or with stationary objects on the road or the roadside (such as guardrails, sidewalks, and parked vehicles).
- If a Mazda genuine trailer hitch is used, the BSM is automatically turned off when the trailer's electrical connector is connected.
- When pulling a trailer other than with a Mazda genuine trailer hitch, or while an accessory such as a bicycle carrier is installed to the rear of the vehicle, turn off the BSM. Otherwise, the radar's radio waves will be blocked causing the BSM to not operate normally.
- The brightness of the BSM warning lights is linked to the panel light control.  
Refer to Dashboard Illumination on page 5-30.

### When the Vehicle Exit Warning operates

The Vehicle Exit Warning operates when all of the following conditions are met.

- The vehicle is stopped.
- Within 3 minutes after the vehicle power is switched OFF or the vehicle power is switched ON.
- The system detects an approaching vehicle.

When the Vehicle Exit Warning operates, the driver is notified of the presence of an approaching vehicle using the warning lights and the instrument cluster screen display (white)\*1.

**BSM warning light**

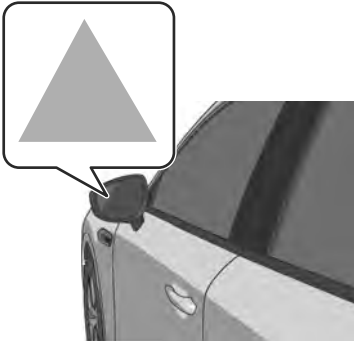

**Instrument cluster (Type A)**

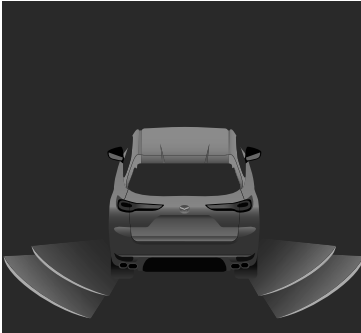

**Instrument cluster (Type B)**



\*1 The instrument cluster screen display (white) is displayed only when the instrument cluster is set to the i-ACTIVSENSE display. However, when the vehicle power is OFF,

the instrument cluster screen display (white) is not displayed.

In addition, when the door in the direction in which an approaching vehicle is detected is opened, the driver is notified of the danger by flashing of the warning lights, the warning sound, and the instrument cluster warning indication (amber).

**BSM warning light**

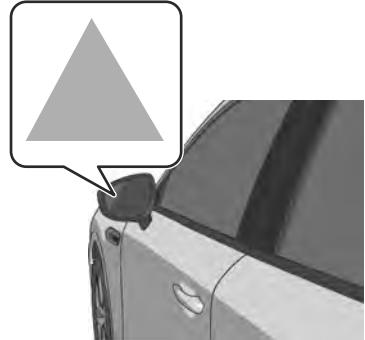

**Instrument cluster (Type A)**

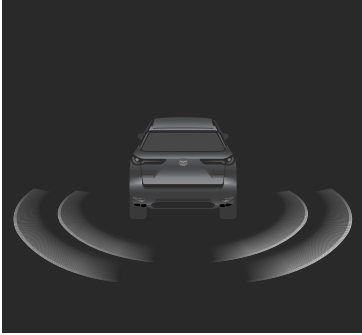

**Instrument cluster (Type B)****NOTE**

- The Vehicle Exit Warning may not operate normally if any of the following conditions is met.
  - The rear side radar sensors cannot detect an object.  
Refer to Radar Sensors on page 5-129.
  - There is a parked vehicle near your vehicle.
  - Moving objects are slow.
- The Vehicle Exit Warning is not automatically turned off even if a Mazda genuine trailer hitch is used.
- If a trailer is towed or a bicycle carrier is attached to the rear of the vehicle, the radar signal may be blocked and the Vehicle Exit Warning may not operate correctly.
- The Vehicle Exit Warning may operate with stationary objects on the road or the roadside (such as guardrails, sidewalls, and parked vehicles).
- The brightness of the BSM warning lights is linked to the panel light control.  
Refer to Dashboard Illumination on page 5-30.

**Turning off the warning sound**

There are 2 ways to turn off the warning sound while the BSM and the Vehicle Exit Warning is operating.

- Turn off the warning sound using Mazda Connect.  
Refer to the Settings section in the Mazda Connect Owner's Manual.
- Turn off the warning sound using the i-ACTIVSENSE mute switch.  
Refer to How to Use the i-ACTIVSENSE mute switch on page 5-124.

**Turning off the BSM and the Vehicle Exit Warning**

The BSM and the Vehicle Exit Warning can be turned off using the Mazda Connect.

Refer to the Settings section in the Mazda Connect Owner's Manual.

## Traffic Sign Recognition System (TSR)\*

The TSR is a system to notify the driver of traffic signs by displaying traffic signs on the screen which are recognized by the vehicle while driving.

## Warnings and Cautions for Using the Traffic Sign Recognition System (TSR)

### **WARNING**

**Always check the traffic signs visually while driving.**

Depending on weather and traffic sign conditions, the TSR may not recognize traffic signs or it may display them differently. Always make it your responsibility as a driver to check the actual traffic signs. Otherwise, it could result in an accident.

## How to Use the Traffic Sign Recognition System (TSR)

### NOTE

- The TSR operates even if the SD card of the navigation system is not inserted, but a traffic sign different from the actual traffic sign may be displayed.
- The TSR may not operate normally if any of the following conditions is met.
  - The Forward Sensing Camera (FSC) does not detect traffic signs correctly. Refer to Forward Sensing Camera (FSC) on page 5-125.
  - **(Vehicles with navigation system)**
    - The map has not been updated to the latest version.
    - The speed limit sign included in the map is inaccurate.
    - The map does not contain a speed limit sign.
    - The vehicle position in the navigation system is deviated.
- The TSR may display signs at the same time in any of the following patterns.
  - Displays only a single traffic sign at the same time.
  - Displays a speed limit sign and conditional speed sign at the same time (when the system cannot accurately determine the conditional speed sign).
  - Displays a speed limit sign and a speed sign ahead at the same time.
  - Displays a speed limit sign and either a stop/do not enter sign at the same time.

- Display of the TSR on the Active Driving Display can be disabled. Refer to the Settings section in the Mazda Connect Owner's Manual.

### Update related devices

Update the map data regularly to maintain the performance of the TSR. For updating the map data, refer to the Navigation System Owner's Manual. If the Forward Sensing Camera (FSC) needs updating, consult an Authorized Mazda Dealer.

### Speed limit signs (Including auxiliary signs) are displayed

When any of the following conditions is met, the speed limit sign  recognized by the system is displayed on the screen.

- The vehicle passes a recognized sign.
- The speed limit sign stored in the navigation system is read by the system while driving.

### NOTE

- If the system cannot recognize a speed limit sign, display of the speed limit sign stops.
- If the system does not correctly recognize any conditional sign,  is displayed.
- When the speed limit sign indication changes, a notification sound is activated. This notification sound can be turned off using Mazda Connect or the i-ACTIVSENSE mute switch. Refer to the Settings section in the Mazda Connect Owner's Manual. Refer to How to Use the i-ACTIVSENSE mute switch on page 5-124.
- If the system recognizes a conditional speed sign such as school zone, that sign is displayed.

### **A do not enter sign is displayed**

If the system recognizes a do not enter sign, the do not enter sign  is displayed on the screen.

#### **NOTE**

The screen display ends after a certain amount of time has passed since the vehicle passed the sign.

### **A stop sign is displayed**

When your vehicle is traveling at a certain speed or slower, the stop sign  recognized by the system is displayed on the screen.

#### **NOTE**

The screen display ends after a certain period of time has passed since the sign was displayed on the screen.

### **Turning off the TSR**

The TSR can be turned off using the Mazda Connect.  
Refer to the Settings section in the Mazda Connect Owner's Manual.

## **Convenient Ways to Use the Traffic Sign Recognition System (TSR)**

You can set an excessive speed warning to be issued when your vehicle's speed exceeds the speed indicated on the speed limit sign.

Turn on the excessive speed warning using Mazda Connect.  
Refer to the Settings section in the Mazda Connect Owner's Manual.

If your vehicle's speed exceeds the speed on the speed limit sign, the area around the display of the speed limit

sign flashes in amber  and a warning sound is activated. In addition, if the vehicle speed continues to be excessive, it stops flashing and remains on.

The warning sound can be turned off using Mazda Connect or the i-ACTIVSENSE mute switch.  
Refer to the Settings section in the Mazda Connect Owner's Manual.  
Refer to How to Use the i-ACTIVSENSE mute switch on page 5-124.

#### **NOTE**

The warning pattern and the warning activation timing can be changed using Mazda Connect.  
Refer to the Settings section in the Mazda Connect Owner's Manual.

## Distance & Speed Alert (DSA)

The DSA is a system in which the screen display notifies the driver that the distance between your vehicle and a vehicle ahead is close.

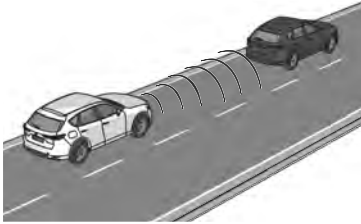

## Warnings and Cautions for Using the Distance & Speed Alert (DSA)

### **WARNING**

#### **Do not rely completely on the DSA.**

The DSA may not be able to detect a vehicle ahead depending on the type of vehicle ahead and its conditions, the weather conditions, and the road conditions. In addition, the system is not for maintaining the distance between your vehicle and a vehicle ahead. If you neglect to operate the accelerator and brake pedals correctly, it could lead to an accident.

Always check the surrounding conditions and depress the brake pedal or accelerator pedal while keeping a safe distance from a vehicle ahead or a vehicle following behind you.

## How to Use the Distance & Speed Alert (DSA)

### Operating the DSA

The DSA operates when all of the following conditions are met.

- The vehicle speed is about 30 km/h (19 mph) or faster.
- The system determines that the distance to the vehicle ahead is close.

When the DSA operates, the screen display notifies the driver that the distance between your vehicle and a vehicle ahead is close.

#### **Instrument cluster (Type A)**

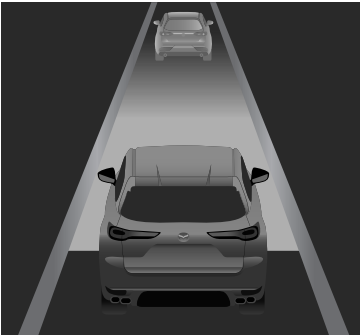

#### **Instrument cluster (Type B)**

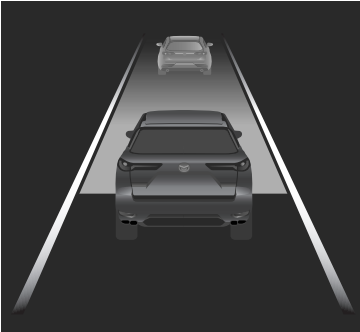

### **Active driving display**



### **NOTE**

- The objects which operate the DSA are four-wheeled vehicles. However, the DSA may also operate in the presence of motorcycles and bicycles.
- The DSA does not operate on stopped vehicles.
- When the speed of the vehicle ahead is extremely slow, the DSA may not operate normally.

### **Turning off the DSA**

The DSA can be turned off using the Mazda Connect. Refer to the Settings section in the Mazda Connect Owner's Manual.



# Driver Attention Alert (DAA)

---

## Driver Attention Alert (DAA)

The DAA is a system that can help detect driver fatigue and decreased attentiveness based on various types of vehicle information, and encourages the driver to take a rest using a screen display and warning sound.

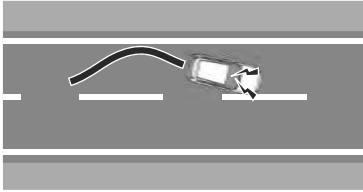

## Warnings and Cautions for Using the Driver Attention Alert (DAA)

### **WARNING**

**Do not rely completely on the DAA.**

The DAA does not prevent driver fatigue or decreased attentiveness and over reliance on the system could lead to an accident. Drive carefully and turn the steering wheel appropriately. In addition, the system may not be able to correctly detect driver fatigue or decreased attentiveness depending on the road and driving conditions. The driver must take sufficient rest in consideration of safe driving.

## How to Use the Driver Attention Alert (DAA)

### Operating the DAA

The DAA operates when all of the following conditions are met and the system detects driver fatigue or decreased attentiveness based on deviation from the learned vehicle information.

- The system detects white (yellow) lane lines.
- One hour has passed since driving began.
- The vehicle speed is about 65 km/h to 140 km/h (41 mph to 86 mph) for more than 20 minutes.
- The system has completed an initial learning of vehicle information based on driving behavior during that driving session.

When the DAA is operating, the screen display and a warning sound will notify the driver that his/her attention level has decreased.

### **Instrument cluster (Type A)**

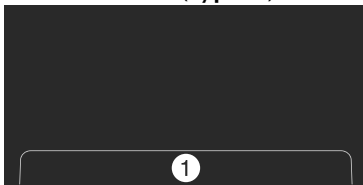

1. "Time for a Break"

### **Instrument cluster (Type B)**

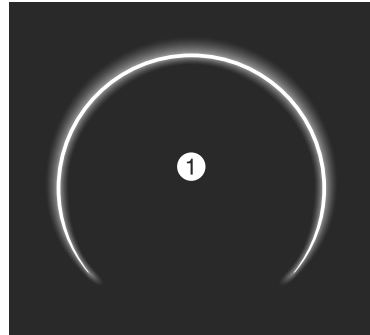

1. "Time for a Break"

### **NOTE**

- Driver behavior information from this feature is not transmitted outside the vehicle. The DAA does not operate if any of the following conditions is met.
  - The vehicle is making a sharp turn.
  - The vehicle is changing lanes.
- The DAA may not operate normally if any of the following conditions is met.
  - The visibility of white (yellow) lane lines is poor.
  - The vehicle is jolted or swayed continuously by strong winds or rough roads.
- The DAA detects driver fatigue and decreased attentiveness based on vehicle information when driving the vehicle at a vehicle speed between about 65 km/h and about 140 km/h (41 mph to 86 mph) for about 20 minutes. The learned vehicle information is reset and driver behavior information deleted when any of the following conditions is met.
  - The vehicle is stopped for 15 minutes or longer.

## Driver Attention Alert (DAA)

---

- The vehicle is driven at less than about 65 km/h (41 mph) for about 30 minutes.
- The vehicle power is switched OFF.
- After the DAA has displayed the first message encouraging rest, it does not display the next one until 60 minutes have passed.

### **Turning off the DAA**

Turn off the DAA using Mazda Connect.

Set in the Mazda Connect "Settings" or consult an Authorized Mazda Dealer.

### **NOTE**

For vehicles equipped with the driver monitoring camera, the DAA setting item is not displayed in Mazda Connect because the Driver Monitoring (DM) operation takes priority.

## Driver Monitoring (DM)\*

DM uses the Driver Monitoring Camera to alert the driver if the driver may be drowsy or inattentive while driving.

Refer to Driver Monitoring Camera on page 5-137.

No personal information is stored related to this feature. The camera used for this feature does not capture photographic images and operates on numeric information only.

For vehicles with DM, the DM is set to "On" to promote safety and security. If you wish to turn it Off.

Set in the "Safety Settings" or consult an Authorized Mazda Dealer.

Please find additional information below about the two detection functions of DM.

### Drowsiness detection function

The drowsiness detection function can help detect the level of driver drowsiness. When the driver drowsiness is detected, the screen display and warning sound encourage the driver to take a rest.

There are 2 levels of screen display and warning sound.

### Warning pattern (caution)

When driver drowsiness is detected, taking a rest is encouraged.

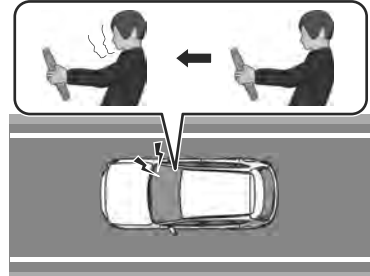

### Warning pattern (warning)

If a higher level of driver drowsiness is detected, taking a rest is encouraged.

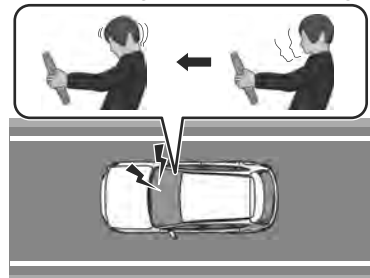

## Driver Monitoring (DM)

---

### Inattentive driving detection function

The inattentive driving detection function can help detect that the driver is not paying attention to the road.

When the system detects that the driver is not paying attention to the road, it alerts the driver with a screen display and a warning sound.

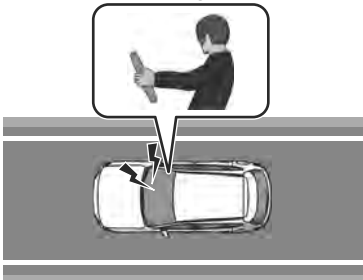

### Warnings and Cautions for Using the Driver Monitoring (DM)

#### **⚠ WARNING**

#### **Do not rely completely on the DM.**

DM is not a substitute for safe and attentive driving.

The DM does not prevent driver drowsiness or inattentive driving and over reliance on the system could lead to an accident. Drive carefully and turn the steering wheel appropriately.

In addition, the system may not be able to correctly detect driver drowsiness or inattentive driving depending on the road and driving conditions. The driver must take sufficient rest in consideration of safe driving.

## How to Use the Driver Monitoring (DM)

### Operating the drowsiness detection function

The drowsiness detection function operates when all of the following conditions are met and the system detects driver drowsiness.

- The vehicle has been driven for about 20 minutes or longer.
- The vehicle speed is about 5 km/h (3 mph) or faster.

When the drowsiness detection function operates, the screen display and warning sound encourage the driver to take a rest.

#### Instrument cluster (Type A)

##### Warning pattern (caution) (white)

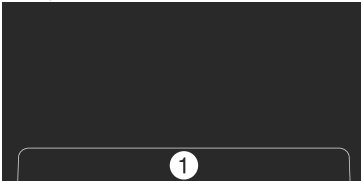

1. "Time for a Break"

##### Warning pattern (warning) (amber)

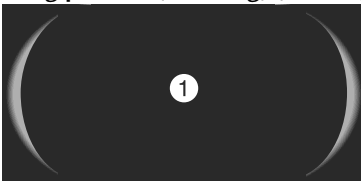

1. "Time for a Break"

#### Instrument cluster (Type B)

##### Warning pattern (caution) (white)

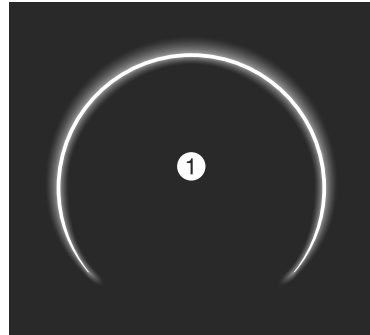

1. "Time for a Break"

##### Warning pattern (warning) (amber)

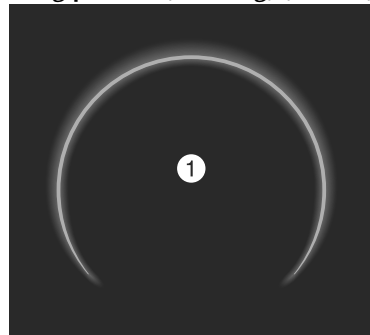

1. "Time for a Break"

#### NOTE

- After the drowsiness detection function has displayed the first message encouraging the driver to take a rest, it does not display it again during the following periods.
- After displaying the warning pattern (caution), the next warning pattern (caution) is not displayed until 45 minutes have passed.

- After displaying the warning pattern (warning), the next warning pattern (warning) is not displayed until 15 minutes have passed.
- After displaying the warning pattern (warning), the next warning pattern (caution) is not displayed until 45 minutes have passed.

However, if a higher level of driver drowsiness is detected, a notification is made to take a rest.

- If the driver monitoring camera does not recognize the driver correctly, the drowsiness detection function may not operate normally. Refer to Driver Monitoring Camera on page 5-137.
- The drowsiness detection function may not operate normally if any of the following conditions is met.
  - You are looking down.
  - You are squinting or closing your eyes.
  - One eye is closed.
  - You are laughing.

## **Operating the inattentive driving detection function**

The inattentive driving detection function operates when the system detects that the driver is not paying attention to the road at a vehicle speed of about 20 km/h (12 mph) or faster.

When the inattentive driving detection function operates, the screen display and warning sound alerts the driver.

### Instrument cluster (Type A)

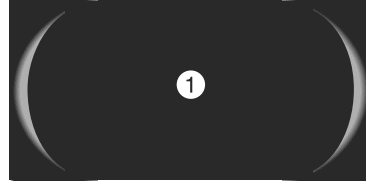

1. "Distracted Driver Detected"

### Instrument cluster (Type B)

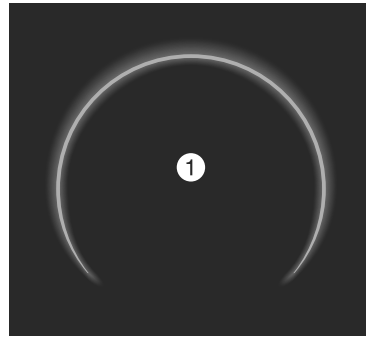

1. "Distracted Driver Detected"

### NOTE

- If the driver monitoring camera does not recognize the driver correctly, the inattentive driving detection function may not operate normally. Refer to Driver Monitoring Camera on page 5-137.
- The inattentive driving detection function requires the driver to maintain a stable line of sight. The function may not operate normally if any of the following conditions is met.
  - There is a large difference between your line of sight and the direction your face is pointed.
  - Your face or your eyes frequently turn in a direction other than straight ahead.

- You are driving the vehicle with your head largely tilted to one side.
- You are moving around extensively.

**Turning off the DM**

The DM can be turned off using the Mazda Connect.

Set in the “Safety Settings” or consult an Authorized Mazda Dealer.



## Front Cross Traffic Alert (FCTA)

---

### Front Cross Traffic Alert (FCTA)\*

The FCTA assists the driver in checking both sides of the vehicle when the vehicle starts to drive at an intersection. When a vehicle approaching from the blind spots on the front left or right side is detected, a screen display and warning sound notify the driver of the danger.

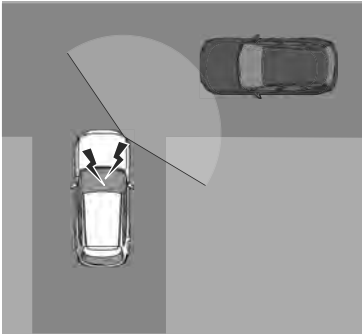

### Warnings and Cautions for Using the Front Cross Traffic Alert (FCTA)

#### **WARNING**

**Always check the surrounding area visually when the vehicle starts to drive at an intersection.**

Due to certain limitations with the operation of the FCTA, the screen display and warning sound might be delayed even though there is a vehicle approaching from a blind spot. Always make it your responsibility as a driver to check the left and right sides.

## How to Use the Front Cross Traffic Alert (FCTA)

### Operating the FCTA

The FCTA operates when all of the following conditions are met.

- The vehicle speed is less than about 10 km/h (6 mph).
- The selector lever is in the D position.
- The system detects a vehicle approaching at a speed of about 5 km/h (3 mph) or faster from the front side of your vehicle.

When the FCTA is operating, the driver is notified of the danger by the screen display and the warning sound according to the situation.

### **When your vehicle is stopped**

The screen display (white)<sup>\*1</sup> notifies you that a vehicle is approaching.

#### **Instrument cluster (Type A)**

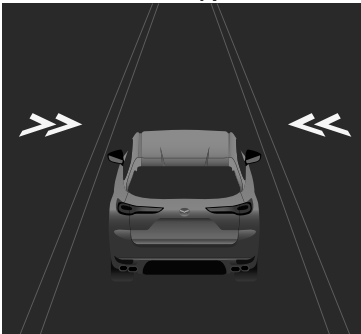

#### **Instrument cluster (Type B)**

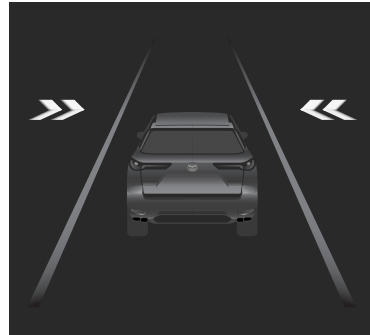

#### **Active driving display**



#### **360° view monitor**



<sup>\*1</sup> The instrument cluster screen display (white) is displayed only when the instrument cluster is set to the i-ACTIVSENSE display.

### **When your vehicle is moving**

The screen display (amber) and warning sound notify the driver of the possibility that a collision may occur with an approaching vehicle.

#### **Instrument cluster (Type A)**

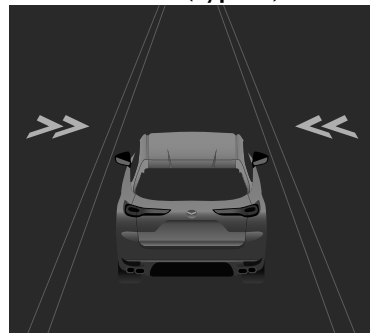

## Front Cross Traffic Alert (FCTA)

---

### Instrument cluster (Type B)

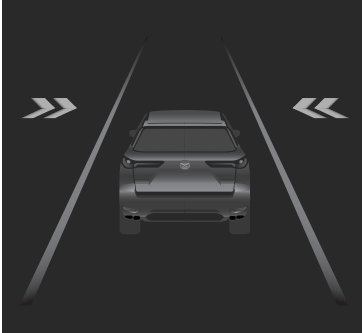

### Active driving display



### 360° view monitor



### NOTE

- The system may operate even if a vehicle is not approaching depending on the conditions around your vehicle.
- The front side radar sensors may not detect objects and the FCTA may not operate normally.  
Refer to Radar Sensors on page 5-129.

### Turning off the warning sound

There are 2 ways to turn off the warning sound while the FCTA is operating.

- Turn off the warning sound using Mazda Connect.  
Refer to the Settings section in the Mazda Connect Owner's Manual.

- Turn off the warning sound using the i-ACTIVSENSE mute switch.  
Refer to How to Use the i-ACTIVSENSE mute switch on page 5-124.

### Turning off the FCTA

The FCTA can be turned off using the Mazda Connect.  
Refer to the Settings section in the Mazda Connect Owner's Manual.

## Rear Cross Traffic Alert (RCTA)

The RCTA assists the driver in checking the area to the rear of the vehicle, such as while reversing out of a parking space. When a vehicle approaching from the rear on the left or right is detected, various screen displays and warning sounds notify the driver of the danger.

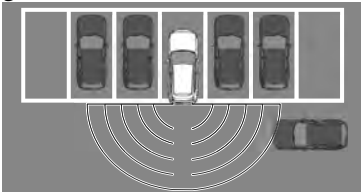

## Warnings and Cautions for Using the Rear Cross Traffic Alert (RCTA)

### **WARNING**

**Do not rely completely on the RCTA.** The RCTA is a system to assist the driver in checking the area to the rear of the vehicle while reversing. Due to certain limitations with the operation of the system, the BSM warning light may not flash or it might be delayed even though a vehicle is at the rear of your vehicle. Always make it your responsibility as a driver to check the rear.

## How to Use the Rear Cross Traffic Alert (RCTA)

### Operating the RCTA

The RCTA operates when all of the following conditions are met.

- The vehicle is about to be driven in reverse.
- The system detects an approaching vehicle.

When the RCTA operates, the driver is notified of the danger by flashing of the BSM warning lights, a warning indication, and a warning sound.

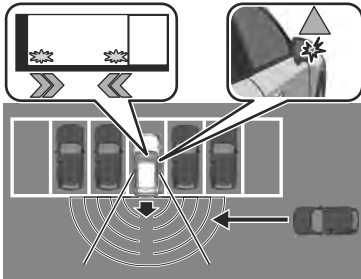

### NOTE

- The system may operate even if a vehicle is not approaching depending on the conditions around your vehicle.
- The RCTA may not operate normally if any of the following conditions is met.
  - The rear side radar sensors cannot detect an object. Refer to Radar Sensors on page 5-129.
  - The vehicle speed when reversing is about 15 km/h (9 mph) or faster.
  - A vehicle is approaching directly from the rear of your vehicle.
  - A vehicle is approaching at an angle from the rear of your vehicle.

- If a Mazda genuine trailer hitch is used, the RCTA is automatically turned off when the trailer's electrical connector is connected.
- When pulling a trailer other than with a Mazda genuine trailer hitch, or while an accessory such as a bicycle carrier is installed to the rear of the vehicle, turn off the RCTA. Otherwise, the radar's radio waves will be blocked causing the RCTA to not operate normally.
- The brightness of the BSM warning lights is linked to the panel light control. Refer to Dashboard Illumination on page 5-30.

### Turning off the warning sound

There are 2 ways to turn off the warning sound while the RCTA is operating.

- Turn off the warning sound using Mazda Connect. Refer to the Settings section in the Mazda Connect Owner's Manual.
- Turn off the warning sound using the i-ACTIVSENSE mute switch. Refer to How to Use the i-ACTIVSENSE mute switch on page 5-124.

### Turning off the RCTA

The RCTA can be turned off using the Mazda Connect.

Refer to the Settings section in the Mazda Connect Owner's Manual.

## Mazda Radar Cruise Control (MRCC)

MRCC is a system that reduces load on the driver through constant speed and headway control. The function performs headway control to maintain the distance with a vehicle ahead at a constant preset speed without you having to depress the accelerator or brake pedal.

## Warnings and Cautions for Using the Mazda Radar Cruise Control (MRCC)

### WARNING

**Do not rely completely on the MRCC.** The MRCC may not be able to detect a vehicle ahead depending on the type of vehicle ahead and its conditions, the weather conditions, and the road conditions. Additionally, the system might be unable to decelerate sufficiently if the vehicle ahead applies the brakes suddenly or another vehicle cuts into your lane, which could result in an accident.

Always check the surrounding conditions and depress the brake pedal or accelerator pedal while keeping a safe distance from a vehicle ahead or a vehicle following behind you.

**Do not use the MRCC under the following conditions. Otherwise, it may result in an accident.**

- The vehicle is driven on roads other than highways.
- The vehicle is driven on roads with sharp curves or with heavy traffic where sufficient distances between vehicles cannot be kept.
- The vehicle is driven on roads where acceleration and deceleration are frequently repeated.
- The vehicle is exiting the main lane on an expressway to enter an interchange, a rest area, or a parking area.

## Mazda Radar Cruise Control (MRCC)

---

- The vehicle is driven on slippery roads such as icy roads, snow-covered roads, and unpaved roads.
- The vehicle is driven on a long downslope.
- The vehicle is driven on a steep slope.
- A two-wheeled vehicle such as a motorcycle or bicycle is traveling ahead.

### **Switch the MRCC off when it is not being used.**

Leaving the MRCC on when it is not in use is dangerous as it could operate unexpectedly, resulting in an accident.

### **Do not leave the vehicle while the vehicle is stopped by the MRCC control.**

Getting out of the vehicle while the stop hold control is operating is dangerous as the vehicle may move unexpectedly and result in an accident. Before leaving the vehicle, switch the MRCC off, shift the selector lever to the P position, and apply the parking brake.



- If the vehicle is towed or you are towing something, switch the MRCC off.
- Turn off the MRCC when the vehicle is running on a chassis roller.

## How to Use the Mazda Radar Cruise Control (MRCC)

### MRCC operation conditions

The MRCC can be set when all of the following conditions are met.

- The brake pedal is not depressed.
- The vehicle speed is about 0 km/h (0 mph) to 145 km/h (90 mph).
- The Hill Descent Control is not operating.

### Setting the MRCC



1. Press the MRCC switch to turn the system on.



When the system is on, the MRCC standby indication (white)  is displayed on the screen.

2. Accelerate to the desired speed.
3. Set the vehicle speed by pressing the RES switch up (SET+) or down (SET-).



Constant speed driving starts when the vehicle speed is set. In addition, the set speed is displayed on the screen, and the MRCC standby indication (white)  changes to the MRCC set indication (green) .

If a vehicle ahead is detected while traveling at a constant speed, the system switches to headway control. The vehicle ahead indication is displayed on the screen while in headway control.



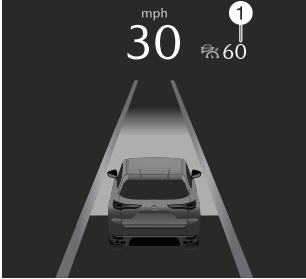
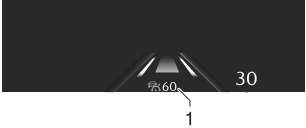
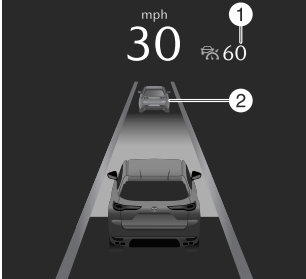
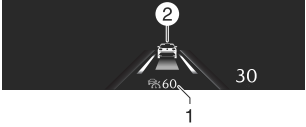

Driving  
**Mazda Radar Cruise Control (MRCC)**

**Instrument cluster (Type A)**

Driving condition	Instrument cluster display	Active driving display indication
During travel at constant speed		
During travel under headway control		

1. Set speed
2. Vehicle ahead indication

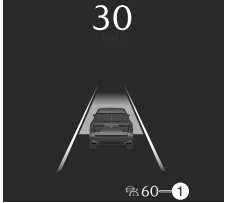
**Instrument cluster (Type B)**

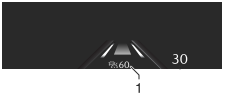
Driving condition	Instrument cluster display		Active driving display indication
	i-ACTIVSENSE display	Other than i-ACTIVSENSE display	
During travel at constant speed			

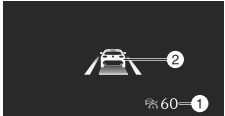
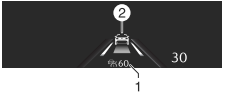
Driving condition	Instrument cluster display		Active driving display indication
	i-ACTIVSENSE display	Other than i-ACTIVSENSE display	
During travel under headway control			

1. Set speed
2. Vehicle ahead indication

## NOTE

- If there is a structure on the road or an obstruction at a low height off the ground in front of the vehicle, the system may recognize it as a vehicle ahead.
- Acceleration and deceleration by accelerator pedal operation takes priority while traveling at a constant speed or in headway control. When the accelerator pedal is released, the vehicle returns to driving at a constant speed or headway control at the set speed.
- If a vehicle ahead is traveling at an extremely low speed, the system may not detect it correctly.
- While driving using the MRCC, intended engine braking is not applied even if the selector lever is operated.
- The brake lights turn on while the brakes are operating by the MRCC control.
- The MRCC is also turned off automatically when the vehicle power is switched OFF.
- If the distance between vehicles control is disabled using Mazda Connect, the system switches to the cruise control. At this time, the MRCC switch functions as the cruise control switch.  
Refer to the Settings section in the Mazda Connect Owner's Manual.
- If the vehicle power is switched OFF while the distance between vehicles control is disabled, the distance between vehicles control is enabled automatically the next time the vehicle power is switched ON.

If the vehicle ahead stops during headway control, your vehicle in headway control also stops. When the vehicle is stopped, the MRCC indicator light **HOLD** in the instrument cluster turns on.

When the vehicle ahead accelerates from a stop and one of the following operations is performed, your vehicle starts driving.

- Press the RES switch.
- Depress the accelerator pedal.

## Mazda Radar Cruise Control (MRCC)

---

If you do not start driving the vehicle after the vehicle ahead has resumed driving, the system urges the driver to resume driving.

### NOTE

- If the vehicle ahead resumes driving within 3 seconds after the vehicle was stopped by the system, your vehicle also resumes driving automatically.
- If the vehicle is stopped by the system continuously for 10 minutes or longer, the parking brake is applied automatically. At this time, the MRCC is canceled.
- Even if the MRCC is canceled while the vehicle is stopped, the vehicle is held in its stopped position.  
Refer to AUTOHOLD on page 5-71.
- If the MRCC is canceled while the vehicle is stopped and there is no vehicle ahead, you cannot resume driving the vehicle using the RES switch. Depress the accelerator pedal and start driving the vehicle.
- If the i-stop operation conditions are met while the vehicle is stopped, the i-stop function operates without depressing the brake pedal. The engine restarts automatically when you start driving the vehicle.  
Refer to i-stop on page 5-21.

### Changing the set vehicle speed

#### Changing the set vehicle speed using the RES switch

Press the RES switch up (SET+) or down (SET-) to the desired speed.

- Press and release immediately: 1 km/h (1 mph)
- Press and hold: 10 km/h (5 mph)

#### Changing the set vehicle speed using the accelerator pedal

Depress the accelerator pedal until the vehicle speed reaches the desired speed, then press the RES switch up (SET+) or down (SET-).

#### Reading the set vehicle speed from the speed limit sign using the RES switch (Speed Limit Assist only)

Press the RES switch when the speed limit sign set indication **RES** turns on.



- The function which recognizes speed limit signs has limitations. Always check the set vehicle speed that was read.
- Set the speedometer display unit to the same unit as the speed limit sign. Differing units will capture speeds not intended by the driver.

### NOTE

- The Speed Limit Assist operates only when the navigation system's SD card is inserted.
- The Speed Limit Assist uses the Traffic Sign Recognition system (TSR).

- Refer to Traffic Sign Recognition System (TSR) on page 5-151.
- The Speed Limit Assist cannot read speeds of less than 30 km/h (19 mph).
- Set vehicle speeds read from speed limit signs can be adjusted.
- Refer to the Settings section in the Mazda Connect Owner's Manual.
- The Speed Limit Assist can be turned off.
- Refer to the Settings section in the Mazda Connect Owner's Manual.



### Setting the distance-between-vehicles during headway control

1. Press the CANCEL switch up (longer distance) or down (shorter distance).





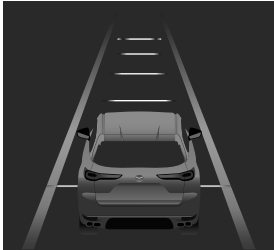



### MRCC is not operating (white)

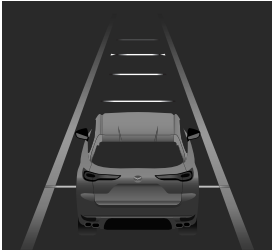

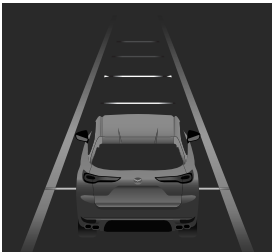



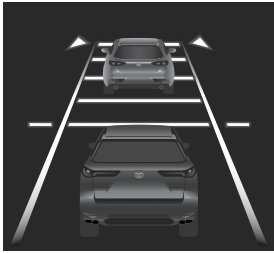

#### Instrument cluster (Type A)

Distance-between-vehicles guide-line (at 80 km/h (50 mph) vehicle speed)	Instrument cluster display	Active driving display indication
Long (about 50 m (164 ft))		

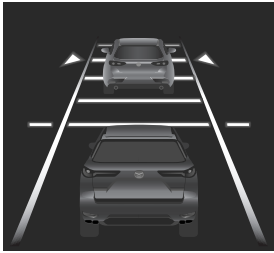
# Mazda Radar Cruise Control (MRCC)

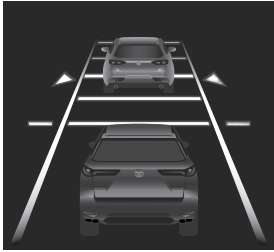
Distance-between-vehicles guideline (at 80 km/h (50 mph) vehicle speed)	Instrument cluster display	Active driving display indication
Medium (about 40 m (131 ft))		
Short (about 30 m (98 ft))		
Extremely short (about 25 m (82 ft))		

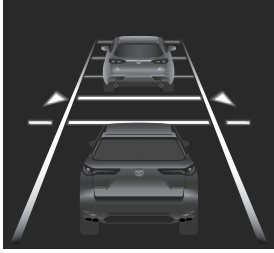





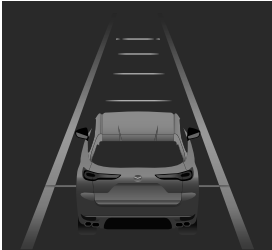

**Instrument cluster (Type B)**

Distance-between-vehicles guide-line (at 80 km/h (50 mph) vehicle speed)	Instrument cluster display	Active driving display indication
Long (about 50 m (164 ft))		
Medium (about 40 m (131 ft))		
Short (about 30 m (98 ft))		
Extremely short (about 25 m (82 ft))		

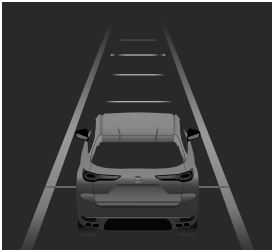

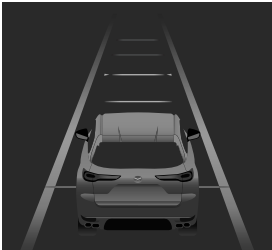

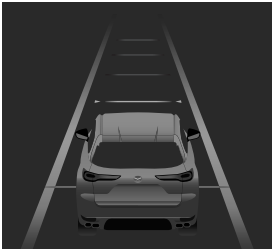

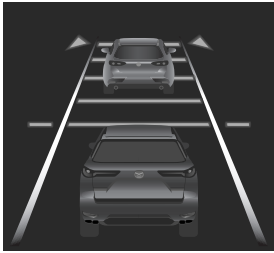

Driving  
**Mazda Radar Cruise Control (MRCC)**

---

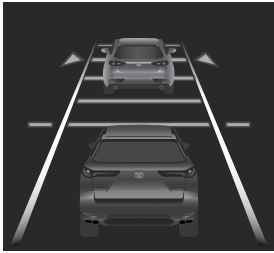
**MRCC is operating (green)**  
**Instrument cluster (Type A)**

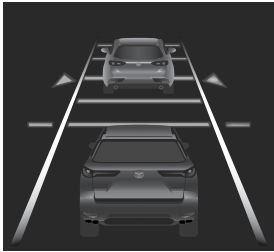
Distance-between-vehicles guide-line (at 80 km/h (50 mph) vehicle speed)	Instrument cluster display	Active driving display indication
Long (about 50 m (164 ft))		
Medium (about 40 m (131 ft))		
Short (about 30 m (98 ft))		
Extremely short (about 25 m (82 ft))		

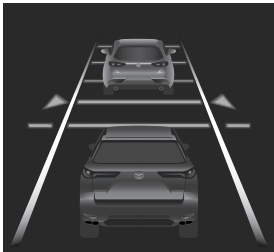
**Instrument cluster (Type B)**

Distance-between-vehicles guideline (at 80 km/h (50 mph) vehicle speed)	Instrument cluster display	Active driving display indication
Long (about 50 m (164 ft))		
Medium (about 40 m (131 ft))		
Short (about 30 m (98 ft))		
Extremely short (about 25 m (82 ft))		



## NOTE

- The distance-between-vehicles can be set to 4 levels: Long, medium, short, and extremely short distance.
- The distance-between-vehicles differs depending on the vehicle speed, and the slower the vehicle speed, the shorter the distance.

### Close proximity warning

If your vehicle approaches a vehicle ahead while in headway control, a warning sound and a display cautions you.

#### **Instrument cluster (Type A)**



1. "Depress Brake Pedal"

#### **Instrument cluster (Type B)**

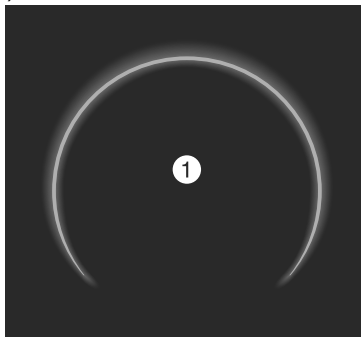

1. "Depress Brake Pedal"

## NOTE

The close proximity warning may not be activated in the following cases.

- The vehicle is driven at the same speed as the vehicle ahead.
- Directly after the MRCC is set.
- Immediately after the accelerator pedal is released.
- Another vehicle cuts into the driving lane.
- Do not use the MRCC under conditions in which the close proximity warnings are frequently activated.

### The MRCC is canceled temporarily

If any of the following conditions is met, the MRCC is canceled temporarily.

- The brake pedal is depressed.
- The CANCEL switch is pressed one time.
- The DSC has operated.
- The Smart Brake Support (SBS) has operated.
- The front radar sensors cannot detect target objects.
- The parking brake is applied.
- Any door is opened.
- The driver's seat belt is unfastened.
- The frequency of the braking operation by the MRCC is high.

If the MRCC is temporarily canceled, it will resume operation at the previously set speed by pressing the RES switch.

### **Turning off the MRCC**

Press the MRCC switch.

The MRCC set indication (green)  /MRCC standby indication (white)  turns off, and the MRCC turns off.

## Cruising & Traffic Support (CTS)\*

The CTS is a system that reduces the load on the driver while the vehicle is driven on expressways or highways. The CTS has the following 3 functions.

### Constant speed/Headway control function

The function performs headway control to maintain the distance with a vehicle ahead at a constant preset speed without you having to depress the accelerator or brake pedal.

### Steering wheel assist function

When vehicle lane lines are detected, the function assists your steering wheel operation to follow the vehicle lane lines.

When vehicle lane lines are not detected, the function assists your steering wheel operation to follow the trajectory of the vehicle ahead.

### Risk mitigation function

The risk mitigation function is a function that decelerates the vehicle if the driver is not driving the vehicle under the appropriate conditions. If the driver is not driving the vehicle under the appropriate conditions, a screen display and a warning sound urge the driver to drive appropriately. Furthermore, if this situation continues for a certain period of time, the vehicle is decelerated.

## Warnings and Cautions for Using Cruising & Traffic Support (CTS)

### WARNING

**Do not rely completely on the CTS.**

- The CTS is not an automated driving system. Therefore, the function has limitations. Do not rely completely on the system and always stay on course using the steering wheel.
- Set a vehicle speed within the speed limit according to the road conditions and the weather conditions.
- The CTS may not be able to detect a vehicle ahead depending on the type of vehicle ahead and its conditions, the weather conditions, and the road conditions. Additionally, the system might be unable to decelerate sufficiently if the vehicle ahead applies the brakes suddenly or another vehicle cuts into your lane, which could result in an accident.
- The risk mitigation function is designed to avoid accidents or reduce damage by decelerating quickly in the event of an accident. The function has limitations and its effectiveness changes depending on the various conditions.

**Do not intentionally activate the risk mitigation function.**

Otherwise, it could lead to an accident.

**Do not use the CTS under the following conditions. Otherwise, it may result in an accident.**

- The vehicle is driven on roads other than expressways and highways.
- The vehicle is driven on roads with sharp curves or with heavy traffic where sufficient distances between vehicles cannot be kept.
- The vehicle is driven on roads where acceleration and deceleration are frequently repeated.
- The vehicle is exiting the main lane on an expressway to enter an interchange, a rest area, or a parking area.
- The vehicle is driven on slippery roads such as icy roads, snow-covered roads, and unpaved roads.
- The vehicle is driven on a long downslope.
- The vehicle is driven on a steep slope.
- A two-wheeled vehicle such as a motorcycle or bicycle is traveling ahead.
- The vehicle is being towed or towing another vehicle.
- Proximity warnings activate frequently.
- Under bad weather conditions (rain, fog, and snow).
- Tires other than the specified size are used, such as when tire chains or temporary spare tires are used.
- The tire pressures are not adjusted to the appropriate pressure.
- Tires with insufficient tread are used.

**Switch the CTS off when it is not being used.**

Leaving the CTS on when it is not in use is dangerous as it could operate unexpectedly, resulting in an accident.

**Do not leave the vehicle while the vehicle is stopped by the CTS control.**

Getting out of the vehicle while the stop hold control is operating is dangerous as the vehicle may move unexpectedly and result in an accident. Before leaving the vehicle, switch the CTS off, shift the selector lever to the P position, and apply the parking brake.

**After the risk mitigation function operates, take measures to prevent secondary damage.**

If the driver is able to return to driving, move to a safe place or take other measures to prevent secondary damage.



- Heed the following cautions so that the CTS can operate normally.
  - Do not modify the suspensions.
  - Always use wheels of the specified size for the front and rear wheels. Consult an Authorized Mazda Dealer for tire replacement.
- Turn off the CTS when the vehicle is running on a chassis roller.

## How to Use the Cruising & Traffic Support (CTS)

### CTS operation conditions

The CTS speed can be set when all of the following conditions are met.

- The brake pedal is not depressed.
- The vehicle speed is about 0 km/h (0 mph) to 145 km/h (90 mph).
- The Hill Descent Control is not operating.
- The Mazda Radar Cruise Control is available.
- The Smart Brake Support (SBS) is on.

### Setting the CTS



1. Press the CTS switch to turn the system on.



When the system is on, the CTS standby indication (white)  is displayed on the screen.

2. Accelerate to the desired speed.
3. Set the vehicle speed by pressing the RES switch up (SET+) or down (SET-).



Constant speed driving starts when the vehicle speed is set. In addition, the set speed is displayed on the screen, and the CTS standby indication (white)  changes to the CTS set indication (green) .

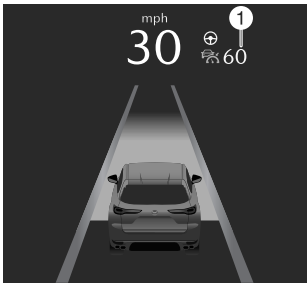
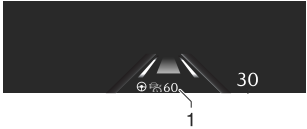
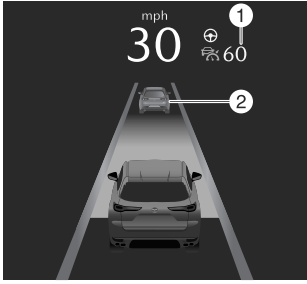
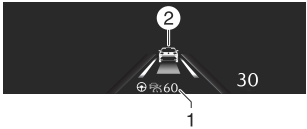

If a vehicle ahead is detected while traveling at a constant speed, the system switches to headway control. The vehicle ahead indication is displayed on the screen while in headway control.

**Instrument cluster (Type A)**



Driving condition	Instrument cluster display	Active driving display indication
During travel at constant speed		
During travel under headway control		

1. Set speed
2. Vehicle ahead indication

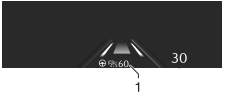
**Instrument cluster (Type B)**

Driving condition	Instrument cluster display		Active driving display indication
	i-ACTIVSENSE display	Other than i-ACTIVSENSE display	
During travel at constant speed			

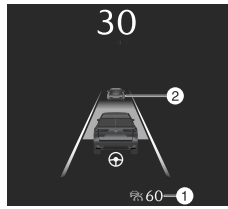
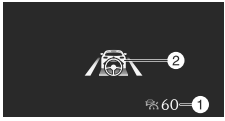
Driving  
**Cruising & Traffic Support (CTS)**

Driving condition	Instrument cluster display		Active driving display indication
	i-ACTIVSENSE display	Other than i-ACTIVSENSE display	
During travel under headway control			

1. Set speed
2. Vehicle ahead indication

**NOTE**





- If there is a structure on the road or an obstruction at a low height off the ground in front of the vehicle, the system may recognize it as a vehicle ahead.
- Acceleration and deceleration by accelerator pedal operation takes priority while traveling at a constant speed or in headway control. When the accelerator pedal is released, the vehicle returns to driving at a constant speed or headway control at the set speed.
- The Forward Sensing Camera (FSC) may not be able to detect target objects correctly, and the CTS may not operate normally.  
Refer to Forward Sensing Camera (FSC) on page 5-125.
- If a vehicle ahead is traveling at an extremely low speed, the system may not detect it correctly.
- While driving using the CTS, intended engine braking is not applied even if the selector lever is operated.
- The brake lights turn on while the brakes are operating by the CTS control.
- Smart Brake Support (SBS) cannot be turned off while the CTS is operating.
- When the driver monitoring is turned on while the CTS is operating, the driver monitoring camera monitors the driver's status.  
Refer to Driver Monitoring Camera on page 5-137.

The steering assist function operates if all of the following conditions are met while traveling at a constant speed or in headway control.

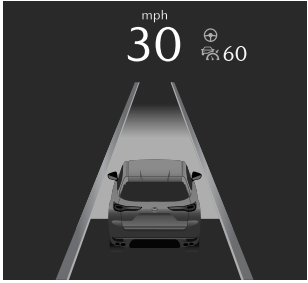

- When driving near the center of the lane and the white (yellow) lane lines on both sides are detected clearly, or a vehicle ahead is detected clearly in front of your vehicle and at less than about 56 km/h (35 mph).
- The steering wheel is not turned sharply.
- The turn signal lever is not operated.

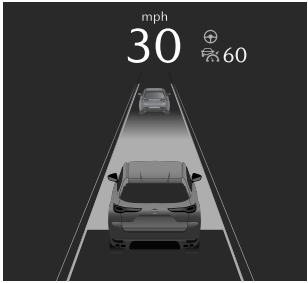
When the steering assist function operates, the steering assist operation display changes from white to green.

**Instrument cluster (Type A)**



Driving condition	Instrument cluster display	Active driving display indication
Steering assist within vehicle lane lines		
Steering assist along the trajectory of the vehicle ahead		

**Instrument cluster (Type B)**

Driving condition	Instrument cluster display		Active driving display indication
	i-ACTIVSENSE display	Except i-ACTIVSENSE display	
Steering assist within vehicle lane lines			

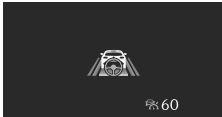

Driving  
**Cruising & Traffic Support (CTS)**

Driving condition	Instrument cluster display		Active driving display indication
	i-ACTIVSENSE display	Except i-ACTIVSENSE display	
Steering assist along the trajectory of the vehicle ahead			

**NOTE**

- The steering assist function assists the steering wheel operation so that the vehicle remains near the center of the driving lane, however, the function might not be able to keep the vehicle near the center of the driving lane when any of the following conditions is met.
  - The vehicle speed is high.
  - The vehicle is making a sharp turn.
  - The vehicle is driven on a road with steep or up and down (wavy) slopes.
  - The vehicle is driven on a road with a large lateral gradient.

If the vehicle ahead stops during headway control, your vehicle in headway control also stops. While the vehicle is stopped, the CTS indicator light **HOLD** in the Instrument cluster turns on.

When the vehicle ahead accelerates from a stop and one of the following operations is performed, your vehicle starts driving.

- Press the RES switch.
- Depress the accelerator pedal.

If you do not start driving the vehicle after the vehicle ahead has resumed driving, the system urges the driver to resume driving.

**NOTE**

- If the vehicle ahead resumes driving within 3 seconds after the vehicle was stopped by the system, your vehicle also resumes driving automatically.
- If the vehicle is stopped by the system continuously for 10 minutes or longer, the parking brake is applied automatically. At this time, the CTS is canceled.
- Even if the CTS is canceled while the vehicle is stopped, the vehicle is held in its stopped position.  
 Refer to AUTOHOLD on page 5-71.
- If the CTS is canceled while the vehicle is stopped and there is no vehicle ahead, you cannot resume driving the vehicle using the RES switch. Depress the accelerator pedal and start driving the vehicle.

- If the i-stop operation conditions are met while the vehicle is stopped, the i-stop function operates without depressing the brake pedal. The engine restarts automatically when you start driving the vehicle.  
Refer to i-stop on page 5-21.

### **Changing the set vehicle speed**

#### **Changing the set vehicle speed using the RES switch**

Press the RES switch up (SET+) or down (SET-) to the desired speed.

- Press and release immediately: 1 km/h (1 mph)
- Press and hold: 10 km/h (5 mph)

#### **Changing the set vehicle speed using the accelerator pedal**

Depress the accelerator pedal until the vehicle speed reaches the desired speed, then press the RES switch up (SET+) or down (SET-).

#### **Reading the set vehicle speed from the speed limit sign using the RES switch (Speed Limit Assist only)**

Press the RES switch when the speed limit sign set indication  turns on.



- The function which recognizes speed limit signs has limitations. Always check the set vehicle speed that was read.
- Set the speedometer display unit to the same unit as the speed limit sign. Differing units will capture speeds not intended by the driver.

### **NOTE**

- The Speed Limit Assist operates only when the navigation system's SD card is inserted.
- The Speed Limit Assist uses the Traffic Sign Recognition system (TSR).  
Refer to Traffic Sign Recognition System (TSR) on page 5-151.
- The Speed Limit Assist cannot read speeds of less than 30 km/h (19 mph).
- Set vehicle speeds read from speed limit signs can be adjusted.  
Set in the Mazda Connect "Settings" or consult an Authorized Mazda Dealer.
- The Speed Limit Assist can be turned off.  
Set in the Mazda Connect "Settings" or consult an Authorized Mazda Dealer.

Driving  
**Cruising & Traffic Support (CTS)**

---





**Setting the distance-between-vehicles during headway control**



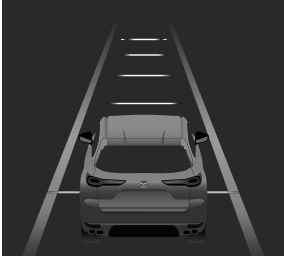

1. Press the CANCEL switch up (longer distance) or down (shorter distance).

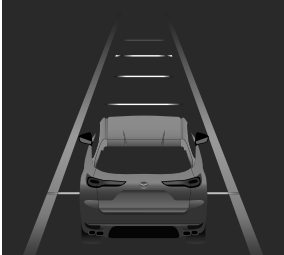

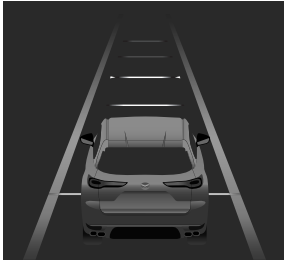

**CTS is not operating (white)**

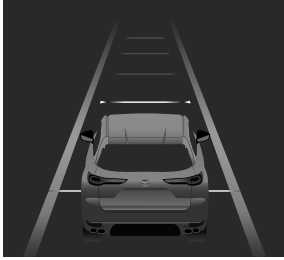
**Instrument cluster (Type A)**





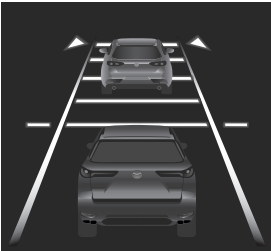

Distance-between-vehicles guideline (at 80 km/h (50 mph) vehicle speed)	Instrument cluster display	Active driving display indication
Long (about 50 m (164 ft))		
Medium (about 40 m (131 ft))		

Distance-between-vehicles guideline (at 80 km/h (50 mph) vehicle speed)	Instrument cluster display	Active driving display indication
Short (about 30 m (98 ft))		
Extremely short (about 25 m (82 ft))		

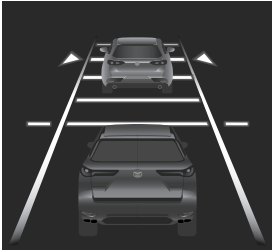
**Instrument cluster (Type B)**

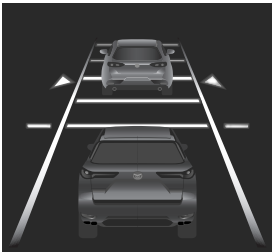

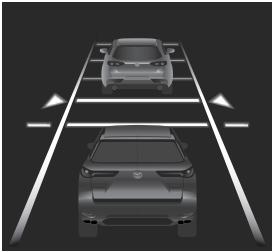



Distance-between-vehicles guideline (at 80 km/h (50 mph) vehicle speed)	Instrument cluster display	Active driving display indication
Long (about 50 m (164 ft))		

Driving  
**Cruising & Traffic Support (CTS)**

Distance-between-vehicles guideline (at 80 km/h (50 mph) vehicle speed)	Instrument cluster display	Active driving display indication
Medium (about 40 m (131 ft))		
Short (about 30 m (98 ft))		
Extremely short (about 25 m (82 ft))		

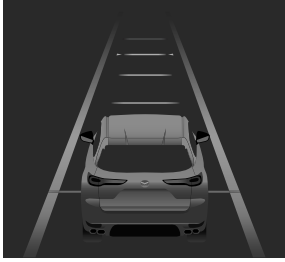

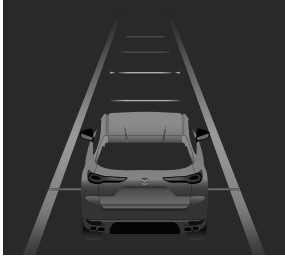
CTS is operating (green)

Instrument cluster (Type A)



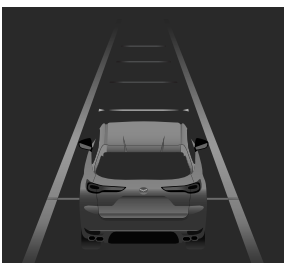

Distance-between-vehicles guideline (at 80 km/h (50 mph) vehicle speed)	Instrument cluster display	Active driving display indication
Long (about 50 m (164 ft))		
Medium (about 40 m (131 ft))		
Short (about 30 m (98 ft))		



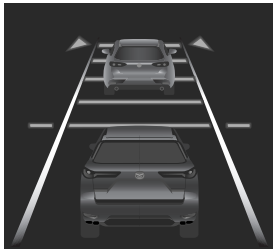

Driving  
**Cruising & Traffic Support (CTS)**

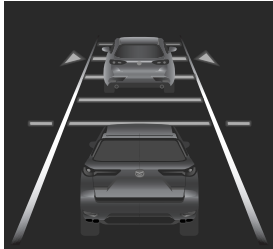
---

Distance-between-vehicles guideline (at 80 km/h (50 mph) vehicle speed)	Instrument cluster display	Active driving display indication
Extremely short (about 25 m (82 ft))		

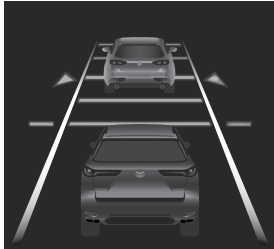
**Instrument cluster (Type B)**

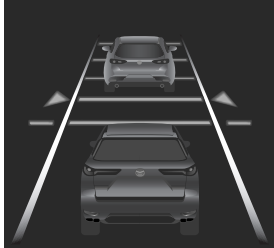
Distance-between-vehicles guideline (at 80 km/h (50 mph) vehicle speed)	Instrument cluster display	Active driving display indication
Long (about 50 m (164 ft))		
Medium (about 40 m (131 ft))		

Distance-between-vehicles guideline (at 80 km/h (50 mph) vehicle speed)	Instrument cluster display	Active driving display indication
Short (about 30 m (98 ft))		
Extremely short (about 25 m (82 ft))		

**NOTE**

- The distance-between-vehicles can be set to 4 levels: Long, medium, short, and extremely short distance.
- The distance-between-vehicles differs depending on the vehicle speed, and the slower the vehicle speed, the shorter the distance.

**Warnings by CTS**

**Close proximity warning**

If your vehicle approaches a vehicle ahead while in headway control, a warning sound and a display cautions you.

**Instrument cluster (Type A)**

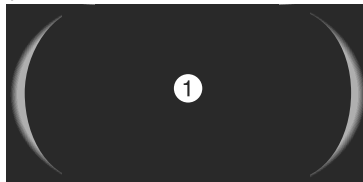

1. "Depress Brake Pedal"



## Instrument cluster (Type B)



1. "Depress Brake Pedal"

### NOTE

- The close proximity warning may not be activated in the following cases.
  - The vehicle is driven at the same speed as the vehicle ahead.
  - Directly after the CTS is set.
  - Immediately after the accelerator pedal is released.
  - Another vehicle cuts into the driving lane.
- Do not use the CTS system under conditions in which the close proximity warnings are frequently activated.

### Steering assist limit warning

If the steering assist function cannot keep the vehicle within the lane lines, a screen display and a warning sound urge you to operate the steering wheel.

### Instrument cluster (Type A)

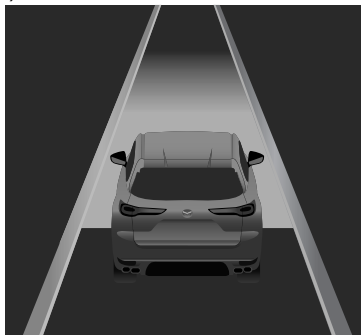

**Instrument cluster (Type B)**



**Active driving display**



**Warning for driving with hands off the steering wheel**

If you take your hands off the steering wheel, a warning (amber) is indicated on the instrument cluster and the active driving display. Then, if you continue to leave your hands off the steering wheel, a warning (red) is indicated on the instrument cluster and the active driving display and a warning sound is activated. This warning is canceled by lightly operating the steering wheel to the left or right.

**Instrument cluster (Type A)**

**Warning (amber)**

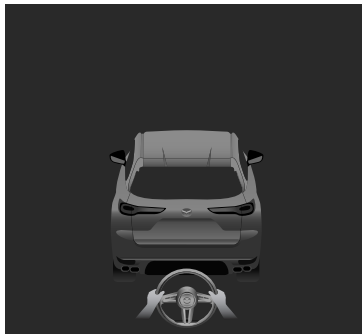

Driving  
**Cruising & Traffic Support (CTS)**

---

**Warning (red)**

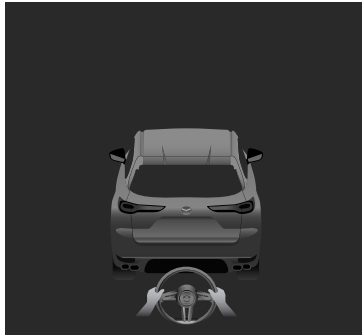

**Instrument cluster (Type B)  
Warning (amber)**

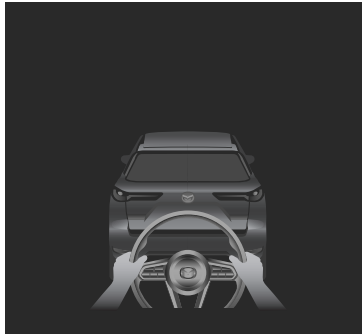

**Warning (red)**

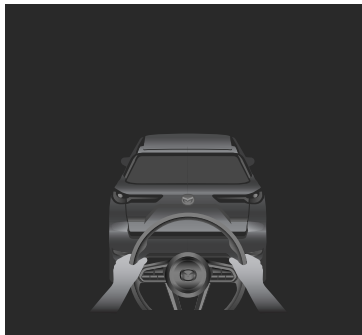

**Active driving display  
Warning (amber)**

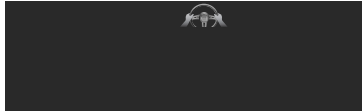

**Warning (red)**

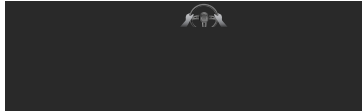

**Warning for lack of attention in the forward direction**

If the driver does not pay attention to the road ahead, a warning (amber) is displayed in the instrument cluster.

This warning is canceled when the driver looks ahead or lightly operates the steering wheel to the left or right.

**Instrument cluster (Type A)**

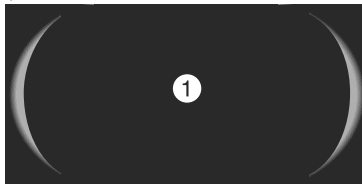

1. "Roadway Inattention Detected"

**Instrument cluster (Type B)**

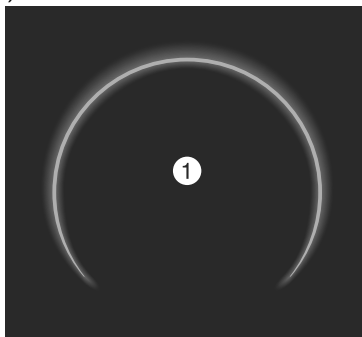

1. "Roadway Inattention Detected"

**NOTE**

If the driver monitoring is turned off, there is no warning for lack of attention in the forward direction.

# Cruising & Traffic Support (CTS)

---

## Warning to encourage appropriate driving

If one of the following warnings continues for a certain period of time, a warning (red) is displayed in the instrument cluster and the active driving display, and a warning sound is activated. In addition, light braking is performed at the same time.

- Warning for driving with hands off the steering wheel
- Warning for lack of attention in the forward direction

This warning is canceled when the steering wheel is lightly operated to the left or right.

### Instrument cluster (Type A)

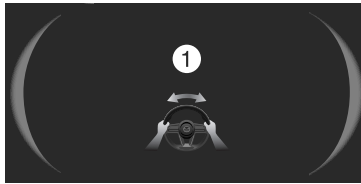

1. "Gently Apply Steering Input"

### Instrument cluster (Type B)

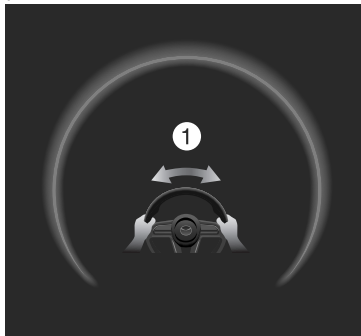

1. "Gently Apply Steering Input"

### Active driving display



### NOTE

If the warning encouraging appropriate driving continues for a certain period of time, the risk mitigation function operates.

**When the risk mitigation function operates**

When all of the following conditions are met, the risk mitigation function operates. When the risk mitigation function operates, CTS and MRCC can no longer be used until the vehicle power is switched OFF.

- The CTS steering assist function is operating.
- The warning encouraging appropriate driving continues for a certain period of time.

When the risk mitigation function operates, the driver is notified that the function has started operating using a screen display, warning sound, and voice guidance. In addition, deceleration is performed at the same time.

While the risk mitigation function is operating, acceleration is not possible even if the accelerator pedal is depressed.

**Instrument cluster (Type A)**

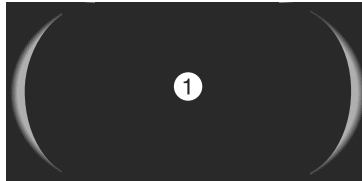

1. "Decelerating. Gently Apply Steering Input to Cancel"

**Instrument cluster (Type B)**

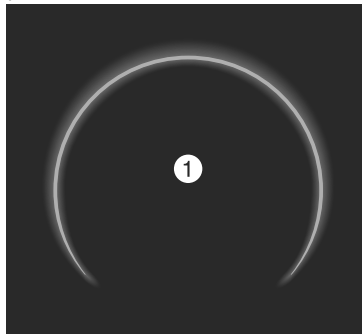

1. "Decelerating. Gently Apply Steering Input to Cancel"

**Vehicle is stopped by the risk mitigation function**

After the vehicle is stopped by the risk mitigation function, the following is performed automatically.

- The parking brake is applied.
- All the doors are unlocked.
- The hazard warning lights turn on.
- A Private eCall is placed.

Refer to Private eCall on page 7-25.

## **NOTE**

- The details on vehicle controls by the risk mitigation function are displayed in the instrument cluster.
- Flashing of the hazard warning lights stops when the hazard warning light switch is pressed.

## **Canceling the risk mitigation function during operation**

If any of the following conditions is met, the risk mitigation function during operation can be canceled.

- The CTS switch or the CANCEL switch is pressed one time.
- The steering wheel is lightly operated to the left or right.
- The vehicle is driven intentionally, such as by operating a pedal to accelerate/ decelerate with the steering wheel gripped.
- The accelerator pedal is depressed 3 times.
- The vehicle power is switched off.
- The parking brake is released.

## **The CTS is temporarily canceled**

### **Constant speed/Headway control function**

If any of the following conditions is met, the constant speed/headway control function is temporarily canceled.

- The brake pedal is depressed.
- The CANCEL switch is pressed one time.
- The DSC has operated.
- The Smart Brake Support (SBS) has operated.
- The front radar sensors cannot detect target objects.
- The parking brake is applied.
- Any door is opened.
- The driver's seat belt is unfastened.
- The frequency of the braking operation by the CTS is high.

If the constant speed/headway control function is temporarily canceled, it will resume operation at the previously set speed by pressing the RES switch.

### **Steering assist function**

If any of the following conditions is met, the steering assist function is temporarily canceled. The steering assist function is automatically restored when its operation conditions are met.

- The constant speed/headway control function is canceled.
- White (yellow) lane lines cannot be detected or a vehicle ahead cannot be recognized.
- The turn signal lever is operated.

- The steering wheel is operated abruptly.
- Hands are off the steering wheel.
- The vehicle is making a sharp curve.
- The vehicle crosses a lane line.
- The width of the vehicle lane is narrow or wide.



### **NOTE**

The notification method when the steering assist function is canceled can be changed.

Set in the Mazda Connect "Settings" or consult an Authorized Mazda Dealer.

### **Turning off the CTS**

Press the CTS switch.

The CTS set indication (green)  /CTS standby indication (white)  turns off, and the CTS turns off.



## Lane-keep Assist System (LAS)

### Lane-keep Assist System (LAS)

The LAS is a system to help the driver stay within the vehicle lane if the vehicle might be deviating. If your vehicle may be deviating from the vehicle lane, the LAS provides steering assistance to avoid departure from the lane.

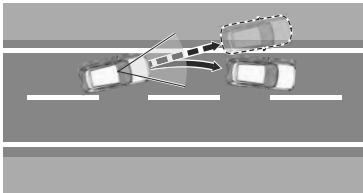

### Warnings and Cautions for Using the Lane-keep Assist System (LAS)

#### **! WARNING**

#### **Do not rely completely on the LAS.**

- The LAS is not an automated driving system. Over reliance on the system could lead to an accident.
- The functions of the LAS have limitations. Do not rely completely on the system and always stay on course using the steering wheel.

#### **Do not use the LAS under the following conditions. Otherwise, it may result in an accident.**

- The vehicle is driven on slippery roads such as icy roads, snow-covered roads, and unpaved roads.
- Tires other than the specified size are used, such as when tire chains or temporary spare tires are used.
- Tires with insufficient tread are used.
- The tire pressures are not adjusted to the specified pressure.
- The vehicle is towing a camping trailer or boat trailer.
- The vehicle is driven on roads other than expressways or highways with white (yellow) lines.

#### **! CAUTION**

- Heed the following cautions so that the LAS can operate normally.
  - Do not modify the vehicle's suspensions.

- Always use wheels of the specified size for the front and rear wheels. Consult an Authorized Mazda Dealer for tire replacement.

## How to Use the Lane-keep Assist System (LAS)

### When the LAS operates

When all the following conditions are met, the LAS operates to assist the steering wheel operation.

- The vehicle speed is about 64 km/h (40 mph) or faster.
- The system detects white (yellow) lane lines.
- The CTS steering assist function is not operating.
- The system determines that the vehicle may depart from the lane.

While the steering wheel operation assist is operating, the screen display notifies the driver.

### **Instrument cluster (Type A)**

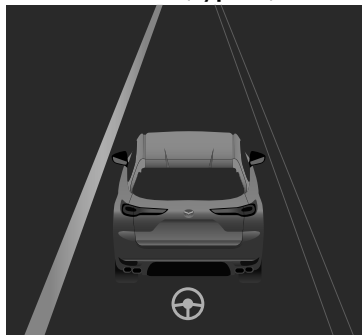

## Lane-keep Assist System (LAS)

---

### Instrument cluster (Type B)



### Active driving display



### NOTE

- The LAS operates only on the side that detects white lines (yellow lines).
- The LAS may not operate normally if any of the following conditions is met.
  - The forward sensing camera (FSC) cannot detect target objects. Refer to Forward Sensing Camera (FSC) on page 5-125.
  - The visibility of white (yellow) lane lines is poor.

### LAS temporary cancellation

If any of the following conditions is met, the LAS is temporarily canceled. The LAS operation is automatically restored when the system's operation conditions are met.

- The turn signal lever is operated.
- The steering wheel is operated abruptly.
- The accelerator pedal is depressed abruptly.
- The brake pedal is depressed.

- The TCS/DSC is operating.
- The TCS/DSC is turned off.
- The Off-Road Traction Assist is on.

### Turning off the LAS

The LAS can be turned off using the Mazda Connect.

Refer to the Settings section in the Mazda Connect Owner's Manual.

When the LAS is turned off, the LAS & LDWS OFF indicator  turns on.

## Emergency Lane Keeping (ELK)

The ELK is a system designed to assist the driver's steering wheel operation to avoid danger.

The ELK has the following 3 functions.

### Road Keep Assist

The Road Keep Assist assists the driver to avoid departure from the road. If your vehicle may be deviating from the road, the Road Keep Assist provides steering assistance to avoid departure from the road. In addition, a screen display and a warning sound notify the driver of the danger.

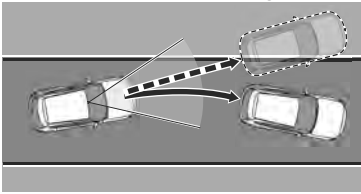

### Blind Spot Assist\*

The Blind Spot Assist assists the driver in avoiding collisions with vehicles in adjacent lanes (excluding vehicles approaching in the opposite direction).

If there is a possibility of a collision with a vehicle in an adjacent lane when you try to change lanes or if you may deviate from your lane, the Blind Spot Assist assists your steering wheel operation to keep you in the driving lane. In addition, a screen display and

a warning sound notify the driver of the danger.

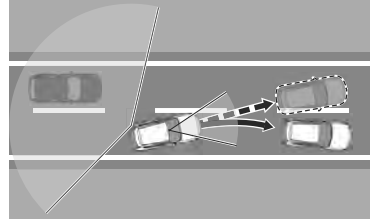

### Head-on traffic avoidance assist\*

The Head-on traffic avoidance assist assists you in avoiding a collision with a vehicle approaching in the oncoming lane and your vehicle.

If there is a possibility of a collision with a vehicle approaching in the oncoming lane due to your vehicle departing from its lane, the Head-on traffic avoidance assist assists your steering wheel operation to keep you in the original driving lane. In addition, a screen display and a warning sound notify the driver of the danger.

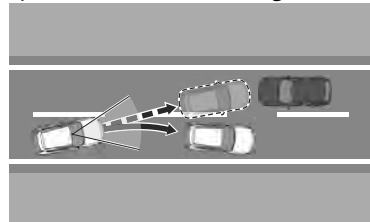

## Emergency Lane Keeping (ELK)

### Warnings and Cautions for Using the Emergency Lane Keeping (ELK)

#### **⚠ WARNING**

#### **Do not rely completely on the ELK.**

- The ELK has limitations. Do not rely completely on the system and always stay on course using the steering wheel.
- The ELK is not an automated driving system. Over reliance on the system could lead to an accident.
- The detection range of the camera and sensors is limited. If the steering wheel operation assist is operated without detecting a two-wheeled vehicle near the detecting vehicle, it could result in an accident.

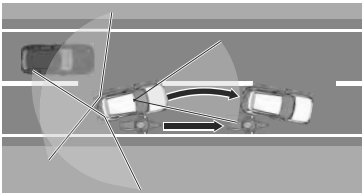

#### **Do not use the ELK under the following conditions. Otherwise, it may result in an accident.**

- The vehicle is driven on slippery roads such as icy roads, snow-covered roads, and unpaved roads.
- Tires other than the specified size are used, such as when tire chains or temporary spare tires are used.
- **(Blind Spot Assist)**  
The vehicle is driven on roads other than expressways and highways.
- **(Blind Spot Assist and Head-on traffic avoidance assist)**

The rear bumper around a rear side radar sensor is deformed.

## How to Use the Emergency Lane Keeping (ELK)

### Road Keep Assist

#### The Road Keep Assist operates

When all the following conditions are met, the Road Keep Assist operates to assist the steering wheel operation.

- The vehicle speed is about 64 km/h (40 mph) or faster.
- The vehicle is driven on a straight road or gentle curve.
- The function recognizes the outside of the road by detecting target objects (such as gravel, grass, street gutters, road curbs, guardrails, or walls).
- The CTS steering assist function is not operating.
- The system determines that your vehicle may deviate from the road.

While the steering wheel operation assist is operating, the screen display notifies the driver.

#### Instrument cluster (Type A)

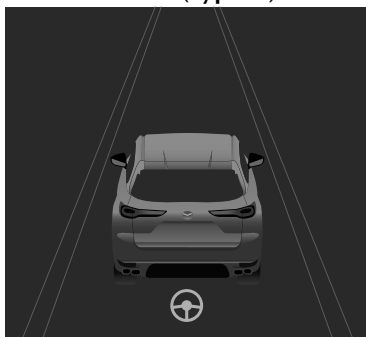

#### Instrument cluster (Type B)



#### Active driving display



Furthermore, if the possibility of a road departure increases, a screen display and a warning sound notify the driver of the danger. Operate the steering wheel according to the screen display.

#### Instrument cluster (Type A)

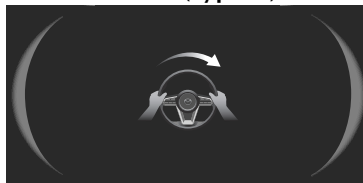

#### Instrument cluster (Type B)

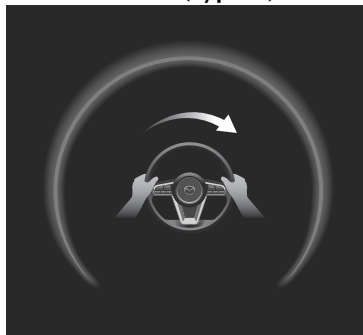

# Emergency Lane Keeping (ELK)

## Active driving display



### NOTE

- The Road Keep Assist may not operate normally when any of the following conditions is met.
  - The Forward Sensing Camera (FSC) cannot detect target objects. Refer to Forward Sensing Camera (FSC) on page 5-125.
  - The road width is narrow.
- When the system detects target objects on one side only, the system does not operate to avoid a road departure in the direction of the side that is not being detected.
- If the driver operates the steering wheel while the steering wheel operation assist is operating, the steering wheel operation assist is canceled.

## When the Road Keep Assist is temporarily canceled

The Road Keep Assist goes on stand-by when any of the following conditions is met. The Road Keep Assist is automatically restored when its operation conditions are met.

- The turn signal lever is operated.
- The accelerator pedal is depressed abruptly.
- The brake pedal is depressed.
- The steering wheel is operated abruptly.
- The TCS/DSC is operating.
- The TCS/DSC is turned off.

## Blind Spot Assist\*

### The Blind Spot Assist operates

When all of the following conditions are met, the Blind Spot Assist operates to assist the steering wheel operation.

- The vehicle speed is about 64 km/h (40 mph) or faster.
- The vehicle is driven on a straight road or gentle curve.
- The system detects white (yellow) lane lines on both sides.
- The CTS steering assist function is not operating.
- The system determines that your vehicle may collide with a vehicle from a rear side.

While the steering wheel operation assist is operating, a screen display and a warning sound notify the driver.

### Instrument cluster (Type A)



### Instrument cluster (Type B)

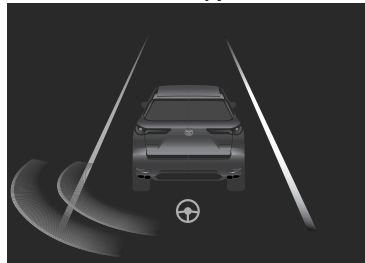

## Active driving display



Furthermore, if the possibility of a collision increases, a screen display and the warning sound notify the driver of the danger. Operate the steering wheel according to the screen display.

## Instrument cluster (Type A)

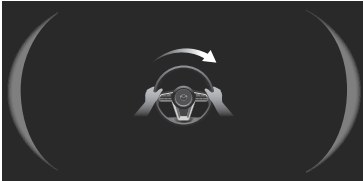

## Instrument cluster (Type B)

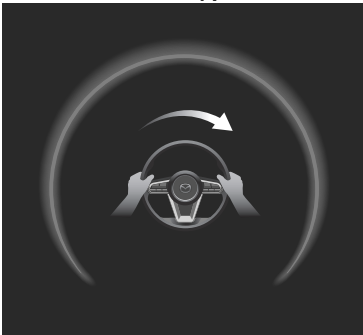

## Active driving display



## NOTE

- The Blind Spot Assist may not operate normally when any of the following conditions is met.
  - The Forward Sensing Camera (FSC) cannot detect target objects correctly.

Refer to Forward Sensing Camera (FSC) on page 5-125.

- The rear side radar sensors cannot detect target objects correctly. Refer to Radar Sensors on page 5-129.
- The width of the vehicle lane is narrow or wide.
- The vehicle is driven on a section with a closed lane or temporary lane due to construction.
- The vehicle is driven on a forked road or junction.
- If the driver operates the steering wheel while the steering wheel operation assist is operating, the steering wheel operation assist is canceled.

## When the Blind Spot Assist is temporarily canceled

The Blind Spot Assist goes on stand-by when any of the following conditions is met. The Blind Spot Assist is automatically restored when its operation conditions are met.

- The accelerator pedal is depressed abruptly.
- The brake pedal is depressed.
- The steering wheel is operated abruptly.
- The TCS/DSC is operating.
- The TCS/DSC is turned off.
- Multiple vehicles are traveling in the detecting area near your vehicle.

## Head-on traffic avoidance assist\*

### The Head-on traffic avoidance assist operates

When all the following conditions are met, the Head-on traffic avoidance assist operates to assist the steering wheel operation.

- The vehicle speed is about 64 km/h (40 mph) or faster.



# Emergency Lane Keeping (ELK)

---

- The vehicle is driven on a straight road or gentle curve.
- The system detects white (yellow) lane lines on both sides.
- The CTS steering assist function is not operating.
- The system determines that your vehicle may collide with a vehicle approaching in the oncoming lane.

While the steering wheel operation assist is operating, the screen display notifies the driver.

### Instrument cluster (Type A) i-ACTIVSENSE display



### Instrument cluster (Type A) Other than i-ACTIVSENSE display

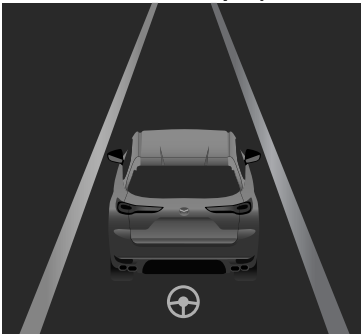

### Instrument cluster (Type B) i-ACTIVSENSE display



### Instrument cluster (Type B) Other than i-ACTIVSENSE display



### Active driving display



Furthermore, if the possibility of a road departure increases, a screen display and a warning sound notify the driver of the danger. Operate the steering wheel according to the screen display.

### Instrument cluster (Type A)

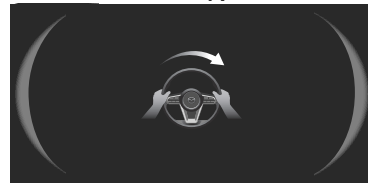

## Instrument cluster (Type B)

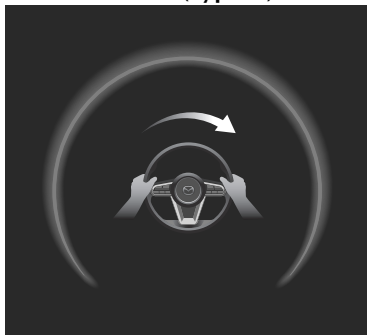

## Active driving display



## NOTE

- The Head-on traffic avoidance assist may not operate normally when any of the following conditions is met.
  - The Forward Sensing Camera (FSC) cannot detect target objects. Refer to Forward Sensing Camera (FSC) on page 5-125.
  - The front radar sensors cannot detect target objects.
  - The width of the vehicle lane is narrow or wide.
  - The vehicle is driven on a section with a closed lane or temporary lane due to construction.
  - The vehicle is driven on a forked road or junction.
- If the driver operates the steering wheel while the steering wheel operation assist is operating, the steering wheel operation assist is canceled.

## When the Head-on traffic avoidance assist is temporarily canceled

The Head-on traffic avoidance assist goes on stand-by when any of the

following conditions is met. The Head-on traffic avoidance assist is automatically restored when its operation conditions are met.

- The accelerator pedal is depressed abruptly.
- The brake pedal is depressed.
- The steering wheel is operated abruptly.
- The TCS/DSC is operating.
- The TCS/DSC is turned off.
- Multiple vehicles are traveling in the detecting area near your vehicle.

## Turning off the ELK

The ELK can be turned off using the Mazda Connect.

Refer to the Settings section in the Mazda Connect Owner's Manual.

When the ELK is turned off, the ELK OFF indicator  turns on.

## Smart Brake Support (SBS)

SBS is a system designed to avoid collisions and reduce damage in the event of a collision by controlling the brakes. Sensors and camera equipped on the vehicle detect objects, and operate brake control if there is a possibility of your vehicle colliding with the object.

One part of the SBS functions when you are driving forward and the other part functions when you are driving in reverse.

### Forward drive detection

Forward drive detection has the following 5 functions.

#### Forward detection function

The forward detection function is designed to assist the driver in avoiding collisions with objects (vehicles ahead, pedestrians, bicycles, and motorcycles) at the front and to reduce damage in the event of a collision.

If there is a possibility of your vehicle colliding with a target object at the front, you are notified of possible danger by a screen display and a warning sound. Furthermore, if the possibility of a collision increases, brake control is performed to avoid collision and reduce damage in the event of a collision.

In addition, when the driver depresses the brake pedal, the brakes are applied firmly and quickly to assist.

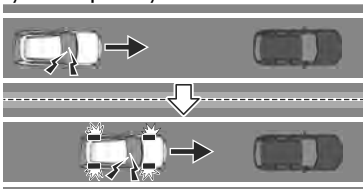

### Turn-Across Traffic\*

The Turn-Across Traffic is designed to assist the driver in avoiding a collision with a vehicle approaching in the opposite direction when making a left turn at an intersection and to reduce damage in the event of a collision. If there is a possibility of your vehicle colliding with a vehicle approaching in the opposite direction when you make a left turn at an intersection, you are notified of possible danger by a screen display and a warning sound. Furthermore, if the possibility of a collision increases, brake control is performed to avoid collision and reduce damage in the event of a collision.

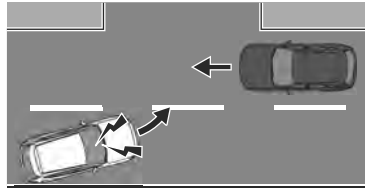

### Front Crossing\*

Front Crossing is designed to assist the driver in avoiding a collision at an intersection and reduce damage. If there is a possibility of a collision with a vehicle at an intersection, brake control is performed to avoid a

collision or to reduce damage in the event of a collision.

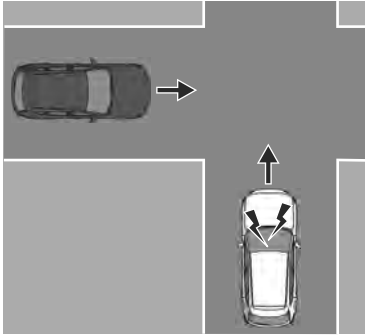

### Intersection accident avoidance assist function\*

Intersection accident avoidance assist function is designed to avoid collisions with objects (pedestrians and bicycles) when making a left or right turn at an intersection and to reduce damage in the event of a collision.

If there is a possibility of your vehicle colliding with a target object when you make a left or right turn at an intersection, you are notified of possible danger by a screen display and a warning sound. Furthermore, if the possibility of a collision increases, brake control is performed to avoid collision and reduce damage in the event of a collision.

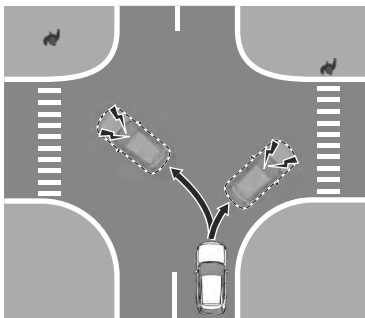

### Head-on collision mitigation\*

Head-on collision mitigation is a function designed to reduce damage in the event of a collision with a vehicle approaching in the opposite direction. If there is a possibility of your vehicle colliding with a vehicle approaching in the opposite direction, a screen display and a warning sound notify the driver of the danger. Furthermore, if the possibility of a collision increases, the brake control operates to reduce the damage in the event of a collision.

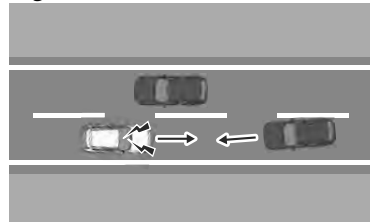

### Reverse drive detection

Reverse drive detection has the following 2 functions.

#### Rearward detection function\*

The rearward detection function is designed to assist the driver in avoiding collisions with objects at the rear (obstructions and pedestrians\*) and to reduce damage in the event of a collision.

If there is a possibility of your vehicle colliding with a target object at the rear, you are notified of possible danger by a screen display and a warning sound. Furthermore, if the possibility of a collision increases, brake control is performed to avoid

## Smart Brake Support (SBS)

collision and reduce damage in the event of a collision.

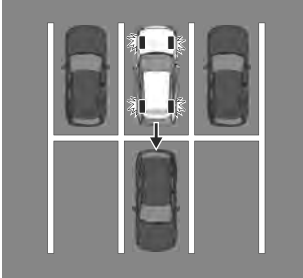

### Rear Crossing\*

The Rear Crossing is designed to avoid collision and reduce damage in the event of a collision with a vehicle approaching from the rear sides. If there is a possibility of your vehicle colliding with a vehicle approaching from the rear sides, you are notified of possible danger by a screen display and a warning sound. Furthermore, if the possibility of a collision increases, brake control is performed to avoid collision and reduce damage in the event of a collision.

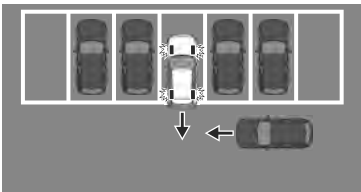

## Warnings and Cautions for Using the Smart Brake Support (SBS)

### ⚠ WARNING

#### Do not rely completely on the SBS.

The SBS is only designed to reduce damage in the event of a collision. Over reliance on the system leading to the accelerator pedal or brake pedal being mistakenly operated could result in an accident.

#### Heed the following cautions so that the SBS can operate normally.

- Do not modify the suspensions.
- Handle the Forward Sensing Camera (FSC) appropriately. Otherwise, the Forward Sensing Camera (FSC) may not be able to detect target objects, which could result in an accident. Refer to Forward Sensing Camera (FSC) on page 5-125.
- Handle the radar sensors appropriately. Otherwise, the radar sensors may not be able to detect target objects, which could result in an accident. Refer to Radar Sensors on page 5-129.
- Handle the ultrasonic sensors appropriately. Otherwise, the ultrasonic sensors may not be able to detect target objects, which could result in an accident. Refer to Ultrasonic Sensors on page 5-133.
- Handle the rear camera appropriately. Otherwise, the rear camera may not be able to detect target objects, which could result in an accident.

Refer to Cameras on page 5-135.

**Always check the surrounding area visually.**

The operation of the SBS has certain limitations. Always confirm the safety around the vehicle visually when driving.

**CAUTION**

- If any of the following conditions is met, turn the SBS off to prevent a mis-operation.
  - A trailer is pulled or an accessory such as a bicycle carrier is installed to the rear of the vehicle.
  - The vehicle is driven on rough roads such as in areas where there is grass and foliage or off-road.
- Use the specified tire size and the same type of tire on all 4 wheels. In addition, do not use tires with significantly different wear patterns on the same vehicle. If such improper tires are used, the SBS may not operate normally.

## How to Use the Smart Brake Support (SBS)

**NOTE**

During the SBS brake control, the brake pedal may move rearward or become stiff. The brakes are operating, but continue to depress the brake pedal.

**When the forward detection function operates**

The forward detection function operates when all of the following conditions are met.

- **(If an object is a vehicle ahead)**
  - The vehicle speed is about 4 km/h (3 mph) or faster.
- **(If an object is a bicycle/pedestrian)**
  - The vehicle speed is about 10 km/h to 80 km/h (6.3 mph to 49 mph).
  - The DSC does not operate.
  - The system determines that there is a possibility of a collision with an object ahead.

When the forward detection function operates, the driver is notified of the danger by the screen display and warning sound. Furthermore, if the possibility of a collision increases, brake control is performed.

**Instrument cluster (Type A)**

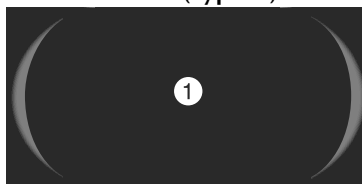

1. "BRAKE!"

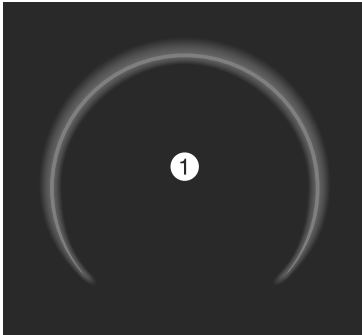
**Instrument cluster (Type B)**

1. "BRAKE!"

**Active driving display**

1. "BRAKE!"

**NOTE**

- If any of the following conditions is met, the forward detection function may not operate normally.
  - The Forward Sensing Camera (FSC) cannot detect target objects. Refer to Forward Sensing Camera (FSC) on page 5-125.
  - The front radar sensor cannot detect target objects. Refer to Radar Sensors on page 5-129.
- When there is the possibility of a partial contact with a target object.
- The driver deliberately performs driving operations (accelerator pedal operation, steering wheel operation, selector lever operation, and turn signal lever operation).
- If any of the following conditions is met, the forward detection function may operate.

- An animal or object on the road is detected.
- Passing an approaching vehicle while rounding a curve.
- Vehicle is passing through a narrow gate or a gate with a low ceiling.
- There is a metal object, bump, or a protruding object on the road.
- **(Vehicles with Driver Monitoring (DM))**

If the system determines that the driver is not paying attention to the road, it activates the collision warning earlier than normal.

- If the forward detection function performs brake control and the vehicle is stopped, the system will continue to hold the brakes for a brief time unless there is an operation performed by the driver.
- The operation distance and volume of the collision warning can be changed.

Refer to the Settings section in the Mazda Connect Owner's Manual.

**The Turn-Across Traffic operation conditions\***

The Turn-Across Traffic operates when all of the following conditions are met.

- The vehicle speed is about 4 km/h to 20 km/h (3 mph to 12 mph).
- The left turn signal light is turned on and the vehicle is turning left.
- A lane line between your vehicle and the vehicle approaching in the opposite direction is detected.
- The system determines that there is a possibility of collision with an object ahead.

When the Turn-Across Traffic operates, the driver is notified of the danger by the screen display and warning sound. Furthermore, if the possibility of a

collision increases, brake control is performed.

**Instrument cluster (Type A)**

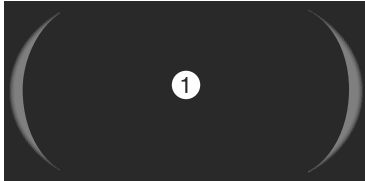

1. "BRAKE!"

**Instrument cluster (Type B)**

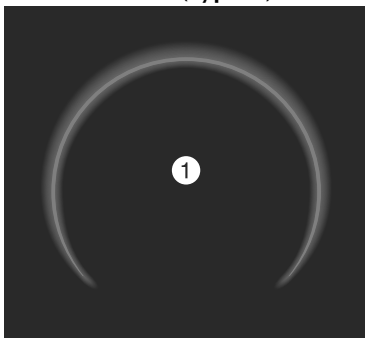

1. "BRAKE!"

**Active driving display**



1. "BRAKE!"

**NOTE**

- If any of the following conditions is met, the Turn-Across Traffic may not operate normally.
  - The Forward Sensing Camera (FSC) cannot detect target objects. Refer to Forward Sensing Camera (FSC) on page 5-125.
  - The front radar sensor cannot detect target objects. Refer to Radar Sensors on page 5-129.

- The vehicle approaching in the opposite direction is a two-wheeled vehicle or a bicycle.
- All of or only a part of a vehicle approaching in the opposite direction is hidden and it cannot be recognized.
- The speed of the on-coming vehicle is too slow or too fast.
- Turning at a large intersection with two lanes or more on one side.
- The accelerator pedal or brake pedal is being operated.
- The steering wheel is being operated in the straight-ahead position.
- The Turn-Across Traffic may not operate depending on the country where the vehicle is driven.
- If any of the following conditions is met, the Turn-Across Traffic may operate.
  - The steering wheel is turned towards the on-coming traffic lane with a vehicle approaching in the opposite direction.
  - Turning right after or right before an oncoming vehicle passes.
  - The direction of movement of a vehicle approaching in the opposite direction cannot be predicted due to sudden right/left turning or sudden deceleration.
- The brakes are released by the brake control of the Turn-Across Traffic as soon as the danger of a collision passes.

**When Front Crossing is Operating\***

The Front Crossing operates when all of the following conditions are met.

- The vehicle is traveling straight at a speed of about 5 km/h to 20 km/h (3 mph to 12 mph).
- The DSC/TCS is not operating.



## Smart Brake Support (SBS)

- When an approaching vehicle is traveling straight in a direction perpendicular to your vehicle.
- The approaching vehicle is traveling at a constant speed within the range of about 20 km/h to 60 km/h (12 mph to 37 mph).
- The system determines that there is a possibility of a collision with a vehicle approaching from the front.

### NOTE

- Front Crossing may not operate normally if any of the following conditions is met.
  - The front side radar sensors cannot detect target objects. Refer to Radar Sensors on page 5-129.
  - The accelerator pedal or brake pedal is being operated.
  - The steering wheel is being operated.
  - The turn signal lever is being operated.
- The Front Crossing brake force may differ depending on the operation conditions.
- If Front Crossing performs brake control and the vehicle is stopped, the vehicle is held stopped until the estimated passing time of the target vehicle has elapsed.

### When the intersection accident avoidance assist function operates\*

The intersection accident avoidance assist function operates when all of the following conditions are met.

- The vehicle speed is about 8 km/h to 20 km/h (5 mph to 12 mph).
- The DSC is not operating.
- The system determines that there is a possibility of a collision with an object ahead.

**5-220** \*Some models.

If the intersection accident avoidance assist function operates, a screen display and warning sound the driver notify the driver of the danger. Furthermore, if the possibility of a collision increases, brake control is performed.

### Instrument cluster (Type A)



1. "BRAKE!"

### Instrument cluster (Type B)

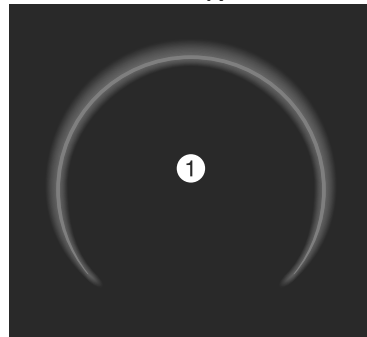

1. "BRAKE!"

### Active driving display



1. "BRAKE!"

### NOTE

- If the Forward Sensing Camera (FSC) cannot detect objects, the intersection accident avoidance assist function may not operate normally.

Refer to Forward Sensing Camera (FSC) on page 5-125.

- If the intersection accident avoidance assist function performs brake control and the vehicle is stopped, the system will continue to hold the brakes for a brief time unless there is an operation performed by the driver.

**When the head-on collision mitigation operates\***

The head-on collision mitigation operates when all of the following conditions are met.

- The vehicle speed is between about 45 km/h to 100 km/h (28 mph to 62.1 mph).
- The DSC is not operating
- The vehicle approaching in the opposite direction is driving in the same vehicle lane as your vehicle.
- The system detects the vehicle lane boundaries on both sides.
- There is no space in the vehicle lane for the vehicle approaching in the opposite direction to take evasive action.

When head-on collision mitigation is operating, the driver is notified of the danger by the screen display and the warning sound. Furthermore, if the possibility of a collision increases, brake control is performed.

**Instrument cluster (Type A)**

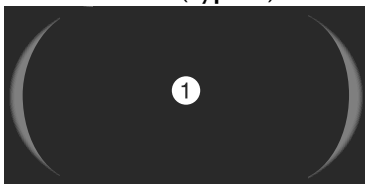

1. "BRAKE!"

**Instrument cluster (Type B)**

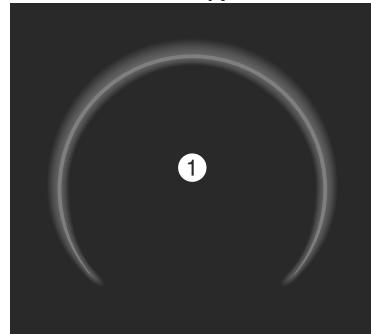

1. "BRAKE!"

**Active driving display**



1. "BRAKE!"

**NOTE**

- Head-on collision mitigation may not operate normally when any of the following conditions is met.
  - The Forward Sensing Camera (FSC) cannot detect target objects. Refer to Forward Sensing Camera (FSC) on page 5-125.
  - The front radar sensor cannot detect target objects. Refer to Radar Sensors on page 5-129.
  - The vehicle approaching in the opposite direction is a two-wheeled vehicle or a bicycle.
  - The vehicle in the opposite direction is stopped.
  - The speed of the vehicle approaching in the opposite direction is too slow or too fast.
  - There is the possibility of partial contact with the target object.

# Smart Brake Support (SBS)

- The driver deliberately performs driving operations (accelerator pedal operation, steering wheel operation, selector lever operation, and turn signal lever operation).
- The vehicle lane makes a curve.
- The vehicle lane width is outside the range of about 3 m to 3.6 m (118 in to 142 in).
- Even if there is no eventual collision, head-on collision mitigation may operate if the vehicle approaching in the opposite direction comes very close to the front of your vehicle.
- After head-on collision mitigation operates, the brakes may be released before the collision depending on the conditions.

## When the rearward detection function operates\*

The rearward detection function operates when all of the following conditions are met.

- The vehicle speed is about 2 km/h to 15 km/h (2 mph to 9.3 mph).
- The system determines that there is a possibility of collision with an object at the rear.

When the rearward detection function operates, the screen display and warning sound notify the driver of the danger. Furthermore, if the possibility of a collision increases, brake control is performed.

### Instrument cluster (Type A)

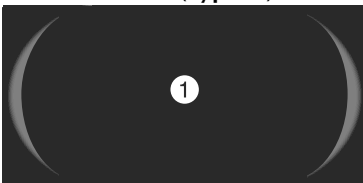

1. "BRAKE!"

### Instrument cluster (Type B)

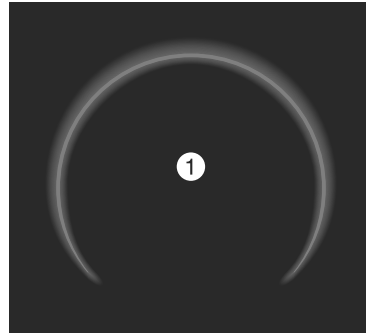

1. "BRAKE!"

### Active driving display



1. "BRAKE!"

### NOTE

- If any of the following conditions is met, the rearward detection function may not operate normally.
  - The rear ultrasonic sensors cannot detect an object.  
Refer to Ultrasonic Sensors on page 5-133.
  - The rear camera cannot detect an object.  
Refer to Cameras on page 5-135.
- If any of the following conditions is met, the rearward detection function may operate.
  - There is a hanging curtain.
  - Vehicle is passing through a narrow gate or a gate with a low ceiling.
  - There is a metal object, bump, or a protruding object on the road.

- If the rearward detection function performs brake control and the vehicle is stopped, the system will continue to hold the brakes for a brief time unless there is an operation performed by the driver.

**When the Rear Crossing is operating\***

The Rear Crossing operates when all of the following conditions are met.

- The vehicle speed is about 15 km/h (9.3 mph) or slower.
- The system determines that there is a possibility of a collision with a vehicle approaching from a rear side.

When the Rear Crossing operates, the screen display and warning sound notify the driver is notified of the danger. Furthermore, if the possibility of a collision increases, brake control is performed.

**Instrument cluster (Type A)**

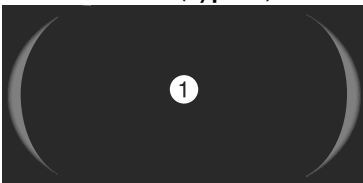

1. "BRAKE!"

**Instrument cluster (Type B)**

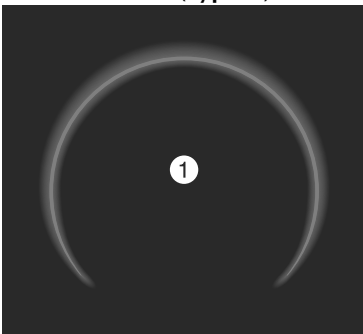

1. "BRAKE!"

**Active driving display**



1. "BRAKE!"

**NOTE**

- If any of the following conditions is met, the Rear Crossing may not operate normally.
  - The rear side radar sensors cannot detect an object. Refer to Radar Sensors on page 5-129.
  - A vehicle is approaching directly from the rear of your vehicle.
  - A vehicle is approaching at an angle from the rear of your vehicle.
  - A vehicle is approaching from a direction at an acute angle.
- If any of the following conditions is met, the Rear Crossing may operate.
  - There is a hanging curtain.
  - Vehicle is passing through a narrow gate or a gate with a low ceiling.
- If the Rear Crossing performs brake control and the vehicle is stopped, the system will continue to hold the brakes for a brief time unless there is an operation performed by the driver.

**Turning off the SBS**

The SBS can be turned off using the Mazda Connect.

Refer to the Settings section in the Mazda Connect Owner's Manual.

When the SBS is turned off, the SBS

OFF indicator  turns on.

Driving  
**360° View Monitor**

---

## 360° View Monitor\*

The 360° view monitor is a system which assists the driver in checking safety by displaying the conditions around the vehicle on the center display when the vehicle is driven at low speeds or when the vehicle is parked or stopped.

### Top view

Displays an image of the vehicle as if it were viewed from directly above to assist in checking the area around the vehicle when driving forward or in reverse.

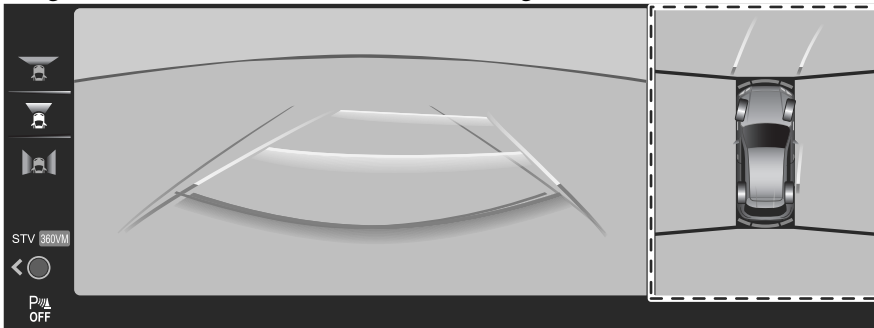

### Front view

Displays an image of the front of the vehicle together with the guide lines to assist in checking the area at the front of the vehicle when driving forward, parking, or stopping.

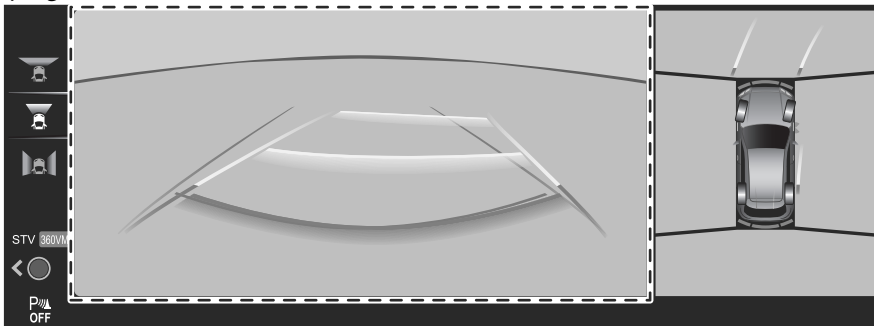

**Front wide view**

Displays an image of the front of the vehicle (wide area) together with the guide lines to assist in checking the area at the front of the vehicle when driving forward or entering an intersection.

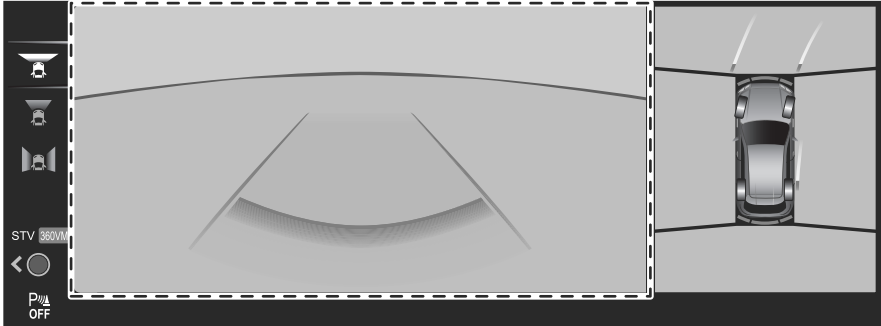

**Side view**

Displays an image of the front left and right sides of the vehicle together with the guide lines to assist in checking the front left and right sides of the vehicle when driving forward, parking, or stopping.

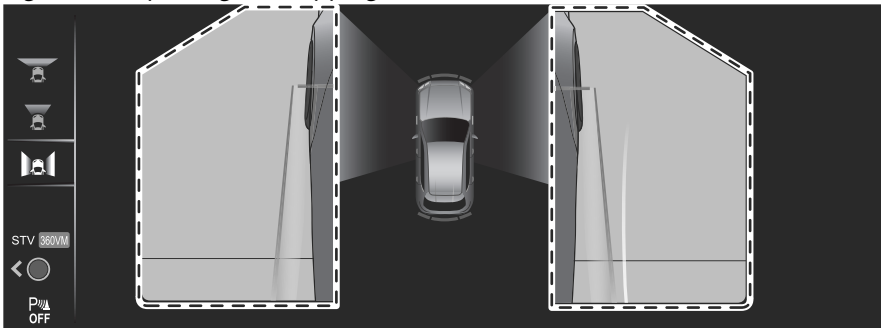

Driving  
**360° View Monitor**

---

**Rear view**

Displays an image of the rear of the vehicle together with the guide lines to assist in checking the area at the rear of the vehicle when reversing, parking, or stopping.

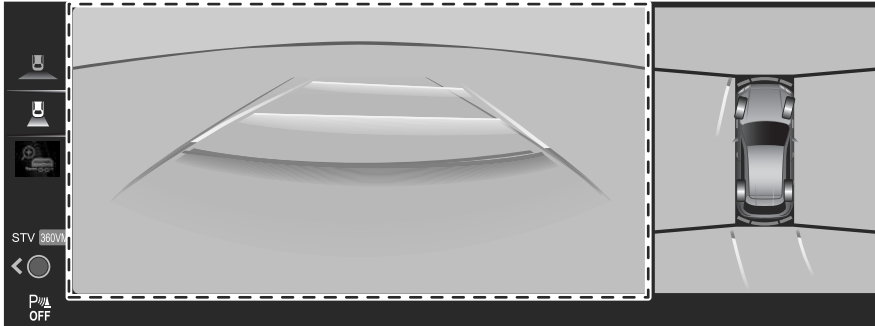

**Rear wide view**

Displays an image of the rear of the vehicle (wide area) together with the guide lines to assist in checking the area at the rear of the vehicle when reversing, parking, or stopping.

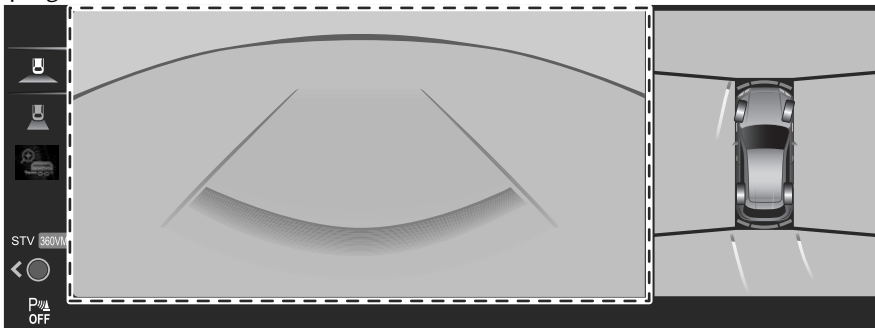

**See-Through View\***

The See-Through View is a function that combines the images taken by each camera and processes them to look as if the vehicle is transparent and displays them on the center display.

### Front See-Through View

Displays a camera image of the front of the vehicle as though it was transparent together with the guide lines to assist in checking the area at the front/sides of the vehicle when driving forward, parking, or stopping.

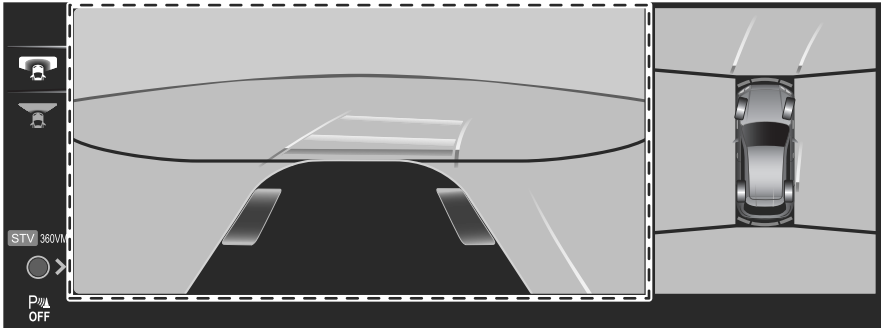

### Rear See-Through View

Displays a camera image of the rear of the vehicle as though it was transparent together with the guide lines to assist in checking the area at the rear/sides of the vehicle when reversing, parking, or stopping.

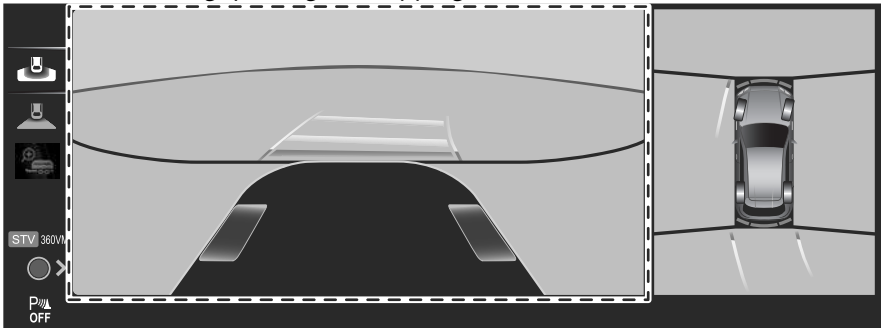



**Trailer Hitch View\***

The Trailer Hitch View is a function that combines the image of the vehicle rear with the Trailer Hitch Guideline on the center display to facilitate alignment when hitching a trailer to the vehicle.

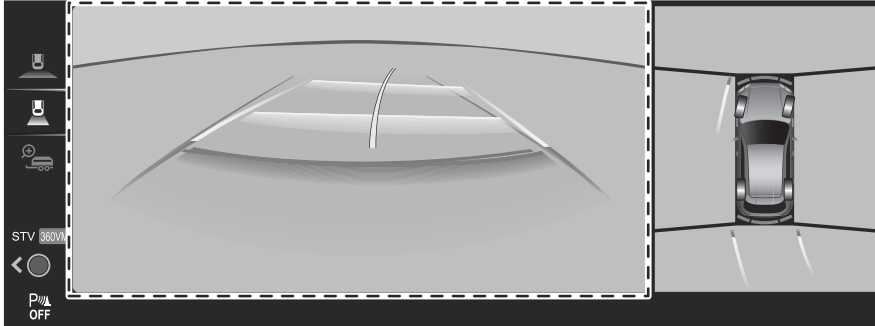

**Trailer Hitch Zoom View**

Displays images around the hitch ball to facilitate final positioning.

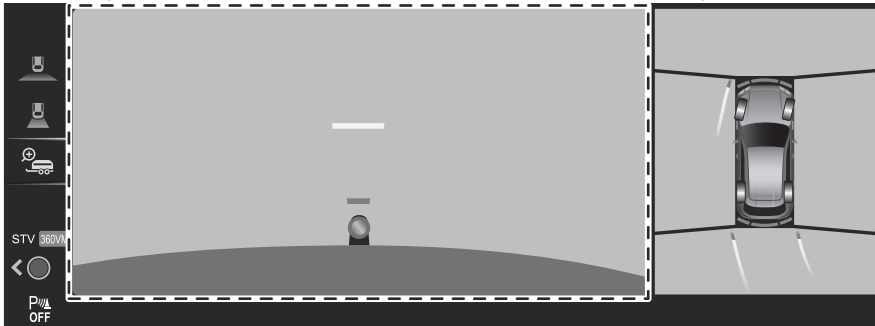

## Warnings and Cautions for Using the 360° View Monitor

### **WARNING**

**Always confirm the safety of the area around the vehicle visually when driving.** The 360° View Monitor is an auxiliary device which assists the driver in checking the safety of the area around the vehicle.

**Do not rely completely on the 360° View Monitor.**

- The shooting range of the cameras and detection range of the sensors are limited. For example, the following locations displayed on the screen may be blind spots and target objects may not be visible.
  - Areas in black on screen
  - Seams where each of camera images merge
- See-Through View may not be able to accurately display obstructions near the seams of the image.

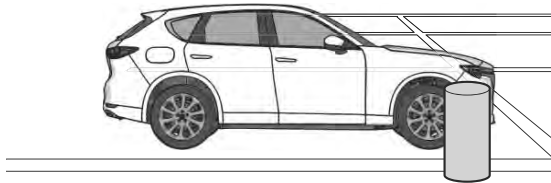
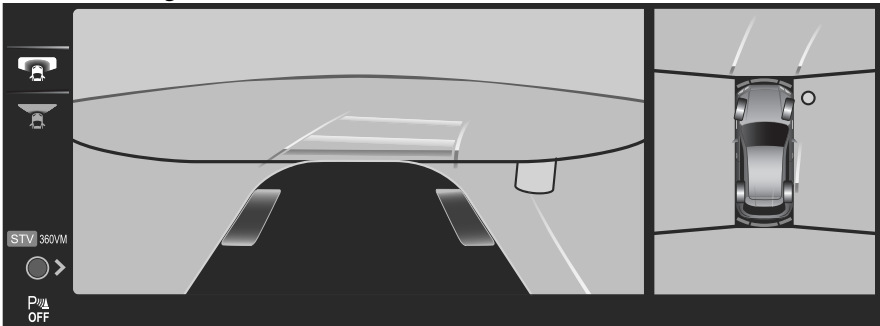

- Vehicle width extension lines and projected vehicle paths are only estimates. Images displayed on the display may differ from the actual conditions.

**⚠ CAUTION**

- Handle the cameras appropriately. If the cameras are handled incorrectly, images may not be displayed normally.  
Refer to Cameras on page 5-135.
- Do not use the 360° view monitor in the following locations or conditions.
  - Bumpy roads
  - The vehicle is on a road incline.
  - Icy or snow-covered roads
  - Tire chains or a temporary spare tire is installed.
  - The doors are not fully closed.
  - The outside mirrors are retracted.
- If the doors are not completely closed, images and guide lines may not be displayed correctly.
- Heed the following cautions to assure that the 360° view monitor operates normally.
  - Do not modify the suspensions.
  - Always use wheels of the specified size for the front and rear wheels. Consult an Authorized Mazda Dealer for tire replacement.
- When the center display is cold, images may leave trails or the display might be darker than usual, making it difficult to check the vehicle surroundings. Always confirm the safety around the vehicle visually when driving.
- Recognizing images at night may be difficult because there are no lights in the shooting range of the side camera. Always confirm the safety around the vehicle visually when driving.
- The method for parking/stopping the vehicle using the 360° View Monitor differs depending on the road conditions and vehicle conditions. In addition, when and how much you turn the steering wheel will differ depending on the situation, therefore always check the vehicle surroundings directly with your eyes while using the system.

## How to Use the 360° View Monitor

### Displaying images of the vehicle front/sides



Images are displayed on the center display.

#### **NOTE**

- When the selector lever is in the R position, images of the front/sides of the vehicle are not displayed.
- If any of the following conditions are met, image display of the front/sides of the vehicle ends.
  - Switches around the commander knob are pressed.
  - The vehicle is driven at less than 15 km/h (9.3 mph) for about 4 minutes and 30 seconds.
  - The vehicle speed is 15 km/h (9.3 mph) or faster.
  - The vehicle is driven at 15 km/h (9.3 mph) or faster for 8 seconds.
  - The selector lever is shifted to the P position.

### Displaying images of the vehicle rear

Shift the selector lever to the R position.  
Images are displayed on the center display.

#### **(Vehicles with Trailer Hitch View)**

The Trailer Hitch View is operable on vehicles equipped with a Mazda genuine trailer hitch.

#### **NOTE**

Trailer Hitch View is a function that assumes the use of a Mazda genuine trailer hitch.

Trailer Hitch View can be used correctly only if a Mazda genuine trailer hitch is equipped.

### Switching the image

1. Turn the commander knob and move the cursor to the desired image.

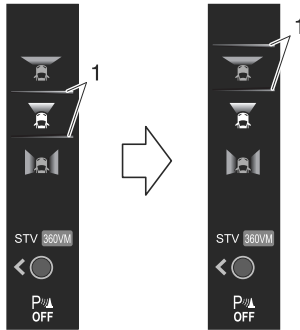

1. Cursor
2. Press the commander knob to select the image to display.

### **(Vehicles with See-Through View)**

Move the commander knob sideways to switch between 360° View mode (360VM) and See-Through View mode (STV).

### Viewing the screen

#### **NOTE**

- Because there might be a difference between the image displayed on the screen and the actual conditions, always check the safety of the surrounding area directly with your eyes when driving.
- Images may be difficult to see due to the weather and surrounding environment, however this does not indicate a problem.
- The rear view, rear wide view, and rear See-Through View images are reversed left and right
- The actual tires may appear in the top view and front See-Through View.
- Obstructions displayed in views other than the top view may not be displayed on the top view.
- The areas in black on the top view, front See-Through View, and rear See-Through View and the seams where each of camera images merge are blind spots.
- The top view, front See-Through View, and rear See-Through View are displayed by processing the images taken by each camera. Therefore, images may be displayed as follows.
  - Color or brightness displayed on the screen may appear differently than in actuality.
  - If the vehicle tilts, the image may appear distorted.
  - Lines on the road may appear distorted at the seams where each of the camera images merge.
- Screen brightness and contrast can be adjusted.

- Refer to the Settings section in the Mazda Connect Owner's Manual.
- The parking sensor detection range has limitations. For details, refer to the parking sensor entry.
- Refer to Parking Sensor on page 5-258.
- The screen display may differ from the actual display.
- **(Vehicles with Trailer Hitch View)**
  - The Trailer Hitch Guideline can be turned off.
  - Refer to the Settings section in the Mazda Connect Owner's Manual.
  - The Trailer Hitch Guideline may appear off-center in the video image.
  - When any of the following conditions is met, the hitch ball or the trailer coupling may appear deviated from the Trailer Hitch Guideline.
    - A vehicle condition has changed (such as weight, tire pressure).
    - The liftgate is not fully closed.
    - The road surface is not flat.
    - There is a large difference in height between the hitch ball and the trailer coupling.
    - The hitch ball position deviates from normal conditions.

**Top view, front view**

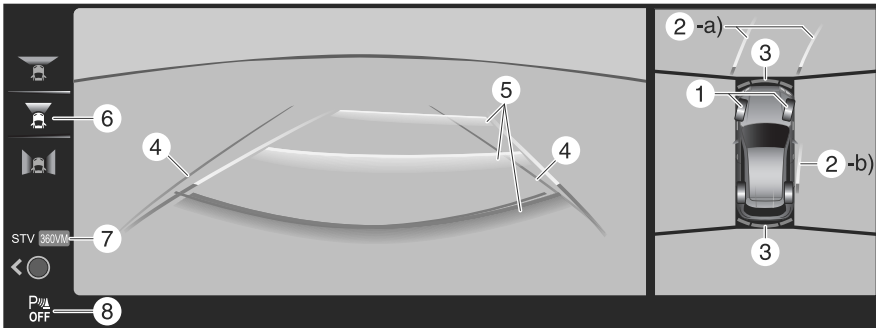

	Indication	Content
1	Tire icon	Indicates the tire direction. Moves in conjunction with the steering wheel operation.
2	Projected vehicle path lines (red/ yellow)	Indicates the approximate projected path of the vehicle. Moves in conjunction with the steering wheel operation. a) Indicates the path where the edge of the front bumper is expected to travel. b) Indicates the path where the inner side of the vehicle is expected to travel.
3	Parking sensor detection indication	Indicates the obstruction detection status.
4	Vehicle width guide lines (blue)	Indicates the approximate width of the vehicle.

Driving  
**360° View Monitor**

	Indication	Content
5	Projected vehicle path distance guide lines (red/yellow)	Indicates the distance (from front end of bumper) in front of the vehicle. <ul style="list-style-type: none"> <li>• The red line indicates the point about 50 cm (19 in) from the front end of the bumper.</li> <li>• The yellow lines indicate the points about 1 m (39 in) and 2 m (78 in) from the front end of the bumper.</li> </ul>
6	View status icon	Indicates which image is selected.
7	Mode switching icon	Indicates which mode is selected.
8	Parking sensor status icon	Indicates that the parking sensor has a problem or it is switched off.

**Top view, front wide view**

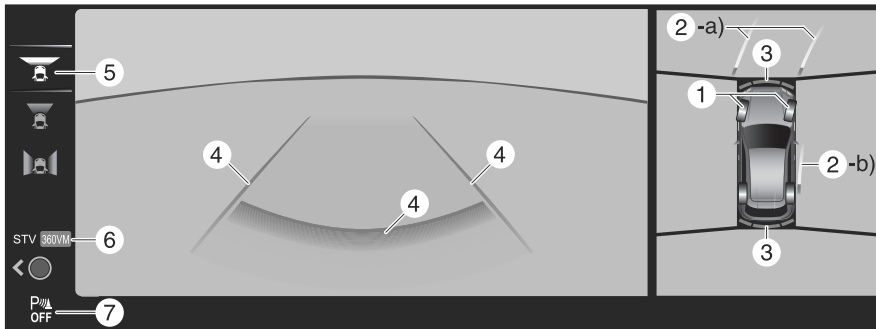

	Indication	Content
1	Tire icon	Indicates the tire direction. Moves in conjunction with the steering wheel operation.
2	Projected vehicle path lines (red/yellow)	Indicates the approximate projected path of the vehicle. Moves in conjunction with the steering wheel operation. <ul style="list-style-type: none"> <li>a) Indicates the path where the edge of the front bumper is expected to travel.</li> <li>b) Indicates the path where the inner side of the vehicle is expected to travel.</li> </ul>
3	Parking sensor detection indication	Indicates the obstruction detection status.

	Indication	Content
4	Extended vehicle width lines and distance guide lines (red/blue)	Indicates the approximate width of the vehicle and the distance (from front end of bumper) in front of the vehicle. <ul style="list-style-type: none"> <li>• The red line indicates the point about 50 cm (19 in) from the front end of the bumper.</li> <li>• The blue lines indicate the points from about 50 cm (19 in) and up to 2 m (78 in) from the front end of the bumper.</li> </ul>
5	View status icon	Indicates which image is selected.
6	Mode switching icon	Indicates which mode is selected.
7	Parking sensor status icon	Indicates that the parking sensor has a problem or it is switched off.

**NOTE**

The front wide view displays the image in front of the vehicle at a wide angle and corrects the image to help detect approaching obstructions from the side. Therefore, it differs from the actual view.

**Side view**

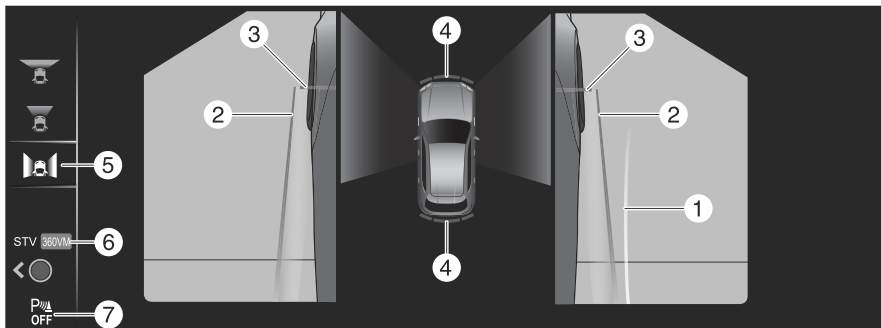

	Indication	Content
1	Projected vehicle path lines (yellow)	Indicates the approximate projected path of the vehicle. Moves in conjunction with the steering wheel operation. The projected vehicle path lines (yellow) indicate the path the inner side of the vehicle is expected to travel.
2	Vehicle parallel guide lines (blue)	Indicates the approximate vehicle width including the outside mirrors.
3	Vehicle front end guide lines (blue)	Indicates the front edge of the vehicle (front edge of the bumper).



Driving  
**360° View Monitor**

	Indication	Content
4	Parking sensor detection indication	Indicates the obstruction detection status.
5	View status icon	Indicates which image is selected.
6	Mode switching icon	Indicates which mode is selected.
7	Parking sensor status icon	Indicates that the parking sensor has a problem or it is switched off.

**CAUTION**

Do not turn the steering wheel any more until the vehicle has passed the obstruction, even if the obstruction is not visible on the side view image. If the steering wheel is turned even more, the vehicle may contact the obstruction if it is turned sharply.

**Top view, rear view**

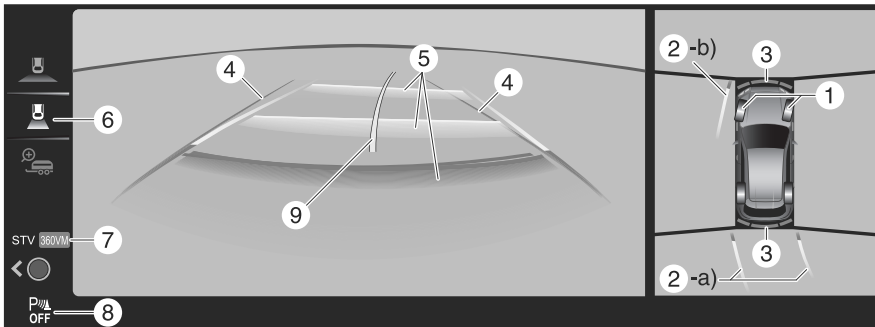

	Indication	Content
1	Tire icon	Indicates the tire direction. Moves in conjunction with the steering wheel operation.
2	Projected vehicle path lines (red/yellow)	Indicates the approximate projected path of the vehicle. Moves in conjunction with the steering wheel operation. a) Indicates the path where the rear end of the rear bumper passes as a reference. b) Indicates the path where the outer side of the vehicle is expected to travel.
3	Parking sensor detection indication	Indicates the obstruction detection status.
4	Vehicle width guide lines (blue)	Indicates the approximate width of the vehicle.

	Indication	Content
5	Projected vehicle path distance guide lines (red/yellow)	<p>These guide lines indicate the approximate distance to a point measured from the rear of the vehicle (from the end of the bumper).</p> <ul style="list-style-type: none"> <li>· The red line indicates the point about 50 cm (19 in) from the rear end of the rear bumper.</li> <li>· The yellow lines indicate the points about 1 m (39 in) and 2 m (78 in) from the rear end of the rear bumper.</li> </ul>
6	View status icon	Indicates which image is selected.
7	Mode switching icon	Indicates which mode is selected.
8	Parking sensor status icon	Indicates that the parking sensor has a problem or it is switched off.
9	Trailer Hitch Guideline	<p><b>(Vehicles with Trailer Hitch View)</b></p> <p>Indicates the approximate position of the hitch ball. Moves in conjunction with the steering wheel operation.</p>

**⚠ CAUTION**

The front of the vehicle swings out wide when turning the steering wheel while reversing. Maintain sufficient distance between the vehicle and an obstruction.

**NOTE**

- Even though the back end of the parking space (or garage) displayed on the screen and distance guide lines appear parallel, they may not actually be parallel.
- When parking in a space with a division line on only one side of the parking space, even though the division line and the vehicle width guide line appear parallel, they may not actually be parallel.

**Top view, rear wide view**

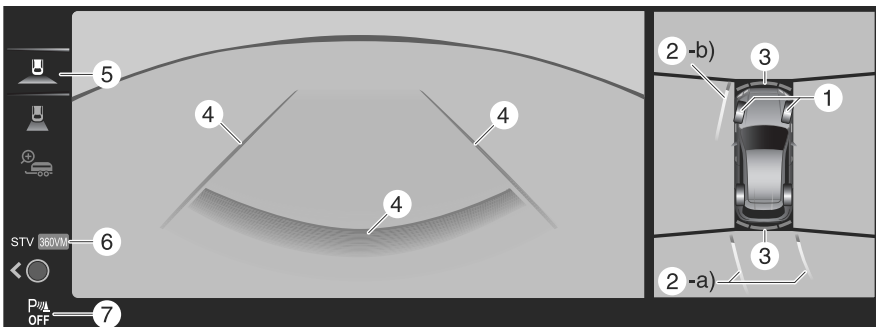

Driving  
**360° View Monitor**

	Indication	Content
1	Tire icon	Indicates the tire direction. Moves in conjunction with the steering wheel operation.
2	Projected vehicle path lines (red/ yellow)	Indicates the approximate projected path of the vehicle. Moves in conjunction with the steering wheel operation. a) Indicates the path where the rear end of the rear bumper passes as a reference. b) Indicates the path where the outer side of the vehicle is expected to travel.
3	Parking sensor detection indication	Indicates the obstruction detection status.
4	Extended vehicle width lines and distance guide lines (red/blue)	These guide lines indicate the approximate width of the vehicle and distance to a point measured from the rear of the vehicle (from the end of the bumper). <ul style="list-style-type: none"> <li>• The red line indicates the point about 50 cm (19 in) from the rear end of the rear bumper.</li> <li>• The blue lines indicate the points from about 50 cm (19 in) and up to 2 m (78 in) from the rear end of the bumper.</li> </ul>
5	View status icon	Indicates which image is selected.
6	Mode switching icon	Indicates which mode is selected.
7	Parking sensor status icon	Indicates that the parking sensor has a problem or it is switched off.

**NOTE**

The rear wide view displays the image at the rear of the vehicle at a wide angle and corrects the image to help detect approaching obstructions from the side. Therefore, it differs from the actual view.

**Top view, front See-Through View**

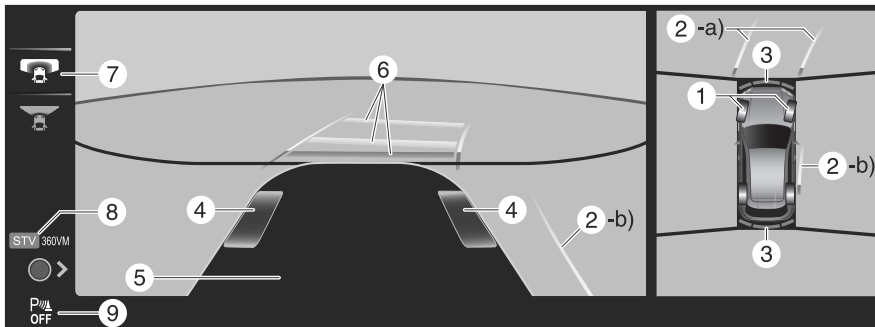

	Indication	Content
1	Tire icon	Indicates the tire direction. Moves in conjunction with the steering wheel operation.
2	Projected vehicle path lines (red/ yellow)	Indicates the approximate projected path of the vehicle. Moves in conjunction with the steering wheel operation. a) Indicates the path where the edge of the front bumper is expected to travel. b) Indicates the path where the inner side of the vehicle is expected to travel.
3	Parking sensor detection indication	Indicates the obstruction detection status.
4	Tire graphic	Indicates the approximate position of the tires.
5	Vehicle bottom graphic	Indicates the estimated bottom of the vehicle.
6	Projected vehicle path distance guide lines (red/yellow)	Indicates the distance (from front end of bumper) in front of the vehicle. · The red line indicates the point about 50 cm (19 in) from the front end of the bumper. · The yellow lines indicate the points about 1 m (39 in) and 2 m (78 in) from the front end of the bumper.
7	View status icon	Indicates which image is selected.
8	Mode switching icon	Indicates which mode is selected.
9	Parking sensor status icon	Indicates that the parking sensor has a problem or it is switched off.

**NOTE**

The front See-Through View may be displayed as follows.

- The ground and three-dimensional objects may appear curved.
- The representation of three-dimensional objects changes at the joints of images and the same object may appear to be duplicated or not connected.

**Top view, rear See-Through View**

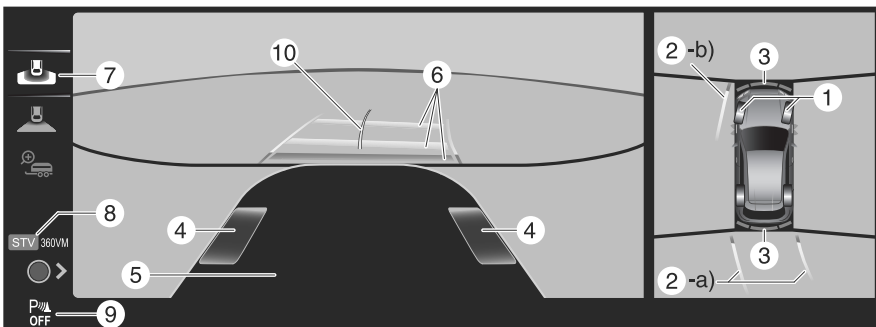

	Indication	Content
1	Tire icon	Indicates the tire direction. Moves in conjunction with the steering wheel operation.
2	Projected vehicle path lines (red/yellow)	Indicates the approximate projected path of the vehicle. Moves in conjunction with the steering wheel operation. a) Indicates the path where the rear end of the rear bumper passes as a reference. b) Indicates the path where the outer side of the vehicle is expected to travel.
3	Parking sensor detection indication	Indicates the obstruction detection status.
4	Tire graphic	Indicates the approximate position of the tires.
5	Vehicle bottom graphic	Indicates the estimated bottom of the vehicle.
6	Projected vehicle path distance guide lines (red/yellow)	These guide lines indicate the approximate distance to a point measured from the rear of the vehicle (from the end of the bumper). <ul style="list-style-type: none"> <li>• The red line indicates the point about 50 cm (19 in) from the rear end of the rear bumper.</li> <li>• The yellow lines indicate the points about 1 m (39 in) and 2 m (78 in) from the rear end of the rear bumper.</li> </ul>
7	View status icon	Indicates which image is selected.
8	Mode switching icon	Indicates which mode is selected.
9	Parking sensor status icon	Indicates that the parking sensor has a problem or it is switched off.
10	Trailer Hitch Guideline	<b>(Vehicles with Trailer Hitch View)</b> Indicates the approximate position of the hitch ball. Moves in conjunction with the steering wheel operation.

**NOTE**

The rear See-Through View may be displayed as follows.

- The ground and three-dimensional objects may appear curved.
- Expressions such as three-dimensional objects change at the seams of the image, and the same objects may be displayed in duplicate or may be connected and not visible.

**Top view, Trailer Hitch Zoom View**

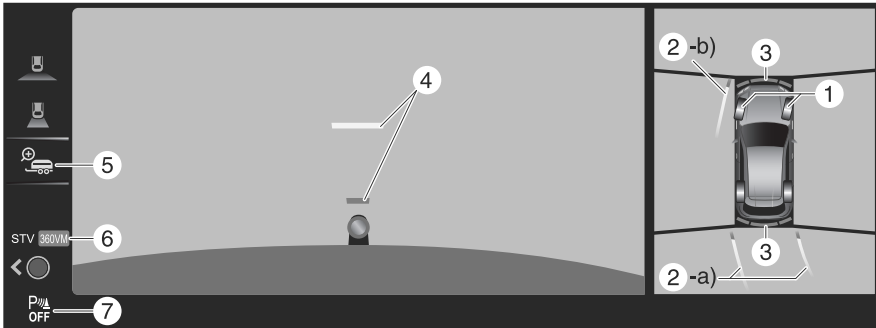

	Indication	Content
1	Tire icon	Indicates the tire direction. Moves in conjunction with the steering wheel operation.
2	Projected vehicle path lines (red/yellow)	Indicates the approximate projected path of the vehicle. Moves in conjunction with the steering wheel operation. a) Indicates the path where the rear end of the rear bumper passes as a reference. b) Indicates the path where the outer side of the vehicle is expected to travel.
3	Parking sensor detection indication	Indicates the obstruction detection status.
4	Projected vehicle path distance guide lines (red/yellow)	These guide lines indicate the approximate distance to a point measured from the rear of the vehicle (from the end of the bumper). · The red line indicates the point about 50 cm (19 in) from the rear end of the rear bumper. · The yellow lines indicate the points about 1 m (39 in) and 2 m (78 in) from the rear end of the rear bumper. Moves in conjunction with the steering wheel operation.
5	View status icon	Indicates which image is selected.
6	Mode switching icon	Indicates which mode is selected.
7	Parking sensor status icon	Indicates that the parking sensor has a problem or it is switched off.

**System problem indication**

In the following cases, there might be a problem with the system. Have the vehicle inspected by an Authorized Mazda Dealer.

- "No camera signal." is displayed on the center display.

- The display on the center display does not switch to the camera image even if the selector lever is shifted to the R position.
- The display on the center display does not switch to the camera image even if the 360° view monitor switch is pressed.
- A portion of the display on the center display is black.

## Convenient Ways to Use the 360° View Monitor

The 360° View Monitor settings can be changed as follows.

Refer to the Settings section in the Mazda Connect Owner's Manual.

- Automatic display of the 360° View Monitor when the vehicle power is switched ON.
- When the 360° view mode/ See-Through View mode is activated, the preferentially displayed images can be selected.
- Automatic display of the front view or front See-Through View when switching from reverse to forward gear.
- No display of the projected vehicle path lines.



## Secondary Collision Reduction

### Type A

The Secondary Collision Reduction reduces secondary damage by decelerating the vehicle when it is damaged in a collision to the extent that the airbags are deployed while driving.

If a collision occurs to the extent that the airbags are deployed while driving, the hazard warning lights flash to alert surrounding vehicles and the brakes are controlled to reduce damage in the event of a collision with an obstruction or other object.

### Type B

The Secondary Collision Reduction reduces secondary damage by decelerating the vehicle when it is damaged in a collision to the extent that the airbags are deployed while the vehicle is stopped.

If a collision occurs to the extent that the airbags are deployed while the vehicle is stopped, the hazard warning lights flash to alert surrounding vehicles and the brakes are controlled to reduce damage in the event of a collision with an obstruction or other object.

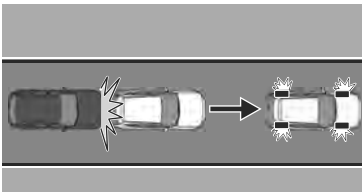

## Warnings and Cautions for Using the Secondary Collision Reduction

### ⚠ WARNING

**Do not rely completely on the Secondary Collision Reduction.**

- The Secondary Collision Reduction may not operate normally depending on various conditions such as the vehicle condition, component part damage condition, target object condition, weather conditions, or traffic conditions. Do not rely completely on the system and make it your responsibility as a driver to drive the vehicle.
- The functions of the Secondary Collision Reduction have limitations. If you neglect to operate the brake and accelerator pedals correctly, it could result in serious injury.

## Secondary Collision Reduction

### How to Use the Secondary Collision Reduction

#### When the Secondary Collision Reduction operates

##### **Type A**

The Secondary Collision Reduction operates if the vehicle is damaged in a collision to the extent that the airbags are deployed while driving.

##### **Type B**

The Secondary Collision Reduction operates if the vehicle is damaged in a collision to the extent that the airbags are deployed while the vehicle is stopped.

When the Secondary Collision Reduction operates, the system controls and applies the brakes until the vehicle stops. In addition, the hazard warning lights continue to flash. After the vehicle stops, the parking brake is applied by the Electric Parking Brake (EPB).

#### **NOTE**

- The brake lights turn on while the brakes are operating by the system control.
- If there is a malfunction with the electric parking brake (EPB), the brakes are released by the system control after the vehicle is stopped.

#### Secondary Collision Reduction is disabled

If any of the following conditions is met, the Secondary Collision Reduction is canceled.

- A certain period of time has passed since the system operated.

- After stopping the vehicle, the accelerator pedal is strongly depressed 3 times.
- The parking brake is released after the Electric Parking Brake (EPB) operates.

#### **NOTE**

- If the driver's brake pedal depression force is stronger than the system's brake control, the driver's brake operation takes priority.
- Flashing of the hazard warning lights by the system control is canceled when any of the following operations is performed.
  - Hazard warning light switch is pressed.
  - Vehicle power is switched OFF.

## Cruise Control\*

Cruise control reduces the load on the driver by driving the vehicle at a constant speed. The vehicle is driven at the preset speed and maintaining a constant vehicle speed without the driver having to depress the accelerator or brake pedal.

## Warnings and Cautions for Using the Cruise Control

### WARNING

**Do not rely completely on the cruise control.**

The functions of the cruise control have limitations. Always drive carefully by checking the safety of your surroundings and depressing the brake or accelerator pedal.

**Do not use the cruise control under the following conditions. Otherwise, it may result in an accident.**

- The vehicle is driven on roads other than highways.
- The vehicle is driven on roads with sharp curves or with heavy traffic where sufficient distances between vehicles cannot be kept.
- The vehicle is driven on slippery roads such as icy or snow-covered roads, and unpaved roads.
- The vehicle is driven on a long downslope.
- The vehicle is driven on a steep slope.

**Turn off the cruise control when not in use.**

Leaving the cruise control turned on when it is not in use is dangerous as it could operate unexpectedly, resulting in an accident.

### CAUTION

- Turn off the cruise control when being towed or when towing another vehicle.

- Turn off the cruise control when the vehicle is running on a chassis roller.

## How to Use the Cruise Control

### Setting the cruise control

1. Press the cruise control switch to turn the system on.





When the system is on, the cruise control standby indication (white)

 is displayed.

2. Accelerate the vehicle to the desired speed of 25 km/h (16 mph) or faster (minimum speed setting is 30 km/h (19 mph)).
3. Set the vehicle speed by pressing the RES switch up (SET+) or down (SET-).



When the vehicle speed is set, the set vehicle speed is displayed on the displays and the cruise control standby indication (white)  changes to the cruise control set indication (green) .

# Cruise Control

While the cruise control is operating, the driver is notified of the operation condition by the screen display.

## Instrument cluster (Type A)

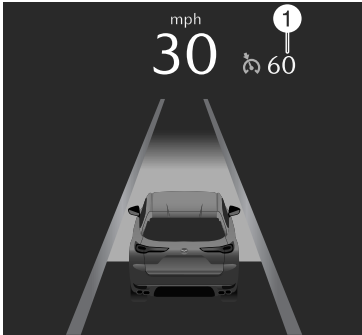

1. Set speed

## Instrument cluster (Type B) i-ACTIVSENSE display

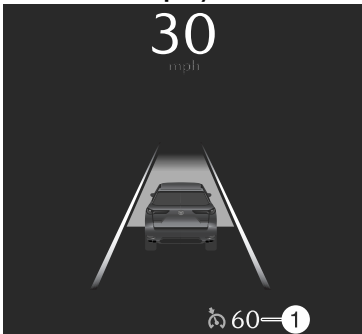

1. Set speed

## Instrument cluster (Type B) Other than i-ACTIVSENSE display



1. Set speed

## Active driving display

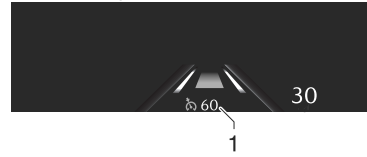

1. Set speed

### NOTE

- The cruise control does not operate when the Hill Descent Control is operating.
- The accelerator pedal operation takes priority during constant speed driving. When you release your foot from the accelerator pedal, the vehicle returns to constant speed driving at the set speed.
- If the distance between vehicles control is disabled using the Mazda Connect, the system switches to the cruise control. At this time, the MRCC switch functions as the cruise control switch. Refer to the Settings section in the Mazda Connect Owner's Manual. If the vehicle power is switched OFF while the distance between vehicles control is disabled, the distance between vehicles control is enabled automatically the next time the vehicle power is switched ON.
- The system may not be able to maintain the set speed depending on the road conditions such as steep up or down slopes.
- When the vehicle speed is less than 20 km/h (12 mph), the cruise control is canceled. If you want to use the cruise control again, reset the cruise control.
- The brake lights turn on while the brakes are operating by the cruise control.

### **Changing the set vehicle speed**

#### **Changing the set vehicle speed using the RES switch**

Press the RES switch up (SET+) or down (SET-) to the desired speed.

- Press and release immediately: 1 km/h (1 mph)
- Press and hold: 10 km/h (5 mph)

#### **Changing the set vehicle speed using the accelerator pedal**

Depress the accelerator pedal until the vehicle speed reaches the desired speed, then press the RES switch up (SET+) or down (SET-).

#### **The cruise control is temporarily canceled**

The cruise control is temporarily canceled when one of the following conditions is met.

- The brake pedal is depressed.
- The CANCEL switch is pressed one time.
- The DSC has operated.
- The Smart Brake Support (SBS) has operated.
- The frequency of the braking operation by the cruise control is high.

If the cruise control is temporarily canceled, it operates at the previously set speed by pressing the RES switch.

#### **Turning off the cruise control**

Press the cruise control switch.

The cruise control standby indication

(white)  /cruise control set

indication (green)  turns off and the cruise control stops.

# Rear View Monitor

---

## Rear View Monitor\*

The rear view monitor is a system which assists the driver in checking safety by displaying the conditions behind the vehicle on the center display when the vehicle is driven in reverse.

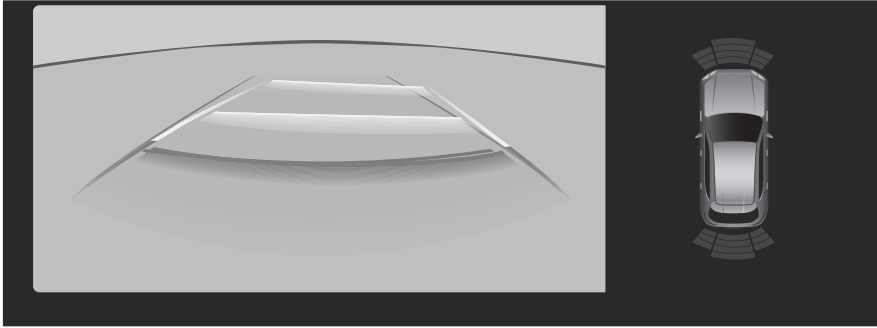

## Trailer Hitch View\*

The Trailer Hitch View is a function that combines the image of the vehicle rear with the Trailer Hitch Guideline on the center display to facilitate alignment when hitching a trailer to the vehicle.

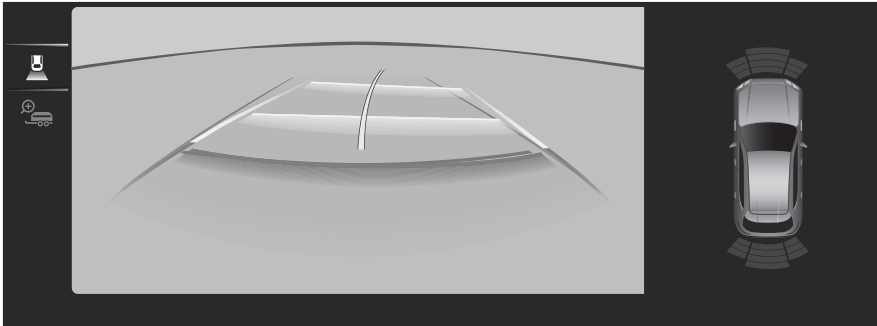

**Trailer Hitch Zoom View**

Displays images around the hitch ball to facilitate final positioning.

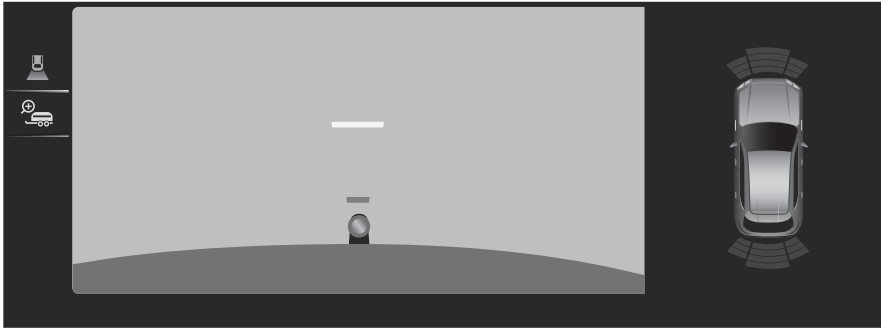



## Warnings and Cautions for Using the Rear View Monitor

### **WARNING**

**Always confirm the safety of the area around the vehicle visually when driving.** The rear view monitor is only designed to assist the driver while reversing. Images displayed on the display may differ from the actual conditions. Do not rely completely on the rear view monitor while reversing. Otherwise, the vehicle may contact an obstruction and cause an accident.

### **CAUTION**

- Do not use the rear view monitor in the following locations/situations.
  - There is a bump on a road.
  - The vehicle is on a road incline.
  - Icy or snow-covered slippery roads.
  - Tire chains or a temporary spare tire is installed.
  - The liftgate is not fully closed.
- When the center display is cold, images may leave trails or the display might be darker than usual, making it difficult to check the vehicle surroundings. Always confirm the safety around the vehicle visually when driving.

## How to Use the Rear View Monitor

### Displaying the rear view monitor

Shift the selector lever to the R position.  
Images are displayed on the center display.

### **(Vehicles with Trailer Hitch View)**

The Trailer Hitch View is operable on vehicles equipped with a Mazda genuine trailer hitch.

### **NOTE**

Trailer Hitch View is a function that assumes the use of a Mazda genuine trailer hitch.

Trailer Hitch View can be used correctly only if a Mazda genuine trailer hitch is equipped.

### Switching the image (Vehicles with Trailer Hitch View)

1. Turn the commander knob and move the cursor to the desired image.

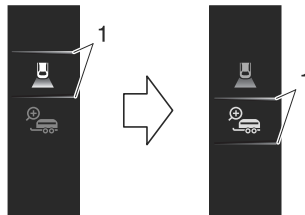

1. Cursor
2. Press the commander knob to select the image to display.

### Viewing the screen

### **NOTE**

- The images displayed on the center display are reversed left and right.
- **(Vehicles with Trailer Hitch View)**
  - The Trailer Hitch Guideline can be turned off.  
Refer to the Settings section in the Mazda Connect Owner's Manual.
  - The Trailer Hitch Guideline may appear off-center in the video image.
  - When any of the following conditions is met, the hitch ball or the trailer coupling may appear deviated from the Trailer Hitch Guideline.
    - A vehicle condition has changed (such as weight, tire pressure).
    - The liftgate is not fully closed.
    - The road surface is not flat.
    - There is a large difference in height between the hitch ball and the trailer coupling.
    - The hitch ball position deviates from normal conditions.

# Rear View Monitor

- Screen brightness and contrast can be adjusted.  
Refer to the Settings section in the Mazda Connect Owner's Manual.

## Type A

### When the parking sensor is ON

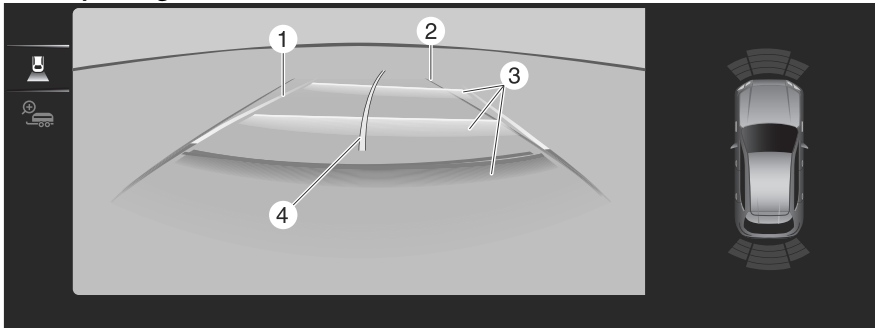

### When the parking sensor is OFF

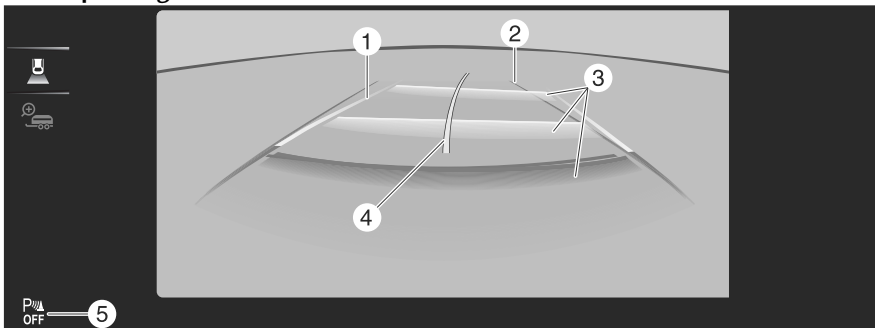

	Indication	Content
1	Projected vehicle path lines (yellow)	Indicates the approximate projected path of the vehicle. The projected vehicle path lines move in conjunction with the steering wheel operation.
2	Vehicle width guide lines (blue)	Indicates the approximate width of the vehicle. Does not display when the steering wheel is operated in a straight-ahead position.

	Indication	Content
3	Projected vehicle path distance guide lines (red/yellow)	<p>These guide lines indicate the approximate distance to a point measured from the rear of the vehicle (from the end of the bumper).</p> <ul style="list-style-type: none"> <li>• The center point of the red line indicates the point about 50 cm (19 in) from the rear end of the rear bumper.</li> <li>• The center points of the yellow lines indicate the points about 1 m (39 in) and 2 m (78 in) from the rear end of the rear bumper.</li> </ul>
4	Trailer Hitch Guideline	<p><b>(Vehicles with Trailer Hitch View)</b> Indicates the approximate position of the hitch ball. Moves in conjunction with the steering wheel operation.</p>
5	Parking sensor status icon	Indicates that the parking sensor has a problem or it is switched off.

**Trailer Hitch Zoom View (When the parking sensor is ON)**

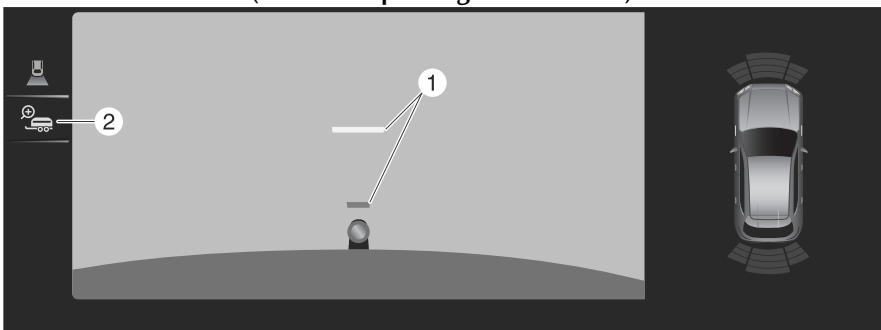

	Indication	Content
1	Projected vehicle path distance guide lines (red/yellow)	<p>These guide lines indicate the approximate distance to a point measured from the rear of the vehicle (from the end of the bumper).</p> <ul style="list-style-type: none"> <li>• The red line indicates the point about 50 cm (19 in) from the rear end of the rear bumper.</li> <li>• The yellow lines indicate the points about 1 m (39 in) and 2 m (78 in) from the rear end of the rear bumper.</li> </ul> <p>Moves in conjunction with the steering wheel operation.</p>
2	View status icon	Indicates which image is selected.

# Rear View Monitor

## Trailer Hitch Zoom View (When the parking sensor is OFF)

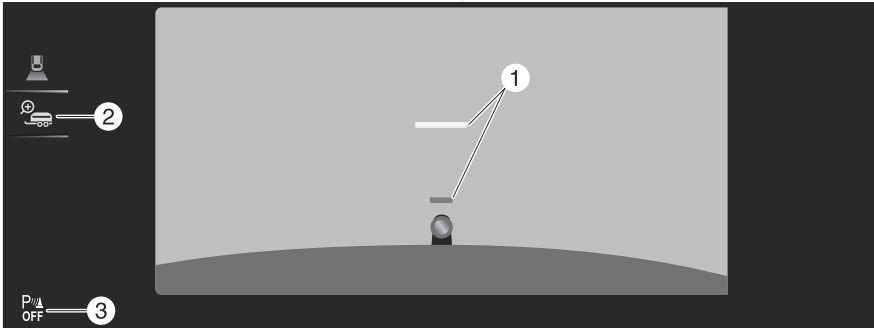

	Indication	Content
1	Projected vehicle path distance guide lines (red/yellow)	<p>These guide lines indicate the approximate distance to a point measured from the rear of the vehicle (from the end of the bumper).</p> <ul style="list-style-type: none"> <li>• The red line indicates the point about 50 cm (19 in) from the rear end of the rear bumper.</li> <li>• The yellow lines indicate the points about 1 m (39 in) and 2 m (78 in) from the rear end of the rear bumper.</li> </ul> <p>Moves in conjunction with the steering wheel operation.</p>
2	View status icon	Indicates which image is selected.
3	Parking sensor status icon	Indicates that the parking sensor has a problem or it is switched off.

### Type B

## When the parking sensor is ON

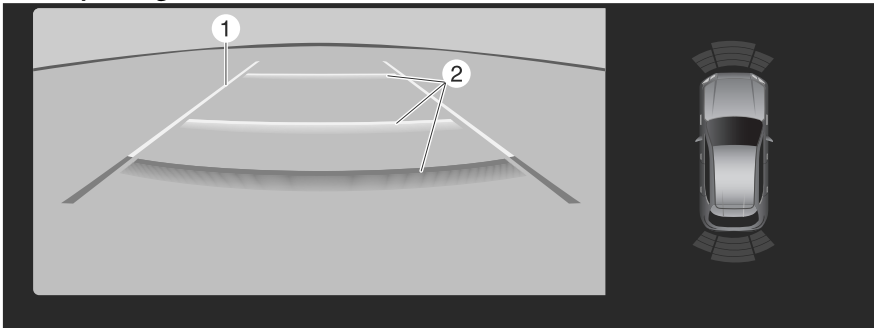

**When the parking sensor is OFF**

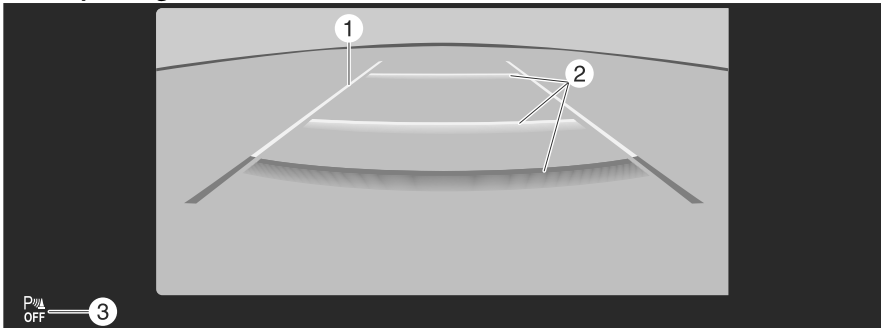

	Indication	Content
1	Vehicle width guide lines (yellow)	Indicates the approximate width of the vehicle.
2	Projected vehicle path distance guide lines (red/yellow)	<p>These guide lines indicate the approximate distance to a point measured from the rear of the vehicle (from the end of the bumper).</p> <ul style="list-style-type: none"> <li>· The red line indicates the point about 50 cm (19 in) from the rear end of the rear bumper.</li> <li>· The yellow lines indicate the points about 1 m (39 in) and 2 m (78 in) from the rear end of the rear bumper.</li> </ul>
3	Parking sensor status icon	Indicates that the parking sensor has a problem or it is switched off.

**System problem indication**

In the following cases, there might be a problem with the system. Have the vehicle inspected by an Authorized Mazda Dealer.

- "No camera signal." is displayed on the center display.
- The display on the center display does not switch to the camera image even if the selector lever is shifted to the R position.
- A portion of the display on the center display is black.

## Parking Sensor\*

The parking sensors are a system that assists the driver in checking safety by detecting obstructions around the vehicle and notifying the driver while parking. When an obstruction is detected, a screen display and a warning sound notify the driver of the distance to the obstruction.

## Warnings and Cautions for Using the Parking Sensor

### **WARNING**

**Always confirm the safety of the area around the vehicle visually when driving.**





The parking sensors are only auxiliary devices when driving forward or in reverse. In addition, the detection range of the sensors is limited, and driving the vehicle relying on the system completely may cause an accident.

## How to Use the Parking Sensor

**The parking sensors operate**





When the system detects an obstruction, the driver is notified of the presence of the obstruction by a screen display and a warning sound. The screen display and warning sound change according to the distance from the obstruction. In addition, if multiple obstructions are detected simultaneously, the warning sound for the nearest obstruction is activated.

**Front\*, rear**



Distance between vehicle and obstruction		Display		Warning sounds
Front	Rear	Vehicles without 360° View Monitor	Vehicles with 360° View Monitor	
About 1 m to 60 cm (39 in to 24 in)	About 1 m 50 cm to 60 cm (59 in to 24 in)	Green 	Green 	Slow, intermittent sound
About 60 cm to 50 cm (24 in to 20 in)	About 60 cm to 50 cm (24 in to 20 in)	Yellow 	Yellow 	Intermittent sound



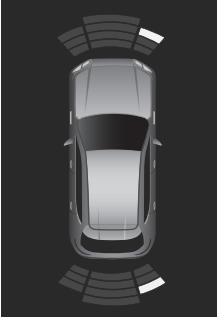

Driving  
**Parking Sensor**

Distance between vehicle and obstruction		Display		Warning sounds
Front	Rear	Vehicles without 360° View Monitor	Vehicles with 360° View Monitor	
About 50 cm to 40 cm (20 in to 16 in)	About 50 cm to 40 cm (20 in to 16 in)	Amber 	Amber 	Fast intermittent sound
Within about 40 cm (16 in)	Within about 40 cm (16 in)	Red 	Red 	

**Corners**

Distance between vehicle and obstruction	Display		Warning sounds
	Vehicles without 360° View Monitor	Vehicles with 360° View Monitor	
About 50 cm to 40 cm (20 in to 16 in)	Yellow 	Yellow 	Intermittent sound

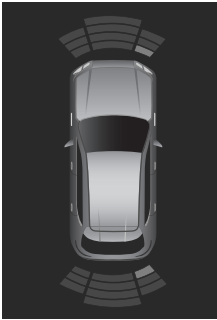
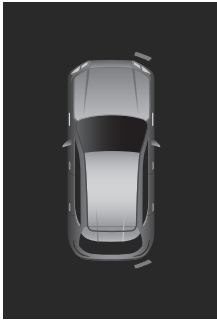
Distance between vehicle and obstruction	Display		Warning sounds
	Vehicles without 360° View Monitor	Vehicles with 360° View Monitor	
About 40 cm to 30 cm (16 in to 12 in)	Amber 	Amber 	Fast intermittent sound
Within about 30 cm (12 in)	Red 	Red 	Continuous sound

**NOTE**

- If ultrasound sensors cannot detect an object correctly, the system may not operate normally.  
Refer to Ultrasonic Sensors on page 5-133.
- The screen display can be switched between display and non-display and the volume of the warning sound can be changed.  
Refer to the Settings section in the Mazda Connect Owner's Manual.
- **(Vehicles with 360° View Monitor)**  
When the screen display is set to be displayed, the display automatically switches to the 360° View Monitor display when the sensor detects an obstruction. When an obstruction is no longer detected, the display switches to the display before the obstruction was detected. However, when the 360° View Monitor is displayed in advance, it continues to be displayed no matter if an obstruction is detected or not.

# Parking Sensor

---

- If an obstruction in the same detection range is detected continuously for 6 seconds or longer, only the warning sound stops (excluding the closest detection range). When the detection range changes to the close side, the warning sound resumes.

## Turning off the parking sensors

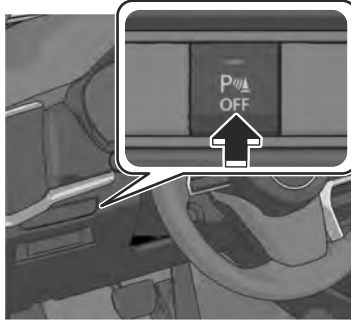

The parking sensors turn off and the parking sensor OFF switch indicator light turns on.

If the switch is pressed again, the parking sensors become operational and the indicator light of the switch turns off.

## System problem indication

- If a problem occurs, the following display notifies the driver. The system may have a malfunction. Have the vehicle inspected by an Authorized Mazda Dealer.  
(Vehicles without 360° View Monitor)

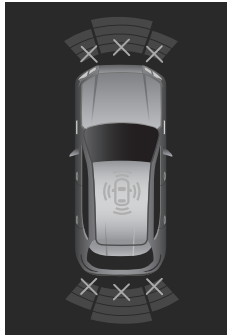

(Vehicles with 360° View Monitor)



- If a certain obstruction detection indication is continuously displayed, make sure that there is no foreign matter on the sensor area corresponding to the detection indicator. If the system does not recover, have the vehicle inspected by an Authorized Mazda Dealer.

## Winter Driving

Carry emergency gear, including tire chains, window scraper, flares, a small shovel, jumper cables, and a small bag of sand or salt.

Ask an Authorized Mazda Dealer to check the following:

- Have the proper ratio of antifreeze in the radiator.  
Refer to Inspecting the Coolant on page 9-20.
- Inspect the battery and its cables.  
Cold reduces battery capacity.
- Use an engine oil appropriate for the lowest ambient temperatures that the vehicle will be driven in (page 9-24).
- Inspect the ignition system for damage and loose connections.
- Use washer fluid made with antifreeze—but do not use engine coolant antifreeze for washer fluid (page 9-23).

When driving on ice or in water, snow, mud, sand, or similar hazards:

- Be cautious and allow extra distance for braking.
- Avoid sudden braking and sudden maneuvering.
- Do not pump the brakes. Continue to press down on the brake pedal.  
Refer to Antilock Brake System (ABS) on page 5-92.
- If you get stuck, select a lower gear and accelerate slowly. Do not spin the rear wheels.
- For more traction in starting on slippery surfaces such as ice or packed snow, use sand, rock salt, chains, carpeting, or other nonslip material under the rear wheels.

## NOTE

- Remove snow before driving. Snow left on the windshield is dangerous as it could obstruct vision.
- Do not apply excessive force to a window scraper when removing ice or frozen snow on the mirror glass and windshield.
- Never use warm or hot water for removing snow or ice from windows and mirrors as it could result in the glass cracking.
- Drive slowly. Braking performance can be adversely affected if snow or ice adheres to the brake components. If this situation occurs, drive the vehicle slowly, releasing the accelerator pedal and lightly applying the brakes several times until the brake performance returns to normal.

## Snow Tires

### **WARNING**

**Do Not Use Tires Other Than The Specified Size. In Addition, Do Not Mix Different Types Of Tires.**

Using tires with sizes other than the specified size or mixing different tire types is dangerous. It could compromise the vehicle's driveability, resulting in an accident. In addition, it could be in violation of the law.

Use the tire size indicated on the label applied to the door frame of the driver's door while the door is open. Use only the same type tires on all four wheels.

### **CAUTION**

Check local regulations before using studded tires.

#### Use snow tires on all 4 wheels

Do not go faster than 120 km/h (75 mph) while driving with snow tires. When installing winter tires, use tires of the specified size and adjust the air pressure of all the tires to the specified value. (page 10-69).

#### Mexico

The vehicle is originally equipped with summer tires designed for optimum traction on wet and dry roads. If your vehicle is to be used on snow and ice covered roads, Mazda recommends that you replace the tires originally equipped on your vehicle with snow tires during the winter months.

#### Except Mexico

The vehicle is originally equipped with all season radials designed to be used all year around. In some extreme climates you may find it necessary to replace them with snow tires during the winter months to further improve traction on snow and ice covered roads.

## Tire Chains

Check local regulations before using tire chains.

### CAUTION

- Chains may affect handling.
- Do not go faster than 50 km/h (30 mph) or the chain manufacturer's recommended limit, whichever is lower.
- Drive carefully and avoid bumps, holes, and sharp turns.
- Avoid locked-wheel braking.
- Do not use chains on a temporary spare tire; it may result in damage to the vehicle and to the tire.
- Do not use chains on roads that are free of snow or ice. The tires and chains could be damaged.
- Chains may scratch or chip aluminum wheels.

### NOTE

The tire pressure monitoring system may not function correctly when using tire chains.

Install the chains on the rear tires only. Do not use chains on the front tires. Please consult an Authorized Mazda Dealer.

### Installing the chains

1. Secure the chains on the rear tires as tightly as possible. Always follow the chain manufacturer's instructions.
2. Retighten the chains after driving 1/2—1 km (1/4—1/2 mile).

## Turbocharger

The turbocharger greatly enhances engine power. Its advanced design provides improved operation and requires minimum maintenance.

## Warnings and Cautions for Using the Turbocharger

### CAUTION

- After driving at freeway speeds or up a long hill, trailer towing for a long time, idle the engine at least 30 seconds before stopping it. Otherwise, the turbocharger could be damaged. However, when i-stop operates, idling is unnecessary.
- Racing or over-revving the engine, particularly after it's just been started, can damage the turbocharger.
- To protect the engine from damage, the engine is designed so that it cannot be raced just after starting it in extremely cold weather.



## How to Use the Turbocharger

To get the most from it, observe the following.

1. Change engine oil and filter according to Scheduled Maintenance.  
Refer to Scheduled Maintenance (U.S.A., Canada, and Puerto Rico) on page 9-6.  
Refer to Scheduled Maintenance (Mexico) on page 9-9.
2. Use only recommended engine oil (page 9-18). Extra additives are NOT recommended.

# 6

## Equipment to Make Cabin More Comfortable

### Fully Automatic Climate Control

<b>System (Front)</b> .....	<b>6-2</b>
Air Vents.....	6-2
How to Use the Air Vents.....	6-2
Fully Automatic Climate Control.....	6-4
Fully Automatic Climate Control Overview.....	6-6
How to Use the Fully Automatic Climate Control.....	6-7
Operating Each Switch.....	6-7

### Fully Automatic Climate Control

<b>System (Rear)</b> .....	<b>6-12</b>
Air Vents.....	6-12
How to Use the Air Vents.....	6-12
Fully Automatic Climate Control System.....	6-13
Fully Automatic Climate Control System Overview.....	6-14
How to Use the Fully Automatic Climate Control System.....	6-16
Operating Each Switch.....	6-17

### Seat Warmer.....

<b>6-19</b>	
Seat Warmer*.....	6-19
Warnings and Cautions For Using the Seat Warmer.....	6-19
How to Use the Seat Warmer.....	6-20
Convenient Ways to Use the Seat Warmer.....	6-21

### Heated Steering Wheel.....

<b>6-22</b>	
Heated Steering Wheel*.....	6-22
Warnings and cautions For Using the Heated Steering Wheel.....	6-22
How to Use Heated Steering Wheel.....	6-23
Convenient Ways to Use Heated Steering Wheel.....	6-23

### Seat Ventilation.....

<b>6-24</b>	
Seat Ventilation*.....	6-24
Warnings and cautions For Using the Seat Ventilation.....	6-24
How to Use the Seat Ventilation.....	6-25
Convenient Ways to Use the Seat Ventilation.....	6-25

### Driver Personalization System.....

<b>6-26</b>	
Driver Personalization System*.....	6-26
Warnings and Cautions For Using the Driver Personalization System.....	6-27
How to Use the Driver Personalization System.....	6-27

## Fully Automatic Climate Control System (Front)

---

### Air Vents

The location and the direction airflow exits the air vents changes depending on the air vent adjustment.

### How to Use the Air Vents

#### **Air vent open/close**

Move the dial fully in the fully open or fully closed direction.

#### **Side Vents**

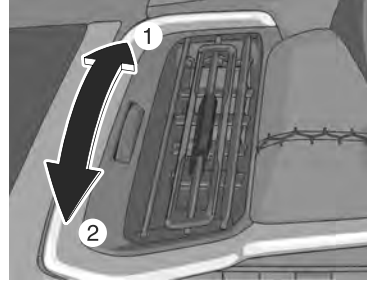

1. Open
2. Close

#### **Center Vents**

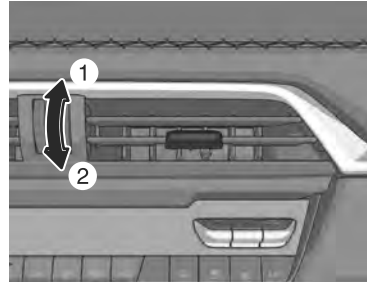

1. Open
2. Close

# Fully Automatic Climate Control System (Front)

## Airflow direction adjustment Side Vents

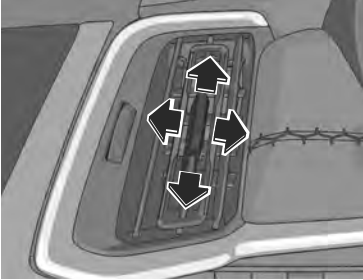

## Center Vents

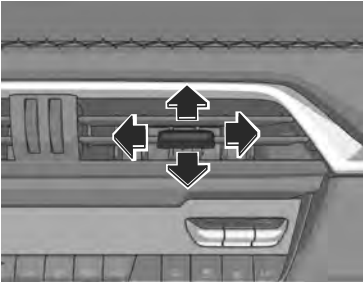

## Airflow selection Dashboard Vents



## Dashboard and Floor Vents

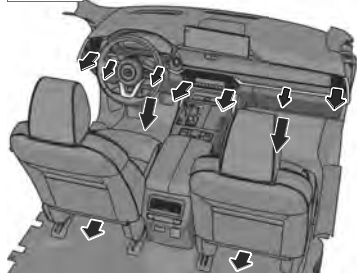

## Floor Vents



## Fully Automatic Climate Control System (Front)

### Defroster and Floor Vents

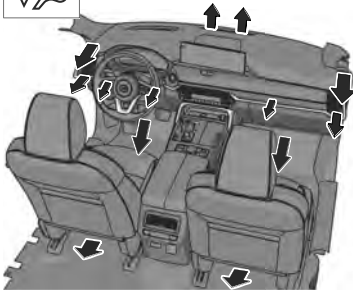

### Defroster Vents

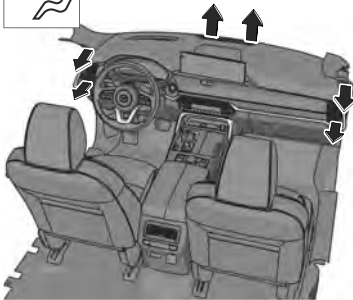

## Fully Automatic Climate Control

The following functions are automatically controlled according to the set temperature.

- Airflow temperature control
- Airflow amount control
- Airflow mode switching
- Recirculate/fresh air mode switching
- Air conditioning (cooling/dehumidifying functions) on/off
- Seat warmer level selection\*
- Heated steering wheel operation\*
- Seat ventilation level selection\*

### NOTE

To prevent cold airflow immediately after heating starts when the engine is cold, the airflow amount is decreased.

Fully automatic air-conditioning uses the sunlight and interior temperature sensors to control the temperature in the cabin by measuring interior and exterior temperatures, humidity, and sunlight. Do not cover the sunlight/interior temperature sensor.

### Sunlight sensor

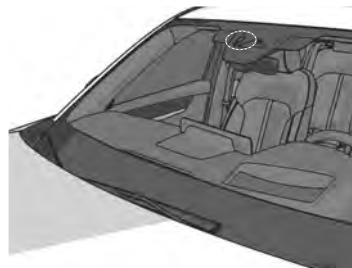

# Fully Automatic Climate Control System (Front)

---

## Interior temperature sensor

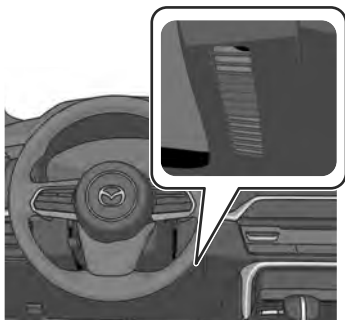

## Fully Automatic Climate Control System (Front)

### Fully Automatic Climate Control Overview

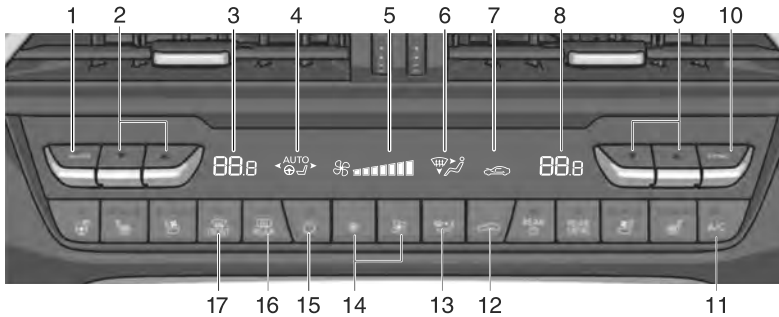

1. AUTO switch
2. Driver's side temperature setting switch
3. Driver's side temperature setting display
4. Linked auto-comfort display\*<sup>1</sup>  
Refer to Convenient Ways to Use the Seat Warmer on page 6-21.  
Refer to Convenient Ways to Use Heated Steering Wheel on page 6-23.  
Refer to Convenient Ways to Use the Seat Ventilation on page 6-25.
5. Airflow display
6. Mode selector display
7. Air intake selector display
8. Front passenger's side temperature setting display
9. Front passenger's side temperature setting switch
10. SYNC (synchronized temperature) switch
11. A/C switch
12. Air intake selector switch
13. Mode selector switch
14. Fan control switch
15. Climate control system power switch
16. Rear window defogger switch
17. Windshield defroster switch

\*<sup>1</sup> The display differs depending on the climate control systems, or whether or not the seat warmer, seat ventilation, and steering warmer are equipped.

# Fully Automatic Climate Control System (Front)

## How to Use the Fully Automatic Climate Control

1. Start the engine.
- 2.

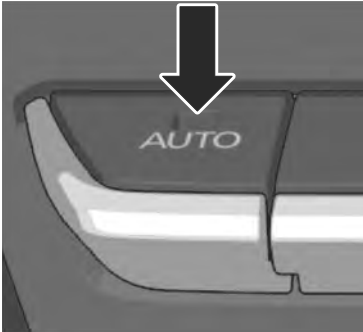

The AUTO switch indicator light turns on.

3. Press the temperature setting switch to set the desired temperature. Each function is automatically controlled according to the set temperature.
4. To stop the operation, press the climate control system power switch.

### NOTE

- The recommended set temperature is 22 °C (72 °F).
- If any mode selector switch, fan control switch, or windshield defroster switch is operated during auto operation, the AUTO switch indicator light turns off. The functions for switches other than those operated will continue to operate in auto control.

## Operating Each Switch

### AUTO switch

Automatically controlled according to the set temperature.

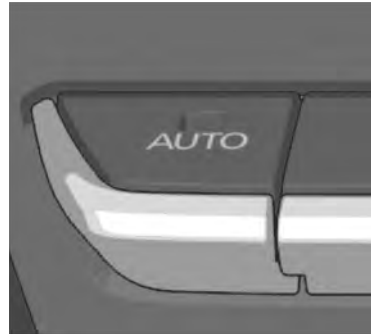

### Temperature setting switch

#### How to increase the set temperature

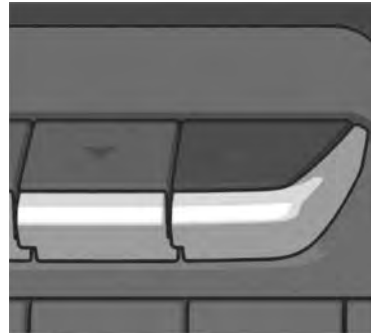



## Fully Automatic Climate Control System (Front)

---

### How to decrease the set temperature

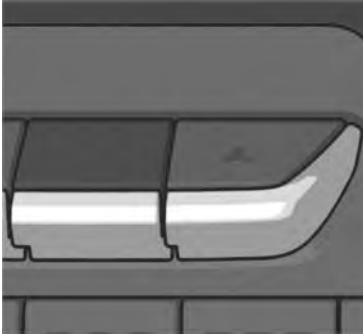

#### NOTE

- The set temperature changes in increments of 0.5 °C within a range of 15 °C (60 °F) and 29 °C (84 °F).
- The set temperature can be quickly adjusted by pressing and holding the temperature setting switch.
- When the temperature is set to the lower or upper limit, "Lo" or "Hi" is displayed.

### SYNC (synchronized temperature) switch



The mode switches between independent mode and interconnection mode each time the switch is pressed.

### Independent mode (indicator light turned off)

The set temperature can be controlled independently for the driver's side and front passenger's side.

Press the driver's side temperature setting switch or the front passenger's side temperature setting switch to control the temperature.

### Interconnection mode (indicator light turned on)

The set temperature for the driver's side and front passenger's side is controlled simultaneously.

Press the driver's side temperature setting switch to control the temperature.

#### NOTE

- The set temperature for the front passenger's side and the rear (while the rear climate control system is ON) changes to that of the driver when independent mode is switched to interconnection mode.
- When the front passenger's side temperature setting switch or the rear temperature setting switch is pressed while in interconnection mode (SYNC switch indicator light turned on), the mode switches to independent mode (SYNC switch indicator light turned off).

## Fully Automatic Climate Control System (Front)

### A/C switch



The cooling/dehumidifying function switches between on and off each time the switch is pressed. The indicator light turns on while the function is operating.

#### **NOTE**

The air conditioner may not operate when the ambient temperature falls to nearly 0 °C (32 °F) to protect the system.

### Rear window defogger switch

Use to defog the rear window. Refer to How to Use the Rear Window Defogger Switch on page 5-87.

### Air intake selector switch



The mode is switched between recirculate mode and fresh air mode each time the switch is pressed.

The display indicates whether recirculate mode (↻) or fresh air mode (↻) is selected.

### **! WARNING**

**Do not recirculate the air in the cabin during cold or rainy weather.**

Recirculating the air in the cabin during cold and rainy weather is dangerous as it will cause the windows to fog up. Your vision will be hampered, which could lead to a serious accident.

### **Recirculate mode (↻)**

Outside air is shut off. Air within the vehicle is recirculated. Use this position when going through tunnels, driving in congested traffic (high engine exhaust areas) or when quick cooling is desired.

### **Fresh air mode (↻)**

Outside air is allowed to enter the cabin. Use this position for ventilation or windshield defrosting.

#### **NOTE**

- The recirculated air position is the default position whenever the vehicle power is switched ON, the climate control system is on, and the outside temperature exceeds about 23 °C (73 °F).
- To exit the default recirculated air position, press the air intake selector switch to select the outside air position.
- When the air intake selector switch is set to the outside air position and the outside temperature exceeds about 23 °C (73 °F), the climate control system may automatically select the recirculated air position to improve the efficiency of the climate control system.

## Fully Automatic Climate Control System (Front)

---

### Mode selector switch



The desired airflow mode can be selected. The mode changes each time the switch is pressed. The selected mode is indicated on the display.

#### **NOTE**

To set the air vent to  press the windshield defroster switch.

### Fan control switch

#### **How to increase the airflow amount**



### **How to decrease the airflow amount**



The airflow amount changes each time the switch is pressed. The airflow amount is indicated on the display. The airflow amount can be adjusted to 7 levels.

### Climate control system power switch (system on/off)



Switches the climate control system on and off. The indicator light turns on while the function is operating.

## Fully Automatic Climate Control System (Front)

### Windshield defroster switch



Switches the windshield defroster on (indicator light turned on) and off (indicator light turned off). Use to defrost the windshield and side windows.

The fresh air mode (↔) is automatically selected, and the air conditioner automatically turns on when the windshield defroster is operating.

### **! WARNING**

**Do not lower the airflow temperature when defrosting the windshield.**

Otherwise, the outer side of the windshield will frost causing reduced visibility which may lead to an accident.

### **NOTE**

- For faster defrosting, do any of the following operations.
  - Operate the fan switch and increase the airflow amount.
  - Press the temperature setting switch to increase the airflow temperature.
- Be careful that the windows do not fog up when doing any of the following operations.

- Switch to recirculate mode.
- Turn off the air conditioner.

## Fully Automatic Climate Control System (Rear)

---

### Air Vents

The location and the direction airflow exits the air vents changes depending on the air vent adjustment.

### How to Use the Air Vents

#### Air vent open/close

Move the dial fully in the fully open or fully closed direction.

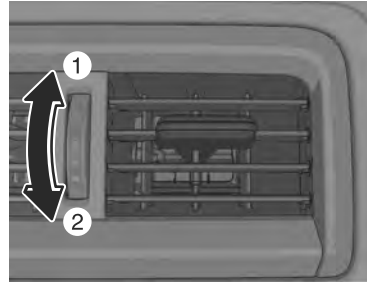

1. Open
2. Close

#### Airflow direction adjustment

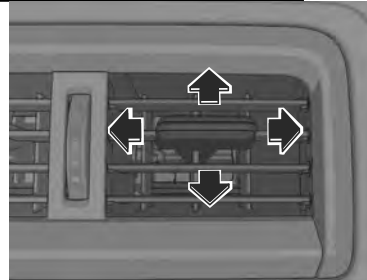

# Fully Automatic Climate Control System (Rear)

## Airflow selection Center Console Vents



## Center Console and Floor Vents



## Floor Vents



## Fully Automatic Climate Control System

The following functions are automatically controlled according to the set temperature.

- Airflow temperature control
- Airflow amount control
- Airflow mode switching

### NOTE

To prevent cold airflow immediately after heating starts when the engine is cold, the airflow amount is decreased.

## Fully Automatic Climate Control System (Rear)

### Fully Automatic Climate Control System Overview

#### Front

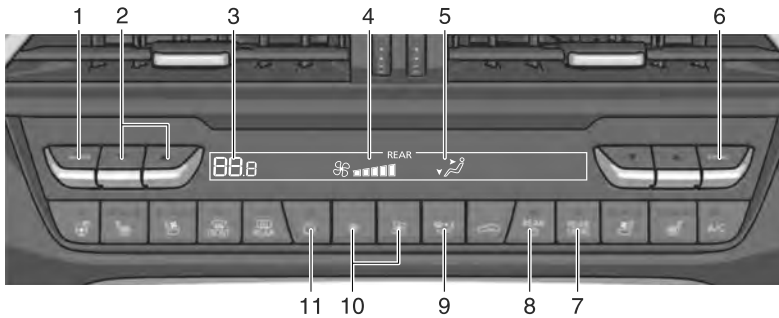

1. AUTO switch
2. Driver's side temperature setting switch
3. Temperature setting display
4. Airflow display
5. Mode selector display
6. SYNC (synchronized temperature) switch
7. Rear control switch
8. Rear climate control system power switch (system on/off)
9. Mode selector switch
10. Fan control switch
11. Climate control system power switch

#### Rear

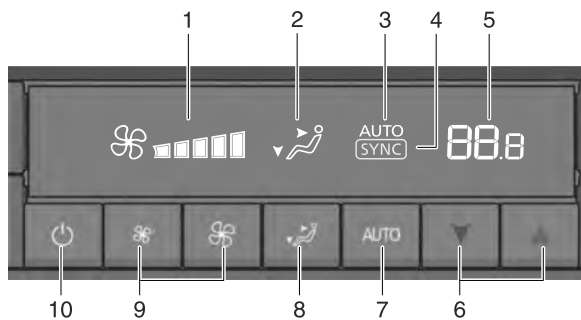

1. Airflow display
2. Mode selector display
3. AUTO display
4. SYNC (synchronized temperature) display
5. Temperature setting display
6. Temperature setting switch

## Fully Automatic Climate Control System (Rear)

---

7. AUTO switch
8. Mode selector switch
9. Fan control switch
10. Climate control system power switch



## Fully Automatic Climate Control System (Rear)

### How to Use the Fully Automatic Climate Control System

#### (Operation from front seats)

1. Start the engine.
2. Turn the front climate control system on.
- 3.

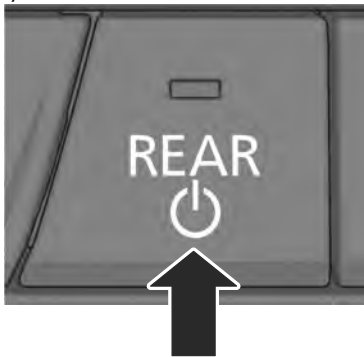

The indicator light turns on.

#### NOTE

When the rear climate control system is turned on using the Rear climate control system power switch, each setting is the setting before the rear climate control system was turned off.

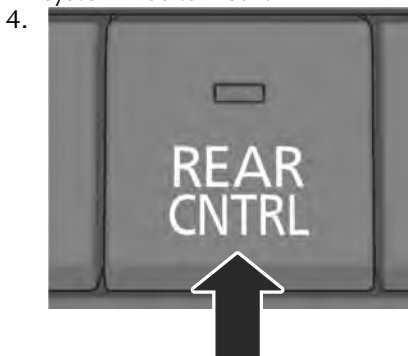

The indicator light turns on and the screen changes to the rear climate control system operation screen.



5. Press the temperature setting switch to set the desired temperature. Each function is automatically controlled according to the set temperature.

#### NOTE

- The following switches cannot be operated while the rear climate control system operation screen is displayed.

- Air intake selector switch
- Front passenger's side temperature setting switch
- A/C switch

- If none of the following switches are operated, the screen returns to the front climate control system operation screen after 10 seconds.

- AUTO switch
- Driver's side temperature setting switch
- SYNC (synchronized temperature) switch
- Mode selector switch
- Fan control switch

6. To stop the operation, press the climate control system power switch.

# Fully Automatic Climate Control System (Rear)

## (Operation from rear seats)

1. Start the engine.
- 2.

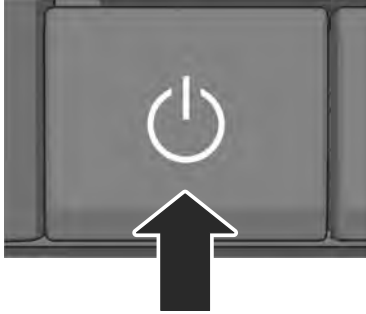

- 3.

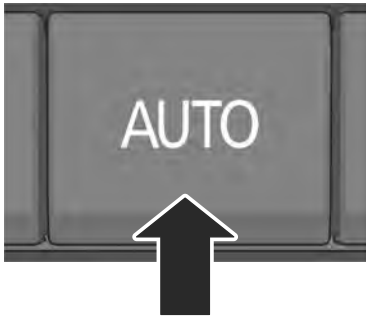

4. Press the temperature setting switch to set the desired temperature. Each function is automatically controlled according to the set temperature.

### NOTE

- The recommended set temperature is 22 °C (72 °F).
  - If mode selector switch or fan control switch is operated during auto operation, the AUTO switch indicator light turns off.
  - If the AUTO switch is pressed while the front A/C switch is off, the rear air conditioner operates only to circulate air.
5. To stop the operation, press the climate control system power switch.

## Operating Each Switch

### AUTO switch

Automatically controlled according to the set temperature.



### Temperature setting switch

How to increase the set temperature



How to decrease the set temperature



### NOTE

- The set temperature changes in increments of 0.5 °C within a range of 15 °C (60 °F) and 29 °C (84 °F).

## Fully Automatic Climate Control System (Rear)

---

- The set temperature can be quickly adjusted by pressing and holding the temperature setting switch.
- When the temperature is set to the lower or upper limit, "Lo" or "Hi" is displayed.

### Mode selector switch



The desired airflow mode can be selected. The mode changes each time the switch is pressed. The selected mode is indicated on the display.

### Fan control switch

#### How to increase the airflow amount

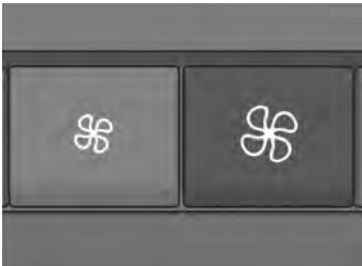

#### How to decrease the airflow amount



The airflow amount changes each time the switch is pressed. The airflow amount is indicated on the display. The airflow amount can be adjusted to 5 levels.

### Climate control system power switch (system on/off)



Switches the air conditioner on and off. The indicator light turns on while the function is operating.

## Seat Warmer\*

The seat warmer warms the seat.

## Warnings and Cautions For Using the Seat Warmer

### **WARNING**

**Be careful when using the seat warmer.**

The heat from the seat warmer may be too hot for the following people and could cause a low-temperature burn.

- Infants, small children, elderly people, and physically challenged people
- People with delicate skin
- People who are excessively fatigued
- People who are intoxicated
- People who have taken sleep-inducing medicine such as sleeping pills or cold medicine

**Do not use the seat warmer with anything having high moisture-retention ability such as a blanket or cushion on the seat.**

The seat may be heated excessively and cause a low-temperature burn.

**Do not use the seat warmer even when taking a short nap in the vehicle.**

The seat may be heated excessively and cause a low-temperature burn.

**Do not place heavy objects with sharp projections on the seat, or insert needles or pins into it.**

This could cause the seat to become excessively heated and result in injury from a minor burn.

# Seat Warmer

## **CAUTION**

➤ Do not use organic solvents to clean the seat. It may damage the seat surface and the heater.

### ➤ (rear)

Before folding a rear seatback, make sure that the rear seat warmer switch is off. If a rear seatback is folded while the rear seat warmer is in operation, it may heat the seat excessively and damage the seat surface.

## How to Use the Seat Warmer

1. Start the engine.
2. **Front**

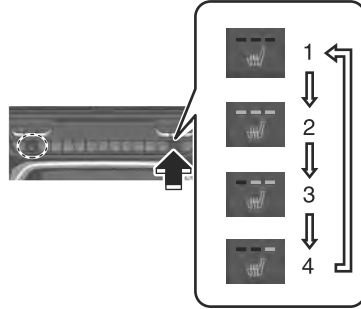

1. OFF
2. High
3. Mid
4. Low

### **Rear**

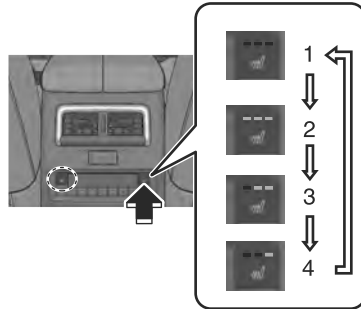

1. OFF
2. High
3. Mid
4. Low

The indicator light in the seat warmer switch turns on according to the set temperature.

The set temperature changes each time the seat warmer switch is pressed.

**NOTE**

If the engine is stopped while the seat warmer is operating in manual mode, the seat warmer does not turn on automatically the next time the engine is started. To turn the seat warmer on, press the switch again. In addition, the rear seat warmer operation stops automatically after the seat warmers have operated for a certain period of time.

**Convenient Ways to Use the Seat Warmer**

The seat temperature for front seat can be automatically controlled (auto mode) at 4 levels (High, Mid, Low, OFF) according to the conditions in the cabin.

The seat warmer can be operated in conjunction with auto mode for the climate control system.



1. Turn on the "Occupant Comfort"  
Refer to Mazda Connect Owner's Manual or consult an Authorized Mazda Dealer.
2. Press the AUTO switch for the climate control system.

**NOTE**

- If the front passenger's seat belt is unfastened, the front passenger's seat warmer turns off.
- If any of the following switch operations is performed during auto mode or the auto operation of the climate control system is canceled, the seat warmer switches from auto mode to manual mode.
  - Seat warmer switch is pressed
  - Seat ventilation switch is pressed

When the seat warmer switch/seat ventilation switch is pressed, only the seat on the side where the switch was pressed switches to manual mode.

To return to auto operation, press the AUTO switch for the climate control system.

- While operating in auto mode, the  (with heated steering wheel)/  
 (without heated steering wheel) is displayed.

## Heated Steering Wheel\*

The grips on the left and right of the steering wheel can be warmed up.

## Warnings and cautions For Using the Heated Steering Wheel

### **WARNING**

**The following types of persons should be careful not to touch the steering wheel. Otherwise, it could cause a low-temperature burn.**

- Infants, small children, elderly people, and physically challenged people
- People with delicate skin
- People who are excessively fatigued
- People who are intoxicated
- People who have taken sleep-inducing medicine such as sleeping pills or cold medicine

## How to Use Heated Steering Wheel

### Using the Heated Steering Wheel

1. Start the engine.
- 2.

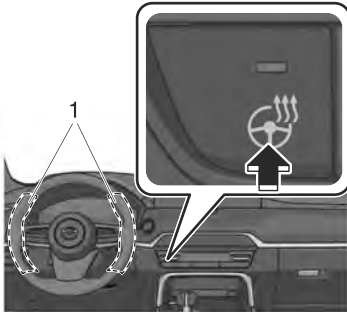

1. Heating area  
The indicator light in the heated steering wheel switch turns on.

### **NOTE**

The heated steering wheel operates for a certain period of time and then stops automatically.

### Turning Off the Heated Steering Wheel

Press the heated steering wheel switch. The heated steering wheel stops and the indicator light in the switch turns off.

## Convenient Ways to Use Heated Steering Wheel

The steering warmer can be automatically (auto mode) turned on/off depending on the conditions in the cabin.

The steering warmer can be operated in conjunction with auto mode for the climate control system.

1. Turn on the "Occupant Comfort"  
Refer to Mazda Connect Owner's Manual or consult an Authorized Mazda Dealer.
2. Press the AUTO switch for the climate control system.

### **NOTE**

- If the heated steering wheel switch is pressed during auto mode or the auto operation of the climate control system is canceled, the heated steering wheel switches from auto mode to manual mode.  
To return to auto operation, press the AUTO switch for the climate control system.
- If the vehicle power is switched OFF while the heated steering wheel is operating in auto mode, the heated steering wheel operates in auto mode again the next time the vehicle power is switched ON.



## Seat Ventilation

---

### Seat Ventilation\*

The seat ventilation uses the fans installed on the seats to draw air around the seat surface and ventilate them.

### Warnings and cautions For Using the Seat Ventilation

 **CAUTION**

- Do not use organic solvents to clean the seat. It may damage the seat surface and the seat ventilation parts.
- Do not place heavy objects with sharp projections on the seat, or insert needles or pins into it.

## How to Use the Seat Ventilation

1. Start the engine.
- 2.

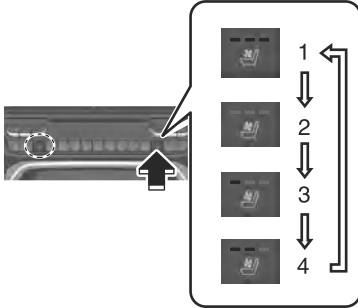

1. OFF
2. High
3. Mid
4. Low

While the seat ventilation is operating, the indicator light in the seat ventilation switch turns on according to the set mode.

### NOTE

If the engine is stopped while the seat ventilation is operating in manual mode, the seat ventilation does not turn on automatically the next time the engine is started. To turn the seat ventilation on, press the switch again.

## Convenient Ways to Use the Seat Ventilation

The fan operation for front seat is automatically controlled at 4 levels (High, Mid, Low, and OFF) according to the conditions in the cabin. The seat ventilation can be operated in conjunction with auto mode for the climate control system.



1. Turn on the "Occupant Comfort" Refer to Mazda Connect Owner's Manual or consult an Authorized Mazda Dealer.
2. Press the AUTO switch for the climate control system.

### NOTE

- If the front passenger's seat belt is unfastened, the front passenger's seat ventilation turns off.
- If any of the following switch operations is performed during auto mode or the auto operation of the climate control system is canceled, the seat ventilation switches from auto mode to manual mode.
  - Seat warmer switch is pressed
  - Seat ventilation switch is pressed

When the seat warmer switch/seat ventilation switch is pressed, only the seat on the side where the switch was pressed switches to manual mode.

To return to auto operation, press the AUTO switch for the climate control system.

- While operating in auto mode, the  (with heated steering wheel)/  (without heated steering wheel) is displayed.

### Driver Personalization System\*

On select vehicle packages, the Driver Personalization System allows you to create a Driver Profile that automatically adjusts your vehicle's settings to your personal preferences. For example, the Driver Profile allows you to save and adjust your seat and mirror settings to your preferences and allows other drivers of your vehicle who create a profile to do the same.

If you elect to create a driver profile in the Driver Personalization System, the camera in your vehicle scans features of your face and converts them into numeric information (a "**Driver Profile**"). Your Driver Profile is secured, locally stored on your vehicle only, and is not subject to remote access. When this feature is enabled, the camera will automatically check the numeric information of the driver and if a match is found, the vehicle adjusts the driver vehicle settings to that saved Driver Profile. This is a convenience feature and you can adjust vehicle settings manually instead of using the Driver Personalization System.

The following 2 functions may be included in the Driver Personalization System depending on the vehicle package selected.

#### Ideal Driving Position Assist\*

Driving Position Assist is a feature that can suggest ideal driving position settings. If you enable Driving Position Assist, you will be asked to enter your height and the camera in your vehicle will automatically detect the center of your face to determine the position of your head. The vehicle then uses this

information to adjust the position of your seat, steering wheel, Active Driving Display, and outer mirrors, so you are in a better position for driving. No personal information is stored related to this feature unless you choose to create a Driver Profile as detailed above; if you create a Driver Profile your ideal driving position settings will be stored with your Driver Profile. This is a convenience feature and you can adjust vehicle settings manually instead of using Driving Position Assist.

#### Entry/Exit Assist\*

This function automatically moves the seat back and the steering wheel up so that the driver can easily enter and exit the vehicle.

## Warnings and Cautions For Using the Driver Personalization System

### **CAUTION**

Do not allow a hand, fingers, or feet to come close the area under or around the seat or steering wheel when the seat or steering wheel is automatically moving by the driver personalization system. Otherwise, your hand, fingers, or feet could be injured.

### **NOTE**

For additional information see the Driver Monitoring Camera section of this manual on page 5-137.

## How to Use the Driver Personalization System

### **NOTE**

- The Driver Personalization System uses the driver monitoring camera to convert the driver's facial features into numerical information. The driver monitoring camera does not store or share images, audio, or video.
- In the following cases, the driver may not be registered or recognized correctly.
  - You are wearing sunglasses, a mask, or other accessories.
  - There is an obstruction between your face and the camera.
- Looking forward or at the Mazda Connect screen will facilitate driver recognition.
- If the vehicle power is switched ON during recognition, the driver will be recognized as a guest. If the vehicle power is switched ON without opening/closing the door even once, the information of the previously recognized driver is taken over.
- If the recognition is difficult, reprogram the data. Two types of faces can be programmed, such as when wearing glasses or contact lenses.
- If people with similar faces are programmed, they may be recognized incorrectly.  
Refer to Driver Monitoring Camera on page 5-137

### **Programming**

1. Switch the vehicle power ON.
2. Select "Settings" from the Mazda Connect home screen.

## Driver Personalization System

---

3. Select "Driver Personalization System".
4. Select "Add New Driver". Operate according to the Mazda Connect screen.

### NOTE

When the door is closed and "Add New Driver" is displayed on the Mazda Connect home screen, follow the instructions on the screen.

5. **(Vehicles with Ideal Driving Position Assist)**  
Program the driver's height according to the Mazda Connect screen.  
The following items are automatically adjusted.

- Driver's seat position (Angle, forward and back positions, entire height, front end height)
- Active driving display (Display height)
- Outer mirror angle
- Steering wheel position (forward and back positions, height)

### NOTE

- Under the following conditions, the Ideal Driving Position Assist is canceled.
  - The switch is operated due to the position adjustment of the driver's seat, the steering wheel, the outer mirrors, or the active driving display.
  - The key lock button or unlock button is operated.
  - The vehicle moves.
  - The selector lever is shifted to a position other than P.

- When the seat operates, a load of a certain amount or more is detected and the safety function operates.

6. Follow the Mazda Connect screen to complete the programming.

### System Operation

#### **When Entering the Vehicle**

Sit in the driver' seat and close the door.

Matching of the driver's information with the programmed information begins.

The recognition result is displayed on the screen.

If a confirmation message is displayed on the Mazda Connect screen, follow the message to complete the operation.

The various driver's settings that have been programmed are automatically restored.

### NOTE

- If the outer mirror angles are adjusted close to the limits of their range of motion, the outer mirror angles may not be restored correctly.
- When the adjustment to the stored driving position has been completed, a sound is not activated.
- Under the following conditions, the driving position adjustment is canceled automatically.
  - The switch is operated due to the position adjustment of the driver's seat, the steering wheel, the outer mirrors, or the active driving display.
  - The key lock button or unlock button is operated.
  - The vehicle moves.
  - The selector lever is shifted to a position other than P.

- When the seat operates, a load of a certain amount or more is detected and the safety function operates.

### **When Exiting the Vehicle**

Unfasten the seat belt and switch the vehicle power OFF.

The climate control setting status and the personalization features are stored at the time the vehicle power is switched OFF.

#### **(Vehicles with Entry/Exit Assist)**

The seat and the steering wheel move when all of the following conditions are met.

- The vehicle is in a programmed driving position or in a position where the vehicle was driven for a certain period of time after adjusting the driving position.
- The vehicle power is switched OFF.
- The driver's seat belt is unfastened.

### **NOTE**

- The climate control setting status and the personalization features are also stored when the drivers are switched or when another programmed driver is selected.
- The climate control system operates at the current setting without restoring the stored values if any of the following conditions occurs.
  - The windshield defrosting was operating.
  - The ambient temperature is significantly different from the previous time of entering the vehicle.
  - A certain number of days have passed since the previous time of entering the vehicle.

- If the driver's seat belt is unfastened about 40 seconds after the vehicle power is switched OFF, the Entry/Exit Assist may not operate.
- The Entry/Exit Assist may not operate depending on the position of the seat and the steering wheel.
- The amount of seat movement and the seat and the steering wheel movement on/off can be changed. Refer to Settings section in the Mazda Connect Owner's Manual or consult an Authorized Mazda Dealer.
- In the following cases, the Entry/Exit Assist is canceled.
  - A switch is operated due to the position adjustment of the driver's seat, steering wheel, or outer mirrors.
  - The key lock button or unlock button is operated.
  - When the seat operates, a load of a certain amount or more is detected and the safety function operates.

### **Editing and Deleting the Programming Content**

Switch the vehicle power ON.  
Select "Settings" from the Mazda Connect home screen.  
Select "Driver Personalization System".  
Select "Edit Driver Profile" or "Delete Driver".  
Operate according to the Mazda Connect screen.

### **Setting the System to Inoperable**

This can be set by operating Mazda Connect.  
Set in the Mazda Connect "Settings" or consult an Authorized Mazda Dealer.

# MEMO

# 7

## Other Equipment

<b>Mazda Connect.....</b>	<b>7-4</b>
Mazda Connect.....	7-4
Warnings and Cautions for Using the Mazda Connect.....	7-6
Mazda Connect Overview .....	7-7
How to Use the Mazda Connect.....	7-8
Connected Service (If applicable).....	7-13
Appendix.....	7-15
<b>Alexa.....</b>	<b>7-22</b>
Alexa* .....	7-22
Warning and Cautions for Using Alexa.....	7-22
How to Use Alexa.....	7-23
<b>Private eCall.....</b>	<b>7-25</b>
Private eCall* .....	7-25
Warnings and Cautions for Using Private eCall.....	7-25
How to Use Private eCall.....	7-26
<b>Storage Compartments.....</b>	<b>7-27</b>
Warning and Cautions for Using the Storage Compartments .....	7-27
<b>Cup Holders.....</b>	<b>7-28</b>
Warnings and Cautions for Using the Cup Holders.....	7-28
Cup Holders.....	7-28
<b>Bottle Holder.....</b>	<b>7-29</b>
Warnings and Cautions for Using the Bottle Holder.....	7-29
How to Use the Bottle Holder.....	7-29
<b>Glove Compartment.....</b>	<b>7-30</b>
How to Use the Glove Compartment.....	7-30
<b>Center Console.....</b>	<b>7-31</b>
How to Use the Center Console.....	7-31
<b>Overhead Console.....</b>	<b>7-32</b>
How to Use the Overhead Console* .....	7-32
<b>Rear Coat Hooks.....</b>	<b>7-33</b>
Warning and Cautions for Using the Rear Coat Hooks.....	7-33
How to Use the Rear Coat Hooks.....	7-33
<b>Shopping Bag Hook.....</b>	<b>7-34</b>
Warnings and Cautions for Using the Shopping Bag Hook.....	7-34
How to Use the Shopping Bag Hook.....	7-34
<b>Luggage Compartment.....</b>	<b>7-35</b>
Luggage Compartment.....	7-35
How to Use the Luggage Compartment.....	7-35



<b>Sunvisor.....</b>	<b>7-36</b>
How to Use the Sunvisor.....	7-36
<b>Vanity Mirror.....</b>	<b>7-37</b>
How to Use the Vanity	
Mirrors.....	7-37
<b>Rear Door Sunshade.....</b>	<b>7-38</b>
Warnings and Cautions When	
Using the Rear Door	
Sunshade.....	7-38
How to Use the Rear Door	
Sunshade.....	7-38
<b>Interior Lights.....</b>	<b>7-39</b>
Illuminated Entry System.....	7-39
How to Use the Illuminated Entry	
System.....	7-39
How to Use the Overhead	
Lights.....	7-40
How to Use the Map Lights.....	
.....	7-41
How to Use the Door Courtesy	
Lights*.....	7-42
How to Use the Luggage	
Compartment Lights.....	7-42
How to Use the Ambient	
Lights.....	7-43
<b>Accessory Sockets.....</b>	<b>7-44</b>
Accessory Sockets.....	7-44
Warnings and Cautions When	
Using the Accessory Socket.....	
.....	7-44
How to Use the Accessory	
Socket.....	7-45
AC Power Outlet*.....	7-45

Warnings and Cautions When	
Using the AC Power Outlet.....	
.....	7-46
How to Use the AC Power	
Outlet.....	7-47
USB Power Outlet.....	7-48
Warnings and Cautions When	
Using the USB Power	
Outlet.....	7-48
How to Use the USB Power	
Outlet.....	7-49

<b>Wireless Charger (Qi).....</b>	<b>7-50</b>
Wireless Charger (Qi)*.....	7-50
Warnings and Cautions When	
Using the Wireless Charger	
(Qi).....	7-50
How to Use the Wireless Charger	
(Qi).....	7-52
Convenient Ways to Use the	
Wireless Charger (Qi).....	7-53

<b>Assist Grip.....</b>	<b>7-54</b>
Warnings and Cautions When	
Using the Assist Grips.....	7-54
How to Use the Assist	
Grips.....	7-54

<b>Luggage compartment cover.....</b>	<b>7-55</b>
Luggage Compartment	
Cover.....	7-55
Warnings and Cautions for Using	
the Luggage compartment	
cover.....	7-55
How to Use the Luggage	
Compartment Cover.....	7-56

<b>Towing (U.S.A. and Canada).....</b>	<b>7-57</b>
Towing.....	7-57

---

Warnings and Cautions for Using the Towing.....	7-58
How to Use the Towing.....	7-60
<b>HomeLink Wireless Control System.....</b>	<b>7-65</b>
HomeLink Wireless Control System* .....	7-65
Warning and Cautions for Using the HomeLink Wireless Control System.....	7-65
How to Use the HomeLink Wireless Control System.....	7-66
<b>Accessories.....</b>	<b>7-70</b>
Warnings and Cautions For Using the Accessories.....	7-70
<b>Floor Mat.....</b>	<b>7-71</b>
Warnings and Cautions For Using the Floor Mat.....	7-71
<b>Malfunction Diagnosis Connector.....</b>	<b>7-72</b>
Malfunction Diagnosis Connector.....	7-72
<b>Spare Tire and Tool Storage.....</b>	<b>7-73</b>
Jack.....	7-73
Spare Tire.....	7-74

## Mazda Connect

Mazda Connect is a system that allows users to use various functions such as displaying vehicle information, playing music, connecting to mobile devices and changing vehicle settings.

### Mazda Connect home screen



This manual only indicates a part of the information for Mazda Connect. For detailed user information, refer to the Mazda Connect Owner's Manual.

### Mazda Connect functions

Mazda Connect has the following 8 functions.

#### **Information**

Information stored in the vehicle can be checked.

#### **Entertainment**

You can listen to radio and music.

#### **Notifications**

Notifications from the vehicle can be checked. If a serious problem occurs, the background of the notification display turns amber or red.

#### **Communication**

By connecting your mobile device, such as a Smartphone, to Mazda Connect via Bluetooth®, you can use the hands-free call and short message functions.

#### **Navigation/Compass**

If a navigation system SD card is inserted, you can use the navigation system. If the navigation system SD card is not inserted, a compass indicating the direction the vehicle is moving is displayed.

#### **Settings**

You can change the settings for the Mazda Connect and the vehicle functions.

#### **Apple CarPlay™**

By connecting an iPhone® compatible with Apple CarPlay™, you can use Apple CarPlay™.

### **Android Auto™**

By connecting an Android™ Smartphone compatible with Android Auto™, you can use Android Auto™.

#### **NOTE**

- The explanation of functions described in this manual may differ from the actual operation, and the shapes of screens and buttons and the letters and characters displayed may also differ from the actual appearance. Additionally, depending on future software updates, the content is subject to change without notice.
- Using a cellular phone or CB radio in or near the vehicle could cause noise.

## Warnings and Cautions for Using the Mazda Connect

### **WARNING**

**Always adjust Mazda Connect while the vehicle is stopped:**

Do not adjust Mazda Connect with the Commander switch while driving the vehicle. Adjusting Mazda Connect with the Commander switch while driving the vehicle is dangerous as it could distract your attention from the vehicle operation which could lead to a serious accident.

Even if the audio remote control switches are equipped on the steering wheel, learn to use the switches without looking down at them so that you can keep your maximum attention on the road while driving the vehicle.

**Do not allow the connection plug cord to get tangled with the selector lever:**

Allowing the plug cord to become tangled with the selector lever is dangerous as it could interfere with driving, resulting in an accident.

**Do not adjust a mobile device or a similar product while driving the vehicle:**

Adjusting a mobile device or a similar product while driving the vehicle is dangerous as it could distract your attention from the vehicle operation which could lead to a serious accident. Always adjust a mobile device or a similar product while the vehicle is stopped.

### **CAUTION**

For the purposes of safe driving, adjust the audio volume to a level that allows you to hear sounds outside of the vehicle including car horns and particularly emergency vehicle sirens.

## Mazda Connect Overview

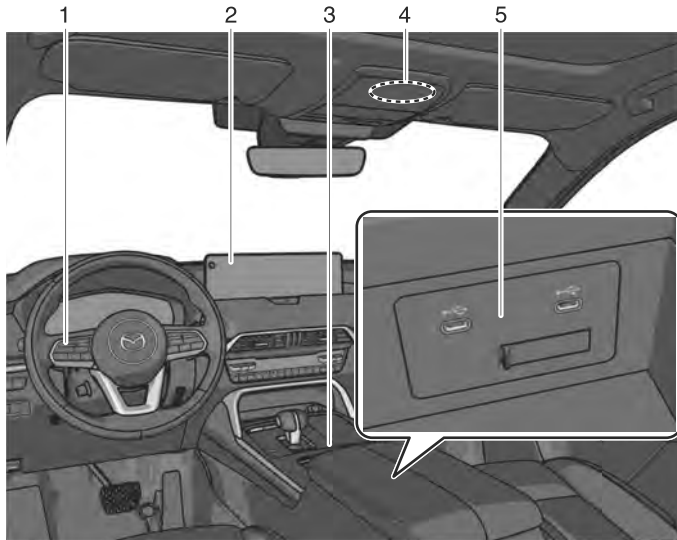

1. Audio remote control switch
2. Center display
3. Commander switch
4. Microphone
5. USB port/SD card slot\*<sup>1</sup>\*

<sup>1</sup> SD card slot for the navigation system.  
Insert an SD card (Mazda genuine) for the navigation system.



## How to Use the Mazda Connect





### Mazda Connect operation method

You can operate Mazda Connect when the vehicle power is switched to ACC or ON. There are 4 ways to operate Mazda Connect.

#### Commander switch operation



Buttons		Explanation
	Volume knob	<p><b>Adjusting the volume</b></p> <ul style="list-style-type: none"> <li>• You can adjust the volume by turning the volume knob.</li> <li>• Press and release the volume knob immediately to mute the audio. Press and release the volume knob immediately again to cancel the mute.</li> </ul> <p><b>Switching radio stations/music</b></p> <ul style="list-style-type: none"> <li>• You can switch between radio stations and audio tracks by sliding the volume knob left or right.</li> </ul> <p><b>Selecting a radio station automatically</b></p> <ul style="list-style-type: none"> <li>• Slide and hold the volume knob to start automatic radio station selection. Automatic radio station selection stops when a broadcast is received.</li> </ul> <p><b>Turning the power off/on</b></p> <ul style="list-style-type: none"> <li>• You can turn off Mazda Connect by pressing and holding the volume knob. You can turn on Mazda Connect by pressing the volume knob again.</li> </ul>
	Entertainment button	Press the entertainment button to display the most recently played audio source screen.

Buttons		Explanation
	Commander knob	<p><b>Operating the cursor</b></p> <ul style="list-style-type: none"> <li>You can move the cursor on the screen by turning or sliding the commander knob.</li> </ul> <p><b>Selection</b></p> <ul style="list-style-type: none"> <li>Press the commander knob to select the function the cursor is hovering over.</li> </ul>
	Map button	Press the map button to display the navigation/compass screen.
	Back button	Press the back button to display the previous screen.
	Home button	<p><b>Displaying the home screen</b></p> <ul style="list-style-type: none"> <li>Press and release the home button immediately to display the Home screen.</li> </ul> <p><b>Switching between screens</b></p> <ul style="list-style-type: none"> <li>Press and hold the Home button to switch between the Apple CarPlay™/Android Auto™ screen and the Mazda Connect screen.</li> </ul>
	Favorites button	<p><b>Displaying the favorites screen</b></p> <ul style="list-style-type: none"> <li>Press and release the favorites button immediately to display the favorites screen.</li> </ul> <p><b>Programming favorites</b></p> <ul style="list-style-type: none"> <li>Press and hold the favorites button to save the currently displayed contact, broadcast station, navigation point, and others as favorites.</li> </ul>

**Audio remote control switch operation**

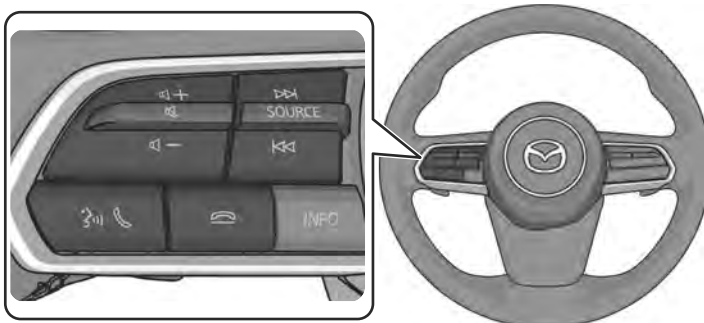





Buttons		Explanation
 	Volume adjustment button	You can adjust the volume by pressing the volume adjustment button.
	Mute button	<p><b>Mute</b></p> <ul style="list-style-type: none"> <li>• Press the mute button to mute the audio.</li> <li>• Press the mute button again to cancel the mute.</li> </ul> <p><b>Pausing the audio</b></p> <ul style="list-style-type: none"> <li>• Pressing the mute button while playing an audio source that can be paused will pause the audio source.</li> </ul>
 	Seek button	Press the seek button to switch between radio stations and audio tracks. (Except SiriusXM <sup>®</sup> )
SOURCE	SOURCE button	<p><b>Switching audio sources</b></p> <ul style="list-style-type: none"> <li>• The audio source switches each time you press the SOURCE button.</li> </ul> <p><b>Turning off the audio</b></p> <ul style="list-style-type: none"> <li>• You can turn off the audio during playback by pressing and holding the SOURCE button.</li> </ul>
	Talk/pick-up button <sup>*1</sup>	You can answer an incoming call by pressing the button while on another call.
	Hang-up button <sup>*1</sup>	<p><b>Hanging up a call</b></p> <ul style="list-style-type: none"> <li>• You can hang up a call by pressing the hang-up button during the call.</li> </ul> <p><b>Putting a call on hold</b></p> <ul style="list-style-type: none"> <li>• Press the hang-up button during a call to put the call on hold.</li> </ul>

<sup>\*1</sup> You can also use the voice recognition for the talk, pick-up/hang-up button.

## Operating the voice recognition function



Buttons		Explanation
	Talk/pick-up button	<p><b>Activating the voice recognition</b></p> <ul style="list-style-type: none"> <li>Press the talk/pick-up button to activate voice recognition. In addition, the top screen of the voice recognition is displayed.</li> </ul> <p><b>Ending the voice recognition</b></p> <ul style="list-style-type: none"> <li>Press and hold the talk/pick-up button to end the voice recognition.</li> </ul> <p><b>Skipping the voice guidance</b></p> <ul style="list-style-type: none"> <li>Press the talk/pick-up button while the voice guidance is playing to skip the voice guidance.</li> </ul>
	Hang-up button	Press the hang-up button to end the speech recognition.

Examples of effective voice commands in various categories are displayed on the voice recognition top screen.

Anything that is not a valid voice command is not recognized by the system.

### NOTE

- Some voice commands may not be available depending on the vehicle specifications and the mobile device connection status.
- While Apple CarPlay™ or Android Auto™ is connected, press and hold the talk/pick-up button to activate Siri or Android Auto™ voice recognition without activating the Mazda Connect voice recognition/Alexa\*.
- Voice commands can be spoken and operated even while voice guidance is playing (Barge-In function). However, voice commands may not be recognized correctly if the guidance volume is set to a high volume. Refer to the Mazda Connect Owner's Manual for details on the Barge-In setting method.
- To prevent mistaken voice recognition, be aware of the following points.

\*Some models.

- Do not speak more slowly than necessary. Speak at a normal speed.
- Speaking in a slightly louder voice will improve voice recognition, but an excessively loud voice is unnecessary. Try to speak in a slightly louder voice than when talking to other passengers in the vehicle.
- Speak clearly, without pausing between words or numbers.
- It is not necessary to orient oneself in the direction of the microphone or approach the microphone. Speak the voice commands while maintaining your driving posture.
- Voice commands may not be recognized correctly due to external noise or air turbulence in the car.
- When calling a person in the mobile device's phone book, the recognition rate increases the longer the name is. Errors may occur with names that are short such as (Mama), (Home), or (wife).

## **Center display operation\***

Only Apple CarPlay™ or Android Auto™ can be operated by touching the center display.

## **Turning Mazda Connect off/on**

### **Turning off**

Press and hold the volume knob to turn off the Mazda Connect power.

### **Turning on**

There are 2 ways to turn Mazda Connect ON.

- Press the volume knob.
- Press the commander knob.

## Connected Service (If applicable)

### Connected Service Overview (U.S.A.)

There are several types of connected services available via Mazda Connect. Some services may require you to download the MyMazda app to your smartphone and subscribe to the services, while others may require you to pair your smartphone to the vehicle via Bluetooth®. In addition, on a regular basis and unless you opt-out, your vehicle will automatically transmit certain geo-location, driving behavior data, and vehicle health information to Mazda for product quality, data analysis, research, and product development. Using the QR codes or URLs below, refer to the Connected Service Owner's Manual and Privacy Policy for more details and opt-out options.

- Connected Service Owner's Manual

<https://www.mazdausa.com/static/manuals/mazda-connected-service/index.html>



### Connected Service Overview (Canada)

If your vehicle is equipped for connected services, there may be several types of connected services available to you. The availability, terms and capability of connected services vary by vehicle and other factors. Some services may require you to download the MyMazda app to your compatible smartphone, purchase a subscription or be in a supported area with wireless coverage, while others may require you to pair your smartphone to the vehicle via Bluetooth®. If your vehicle is equipped for connected services, certain data may be collected and transmitted through the connected vehicle system, including, without limitation, geo-location, driving behaviour data and vehicle health information. Please refer to connected services terms and privacy policy available on the Mazda Canada website for more details.

Connected Services owner's manual:

<https://www.mazda.ca/en/digital-owners-manual/2021/connected-services/>



**(U.S.A. and Canada)**

**Privacy Policy**

Mazda maintains a Privacy Statement which describes how we collect, use, share, store and secure data from your vehicle equipped with connected services.

We provide you with connected services by collecting and using your personal information and vehicle location, health and driving data.

To learn more about our Privacy Statement, please visit:

**(U.S.A.)**

<https://www.mazdausa.com/site/privacy-connectedservices>



**(Canada)**

<https://www.mazda.ca/en/cv-privacy/>



## Appendix

### Gracenote® Database

When connecting a USB audio device or Bluetooth® audio device to this unit and playing audio, the unit searches the database stored in the vehicle for the album art. If there is a match in the vehicle's database compilation to the music being played, the album art is displayed. The database information stored in this device uses database information in the Gracenote® music recognitions service.

### SiriusXM® Satellite Radio\*



Products/applications shall display "Call [Appropriate Phone Number] to Enable Services" for any unsubscribed SiriusXM Data Service(s).

This shall be shown on the same screen as the Radio ID and the service subscription status:

Contact your SiriusXM Representative for the appropriate call center phone number.

- U.S.A.: 1-877-447-0011
- Canada: 1-877-438-9677

### SiriusXM® All Access Subscription

Hopefully, you're already loving SiriusXM in your new Mazda. But don't stop there — you can also listen on the app and online. All Access is the very best subscription package — with the most channels and the most flexibility. With All Access, you get every channel available on your vehicle, plus you can listen on the app, online, and in your home on a variety of connected devices. — so you can enjoy SiriusXM wherever you are. Here's what's included:

- Over 150 satellite channels to enjoy in your car, coast-to-coast, 24/7.
- All kinds of commercial-free music, plus every major sport, world-class news and the biggest names in talk & entertainment.
- All of our premium programming, including Howard Stern, every NFL, MLB®, and NBA game, NHL® games, every NASCAR® race, 24/7 talk channels dedicated to the biggest leagues, and much more.

All SiriusXM services require a subscription, sold separately or as a package by SiriusXM Radio Inc. (or, in Canada, SiriusXM Canada Inc.), after any trial subscription which may be included with your vehicle purchase or lease. To subscribe after your trial subscription, call 1-877-447-0011 (U.S.A.) or 1-877-438-9677 (Canada).

 **CAUTION**

It is prohibited to copy, decompile, disassemble, reverse engineer, hack, manipulate, or otherwise make available any technology or software incorporated in receivers compatible with the SiriusXM satellite radio service or that support the SiriusXM website, the online service or any of its content. Furthermore, the AMBE® voice compression software included in this product is protected by intellectual property rights including patent rights, copyrights, and trade secrets of Digital Voice Systems, Inc. The SiriusXM Service may include traffic, weather and other content and emergency alert information and data. Such information and data is not for “safety for life”, but is merely supplemental and advisory in nature and, therefore, cannot be relied upon as safety critical. Neither SiriusXM nor Mazda is responsible for any errors in accuracies in the SiriusXM data services or its use in applications. The SiriusXM content is subject to change without notice.

**NOTE**

SiriusXM Satellite Radio Service is available in the 48 contiguous United States and the District of Columbia. The service is not available in Alaska, Hawaii or Puerto Rico.

**HD Radio™\***

**What is HD Radio™ Technology and how does it work?**

HD Radio™ Technology is the digital evolution of analog AM/FM radio. Your radio product has a special receiver which allows it to receive digital broadcasts (where available) in addition to the analog broadcasts it already receives. Digital broadcasts have better sound quality than analog broadcasts as digital broadcasts provide free, crystal clear audio. For more information, and a guide to available radio stations and programming, please visit [www.hdradio.com](http://www.hdradio.com).

**Benefits of HD Radio™ Technology**

**(Information)**

The song title, artist name, album name will appear on the screen when available by the radio station.

**(Multicast)**

On the FM radio frequency most digital stations have “multiple” or supplemental programs on each FM station. HD Radio Technology manufactured under license from iBiquity Digital Corporation. U.S. and Foreign Patents. For patents see <http://dts.com/patents>.

## Apple CarPlay™



- YOU EXPRESSLY ACKNOWLEDGE AND AGREE THAT USE OF APPLE CARPLAY™ (“THE APPLICATION”) IS AT YOUR SOLE RISK AND THAT THE ENTIRE RISK AS TO SATISFACTORY QUALITY, PERFORMANCE, ACCURACY AND EFFORT IS WITH YOU TO THE MAXIMUM EXTENT PERMITTED BY APPLICABLE LAW, AND THAT THE APPLICATION AND INFORMATION ON THE APPLICATION IS PROVIDED “AS IS” AND “AS AVAILABLE”, WITH ALL FAULTS AND WITHOUT WARRANTY OF ANY KIND, AND MAZDA HEREBY DISCLAIMS ALL WARRANTIES AND CONDITIONS WITH RESPECT TO THE APPLICATION AND INFORMATION ON THE APPLICATION, EITHER EXPRESS, IMPLIED OR STATUTORY, INCLUDING, BUT NOT LIMITED TO, THE IMPLIED WARRANTIES AND/OR CONDITIONS OF MERCHANTABILITY, SATISFACTORY QUALITY, FITNESS FOR A PARTICULAR PURPOSE, ACCURACY, QUIET ENJOYMENT, AND NONINFRINGEMENT OF THIRD PARTY RIGHTS.
- AS EXAMPLES, AND WITHOUT LIMITATION, MAZDA DISCLAIMS ANY WARRANTY REGARDING THE ACCURACY OF DATA PROVIDED BY THE APPLICATION, SUCH AS THE ACCURACY OF DIRECTIONS, ESTIMATED TRAVEL TIME, SPEED LIMITS, ROAD CONDITIONS, NEWS, WEATHER, TRAFFIC, OR OTHER CONTENT PROVIDED BY APPLE, ITS AFFILIATES, OR THIRD PARTY PROVIDERS; MAZDA DOES NOT GUARANTEE AGAINST LOSS OF APPLICATION DATA, WHICH MAY BE LOST AT ANY TIME; MAZDA DOES NOT GUARANTEE THAT THE APPLICATION OR ANY SERVICES PROVIDED THROUGH THEM WILL BE PROVIDED AT ALL TIMES OR THAT ANY OR ALL SERVICES WILL BE AVAILABLE AT ANY PARTICULAR TIME OR LOCATION. FOR EXAMPLE, SERVICES MAY BE SUSPENDED OR INTERRUPTED WITHOUT NOTICE FOR REPAIR, MAINTENANCE, SECURITY FIXES, UPDATES, ETC., SERVICES MAY BE UNAVAILABLE IN YOUR AREA OR LOCATION, ETC.
- IN ADDITION, YOU UNDERSTAND THAT CHANGES IN THIRD PARTY TECHNOLOGY OR GOVERNMENT REGULATION MAY RENDER THE SERVICES AND/OR APPLICATIONS OBSOLETE AND/OR UNUSABLE. TO THE EXTENT NOT PROHIBITED BY LAW, IN NO EVENT SHALL MAZDA OR ITS AFFILIATES BE LIABLE FOR PERSONAL INJURY, OR ANY INCIDENTAL, SPECIAL, INDIRECT OR CONSEQUENTIAL DAMAGES WHATSOEVER, INCLUDING, WITHOUT LIMITATION, DAMAGES FOR LOSS OF PROFITS, CORRUPTION OR LOSS OF DATA, FAILURE TO TRANSMIT OR RECEIVE ANY DATA, BUSINESS INTERRUPTION OR ANY OTHER COMMERCIAL DAMAGES OR LOSSES, ARISING OUT OF OR RELATED TO THE APPLICATION OR YOUR USE OF OR INABILITY TO USE THE APPLICATION OR INFORMATION ON THE APPLICATION.
- When using Apple CarPlay™, please avoid distraction and use Apple CarPlay™ responsibly.  
Stay fully aware of driving conditions and always obey applicable laws.



## NOTE

- Apple CarPlay™ is provided by Apple® and its use is subject to your agreement to the Apple CarPlay™ terms of use, which are included as part of the Apple iOS terms of use.
- When using Apple CarPlay™, location, speed, and other vehicle data is transferred to your iPhone®. For further details, refer to Apple®'s Privacy Policy.

## Android Auto™



- YOU EXPRESSLY ACKNOWLEDGE AND AGREE THAT USE OF ANDROID AUTO™ (“THE APPLICATION”) IS AT YOUR SOLE RISK AND THAT THE ENTIRE RISK AS TO SATISFACTORY QUALITY, PERFORMANCE, ACCURACY AND EFFORT IS WITH YOU TO THE MAXIMUM EXTENT PERMITTED BY APPLICABLE LAW, AND THAT THE APPLICATION AND INFORMATION ON THE APPLICATION IS PROVIDED “AS IS” AND “AS AVAILABLE,” WITH ALL FAULTS AND WITHOUT WARRANTY OF ANY KIND, AND MAZDA HEREBY DISCLAIMS ALL WARRANTIES AND CONDITIONS WITH RESPECT TO THE APPLICATION AND INFORMATION ON THE APPLICATION, EITHER EXPRESS, IMPLIED OR STATUTORY, INCLUDING, BUT NOT LIMITED TO, THE IMPLIED WARRANTIES AND/OR CONDITIONS OF MERCHANTABILITY, SATISFACTORY QUALITY, FITNESS FOR A PARTICULAR PURPOSE, ACCURACY, QUIET ENJOYMENT, AND NONINFRINGEMENT OF THIRD PARTY RIGHTS.

AS EXAMPLES, AND WITHOUT LIMITATION, MAZDA DISCLAIMS ANY WARRANTY REGARDING THE ACCURACY OF DATA PROVIDED BY THE APPLICATION, SUCH AS THE ACCURACY OF DIRECTIONS, ESTIMATED TRAVEL TIME, SPEED LIMITS, ROAD CONDITIONS, NEWS, WEATHER, TRAFFIC, OR OTHER CONTENT PROVIDED BY GOOGLE, ITS AFFILIATES, OR THIRD PARTY PROVIDERS; MAZDA DOES NOT GUARANTEE AGAINST LOSS OF APPLICATION DATA, WHICH MAY BE LOST AT ANY TIME; MAZDA DOES NOT GUARANTEE THAT THE APPLICATION OR ANY SERVICES PROVIDED THROUGH THEM WILL BE PROVIDED AT ALL TIMES OR THAT ANY OR ALL SERVICES WILL BE AVAILABLE AT ANY PARTICULAR TIME OR LOCATION. FOR EXAMPLE, SERVICES MAY BE SUSPENDED OR INTERRUPTED WITHOUT NOTICE FOR REPAIR, MAINTENANCE, SECURITY FIXES, UPDATES, ETC., SERVICES MAY BE UNAVAILABLE IN YOUR AREA OR LOCATION, ETC.

IN ADDITION, YOU UNDERSTAND THAT CHANGES IN THIRD PARTY TECHNOLOGY OR GOVERNMENT REGULATION MAY RENDER THE SERVICES AND/OR APPLICATIONS OBSOLETE AND/OR UNUSABLE. TO THE EXTENT NOT PROHIBITED BY LAW, IN NO EVENT SHALL MAZDA OR ITS AFFILIATES BE LIABLE FOR PERSONAL INJURY, OR ANY INCIDENTAL, SPECIAL, INDIRECT OR CONSEQUENTIAL DAMAGES WHATSOEVER, INCLUDING, WITHOUT LIMITATION, DAMAGES FOR LOSS OF PROFITS, CORRUPTION OR LOSS OF DATA, FAILURE TO TRANSMIT OR RECEIVE ANY DATA, BUSINESS INTERRUPTION OR ANY OTHER COMMERCIAL DAMAGES OR LOSSES, ARISING OUT OF OR RELATED TO THE APPLICATION OR YOUR USE OF OR INABILITY TO USE THE APPLICATION OR INFORMATION ON THE APPLICATION.

- When using Android Auto™, please avoid distraction and use Android Auto™ responsibly.  
Stay fully aware of driving conditions and always obey applicable laws.

#### NOTE

- Android Auto™ is provided by Google and its use is subject to your agreement to the Android Auto™ terms of use.
- When using Android Auto™, location, speed, and other vehicle data is transferred to your smart phone. For further details, refer to Google Privacy Policy.

#### Trademark

- HD Radio Technology manufactured under license from iBiquity Digital Corporation. U.S. and Foreign Patents. For patents see <http://dts.com/patents>. HD Radio, Artist Experience, and the HD, HD Radio, and "ARC" logos are registered trademarks or trademarks of iBiquity Digital Corporation in the United States and/or other countries.



- iPhone, iPod touch, iPod nano, Siri and Lightning are trademarks of Apple Inc., registered in the U.S. and other countries.
- Apple CarPlay is a trademark of Apple Inc.
- Use of the Apple CarPlay logo means that a vehicle user interface meets Apple performance standards. Apple is not responsible for the operation of this vehicle or its compliance with safety and regulatory standards. Please note that the use of this product with iPhone, iPod may affect wireless performance.
- iOS is a trademark or registered trademark of Cisco in the U.S. and other countries and is used under license.
- "Made for iPhone" and "Made for iPod" mean that an accessory has been designed to connect specifically to iPhone or iPod, and has been certified by the developer to meet Apple performance standards. Apple is not responsible for the operation of this device or its compliance with safety and regulatory standards.

Please note that the use of this accessory with iPhone or iPod may affect wireless performance.

Made for

iPhone 12 Pro Max

iPhone 12 Pro

iPhone 12

iPhone 12 mini

iPhone SE (2nd generation)

iPhone 11 Pro Max

iPhone 11 Pro

iPhone 11

iPhone XS Max

iPhone XS

iPhone XR

iPhone X

iPhone 8 Plus

iPhone 8

iPhone 7 Plus

iPhone 7

iPhone SE

iPhone 6s Plus

iPhone 6s

iPhone 6 Plus

iPhone 6

iPhone 5s

iPod touch (7th Generation)

iPod touch (6th Generation)



- Google, Android, Android Auto and other related marks are trademarks of Google LLC.
- AudioPilot is a registered trademark of Bose Corporation.
- Centerpoint is a registered trademark of Bose Corporation.
- This product is protected by certain intellectual property rights of Microsoft. Use or distribution of such technology outside of this product is prohibited without a license from Microsoft.
- This product is licensed under the MPEG-4 patent portfolio license, AVC patent portfolio license and VC-1 patent portfolio license for the personal use of a consumer or other uses in which it does not receive remuneration to (i) encode video in compliance with the MPEG-4 Visual Standard, AVC Standard and VC-1

Standard (“MPEG-4/AVC/VC-1 Video”) and (ii) decode MPEG-4/AVC/VC-1 Video that was encoded by a consumer engaged in a personal activity and/or was obtained from a video provider licensed to provide MPEG-4/AVC/VC-1 Video. No license is granted or shall be implied for any other use. Additional information may be obtained from MPEG LA, L.L.C. See <http://www.mpegla.com>.

- The Bluetooth® word mark and logos are registered trademarks owned by Bluetooth SIG, Inc. and any use of such marks by Panasonic Corporation is under license. Other trademarks and trade names are those of their respective owners.



- SDHC Logo is a trademark of SD-3C, LLC.



- Gracenote, the Gracenote logo and logotype, “Powered by Gracenote” and Gracenote MusicID are either registered trademarks or trademarks of Gracenote, Inc. in the United States and/or other countries.



- Amazon, Alexa, Echo, and all related marks are trademarks of Amazon.com, Inc. or its affiliates.

## Alexa

---

### Alexa\*

Talking to Alexa can be done in the vehicle. Alexa is hands-free and easy to use, allowing the user to control vehicle functions with verbal commands while maintaining the driving posture.

Alexa voice recognition can operate the vehicle's air conditioning, navigation, hands-free telephone, audio functions, and the heated seats, among others.

In addition, Alexa's various functions (such as weather information, news functions, shopping, and Smart Home\*1) can be used.\*2

\*1 Certain Alexa functionality is dependent on Smart Home technology.

\*2 Availability of Alexa Built-in depends on the country.

Alexa service is provided by Amazon and is subject to Amazon's Terms and Conditions and Privacy Policy. Mazda does not have access to your Amazon account.

### Warning and Cautions for Using Alexa

#### CAUTION

When you are signed into your Amazon account, Alexa can be used by any other driver or passenger of your vehicle. To avoid unauthorized use of Alexa and your Amazon account, please sign out from your Amazon account when lending, renting, or selling your vehicle to another person. You may also perform a factory reset to sign out of your Amazon account.

## How to Use Alexa

### Before using Alexa

- To use Alexa, communication between the vehicle and Amazon Cloud is required. Enable either one of the following functions. In order for Alexa to play streaming music, communication with the Wi-Fi client function is required.

- Connected Service function\*<sup>1</sup>
- Wi-Fi client function\*<sup>2</sup>

- <sup>1</sup> Refer to the Connected Service owner's manual.
- <sup>2</sup> Set the communication with the Wi-Fi client function using the following procedure.
1. Select "Settings" from the Mazda Connect home screen.
  2. Select "Connectivity Settings".
  3. Select "Wi-Fi Client Settings".
  4. Make sure that "Wi-Fi Client Mode" is enabled.
  5. A Wi-Fi connection can be made with the device to be used from "Search for Available Wi-Fi Networks" or "Wi-Fi Protected Setup (WPS)".

The Wi-Fi client function communicates using the customer's mobile device, therefore communication fees are borne by the customer. If the Wi-Fi client function is enabled, the only connection method for Apple CarPlay™ or Android Auto™ is a USB connection.

- Set your Mazda Connect "Home Region" using the following procedure.
1. Select "Settings" from the Mazda Connect home screen.
  2. Select "System Settings".
  3. Select "Home Region".
  4. Select the country and region.

- Sign into your Amazon account using the following procedure.
1. Select "Settings" from the Mazda Connect home screen.
  2. Select "Alexa Settings".
  3. Select "Sign In".
  4. Follow the Mazda Connect screen to sign in.

### **NOTE**

- When Alexa is playing streaming music, noise may occur or music may be interrupted due to signal reception conditions or other factors.
- After removing or installing the lead-acid battery, Alexa is unavailable until the GPS signal is received. Move the vehicle to a location where the GPS signal can be received.

### When using Alexa

There are two ways to use Alexa.

- Say, "Alexa".\*<sup>1</sup>
- Press the talk/pick-up button.\*<sup>2</sup>

<sup>1</sup> Can be used when Alexa Hands-Free is enabled on "Alexa Settings" in Mazda Connect.

<sup>2</sup> Can be used when Push-to-talk is enabled on "Alexa Settings" in Mazda Connect.

The main functions that can be controlled by Alexa are as follows. Examples of these and other functions can also be confirmed on Mazda Connect.

- Air conditioner on/off
- Airflow temperature control
- Airflow amount control
- Airflow mode switching
- Recirculate/fresh air mode switching
- Defroster on/off

## Alexa

---

- Seat warmer on/off
- Seat ventilation on/off
- Steering warmer on/off
- Navigation destination setting and canceling
- Hands-free telephone

### **When confirming examples of Alexa features**

1. Select "Settings" from the Mazda Connect home screen.
2. Select "Alexa Settings".
3. Select "Things to Try".

### **When signing out of your Amazon account**

1. Select "Sign Out" from the "Alexa Settings" menu screen.
2. Follow the Mazda Connect screen to sign out.

## Private eCall\*

### Private eCall

If the vehicle is involved in a collision that deploys the airbags or when the SOS button is pressed, an emergency vehicle can be arranged through Private eCall center.

### **CAUTION**

To operate Private eCall, a contract with Connected Service is required. For details, check the Connected Service owner's manual.

## Warnings and Cautions for Using Private eCall

### **WARNING**

**When using Connected Service, if an occupant has an implanted-type heart pacemaker or defibrillator, keep the medical device about 22 cm (8.7 in) or farther away from the vehicle's antenna.**

If these medical devices come near the antenna, the operation of the medical device might be affected by radio waves.





## How to Use Private eCall

For details, check the Connected Service owner's manual.

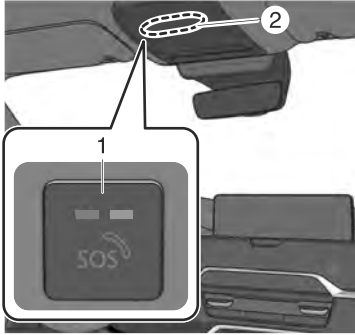

1. Emergency call switch
2. Microphone, Speaker

## Warning and Cautions for Using the Storage Compartments

### **WARNING**

**When loading cargo, make sure that it is completely secured.**

If the cargo is not completely secured, it may move or collapse while driving or during sudden braking, resulting in injury or an accident.

### **CAUTION**

- Always close the covers for storage such as the glove compartment when the vehicle is being driven. Open storage boxes and their contents may cause injury during sudden braking or if the vehicle is involved in a collision.
- Be careful when storing items in uncovered storage spaces. If an item is ejected from the storage space during sudden braking, maneuvering, or acceleration it could lead to an accident.
- Do not leave lighters or eyeglasses in the storage boxes while parked under the sun. A lighter could explode or the plastic material in eyeglasses could deform and crack from high temperature.

## Warnings and Cautions for Using the Cup Holders

### **WARNING**

**Never use a cup holder to hold hot liquids while the vehicle is moving.** Using a cup holder to hold hot liquids while the vehicle is moving is dangerous. If the contents spill, you could be scalded.

**Do not put anything other than cups or drink cans in cup holders.**

Putting objects other than cups or drink cans in a cup holder is dangerous.

During sudden braking or maneuvering, occupants could be hit and injured, or objects could be thrown around the vehicle, causing interference with the driver and the possibility of an accident. Only use a cup holder for cups or drink cans.

## Cup Holders

Cup holders are installed to the following positions.

### Front

#### Type A

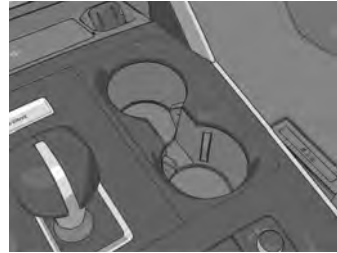

#### Type B

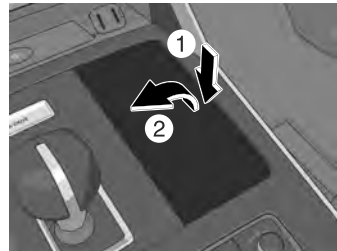

### Rear



## Warnings and Cautions for Using the Bottle Holder

### CAUTION

Do not use the bottle holders for containers without caps. The contents may spill when opening/closing the door or while driving the vehicle.

## How to Use the Bottle Holder

Plastic bottles can be placed in the bottle holders.

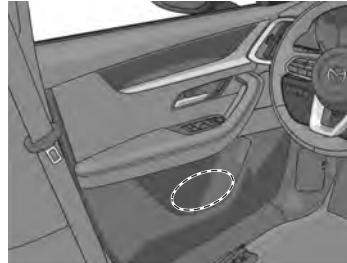

## Glove Compartment

---

### How to Use the Glove Compartment

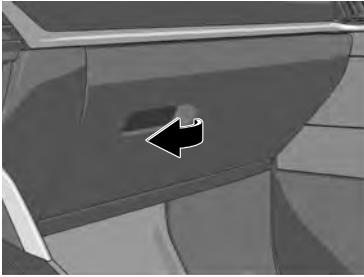

## How to Use the Center Console

### Open

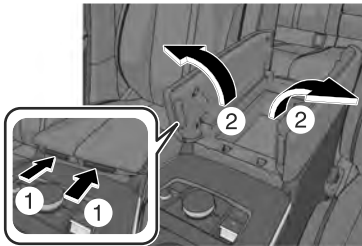

### Close

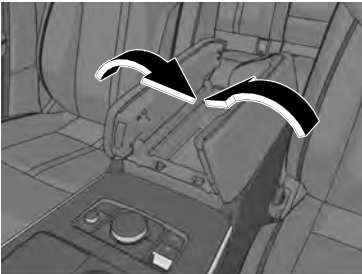

## How to Use the Overhead Console\*

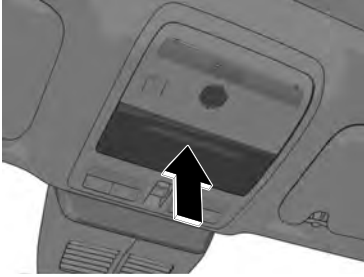

## Warning and Cautions for Using the Rear Coat Hooks

### **WARNING**

**Never hang heavy or sharp objects on the assist grips and coat hooks.** Hanging heavy or sharp-ended objects such as a coat hanger from the assist grips or coat hooks is dangerous as they can fly off and hit an occupant in the cabin if a curtain air bag was to deploy, which could result in serious injury or death.

## How to Use the Rear Coat Hooks

Use the rear coat hooks when hanging a coat or jacket.





# Shopping Bag Hook

---

## Warnings and Cautions for Using the Shopping Bag Hook

**! CAUTION**

Do not hang excessive weight on the shopping bag hook as it could be damaged.

## How to Use the Shopping Bag Hook

The shopping bag hook can be used for hanging shopping bags. Maximum load 3 kg (6.6 lb)

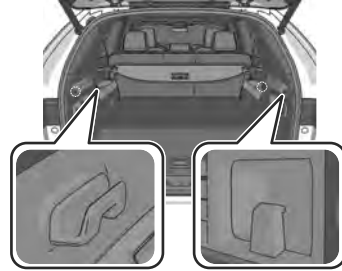

# Luggage Compartment

## Luggage Compartment

### Cargo Securing Loops

Use rope or a net to secure cargo.

### Cargo Sub-Compartment

The spaces can be used to store small items.

## How to Use the Luggage Compartment

### Cargo Securing Loops

The tension load of a luggage hook is 20 kg (44 lb). Do not tighten a rope to the anchors excessively.

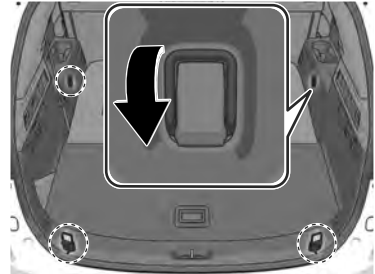

### Cargo Sub-Compartment

Open the luggage board.

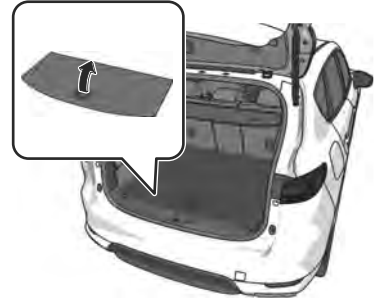

## How to Use the Sunvisor

### When blocking light from the front



### When blocking light from the side

Unhook the sunvisor and swing it to the side.

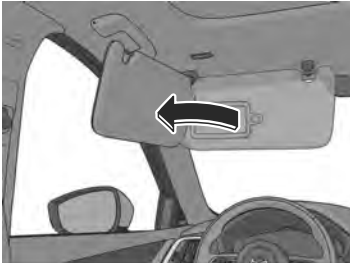

The visor extender extends the sunvisor's range of sun shading. To use, pull it out.

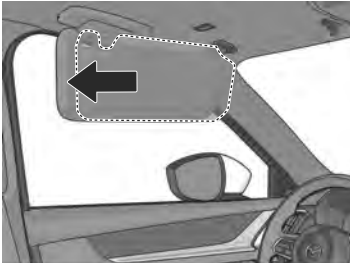

### **! CAUTION**

When moving the sunvisor, retract the visor extender to its original position. Otherwise, the visor extender could hit the rearview mirror.

## How to Use the Vanity Mirrors

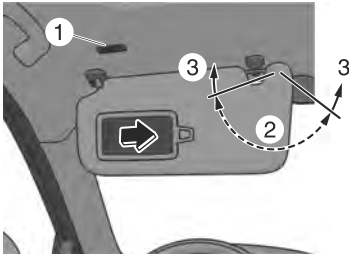

1. Vanity mirror light\*
2. Lighting range
3. Off range

For vehicles with a light, it turns on when the cover is opened. The light turns on only when the sunvisor angle is within the lighting range.

### NOTE

- If a vanity mirror light is left on with the vehicle power switched OFF, the light is turned off automatically to prevent the lead-acid battery from being discharged.
- The vanity mirror light can be turned on again by doing any of the following operations:
  - Opening/closing any door.
  - Unlocking any door.
  - Switching the vehicle power to ACC or ON.
  - Switching an overhead light/front map light on.

## Rear Door Sunshade

### Warnings and Cautions When Using the Rear Door Sunshade

#### CAUTION

- Securely hook the sunshade. Otherwise, the sunshade may retract suddenly resulting in injury such as fingers get pinched.
- Use the sunshades only when the windows are fully closed. Using a sunshade while a window is open could cause it to unhook and flap around inside the cabin where it can hit someone sitting near the window, resulting in injury.

### How to Use the Rear Door Sunshade

The sunshades are equipped to the windows on both sides of the rear seats.

Hold the tab and pull the sunshade upward and hook the slots.

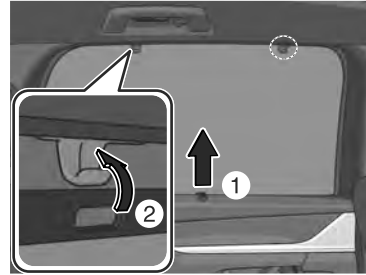

To return the sunshade to its original position, unhook the sunshade and retract it slowly.

## **Illuminated Entry System**

The interior lights turn on/off in conjunction with the opening/closing of the doors and the position of the vehicle power (ON/OFF).

## **How to Use the Illuminated Entry System**

The overhead lights turn on when any of the following operations is done with the overhead light switch in the DOOR-linked position.

- The driver's door is unlocked with the vehicle power switched OFF.
- The vehicle power is switched OFF with all doors closed.

The overhead lights turns off when any of the following operations is done.

- The driver's door is locked.
- The vehicle power is switched ON.

When the vehicle power is switched OFF and the interior lights remain on, they turn off after a certain period of time has passed.

### **NOTE**

- The amount of time until the illuminated entry system turns off can be changed.  
Refer to Mazda Connect Owner's Manual or consult an Authorized Mazda Dealer.
- The illuminated entry system does not operate when the overhead lights are turned on by operating the overhead light ON/OFF switch.

## How to Use the Overhead Lights

### Front

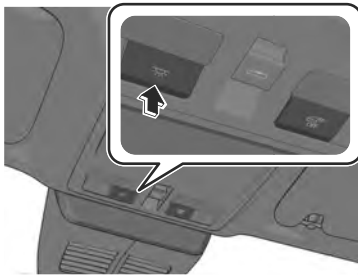

The overhead lights turn on.  
Press the  switch again to turn off the overhead lights.

### **When the door interlock is ON**

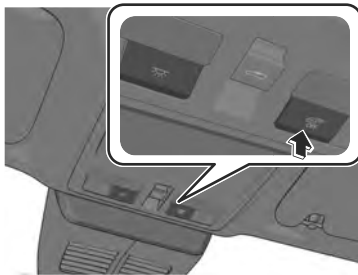

- The indicator light in the  OFF switch turns off.
- The lights turn on when any of the doors is opened.
- The light turns on/off depending on the illumination entry system.

### **When the door interlock is OFF**

The indicator light in the switch turns on.

### Rear

The rear overhead lights also turns on/off in conjunction with the operation of the front overhead lights.

### Type A



### Type B

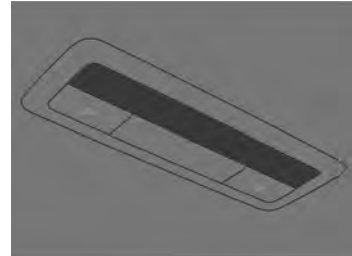

### Type C

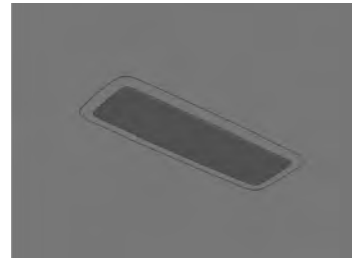

## How to Use the Map Lights

### Front

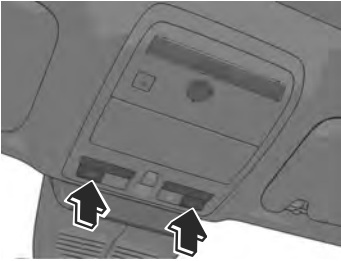

The map light turns on.  
Press the switch again to turn off the map lights.

### Rear

#### Type A



#### Type B

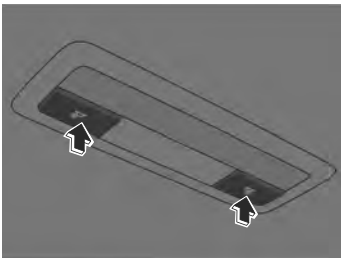

The map light turns on.  
Press the switch again to turn off the map lights.

### **NOTE**

- Pressing the switch does not turn the lights off in any of the following cases.

- When the light is turned on by operating an overhead light  switch.
- When the illuminated entry system is operating.
- **(Rear)** Once the rear map lights have been turned off, they will turn on/off in conjunction with the operation of an overhead light switch.



### How to Use the Door Courtesy Lights\*

The light turns on when any door is opened and turns off when closed.

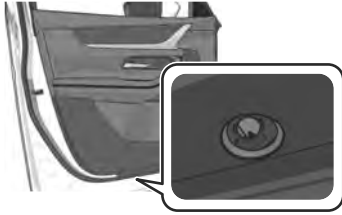

### How to Use the Luggage Compartment Lights

Open the liftgate.

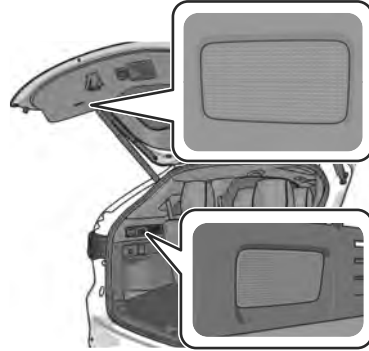

The luggage compartment lights turn on.  
When the liftgate is closed, the luggage compartment lights turn off.

## How to Use the Ambient Lights

When the vehicle power is switched ON, the ambient lights remain on. The ambient lights turn on/off in conjunction with the Illuminated Entry System in the cabin and parking lights turned on.



### NOTE

- The light turns on/off depending on the illumination entry system when the vehicle power is switched OFF.
  - The intensity of the ambient lights can be changed when the parking lights are turned on.
- For the method of changing the setting, refer to the Mazda Connect owner's manual.

### Accessory Sockets

The accessory socket is used as a socket for accessories when the vehicle power is switched to ACC or ON. Only use accessories that have a maximum power consumption of 120 W (DC12V-10A) or below.

### Warnings and Cautions When Using the Accessory Socket

#### CAUTION

- Always close the cover when it is not in use. If foreign matter or liquid penetrates the socket, it may cause a problem.
- Insert the accessory plug into the socket securely. If the plug is not inserted securely, it may heat excessively and blow the fuse.
- Do not use accessories that have a power consumption of over 120 W (DC12V-10A). Otherwise, it could cause a malfunction.
- Noise may occur on the audio playback depending on the device connected to the accessory socket.
- Do not insert the cigarette lighter into the accessory socket.
- Depending on the device connected to the accessory socket, the vehicle's electrical system might be affected, which could cause the warning light to turn on. Disconnect the connected device and make sure that the problem is resolved. If the problem is resolved, switch the vehicle power OFF after the device is disconnected from the socket. If the problem is not resolved, consult an Authorized Mazda Dealer.

## How to Use the Accessory Socket

Open the lid and insert the plug to be used.

### Front



### Rear

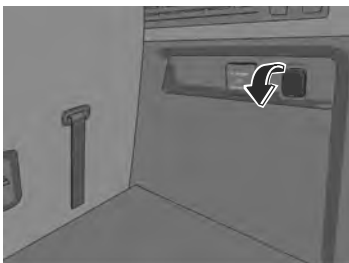

## AC Power Outlet\*

The AC power outlet can be used as a socket for accessories when the vehicle power is switched to ACC or ON. Only use AC 120 V/60 Hz accessories that have a maximum power consumption of 150 W or below.

### Warnings and Cautions When Using the AC Power Outlet

#### **WARNING**

**Never use medical instruments with the power outlet.**

Otherwise, the operation of the medical device might be affected.

**Heed the following cautions when using the AC power supply to prevent electrical shock, smoking, or combustion.**

- Be careful with the AC power outlet and plug during and after use.
- Because an electrical appliance could operate at the moment it is plugged in, check the safety before plugging it in.
- Do not plug accessories into the power outlet or unplug them with wet hands.
- Be careful not to allow liquid to penetrate the AC power outlet.
- Do not put anything other than plugs into the AC power outlet.
- Do not disassemble the AC power outlet.
- Do not use the AC power outlet if it is damaged. If part replacement or repair is required, consult an Authorized Mazda Dealer.

#### **CAUTION**

- Always close the cover when it is not in use. If foreign matter or liquid penetrates the AC power outlet, it may cause a problem.

- Insert electrical appliance plugs into the AC power outlet securely. If the plug is not inserted securely, it may heat excessively and blow a fuse.
- Do not connect multiple electrical appliances to the AC power outlet. Otherwise, it could cause smoking or combustion.
- Do not use electrical appliances that exceed the prescribed power capacity. Otherwise, it could cause a malfunction.

## How to Use the AC Power Outlet

Open the lid and insert the plug to be used.



### NOTE

- Use electrical appliances only in the cabin. If they are used outside of the vehicle cabin, they may not operate correctly due to noise.
- The following electrical appliances may not operate even if their electrical capacity is 150 W or lower.
  - Appliances requiring large amounts of power for activation (such as refrigerators with a compressor, electrical pumps, and electrical tools)
  - Appliances with a power supply frequency switch function (such as clocks and audio)
  - Appliances for precise data processing (such as measurement equipment)
- Electrical appliances other than the above may be used.
- When using an electrical appliance for data processing such as a personal computer, back up the data frequently.
- The protection function operates and the AC power outlet cannot be used in the following cases:
  - Lead-acid battery power is weak

- Appliances with a capacity of 150 W or higher are used
- Cabin temperature is extremely hot
- Noise may occur during radio operation depending on the electrical appliance being used.
- To prevent the lead-acid battery from depleting, do not use the socket for long periods with the engine stopped.

## USB Power Outlet

Only use USB devices with the following maximum power consumption.

- Type A (12 W (DC 5 V, 2.4 A)) or lower
- Type C (15 W (DC 5 V, 3 A)) or lower

## Warnings and Cautions When Using the USB Power Outlet

### CAUTION

- Insert the USB plug into the USB power supply socket securely. If the USB plug is not inserted securely, it may heat excessively and blow the fuse.
- Do not use USB devices that have a power consumption which exceeds the following. Otherwise, it could cause a malfunction.
  - Type A (12 W (DC 5 V, 2.4 A)) or lower
  - Type C (15 W (DC 5 V, 3 A)) or lower

## How to Use the USB Power Outlet

Insert the plug to be used.





## Wireless Charger (Qi)

### Wireless Charger (Qi)\*

You can charge mobile devices such as Smartphones which comply with the Qi Wireless Charging standard.

Only use mobile devices that have a maximum power consumption of 5 W, or 15 W or below.

#### Trademarks

“Qi” and the Qi symbol are trademarks or registered trademarks of the Wireless Power Consortium (WPC).



### Warnings and Cautions When Using the Wireless Charger (Qi)

#### **WARNING**

**Radio waves from the Wireless Charger (Qi) may affect the operation of medical devices such as implanted-type cardiac pacemakers or defibrillators.**

- Before using the Wireless Charger (Qi) near people who use medical devices, ask the medical device manufacturer or your physician if radio waves from the Wireless Charger (Qi) will affect the device.
- The Wireless Charger (Qi) can be disabled to prevent it from affecting medical devices. Consult an Authorized Mazda Dealer for details.

**Heed the following cautions. Otherwise, the Wireless Charger (Qi) may malfunction or be damaged, which could cause a fire, burns due to heat generation, or an accident such as electrical shock.**

- Do not install, remove, disassemble, or change the wiring of the Wireless Charger (Qi). If the Wireless Charger (Qi) needs to be installed or removed, consult an Authorized Mazda Dealer.
- Do not use the Wireless Charger (Qi) when it is malfunctioning. In addition, if smoke, abnormal noise, or abnormal smell is emitted from the Wireless Charger (Qi), stop the vehicle in a safe place, turn off the Wireless Charger (Qi), and consult an Authorized Mazda Dealer.

## Wireless Charger (Qi)

- When using the Wireless Charger (Qi) to store items on, turn off the Wireless Charger (Qi).
  - Do not place any metal object between the charging area and the mobile device. Also, do not apply items such as a metallic sticker to the Wireless Charger (Qi).
  - When charging, do not place any item other than the mobile device to be charged on the Wireless Charger (Qi). In addition, do not place any metal object, IC card, coin, or magnetic item near the charging area.
  - Remove dust or dirt from the charging area before use.
  - Do not apply strong force or impact to the Wireless Charger (Qi) or get it wet.
  - Use only mobile devices which support the Wireless Charger (Qi).
-  **CAUTION**
- While a mobile device is placed on the charging area, keep the vehicle key away from the Wireless Charger (Qi). The vehicle key may not be detected due to radio wave interference by the Wireless Charger (Qi).
  - Charging may not operate normally under the following conditions:
    - The mobile device is fully charged.
    - There is foreign matter between the mobile device and the charging area.
    - The temperature of the mobile device is high.
    - The mobile device is placed with the charging side facing upward.
    - The mobile device is placed in a position extremely deviating from the center of the charging area.
- Your vehicle is in an area where strong radio waves or electrical noise occur such as near a television tower, power plant, or airport.
  - The Near Field Communication (NFC) function setting of the mobile device is on (depends on the model of the mobile device).
  - Keep the following items away from the charging area. Otherwise the data stored on the mobile device could be erased or the device could malfunction.
    - Magnetic items such as magnets, magnetic cards, and magnetic recording media.
    - High precision devices such as wristwatches.
  - Before using the Wireless Charger (Qi), make sure to back up the data stored on the mobile device. The data on the mobile device could be deleted.
  - Do not wipe the Wireless Charger (Qi) using oil, alcohol, or thinner, or spray hairspray or insecticide onto it. Otherwise, it could cause damage or cracking.
  - Do not leave mobile devices in the cabin. The temperature inside the cabin may become very hot, causing the devices to malfunction.

# Wireless Charger (Qi)

## How to Use the Wireless Charger (Qi)

1. Start the engine.  
The power for the Wireless Charger (Qi) turns on and the LED indicator turns on.
2. Place a device compliant with the Qi Wireless Charging standard (portable device with a maximum power consumption of 5 W or 15 W or below) in the center of the charging area on the tray.



1. Charging area
2. LED indicator

The LED indicator turns on in amber or green when charging starts. Charging starts when all the doors and liftgate are closed.

For details on the LED indicator, refer to the following LED indicator table.

### Charging status display

The charging status of the Wireless Charger (Qi) can be checked with the LED indicator or the icon displayed on the center display.

Illumi-nation/flash pattern	Icon indi-cation	Status
Does not turn on	—	Indicates that charging is turned off.

Illumi-nation/flash pattern	Icon indi-cation	Status
Turns on in white		Indicates that charging is possible.
Turns on in amber		Indicates normal charging.
Turns on in green		Indicates fast charging*1.
Flashes in white		Indicates that the charging conditions are not met.
Flashes in red		Indicates that charging is not possible because a high temperature is detected.
		Indicates that charging is not possible because foreign matter is detected.
Turns on in red		Indicates that there is a problem with Wireless Charger (Qi) and it needs to be repaired. Consult an Authorized Mazda Dealer.

\*1 Some mobile devices can switch between normal charging and fast charging.

### NOTE

- Charging efficiency may be reduced or charging may not be possible depending on the use environment and conditions.

- Depending on the mobile device case or accessories used, the mobile device may not charge, or the charging efficiency may be reduced resulting in a longer charging time. If charging does not start even when a mobile device is placed on the charging area, remove the case or accessory.
- Depending on the vehicle condition, charge amount may be temporarily restricted and charging may be canceled, however, this does not indicate a problem.
- If the mobile device temperature rises during charging, charging may stop due to the protection function of the device. If that happens, wait until the mobile device cools down sufficiently and then recharge it.
- When using the Wireless Charger (Qi), applications using the Near Field Communication (NFC) function may launch, however, this does not indicate a problem with the Wireless Charger (Qi).
- While i-stop is operating, charge amount may be temporarily restricted and charging may be temporarily canceled, however, this does not indicate a problem.
- Charging may be temporarily canceled depending on the vehicle conditions, such as when the engine is stopped.

### **Convenient Ways to Use the Wireless Charger (Qi)**

The Wireless Charger (Qi) can be turned on/off and the connection mode can be switched.

Refer to the Settings section in the Mazda Connect Owner's Manual.

## Warnings and Cautions When Using the Assist Grips

### **WARNING**

**Never hang heavy or sharp objects on the assist grips and coat hooks.** Hanging heavy or sharp-ended objects such as a coat hanger from the assist grips or coat hooks is dangerous as they can fly off and hit an occupant in the cabin if a curtain air bag was to deploy, which could result in serious injury or death.

**Do not use the assist grips when getting in and out of the vehicle or getting out of a seat.** An assist grip could break under a heavy load resulting in injury.

## How to Use the Assist Grips

Use the assist grips to support your body while seated in the vehicle and while the vehicle is moving.

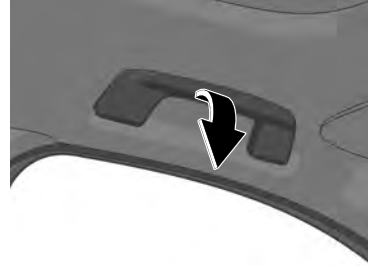

## Luggage compartment cover

---

### Luggage Compartment Cover

Use the luggage compartment cover to conceal cargo or luggage.

### Warnings and Cautions for Using the Luggage compartment cover

#### **WARNING**

**Do not place any objects or cargo on the Luggage compartment cover.**

If you leave any objects or cargo on the Luggage compartment cover, it may move during sudden braking resulting in an unexpected accident.

#### **CAUTION**

Make sure that the Luggage compartment cover is fixed securely. If the Luggage compartment cover is used without being secured, it may come off unexpectedly while the vehicle is being driven, resulting in injury.

## Luggage compartment cover

---

### How to Use the Luggage Compartment Cover

Pull out the luggage compartment cover and insert the attachment pin into the securing groove.



### To Remove the Luggage Compartment Cover

1. Open the rear door.
2. Fold down the rear seatbacks.
3. Compress either the left or right luggage compartment cover holder inwards.

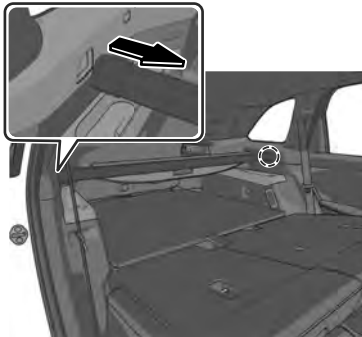

4. Pull the luggage compartment cover toward you and remove it from the installation hole.

5. Remove the luggage compartment cover from the rear doors.

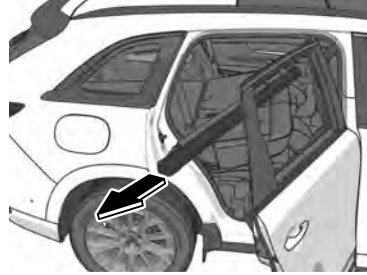

### To Install the Luggage Compartment Cover

Install in the reverse order of removal.

## Towing

Your Mazda was designed and built primarily to carry passengers and cargo.

If you tow a trailer, follow these instructions because driver and passenger safety depends on proper equipment and safe driving habits. Towing a trailer will affect handling, braking, durability, performance, and economy.

Never overload vehicle or trailer. Consult an Authorized Mazda Dealer if you need further details.

### NOTE

- Your vehicle is equipped with a Trailer Stability Control (TSC) mechanism, which enhances vehicle stability when towing a trailer. Refer to Trailer Stability Control (TSC) on page 5-97.
- When towing a trailer, do not use the following safety systems (If a Mazda genuine trailer hitch is used, these systems are automatically turned off when the trailer's electrical connector is connected):
  - Blind Spot Monitoring (BSM)
  - Rear Cross Traffic Alert (RCTA)
  - Smart Brake Support (SBS) reverse drive detection
  - Parking Sensor System (Rear)
  - Emergency Lane Keeping (ELK) Blind Spot Assist
  - Emergency Lane Keeping (ELK) Head-on traffic avoidance assist

Turn off the aforementioned safety systems when towing a trailer without a genuine Mazda trailer hitch.

- Your vehicle is equipped with a Mazda intelligent Drive Select (Mi-Drive) towing mode which enhances vehicle stability when towing a trailer. Refer to Mazda intelligent Drive Select (Mi-Drive) on page 5-103.



## Warnings and Cautions for Using the Towing

### **WARNING**

#### **Always keep tow loads within specified limits as indicated in the Trailer Towing-Load Table:**

Attempting to tow loads greater than those specified is dangerous as it may cause serious handling and performance problems that could result in personal injury or vehicle damage, or both.

#### **Load your trailer with the weight about 60 % toward the front and 40 % toward the rear:**

Loading the trailer with more weight in the rear than in the front is dangerous. Doing so could cause you to lose control. The trailer tongue load must be 10 %—15 % of the total trailer load (sum of the weights of the trailer and cargo).

#### **Always have the total trailer weight and tongue load determined prior to departure:**

Attempting to tow loads without determining the total trailer weight and tongue load is dangerous. Trailer sway from crosswinds, rough roads or other causes could result in loss of control and a serious accident.

#### **Always make sure the trailer hitch is securely attached before departure:**

An unsecured trailer hitch is dangerous as it causes greater trailer sway from crosswinds, rough roads or other causes, resulting in loss of control and a serious accident.

Examine all trailer-hitch mounting bolts regularly and tighten any that are loose. If the hitch is removed, seal any open mounting holes to prevent exhaust, dust, water, dirt and other foreign elements from filtering in, possibly endangering personal safety and damaging your vehicle.

Do not install a hitch that stiffens the bumper as it will reduce the bumper's performance.

#### **Make sure there are no exhaust gas leaks into the passenger compartment if any mounting bolts are connected to the body:**

Modifying your vehicle exhaust system is dangerous. Exhaust gas entering the vehicle could cause loss of consciousness or even death.

When mounting the trailer hitch, make no modifications to the vehicle exhaust system.

#### **Never use the temporary spare tire when towing:**

Using the temporary spare tire on your vehicle when towing a trailer is dangerous as it could result in tire failure, loss of control, and injury to vehicle occupants.

#### **Make sure the safety chain is securely attached to both the trailer and the vehicle prior to departure:**

Towing a trailer without using a safety chain securely attached to both the trailer and the vehicle is dangerous. If damage occurs to the coupling unit or hitch ball, the trailer could wander into another lane and cause a collision.

**Do not connect a hydraulic trailer-brake system to your vehicle's brake system:**

Connecting a hydraulic trailer-brake system directly to the vehicle brake system is dangerous and will result in inadequate braking and possible injury.

**Always use lower gears to reduce speed:**

Holding the brake pedal down too long or too frequently is dangerous as it could cause the brakes to overheat and lose power, resulting in loss of control and a serious accident. Use lower gears to help reduce speed. Pull off the road and allow brakes to cool down whenever braking performance feels reduced.

 **CAUTION**

- Do not tow a trailer during the first 1,000 km (600 miles) of your new Mazda. If you do, you may damage the engine, transmission, differential, wheel bearings, and other power-train components.
- Be aware of the towing load weight differences when towing at high altitudes. For altitudes exceeding 1,000 meter (3,280 ft 10 in), always reduce the towing load by 10 % for every 1,000 meter (3,280 ft 10 in) increase in altitude from the load indicated under the maximum GCWR heading in the trailer towing-load table. If the determined maximum total towing load weight is exceeded, the engine and other power-train parts may be damaged.
- The total trailer weight and tongue load can be determined by weighing the trailer on platform scales at a highway weight station or a trucking company.

- Make all hitch adjustments with actual loads. Do not load and unload vehicle while adjusting hitch. This action will change the vehicle height.
- Do not use an axle-mounted hitch. This may damage the axle and related parts.
- If the vehicle exceeds 100 km/h (62 mph) with a trailer in tow, the vehicle could be damaged.
- Do not connect a trailer lighting system directly to the lighting system of your Mazda. This may damage your vehicle's electrical system and lighting systems. Have a recreational vehicle dealer or trailer rental agency connect the system, and inspect the brake lights and turn signals yourself before each trip.



## How to Use the Towing



### NOTE

- The three main causes of vehicle-trailer accidents are driver error, excessive speed, and improper trailer loading.
- Trailer towing causes higher fuel consumption.
- The extra weight of the trailer may strain the engine on hot days and on long or steep upgrades. If the temperature gauge indicates overheating, turn off the air conditioner, drive safely to the side of the road, park off the right-of-way and wait for engine to cool.
- Verify that your Mazda maintains a near-normal level ride when a loaded or unloaded trailer is connected. Do not drive if it has an abnormal front-up or front-down position. Inspect for incorrect tongue load, worn suspension parts, and trailer overloading.
- Make sure the trailer is properly loaded and the cargo is secure to prevent it from shifting.
- Make sure the mirrors conform to all government regulations. If they do not, install required rear view mirrors appropriate for towing purposes.

### Trailer towing-load table

Because vehicle weights vary, adjustments must be made to meet the requirements in this table.  
(U.S.A. and Canada)

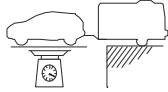
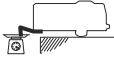
Limitation items		Limit values				
		e-SKYACTIV G (STANDARD POWER)			e-SKYACTIV G (HIGH POWER)	
		Moonroof	Panorama sunroof	Without moonroof/panorama sunroof		
MAX. TTW		2,268 kg (5,000 lb) <sup>*1</sup> or 1,588 kg (3,500 lb) <sup>*2</sup>				
MAX. GCWR		4,588 kg (10,115 lb) <sup>*1</sup> or 3,908 kg (8,615 lb) <sup>*2</sup>			4,674 kg (10,304 lb) <sup>*1</sup> or 3,994 kg (8,804 lb) <sup>*2</sup>	
MAX. GAWR		Front	1,271 kg (2,804 lb)	1,282 kg (2,826 lb)	1,266 kg (2,791 lb)	1,287 kg (2,837 lb)
		Rear	1,421 kg (3,133 lb)	1,433 kg (3,159 lb)	1,413 kg (3,115 lb)	1,445 kg (3,186 lb)

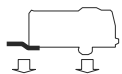
Limitation items		Limit values			
		e-SKYACTIV G (STANDARD POWER)			e-SKYACTIV G (HIGH POWER)
		Moonroof	Panorama sunroof	Without moonroof/ panorama sunroof	
<b>MAX. GVWR</b>		2,722 kg (6,001 lb)		2,728 kg (6,014 lb)	
<b>TRAILER-TONGUE LOAD</b>	Tongue load		Tongue load/Trailer load × 100 = 10 % to 15 %		
	Trailer load				
<b>DISTRIBUTION OF TRAILER LOAD</b>		Front	60 %		
		Rear	40 %		

\*1 Large towing capacity specification

\*2 Normal specification

### TTW and GCWR

The total trailer weight (TTW), gross combination weight rating (GCWR), gross axle weight rating (GAWR), trailer load, and trailer tongue load must be within the prescribed limits.

- The total trailer weight (TTW) is the sum of the weights of the trailer load (trailer weight plus cargo). Never allow the total trailer weight (TTW) to exceed specifications in the Trailer towing-load table.
- The maximum GCWR is the combination weight of the trailer and load plus the towing vehicle (including trailer hitch, vehicle passengers, and load). It must not exceed the specifications in the load table.

### GAWR and GVWR

Do not exceed front and rear GAWR (gross axle weight rating) and GVWR (gross vehicle weight rating). If you do, vehicle handling, braking, and performance will be affected. These values are also on the Motor Vehicle Safety Standard Label posted on the driver's door frame.

### Trailer frontal area table

Frontal area is the total area that a moving vehicle and trailer exposes to air resistance. Exceeding this limit may reduce the performance of your towing vehicle.

## Towing (U.S.A. and Canada)

### (U.S.A. and Canada)

Limitation items		Limit values
MAX. FRONTAL AREA		3.72 m <sup>2</sup> (40 ft <sup>2</sup> ) <sup>*1</sup> or 2.79 m <sup>2</sup> (30 ft <sup>2</sup> ) <sup>*2</sup>

\*1 Large towing capacity specification

\*2 Normal specification

### Before driving

- Have your cooling and braking system checked by an Authorized Mazda Dealer.
- Before starting out, inspect the operation of all vehicle and trailer lights and all vehicle-to-trailer connections. Stop and re-inspect all lights and connections after driving a short distance.

### Trailer hitch

Use only a hitch ball recommended by the trailer manufacturer that conforms to the gross trailer weight requirement.

When not towing a trailer, remove the trailer hitch (if detachable) to reduce the possibility of damage as a result of the vehicle being rear-ended.

### Tires

- When towing a trailer, make sure that the tire pressures of the rear tires are at 20 kPa (0.2 bar, 2.9 psi) higher than the recommended tire pressures indicated on the tire pressure chart on the driver's door frame.  
Trailer tire size, load rating, and inflation pressures should conform to tire manufacturer specifications.
- Do not exceed 100 km/h (62 mph) with a trailer in tow. If the local legal maximum speed with a trailer in tow is less than 100 km/h (62 mph), do not exceed the legal speed.

### Safety chains

Safety chains must be used as a precautionary measure should the trailer become unintentionally unhitched. They should cross under the trailer tongue and attach to the hitch. Leave enough slack to allow full turns. Consult literature published by your trailer or hitch manufacturer for more details.

### Trailer lights

Trailer lights must comply with all federal, state, and local regulations. Equip your trailer as required before towing it day or night.

### Trailer brakes

If the total trailer weight exceeds 450 kg (1,000 lb), trailer brakes are required. If your trailer has brakes, make sure they comply with all federal, state, and local regulations.

## **Driving**

- Your Mazda will handle differently with a trailer in tow, so practice turning, backing, and stopping in a traffic-free area.
- Take time to get accustomed to the extra weight and length.
- Allow more room between your vehicle and the one in front because braking distance increases with a trailer. For each 16 km/h (10 mph) of speed, allow at least one vehicle and trailer length between your Mazda and the vehicle ahead.
- Avoid jerky starts or sudden acceleration.
- Avoid sudden braking. It may cause loss of control and result in jackknifing, especially so on wet or slippery roads.
- Shift the selector lever to the D position when towing a trailer in hilly terrain or when heavily loaded.

The D position will allow operating the vehicle without frequent shifting.

## **Lane changes and turning**

Avoid quick lane changes, sudden turns, and tight turns. Slow down before turning to avoid the need of sudden braking.

A turning trailer will make a tighter arc than the tow vehicle. Compensate with turns that are larger than normal.

## **Passing**

Plan well ahead to pass other vehicles, and provide plenty of room before changing lanes. Crosswinds from passing vehicles, especially larger ones, and the effects of rough roads will affect handling.

If swaying occurs, firmly grip the steering wheel and reduce speed immediately, but gradually.

Steer straight ahead. If no extreme correction of steering or braking is made, the combination of less speed and firm steering will result in stability.

## **Backing up**

Backing a vehicle with a trailer requires practice and patience. Back slowly, and have a helper outside at the rear of the trailer to reduce the risk of an accident.

To turn the trailer, place your hand at the bottom of the steering wheel and turn it in the direction you want the trailer to go. Make only slight movements to prevent sharp or prolonged turning.

## **Ascending a hill**

Shift into a lower gear to reduce the possibility of overloading or overheating the engine, or both.

## **Descending a hill**

Shift into a lower gear and use engine compression as a braking effect.

## Towing (U.S.A. and Canada)

---

### **Parking**

Always make sure the tires of the trailer and the tow vehicle are blocked while parked.

Apply the parking brake firmly and put the transmission in P.

**Avoid parking on an incline, but if you must, follow these instructions:**

1. Depress and hold down the brake pedal.
2. Have a helper put wheel blocks against the downhill side of all vehicle and trailer tires.
3. Then release the brake pedal slowly until the blocks bear the load.
  - If the grade is downhill, turn the steering wheel so that the front of the front tires face the curb.
  - If it is uphill, face the rear of the front tires against the curb.
4. Firmly apply the parking brake.
5. Shift the transmission into P, and stop the engine.

**To restart after parking on an incline:**

1. With the transmission in P, start the engine. (Be sure to depress and hold the brake pedal.)
2. Shift into gear.
3. Release the parking brake (also the foot brake) and pull away from the wheel blocks. Stop; apply the parking brake and shift into P.
4. Have a helper retrieve the wheel blocks.

### **Maintenance**

If you tow a trailer frequently, have your vehicle serviced as shown in Scheduled Maintenance (page 9-6).

### **Recreational Towing**

An example of "recreational towing" is towing your vehicle behind a motorhome. The transmission is not designed for towing this vehicle on all 4 wheels.

When doing recreational towing refer to "Having the Vehicle Towed" (page 8-5) and "Using the Towing Hooks" (page 8-6) and carefully follow the instructions.

# HomeLink Wireless Control System

## HomeLink Wireless Control System\*

The HomeLink system replaces up to 3 hand-held transmitters with a single built-in component in the auto-dimming mirror. Pressing the HomeLink button on the auto-dimming mirror activates garage doors, gates and other devices surrounding your home.

### NOTE

HomeLink and HomeLink house are registered trademarks of Gentex Corporation.

## Warning and Cautions for Using the HomeLink Wireless Control System

### WARNING

**Do not use the HomeLink system with any garage door opener that lacks the safety stop and reverse feature.**

Using the HomeLink system with any garage door opener that lacks the safety stop and reverse feature as required by federal safety standards is dangerous. (This includes garage doors manufactured before April 1, 1982.) Using these garage door openers can increase the risk of serious injury or death. For further information, contact **HomeLink** at [www.homelink.com](http://www.homelink.com) or [www.youtube.com/HomelinkGentex](http://www.youtube.com/HomelinkGentex) or an Authorized Mazda Dealer.

**Always check the areas surrounding garage doors and gates for people or obstructions before programming or during operation of the HomeLink system.**

Programming or operating the HomeLink system without verifying the safety of areas surrounding garage doors and gates is dangerous and could result in an unexpected accident and serious injury if someone were to be hit.



## How to Use the HomeLink Wireless Control System

### Programming the HomeLink System

The HomeLink system provides 3 buttons which can be individually selected and programmed using the transmitters for current, on-market devices as follows:

1. Verify that there is a remote control transmitter available for the device you would like to program.

#### **NOTE**

It is recommended that a new battery be placed in the hand-held transmitter of the device being programmed to HomeLink for quicker training and accurate transmission of the radio-frequency signal.

2. Press and release the HomeLink button you would like to program. The indicator light flashes slowly in amber when the button is pressed.

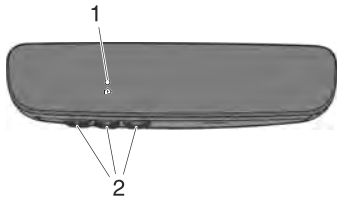

1. Indicator light
2. HomeLink button
3. Hold the hand-held transmitter 3 to 7 cm (1.2 to 2.7 in) away from the HomeLink button you would like to program while keeping the indicator light in view.

#### **NOTE**

Depending on the hand-held transmitter, it may be easier to do the programming by holding it about 20 cm (7.9 in) away from the HomeLink button.

4. Press the hand-held transmitter button continuously until the indicator light changes from amber (flashing) to green (on/flashing).

#### **NOTE**

Some gate operators and garage door openers may require you to replace this Programming Step 4 with procedures noted in the "Gate Operator/Canadian Programming" section.

5. Press the HomeLink button again to check if the programming has been completed.

If the indicator light remains on in green, the programming is complete and the device becomes operational.

If the indicator light flashes rapidly in green, firmly press and hold the HomeLink button and release it after two seconds have passed.

Repeat this process up to three times to complete the programming. The device becomes operational and programming is complete. If the device does not operate, go to the next step.

6. At the garage door opener receiver (motor-head unit) in the garage, locate the "learn" or "smart" button. This can usually be found where the hanging antenna wire is attached to the motor-head unit.
7. Firmly press and release the "learn" or "smart" button. (The name and color of the button may vary by manufacturer.)

# HomeLink Wireless Control System

## NOTE

Complete the programming within 30 seconds.

8. Return to the vehicle and firmly press and hold the HomeLink button, and then release it after two seconds have passed. Repeat the “press/hold/release” sequence a second time, and, depending on the brand of the garage door opener (or other rolling code equipped device), repeat this sequence a third time to complete the programming process. Press the programmed HomeLink button and make sure that the HomeLink System operates. If the status indicator arrows are flashing, refer to Programming two-way communication.

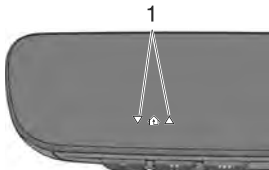

### 1. Indicator light

For questions or comments, please contact HomeLink at [www.homelink.com](http://www.homelink.com) or [www.youtube.com/HomeLinkGentex](http://www.youtube.com/HomeLinkGentex), or the HomeLink toll-free hotline at 1-800-355-3515 (for calls placed outside of the USA, Canada, and Puerto Rico, international rates will apply and may differ based on landline or mobile phone).

## Gate operator/Canadian Programming

Canadian radio-frequency laws require transmitter signals to “time-out” (or quit) after several seconds of transmission — which may not be long

enough for HomeLink to pick up the signal during programming. Similar to this Canadian law, some U.S. gate operators are designed to “time-out” in the same manner.

If you live in Canada or are having difficulties programming a gate operator by using the programming procedures (regardless of where you live), replace Step 4 of Programming the HomeLink System with the following:

## NOTE

If programming a garage door opener or gate operator, it is advised to unplug the device during the “cycling” process to prevent possible overheating.

While the indicator light is flashing in amber, press the button on the hand-held transmitter for 2 seconds and release it repeatedly until the indicator light changes from amber to green.

Go back to Step 5 of Programming the HomeLink System to complete the procedure.

## Operating the HomeLink System

Press the programmed HomeLink button to operate a programmed device.

## Reprogramming the HomeLink system

To program a device to HomeLink using a HomeLink button previously trained, follow these steps:

1. Press and hold the desired HomeLink button. Do not release the button.
2. After 20 seconds, the indicator light flashes in amber. After the indicator light flashes, release the HomeLink button.

# HomeLink Wireless Control System

3. Go back to Step 3 of Programming the HomeLink System to complete the procedure.

**NOTE**

If the programming has not been completed, the system returns to the previous programming.

**Programming two-way communication**

The garage door two-way communication is a function that communicates with the garage door opener and indicates whether the garage door is open or closed using the indicator lights in the rear view mirror. It can indicate the status of the garage door within a range up-to 250 m (820 ft).

**NOTE**

The communication range may shorten depending on obstructions.

Within five seconds after programming a new HomeLink button, both of the garage door status indicator lights will flash rapidly in green indicating that the garage door two-way communication has been established. If the garage door status indicator lights flash, the two-way communication programming is complete.

If the garage door status indicator lights do not flash, the two-way communication programming is not completed. For additional HomeLink information and programming videos, refer to the following Websites:

- [www.HomeLink.com](http://www.HomeLink.com)
- [www.youtube.com/HomeLinkGentex](http://www.youtube.com/HomeLinkGentex)

**Operating the garage door two-way communication**

By pressing HomeLink buttons 1 and 2 at the same time for two seconds, the status of the garage door is indicated for about 3 seconds as follows:

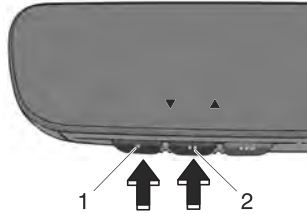

1. HomeLink button 1
2. HomeLink button 2

Garage door status	Indicator light
Closing	Amber flashes
	▼
Opening	Amber flashes
	▲
Closed	Green turns on
	▼
Opened	Green turns on
	▲

# HomeLink Wireless Control System

---

## Erasing Programmed HomeLink Buttons

Press the two outer HomeLink buttons continuously at the same time until the indicator light flashes.

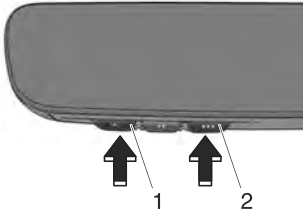

1. HomeLink button 1
2. HomeLink button 3

### **NOTE**

- All of the programmed HomeLink buttons are reset. If there is programming you do not want to delete, reprogram if necessary. Refer to Programming the HomeLink System.
- Verify that the programming has been erased if you resell the vehicle.
- The programming will not be erased even if the battery is disconnected.

## Warnings and Cautions For Using the Accessories

 **CAUTION**

When installing accessories using electrical or electronic components, consult an Authorized Mazda Dealer. There is a possibility of accidents due to brake or air bag mis-operation, vehicle damage or malfunctions.

## Warnings and Cautions For Using the Floor Mat

We recommend the use of Genuine Mazda floor mats.

### WARNING

**Make sure the floor mats are secured with the grommets to prevent them from bunching up under the foot pedals (Driver's side).**

Using a floor mat that is not secured is dangerous as it will interfere with the accelerator and brake pedal operation (driver's side), which could result in an accident.

Only use a floor mat which conforms to the shape of the floor on the driver's side and make sure it is oriented correctly.

Secure the floor mat using the grommets.

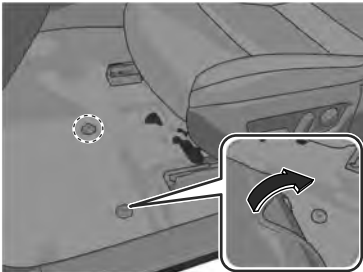

There are various ways to secure floor mats depending on the type used, therefore secure the mat according to the type.

After installing the floor mat, make sure that it does not slide from side to side or back and forth, and that there is sufficient clearance with the accelerator and brake pedals on the driver's side.

After removing the floor mat for cleaning or some other reason, always securely reinstall it while paying attention to the precautions just mentioned.

**Do not install two floor mats, one on top of the other, on the driver's side.** Installing two floor mats, one on top of the other, on the driver's side is dangerous as the retention pins can only keep one floor mat from sliding forward.

Loose floor mat(s) will interfere with the foot pedals and could result in an accident.

If using an all-weather mat for winter use always remove the original floor mat.

# Malfunction Diagnosis Connector

---

## Malfunction Diagnosis Connector

**⚠ CAUTION**

Do not connect any devices other than the specially designed malfunction diagnosis devices for servicing. If any device other than the malfunction diagnosis device is connected, it may affect the vehicle's electrical devices or lead to damage such as lead-acid battery depletion.

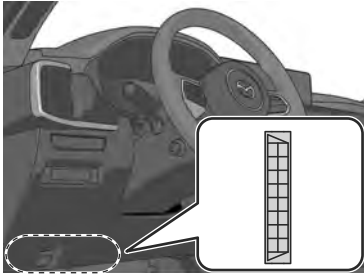

# Spare Tire and Tool Storage

## Jack

### To remove the jack

1. Remove the luggage board.



2. Remove the cargo sub-compartment.



3. Turn the wing bolt and jack screw counterclockwise.

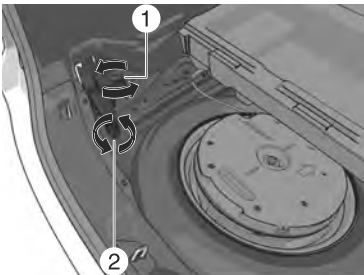

1. Wing bolt
2. Jack screw

### To secure the jack

1. Insert the wing bolt into the jack with the jack screw pointing to the right side and turn the wing bolt clockwise to temporarily tighten it.
2. Tighten the jack screw clockwise.

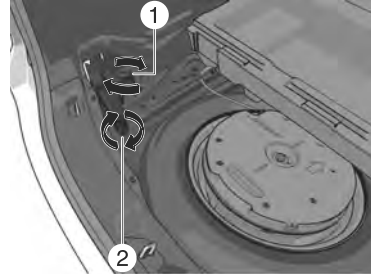

1. Wing bolt
2. Jack screw
3. Turn the wing bolt completely to secure the jack.

### Maintenance

- Always keep the jack clean.
- Make sure the moving parts are kept free from dirt or rust.
- Make sure the screw thread is adequately lubricated.



# Spare Tire and Tool Storage

## Spare Tire

The temporary spare tire is lighter and smaller than a conventional tire, and is designed only for emergency use and should be used only for VERY short periods. Temporary spare tires should NEVER be used for long drives or extended periods.

### **⚠ WARNING**

**Do not install the temporary spare tire on the rear wheels (driving wheels).** Driving with the temporary spare tire on one of the rear driving wheels is dangerous. Handling will be affected. You could lose control of the vehicle, especially on ice or snow bound roads, and have an accident. Move a regular tire to the rear wheel and install the temporary spare tire to the front.

### **⚠ CAUTION**

- When using the temporary spare tire, driving stability may decrease compared to when using only the conventional tire. Drive carefully.
- To avoid damage to the temporary spare tire or to the vehicle, observe the following precautions:
  - Do not exceed 80 km/h (50 mph).
  - Avoid driving over obstacles. Also, do not drive through an automatic car wash. This tire's diameter is smaller than a conventional tire, so the ground clearance is reduced.
  - Do not use a tire chain on this tire because it will not fit properly.
  - Do not use your temporary spare tire on any other vehicle, it has been designed only for your Mazda.

- Use only one temporary spare tire on your vehicle at the same time.

### **To remove the spare tire**

1. Remove the luggage board.



2. Remove the cargo sub compartment.



3. **(Vehicles with sub-woofer)** Uncouple the sub-woofer connector.

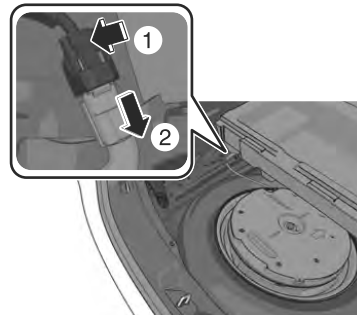

**NOTE**

Extra strength may be required to uncouple the connector. Be sure to squeeze the tab firmly.

**4. (Vehicles with sub-woofer)**

Turn the spare tire hold-down bolt counterclockwise and remove the sub-woofer and the spare tire.

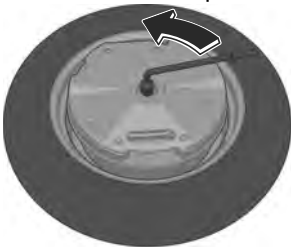

**(Vehicles without sub-woofer)**

Turn the spare tire hold-down bolt counterclockwise and remove the spare tire.



**NOTE**

If the spare tire hold-down bolt cannot be loosened, hold the edge of the tire and turn it counterclockwise until the spare tire hold-down bolt rotates.

**To secure the spare tire**

Store the spare tire in the reverse order of removal. After storing, verify that the spare tire is stored securely.

# MEMO

# 8

## What to Do in Case of Emergency

<b>In Case of Emergency.....</b>	<b>8-4</b>
Dealing With an Accident.....	8-4
Make a Private eCall*.....	8-4
<b>When Towing is Required.....</b>	<b>8-5</b>
Having the Vehicle Towed.....	8-5
Using the Tiedown Hooks* .....	8-6
<b>Key Does Not Operate.....</b>	<b>8-8</b>
Canceling the Key Temporary Suspension Function.....	8-8
Unlocking Using the Auxiliary Key.....	8-8
Starting the Engine with a Dead Key Battery.....	8-9
<b>Engine Does Not Start.....</b>	<b>8-11</b>
Taking Action with Depleted Lead-acid Battery.....	8-11
Starting a Flooded Engine.....	8-15
<b>Engine Cannot be Stopped.....</b>	<b>8-16</b>
Forcibly Stopping the Engine.....	8-16
<b>Problem With the Brake System (Foot Brake).....</b>	<b>8-17</b>
Applying the Emergency Brake.....	8-17
<b>AUTOHOLD Cannot be Canceled.....</b>	<b>8-18</b>
Forcibly Canceling the AUTOHOLD.....	8-18
<b>Overheating.....</b>	<b>8-19</b>
Taking Action with Overheating.....	8-19
<b>Tire is Punctured or Bursts.....</b>	<b>8-21</b>
Changing a Flat Tire.....	8-21
<b>Liftgate Cannot Open.....</b>	<b>8-29</b>
Open the liftgate from the luggage compartment.....	8-29
<b>The Power Windows Cannot Be Operated.....</b>	<b>8-30</b>
Initializing the Power Window.....	8-30
<b>The Panorama Sunroof Cannot Be Operated.....</b>	<b>8-31</b>
Initializing the Panorama Sunroof* .....	8-31
<b>The Moonroof Cannot Be Operated.....</b>	<b>8-32</b>
Initializing the Moonroof* .....	8-32
<b>Windshield Wipers Operate at High Speed.....</b>	<b>8-33</b>
Have the Vehicle Inspected.....	8-33

**Washer Fluid Does Not Spray** .....  
 ..... **8-34**  
 Inspecting Washer Fluid  
 Level..... 8-34

**Active Driving Display Does Not Operate**..... **8-35**  
 Active Driving Display Does Not Operate..... 8-35

**Warning/Indicator Light Turns On**..... **8-36**  
 Warning Lights..... 8-36  
 Brake System Warning Light..... 8-36  
 Charging System Warning Light..... 8-37  
 Hybrid System Warning Light..... 8-38  
 Engine Oil Warning Light..... 8-38  
 High Engine Coolant Temperature Warning Light..... 8-39  
 Electric Power Steering Warning Light..... 8-39  
 Shift System Warning Light ..... 8-40  
 ABS Warning Light..... 8-40  
 Master Warning Light..... 8-41  
 Brake Control System Warning Light..... 8-41  
 Electric Parking Brake (EPB) Indicator Light..... 8-42  
 Check Engine Warning Light..... 8-42  
 i-stop Warning Light (Amber)..... 8-43  
 Automatic Transmission Warning Light..... 8-43  
 AWD Warning Light..... 8-44

Tire Pressure Monitoring System (TPMS) Warning Light (Flashing)..... 8-44  
 TCS/DSC Indicator Light (Turns on)..... 8-45  
 Air Bag/Seat Belt Pretensioner System Warning Light..... 8-45  
 KEY Warning Light (Red)..... 8-46  
 Security Indicator Light..... 8-46  
 High Beam Control System (HBC) Warning Light (Amber)..... 8-47  
 i-ACTIVSENSE Warning Light..... 8-47  
 Exterior Lights Warning Light..... 8-48  
 Low Fuel Warning Light..... 8-48  
 Check Fuel Cap Warning Light..... 8-49  
 Engine Oil Level Warning Light..... 8-49  
 Seat Belt Warning Light (Front Seat)..... 8-50  
 Seat Belt Warning Light (Rear Seat) (Red)..... 8-51  
 Rear Seat Alert Warning Light\* ..... 8-51  
 Low Washer Fluid Amount Warning Light\* ..... 8-52  
 Door-ajar Warning Light/Liftgate-open Warning Light/Hood-open Warning Light..... 8-52  
 KEY Indicator Light (Green) (Flashing)..... 8-53  
 Wrench Indicator Light..... 8-53

**Warning Sound is Activated**..... **8-55**  
 Lights-On Reminder..... 8-55  
 Vehicle Power Not Switched OFF Reminder Warning Sound..... 8-55

---

Key Removed from Vehicle Warning Sound.....	8-56
Key Left-in-Vehicle Warning Sound.....	8-56
Key Left-In-Luggage Compartment Warning Sound (Vehicles With Advanced Keyless Function).....	8-57
Door Lock Inoperable Warning Sound.....	8-57
Power Liftgate Warning Sound*..... .....	8-58
Brake System Warning Sound.....	8-58

Electric Parking Brake (EPB) Warning Sound.....	8-59
Reverse Position Warning Sound.....	8-59
Battery Saving Mode Warning Sound.....	8-60

**If the Vehicle Becomes Stuck.... 8-61**

What to do when the vehicle is stuck.....	8-61
--	------

**Alexa Does Not Operate..... 8-62**

Check Alexa settings.....	8-62
---------------------------	------

## In Case of Emergency

---

### Dealing With an Accident

In case of an accident, react calmly and perform as follows.

1. Prevention of secondary accident  
Move the vehicle to a safe place (such as a shoulder or a vacant lot) where it does not obstruct traffic, and stop the engine.
2. Aiding injured person  
If there is any injured person, provide any possible first aid until an ambulance or a doctor arrives. If someone has injured his or her head, do not move the person unnecessarily. However, move the person to a safe place if there is the possibility of a secondary accident.
3. Call the police  
Provide information such as the location, conditions, and level of injury, and take directions.
4. Check the name and address of the other person.
5. Call an Authorized Mazda Dealer and insurance agency.

### Make a Private eCall\*

Connected service is available through the Private eCall center. Refer to How to Use Private eCall on page 7-26.

## Having the Vehicle Towed

We recommend that towing be done only by an Authorized Mazda Dealer or a commercial tow-truck service.

Proper lifting and towing are necessary to prevent damage to the vehicle. Particularly when towing an AWD vehicle, where all the wheels are connected to the drive train, proper transporting of the vehicle is absolutely essential to avoid damaging the drive system. Government and local laws must be followed.

### WARNING

**Always tow an AWD vehicle with all four wheels off the ground.**

Towing an AWD vehicle with either the front or rear wheels on the ground is dangerous as the drive train could be damaged, or the vehicle could trail away from the tow truck and cause an accident. If the drive train has been damaged, transport the vehicle on a flatbed truck.



### CAUTION

- Do not tow the vehicle pointed forward with driving wheels on the ground. This may cause internal damage to the transmission.



- Do not tow with sling-type equipment. This could damage your vehicle. Use wheel-lift or flatbed equipment.



- If the parking brake cannot be released when towing the vehicle, transport the vehicle with all front and rear wheels raised off the ground as shown in the figure. If the vehicle is towed without raising the wheels off the ground, the brake system could be damaged.



1. Wheel dollies



# When Towing is Required

## Using the Tiedown Hooks\*

### **CAUTION**

Do not use the front and rear tiedown eyelets for towing the vehicle. They have been designed only for securing the vehicle to a transport vessel during shipping. Using the eyelets for any other purpose could result in the vehicle being damaged.

1. Remove the tiedown eyelet, the jack lever and the lug wrench or equivalent from the luggage compartment.

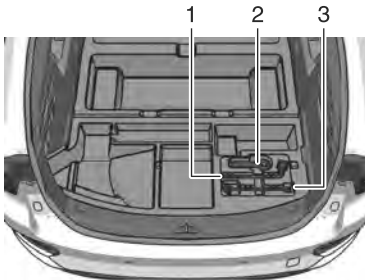

1. Lug wrench
2. Tiedown eyelet
3. Jack lever

2. Wrap a flathead screwdriver or jack lever or a similar tool with a soft cloth to prevent damage to a painted bumper, and open the cap located on the front or rear bumper.

### Front

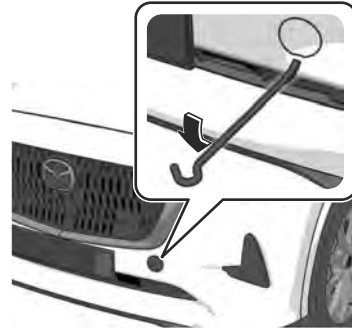

### Rear

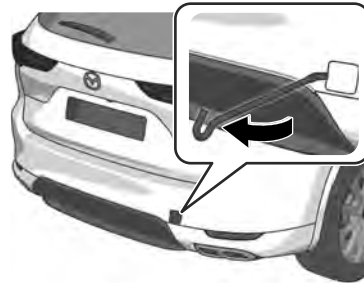

### **CAUTION**

Do not use excessive force as it may damage the cap or scratch the painted bumper surface.

### **NOTE**

Remove the cap completely and store it so as not to lose it.

3. Securely install the tiedown eyelet using the lug wrench, the jack lever or equivalent.

**Front**

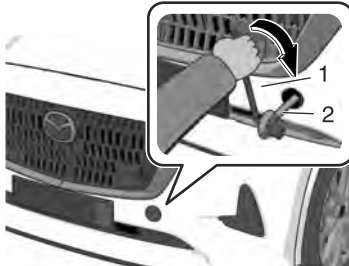

1. Lug wrench
2. Tiedown eyelet

**Rear**

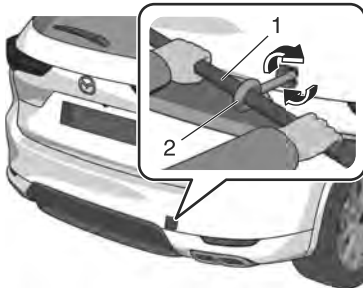

1. Jack lever
2. Tiedown eyelet

4. Hook the tying rope to the tiedown eyelet.

**⚠ CAUTION**

If the tiedown eyelet is not securely tightened, it may loosen or disengage from the bumper when tying the vehicle. Make sure that the tiedown eyelet is securely tightened to the bumper.

## Canceling the Key Temporary Suspension Function

If a key is inside the vehicle, its functions might be temporarily suspended to prevent theft. In this case, press the unlock button on the suspended key in the vehicle to restore the functions.

## Unlocking Using the Auxiliary Key

1. Remove the cover while pressing the knob.



2. Remove the auxiliary key.
3. Insert the auxiliary key while pulling the driver's door handle.



4. Turn the auxiliary key.  
The door is unlocked.



5. Attach the auxiliary key to its original position.

6. Insert the tabs of the cover.



## Starting the Engine with a Dead Key Battery

### CAUTION

Do not allow the following conditions. Otherwise, the vehicle may not receive the correct signal from the key and the engine may not start.

- Metal parts of other keys or metal objects touch the key.



- Spare keys or keys for other vehicles equipped with an immobilizer system touch or come near the key.



- Equipment containing electronic components or cards with magnetic strips such as credit cards come near the key.

If the engine cannot be started due to a dead key battery, use the following procedure to start the engine.

1. Depress the brake pedal.  
The push button start indicator light (green) flashes.
2. Align the center of the key emblem with the center of the push button start.

## Key Does Not Operate

---

The push button start indicator light (green) turns on.



1. Indicator light
  2. Push button start
  3. Key
  4. Emblem
3. Press the push button start.

### NOTE

- If there is a problem with the push button start function, the push button start indicator light (amber) flashes. In this case, it is possible to start the engine, however, have the vehicle inspected by an Authorized Mazda Dealer as soon as possible.
- If the push button start indicator light (green) does not turn on, perform the operation from the beginning. If it still does not turn on, have the vehicle inspected by an Authorized Mazda Dealer.
- To change the vehicle power position, release the brake pedal after the push button start indicator light (green) turns on, then press the push button start. The vehicle power position is switched in the order of ACC, ON, and OFF.

Once the vehicle power is switched OFF, the vehicle power position can no longer be changed. Therefore, to start the engine, perform the operation from the beginning.

## Taking Action with Depleted Lead-acid Battery

The lead-acid battery might be depleted if the following conditions occur.

- The engine does not start.
- The selector lever cannot be shifted to a position other than P.
- The horn sound is weak or it does not sound.
- The brightness of the lights is extremely low.

Using commercially available booster cables, connect the lead-acid battery of the booster vehicle's battery to the lead-acid battery of your vehicle and start the engine. Jump-starting is dangerous if done incorrectly. Therefore, follow the procedure carefully. If you feel unsure about jump-starting, we strongly recommend that you have a competent service technician do the work.

### **WARNING**



**Read the following precautions carefully before using the lead-acid battery or inspecting to ensure safe and correct handling.**



**Always wear eye protection when working near the lead-acid battery.** Working without eye protection is dangerous. Lead-acid battery fluid contains SULFURIC ACID which could cause blindness if splashed into your eyes. Also, hydrogen gas produced during normal lead-acid battery operation, could ignite and cause the lead-acid battery to explode.



**Wear eye protection and protective gloves to prevent contact with lead-acid battery fluid.**

Spilled lead-acid battery fluid is dangerous. Lead-acid battery fluid contains SULFURIC ACID which could cause serious injuries if it gets in eyes, or on the skin or clothing. If this happens, immediately flush your eyes with water for 15 minutes or wash your skin thoroughly and get medical attention.



**Always keep lead-acid batteries out of the reach of children.** Allowing children to play near lead-acid batteries is dangerous. Lead-acid battery fluid could cause serious injuries if it gets in the eyes or on the skin.

## Engine Does Not Start

---



**Keep flames and sparks away from lead-acid battery cells and do not allow metal tools to contact the positive (+) or negative (-) terminal of the lead-acid battery when working near a lead-acid battery. Do not allow the positive (+) terminal to contact the vehicle body.**

Flames and sparks near lead-acid battery cells are dangerous. Hydrogen gas, produced during normal lead-acid battery operation, could ignite and cause the lead-acid battery to explode. An exploding lead-acid battery can cause serious burns and injuries. Keep all flames including cigarettes and sparks away from lead-acid battery cells.



**Keep all flames and sparks away from lead-acid battery cells because hydrogen gas is produced from lead-acid battery cells while charging the lead-acid battery or adding lead-acid battery fluid.**

Flames and sparks near lead-acid battery cells are dangerous. Hydrogen gas, produced during normal lead-acid battery operation, could ignite and cause the lead-acid battery to explode. An exploding lead-acid battery can cause serious burns and injuries. Keep all flames including cigarettes and sparks away from lead-acid battery cells.

**Do not jump-start a frozen lead-acid battery or one with a low fluid level.**

Jump-starting a frozen lead-acid battery or one with a low fluid level is dangerous. It may rupture or explode, causing serious injury.

**Connect the negative cable to a good ground point away from the lead-acid battery.**

Connecting the end of the second jumper cable to the negative (-) terminal of the depleted lead-acid battery is dangerous.

A spark could cause the gas around the lead-acid battery to explode and injure someone.

**Route the jumper cables away from parts that will be moving.**

Connecting a jumper cable near or to moving part (cooling fans) is dangerous. The cable could get caught when the engine starts and cause serious injury.



➤ Use only a 12 V booster system. You can damage a 12 V starter, ignition system, and other electrical parts beyond repair with a 24 V power supply (two 12 V batteries in series).

➤ Do not use your vehicle as a booster vehicle to prevent damaging your vehicle.

1. Make sure that the vehicle power is switched OFF.

2. Remove the hole cover.  
Refer to Removing the hole cover in Inspecting Lead-acid battery on page 9-24.
3. Remove the lead-acid battery cover.



4. Turn off the booster vehicle's engine and connect the jumper cables in the following order.  
Make sure that the jumper cables are securely connected so that they do not disconnect due to the vibrations.

**1st lead**

① Positive (+) terminal on the depleted lead-acid battery

② Positive (+) terminal on booster vehicle's battery

**2nd lead**

③ Negative (-) terminal on booster vehicle's battery

④ Location shown in the figure (do not connect to the negative (-) terminal of the depleted lead-acid battery)

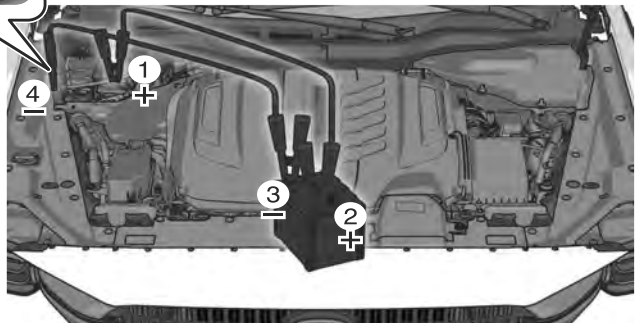

5. Start the booster vehicle's engine and rev the engine.
6. Start the engine of your vehicle.



## Engine Does Not Start

---

7. Disconnect the booster cables in the reverse order of their connection after the engine is started.
8. Install the lead-acid battery cover.
9. Have your vehicle inspected by an Authorized Mazda Dealer as soon as possible.

### **Push-Starting**

Do not push-start your Mazda.



#### **Never tow a vehicle to start it.**

Towing a vehicle to start it is dangerous. The vehicle being towed could surge forward when its engine starts, causing the 2 vehicles to collide. The occupants could be injured.

## **Starting a Flooded Engine**

If the engine stops unexpectedly, it may be flooded (excessive fuel in the engine).

Follow this procedure:

1. If the engine does not start within 5 seconds on the first try, wait 10 seconds and try again.
2. Make sure the parking brake is on.
3. Depress the accelerator all the way and hold it there.
4. Depress the brake pedal, then press the push button start. If the engine starts, release the accelerator immediately because the engine will suddenly rev up.
5. If the engine fails to start, crank it without depressing the accelerator.

If the engine still does not start using the previous procedure, have your vehicle inspected by an Authorized Mazda Dealer.

## Engine Cannot be Stopped

---

### Forcibly Stopping the Engine

Press and hold the push button start or press it quickly and repeatedly. The engine stops and the vehicle power is switched to ACC.

## Problem With the Brake System (Foot Brake)

---

### Applying the Emergency Brake

Continue pulling the EPB switch.

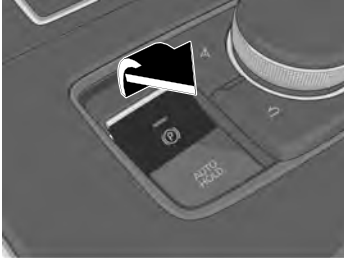

The brakes are applied and the vehicle can be decelerated/stopped.

A sound is activated when the brake is applied and when the EPB switch is released, the brake will be released and the sound stops.

#### **WARNING**

**Use only in emergency situations.**  
Use this function only in an emergency. Excessive use will cause the brake parts to wear out quickly or cause the brakes to generate heat, reducing their effectiveness.

## AUTOHOLD Cannot be Canceled

---

### Forcibly Canceling the AUTOHOLD

The AUTOHOLD can be canceled forcibly by fully depressing the accelerator pedal for about 1 second while the AUTOHOLD is operating. Forcibly cancel the AUTOHOLD only when the AUTOHOLD cannot be canceled due to a system malfunction or it is necessary to cancel the AUTOHOLD in an emergency.

## Taking Action with Overheating

If the engine coolant temperature gauge indicates overheating and the high engine coolant temperature warning light  is displayed, the vehicle loses power or you hear a loud knocking or pinging noise, the engine is probably too hot.



### **WARNING**

**Do not open the hood while steam is escaping from the engine compartment.**

If the hood is opened while the engine compartment is hot, steam and scalding hot coolant may shoot out and cause serious injury. In addition, even if steam is not escaping, some parts in the engine compartment may remain at high temperature. Be extremely careful when opening the hood.



**Do not touch rotating parts such as the fan belt when inspecting inside the engine compartment.**

Working near the cooling fan when it is running is dangerous. The fan could continue running indefinitely even if the engine has stopped and the engine compartment temperature is high. You could be hit by the fan and seriously injured.

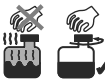

**Do not remove either cooling system cap when the engine and radiator are hot.**

When the engine and radiator are hot, scalding coolant and steam may shoot out under pressure and cause serious injury.

1. Drive safely to the side of the road and park off the right-of-way.
2. Shift into park (P).
3. Apply the parking brake.
4. Turn off the air conditioner.
5. Check whether coolant or steam is escaping from the engine compartment.

### **If steam is coming from the engine compartment:**

Do not go near the front of the vehicle. Stop the engine. Wait until the steam dissipates, then open the hood and start the engine.

### **If neither coolant nor steam is escaping:**

Open the hood and idle the engine until it cools.

6. Make sure the cooling fan is operating, then turn off the engine after the temperature has decreased.



### **CAUTION**

If the cooling fan does not operate while the engine is running, the engine temperature will increase. Stop the engine and call an Authorized Mazda Dealer.

7. When cool, check the coolant level. If it is low, look for coolant leaks from the radiator and hoses.

## Overheating

---

**If you find a leak or other damage, or if coolant is still leaking:**

Stop the engine and call an Authorized Mazda Dealer.

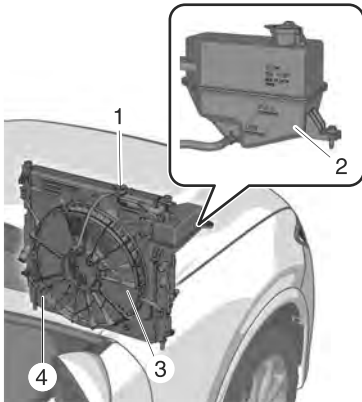

1. Cooling system cap
2. Coolant reservoir
3. Cooling fan
4. Radiator

**If you find no problems, the engine is cool, and no leaks are obvious:**

Carefully add coolant as required (page 9-20).



If the engine continues to overheat or frequently overheats, have the cooling system inspected. The engine could be seriously damaged unless repairs are made. Consult an Authorized Mazda Dealer.

## Tire is Punctured or Bursts

### Changing a Flat Tire

#### NOTE

If the following occurs while driving, it could indicate a flat tire.

- Steering becomes difficult.
- The vehicle begins to vibrate excessively.
- The vehicle pulls in one direction.

If you have a flat tire, drive slowly to a level spot that is well off the road and out of the way of traffic to change the tire.

Stopping in traffic or on the shoulder of a busy road is dangerous.

#### **WARNING**

**Do not install the temporary spare tire on the rear wheels (driving wheels).**

Driving with the temporary spare tire on one of the rear driving wheels is dangerous. Handling will be affected. You could lose control of the vehicle, especially on ice or snow bound roads, and have an accident. Move a regular tire to the rear wheel and install the temporary spare tire to the front.

**Be sure to follow the directions for changing a tire.**

Changing a tire is dangerous if not done properly. The vehicle can slip off the jack and seriously injure someone. No person should place any portion of their body under a vehicle that is supported by a jack.

**Never allow anyone inside a vehicle supported by a jack.**

Allowing someone to remain in a vehicle supported by a jack is dangerous. The occupant could cause the vehicle to fall resulting in serious injury.

#### NOTE

Make sure the jack is well lubricated before using it.

1. Park on a hard, level surface off the right-of-way and firmly set the parking brake.
2. Shift into Park (P) and turn off the engine.
3. Turn on the hazard warning flasher.
4. Have passengers get out of the vehicle and away from the vehicle and traffic.
5. Remove any luggage, the jack (page 7-73), spare tire (page 7-74), and tools.

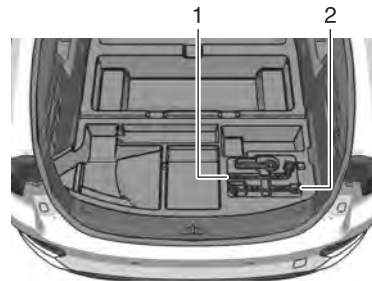

1. Lug wrench
2. Jack lever



## Tire is Punctured or Bursts

6. Block the wheel diagonally opposite the flat tire. When blocking a wheel, place a tire block both in front and behind the tire.



### NOTE

When blocking a tire, use rocks or wood blocks of sufficient size if possible to hold the tire in place.

### Removing a Flat Tire



When jacking-up a vehicle, always shift the selector lever to **P** position, apply the parking brake, and place wheel blocks in the position diagonally opposed to the jack. Changing a flat tire without using wheel blocks is dangerous because the vehicle may move and fall off the jack even with the selector lever in **P** position, which could result in an accident.

1. Loosen the lug nuts by turning them counterclockwise one turn each, but do not remove any lug nuts until the tire has been raised off the ground.

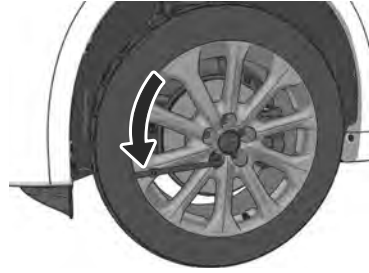

### NOTE

If your Mazda is equipped with the optional antitheft wheel lug nuts, a special key must be used to unlock the locking lug nut for each wheel. For details, refer to "Locking Lug Nuts" below.

2. Place the jack on the ground.
3. Turn the jack screw in the direction shown in the figure and adjust the jack head so that it is close to the jack-up position.

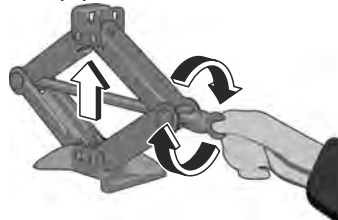

## Tire is Punctured or Bursts

- Place the jack under the jack-up position closest to the tire being changed with the jack head squarely under the jack-up point.



- Continue raising the jack head gradually by rotating the screw with your hand until the jack head is inserted into the jack-up position.

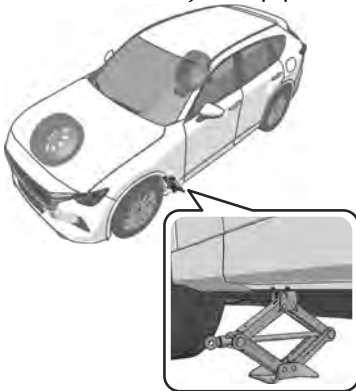

### **! WARNING**

**Use only the front and rear jacking positions recommended in this manual.**

Attempting to jack the vehicle in positions other than those recommended in this manual is dangerous. The vehicle could slip off the jack and seriously injure or even kill someone. Use only the front and rear jacking positions recommended in this manual.

**Do not jack up the vehicle in a position other than the designated jack-up position or place any objects on or under the jack.**

Jacking up the vehicle in a position other than the designated jack-up position or placing objects on or under the jack is dangerous as it could deform the vehicle body or the vehicle could fall off the jack resulting in an accident.

**Use only the jack provided with your Mazda.**

Using a jack that is not designed for your Mazda is dangerous. The vehicle could slip off the jack and seriously injure someone.

**Never place objects under the jack.**

Jacking the vehicle with an object under the jack is dangerous. The jack could slip and someone could be seriously injured by the jack or the falling vehicle.

### **NOTE**

When raising the jack head into the jacking position and aligning the groove in the jack head with the rail under the vehicle body, the top of the jack head contacts the vehicle's underbody without the rail contacting the bottom of the groove.

## Tire is Punctured or Bursts

6. Insert the jack lever and attach the lug wrench to tire jack.



7. Turn the jack handle clockwise and raise the vehicle high enough so that the spare tire can be installed. Before removing the lug nuts, make sure your Mazda is firmly in position and that it cannot slip or move.



### **WARNING**

**Do not jack up the vehicle higher than is necessary.**

Jacking up the vehicle higher than is necessary is dangerous as it could destabilize the vehicle resulting in an accident.

**Do not start the engine or shake the vehicle while it is jacked up.**

Starting the engine or shaking the vehicle while it is jacked up is dangerous as it could cause the vehicle to fall off the jack resulting in an accident.

**Never go under the vehicle while it is jacked up.**

Going under the vehicle while it is jacked up is dangerous as it could result in death or serious injury if the vehicle were to fall off the jack.

8. Remove the lug nuts by turning them counterclockwise; then remove the wheel and center cap.

### Locking Lug Nuts

If your Mazda is equipped with the optional antitheft wheel lug nuts, a special key must be used to unlock the locking lug nut for each wheel. The key is stored in the glove compartment, center console storage, storage box, or trunk. Register the key and lug nuts with the lock manufacturer by filling out the registration card and mailing it in using the accompanying envelope. If the key is lost, consult an Authorized Mazda Dealer or use the lock manufacturer's order form to order a new key.

Antitheft wheel lug nuts cannot be installed on a steel wheel spare tire. When installing a temporary spare tire, use one of the original lug nuts in place of the locking lug nut. The original lug nuts are stored inside your Mazda.

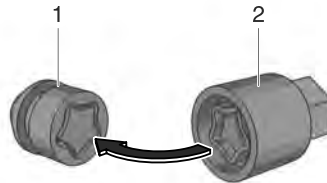

1. Antitheft lug nut
2. Special key

## Tire is Punctured or Bursts

### To remove an antitheft lug nut

1. Obtain the special key for the antitheft lug nut.
2. Place the special key on top of the antitheft lug nut, and be sure to hold the key square to it. If you hold the key at an angle, you may damage both key and nut. Do not use a power impact wrench.
3. Place the lug wrench on top of the key and apply pressure. Turn the wrench counterclockwise.

### To install the antitheft lug nut

1. Place the special key on top of the nut, and be sure to hold the key square to it. If you hold the key at an angle, you may damage both key and nut. Do not use a power impact wrench.
2. Place the lug wrench on top of the special key, apply pressure, and turn it clockwise.

Nut tightening torque	
N·m (kgf·m, ft·lbf)	108—147 (12—14, 80—108)

### Mounting the Spare Tire

1. Remove dirt and grime from the mounting surfaces of the wheel and hub, including the hub bolts, with a cloth.

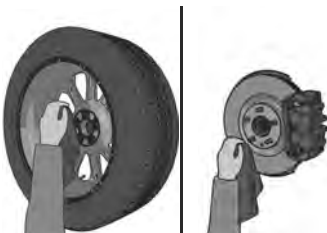

### **!** WARNING

**Make sure the mounting surfaces of the wheel, hub and lug nuts are clean before changing or replacing tires.**

When changing or replacing a tire, not removing dirt and grime from the mounting surfaces of the wheel, hub and hub bolts is dangerous. The lug nuts could loosen while driving and cause the tire to come off, resulting in an accident.

2. Mount the spare tire.
3. Install the lug nuts with the beveled edge inward; tighten them by hand.

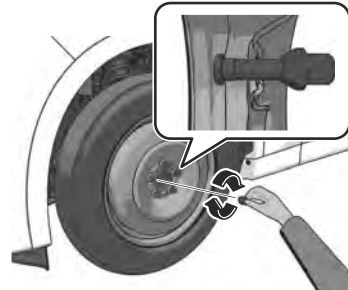

### **!** WARNING

**Do not apply oil or grease to lug nuts and bolts and do not tighten the lug nuts beyond the recommended tightening torque.**

Applying oil or grease to lug nuts and bolts is dangerous. The lug nuts could loosen while driving and cause the tire to come off, resulting in an accident. In addition, lug nuts and bolts could be damaged if tightened more than necessary.

4. Turn the lug wrench counterclockwise and lower the vehicle.

## Tire is Punctured or Bursts

- Use the lug wrench to tighten the nuts in the order shown.

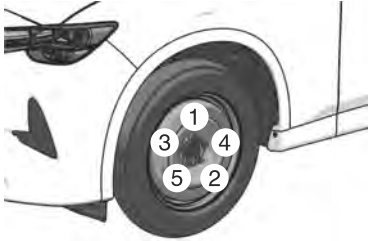

If you are unsure of how tight the nuts should be, have them inspected at an Authorized Mazda Dealer.

Nut tightening torque	
N·m (kgf·m, ft·lbf)	108—147 (12—14, 80—108)

### **⚠ WARNING**

**Always securely and correctly tighten the lug nuts.**

Improperly or loosely tightened lug nuts are dangerous. The wheel could wobble or come off. This could result in loss of vehicle control and cause a serious accident.

**Be sure to reinstall the same nuts you removed or replace them with metric nuts of the same configuration.**

Because the wheel studs and lug nuts on your Mazda have metric threads, using a non-metric nut is dangerous. On a metric stud, it would not secure the wheel and would damage the stud, which could cause the wheel to slip off and cause an accident.

- Remove the tire blocks and store the jack and tools.

### NOTE

To prevent the jack and tools from rattling, store them properly.

- (Vehicles without flat tire belt)**  
Store the damaged and/or flat tire in the rear cargo area.

### **(Vehicles with flat tire belt)**

Secure the damaged and/or flat tire by following procedures.

- Open the luggage mat.
- Remove the belt for securing the flat tire.

The number and shape of the flat tire belts differ depending on the vehicle specification.



- The flat tire belt for securing a flat tire.
- The flat tire belt for securing the sub-woofer.

- (Vehicles with sub-woofer)**

Secure the sub-woofer to the flat tire using the flat tire belt.

- Pass the flat tire belt through the wheel of the flat tire.



2. Install the sub-woofer to the flat tire.

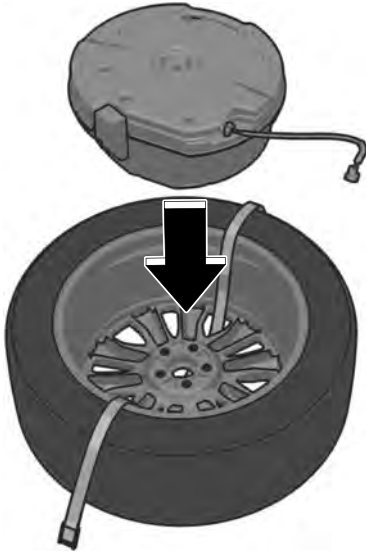

3. Pass the flat tire belt through the buckle.

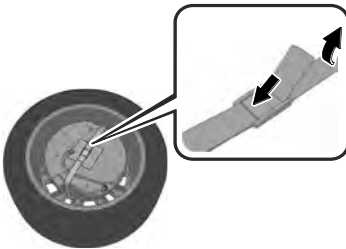

4. Pull the end of the flat tire belt and secure the sub-woofer and the wiring harness to the flat tire.

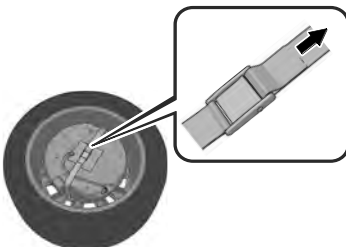

**CAUTION**

When pulling the flat tire belt, wrap the buckle with a cloth. If the buckle directly contacts the sub-woofer, the sub-woofer may be damaged.

4. Put the flat tire into the liftgate on the left and toward the back.



5. Thread the buckle through the wheel as shown in the figure.



6. Thread the belt through the rear seat as shown in the figure.

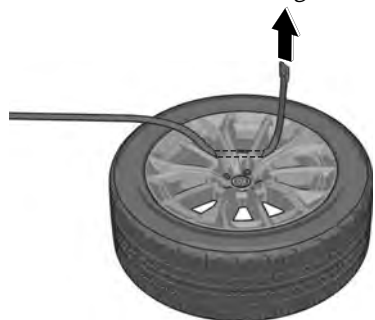

## Tire is Punctured or Bursts

---

7. Thread the belt through the buckle, then pull the belt end to secure the flat tire.

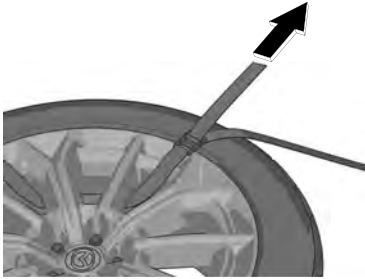

8. Check the tire inflation pressure. Refer to the specification charts on page 10-37.
9. Have the flat tire repaired or replaced as soon as possible.

### **WARNING**

**Do not drive with any tires that have incorrect air pressure.**

Driving on tires with incorrect air pressure is dangerous. Tires with incorrect pressure could affect handling and result in an accident. When you check the regular tires' air pressure, check the spare tire, too.

## Open the liftgate from the luggage compartment

If the lead-acid battery is dead, the liftgate cannot be unlocked and opened. In this case, the liftgate can be unlocked by taking care of the dead lead-acid battery situation.

Refer to Taking Action with Depleted Lead-acid Battery on page 8-11.

If the liftgate cannot be unlocked even after charging the dead lead-acid battery, you can open the liftgate as an emergency measure by following the procedure below.

1. Fold down the rear seatbacks.  
Refer to How to Use the Rear Seats on page 3-39.
2. Remove the cover.

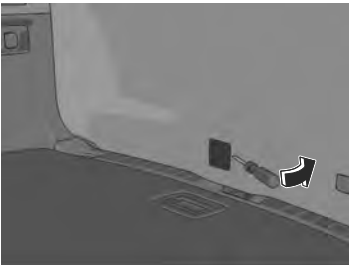

3. Move the lever.

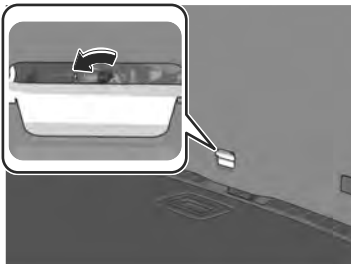

The liftgate is unlocked.  
After performing this emergency measure, have the vehicle inspected by an Authorized Mazda Dealer.



## The Power Windows Cannot Be Operated

---

### Initializing the Power Window

To restore these functions, do the following:

1. Switch the vehicle power ON.
2. Press the power window switch to fully open the window.
3. Pull the power window switch and fully close the window, and continue pulling the switch for about 2 seconds.

# The Panorama Sunroof Cannot Be Operated

---

## Initializing the Panorama Sunroof\*

If the panorama sunroof does not operate normally, do the following procedure.

1. Switch the vehicle power ON.
2. Press the tilt/slide switch forward to fully close the panorama sunroof and the sunshade.
3. Release the tilt/slide switch.
4. Press and hold the tilt/slide switch forward.  
The panorama sunroof and sunshade move further in the close direction.
5. When the sunshade stops after about 13 seconds, release the tilt/slide switch.

## The Moonroof Cannot Be Operated

---

### Initializing the Moonroof\*

If the moonroof does not operate normally, do the following procedure:

1. Switch the vehicle power ON.
2. Press the tilt switch, to partially tilt open the rear of the moonroof.
3. Repeat Step 2. The rear of the moonroof tilts open to the fully open position, then closes a little.

If the reset procedure is performed while the moonroof is in the slide position (partially open) it will close before the rear tilt opens.

## Windshield Wipers Operate at High Speed

---

### Have the Vehicle Inspected

The windshield wipers may operate at high speed if there is a problem with the wiper control.

If the wipers operate at high speed regardless of the wiper switch operation, have your vehicle inspected by an Authorized Mazda Dealer.

### Inspecting Washer Fluid Level

If the washer fluid is not sprayed, check the amount of fluid in the washer tank. Refer to Replenishing Windshield Washer Fluid on page 9-23.

If air enters the washer pipe when refilling the empty washer tank with washer fluid, the washer fluid may not be sprayed.

Operate the wiper lever until the washer fluid is sprayed.

If the washer fluid is not sprayed even after refilling, consult an Authorized Mazda Dealer.

## Active Driving Display Does Not Operate

---

### Active Driving Display Does Not Operate

If the active driving display does not operate, switch the vehicle power off and then restart the engine. If the active driving display does not operate even with the engine restarted, have the vehicle inspected at an Authorized Mazda Dealer.

## Warning/Indicator Light Turns On

### Warning Lights

If any warning/indicator light turns on/flashes, take appropriate action for each light. If the warning/indicator light does not turn off, or it turns on or flashes again, consult an Authorized Mazda Dealer.

#### **WARNING**

If the warning light/indicator light turns on or flashes, park the vehicle in a safe place immediately and take appropriate measures.

Continuing to drive the vehicle while ignoring the illumination/flashing of the warning light/indicator light is dangerous because a problem may occur to a vehicle system, the engine may be damaged, or it could lead to an accident.

The details for some warnings can be viewed on the center display or instrument cluster.

#### Checking Using the Center Display

1. Select "Information" on the home screen.
2. Select "Vehicle Status Monitor".
3. Select the applicable warning to view the warning details.

#### Checking Using the Instrument Cluster

Press the INFO switch on the steering switch to display the warning indication screen.

##### **Instrument cluster (Type A)**

Refer to How to Use the Instrument Cluster on page 5-24.

##### **Instrument cluster (Type B)**

Refer to How to Use the Multi-information Display on page 5-40.

### Brake System Warning Light



This warning has the following functions:

#### Warning light inspection

For an operation check, make sure that the light turns on when the vehicle power is switched on, and turns off a few seconds later or when the engine is started.

#### When the light turns on

The light turns on continuously if any one of the following occurs:

- Insufficient brake fluid
- Brake system (electronic brake force distribution system) has a problem

Park the vehicle in a safe place immediately and contact an Authorized Mazda Dealer.

#### **WARNING**

**Do not drive with the brake system warning light illuminated. Contact an Authorized Mazda Dealer to have the brakes inspected as soon as possible.**

Driving with the brake system warning light illuminated is dangerous. It indicates that your brakes may not work at all or that they could completely fail at any time. If this light remains illuminated, after checking that the parking brake is fully released, have the brakes inspected immediately.

## Warning/Indicator Light Turns On

If the brake system warning light and the ABS warning light  turn on at the same time, stop the vehicle in a safe place immediately and contact an Authorized Mazda Dealer.

The rear wheels could lock more quickly in an emergency stop than under normal circumstances which could result in an accident.

### CAUTION

- In addition, the effectiveness of the braking may diminish so you may need to depress the brake pedal more strongly than normal to stop the vehicle.
- The brake warning light may turn on when the engine is started. In this case, park the vehicle in a safe location and release the brake pedal. If the brake warning light remains illuminated, have the vehicle inspected by an Authorized Mazda Dealer.

## Charging System Warning Light

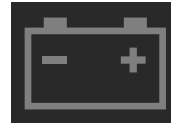

The light turns on if the charging system has a problem.

Park the vehicle in a safe place immediately and contact an Authorized Mazda Dealer.

### WARNING

**Do not continue driving with the charging system warning light turned on:**

Otherwise, the engine may stop, which could result in an accident.



## Warning/Indicator Light Turns On

---

### Hybrid System Warning Light



The light turns on if the hybrid system has a problem.  
Contact an Authorized Mazda Dealer.

### Engine Oil Warning Light



The light turns on when the engine oil pressure decreases.

#### **CAUTION**

Do not drive the vehicle with the engine oil warning light turned on. Driving the vehicle with decreased engine oil pressure may cause engine damage.

If the engine oil warning light turns on while driving, stop the vehicle in a safe place and stop the engine. After that, contact an Authorized Mazda Dealer.

## Warning/Indicator Light Turns On

### High Engine Coolant Temperature Warning Light



The light turns on if the engine coolant temperature has increased excessively. Check the contents of the message displayed and take the necessary action.

#### CAUTION

Do not drive the vehicle with the high engine coolant temperature warning light turned on. Driving the vehicle with the engine not cooled down may cause engine damage.

### Electric Power Steering Warning Light



The warning light turns on if the electric power steering has a malfunction.

If the warning light turns on, stop the vehicle in a safe place and switch the vehicle power OFF.

There is no problem if the warning light turns off when the engine is restarted after some time has passed.

If the warning light turns on even after the engine is restarted, contact an Authorized Mazda Dealer.

#### NOTE

- If the warning light turns on, the electric power steering will not operate normally. In this case, the steering wheel can still be operated, however, the operation may feel heavy compared to normal.
- Repeatedly jerking the steering wheel left and right while the vehicle is stopped or moving extremely slowly will cause the power steering system to go into protective mode which will make the steering feel heavy, but this does not indicate a problem. If this occurs, park the vehicle safely and do not operate the steering wheel. The system will return to normal after a few minutes.

## Warning/Indicator Light Turns On

---

### Shift System Warning Light



The light turns on if the shift system has a problem.

Park the vehicle in a safe place immediately and contact an Authorized Mazda Dealer.

Always apply the parking brake when parking or stopping the vehicle, as it may not be possible to hold the vehicle in a stopped position even with the selector lever in the P position. In addition, the engine may not start again if it is stopped.

### ABS Warning Light



The light remains on if the system has a problem.

Have your vehicle inspected by an Authorized Mazda Dealer.

#### **WARNING**

**If the brake system warning light  and the ABS warning light turn on at the same time, stop the vehicle in a safe place immediately and contact an Authorized Mazda Dealer.**

The rear wheels could lock more quickly in an emergency stop than under normal circumstances which could result in an accident.

## Warning/Indicator Light Turns On

---

### Master Warning Light



The light turns on if the system has a problem.  
Check the contents of the message displayed on the center display or in the instrument cluster and take the necessary action.

### Brake Control System Warning Light



The light turns on if the system has a problem.  
Have your vehicle inspected by an Authorized Mazda Dealer.

## Warning/Indicator Light Turns On

---

### Electric Parking Brake (EPB) Indicator Light



The light turns on when applying the parking brake and it turns off when releasing the parking brake.

#### Parking brake warning/Indicator light inspection

The light illuminates when the parking brake is applied with the vehicle power switched to START or ON. It turns off when the parking brake is released.

#### Turning on

If the light remains on even with the electric parking brake (EPB) switch turned off, the system may have a malfunction. Have the vehicle inspected by an Authorized Mazda Dealer.

#### Flashing

The light flashes if the system has a problem. If the light remains flashing even if the electric parking brake (EPB) switch is pressed, consult an Authorized Mazda Dealer as soon as possible.

### Check Engine Warning Light

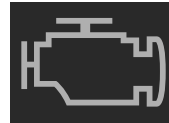

#### **! WARNING**

**Do not disconnect the lead-acid battery cables when the check engine warning light is turned on/flashing.**

The engine may be damaged when reconnecting the lead-acid battery cables, which could result in a fire.

The light turns on if the engine has a problem while it is running.

Park the vehicle in a safe place immediately and contact an Authorized Mazda Dealer.

If any of the following problems occur, the check engine warning light turns on.

- There is a problem with the engine control system
- There is a problem with the emission control system
- There is a problem with the transmission control system
- There is a problem with the M Hybrid Boost
- The fuel tank level being very low or approaching empty.
- The fuel-filler cap is missing or not tightened securely

If the check engine warning light remains turned-on/flashing, do not drive at high speed and have the vehicle inspected by an Authorized Mazda Dealer as soon as possible.

## Warning/Indicator Light Turns On

---

### i-stop Warning Light (Amber)



- After the engine is started, the light turns on/flashes continuously if the system has a problem. Have the vehicle inspected by an Authorized Mazda Dealer.

### Automatic Transmission Warning Light



The light turns on if the system has a problem. Contact an Authorized Mazda Dealer.



Do not drive the vehicle with the automatic transmission warning light turned on. If the vehicle continues to be driven while the automatic transmission warning light is turned on, the transmission could be damaged. Have your vehicle inspected by an Authorized Mazda Dealer as soon as possible.

## Warning/Indicator Light Turns On

---

### AWD Warning Light



The light turns on if the system has a problem or if the tire sizes do not match.

Check the contents of the message displayed and take the necessary action.

### Tire Pressure Monitoring System (TPMS) Warning Light (Flashing)

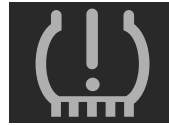

The light flashes if there is a malfunction in the system. Contact an Authorized Mazda Dealer.

#### **WARNING**

**Do not drive the vehicle at high speeds if the TPMS warning light turns on or flashes:**

Driving the vehicle at high speeds while the TPMS warning light is turned on or flashing is dangerous because the brake performance and the steering wheel operability will be reduced. If the vehicle is driven at high speeds or the brakes are suddenly applied, it could lead to an accident. Gradually apply the brakes to lower the vehicle's speed.

**Do not ignore the TPMS warning light when it is turned on or flashing:**

Continuing to drive the vehicle while ignoring the illumination/flashing of the TPMS warning light is dangerous because a tire may burst which could lead to an accident. Take appropriate measures as soon as possible.

## Warning/Indicator Light Turns On

### TCS/DSC Indicator Light (Turns on)



There may be a problem with the DSC, TCS, or Hill Launch Assist (HLA) under the following conditions.

Have your vehicle inspected by an Authorized Mazda Dealer.

- The light does not turn on or remains on even if the vehicle power is switched ON.
- It turns on while driving the vehicle.

### Air Bag/Seat Belt Pretensioner System Warning Light



A problem in the system might be indicated under the following conditions.

Have your vehicle inspected by an Authorized Mazda Dealer.

- Does not turn on even if the vehicle power is switched ON.
- Remains turned-on/flashing.

### **WARNING**

**Never tamper with the air bag/pretensioner systems and always have an Authorized Mazda Dealer perform all servicing and repairs.**

Self-servicing or tampering with the systems is dangerous. An air bag/pretensioner could accidentally activate or become disabled causing serious injury or death.



## Warning/Indicator Light Turns On

---

### KEY Warning Light (Red)



The light turns on if the system has a problem or if the key is out of the operation range.

Check the contents of the message displayed and take the necessary action.



If the push button start indicator light (amber) flashes at the same time, the engine may not start. Have the vehicle inspected by an Authorized Mazda Dealer as soon as possible.

### Security Indicator Light



If the security indicator light turns on/ flashes while driving, do not stop the engine (leave it operating) and have the vehicle inspected at an Authorized Mazda Dealer. If you stop the engine, you may not be able to start it again.

If the engine cannot be started, switch the vehicle power OFF, place the key in another position within the operation range, and then restart the engine.

Check the security indicator light and if it does not turn off, such as it remains on or flashes, switch the vehicle power OFF, wait for a while, and then restart the engine.

If the engine does not start after three attempts, a system malfunction may have occurred. Have the vehicle inspected by an Authorized Mazda Dealer.

#### NOTE

When repairing the immobilizer system, the key codes will need to be reprogrammed. Bring all the remaining keys to an Authorized Mazda Dealer.

## Warning/Indicator Light Turns On

---

### High Beam Control System (HBC) Warning Light (Amber)



The light turns on if the system has a problem.  
Have your vehicle inspected by an Authorized Mazda Dealer.

### i-ACTIVSENSE Warning Light



The light turns on if any i-ACTIVSENSE related system has a problem.  
Check the contents of the message displayed and take the necessary action.

## Warning/Indicator Light Turns On

---

### Exterior Lights Warning Light



The light turns on if the exterior lights (not including the license plate lights) has a problem.

Have your vehicle inspected by an Authorized Mazda Dealer.



Do not drive the vehicle while an exterior light has a malfunction. Poor visibility, and not being able to signal braking and turns may cause an accident. In addition, if the vehicle is driven with the lights not turned on, it may conflict with laws and regulations due to poor maintenance.

### Low Fuel Warning Light



The light turns on/flashes when the remaining fuel in the tank is near empty.

When the light flashes, a warning sound is activated.  
Refuel immediately.

#### NOTE

The light illumination timing may vary because fuel inside the fuel tank moves around according to the driving conditions and the vehicle posture.

## Warning/Indicator Light Turns On

---

### Check Fuel Cap Warning Light



If the check fuel cap warning light illuminates while driving, the fuel-filler cap may not be installed properly. Stop the engine and reinstall the fuel-filler cap.

### Engine Oil Level Warning Light



This warning light indicates that the engine oil level is around the MIN mark.

#### CAUTION

Do not continue to drive the vehicle with the engine oil level warning light turned on. If the vehicle continues to be driven with an insufficient amount of engine oil, it could cause damage to the engine.

Add 1 L (0.26 US gal, 0.22 Imp gal) of engine oil (page 9-18).

## Warning/Indicator Light Turns On

### Seat Belt Warning Light (Front Seat)



#### (Except Mexico)

The warning light flashes for about 6 seconds if the driver or front passenger's seat is occupied and the seat belt is not fastened with the vehicle power switched ON.

If the driver or front passenger's seat belt is unfastened (only when the front passenger's seat is occupied) and if the vehicle is driven at about 20 km/h (12 mph) or faster, or about 10 km/h (6 mph) or faster for a continuous 30 seconds, with the seat belt unfastened, the warning light flashes for a certain period.

After a short time, the warning light stops flashing, but remains illuminated. In addition, when the warning light flashes, a warning sound is activated. Wear the seat belt.

#### NOTE

- Placing heavy items on the front passenger's seat may cause the front passenger's seat belt warning function to operate depending on the weight of the item.
- To allow the sensor that detects an occupant to function properly, do not sit on the front passenger's seat with a cushion or other object on it. The sensor may not function properly because the additional seat cushion could cause sensor interference.

- If a small child is seated on the front passenger's seat, the warning light may not operate.

#### (Mexico)

The warning light turns on if the driver or front passenger's seat is occupied and the seat belt is not fastened with the vehicle power switched ON.

If the driver or front passenger's seat belt is unfastened (only when the front passenger's seat is occupied) and if the vehicle is driven at about 20 km/h (12 mph) or faster, the warning light flashes for a certain period.

After a short time, the warning light stops flashing, but remains illuminated. In addition, when the warning light flashes, a warning sound is activated. Wear the seat belt.

#### NOTE

- Placing heavy items on the front passenger's seat may cause the front passenger's seat belt warning function to operate depending on the weight of the item.
- To allow the sensor that detects an occupant to function properly, do not sit on the front passenger's seat with a cushion or other object on it. The sensor may not function properly because the additional seat cushion could cause sensor interference.
- If a small child is seated on the front passenger's seat, the warning light may not operate.

## Warning/Indicator Light Turns On

### Seat Belt Warning Light (Rear Seat) (Red)

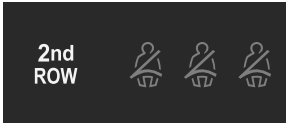

When the vehicle power is switched ON, the warning lights turn on if the seat belts are not fastened.\*<sup>1</sup> After the engine is started, the warning lights turn off after a short period of time.

In addition, if a fastened seat belt is unfastened, the warning light flashes for a short period of time and then turns off.

When the warning light flashes, a warning sound is activated.

Wear the seat belt.

\*<sup>1</sup> The warning light also turns on when the rear seat is unoccupied.

### Rear Seat Alert Warning Light\*



The warning light turns on continuously if the system has a problem. Have the vehicle inspected by an Authorized Mazda Dealer.

## Warning/Indicator Light Turns On

---

### Low Washer Fluid Amount Warning Light\*



The light turns on if the amount of washer fluid is low when the vehicle power is switched ON. Add washer fluid.

### Door-ajar Warning Light/ Liftgate-open Warning Light/Hood-open Warning Light

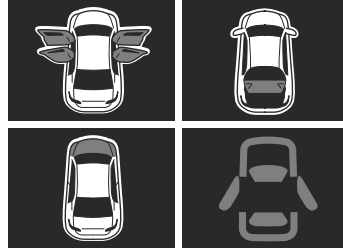

The light turns on if any door/liftgate/hood is not closed securely. In addition, the warning sound is activated if any door/liftgate is not closed and the vehicle is driven.

Close the door/liftgate/hood securely.

## Warning/Indicator Light Turns On

### KEY Indicator Light (Green) (Flashing)



The light flashes if the battery power of the key is low when the vehicle power is switched from ON to OFF. Replace the key battery.

### Wrench Indicator Light

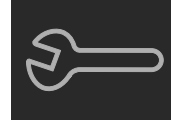

The wrench indication/indicator light is displayed/turns on under the following conditions.

- When the preset maintenance period has arrived. Refer to the Information section in the Mazda Connect Owner's Manual.

#### CAUTION

- When the maintenance period arrives, have your vehicle inspected by an Authorized Mazda Dealer as soon as possible. If maintenance is neglected, a decrease in vehicle performance may occur which could cause damage. Have your vehicle inspected before the maintenance period arrives.
- If the vehicle continues to be driven after the engine oil replacement period has passed, it could cause damage to the engine. Replace the engine oil before the maintenance period arrives.
- Depending on the vehicle use conditions, engine oil replacement is required due to engine oil deterioration from fuel penetrating the engine oil. Confirm the contents of the message displayed in the instrument cluster and have your vehicle inspected at an Authorized Mazda Dealer.



## Warning/Indicator Light Turns On

---

### NOTE

- The wrench indication/indicator light may display/turn on earlier than the preset period depending on vehicle usage conditions.
- Whenever the engine oil is replaced, a reset of the vehicle engine control unit is necessary.

Refer to the Information section in the Mazda Connect Owner's Manual.

## Warning Sound is Activated

---

### Lights-On Reminder

If the vehicle power is switched OFF with the exterior lights turned on and the driver's door is opened, a sound is activated.

Operate the headlight switch to turn off the exterior lights.

#### NOTE

A personalized function is available to change the sound volume for the lights-on reminder.

Refer to the Settings section in the Mazda Connect Owner's Manual.

### Vehicle Power Not Switched OFF Reminder Warning Sound

If the driver's door is opened with the vehicle power switched to ACC, a beep will be heard continuously in the cabin to notify the driver that the vehicle power has not been switched OFF (STOP). Under this condition, the keyless entry system will not operate, the vehicle cannot be locked, and the lead-acid battery voltage will be depleted.

Switch the vehicle power OFF.

## Warning Sound is Activated

---

### Key Removed from Vehicle Warning Sound

#### Vehicles with advanced keyless function

If the key is taken out of the vehicle while the vehicle power is switched to ACC or ON, and all the doors are closed, a sound is activated 6 times outside of the vehicle and a sound is activated 1 time in the vehicle.

#### Vehicles without advanced keyless function

If the key is taken out of the vehicle while the vehicle power is switched to ACC or ON, and all the doors are closed, a sound is activated 1 time in the vehicle.

Make sure that you leave the vehicle while carrying the key, or switch the vehicle power OFF.

### Key Left-in-Vehicle Warning Sound

If all the doors and luggage compartment are locked using another key while the key is left in the cabin, the beep which sounds outside of the vehicle will be heard for about 10 seconds to notify the driver that the key is in the cabin. In this case, take out the key by opening the door. A key taken out of the vehicle using this method may not operate because its functions have been temporarily stopped. To restore the key's functions, perform the applicable procedure (page 8-8).

## Warning Sound is Activated

### Key Left-In-Luggage Compartment Warning Sound (Vehicles With Advanced Keyless Function)

If the key is left in the luggage compartment with all the doors locked and the liftgate closed, a beep will be heard outside for about 10 seconds to notify the driver that the key is in the luggage compartment. In this case, take out the key by pressing the electric liftgate opener and opening the liftgate.

The key taken out of the luggage compartment may not operate because its functions have been temporarily stopped. To restore the key's functions, perform the applicable procedure (page 8-8).

### Door Lock Inoperable Warning Sound

#### Operation Using Touch Sensor

A warning beep is activated to notify the driver that the doors are not locked when all of the following conditions are met:

- The vehicle power is switched OFF.
- All the doors are not fully closed.
- The lock is operated 3 times within 5 seconds.

Check the vehicle power and whether the doors are open or closed, and then operate the lock again.

#### Operation Using Door-lock Switch on the Liftgate

When the door-lock switch on the liftgate is pressed under any of the following conditions, a warning sound is activated.

- The vehicle power is switched to a position other than OFF.
- Any door is open.

Make sure that none of the above conditions are present, and then press the door-lock switch again.

## Warning Sound is Activated

---

### Power Liftgate Warning Sound\*

- A sound is activated 3 times when the power liftgate is operated and an object is stuck in the liftgate. Make sure that there is nothing stuck.
- If the vehicle is driven while the liftgate is open, a sound is activated for a while. Drive the vehicle with the liftgate closed.

### Brake System Warning Sound

A warning sound is activated if a problem with the brake system occurs and the brakes may not work as intended. Decelerate the vehicle while checking the safety of the surrounding area, and park the vehicle in a safe place. After stopping the vehicle, contact an Authorized Mazda Dealer.

## Warning Sound is Activated

---

### Electric Parking Brake (EPB) Warning Sound

The warning sound is activated under the following conditions:

- The vehicle is driven with the parking brake applied.
- The Electric Parking Brake (EPB) switch is pulled while the vehicle is driven.
- You attempt to start driving the vehicle while the conditions for releasing the Electric Parking Brake (EPB) automatically have not been met.

Check the condition of the parking brake.

### Reverse Position Warning Sound

The warning sound is activated when the vehicle power is switched ON and the selector lever is in the R position.

## Warning Sound is Activated

---

### Battery Saving Mode Warning Sound

A warning sound is activated when the vehicle goes into Battery Saving Mode. To charge the lead-acid battery, start the engine and keep running the engine for 5 minutes or longer.

## What to do when the vehicle is stuck

### **WARNING**

**Do not spin the wheels at more than 56 km/h (35 mph), and do not allow anyone to stand behind a wheel when pushing the vehicle:**

When the vehicle is stuck, spinning the wheels at high speed is dangerous. The spinning tire could overheat and explode. This could cause serious injuries.

### **CAUTION**

Too much rocking may cause engine overheating, transmission failure, and tire damage.

If you must rock the vehicle to free it from snow, sand or mud, depress the accelerator slightly and slowly move the selector lever from D to R position.



**Check Alexa settings**

Symptom	Cause	Solution method
<p>Streaming music cannot be played using Alexa.</p>	<p>Cannot communicate using the Wi-Fi client function.</p>	<p>Check the communication with the Wi-Fi client function using the following procedure.</p> <ol style="list-style-type: none"> <li>1. Select "Settings" from the Mazda Connect home screen.</li> <li>2. Select "Connectivity Settings".</li> <li>3. Select "Wi-Fi Client Settings".</li> <li>4. Make sure that "Wi-Fi Client Mode" is enabled.</li> <li>5. A Wi-Fi connection can be made with the device to be used from "Search for Available Wi-Fi Networks" or "Wi-Fi Protected Setup (WPS)".</li> </ol>
<p>Alexa does not respond when the talk/pick-up button is pressed.</p>	<p>You are not signed in to your Amazon account or "Push-To-Talk" is disabled.</p>	<p>Check whether you are signed in to your Amazon account using the following procedure.</p> <ol style="list-style-type: none"> <li>1. Select "Settings" from the Mazda Connect home screen.</li> <li>2. Select "Alexa Settings".</li> </ol> <p>If "Sign In" does not display on the screen, you are signed in. If "Sign In" is displayed on the screen, select "Sign In" and follow the instructions on the screen to sign in.</p> <p>Make sure that "Push-To-Talk" is enabled using the following procedure.</p> <ol style="list-style-type: none"> <li>1. Select "Settings" from the Mazda Connect home screen.</li> <li>2. Select "Alexa Settings".</li> <li>3. Select "Settings".</li> <li>4. Make sure that "Push-To-Talk" is enabled.</li> </ol>

Symptom	Cause	Solution method
<p>Alexa does not respond when you say "Alexa".</p>	<p>You are not signed in to your Amazon account or "Alexa Hands-Free" is disabled.</p>	<p>Check whether you are signed in to your Amazon account using the following procedure.</p> <ol style="list-style-type: none"> <li>1. Select "Settings" from the Mazda Connect home screen.</li> <li>2. Select "Alexa Settings".</li> </ol> <p>If "Sign In" does not display on the screen, you are signed in. If "Sign In" is displayed on the screen, select "Sign In" and follow the instructions on the screen to sign in.</p> <p>Make sure that "Alexa Hands-Free" is enabled using the following procedure.</p> <ol style="list-style-type: none"> <li>1. Select "Settings" from the Mazda Connect home screen.</li> <li>2. Select "Alexa Settings".</li> <li>3. Select "Settings".</li> <li>4. Make sure that "Alexa Hands-Free" is enabled.</li> </ol>

# MEMO

# 9

## Inspection and Servicing/Cleaning

<b>Inspection and Servicing.....</b>	<b>9-4</b>
Inspection and Servicing.....	9-4
<b>Scheduled Maintenance.....</b>	<b>9-6</b>
Scheduled Maintenance (U.S.A., Canada, and Puerto Rico).....	9-6
Scheduled Maintenance (Mexico).....	9-9
<b>Daily Inspection.....</b>	<b>9-12</b>
Daily Inspection.....	9-12
Warnings and Cautions for Daily Inspection.....	9-13
<b>Engine Compartment Inspection.....</b>	<b>9-14</b>
Checking the Inspection Locations and Inspection Items.....	9-14
Inspecting Engine Oil.....	9-18
Inspecting the Coolant.....	9-20
Inspecting the Brake Fluid.....	9-21
Replenishing Windshield Washer Fluid.....	9-23
Inspecting Lead-acid Battery.....	9-24
Replacing the Fuses.....	9-26
Inspecting Body Lubrication.....	9-27
<b>Vehicle Exterior Inspection.....</b>	<b>9-28</b>
Checking the Inspection Locations and Inspection Items.....	9-28
Replacing Windshield Wiper Blade Rubbers.....	9-28
Inspecting the Tires.....	9-32
Rotating the Tires.....	9-34
Replacing a Tire or a Wheel.....	9-35
Replacing Light Bulbs.....	9-36
<b>Vehicle Interior Inspection.....</b>	<b>9-37</b>
Checking the Inspection Locations and Inspection Items.....	9-37
Air Conditioner Maintenance.....	9-38
<b>Key Inspection.....</b>	<b>9-39</b>
Warnings and Cautions about Key Battery Replacement.....	9-39
How to Replace the Key Battery.....	9-39
<b>Exterior Maintenance.....</b>	<b>9-41</b>
Exterior Maintenance.....	9-41
Wheel Maintenance.....	9-42
<b>Interior Maintenance.....</b>	<b>9-43</b>
Interior Maintenance.....	9-43
Instrument Panel Top (Soft pad) Maintenance.....	9-44
Upholstery and Synthetic Leather Maintenance.....	9-44
Leather Upholstery Maintenance.....	9-45

---

Maintenance of the Dust-proof  
Sheet of the Active Driving  
Display.....9-46

Seat Belt Maintenance..... 9-46

# MEMO

## Inspection and Servicing

---

### Inspection and Servicing

Be careful not to hurt yourself when inspecting your vehicle, replacing a tire, or doing some kind of maintenance such as changing the oil and filter.

In particular, wear thick work gloves such as cotton gloves when touching areas that are difficult to see while inspecting or working on your vehicle. Doing inspections or procedures with your bare hands could cause injury.

If you are unsure about any procedure this manual describes, we strongly urge you to have a reliable and qualified service shop perform the work, preferably an Authorized Mazda Dealer.

Factory-trained Mazda technicians and genuine Mazda parts are best for your vehicle. Without this expertise and the parts that have been designed and made especially for your Mazda, inadequate, incomplete, and insufficient servicing may result in problems. This could lead to vehicle damage or an accident and injuries.

For expert advice and quality service, consult an Authorized Mazda Dealer.

To continue warranty eligibility and to protect your investment, it is your responsibility to properly maintain your vehicle according to factory recommended schedules outlined in this manual. As part of this you must keep your maintenance records, receipts, repair orders and any other documents as evidence this maintenance was performed. You must present these documents, should any warranty coverage disagreement occur.

Failure to do so can result in your warranty being voided either in whole or in part.

This evidence may consist of the following:

- The Mazda Scheduled Maintenance Record, refer to the Warranty Booklet, must be completely filled out showing mileage, repair order number, date for each service, and signed by a qualified automotive service technician who service vehicles.
- Original copies of repair orders or other receipts that include the mileage and date the vehicle was serviced. Each receipt should be signed by a qualified automotive service technician.
- For self maintenance, a statement that you completed the maintenance yourself, displaying mileage and the date the work was performed. Also, receipts for the replacement parts (fluid, filters, etc.) indicating the date and mileage must accompany this statement.

#### NOTE

If you elect to perform maintenance yourself or have your vehicle serviced at a location other than an Authorized Mazda Dealer, Mazda requires that all fluids, parts and materials must meet Mazda standards for durability and performance as described in this manual.

Claims against the warranty resulting from lack of maintenance, as opposed to defective materials or authorized Mazda workmanship, will not be honored.

Any auto repair shop using parts equivalent to your Mazda's original equipment may perform maintenance. But we recommend that it always be done by an Authorized Mazda Dealer using genuine Mazda parts. Selecting "Vehicle Status Monitor" enables the system to notify you of your vehicle's approaching inspection/servicing period. Refer to the Information section in the Mazda Connect Owner's Manual.



# Scheduled Maintenance

## Scheduled Maintenance (U.S.A., Canada, and Puerto Rico)

Vehicles utilizing the vehicle status monitor feature:

The vehicle status monitor feature alerts you of maintenance needs by turning on the wrench indicator light or displaying a message in the instrument panel, or both.

Every maintenance must be done when the display/wrench indication comes on.

The display/wrench indication will come on before reaching the maximum interval of 16,000 km (10,000 miles), or 12 months (after the previous maintenance).

If you drive your vehicle under any of the following conditions, follow the Severe Driving Scheduled Maintenance and replace the engine oil and filter every 8,000 km (5,000 miles) or 6 months, whichever comes first.

Otherwise, follow the Normal Driving Scheduled Maintenance intervals.

1. The vehicle is idled for long periods or driven at low speeds, such as with police cars, taxis, or driver's education school car.
2. The vehicle is driven mainly on unpaved road.
3. The vehicle is driven mainly on mountain roads or uphill roads.

If you are following the Severe Driving Scheduled Maintenance (8,000 km (5,000 miles) or 6 months oil replacement interval), set the vehicle status monitor manually. Refer to the Information section in the Mazda Connect Owner's Manual. Please contact an Authorized Mazda Dealer if necessary.

### USA, Canada and Puerto Rico Residents (Normal Driving Scheduled Maintenance):

Maintenance Item	Number of times, maintenance was performed.							
	1	2	3	4	5	6	7	8
Engine oil & filter <sup>*1</sup>	R	R	R	R	R	R	R	R
Spark plugs	Replace every 64,000 km (40,000 miles).							
Air filter			R			R		
Fuel lines & hoses <sup>*2</sup>		I		I		I		I
Hoses and tubes for emission <sup>*2</sup>				I				I
Drive belts	I	I	I	I	I	I	I	I
Exhaust system and heat shields				I				I
Coolant level	I	I	I	I	I	I	I	I
Coolant <sup>*3</sup>	Replace at first 192,000 km (120,000 miles) or 120 months; after that, every 96,000 km (60,000 miles) or 60 months.							
Brake lines, hoses and connections		I		I		I		I
Brake and clutch fluid level	I	I	I	I	I	I	I	I
Brake fluid		R		R		R		R
Disc brakes	I	I	I	I	I	I	I	I

Maintenance Item	Number of times, maintenance was performed.							
	1	2	3	4	5	6	7	8
Steering operation and linkages		I		I		I		I
Front and rear suspension, ball joints and wheel bearing axial play		I		I		I		I
Body condition inspection for rust, corrosion and perforation	Canada	I	I	I	I	I	I	I
Driveshaft dust boot		I		I		I		I
Bolts and nuts on chassis and body		T		T		T		T
Cabin air filter	Replace every 48,000 km (30,000 miles) or 24 months.							
Tire rotation	Rotate every 12,000 km (7,500 miles).							
Tire inflation pressure and tire wear <sup>*4</sup>	Inspect every 12,000 km (7,500 miles) or 12 months.							
Emergency flat tire repair kit (if equipped) <sup>*5</sup>	Inspect annually.							
Function of all lights	I	I	I	I	I	I	I	I

**Chart symbols:**

**I:** Inspect: Inspect and clean, repair, adjust, fill up, or replace if necessary.

**R:** Replace

**T:** Tighten

**Remarks:**

- \*1 Reset the engine oil data whenever replacing the engine oil regardless of the message/wrench indicator light display.
- \*2 According to state/provincial and federal regulations, failure to perform maintenance on these items will not void your emissions warranties. However, Mazda recommends that all maintenance services be performed at the recommended time or mileage/kilometer period to ensure long-term reliability.
- \*3 Use of FL-22 is recommended when replacing coolant. Using coolant other than FL-22 may cause serious damage to the engine and cooling system.
- \*4 Inspect a spare tire if equipped.
- \*5 Check the tire repair fluid expiration date every year when performing the periodic maintenance. Replace the tire repair fluid bottle with new one before the expiration date.

Inspection and Servicing/Cleaning  
**Scheduled Maintenance**

---

**USA, Canada and Puerto Rico Residents (Severe Driving Scheduled Maintenance):**

Number of months or kilometers (miles), whichever comes first.								
Months	6	12	18	24	30	36	42	48
× 1000 km	8	16	24	32	40	48	56	64
× 1000 miles	5	10	15	20	25	30	35	40
Engine oil & filter <sup>*1</sup>	R	R	R	R	R	R	R	R
Maintenance Interval (other than engine oil & filter replacement) <sup>*2</sup>		1st		2nd		3rd		4th

**Chart symbols:**

R: Replace

**Remarks:**

- \*1 Reset the engine oil data whenever replacing the engine oil regardless of the message/wrench indicator light display.
- \*2 Follow Maintenance Interval listed in Normal Driving Scheduled Maintenance.

## Scheduled Maintenance (Mexico)

Vehicles utilizing the vehicle status monitor feature:  
 The vehicle status monitor feature alerts you of maintenance needs by turning on the wrench indicator light or displaying a message in the instrument panel, or both. Every maintenance must be done when the display/wrench indication comes on. The display/wrench indication will come on before reaching the maximum interval of 10,000 km, or 6 months (after the previous maintenance).  
 If you drive your vehicle under any of the following conditions, follow the Severe Driving Scheduled Maintenance and replace the engine oil and filter every 5,000 km or 3 months, whichever comes first.

- Otherwise, follow the Normal Driving Scheduled Maintenance intervals.
1. The vehicle is idled for long periods or driven at low speeds, such as with police cars, taxis, or driver's education school car.
  2. Driving under dusty conditions.
  3. Driving for long periods in cold temperatures or driving regularly for short distances only.
  4. Driving under extremely high temperature conditions.
  5. Driving continuously in mountainous regions.

If you are following the Severe Driving Scheduled Maintenance (5,000 km or 3 months oil replacement interval), set the vehicle status monitor manually. Refer to the Information section in the Mazda Connect Owner's Manual. Please contact an Authorized Mazda Dealer if necessary.

### **Mexico Residents (Normal Driving Scheduled Maintenance):**

Maintenance Item	Number of times, maintenance was performed.							
	1	2	3	4	5	6	7	8
Engine oil & filter* <sup>1</sup>	R	R	R	R	R	R	R	R
Spark plugs	I	I	I	I	I	I	I	I
Replace every 64,000 km								
Air filter		R		R		R		R
Drive belts	I	I	I	I	I	I	I	I
Coolant level	I	I	I	I	I	I	I	I
Coolant* <sup>2</sup>	Replace at first 192,000 km or 120 months; after that, every 96,000 km or 60 months.							
Fuel lines & hoses* <sup>3</sup>				I				I
Hoses and tubes for emission* <sup>3</sup>				I				I
Fuel filter	Replace every 60,000 km.							
Brake lines, hoses and connections		I		I		I		I
Vacuum brake booster and hose		I		I		I		I
	With vacuum booster							

Inspection and Servicing/Cleaning  
**Scheduled Maintenance**

---

Maintenance Item	Number of times, maintenance was performed.							
	1	2	3	4	5	6	7	8
Brake and clutch fluid level	I	I	I		I	I	I	
Brake fluid				R				R
Disc brakes	I	I	I	I	I	I	I	I
Tire rotation	Rotate every 10,000 km.							
Tire inflation pressure and tire wear <sup>*4</sup>	I	I	I	I	I	I	I	I
Steering operation and linkages	I	I	I	I	I	I	I	I
Front and rear suspension, ball joints and wheel bearing axial play		I		I		I		I
Driveshaft dust boot		I		I		I		I
Bolts and nuts on chassis and body		T		T		T		T
Exhaust system and heat shields		I		I		I		I
Emergency flat tire repair kit (if equipped) <sup>*5</sup>	Inspect annually.							
Cabin air filter	Replace every 40,000 km or 24 months.							
Function of all lights	I	I	I	I	I	I	I	I

**Chart symbols:**

- I:** Inspect: Inspect and clean, repair, adjust, fill up, or replace if necessary.
- R:** Replace
- T:** Tighten

**Remarks:**

- \*1 Reset the engine oil data whenever replacing the engine oil regardless of the message/wrench indicator light display.
- \*2 Use of FL-22 is recommended when replacing coolant. Using coolant other than FL-22 may cause serious damage to the engine and cooling system.
- \*3 According to state/provincial and federal regulations, failure to perform maintenance on these items will not void your emissions warranties. However, Mazda recommends that all maintenance services be performed at the recommended time or mileage/kilometer period to ensure long-term reliability.
- \*4 Inspect a spare tire if equipped.
- \*5 Check the tire repair fluid expiration date every year when performing the periodic maintenance. Replace the tire repair fluid bottle with new one before the expiration date.

**Mexico Residents (Severe Driving Scheduled Maintenance):**

Number of months or kilometers , whichever comes first.								
Months	3	6	9	12	15	18	21	24
× 1000 km	5	10	15	20	25	30	35	40
Engine oil & filter* <sup>1</sup>	R	R	R	R	R	R	R	R
Maintenance Interval (other than engine oil & filter replacement)* <sup>2</sup>		1st		2nd		3rd		4th

**Chart symbols:**

**R:** Replace

**Remarks:**

- \*1 Reset the engine oil data whenever replacing the engine oil regardless of the message/wrench indicator light display.
- \*2 Follow Maintenance Interval listed in Normal Driving Scheduled Maintenance.

## Daily Inspection

---

### Daily Inspection

The owner or a qualified service technician should make these vehicle inspections at the indicated intervals to ensure safe and dependable operation.

Bring any problem to the attention of an Authorized Mazda Dealer or qualified service technician as soon as possible.

#### When Refueling

- Brake fluid level (page 9-21)
- Coolant level (page 9-20)
- Engine oil level (page 9-18)
- Washer fluid level (page 9-23)

#### At Least Monthly

- Tire inflation pressures (page 9-32)

#### At Least Twice a Year (For Example, Every Spring and Fall)

You can do the following scheduled maintenance items if you have some mechanical ability and a few basic tools and if you closely follow the directions in this manual.

- Coolant (page 9-20)
- Engine oil (page 9-18)

Improper or incomplete service may result in problems. This section gives instructions only for items that are easy to perform.

As explained in the Inspection and Servicing section (page 9-4), several procedures can be done only by a qualified service technician with special tools.

Improper owner maintenance during the warranty period may affect

warranty coverage. Refer to the Inspection and Servicing section (page 9-4) for owner's responsibility in protecting your investment. For details, read the separate Mazda Warranty statement provided with the vehicle. If you are unsure about any servicing or maintenance procedure, have it done by an Authorized Mazda Dealer.

There are strict environmental laws regarding the disposal of waste oil and fluids. Please dispose of your waste properly and with due regard to the environment.

We recommend that you entrust the oil and fluid changes of your vehicle to an Authorized Mazda Dealer.

## Warnings and Cautions for Daily Inspection

### **WARNING**

**Do not perform maintenance work if you lack sufficient knowledge and experience or the proper tools and equipment to do the work. Have maintenance work done by a qualified technician.**

Performing maintenance work on a vehicle is dangerous if not done properly. You can be seriously injured while performing some maintenance procedures.

**If you must run the engine while working under the hood, make certain that you remove all jewelry (especially rings, bracelets, watches, and necklaces) and all neckties, scarves, and similar loose clothing before getting near the cooling fan which may turn on unexpectedly.**

Working under the hood with the engine operating is dangerous. It becomes even more dangerous when you wear jewelry, loose clothing or have long hair or a long beard. Either can become entangled in moving parts and result in injury.



**Pull over to a safe location, then switch the vehicle power off and make sure the fan is not running before attempting to work near the cooling fan.**

Working near the cooling fan when it is running is dangerous. The fan could continue running indefinitely even if the engine has stopped and the engine compartment temperature is high. You could be hit by the fan and seriously injured.

### **Do not leave items in the motor compartment.**

After you have finished checking or doing servicing in the engine compartment, do not forget and leave items such as tools or rags in the motor compartment. Tools or other items left in the engine compartment could cause the engine damage or a fire leading to an unexpected accident.

### **CAUTION**

When using a chassis roller, turn the following systems off to prevent them from mis-operating while the vehicle is running on the chassis roller.

- Mazda Radar Cruise Control with Stop & Go function (MRCC with Stop & Go function)
- Cruising & Traffic Support (CTS)
- Smart Brake Support (SBS)



# Engine Compartment Inspection

## Checking the Inspection Locations and Inspection Items

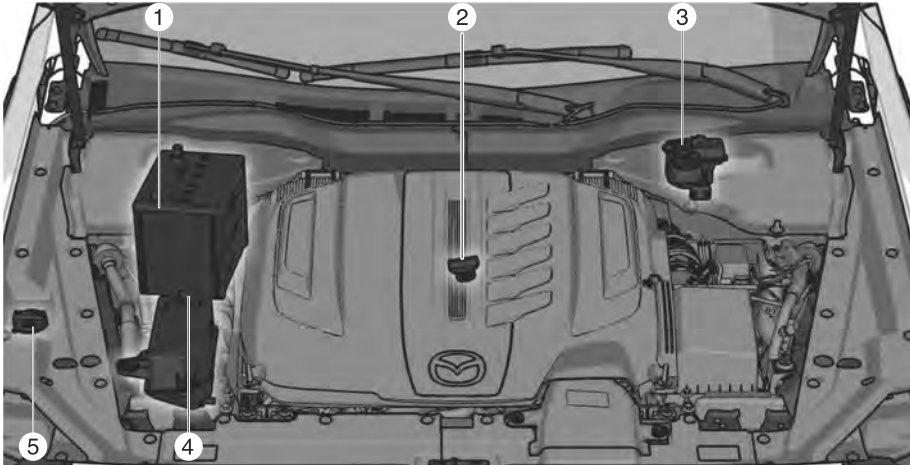

1. Lead-acid battery
2. Engine oil
3. Brake fluid
4. Coolant
5. Windshield washer fluid

### Opening the engine cover

1. Open the hood (page 4-26).
- 2.

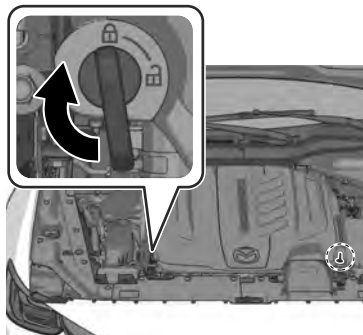

# Engine Compartment Inspection

3.

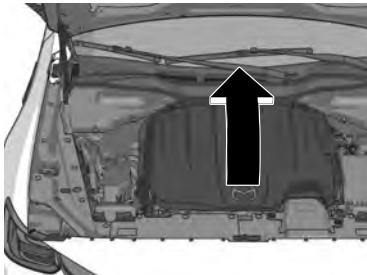

4.

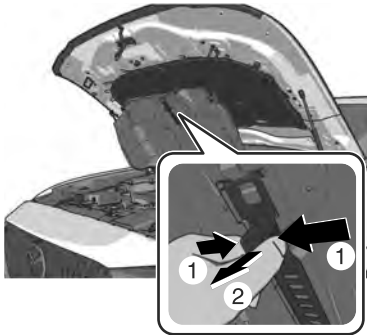

5.

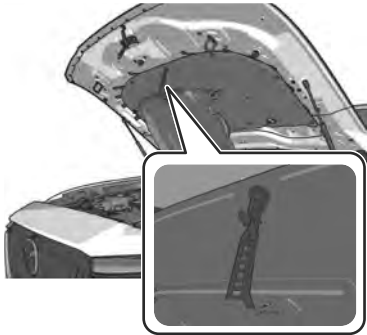

**! CAUTION**

Remove the strap when opening/closing the hood. If the hood is opened/closed while the strap is engaged, the strap or hook may be damaged.

## Engine Compartment Inspection

---

### Closing the engine cover

1.



2. Pinch the strap and press it in until a click sound is heard, and store.



3.

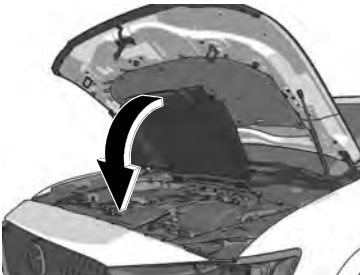

# Engine Compartment Inspection

---

4.

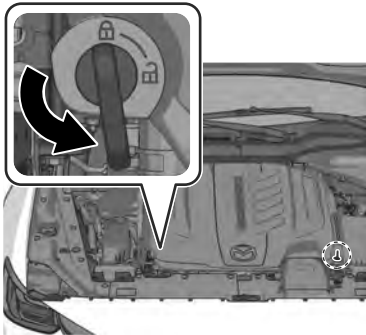

5. Make sure that the engine cover is securely closed.

## Inspecting Engine Oil



Do not overfill the engine oil. This may cause engine damage.

Use center display screen indication to inspect the engine oil level.

1. Make sure the hood is closed.
2. Start the engine.
3. Select "Information" on the Home screen to display the vehicle status monitor.
4. Select "Vehicle Status Monitor".
5. Select "Engine Oil Level".
6. Select "Start".

Measurement of the engine oil level begins. Do not depress the accelerator pedal during the measurement.

### NOTE

If measurement conditions not shown on the display are not met such as when warm-up operation has not been completed due to low outdoor temperatures, "Engine On: No" may be displayed even if the engine is running or the measurement error screen may be displayed after measurement starts. In this case, drive the vehicle for a certain period of time to complete the warm-up operation, stop the engine and leave it for about 10 minutes, and then perform the measurement procedure again.

7. Switch the vehicle power OFF.

### NOTE

After the measurement is completed, the engine does not stop automatically.

### Recommended Oil

#### **U.S.A., Canada**

#### **Use SAE 0W-20 engine oil.**

Mazda Genuine Oil is used in your Mazda vehicle. Mazda Genuine 0W-20 Oil is required to achieve optimum fuel economy. For maintenance service, Mazda recommends Genuine Mazda Parts and Genuine Mazda Premium Oil.



(ILSAC)

Only use SAE 0W-20 oil "Certified For Gasoline Engines" by the American Petroleum Institute (API). Oil with this trademark symbol conforms to the current engine and emission system protection standards and fuel economy requirements of the International Lubricant Standardization and Approval Committee (ILSAC),

# Engine Compartment Inspection

comprised of U.S. and Japanese automobile manufacturers.

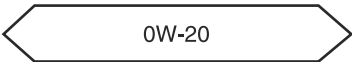
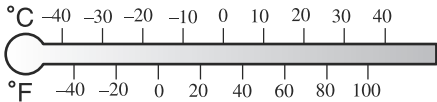

### Except U.S.A., Canada

#### Use SAE 5W-30 engine oil.

Oil container labels provide important information.

A chief contribution this type of oil makes to fuel economy is reducing the amount of fuel necessary to overcome engine friction.

For maintenance service, Mazda recommends Mazda Genuine Parts.



(ILSAC)

### (Mexico)

Use API SM or higher, SAE 5W-30 engine oil. If SAE 5W-30 engine oil is not available, use SAE 5W-20, SAE 0W-30 or SAE 10W-30 engine oil. The quality designation SM, SN or SP must be on the label.

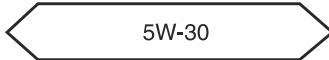
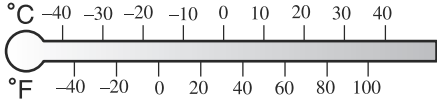

## Engine Compartment Inspection

### Inspecting the Coolant

#### **WARNING**

**Do not use a match or live flame in the engine compartment. DO NOT ADD COOLANT WHEN THE ENGINE IS HOT.**

A hot engine is dangerous. If the engine has been running, parts of the engine compartment can become very hot. You could be burned. Carefully inspect the engine coolant in the coolant reservoir, but do not open it.



**Do not touch rotating parts such as the fan belt when inspecting inside the engine compartment.**

Working near the cooling fan when it is running is dangerous. The fan could continue running indefinitely even if the engine has stopped and the engine compartment temperature is high. You could be hit by the fan and seriously injured.



**Do not remove either cooling system cap when the engine and radiator are hot.**

When the engine and radiator are hot, scalding coolant and steam may shoot out under pressure and cause serious injury.

#### **NOTE**

Changing the coolant should be done by an Authorized Mazda Dealer.

Inspect the antifreeze protection and coolant level in the coolant reservoir at least once a year—at the beginning of

the winter season—and before traveling where temperatures may drop below freezing.

Inspect the condition and connections of all cooling system and heater hoses. Replace any that are swollen or deteriorated.

The coolant should be at full in the radiator and between the FULL and LOW marks on the coolant reservoir when the engine is cool.

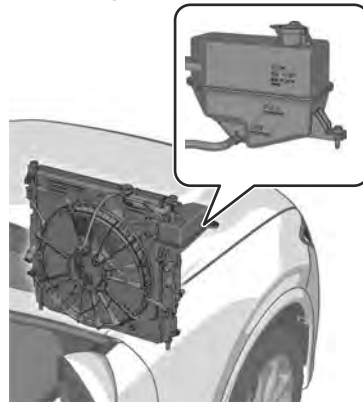

If it is at or near the LOW position, add enough coolant to the coolant reservoir to provide freezing and corrosion protection and to bring the level to FULL.

Securely tighten the coolant reservoir tank cap after adding coolant.

#### **CAUTION**

- Radiator coolant will damage paint. Rinse it off quickly if spilled.

# Engine Compartment Inspection

➤ If the “FL22” mark is shown on or near the cooling system cap, use of FL-22 is recommended when replacing engine coolant. Using engine coolant other than FL-22 may cause serious damage to the engine and cooling system.

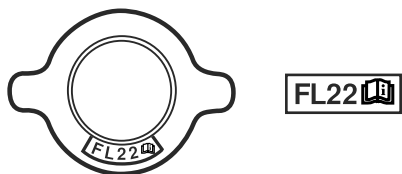

If the coolant reservoir is empty or new coolant is required frequently, consult an Authorized Mazda Dealer.

## Inspecting the Brake Fluid

### **⚠ WARNING**

**If the brake fluid level is low, have the brakes inspected.**

A low brake fluid level is dangerous. A low level could indicate brake lining wear or a brake system leak which could cause the brakes to fail and lead to an accident.

Inspect the fluid level in the reservoir regularly. It should be kept between the MAX and MIN lines.

The level normally drops with accumulated distance, a condition associated with wear of brake linings. If it is excessively low, have the brake system inspected by an Authorized Mazda Dealer.

Before inspecting the brake fluid, remove the hole cover.

### Removing the Hole Cover.

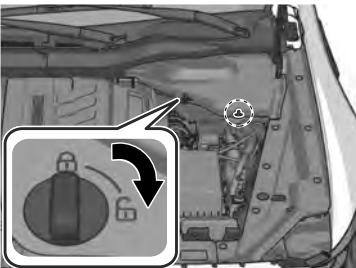
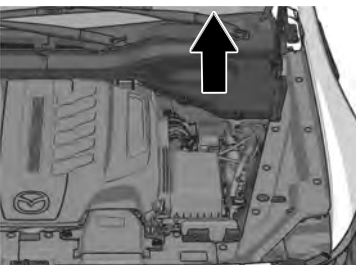
1. 
2. 



# Engine Compartment Inspection

---

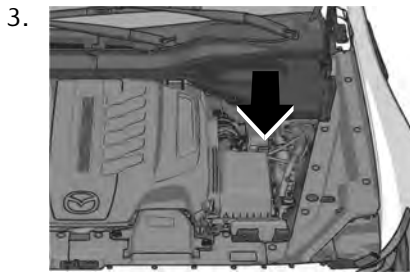

## Installing the Hole Cover.

1. Insert the hole cover into the cowl grille.  
Make sure that the hole cover holds the cowl grille and the knobs are in the correct position.

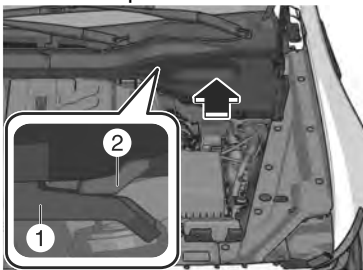

1. The hole cover
2. The cowl grille

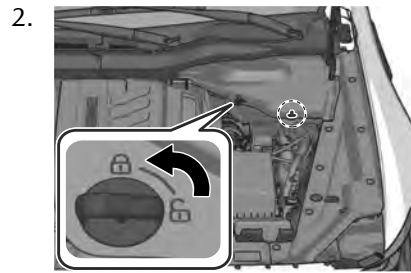

## Brake fluid reservoir

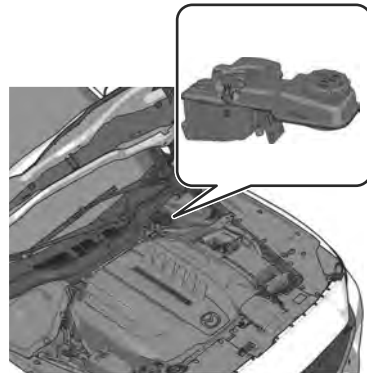

## Replenishing Windshield Washer Fluid

### WARNING

Use only windshield washer fluid or plain water in the reservoir.

Using radiator antifreeze as washer fluid is dangerous. If sprayed on the windshield, it will dirty the windshield, affect your visibility, and could result in an accident.

### Using Washer Fluid Without Anti-freeze Protection in Cold Weather:

Operating your vehicle in temperatures below 4 °C (40 °F) using washer fluid without anti-freeze protection is dangerous as it could cause impaired windshield vision and result in an accident. In cold weather, always use washer fluid with anti-freeze protection.

### CAUTION

Do not use soapy water or engine antifreeze in the reservoir as it could cause paint discoloration or pump damage.

### NOTE

- State or local regulations may restrict the use of volatile organic compounds (VOCs), which are commonly used as anti-freeze agents in washer fluid. A washer fluid with limited VOC content should be used only if it provides adequate freeze resistance for all regions and climates in which the vehicle will be operated.

- Replenish the washer fluid on a flat surface. If the vehicle is tilted, washer fluid may not fill sufficiently.

Add washer fluid under any of the following conditions.

- The top of the fluid level is low.
- The Low Washer Fluid Level Warning Indication/Warning Light (if equipped) turns on.
- The top of the fluid level is lower than L (if equipped).

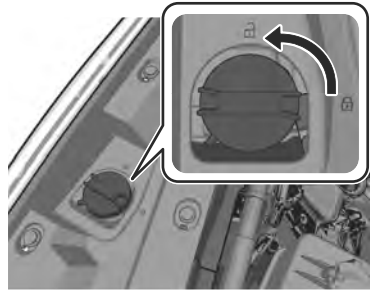

Use plain water if washer fluid is unavailable. But use only washer fluid in cold weather to prevent it from freezing.

# Engine Compartment Inspection

## Inspecting Lead-acid Battery

### **WARNING**



**Read the following precautions carefully before using the lead-acid battery or inspecting to ensure safe and correct handling.**



**Always wear eye protection when working near the lead-acid battery.**

Working without eye protection is dangerous. Lead-acid battery fluid contains SULFURIC ACID which could cause blindness if splashed into your eyes. Also, hydrogen gas produced during normal lead-acid battery operation, could ignite and cause the lead-acid battery to explode.



**Wear eye protection and protective gloves to prevent contact with lead-acid battery fluid.**

Spilled lead-acid battery fluid is dangerous. Lead-acid battery fluid contains SULFURIC ACID which could cause serious injuries if it gets in eyes, or on the skin or clothing. If this happens, immediately flush your eyes with water for 15 minutes or wash your skin thoroughly and get medical attention.



**Always keep lead-acid batteries out of the reach of children.** Allowing children to play near lead-acid batteries is dangerous. Lead-acid battery fluid could cause serious injuries if it gets in the eyes or on the skin.



**Keep flames and sparks away from lead-acid battery cells and do not allow metal tools to contact the positive (+) or negative (-) terminal of the lead-acid battery when working near a lead-acid battery. Do not allow the positive (+) terminal to contact the vehicle body.** Flames and sparks near lead-acid battery cells are dangerous. Hydrogen gas, produced during normal lead-acid battery operation, could ignite and cause the lead-acid battery to explode. An exploding lead-acid battery can cause serious burns and injuries. Keep all flames including cigarettes and sparks away from lead-acid battery cells.

# Engine Compartment Inspection



**Keep all flames and sparks away from lead-acid battery cells because hydrogen gas is produced from lead-acid battery cells while charging the lead-acid battery or adding lead-acid battery fluid.**

Flames and sparks near lead-acid battery cells are dangerous. Hydrogen gas, produced during normal lead-acid battery operation, could ignite and cause the lead-acid battery to explode. An exploding lead-acid battery can cause serious burns and injuries. Keep all flames including cigarettes and sparks away from lead-acid battery cells.

Before performing lead-acid battery maintenance, remove the hole cover and the lead-acid battery cover.

### Removing the Hole Cover

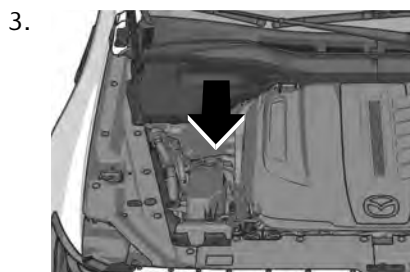
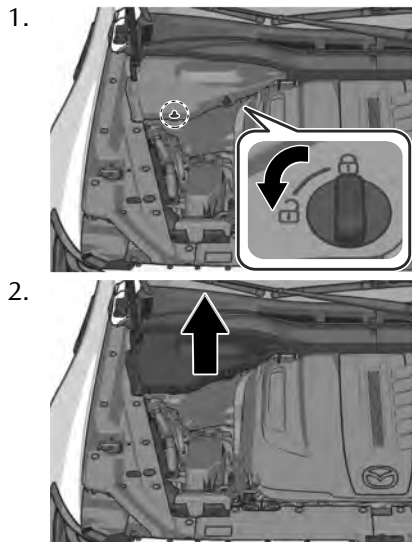

### Installing the Hole Cover

1. Insert the hole cover into the cowl grille. Make sure that the hole cover holds the cowl grille and the knobs are in the correct position.

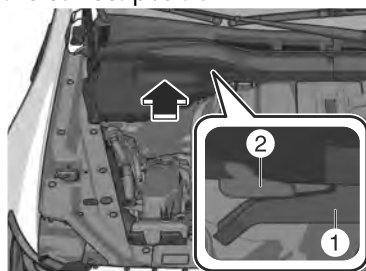

1. The hole cover
2. The cowl grille

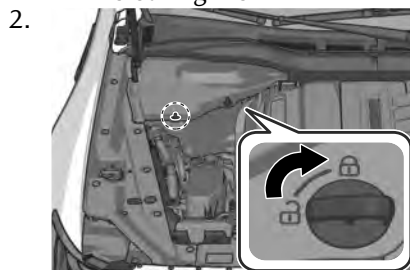

## Engine Compartment Inspection

---

### Removing the Lead-acid Battery Cover



### Maintaining Lead-acid Battery

To get the best service from a lead-acid battery:

- Keep it securely mounted.
- Keep the top clean and dry.
- Keep terminals and connections clean, tight, and coated with petroleum jelly or terminal grease.
- Rinse off spilled electrolyte immediately with a solution of water and baking soda.
- If the vehicle will not be used for an extended time, disconnect the lead-acid battery cables and charge the lead-acid battery every 6 weeks.

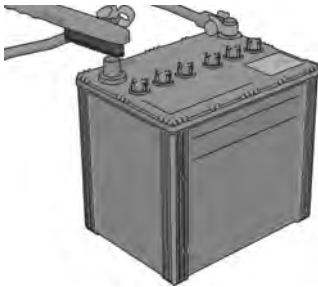

### Replacing lead-acid battery

Contact an Authorized Mazda Dealer for lead-acid battery replacement.

### Replacing the Fuses

Contact an Authorized Mazda Dealer for fuse replacement.

## Inspecting Body Lubrication

All moving points of the body, such as door and hood hinges and locks, should be lubricated each time the engine oil is changed. Use a non-freezing lubricant on locks during cold weather.

Make sure the hood's secondary latch keeps the hood from opening when the primary latch is released.

# Vehicle Exterior Inspection

## Checking the Inspection Locations and Inspection Items

Front

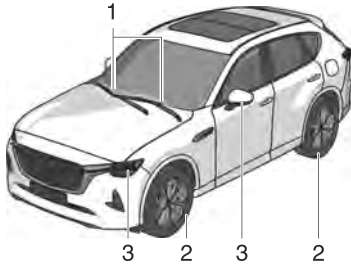

Rear

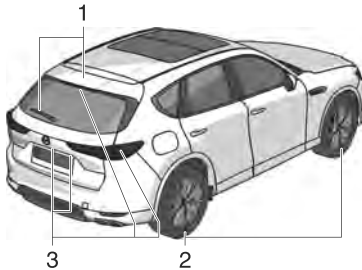

- 1. Windshield wipers
- 2. Tires
- 3. Light bulbs

## Replacing Windshield Wiper Blade Rubbers

### CAUTION

- Hot waxes applied by automatic car washers have been known to affect the wiper's ability to clean windows.
- An operation malfunction may occur or the wiper effectiveness may be reduced if a water-repellent coating is used.
- To prevent damage to the wiper blades, do not use gasoline, kerosene, paint thinner, or other solvents on or near them.
- When the wiper lever is in the AUTO position and the vehicle power is switched ON, the wipers may move automatically in the following cases:
  - If the windshield above the rain sensor is touched.
  - If the windshield above the rain sensor is wiped with a cloth.
  - If the windshield is struck with a hand or other object.
  - If the rain sensor is struck with a hand or other object from inside the vehicle.

Be careful not to pinch hands or fingers as it may cause injury, or damage the wipers. When washing or servicing the vehicle, make sure the wiper lever is in the OFF position.

- Before lifting the windshield wiper blades off the windshield, always follow the procedure for moving the windshield wiper blades. Otherwise, a wiper blade, wiper arm, or the hood could be damaged.

## Vehicle Exterior Inspection

Contamination of either the windshield or the blades with foreign matter can reduce wiper effectiveness. Common sources are insects, tree sap, and hot wax treatments used by some commercial car washes.

If the blades are not wiping properly, clean the window and blades with a good cleaner or mild detergent; then rinse thoroughly with clean water. Repeat if necessary.

### NOTE

You can replace the wiper blades yourself, however you cannot replace the wiper arms.

If you want to replace the wiper arms, consult an Authorized Mazda Dealer.

### Replacing Front Windshield Wiper Blade rubbers

1. Move the wipers to the service positions using the following procedure.
  - a) Switch the vehicle power ON.
  - b) Switch the vehicle power OFF.
  - c) Press up the wiper switch to the MIST position 2 times within 30 seconds after switching the vehicle power OFF. When the procedure is completed, the wipers operate and they stop at the service positions.
2. Raise the wiper arms.

3. Slide the blade component in the direction of the arrow while pressing the wiper arm tab to remove the blade component from the wiper arm.

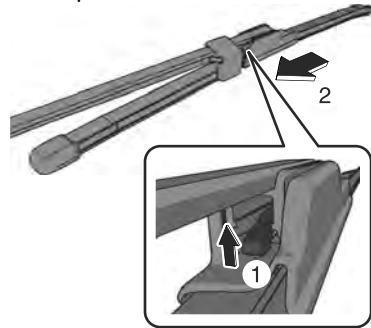

- 4.

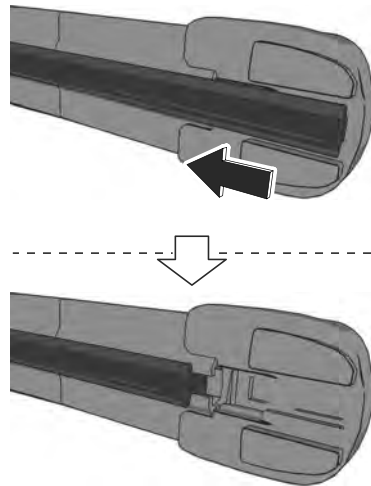



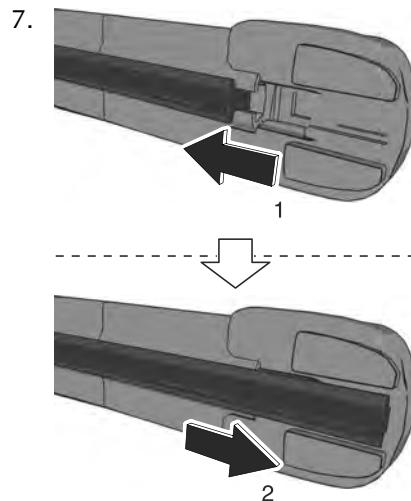
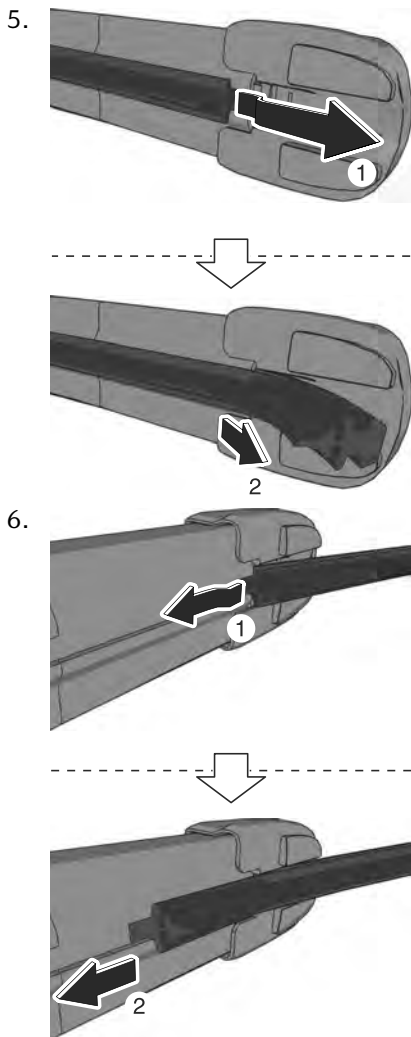

8. Make sure that the blade rubber is correctly installed to the blade holder.

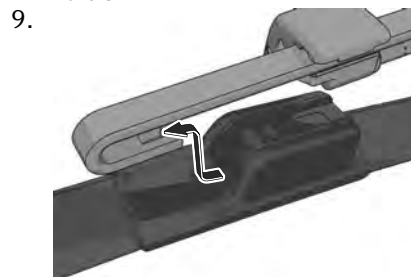

10. Slowly lower the wiper arms onto the windshield.

**⚠ CAUTION**

To prevent damage to the windshield let the wiper arm down easily, do not let it slap down on the windshield.

11. Move the wipers to their initial positions using the following procedure.
- a) Make sure that the wipers are set on the windshield.
  - b) Switch the vehicle power ON.

- c) Press up the wiper switch to the MIST position 2 times.

### Replacing Rear Windshield Wiper Blade rubber

#### **⚠ CAUTION**

To prevent damage to the wiper arm and other components, do not move the wiper by hand.

1. Open the cover.

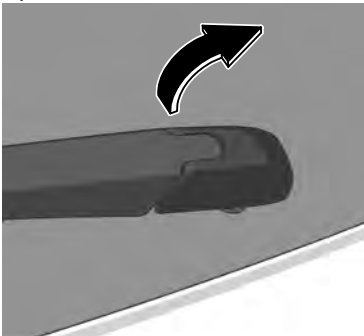

2. Raise the wiper arm and rotate the wiper blade to the right until it unlocks, then remove the blade.

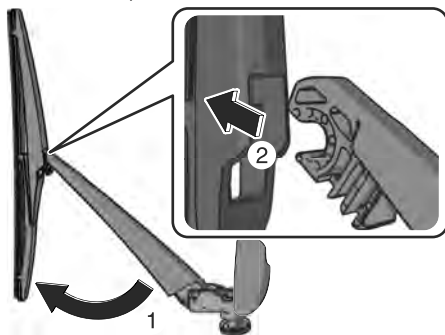

#### **⚠ CAUTION**

To prevent damage to the rear window, do not let the wiper arm fall on it.

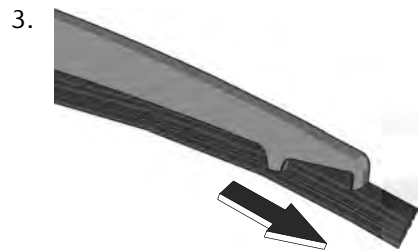

4. Remove the metal stiffeners from the blade rubber and install them in the new blade rubber.



#### **⚠ CAUTION**

Do not bend or discard the stiffeners. You need to use them again.

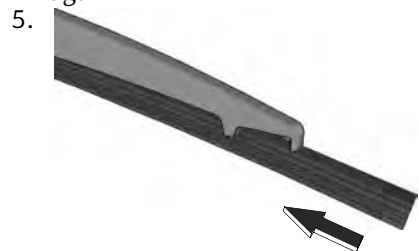

6. Install the blade assembly in the reverse order of removal.

## Inspecting the Tires

### About Tires

For reasons of proper performance, safety, and better fuel economy, always maintain recommended tire inflation pressures and stay within the recommended load limits and weight distribution.



### WARNING

**Do Not Use Tires Other Than The Specified Size. In Addition, Do Not Mix Different Types Of Tires.**

Using tires with sizes other than the specified size or mixing different tire types is dangerous. It could compromise the vehicle's driveability, resulting in an accident. In addition, it could be in violation of the law. Use the tire size indicated on the label applied to the door frame of the driver's door while the door is open. Use only the same type tires on all four wheels.

### Inspecting Tire Inflation Pressure



### WARNING

**Always inflate the tires to the correct pressure.**

Overinflation or underinflation of tires is dangerous. Adverse handling or unexpected tire failure could result in a serious accident.

Refer to Tires on page 10-69.

**Use only a Mazda-genuine tire valve cap.**

Use of a non-genuine part is dangerous as the correct tire air pressure cannot be maintained if the tire valve becomes damaged. If the vehicle is driven under this condition, the tire air pressure will decrease which could result in a serious accident. Do not use any part for the tire valve cap that is not a Mazda-genuine part.

Inspect all tire pressures monthly (including the spare) when the tires are cold. Maintain recommended pressures for the best ride, handling, and minimum tire wear. Refer to the specification charts (page 10-69).

### NOTE

- **Cold inflation pressure**

The cold inflation pressure is the pressure measured under ambient temperatures before the vehicle is driven.

- **Maximum inflation pressure**

The maximum inflation pressure is the upper limit of the cold inflation pressure designated by the tire manufacturer.

- **Recommended inflation pressure**

The recommended inflation pressure is the cold inflation pressure necessary for maintaining the performance of your Mazda.

- Underinflation or overinflation can cause a harsh ride, reduced fuel economy, a greater possibility of damage from road hazards, uneven and accelerated tire wear, and poor sealing of the tire bead, which will deform the wheel and cause separation of tire from rim.
- Keep your tire pressure at the correct levels. If one frequently needs inflating, have it inspected.

## Inspecting Temporary Spare Tire

Inspect the temporary spare tire at least monthly to make sure it is properly inflated and stored.



- Do not use your temporary spare tire rim with a snow tire or a conventional tire. Neither will properly fit and could damage both tire and rim.
- The temporary spare tire has a tread life of less than 5,000 km (3,000 miles). The tread life may be shorter depending on driving conditions.
- The temporary spare tire is for limited use, however, if the tread wear solid-band indicator appears, replace the tire with the same type of temporary spare (page 9-35).

The temporary spare tire is easier to handle because of its construction which is lighter and smaller than a conventional tire. This tire should be used only for an emergency and only for a short distance.

Use the temporary spare tire only until the conventional tire is repaired, which should be as soon as possible. Refer to Tires on page 10-69.

### NOTE

- The temporary spare tire condition gradually deteriorates even if it has not been used.

- Tires degrade over time, even when they are not being used on the road. It is recommended that tires generally be replaced when they are 6 years or older. Heat caused by hot climates or frequent high loading conditions can accelerate the aging process. The period in which the tire was manufactured (both week and year) is indicated by a 4-digit number. Refer to Tire Labeling on page 10-30.

## Vehicle Exterior Inspection

---

### Rotating the Tires

#### **! WARNING**

##### **Rotate tires periodically.**

Irregular tire wear is dangerous. To equalize tread wear for maintaining good performance in handling and braking, rotate the tires periodically or sooner if irregular wear develops. Please refer to Scheduled maintenance for your tire rotation interval.

During rotation, inspect them for correct balance.

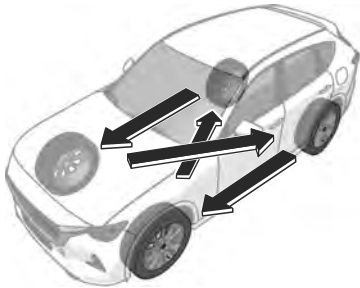

Do not include (TEMPORARY USE ONLY) spare tire in rotation. Also, inspect them for uneven wear and damage. Abnormal wear is usually caused by one or a combination of the following:

- Incorrect tire pressure
- Improper wheel alignment
- Out-of-balance wheel
- Severe braking

After rotation, inflate all tire pressures to specification (page 10-69) and inspect the lug nuts for tightness.

#### **! CAUTION**

Rotate unidirectional tires and radial tires that have an asymmetrical tread pattern or studs only from front to rear, not from side to side. Tire performance will be reduced if rotated from side to side.

## Replacing a Tire or a Wheel

### WARNING

**Always use tires that are in good condition.**

Driving with worn tires is dangerous. Reduced braking, steering, and traction could result in an accident.

**Replace all four tires at the same time.**

Replacing just one tire is dangerous. It could cause poor handling and poor braking resulting in loss of vehicle control. Mazda strongly recommends that you replace all four tires at the same time.

**Always use wheels of the correct size on your vehicle.**

Using a wrong-sized wheel is dangerous. Braking and handling could be affected, leading to loss of control and an accident.

### CAUTION

A wrong-sized wheel may adversely affect:

- Tire fit
- Wheel and bearing life
- Ground clearance
- Snow-chain clearance
- Speedometer calibration
- Headlight aim
- Bumper height
- Tire Pressure Monitoring System

If a tire wears evenly, a wear indicator will appear as a solid band across the tread.

Replace the tire when this happens.

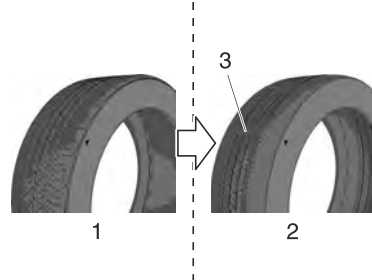

1. New tread
2. Worn tread
3. Tread wear indicator

You should replace the tire before the band crosses the entire tread.

### NOTE

Tires degrade over time, even when they are not being used on the road. It is recommended that tires generally be replaced when they are 6 years or older. Heat caused by hot climates or frequent high loading conditions can accelerate the aging process. The period in which the tire was manufactured (both week and year) is indicated by a 4-digit number. Refer to Tire Labeling on page 10-30.

## Replacing Light Bulbs

All the light bulbs are the LED type. The LED bulb cannot be replaced as a single unit because it is an integrated unit.

The LED bulb has to be replaced with the unit. If a replacement is necessary, consult an Authorized Mazda Dealer.

### Adjusting the Headlight Aim

If the headlight cannot be adjusted using procedure below, consult an Authorized Mazda Dealer.

1. Make sure the vehicle has a full tank of gasoline and the area around the headlight is not deformed.
2. Park the vehicle on level ground.
3. Sit in the driver's seat.
4. Bounce the vehicle several times.
5. Using a Phillips-head screw-driver, turn bolt A in either direction. Remember the turning direction and the number of turns.
6. Turn bolt B the same number of turns and in the same direction as step 5.

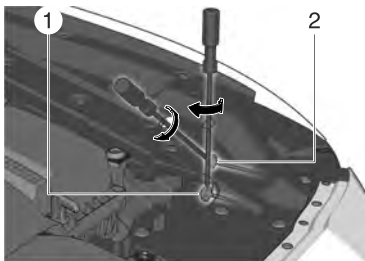

1. Adjustment bolt A
2. Adjustment bolt B

## Checking the Inspection Locations and Inspection Items



1. Air Conditioner



## Air Conditioner Maintenance

### Before Using the Air Conditioner

Lack of refrigerant may make the air conditioner less efficient. The refrigerant specifications are indicated on a label attached to the inside of the engine compartment. If the wrong type of refrigerant is used, it could result in a serious malfunction of the air conditioner. Consult a professional, government certified repairer for the inspection or repair because a special device is required for the air conditioner maintenance. For details, consult an Authorized Mazda Dealer.

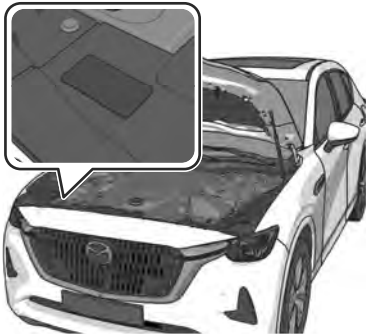

### Air filter

An air filter with pollen and dust collecting function is equipped. To ensure safe and comfortable use of the air conditioner, have the air filter replaced periodically. For details, consult an Authorized Mazda Dealer.

### **NOTE**

- If the airflow of the climate control system significantly decreases, the air filter may be clogged. Replace the air filter.

- If the vehicle is driven in areas with large amounts of dust and heavy traffic such as in large cities and cold regions, the air filter may need to be replaced more frequently.

## Warnings and Cautions about Key Battery Replacement

### CAUTION

- Make sure the battery is installed correctly. Battery leakage could occur if it is not installed correctly.
- When replacing the battery, be careful not to touch any of the internal circuitry and electrical terminals, bend the electrical terminals, or get dirt in the transmitter as the transmitter could be damaged.
- There is the danger of explosion if the battery is not correctly replaced.
- Dispose of used batteries according to the following instructions.
  - Insulate the plus and minus terminals of the battery using cellophane or equivalent tape.
  - Never disassemble.
  - Never throw the battery into fire or water.
  - Never deform or crush.
  - Replace only with the same type battery (CR2032 or equivalent).

## How to Replace the Key Battery

Replace with a new battery before the key becomes unusable.

The following conditions indicate that the battery power is low:

- The KEY indicator light (green) flashes in the instrument cluster.
- The system does not operate and the operation indicator light on the transmitter does not flash when the buttons are pressed.
- The system's operational range is reduced.

Incorrect battery replacement operation may damage the key. Replacing the battery at an Authorized Mazda Dealer is recommended.

If replacing the battery by yourself, heed the following instructions.

1. Remove the lower cover while pressing the knob in the direction of the arrow.



2. Press in the tab to unlock the upper cover.

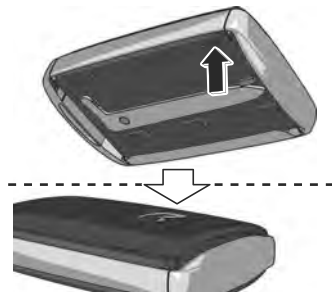

3. Insert a tape-wrapped flathead screwdriver into the gap and slide it.



4. Twist the flathead screwdriver and remove the upper cover.



5. Remove the cap using the tape-wrapped flathead screwdriver.



6. Remove the battery using the tape-wrapped flathead screwdriver.



7. Insert a new battery into the key so that the positive pole is facing up.

8. Install the cap.

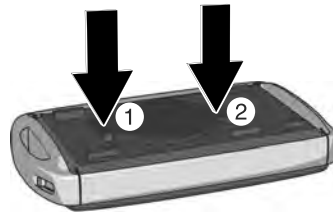

9. Install the upper cover.



10. Attach the lower cover so that its tabs are inserted into the slots of the key.



## Exterior Maintenance

### **WARNING**

**Dry off brakes that have become wet by driving slowly, releasing the accelerator pedal and lightly applying the brakes several times until the brake performance returns to normal.** Driving with wet brakes is dangerous. Increased stopping distance or the vehicle pulling to one side when braking could result in a serious accident. Light braking will indicate whether the brakes have been affected.

### **CAUTION**

- Before lifting the windshield wiper blades off the windshield, always follow the procedure for moving the windshield wiper blades. Otherwise, a wiper blade, wiper arm, or the hood could be damaged. Refer to the Replacing Windshield Wiper Blade Rubbers section (page 9-28) for the procedure on how to move the windshield wiper blades to the service position.
- When the vehicle power is switched ON and the wiper lever is in the AUTO position, the windshield wipers may operate automatically in the following cases:  
The area of the windshield above the rain sensor is touched or wiped with a cloth.  
The windshield or the rain sensor area in the cabin is hit.

When the vehicle power is switched ON and the wiper lever is in the AUTO position, do not touch the windshield or the windshield wipers. Otherwise, the windshield wipers will operate automatically which could catch your fingers or damage the windshield wipers.

When removing ice or snow, or cleaning the windshield, always make sure the wiper lever is in the OFF position.

- Do not spray water in the engine compartment. Otherwise, it could result in engine-starting problems or damage to electrical parts.
- When washing and waxing the vehicle, be careful not to apply excessive force to any single area of the vehicle roof. Otherwise, you could dent the vehicle.
- Make sure that the fuel-filler lid is closed and lock the doors. Otherwise, the fuel-filler lid may be forcefully opened by water pressure causing damage to the vehicle or fuel-filler lid.
- **(Vehicles with hands-free liftgate)** When washing or waxing the vehicle, turn off the hands-free liftgate using the Mazda Connect or do not bring the transmitter into the area around the liftgate. Otherwise, the liftgate could open unexpectedly resulting in an accident. Refer to Power Liftgate section (page 4-20).
- Do not use steel wool, abrasive cleaners, or strong detergents containing highly alkaline or caustic agents on chrome-plated or anodized aluminum parts. This may damage the protective coating; also, cleaners and detergents may discolor or deteriorate the paint.

## Exterior Maintenance

---

- If organic solvents such as gasoline, oil, engine coolant, or battery fluid, get on the exterior, wipe it off immediately.
- Do not use wax containing compounds, organic solvents such as gasoline or benzene, alcohols, acidic or alkaline detergents, or bleach for cleaning.

### Wheel Maintenance

 **CAUTION**

- If there is seawater or anti-freezing agent on the wheels, wash it off with water as soon as possible.
- Do not use any detergent other than mild detergent. Before using any detergent, verify the ingredients. Otherwise, the product could discolor or stain the aluminum wheels.

## Interior Maintenance

### **WARNING**

#### **Do not spray water into the vehicle cabin.**

Spraying water into the vehicle cabin is dangerous as electrical devices such as the audio and switches could get wet resulting in a malfunction or vehicle fire.

### **CAUTION**

- Do not use polishing agents. Depending on the product ingredients, they could cause discoloration, stains, cracks or peeling of the coating.
- Do not scrape or scratch the inside of the window glass. It could damage the thermal filaments and the antenna lines.
- When washing the inside of the window glass, use a soft cloth dampened in lukewarm water, gently wiping the thermal filaments and the antenna lines. Use of glass cleaning products could damage the thermal filaments and the antenna lines.
- If liquid such as fragrance is spilled on the interior, wipe it off immediately.
- Do not use wax containing compounds, organic solvents such as gasoline or benzene, alcohols, acidic or alkaline solvents, or bleach for cleaning.

- Do not try to rub the shiny surface panels and the metallic parts with a dry cloth. Additionally, wipe the instrument cluster lenses with a soft cloth (such as for glasses) and do not rub strongly. Otherwise, it may cause scratches.

### Instrument Panel Top (Soft pad) Maintenance

Dashboard maintenance for areas requiring further cleaning.

1. Wipe the soiled area with a soft cloth soaked in a mild detergent diluted with water.
2. Wipe off any detergent and water remaining on the surface using a cloth soaked in water and wrung out well.

### Upholstery and Synthetic Leather Maintenance

#### Fabric

1. Clean the soiled area by lightly dabbing it with a soft cloth soaked in a mild detergent (approx. 5 %) diluted with water.
2. Wipe off the remaining detergent using a cloth soaked in clean water and wrung out well.

#### Synthetic leather

1. Remove dust and sand using a vacuum cleaner.
2. Wipe the soiled area with a soft cloth soaked in a mild detergent (approx. 5 %) diluted with water.
3. Wipe off the remaining detergent using a cloth soaked in clean water and wrung out well.

## Leather Upholstery Maintenance

1. Remove dust and sand using a vacuum cleaner.
2. Wipe off the soiled area with a soft cloth and a suitable, special cleaner or a soft cloth soaked in a mild detergent (about 5 %) diluted with water.
3. Wipe off the remaining detergent using a cloth soaked in clean water and wrung out well.
4. Remove moisture with a dry, soft cloth and allow the leather to further dry in a well-ventilated, shaded area. If the leather gets wet such as from rain, remove the moisture and dry it as soon as possible.

### NOTE

- Because genuine leather is a natural material, its surface is not uniform and it may have natural scars, scratches, and wrinkles.
- To maintain the quality for as long as possible, periodical maintenance, about twice a year, is recommended.
- If the leather upholstery comes into contact with any of the following, clean it immediately.  
Leaving it uncleaned could cause premature wear, mold, or stains.
  - Sand or dirt
  - Grease or oil, such as hand cream
  - Alcohol, such as in cosmetic or hair dressing items
- If the leather upholstery gets wet, promptly remove moisture with a dry cloth. Remaining moisture on the surface may cause deterioration such as hardening and shrinkage.

- Exposure to direct sunlight for long periods may cause deterioration and shrinkage. When parking the car under direct sunlight for long periods, shade the interior using sunshades.
- Do not leave vinyl products on the leather upholstery for long periods. They may affect the leather quality and coloring. If the cabin temperature becomes hot, the vinyl may deteriorate and adhere to the genuine leather.



## Maintenance of the Dust-proof Sheet of the Active Driving Display

### CAUTION

Do not use detergent to clean the dust-proof sheet. In addition, if a chemical agent gets on the dust-proof sheet, wipe it off immediately. Otherwise, the coating may be damaged.

1. Wipe with a fine, soft cloth such as those used for cleaning eyeglasses.

## Seat Belt Maintenance

### WARNING

**If a seat belt appears frayed or has abrasions, have it replaced by an Authorized Mazda Dealer.**

If a seat belt is used under such a condition, it cannot function at its full capacity which could result in serious injury or death.

**Use a mild detergent to remove soiling from a seat belt.**

If organic solvents are used for cleaning the seat belts or they become stained or bleached, there is the possibility of them becoming weakened and as a result, they may not function at their full capacity which could cause serious injury or death.

**Do not disassemble, modify, or replace a seat belt.**

If a seat belt is used under such a condition, it cannot function at its full capacity which could result in serious injury or death.

**Always have your vehicle inspected by an Authorized Mazda Dealer if the vehicle has been involved in an accident.**

Seat belts with the pretensioner system and the seat belts with the load-limiter system cannot be reused once they have operated (deployed).

If a seat belt is used under such a condition, it cannot function at its full capacity which could result in serious injury or death.

**Always consult an Authorized Mazda Dealer when scrapping the vehicle.**

If the pretensioner system operates (deploys) unexpectedly, it could result in serious injury or death.

**Do not repair the pretensioner system parts or wiring harnesses and do not attempt to diagnose the pretensioner system circuits using an electrical tester or similar device.**

Otherwise, they may not function normally or they may operate incorrectly, which could result in serious injury or death.

Check periodically that the seat belt systems work properly and are not damaged.

**Seat belt cleaning procedure**

1. Lightly tap with a mild detergent to remove dirt.
2. Wipe with a thoroughly wrung cloth.
3. Allow to dry.
4. Make sure that the seat belt locks when it is pulled rapidly. If it is still not retracting properly, have it inspected at an Authorized Mazda Dealer.

**NOTE**

Clean seat belts diligently if they get dirty. Leaving them uncleaned will make it difficult to clean them later, and it may affect the smooth retracting of the seat belt.

# MEMO

# 10

## Specifications/Customer Information and Reporting Safety Defects

**Customer Assistance (U.S.A.)**.....  
..... **10-4**  
Customer Assistance..... 10-4  
STEP 1: Contact Your Mazda  
Dealer.....10-4  
STEP 2: Contact Mazda North  
American Operations..... 10-5  
STEP 3: Contact Better Business  
Bureau (BBB)..... 10-6  
California Customers..... 10-7

**Customer Assistance  
(Canada)**..... **10-9**  
Satisfaction Review  
Process..... 10-9  
STEP 1: Contact the Mazda  
Dealer.....10-9  
STEP 2: Contact the Mazda  
Regional Office..... 10-10  
STEP 3: Contact the Mazda  
Customer Relations  
Department..... 10-10  
Mediation/Arbitration  
Program..... 10-11  
Canadian Motor Vehicle  
Arbitration Plan (CAMVAP).....  
..... 10-11  
Regional Offices.....10-12

**Customer Assistance (Puerto  
Rico)**..... **10-13**  
Customer Assistance..... 10-13  
STEP 1.....10-13  
STEP 2.....10-14

**Customer Assistance (Mexico)** .....  
..... **10-15**  
Customer Assistance..... 10-15  
Contact Your Mazda  
Dealer.....10-15

**Mazda Importer/Distributors** .....  
..... **10-17**  
U.S.A..... 10-17  
CANADA..... 10-17  
PUERTO RICO/U.S. Virgin  
Island.....10-18  
MEXICO.....10-18  
GUAM..... 10-19  
SAIPAN..... 10-19  
AMERICAN SAMOA.....10-20

**Reporting Safety Defects**..... **10-21**  
Reporting Safety Defects  
(U.S.A.)..... 10-21  
Reporting Safety Defects  
(Canada).....10-22

**Warranty**..... **10-23**  
Warranties for Your Mazda .....  
..... 10-23  
Outside the United States/  
Canada..... 10-23  
Registering Your Vehicle in A  
Foreign Country (Except United  
States and Canada)..... 10-24  
Add-On Non-Genuine Parts and  
Accessories.....10-25

---

**Cell Phones..... 10-26**  
Cell Phones Warning..... 10-26

**Uniform Tire Quality Grading System (UTQGS)..... 10-27**  
Uniform Tire Quality Grading System (UTQGS)..... 10-27  
Tread Wear..... 10-27  
Traction-AA, A, B, C..... 10-28  
Temperature-A, B, C..... 10-28  
UNIFORM TIRE QUALITY GRADING..... 10-29

**Tire Information (U.S.A.)..... 10-30**  
Tire Labeling..... 10-30  
Information on Passenger Vehicle Tires..... 10-30  
Information on Temporary Tires..... 10-33  
Location of the Tire Label (Placard)..... 10-34  
Recommended Tire Inflation Pressure..... 10-34  
Checking Tire Pressure..... 10-35  
Glossary of Terms..... 10-36  
Tire Maintenance..... 10-37  
Tire Inflation Pressure..... 10-37  
Tire Rotation..... 10-38  
Replacing a Tire..... 10-38  
Safety Practices..... 10-39  
Vehicle Loading..... 10-40  
Steps for Determining the Correct Load Limit..... 10-45

**Declaration of Conformity..... 10-46**  
Keyless Entry System/Immobilizer System..... 10-46

HomeLink Wireless Control System..... 10-47  
Tire Pressure Monitoring System..... 10-48  
Front Radar Sensor System..... 10-49  
Front Side Radar Sensor System/Rear Side Radar Sensor System..... 10-50  
Audio System..... 10-51  
Radio System..... 10-53  
Data Communication System..... 10-54  
Wireless Charger (Qi)..... 10-57

**Identification Numbers..... 10-58**  
Vehicle Identification Number..... 10-58  
Motor Vehicle Safety Standard Label (U.S.A. and Canada) ..... 10-58  
Vehicle Emission Control Information Label (U.S.A. and Canada)..... 10-59  
Tire Pressure Label..... 10-59  
Engine Number..... 10-60

**Vehicle Specification..... 10-61**  
Engine..... 10-61  
M Hybrid Battery..... 10-62  
Electrical System..... 10-63  
Lubricant Quality..... 10-64  
Capacities..... 10-65  
Dimensions..... 10-66  
Weights..... 10-67  
Light Bulbs..... 10-68  
Tires..... 10-69

# MEMO

## Customer Assistance

Your complete and permanent satisfaction is our business. We are here to serve you. All Authorized Mazda Dealers have the knowledge and the tools to keep your Mazda vehicle in top condition.

If you have any questions or recommendations for improvement regarding the service of your Mazda vehicle or servicing by Mazda Dealer personnel, we recommend that you take the following steps:

### **NOTE**

If it becomes necessary to have the components or wiring system for the supplementary restraint system modified to accommodate a person with certain medical conditions in accordance with a certified physician, contact an Authorized Mazda Dealer. For more information, go to NHTSA website [www.safercar.gov](http://www.safercar.gov) (VEHICLE SHOPPERS > Air Bags > Air Bag FAQs > Air Bag Deactivation).

## STEP 1: Contact Your Mazda Dealer

Discuss the matter with an Authorized Mazda Dealer. This is the quickest and best way to address the issue.

- If your concern has not been resolved by the CUSTOMER RELATIONS, SALES, SERVICE, or PARTS MANAGER, then please contact the GENERAL MANAGER of the dealership or the OWNER.
- If it becomes necessary to have the components or wiring system for the supplementary restraint system modified to accommodate a person with certain medical conditions in accordance with a certified physician, go to STEP 2.

## **STEP 2: Contact Mazda North American Operations**

If for any reason you feel the need for further assistance after contacting your dealership management or it becomes necessary to have the components or wiring system for the supplementary restraint system modified to accommodate a person with certain medical conditions in accordance with a certified physician, you can reach Mazda North American Operations by one of the following ways.

Log on: at [www.MazdaUSA.com](http://www.MazdaUSA.com)

Answers to many questions, including how to locate or contact a local Mazda dealership in the U.S., can be found here.

E-mail: click on "Contact Us" located on the bottom of the page at [www.mazdausa.com](http://www.mazdausa.com) under "Help"

By phone at: 1 (800) 222-5500

By letter at:  
ATTN: Customer Experience Center  
Mazda North American Operations  
200 Spectrum Center Drive Suite 100  
Irvine, California 92618  
P.O. Box 19734  
Irvine, CA 92623-9734

In order to serve you efficiently and effectively, please help us by providing the following information:

1. Your name, address, and telephone number
2. Year and model of vehicle
3. Vehicle Identification Number (17 digits, noted on your registration or

title or located on the upper driver's side corner of the dash)

4. Purchase date and current mileage
5. Your dealer's name and location
6. Your question(s)

If you live outside the U.S.A., please contact your nearest Mazda Distributor.



## Customer Assistance (U.S.A.)

---

### STEP 3: Contact Better Business Bureau (BBB)

Mazda North American Operations realizes that mutual agreement on some issues may not be possible. As a final step to ensure that your concerns are being fairly considered, Mazda North American Operations has agreed to participate in a dispute settlement program administered by the Better Business Bureau (BBB) system, at no cost to you the consumer.

BBB AUTO LINE works with consumers and the manufacturer in an attempt to reach a mutually acceptable resolution of any warranty related concerns. If the BBB is not able to facilitate a settlement they will provide an informal hearing before an arbitrator.

You are required to resort to BBB AUTO LINE before exercising rights or seeking remedies under the Federal Magnuson-Moss Warranty Act, 15 U.S.C. § 2301 et seq. To the extent permitted by the applicable state "Lemon Law", you are also required to resort to BBB AUTO LINE before exercising any rights or seeking remedies under the "Lemon Law". If you choose to seek remedies that are not created by the Magnuson-Moss Warranty Act or the applicable state "Lemon Law", you are not required to first use BBB AUTO LINE.

The whole process normally takes 40 days or less. The arbitration decision is not binding on you or Mazda unless you accept the decision. For more information about BBB AUTO LINE, including current eligibility standards, please call 1-800-955-5100 or visit

the BBB website at [www.bbb.org/autoline](http://www.bbb.org/autoline).

Being truly committed to customer satisfaction is more than a phrase with Mazda. We hope to satisfy every customer directly, but if there is ever a question about our decision, Mazda believes in providing a fast, fair and free method such as the BBB AUTO LINE to ensure Mazda delivers on our commitment to do the right thing for our customers!

## California Customers

1. Mazda North American Operations participates in a mediation/arbitration program administered by BBB AUTO LINE, a Division of BBB National Programs, Inc. [1676 International Drive, Suite 550 McLean, Virginia 22102] through local Better Business Bureaus. BBB AUTO LINE and Mazda have been certified by the Arbitration Certification Program of the California Department of Consumer Affairs.
2. If you have a problem arising under a Mazda written warranty, we encourage you to bring it to our attention. If we are unable to resolve it, you may file a claim with BBB AUTO LINE. Claims must be filed with BBB AUTO LINE within six (6) months after the expiration of the warranty.
3. To file a claim with BBB AUTO LINE, call 1-800-955-5100. There is no charge for the call.
4. In order to file a claim with BBB AUTO LINE, you will have to provide your name and address, the brand name and vehicle identification number (VIN) of your vehicle, and a statement of the nature of your problem or complaint. You will also be asked to provide: the approximate date of your acquisition of the vehicle, the vehicle's current mileage, the approximate date and mileage at the time any problem(s) were first brought to the attention of Mazda or one of our dealers, and a statement of the relief you are seeking.
5. BBB AUTO LINE staff may try to help resolve your dispute through mediation. If mediation is not successful, or if you do not wish to participate in mediation, claims within the program's jurisdiction may be presented to an arbitrator at an informal hearing. The arbitrator's decision should ordinarily be issued within 40 days from the time your complaint is filed; there may be a delay of 7 days if you did not first contact Mazda about your problem, or a delay of up to 30 days if the arbitrator requests an inspection/report by an impartial technical expert or further investigation and report by BBB AUTO LINE.
6. You are required to use BBB AUTO LINE before asserting in court any rights or remedies conferred by California Civil Code Section 1793.22. You are also required to use BBB AUTO LINE before exercising rights or seeking remedies created by Title I of the Magnuson-Moss Warranty Act, 15 U.S.C. sec. 2301 et seq. If you choose to seek redress by pursuing rights and remedies not created by California Civil Code Section 1793.22 or Title I of the Magnuson-Moss Warranty Act, resort to BBB AUTO LINE is not required by those statutes.
7. California Civil Code Section 1793.2 (d) requires that, if Mazda or its representative is unable to repair a new motor vehicle to conform to the vehicle's applicable express warranty after a reasonable number of attempts, Mazda may be required to replace or repurchase the vehicle. California Civil Code Section 1793.22 (b) creates a presumption that Mazda has had a reasonable number of attempts to

## Customer Assistance (U.S.A.)

---

conform the vehicle to its applicable express warranties if, within 18 months from delivery to the buyer or 18,000 miles on the vehicle's odometer, whichever occurs first, one or more of the following occurs:

- The same nonconformity [a failure to conform to the written warranty that substantially impairs the use, value or safety of the vehicle] results in a condition that is likely to cause death or serious bodily injury if the vehicle is driven **AND** the nonconformity has been subject to repair two or more times by Mazda or its agents **AND** the buyer or lessee has directly notified Mazda of the need for the repair of the nonconformity; OR
- The same nonconformity has been subject to repair 4 or more times by Mazda or its agents **AND** the buyer has notified Mazda of the need for the repair of the nonconformity; OR
- The vehicle is out of service by reason of repair of nonconformities by Mazda or its agents for a cumulative total of more than 30 calendar days after delivery of the vehicle to the buyer.

**NOTICE TO Mazda AS REQUIRED ABOVE SHALL BE SENT TO THE FOLLOWING ADDRESS:**

Mazda North American Operations  
200 Spectrum Center Drive Suite  
100  
Irvine, California 92618  
ATTN: Customer Mediation

8. The following remedies may be sought in BBB AUTO LINE: repairs,

reimbursement for money paid to repair a vehicle or other expenses incurred as result of a vehicle nonconformity, repurchase or replacement of your vehicle, and compensation for damages and remedies available under Mazda's written warranty or applicable law.

9. The following remedies may **not** be sought in BBB AUTO LINE: punitive or multiple damages, attorneys' fees, or consequential damages other than as provided in California Civil Code Section 1794 (a) and (b).
10. You may reject the decision issued by a BBB AUTO LINE arbitrator. If you reject the decision, you will be free to pursue further legal action. The arbitrator's decision and any findings will be admissible in a court action.
11. If you accept the arbitrator's decision, Mazda will be bound by the decision, and will comply with the decision within a reasonable time not to exceed 30 days after we receive notice of your acceptance of the decision.
12. Please call BBB AUTO LINE at 1-800-955-5100 for further details about the program.

## **Satisfaction Review Process**

Your complete and permanent satisfaction is of primary concern to Mazda. All Authorized Mazda Dealers have both the knowledge and tools to keep your Mazda in top condition. In our experience, any questions, problems, or complaints regarding the operation of your Mazda or any other general service transactions are most effectively resolved by your dealer. If the cause of your dissatisfaction cannot adequately be addressed by normal dealership procedures, we recommend that you take the following steps:

## **STEP 1: Contact the Mazda Dealer**

Discuss the matter with a member of dealership management. If the Service Manager has already reviewed your concerns, contact the owner of the dealership or its General Manager.

## **STEP 2: Contact the Mazda Regional Office**

If you feel that you still require assistance, ask the dealer Service Manager to arrange for you to meet the local Mazda Service Representative. If more expedient, contact Mazda Canada Inc. Regional Office nearest you for such arrangements. Regional Office address and phone numbers are shown (page 10-12).

## **STEP 3: Contact the Mazda Customer Relations Department**

If still not substantially satisfied, contact the Customer Relations Department, Mazda Canada Inc., 55 Vogell Road, Richmond Hill, Ontario, L4B 3K5 Canada TEL: 1 (800) 263-4680.

Provide the Department with the following information:

1. Your name, address and telephone number
2. Year and model of vehicle
3. Vehicle Identification Number (VIN). Refer to the Vehicle Identification Number on page 10-58 for the location of the VIN.
4. Purchase date
5. Present odometer reading
6. Your dealer's name and location
7. The nature of your problem and/or cause of dissatisfaction

The Department, in cooperation with the local Mazda Service Representative, will review the case to determine if everything possible has been done to ensure your satisfaction.

Please recognize that the resolution of service problems in most cases requires the use of your Mazda dealer's service facilities, personnel and equipment. We urge you to follow the above three steps in sequence for most effective results.

## Mediation/Arbitration Program

Occasionally a customer concern cannot be resolved through Mazda's Customer Satisfaction Program. If after exhausting the procedures in this manual your concern is still not resolved, you have another option.

Mazda Canada Inc. participates in an arbitration program administered by the Canadian Motor Vehicle Arbitration Plan (CAMVAP). CAMVAP will advise you about how your concern may be reviewed and resolved by an independent third party through binding arbitration.

Your complete satisfaction is the goal of Mazda Canada Inc. and our dealers. Mazda's participation in CAMVAP makes a valuable contribution to our achieving that goal. There is no charge for using CAMVAP. CAMVAP results are fast, fair and final as the award is binding on both you and Mazda Canada Inc.

## Canadian Motor Vehicle Arbitration Plan (CAMVAP)

If a specific item of concern arises, where a solution cannot be reached between an owner, Mazda, and/or one of its dealers (that all parties cannot agree upon), the owner may wish to use the services offered by the Canadian Motor Vehicle Arbitration Plan (CAMVAP).

CAMVAP uses the services of Provincial Administrators to assist consumers in scheduling and preparing for their arbitration hearings. However, before you can proceed with CAMVAP you must follow your Mazda dispute resolution process as outlined previously.

CAMVAP is fully implemented in all provinces and territories. Consumers wishing to obtain further information about the Program should contact the Provincial Administrator at 1 (800) 207-0685, or by contacting the Canadian Motor Vehicle Arbitration Plan Office at:

Canadian Motor Vehicle Arbitration Plan  
235 Yorkland Boulevard, suite 300  
North York, Ontario  
M2J 4Y8  
<http://camvap.ca>  
Provincial Administrators may be reached locally:

Province/Territory	CAMVAP Number
British Columbia & Yukon Territories	1 (800) 207-0685
Alberta & Northwest Territories	1 (800) 207-0685

## Customer Assistance (Canada)

Province/Territory	CAMVAP Number
Saskatchewan	1 (800) 207-0685
Manitoba	1 (800) 207-0685
Ontario	1 (800) 207-0685
Atlantic Canada	1 (800) 207-0685
Quebec	1 (800) 207-0685

## Regional Offices

REGIONAL OFFICES	COVERING AREAS
MAZDA CANADA INC. WESTERN REGION 5011 275 STREET LANGLEY, BRITISH COLUMBIA V4W 0A8 (778) 369-2100	ALBERTA, BRITISH COLUMBIA, MANITOBA, SASKATCHEWAN, YUKON
MAZDA CANADA INC. CENTRAL REGION 55 VOGELL ROAD, RICHMOND HILL, ONTARIO, L4B 3K5 1 (800) 263-4680	ONTARIO, NEW BRUNSWICK, NOVA SCOTIA, PRINCE EDWARD IS- LAND, NEWFOUNDLAND
MAZDA CANADA INC. QUEBEC REGION 6111 ROUTE TRANS- CANADIENNE POINTE CLAIRE, QUE- BEC H9R 5A5	QUEBEC

## Customer Assistance

Your complete and permanent satisfaction is our business. That is why all Authorized Mazda Dealers have the knowledge and the tools to keep your Mazda vehicle in top condition.

If you have any questions or recommendations for improvement regarding the service of your Mazda vehicle or servicing by Mazda Dealer personnel, we recommend that you take the following steps:

## STEP 1

Discuss the matter with an Authorized Mazda Dealer. This is the quickest and best way to address the issue. If your concern has not been resolved by the CUSTOMER RELATIONS, SALES, SERVICE, or PARTS MANAGER, then please contact the GENERAL MANAGER of the dealership or the OWNER.



## STEP 2

If, after following STEP 1, you feel the need for further assistance, please contact your area's Mazda representative.

Refer to PUERTO RICO/U.S. Virgin Island on page 10-18.

Please help us by providing the following information:

1. Your name, address, and telephone number
2. Year and model of vehicle
3. Vehicle Identification Number (17 digits, noted on your registration or title or located on the upper driver's side corner of the dash)
4. Purchase date and current mileage
5. Your dealer's name and location
6. Your question(s)

### Customer Assistance

Your complete and permanent satisfaction is our business. We are here to serve you. All Authorized Mazda Dealers have the knowledge and the tools to keep your Mazda vehicle in top condition.

If you have any questions or recommendations for improvement regarding the service of your Mazda vehicle or servicing by Mazda Dealer personnel, we recommend that you take the following steps:

### Contact Your Mazda Dealer

Discuss the matter with an Authorized Mazda Dealer. This is the quickest and best way to address the issue.

- If your concern has not been resolved by the CUSTOMER RELATIONS, SALES, SERVICE, or PARTS MANAGER, then please contact the GENERAL MANAGER of the dealership or the OWNER.
- If it becomes necessary to have the components or wiring system for the supplementary restraint system modified to accommodate a person with certain medical condition in accordance with a certified physician you must contact your dealership in order to avoid the potential loss of the warranty of your vehicle which may occur if some third party is hired by the customer to make any modifications to this system.

Log on: at  
[www.mazdamexico.com.mx](http://www.mazdamexico.com.mx)

Answers to many questions, including how to locate or contact a local Mazda dealership in Mexico, can be found here.

E-mail: click on "Contactanos" at the top of the page at  
[www.mazdamexico.com.mx](http://www.mazdamexico.com.mx)

By phone at: 01 800 01 MAZDA  
(62932)

## Customer Assistance (Mexico)

---

By letter at:

Attn: Customer Assistance  
Mazda Motor de Mexico  
Mario Pani 400 PB, Col. Santa Fe  
Cuajimalpa, Delegación Cuajimalpa  
de Morelos, Ciudad de México, CP  
05348  
Tel: Customer Assistance  
01 800 01 MAZDA(62932).

In order to serve you efficiently and effectively, please help us by providing the following information:

1. Your name, address, and telephone number
2. Year and model of vehicle
3. Vehicle Identification Number (17 digits, noted on your registration or title or located on the upper driver's side corner of the dash)
4. Purchase date and current mileage
5. Your dealer's name and location
6. Your question(s)

## Mazda Importer/Distributors

---

### U.S.A.

**Mazda North American Operations**  
200 Spectrum Center Drive Suite 100  
Irvine, California 92618  
P.O. Box 19734  
Irvine, CA 92623-9734 U.S.A.  
TEL: 1 (800) 222-5500 (in U.S.A.)  
(949) 727-1990 (outside U.S.A.)

### CANADA

**Mazda Canada Inc.**  
55 Vogell Road, Richmond Hill,  
Ontario, L4B 3K5 Canada

## Mazda Importer/Distributors

---

### PUERTO RICO/U.S. Virgin Island

**International Automotive Distributor  
Group, LLC. (Mazda de Puerto Rico)**  
P.O. Box 191850, San Juan, Puerto  
Rico 00919-1850  
TEL: (787) 641-1777

### MEXICO

**Mazda Motor de Mexico**  
Mario Pani 400 PB, Col. Santa Fe  
Cuajimalpa, Delegación Cuajimalpa  
de Morelos, Ciudad de México, CP  
05348  
TEL: Center of Attention to Clients:  
01 (800) 016 2932. in Mexico

**GUAM**

**Triple J Motors**

157 South Marine Drive, Tamuning,  
GUAM 96911 USA  
P.O. Box 6066 Tamuning, Guam  
96931  
TEL: (671) 649-6555

**SAIPAN**

**Pacific International Marianas, Inc.**

**(d.b.a. Midway Motors)**  
P.O. Box 887 Saipan, MP 96950  
TEL: (670) 234-7524

**Triple J Saipan, Inc.**

**(d.b.a. Triple J Motors)**  
P.O. Box 500487 Saipan, MP  
96950-0487  
TEL: (670) 234-7133/3051

## Mazda Importer/Distributors

---

### AMERICAN SAMOA

**Polynesia Motors, Inc.**

P.O. Box 1120, Pago Pago, American  
Samoa 96799

TEL: (684) 699-9347

## Reporting Safety Defects (U.S.A.)

If you believe that your vehicle has a defect which could cause a crash or could cause injury or death, you should immediately inform the National Highway Traffic Safety Administration (NHTSA) in addition to notifying Mazda Motor Corporation or your Mazda Importer/Distributor.

If NHTSA receives similar complaints, it may open an investigation, and if it finds that a safety defect exists in a group of vehicles, it may order a recall and remedy campaign. However, NHTSA cannot become involved in individual problems between you, your dealer, or Mazda Motor Corporation or your Mazda Importer/Distributor.

To contact NHTSA, you may call the Vehicle Safety Hotline toll-free at 1-888-327-4236 (TTY:1-800-424-9153); go to <http://www.safercar.gov>; or write to: Administrator, NHTSA, 1200 New Jersey Avenue, SE., Washington, DC, 20590. You can also obtain other information about motor vehicle safety from <http://www.safercar.gov>.

### **NOTE**

If you live in the U.S.A., all correspondence to Mazda Motor Corporation should be forwarded to:

Mazda North American Operations  
200 Spectrum Center Drive Suite 100  
Irvine, California 92618

or

P.O. Box 19734

Irvine, CA 92623-9734

Customer Experience Center or toll free at 1 (800) 222-5500

If you live outside of the U.S.A., please contact the nearest Mazda Distributor shown in this manual.

- Refer to CANADA on page 10-17.
- Refer to PUERTO RICO/U.S. Virgin Island on page 10-18.
- Refer to MEXICO on page 10-18.
- Refer to GUAM on page 10-19.
- Refer to SAIPAN on page 10-19.
- Refer to AMERICAN SAMOA on page 10-20.



## Reporting Safety Defects

---

### Reporting Safety Defects (Canada)

Canadian customers who wish to report a safety-related defect and concern to Transport Canada, Defect Investigations and Recalls, may telephone the toll free hotline 1-800-333-0510, or go to the Road Safety website at:  
<https://www.tc.gc.ca/en/services/road.html>

## Warranties for Your Mazda

- New Vehicle Limited Warranty
- Powertrain Limited Warranty
- Safety Restraint System Limited Warranty
- Anti-perforation Limited Warranty
- Federal Emission Control Warranty/  
California Emission Control Warranty
  - Emission Defect Warranty
  - Emission Performance Warranty
- Emission Control Warranty
- Replacement Parts and Accessories Limited Warranty
- Tire Warranty

### NOTE

Warranty information varies depending on the country. Refer to the Warranty Booklet for detailed warranty information.

## Outside the United States/Canada

Government regulations in the United States/Canada require that automobiles meet specific emission regulations and safety standards. Therefore, vehicles built for use in the United States/Canada may differ from those sold in other countries.

The differences may make it difficult or even impossible for your vehicle to receive satisfactory servicing in other countries. We strongly recommend that you **NOT** take your Mazda outside the United States/Canada.

### United States

However, in the event that you are moving to Canada permanently, Mazda vehicles built for use in the United States could be eligible for exportation to Canada with specific vehicle modifications to comply with the Canadian Motor Vehicle Safety Standards (CMVSS).

### Canada

However, in the event that you are moving to the United States permanently, Mazda vehicles built for use in Canada could be eligible for exportation to the United States with specific vehicle modifications to comply with the United States Federal Motor Vehicle Safety Standards (FMVSS).

### NOTE

The above is applicable for a permanent import/export situation and not related to travelers on vacation.

## Warranty

---

You may have the following problems if you do take your vehicle outside of the United States/Canada:

- Recommended fuel may be unavailable. Any kind of leaded fuel or low-octane fuel will affect vehicle performance and damage the emission controls and engine.
- Proper repair facilities, tools, testing equipment, and replacement parts may not be available.

Please refer to your Manufacturer's Warranty Booklet for more information.

### Registering Your Vehicle in A Foreign Country (Except United States and Canada)

Registering your vehicle in a foreign country may be problematic depending on whether it meets the specific emission and safety standards of the country in which the vehicle will be driven. Consequently, your vehicle may require modifications at personal expense in order to meet the regulations.

In addition, you should be aware of the following issues:

Satisfactory vehicle servicing may be difficult or impossible in another country.

The fuel specified for your vehicle may be unavailable.

Parts, servicing techniques, and tools necessary to maintain and repair your vehicle may be unavailable.

There might not be an Authorized Mazda Dealer in the country you plan to take your vehicle.

The Mazda warranty is valid only in certain countries.

## Add-On Non-Genuine Parts and Accessories

Non-genuine parts and accessories for Mazda vehicles can be found in stores. These may fit your vehicle, but they are not approved by Mazda for use with Mazda vehicles. When you install non-genuine parts or accessories, they could affect your vehicle's performance or safety systems; the Mazda warranty doesn't cover this. Before you install any non-genuine parts or accessories, consult an Authorized Mazda Dealer.

### **WARNING**

**Always consult an Authorized Mazda Dealer before you install non-genuine parts or accessories.**

Improperly designed parts or accessories could seriously affect your vehicle's performance or safety systems. This could cause you to have an accident or increase your chances of injuries in an accident.

**Be very careful in choosing and installing add-on electrical equipment, such as mobile telephones, two-way radios, stereo systems, and car alarm systems.**

Incorrectly choosing or installing improper add-on equipment or choosing an improper installer is dangerous. Essential systems could be damaged, causing engine stalling, air-bag (SRS) activation, ABS/TCS/DSC inactivation, or a fire in the vehicle.

Mazda assumes no responsibility for death, injury, or expenses that may result from the installation of add-on non-genuine parts or accessories.

## Cell Phones

---

### Cell Phones Warning

#### **WARNING**

**Please comply with the legal regulations concerning the use of communication equipment in vehicles in your country.**

Use of any electrical devices such as cell phones, computers, portable radios, vehicle navigation or other devices by the driver while the vehicle is moving is dangerous. Dialing a number on a cell phone while driving also ties-up the driver's hands. Use of these devices will cause the driver to be distracted and could lead to a serious accident. If a passenger is unable to use the device, pull off the right-of-way to a safe area before use. If use of a cell phone is necessary despite this warning, use a hands-free system to at least leave the hands free to drive the vehicle. Never use a cell phone or other electrical devices while the vehicle is moving and, instead, concentrate on the full-time job of driving.

# Uniform Tire Quality Grading System (UTQGS)

---

## Uniform Tire Quality Grading System (UTQGS)

This information relates to the tire grading system developed by the U.S. National Highway Traffic Safety Administration for grading tires by tread wear, traction, and temperature performance.

## Tread Wear

The tread wear grade is a comparative rating based on the wear rate of the tire when tested under controlled conditions on a specified government test course.

For example, a tire graded 150 would wear one-and-a-half times as well on the government course as a tire graded 100.

The relative performance of tires depends upon the actual conditions of their use, however, and may depart significantly from the norm because of variations in driving habits, service practices and differences in road characteristics and climate.

## Uniform Tire Quality Grading System (UTQGS)

---

### Traction-AA, A, B, C

The traction grades, from highest to lowest, are AA, A, B, and C. These grades represent the tire's ability to stop on wet pavement as measured under controlled conditions on specified government test surfaces of asphalt and concrete. A tire marked C may have poor traction performance.

#### **WARNING**

The traction grade assigned to this tire is based on braking (straight ahead) traction tests and does not include acceleration cornering (turning), hydroplaning, or peak traction characteristics.

### Temperature-A, B, C

The temperature grades A (the highest), B, and C, represent the tire's resistance to the generation of heat and its ability to dissipate heat when tested under controlled conditions on a specified indoor laboratory test wheel.

Sustained high temperature can cause the material of the tire to degenerate and reduce tire life, and excessive temperatures can lead to sudden tire failure.

Grade C corresponds to a level of performance which all passenger vehicle tires must meet under the Federal Motor Vehicle Safety Standard No. 109. Grades B and A represent higher levels of performance on the laboratory test wheel than the minimum required by law.

#### **WARNING**

**Keep your vehicle's tires properly inflated and not overloaded.**

Driving with improperly inflated or overloaded tires is dangerous. Excessive speed, underinflation, or excessive loading, either separately or in combination, can cause heat buildup and possible tire failure. The temperature grade for this tire is established for a tire that is properly inflated and not overloaded.

These grades will be added to the sidewalls of passenger vehicle tires over the next several years according to a schedule established by the NHTSA and the tire manufacturers.

# Uniform Tire Quality Grading System (UTQGS)

---

The grade of tires available as standard or optional equipment on Mazda vehicles may vary with respect to grade.

ALL PASSENGER VEHICLE TIRES MUST CONFORM TO THESE GRADES AND TO ALL OTHER FEDERAL TIRE-SAFETY REQUIREMENTS.

## UNIFORM TIRE QUALITY GRADING

Quality grades can be found where applicable on the tire sidewall between tread shoulder and maximum section width.

For example:

**TREADWEAR 200 TRACTION AA  
TEMPERATURE A**

**UTQGS MARK (example)**

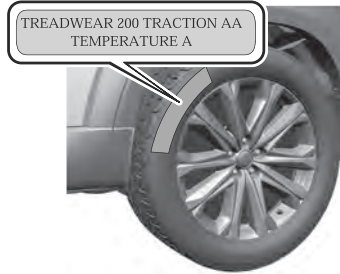



## Tire Labeling

Federal law requires tire manufacturers to place standardized information on the sidewall of all tires. This information identifies and describes the fundamental characteristics of the tire and also provides a tire identification number for safety standard certification and in case of a recall.

## Information on Passenger Vehicle Tires

Please refer to the sample below.

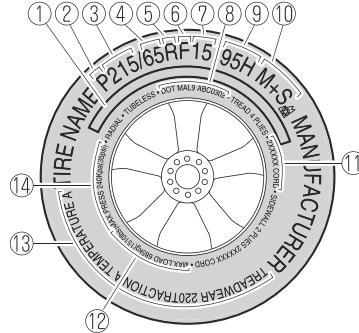

1. SAFETY WARNING
2. Passenger car tire
3. Nominal width of tire in millimeters
4. Ratio of height to width (aspect ratio)
5. Radial
6. Run-flat tire
7. Rim diameter code
8. TIN: U.S. DOT tire identification number
9. Load index & speed symbol
10. Severe snow conditions
11. Tire ply composition and materials used
12. Max. load rating
13. Tread wear, traction and temperature grades
14. Max. permissible inflation pressure

P215/65R15 95H is an example of a tire size and load index rating. Here is an explanation of the various components of that tire size and load index rating. Note that the tire size and load index rating may be different from the example.

## Tire Information (U.S.A.)

### P

Indicates a tire that may be installed on cars, SUVs, minivans and light trucks as designated by the Tire and Rim Association (T&RA).

### **NOTE**

If your tire size does not begin with a letter this may mean it is designated by either ETRTO (European Tire and Rim Technical Organization) or JATMA (Japan Tire Manufacturing Association).

### 215

"215" is the nominal width of the tire in millimeters. This three-digit number gives the width in millimeters of the tire from sidewall edge to sidewall edge. In general, the larger the number, the wider the tire.

### 65

"65" is the aspect ratio. This two-digit number indicates the tire's ratio of height to width.

### R

"R" is the tire construction symbol. R indicates "Radial ply construction".

### 15

"15" is the wheel rim diameter in inches.

### 95

"95" is the Load Index. This two- or three-digit number indicates how much weight each tire can support.

### H

"H" is the speed rating. The speed rating denotes the maximum speed for which the use of the tire is rated.

Letter Rating	Speed Rating
Q	99 mph
R	106 mph
S	112 mph
T	118 mph
U	124 mph
H	130 mph
V	149 mph
W	168 <sup>*</sup> mph
Y	186 <sup>*</sup> mph

\* For tires with a maximum speed capability over 149 mph, tire manufacturers sometimes use the letters ZR. For tires with a maximum speed capability over 186 mph, tire manufacturers always use the letters ZR.

### M+S or M/S: Mud and Snow

AT: All Terrain.

AS: All Season. The "M+S" or "M/S" indicates that the tire has some functional use in mud and snow.

### U.S. DOT Tire Identification Number (TIN)

This begins with the letters "DOT" which indicates the tire meets all federal standards. The next two numbers or letters are the plant code where it was manufactured, and the last four numbers represent the week and year the tire was manufactured. For example, the numbers 457 means the 45th week of 1997. After 2000 the numbers go to four digits. For example, the number 2102 means the 21th week of 2002. The other numbers are marketing codes used at the manufacturer's discretion. This information is used to contact consumers if a tire defect requires a recall.

## Tire Information (U.S.A.)

---

### Tire Ply Composition and Materials Used

The number of plies indicates the number of layers of rubber-coated fabric in the tire. In general, the greater the number of plies, the more weight a tire can support. Tire manufacturers also must indicate the tire materials, which include steel, nylon, polyester, and other.

### Maximum Load Rating

This number indicates the maximum load in kilograms and pounds that can be carried by the tire.

### Maximum Permissible Inflation Pressure

This number is the greatest amount of air pressure that should ever be put in the tire under normal driving conditions.

### Tread Wear, Traction and Temperature Grades

**Tread wear:** The tread wear grade is a comparative rating based on the wear rate of the tire when tested under controlled conditions on a specified government test course. For example, a tire graded 150 would wear one and one-half (1 1/2) times as well on the government course as a tire graded 100.

**Traction:** The traction grades, from highest to lowest are AA, A, B, and C. The grades represent the tire's ability to stop on wet pavement as measured under controlled conditions on specified government test surfaces of asphalt and concrete. A tire marked C may have poor traction performance.

**Temperature:** The temperature grades are A (the highest), B and C, representing the tire's resistance to the generation of heat and its ability to

dissipate heat when tested under controlled conditions on a specified indoor laboratory test wheel.

### Snow Tires

In some heavy snow areas, local governments may require true snow tires, those with very deeply cut tread. These tires should only be used in pairs or placed on all four wheels. Make sure you purchase snow tires that are the same size and construction type as the other tires on your vehicle.

### SAFETY WARNING

The following safety warning appears on the tire's sidewall.

SERIOUS INJURY MAY RESULT FROM:

- EXPLOSION OF TIRE/RIM ASSEMBLY DUE TO IMPROPER MOUNTING-MATCH TIRE DIAMETER TO RIM DIAMETER; NEVER EXCEED 40 psi (275 kPa) TO SEAT BEADS-ONLY SPECIALLY TRAINED PERSONS SHOULD MOUNT TIRES.
- TIRE FAILURE DUE TO UNDER-INFLATION/OVERLOADING/DAMAGE-FOLLOW OWNER'S MANUAL AND PLACARD IN VEHICLE-FREQUENTLY CHECK INFLATION PRESSURE AND INSPECT FOR DAMAGE.

## Information on Temporary Tires

Please refer to the sample below.

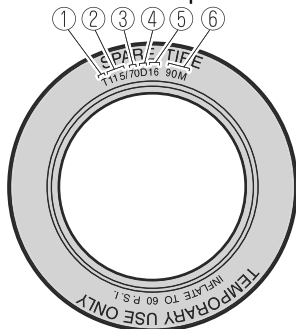

1. Temporary tires
2. Nominal width of tire in millimeters
3. Ratio of height to width (aspect ratio)
4. Diagonal
5. Rim diameter code
6. Load index & speed symbol

T115/70D16 90M is an example of a tire size and load index rating. Here is an explanation of the various components of that tire size and load index rating. Note that the tire size and load index rating may be different from the example.

### T

Indicates a tire that may be installed on cars, SUVs, minivans and light trucks as designated by the Tire and Rim Association (T&RA).

### 115

"115" is the nominal width of the tire in millimeters. This three-digit number gives the width in millimeters of the tire from sidewall edge to sidewall edge. In general, the larger the number, the wider the tire.

### 70

"70" is the aspect ratio. This two-digit number indicates the tire's ratio of height to width.

### D

"D" is the tire construction symbol. D indicates "diagonal ply construction".

### 16

"16" is the wheel rim diameter in inches.

### 90

"90" is the Load Index. This two-or three-digit number indicates how much weight each tire can support.

### M

"M" is the speed rating. The speed rating denotes the maximum speed for which the use of the tire is rated.

Letter Rating	Speed Rating
M	81 mph

## Location of the Tire Label (Placard)

You will find the tire label containing tire inflation pressure by tire size and other important information on the driver's side B-pillar or on the edge of the driver's door frame.

### SAMPLE

TIRE AND LOADING INFORMATION RENSEIGNEMENTS SUR LES PNEUS ET LE CHARGEMENT			
SEATING CAPACITY NOMBRE DE PLACES		TOTAL 5	FRONT 2   REAR 3
The combined weight of occupants and cargo should never exceed 4500 kg or 9900 lbs.* Le poids total des occupants et du chargement ne doit jamais dépasser 4500 kg ou 9900 lbs.*			
TIRE PNEU	SIZE DIMENSIONS	COLD TIRE PRESSURE PRESSION DES PNEUS A FROID	SEE OWNER'S MANUAL FOR ADDITIONAL INFORMATION
FRONT AVANT	195/70R14	200 kPa, 29 psi	VOIR LE MANUEL DE L'USAGER POUR PLUS DE RENSEIGNEMENTS
REAR ARRIERE	195/70R14	200 kPa, 29 psi	
SPARE DE SECOURS	T125/70D15	420 kPa, 60 psi	

## Recommended Tire Inflation Pressure

On the tire label you will find the recommended tire inflation pressure in both kPa and psi for the tires installed as original equipment on the vehicle. It is very important that the inflation pressure of the tires on your vehicle is maintained at the recommended pressure. You should check the tire pressure regularly to insure that the proper inflation pressure is maintained. Refer to Tires on page 10-69.

### NOTE

Tire pressures listed on the vehicle placard or tire information label indicate the recommended cold tire inflation pressure, measured when the tires are cold, after the vehicle has been parked for at least 3 hours. As you drive, the temperature in the tire warms up, increasing the tire pressure.

## WARNING

**Always check the tire inflation pressures on a regular basis according to the recommended tire inflation pressure on the tire label and in conjunction with the information in this owner's manual.**

Driving your vehicle with under-inflated tires is dangerous.

Under-inflation is the most common cause of failures in any kind of tire and may result in severe cracking, tread separation or “blowout”, with unexpected loss of vehicle control and increased risk of injury. Under-inflation increases sidewall flexing and rolling resistance, resulting in heat buildup and internal damage to the tire. It results in unnecessary tire stress, irregular wear, loss of control and accidents. A tire can lose up to half of its air pressure and not appear to be flat!

It is impossible to determine whether or not tires are properly inflated just by looking at them.

## Checking Tire Pressure

1. When you check the air pressure, make sure the tires are cold —meaning they are not hot from driving even a mile.
2. Remove the cap from the valve on one tire.
3. Firmly press a tire gauge onto the valve.
4. Add air to achieve recommended air pressure.
5. If you overfill the tire, release air by pushing on the metal stem in the center of the valve. Then recheck the pressure with your tire gauge.
6. Replace the valve cap.
7. Repeat with each tire, including the spare.

### NOTE

Some spare tires require higher inflation pressure.

8. Visually inspect the tires to make sure there are no nails or other objects embedded that could poke a hole in the tire and cause an air leak.
9. Check the sidewalls to make sure there are no gouges, cuts, bulges, cracks or other irregularities.

## Tire Information (U.S.A.)

---

### Glossary of Terms

**Tire Placard:** A label indicating the OE tire sizes, recommended inflation pressure, and the maximum weight the vehicle can carry.

**Tire Identification Number (TIN):** A number on the sidewall of each tire providing information about the tire brand and manufacturing plant, tire size, and date of manufacture.

**Inflation Pressure:** A measure of the amount of air in a tire.

**kPa:** Kilopascal, the metric unit for air pressure.

**psi:** Pounds per square inch, the English unit for air pressure.

**B-pillar:** The structural member at the side of the vehicle behind the front door.

**Original Equipment (OE):** Describes components originally equipped on the vehicle.

**Vehicle Load Limit:** The maximum value of the combination weight of occupants and cargo.

**Bead Area of the Tire:** Area of the tire next to the rim.

**Sidewall Area of the Tire:** Area between the bead area and the tread.

**Tread Area of the Tire:** Area on the perimeter of the tire that contacts the road when it's mounted on the vehicle.

**Seating capacity** means the total allowable number of vehicle occupants. Seating capacity is described on the tire label.

**Production options weight** is the combination weight of installed regular production options weighing over 2.3 kilograms in excess of the standard items which they replace, and not previously considered in the curb

weight or accessory weight, including heavy duty brakes, ride levelers, roof rack, heavy duty battery, and special trim.

**Rim** is the metal support (wheel) for a tire or a tire and tube assembly upon which the tire beads are seated.

## Tire Information (U.S.A.)

---

### Tire Maintenance

Improper or inadequate vehicle maintenance can cause tires to wear abnormally. Here are some important maintenance points:

### Tire Inflation Pressure

Inspect all tire pressure monthly (including the spare) when the tires are cold. Maintain recommended pressures for the best ride, top handling, and minimum tire wear. Use the pressures specified on the vehicle tire information placard or tire label for optimum service.



## Tire Information (U.S.A.)

### Tire Rotation

To equalize tread wear, rotate the tires every 16,000 km (10,000 miles) at the latest or sooner if irregular wear develops. Mazda recommends to rotate every 8,000 km (5,000 miles) to help increase tire life and distribute wear more evenly.

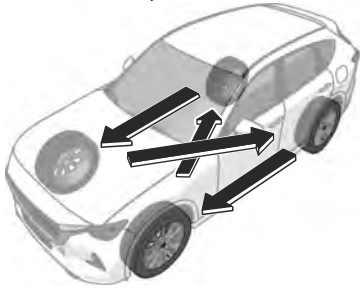

Do not include (TEMPORARY USE ONLY) spare tire in rotation.

Inspect the tires for uneven wear and damage. Abnormal wear is usually caused by one or a combination of the following:

- Incorrect tire pressure
- Improper wheel alignment
- Out-of-balance wheel
- Severe braking

After rotation, inflate all tire pressures to specification on page 10-69 and inspect the lug nuts for tightness.

### CAUTION

Rotate unidirectional tires and radial tires that have an asymmetrical tread pattern or studs only from front to rear, not from side to side. Tire performance will be weakened if rotated from side to side.

### Replacing a Tire

#### ! WARNING

**Always use tires that are in good condition.**

Driving with worn tires is dangerous. Reduced braking, steering, and traction could result in an accident.

If a tire wears evenly, a wear indicator will appear as a solid band across the tread.

Replace the tire when this happens.

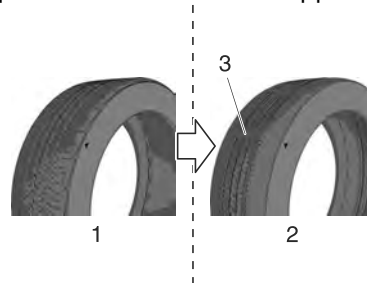

1. New tread
2. Worn tread
3. Tread wear indicator

You should replace the tire before the band crosses the entire tread.

#### NOTE

Tires degrade over time, even when they are not being used on the road. It is recommended that tires generally be replaced when they are 6 years or older. Heat caused by hot climates or frequent high loading conditions can accelerate the aging process. You should replace the spare tire when you replace the other road tires due to the aging of the spare tire. The period in which the tire was manufactured (both week and year) is indicated by a 4-digit number.

Refer to Tire Labeling on page 10-30.

## Safety Practices

The way you drive has a great deal to do with your tire mileage and safety. So cultivate good driving habits for your own benefit.

- Observe posted speed limits and drive at speeds that are safe for the existing weather conditions
- Avoid fast starts, stops and turns
- Avoid potholes and objects on the road
- Do not run over curbs or hit the tire against the curb when parking

### CAUTION

If you feel a sudden vibration or ride disturbance while driving or you suspect your tire or vehicle has been damaged, immediately reduce your speed. Drive with caution until you can safely pull off the road. Stop and inspect the tire for damage. If the tire is under-inflated or damaged, deflate it, remove the tire and rim and replace it with your spare tire. If you cannot detect a cause, have the vehicle towed to the nearest vehicle or tire dealer to have the vehicle inspected.

## Vehicle Loading

This section will guide you in the proper loading of your vehicle and/or trailer, to keep your loaded vehicle weight within its design rating capability, with or without a trailer. Properly loading your vehicle will provide maximum return of vehicle design performance. Before loading your vehicle, familiarize yourself with the following terms for determining your vehicle's weight ratings, with or without a trailer, from the vehicle's Safety Certification Label and Tire and Load Information Label:

### **WARNING**

#### **Overloaded Vehicle.**

Overloading a vehicle is dangerous. The results of overloading can have serious consequences in terms of passenger safety. Too much weight on a vehicle's suspension system can cause spring or shock absorber failure, brake failure, handling or steering problems, irregular tire wear, tire failure or other damage. Overloading makes a vehicle harder to drive and control. It also increases the distance required for stopping. In cases of serious overloading, brakes can fail completely, particularly on steep grades. The load a tire will carry safely is a combination of the size of the tire, its load range, and corresponding inflation pressure.

Never overload the vehicle and always observe the vehicle's weight ratings from the vehicle's Safety Certification and Tire and Load Information labels.

**Base Curb Weight is the weight of the vehicle including a full tank of fuel and all standard equipment. It does not include passengers, cargo, or optional equipment.**

**Vehicle Curb Weight** is the weight of your new vehicle when you picked it up from your dealer plus any aftermarket equipment.

#### **PAYLOAD**

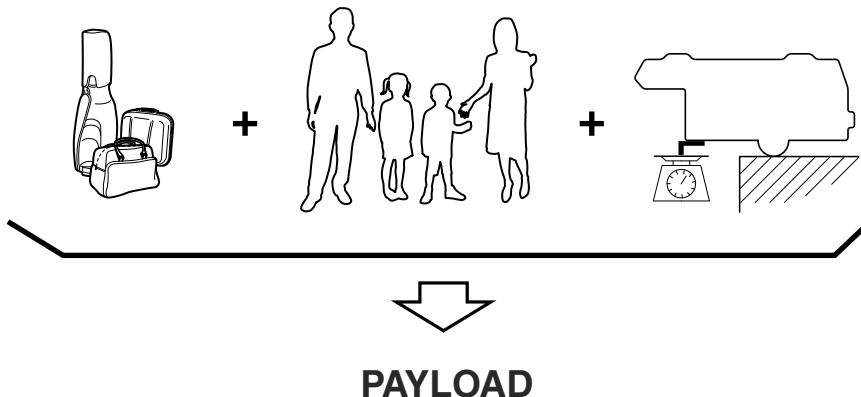

## Tire Information (U.S.A.)

**Payload** is the combination weight of cargo and passengers that the vehicle is designed to carry. The maximum payload for your vehicle can be found on the Tire and Load Information label on the driver's door frame or door pillar. Look for "THE COMBINATION WEIGHT OF OCCUPANTS AND CARGO SHOULD NEVER EXCEED XXX kg or XXX lbs" for your maximum payload. The payload listed on the tire label is the maximum payload for the vehicle as built by the assembly plant. If any aftermarket or dealer installed equipment has been installed on the vehicle, the weight of the equipment must be subtracted from the payload listed on the tire label in order to be accurate.

### SAMPLE

TIRE AND LOADING INFORMATION RENSEIGNEMENTS SUR LES PNEUS ET LE CHARGEMENT				
SEATING CAPACITY NOMBRE DE PLACES		TOTAL 5	FRONT AVANT 2	REAR ARRIÈRE 3
The combined weight of occupants and cargo should never exceed <b>xxx</b> kg or <b>xxx</b> lbs.* Le poids total des occupants et du chargement ne doit jamais dépasser <b>xxx</b> kg ou <b>xxx</b> lb.*				
TIRE PNEU	SIZE DIMENSIONS	COLD TIRE PRESSURE PRESSION DES PNEUS À FROID		SEE OWNER'S MANUAL FOR ADDITIONAL INFORMATION
FRONT AVANT	P195/70R14	200 kPa, 29 psi		VOIR LE MANUEL DE L'USAGER POUR PLUS DE RENSEIGNEMENTS
REAR ARRIÈRE	P195/70R14	200 kPa, 29 psi		
SPARE DE SECOURS	T125/70D15	420 kPa, 60 psi		

### CARGO

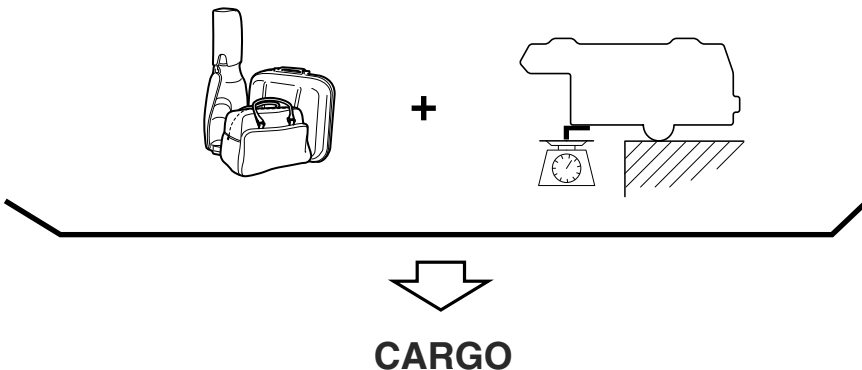

## Tire Information (U.S.A.)

---

**Cargo Weight** includes all weight added to the Base Curb Weight, including cargo and optional equipment. When towing, trailer tongue load or king pin weight is also part of cargo weight.

The cargo weight limit decreases depending on the number of vehicle occupants. The cargo weight limit can be calculated by subtracting the total weight of the vehicle occupants from the “combination weight of occupants and cargo should never exceed” value on the tire label.

Examples: Based on a single occupant weight of 68 kg (150 lbs), and a value of 385 kg (849 lbs) for the “combination weight of occupants and cargo should never exceed”:

The cargo weight limit with one occupant is  $385 \text{ kg (849 lbs)} - 68 \text{ kg (150 lbs)} = 317 \text{ kg (699 lbs)}$

The cargo weight limit with two occupants is  $385 \text{ kg (849 lbs)} - (68 \times 2) \text{ kg (150} \times 2 \text{ lbs)} = 249 \text{ kg (549 lbs)}$

If the weight of the occupant increases, the cargo weight limit decreases by that much.

**GAW (Gross Axle Weight)** is the total weight placed on each axle (front and rear) - including vehicle curb weight and all payload.

**GAWR (Gross Axle Weight Rating)** is the maximum allowable weight that can be carried by a single axle (front or rear). **These numbers are shown on the Safety Compliance Certification Label located on the driver's door frame or door pillar. The total load on each axle must never exceed its GAWR.**

### GVW

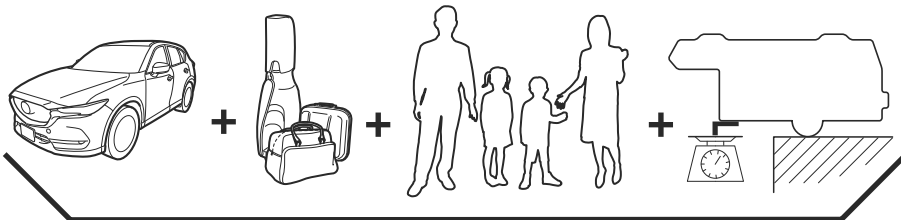

### GVW

**GVW (Gross Vehicle Weight)** is the Vehicle Curb Weight + cargo + passengers.

**GVWR (Gross Vehicle Weight Rating)** is the maximum allowable weight of the fully loaded vehicle (including all options, equipment, passengers and cargo). **The GVWR is shown on the Safety Compliance Certification Label located on the driver's door frame or door pillar. The GVW must never exceed the GVWR.**

**SAMPLE**

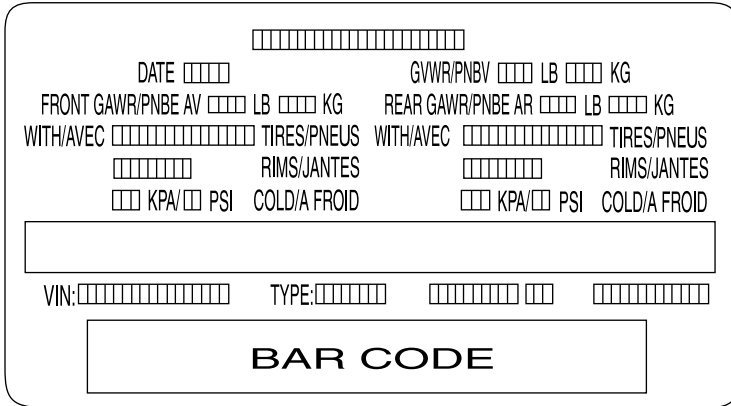

**⚠ WARNING**

**Never Exceed Axle Weight Rating Limits.**

Exceeding the Safety Certification Label axle weight rating limits is dangerous and could result in death or serious injury as a result of substandard vehicle handling, performance, engine, transmission and/or structural damage, serious damage to the vehicle, or loss of control.

Always keep the vehicle within the axle weight rating limits.

**GCW**

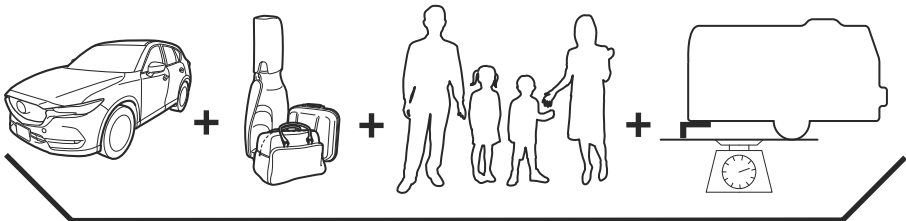

**GCW**

## Tire Information (U.S.A.)

---

**GCW (Gross Combination Weight)** is the weight of the loaded vehicle (GVW) plus the weight of the fully loaded trailer.

**GCWR (Gross Combination Weight Rating)** is the maximum allowable weight of the vehicle and the loaded trailer - including all cargo and passengers - that the vehicle can handle without risking damage. (Important: The towing vehicle's braking system is rated for operation at GVWR, not at GCWR. Separate functional brakes should be used for safe control of towed vehicles and for trailers weighing more than 1,500 lbs). **The GCW must never exceed the GCWR.**

**Maximum Loaded Trailer Weight** is the highest possible weight of a fully loaded trailer the vehicle can tow. It assumes a vehicle with only mandatory options, no cargo (internal or external), a tongue load of 10–15 % (conventional trailer) or king pin weight of 15–25 % (fifth-wheel trailer), and driver only (150 lbs). **Consult your dealership (or the RV and Trailer Towing Guide provided by your dealership) for more detailed information.**

**Tongue Load or Fifth-Wheel King Pin Weight** refers to the amount of the weight that a trailer pushes down on a trailer hitch.

**Examples:** For a 5000 lb conventional trailer, multiply 5000 by 0.10 and 0.15 to obtain a proper tongue load range of 500 to 750 lbs. For an 11,500 lb fifth-wheel trailer, multiply by 0.15 and 0.25 to obtain a proper king pin load range of 1,725 to 2,875 lbs.



### **Never Exceed GVWR or GAWR Specifications.**

Exceeding the GVWR or the GAWR specified on the certification label is dangerous. Exceeding any vehicle rating limitation could result in a serious accident, injury, or damage to the vehicle.

Do not use replacement tires with lower load carrying capacities than the originals because they may lower the vehicle's GVWR and GAWR limitations. Replacement tires with a higher limit than the originals do not increase the GVWR and GAWR limitations.

Never exceed the GVWR or the GAWR specified on the certification label.

## Steps for Determining the Correct Load Limit

### Steps for Determining Correct Load Limit-

- (1) Locate the statement "The combined weight of occupants and cargo should never exceed XXX kg or XXX lbs." on your vehicle's placard.
- (2) Determine the combined weight of the driver and passengers that will be riding in your vehicle.
- (3) Subtract the combined weight of the driver and passengers from XXX kg or XXX lbs.
- (4) The resulting figure equals the available amount of cargo and luggage load capacity. For example, if the "XXX" amount equals 1400 lbs. and there will be five 150 lb passengers in your vehicle, the amount of available cargo and luggage load capacity is 650 lbs. ( $1400 - 750 (5 \times 150) = 650$  lbs.)
- (5) Determine the combined weight of luggage and cargo being loaded on the vehicle. That weight may not safely exceed the available cargo and luggage load capacity calculated in Step 4.
- (6) If your vehicle will be towing a trailer, load from your trailer will be transferred to your vehicle. Consult this manual to determine how this reduces the available cargo and luggage load capacity of your vehicle.



## Declaration of Conformity

---

### Keyless Entry System/Immobilizer System

#### FCC CAUTION

Changes or modifications not expressly approved by the party responsible for compliance could void the user's authority to operate the equipment.

#### FCC/ISED

This device complies with part 15 of FCC Rules and Innovation, Science and Economic Development Canada's licence-exempt RSS(s). Operation is subject to the following two conditions: (1) this device may not cause harmful interference, and (2) this device must accept any interference received, including interference that may cause undesired operation. Le présent appareil est conforme à la partie 15 des règles de la FCC et aux normes des CNR d'Innovation, Sciences et Développement économique Canada applicables aux appareils radio exempts de licence. L'exploitation est autorisée aux deux conditions suivantes : (1) l'appareil ne doit pas produire de brouillage, et (2) l'appareil doit accepter tout brouillage subi, même si le brouillage est susceptible d'en compromettre le fonctionnement.

#### (MEXICO)

La operación de este equipo está sujeta a las siguientes dos condiciones: (1) es posible que este equipo o dispositivo no cause interferencia perjudicial y (2) este equipo o dispositivo debe aceptar cualquier interferencia, incluyendo la que pueda causar su operación no deseada.

## HomeLink Wireless Control System

### FCC (USA) andISED (Canada)

This device complies with FCC rules part 15 and Innovation, Science, and Economic Development Canada RSS-210. Operation is subject to the following two conditions: (1) This device may not cause harmful interference, and (2) This device must accept any interference that may be received including interference that may cause undesired operation. **WARNING:** The transmitter has been tested and complies with FCC and ISED rules. Changes or modifications not expressly approved by the party responsible for compliance could void the user's authority to operate the device.

This equipment complies with FCC and ISED radiation exposure limits set forth for an uncontrolled environment. End Users must follow the specific operating instructions for satisfying RF exposure compliance. This transmitter must be at least 20 cm from the user and must not be co-located or operating in conjunction with any other antenna or transmitter.

### FCC (États-Unis) et ISED (Canada)

Cet appareil est conforme aux règlements de la FCC, section 15, et au CNR-210 d'Innovation, Sciences et Développement économique Canada. Le fonctionnement est assujéti aux deux conditions suivantes : (1) cet appareil ne doit pas causer d'interférences nuisibles et (2) cet appareil doit accepter toute interférence reçue, y compris celle qui pourrait entraîner un dysfonctionnement. **MISE EN GARDE :** L'émetteur a subi des tests et est conforme aux règlements de la FCC et d'ISDE. Les changements ou modifications non approuvés explicitement par la partie responsable de la conformité pourraient rendre caduque l'autorisation de l'utilisateur de se servir du dispositif.

Cet appareil est conforme aux limites d'exposition aux radiations de la FCC et d'ISDE établies pour un environnement non contrôlé. Les utilisateurs finaux doivent respecter les instructions d'utilisation spécifiques pour satisfaire aux exigences de conformité aux expositions de RF. L'émetteur doit se trouver à 20 cm au minimum de l'utilisateur et ne doit pas être situé au même endroit que tout autre émetteur ou antenne ni fonctionner avec un autre émetteur ou antenne.

### Mexico

\*La operación de este equipo está sujeta a las siguientes dos condiciones. (1) es posible que este equipo o dispositivo no cause interferencia perjudicial\* y (2) este equipo o dispositivo debe aceptar cualquier interferencia, incluyendo la que pueda causar su operación no deseada



## Declaration of Conformity

---

### Tire Pressure Monitoring System

#### **USA**

This device complies with Part 15 of the FCC Rules. Operation is subject to the following two conditions: (1) this device may not cause harmful interference, and (2) this device must accept any interference received, including interference that may cause undesired operation.

Changes or modifications not expressly approved by the party responsible for compliance could void the user's authority to operate the equipment.

#### **Canada**

This device complies with Industry Canada licence-exempt RSS standard(s). Operation is subject to the following two conditions: (1) this device may not cause interference, and (2) this device must accept any interference, including interference that may cause undesired operation of the device.

Le présent appareil est conforme aux CNR d'Industrie Canada applicables aux appareils radio exempts de licence. L'exploitation est autorisée aux deux conditions suivantes : (1) l'appareil ne doit pas produire de brouillage, et (2) l'utilisateur de l'appareil doit accepter tout brouillage radioélectrique subi, même si le brouillage est susceptible d'en compromettre le fonctionnement.

#### **Mexico**

La operación de este equipo está sujeta a las siguientes dos condiciones: (1) es posible que este equipo o dispositivo no cause interferencia perjudicial y (2) este equipo o dispositivo debe aceptar cualquier interferencia, incluyendo la que pueda causar su operación no deseada.

## Front Radar Sensor System

### -USA/Puerto Rico/Guam/Saipan/CANADA

Model: ARS4-B

IC: 4135A-ARS4B

FCC ID: OAYARS4B

This device complies with Part 15 of the FCC Rules and with Industry Canada licence-exempt RSS standard(s). Operation is subject to the following two conditions:

- (1) This device may not cause harmful interference, and
- (2) This device must accept any interference received, including interference that may cause undesired operation.

Cet présent appareil est conforme aux CNR d'Industrie Canada applicables aux appareils radio exempts de licence. L'exploitation est autorisée aux deux conditions suivantes:

- (1) l'appareil ne doit pas produire de brouillage, et
- (2) l'utilisateur de l'appareil doit accepter tout brouillage radioélectrique subi, même si le brouillage est susceptible d'en compromettre le fonctionnement.

#### *Radiofrequency radiation exposure information:*

*This equipment complies with FCC and IC radiation exposure limits set forth for an uncontrolled environment. This equipment should be installed and operated with minimum distance of 30 cm between the radiator and your body.*

*This transmitter must not be co-located or operating in conjunction with any other antenna or transmitter.*

*Cet équipement est conforme aux limites d'exposition aux rayonnements IC établies pour un environnement non contrôlé. Cet équipement doit être installé et utilisé avec un minimum de 30 cm de distance entre la source de rayonnement et votre corps.*

#### FCC Notice

Changes or modifications not expressly approved by the party responsible for compliance could void the user's authority to operate the equipment.

### -Mexico

Certificado de homologación: RVLCOAR15-0006

Continental ARS 4-B

Este equipo opera a título secundario, consecuentemente, debe aceptar interferencias perjudiciales. Incluyendo equipos de la misma clase y puede no causar interferencias a sistemas operando a título primario.

# Declaration of Conformity

## Front Side Radar Sensor System/Rear Side Radar Sensor System

FCC	<p>FCC ID : 2AHE9-24GMMR20</p> <p>This device complies with part 15 of the FCC Rules. Operation is subject to the following two conditions:                  (1) This device may not cause harmful interference, and                  (2) This device must accept any interference received, including interference that may cause undesired operation.</p> <p>FCC CAUTION                  Changes or modifications made to this equipment not expressly approved by (FURUKAWA AUTOMOTIVE SYSTEMS INC) may void the FCC authorization to operate this equipment.</p>
CANADA	<p>IC: 21140-24GMMR20</p> <p>NOTICE:                  This device contains licence exempt transmitter(s)/receiver(s) that comply with Innovation, Science and Economic Development Canada's licence exempt RSS(s). Operation is subject to the following two conditions:                  1. This device may not cause interference                  2. This device must accept any interference, including interference that may cause undesired operation of the device.</p> <p>L'émetteur / récepteur exempt de licence contenu dans le présent appareil est conforme aux CNR d'Innovation, Sciences et Développement économique Canada applicables aux appareils radio exempts de licence. L'exploitation est autorisée aux deux conditions suivantes :                  1. L'appareil ne doit pas produire de brouillage                  2. L'appareil doit accepter tout brouillage radioélectrique subi , même si le brouillage est susceptible d'en compromettre le fonctionnement.</p> <p>NOTICE:                  Changes or modifications made to this equipment not expressly approved by (FURUKAWA AUTOMOTIVE SYSTEMS INC) may void the FCC authorization to operate this equipment.</p> <p>Radiofrequency radiation exposure Information:                  The radiated output power of the device is far below the FCC radio frequency exposure limits. Nevertheless, the device shall be used in such a manner that the potential for human contact during normal operation is minimized.</p>

## Audio System

### USA(FCC)

Model No. : AM2201

This device complies with part 15 of the FCC Rules. Operation is subject to the following two conditions:

- (1) This device may not cause harmful interference, and
- (2) this device must accept any interference received, including interference that may cause undesired operation.

#### Responsible Party

- Name : Panasonic Corporation of North America
- Address : Two Riverfront Plaza, Newark, NJ 07102-5490
- Support Contact : <https://shop.panasonic.com/support>

#### NOTE

Properly shielded and grounded cables and connectors must be used for connection to host computers and / or peripherals in order to meet FCC emission limits.

#### Compliance with FCC requirement 15.407(c)

Data transmission is always initiated by software, which is passed down through the MAC, through the digital and analog baseband, and finally to the RF chip. Several special packets are initiated by the MAC. These are the only ways the digital baseband portion will turn on the RF transmitter, which it then turns off at the end of the packet. Therefore, the transmitter will be on only while one of the aforementioned packets is being transmitted. In other words, this device automatically discontinues transmission in case of either absence of information to transmit or operational failure.

Frequency Tolerance:  $\pm 20$ ppm

#### WARNING

##### RF Exposure

This equipment complies with FCC radiation exposure limits set forth for an uncontrolled environment and meets the FCC radio frequency (RF) Exposure Guidelines. This equipment has very low levels of RF energy that it deemed to comply without maximum permissive exposure evaluation (MPE). [But it is desirable that it should be installed and operated keeping the radiator at least 20cm or more away from person's body.]

This transmitter must not be co-located or operated in conjunction with any other antenna or transmitter.

#### FCC CAUTION :

Changes or modifications not expressly approved by the party responsible for compliance could void the user's authority to operate the equipment.

Specifications/Customer Information and Reporting Safety Defects  
**Declaration of Conformity**

---

**Canada**

**NOTE**

This device complies with Industry Canada's applicable licence-exempt RSSs.

Operation is subject to the following two conditions:

- (1) This device may not cause interference; and
- (2) This device must accept any interference, including interference that may cause undesired operation of the device.

Le présent appareil est conforme aux CNR d'Industrie Canada applicables aux appareils radio exempts de licence.

L'exploitation est autorisée aux deux conditions suivantes :

- 1) l'appareil ne doit pas produire de brouillage;
- 2) l'utilisateur de l'appareil doit accepter tout brouillage radioélectrique subi, même si le brouillage est susceptible d'en compromettre le fonctionnement.

**CAUTION:**

This equipment complies with ISED radiation exposure limits set forth for an uncontrolled environment and meets RSS-102 of the ISED radio frequency (RF) Exposure rules. This equipment should be installed and operated keeping the radiator at least 20cm or more away from person's body.

Cet équipement est conforme aux limites d'exposition aux rayonnements énoncées pour un environnement non contrôlé et respecte les règles d'exposition aux fréquences radioélectriques (RF) CNR-102 de l'ISDE. Cet équipement doit être installé et utilisé en gardant une distance de 20 cm ou plus entre le radiateur et le corps humain.

Data transmission is always initiated by software, which is the passed down through the MAC, through the digital and analog baseband, and finally to the RF chip. Several special packets are initiated by the MAC. These are the only ways the digital baseband portion will turn on the RF transmitter, which it then turns off at the end of the packet. Therefore, the transmitter will be on only while one of the aforementioned packets is being transmitted. In other words, this device automatically discontinues transmission in case of either absence of information to transmit or operational failure.

La transmission des données est toujours initiée par le logiciel, puis les données sont transmises par l'intermédiaire du MAC, par la bande de base numérique et analogique et, enfin, à la puce RF. Plusieurs paquets spéciaux sont initiés par le MAC. Ce sont les seuls moyens pour qu'une partie de la bande de base numérique active l'émetteur RF, puis désactive celui-ci à la fin du paquet. En conséquence, l'émetteur reste uniquement activé lors de la transmission d'un des paquets susmentionnés. En d'autres termes, ce dispositif interrompt automatiquement toute transmission en cas d'absence d'information à transmettre ou de défaillance.

**Mexico**

Model No. AM2201: IFT:MAPAAM23-08132

La operación de este equipo está sujeta a las siguientes dos condiciones:

- (1) es posible que este equipo o dispositivo no cause interferencia perjudicial y
- (2) este equipo o dispositivo debe aceptar cualquier interferencia, incluyendo la que pueda causar su operación no deseada.



## Declaration of Conformity

---

### Radio System

FCC

**NOTE :**

Properly shielded and grounded cables and connectors must be used for connection to host computers and / or peripherals in order to meet FCC emission limits.

**CAUTION :**

Changes or modifications not expressly approved by the party responsible for compliance could void the user's authority to operate the equipment.



# Declaration of Conformity

---

## Data Communication System

U.S.A.

 **CAUTION**

### Radio Frequency Radiation Exposure

This equipment complies with FCC radiation exposure limits set forth for an uncontrolled environment and meets the FCC radio frequency (RF) Exposure Guidelines. This equipment should be installed and operated keeping the radiator at least 20cm or more away from person's body in normal use position.

### Co-location

This transmitter must not be co-located or operated in conjunction with any other antenna or transmitter.

This device complies with part 15 of the FCC Rules. Operation is subject to the following two conditions: (1) This device may not cause harmful interference, and (2) this device must accept any interference received, including interference that may cause undesired operation.

### FCC

 **WARNING**

Changes or modifications not expressly approved by the party responsible for compliance could void the user's authority to operate the equipment.

## Declaration of Conformity

---

### Canada

Contains IC: 574B-DA39

This device contains licence-exempt transmitter(s)/receiver(s) that comply with Innovation, Science and Economic Development Canada's licence-exempt RSS(s). Operation is subject to the following two conditions:

- (1) This device may not cause interference.
- (2) This device must accept any interference, including interference that may cause undesired operation of the device.

**CAUTION: Radio Frequency Radiation Exposure**

This equipment complies with IC radiation exposure limits set forth for an uncontrolled environment and meets RSS-102 of the IC radio frequency (RF) Exposure rules. This equipment should be installed and operated keeping the radiator at least 20cm or more away from person's body.

## Declaration of Conformity

---

Contient IC: 574B-DA39

L'émetteur/récepteur exempt de licence contenu dans le présent appareil est conforme aux CNR d'Innovation, Sciences et Développement économique Canada applicables aux appareils radio exempts de licence. L'exploitation est autorisée aux deux conditions suivantes :

- 1) L'appareil ne doit pas produire de brouillage;
- 2) L'appareil doit accepter tout brouillage radioélectrique subi, même si le brouillage est susceptible d'en compromettre le fonctionnement.

**ATTENTION:** l'exposition aux rayonnements radiofréquence

- Cet équipement est conforme aux limites d'exposition aux rayonnements énoncées pour un environnement non contrôlé et respecte les règles d'exposition aux fréquences radioélectriques (RF) CNR-102 de l'IC. Cet équipement doit être installé et utilisé en gardant une distance de 20 cm ou plus entre le radiateur et le corps humain.

## Wireless Charger (Qi)

**IC ID:**26055-KAAA66CH0

**FCC ID:**2AEQT-KAAA66CH0

**FCC Statement:**

This device complies with Industry Canada licence-exempt RSS standard(s).

Operation is subject to the following two conditions: (1) this device may not cause interference, and (2) this device must accept any interference, including interference that may cause undesired operation of the device.

Le présent appareil est conforme aux CNR d'Industrie Canada applicables aux appareils radio exempts de licence. L'exploitation est autorisée aux deux conditions suivantes : (1) l'appareil ne doit pas produire de brouillage, et (2) l'utilisateur de l'appareil doit accepter tout brouillage radioélectrique subi, même si le brouillage est susceptible d'en compromettre le fonctionnement.

This equipment complies with Industry Canada radiation exposure limits set forth for an uncontrolled environment.

Cet équipement est conforme à l'exposition aux rayonnements Industry Canada limites établies pour un environnement non contrôlé.

This device complies with part 15 of the FCC rules. Operation is subject to the following two conditions: (1) this device may not cause harmful interference, and (2) this device must accept any interference received, including interference that may cause undesired operation. Changes or modifications not expressly approved by the party responsible for compliance could void the user's authority to operate the equipment.

NOTE: This equipment has been tested and found to comply with the limits for a Class B digital device, pursuant to part 15 of the FCC Rules. These limits are designed to provide reasonable protection against harmful interference in a residential installation. This equipment generates uses and can radiate radio frequency energy and, if not installed and used in accordance with the instructions, may cause harmful interference to radio communications. However, there is no guarantee that interference will not occur in a particular installation. If this equipment does cause harmful interference to radio or television reception, which can be determined by turning the equipment off and on, the user is encouraged to try to correct the interference by one or more of the following measures:

- Reorient or relocate the receiving antenna.
  - Increase the separation between the equipment and receiver.
  - Connect the equipment into an outlet on a circuit different from that to which the receiver is connected.
  - Consult the dealer or an experienced radio/TV technician for help
- Important announcement Important  
Note: Radiation Exposure Statement

This equipment complies with FCC radiation exposure limits set forth for an uncontrolled environment.

This transmitter must not be co-located or operating in conjunction with any other antenna or transmitter.

# Identification Numbers

---

## Vehicle Identification Number

The vehicle identification number legally identifies your vehicle.

### Dashboard

The number is on a plate attached to the left top side of the dashboard.

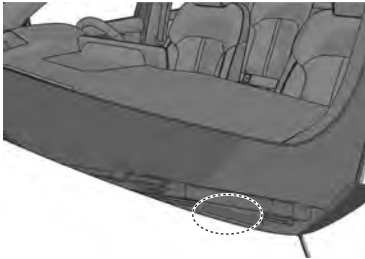

### Chassis

Open the cover shown in the figure to check the vehicle identification number.

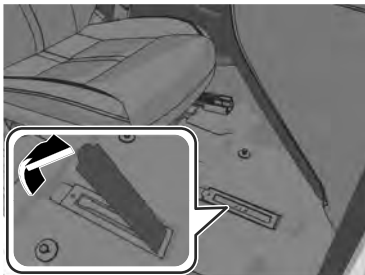

## Motor Vehicle Safety Standard Label (U.S.A. and Canada)



## Identification Numbers

### Vehicle Emission Control Information Label (U.S.A. and Canada)



### Tire Pressure Label



# Identification Numbers

---

## Engine Number

e-SKYACTIV G

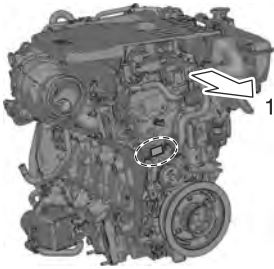

1. Forward

# Vehicle Specification

---

## Engine

Item	Specification
Type	DOHC-24V in-line, 6-cylinder
Bore × Stroke	86.0 × 94.2 mm (3.39 × 3.71 in)
Displacement	3,283.1 ml (3,283.1 cc)
Compression ratio	12.0



## Vehicle Specification

---

### M Hybrid Battery

Item	Specification
Type	Lithium-ion battery
Temperature range	Operation guaranteed temperature: $-30\text{ }^{\circ}\text{C}$ ( $-22\text{ }^{\circ}\text{F}$ ) — $65\text{ }^{\circ}\text{C}$ ( $149\text{ }^{\circ}\text{F}$ ) Storage guaranteed temperature: $-40\text{ }^{\circ}\text{C}$ ( $-40\text{ }^{\circ}\text{F}$ ) — $80\text{ }^{\circ}\text{C}$ ( $176\text{ }^{\circ}\text{F}$ )

## Electrical System

### Lead-acid battery\*<sup>1</sup>

Classification	Specification
U.S.A. and Canada	75D23L (12V-65Ah/20HR) or 80D26L (12V-65Ah/20HR)
Mexico	75D23L (12V-65Ah/20HR)

\*<sup>1</sup> The battery specification differs depending on the country or region. Check the battery installed on the vehicle and use a battery with an equal or higher performance. However, the performance of the battery may vary even among the same battery types, consult an Authorized Mazda Dealer for replacement.

### Spark-plug

Classification	Specification	
e-SKYACTIV G	Mazda Genuine spark plug* <sup>1</sup>	H301-18-110 or H302-18-110

\*<sup>1</sup> This spark plug provides the e-SKYACTIV G engine with optimum performance. Consult an Authorized Mazda Dealer for details.



When cleaning the iridium plugs, do not use a wire brush. The fine particulate coating on the iridium alloy and platinum tips could be damaged.

# Vehicle Specification

## Lubricant Quality

Lubricant	Classification
Engine oil	Refer to Recommended Oil on page 9-18.
Coolant	FL-22 type
Automatic transmission fluid* <sup>1</sup>	Mazda Original Oil ATF-A7
Transfer case oil* <sup>2</sup>	
Front differential oil* <sup>2</sup>	Mazda Long Life Hypoid Gear Oil SG1
Rear differential oil* <sup>2</sup>	
Brake fluid	Mazda Genuine Brake Fluid or equivalent

\*1 Periodic replacement is unnecessary.

\*2 Replacement is necessary when the component is submerged in water.

**NOTE**

Refer to Inspection and Servicing on (page 9-4) for owner's responsibility in protecting your investment.

## Capacities

### (Approximate Quantities)

Item		Normal specification	Large towing capacity specification
Engine oil	With oil filter replacement	6.0 L (6.3 US qt, 5.3 Imp qt)	
	Without oil filter replacement	5.7 L (6.0 US qt, 5.0 Imp qt)	
Coolant	For engine	10.0 L (10.6 US qt, 8.80 Imp qt)	11.1 L (11.7 US qt, 9.77 Imp qt)
	For water-cooled charge air cooler	5.4 L (5.7 US qt, 4.8 Imp qt)	
Automatic transmission fluid		8.5 L (9.0 US qt, 7.5 Imp qt)	
Transfer case oil		0.51 L (0.54 US qt, 0.45 Imp qt)	
Front differential oil		0.35 L (0.37 US qt, 0.31 Imp qt)	
Rear differential oil		0.90 L (1.0 US qt, 0.8 Imp qt)	
Fuel tank		74.0 L (19.5 US gal, 16.3 Imp gal)	

Check oil and fluid levels with dipsticks or reservoir gauges.

# Vehicle Specification

---

## Dimensions

Item		Vehicle specification
Overall length		5,100 mm (200.8 in)
Overall width		1,994 mm (78.5 in)
Overall height	Without roof rail	1,743 mm (68.6 in)
	With roof rail	1,748 mm (68.8 in)
Front tread		1,705 mm (67.1 in)
Rear tread		1,708 mm (67.2 in)
Wheelbase		3,120 mm (122.8 in)

# Vehicle Specification

## Weights

### U.S.A. and Canada

Item		Moonroof	Panorama sunroof (STANDARD POWER)	Panorama sunroof (HIGH POWER)	Without moon- roof/panorama sunroof
GVWR (Gross Vehicle Weight Rating)		2,688 kg (5,926 lb)	2,711 kg (5,977 lb)	2,728 kg (6,014 lb)	2,675 kg (5,897 lb)
GAWR (Gross Axle Weight Rating)	Front	1,271 kg (2,802 lb)	1,282 kg (2,826 lb)	1,287 kg (2,837 lb)	1,266 kg (2,791 lb)
	Rear	1,421 kg (3,133 lb)	1,433 kg (3,159 lb)	1,445 kg (3,186 lb)	1,413 kg (3,115 lb)

### Mexico

Item		Moonroof	Panorama sunroof (STANDARD POW- ER)	Panorama sunroof (HIGH POWER)	Without moon- roof/panorama sunroof
GVW (Gross Ve- hicle Weight)	Total	2,665 kg (5,875 lb)	2,688 kg (5,926 lb)	2,705 kg (5,964 lb)	2,652 kg (5,847 lb)
	Front	1,268 kg (2,795 lb)	1,278 kg (2,818 lb)	1,283 kg (2,829 lb)	1,263 kg (2,784 lb)
	Rear	1,397 kg (3,080 lb)	1,410 kg (3,109 lb)	1,422 kg (3,135 lb)	1,389 kg (3,062 lb)
GAW (Per- missible axle load)	Front	1,286 kg (2,835 lb)	1,296 kg (2,857 lb)	1,301 kg (2,868 lb)	1,281 kg (2,824 lb)
	Rear	1,455 kg (3,208 lb)	1,468 kg (3,236 lb)	1,480 kg (3,263 lb)	1,447 kg (3,190 lb)

## Vehicle Specification

---

### Light Bulbs

#### Exterior light/Interior light

All the light bulbs are the LED type.

The LED bulb cannot be replaced as a single unit because it is an integrated unit.

The LED bulb has to be replaced with the unit. If a replacement is necessary, consult an Authorized Mazda Dealer.

## Tires

### Sample tire mark and its meaning

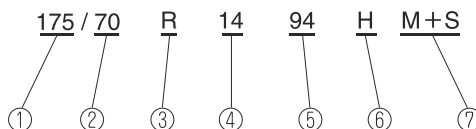

1. Nominal section width
2. Nominal aspect ratio in %
3. Construction code
4. Nominal rim diameter in inches
5. Load index (not on ZR tires)
6. Speed symbol
7. Mud and snow

### Tire mark information

Choose the proper tires for your vehicle using the following tire mark information.

Speed symbol	Maximum permissible speed
Q	Up to 160 km/h (99 mph)
R	Up to 170 km/h (105 mph)
S	Up to 180 km/h (111 mph)
T	Up to 190 km/h (118 mph)
U	Up to 200 km/h (124 mph)
H	Up to 210 km/h (130 mph)
V	Up to 240 km/h (149 mph)
W	Up to 270 km/h (167 mph)
Y	Up to 300 km/h (186 mph)
ZR	Over 240 km/h (149 mph)

### Tire and inflation pressure

#### NOTE

The tires have been optimally matched with the chassis of your vehicle. When replacing tires, Mazda recommends that you replace tires of the same type originally fitted to your vehicle. For details, contact an Authorized Mazda Dealer.

Check the tire pressure label for tire size and inflation pressure. Refer to Tire Pressure Label on page 10-59.



## Vehicle Specification

---

### Standard tire

#### (U.S.A. and Canada)

Tire size	Front	Rear
265/55R19 109V	250 kPa (2.5 bar, 36 psi)	250 kPa (2.5 bar, 36 psi)
275/45R21 107W	250 kPa (2.5 bar, 36 psi)	250 kPa (2.5 bar, 36 psi)

Single occupant's weight: About 75 kg

#### (Mexico)

Tire size		Up to 3 persons	—Full load
275/45R21 107W	Front	250 kPa (2.5 bar, 36 psi)	280 kPa (2.8 bar, 41 psi)
	Rear	250 kPa (2.5 bar, 36 psi)	290 kPa (2.9 bar, 42 psi)

Single occupant's weight: About 75 kg

### Temporary spare tire\*

#### (U.S.A. and Canada)

Tire size	Inflation pressure
T155/90D18 103M	420 kPa (4.2 bar, 60 psi)

#### (Mexico)

Tire size	Inflation pressure
T155/90D18 113M	420 kPa (4.2 bar, 60 psi)

### Lug nut tightening torque

When installing a tire, tighten the lug nut to the following torque.

108—147 N·m (12—14 kgf·m, 80—108 ft·lbf)



# Index

---

## A

- Active Driving Display.....5-50
  - Active driving display does not operate..... 8-35
  - Maintenance of the dust-proof sheet..... 9-46
- Add-On Non-Genuine Parts and Accessories..... 10-25
- Air Bags..... 3-4
  - Driver and front passenger occupant classification system..... 3-18
  - Front passenger occupant classification system.....3-18
- Air-Conditioning
  - Air vents..... 6-2
  - Air-conditioning overview..... 6-6
  - Maintenance..... 9-38
  - Operating each switch..... 6-7
- Alexa.....7-22
  - Check alexa settings..... 8-62
- Automatic Transmission
  - Selector lever..... 5-54
  - Steering shift switches..... 5-59
- AWD
  - i-ACTIV AWD..... 5-105

## B

- Battery
  - Electrical system..... 10-63
  - Inspecting Lead-acid battery..... 9-24
  - Taking action with depleted lead-acid battery.....8-11
- Brakes
  - Antilock Brake System (ABS)..... 5-92
  - AUTOHOLD..... 5-71

- AUTOHOLD cannot be canceled..... 8-18
- Brake override system..... 5-69
- Dynamic Stability Control (DSC)..... 5-95
- Electric Parking Brake (EPB)....5-65
- Hill descent control..... 5-99
- Hill Launch Assist (HLA)..... 5-74
- Inspecting the brake fluid..... 9-21
- Problem with the brake system (foot brake).....8-17
- Traction Control System (TCS)..... 5-93
- Trailer Stability Control (TSC)..... 5-97

## C

- Cell Phones..... 10-26
- Cruise Control..... 5-246
- Customer Assistance (Canada)... 10-9
- Customer Assistance (Mexico).....  
..... 10-15
- Customer Assistance (Puerto Rico)..... 10-13
- Customer Assistance (U.S.A.)..... 10-4

## D

- Doors
  - Doors..... 4-12
  - Liftgate.....4-17

## E

- Engine
  - Engine.....10-61
  - Engine cannot be stopped..... 8-16
  - Engine number..... 10-60
  - Inspecting the coolant..... 9-20
  - Inspecting/replenishing engine oil.....9-18
  - i-stop.....5-21

Overheating..... 8-19  
 Push button start..... 5-13  
 Starting a flooded engine..... 8-15  
 Taking action with depleted lead-  
 acid battery..... 8-11

## H

Hood.....4-26  
 Hybrid System  
   High voltage battery..... 10-62

## I

Inspection and Maintenance  
   Air conditioner  
     maintenance..... 9-38  
   Capacities..... 10-65  
   Dimensions..... 10-66  
   Lubricant quality..... 10-64  
   Motor Vehicle Safety Standard  
   Label.....10-58  
   Vehicle Emission Control  
   Information Label..... 10-59  
   Weights.....10-67  
 Inspection and Servicing  
   Body lubrication..... 9-27  
   Brake fluid.....9-21  
   Coolant..... 9-20  
   Daily inspection..... 9-12  
   Engine oil..... 9-18  
   Fuses..... 9-26  
   Inspecting the tires..... 9-32  
   Inspection and servicing..... 9-4  
   Lead-acid battery..... 9-24  
   Light bulbs..... 9-36  
   Replacing a tire or a wheel... 9-35  
   Rotating the tires..... 9-34  
   Windshield washer fluid..... 9-23  
   Windshield wiper blade  
   rubbers..... 9-28  
 Instrument Cluster

Warning/Indicator light turns  
 on..... 8-36  
 Instrument Cluster (Type A)  
   Average fuel economy  
   display..... 5-33  
   Compass display..... 5-35  
   Dashboard illumination..... 5-30  
   Deceleration regeneration charge  
   display..... 5-34  
   Engine coolant temperature  
   gauge.....5-29  
   Fuel gauge..... 5-30  
   Instantaneous fuel economy  
   display..... 5-34  
   Instrument cluster.....5-23  
   i-ACTIVSENSE status symbol  
   (Warning/Risk avoidance support  
   system)..... 5-35  
   Maximum driving distance  
   display..... 5-32  
   Message display..... 5-36  
   Odometer/Trip meter.....5-28  
   Outside temperature  
   display..... 5-32  
   Speedometer..... 5-27  
   Tachometer..... 5-28  
 Instrument Cluster (Type B)  
   Average fuel economy  
   display..... 5-46  
   Compass display..... 5-48  
   Dashboard illumination..... 5-43  
   Deceleration regeneration charge  
   display..... 5-47  
   Engine coolant temperature  
   gauge.....5-42  
   Fuel gauge..... 5-43  
   Instantaneous fuel economy  
   display..... 5-47  
   Instrument cluster.....5-37  
   i-ACTIVSENSE display..... 5-48

# Index

---

- Maximum driving distance display..... 5-45
  - Message display..... 5-49
  - Multi-information display..... 5-39
  - Odometer/Trip meter..... 5-41
  - Outside temperature display..... 5-45
  - Speedometer..... 5-37
  - Tachometer..... 5-38
  - Interior Equipment
    - Accessory sockets..... 7-44
    - AC power outlet (220 V/150 W)..... 7-45
    - Ambient lights..... 7-43
    - Bottle holder..... 7-29
    - Center console..... 7-31
    - Cup holders..... 7-28
    - Door courtesy lights..... 7-42
    - Glove compartment..... 7-30
    - How to use the assist grips.... 7-54
    - Illuminated entry system..... 7-39
    - Luggage compartment..... 7-35
    - Luggage compartment cover..... 7-56
    - Luggage compartment lights..... 7-42
    - Map lights..... 7-41
    - Overhead console..... 7-32
    - Overhead lights..... 7-40
    - Rear coat hooks..... 7-33
    - Sunvisor..... 7-36
    - USB power outlet..... 7-48
    - Vanity mirrors..... 7-37
    - Wireless charger (Qi)..... 7-50
  - i-ACTIVSENSE
    - Adaptive Front Lighting System (AFS)..... 5-138
    - Blind Spot Monitoring (BSM)..... 5-146
    - Cameras..... 5-135
    - Cruising & Traffic Support (CTS)..... 5-182
    - Distance & Speed Alert (DSA)..... 5-154
    - Driver Attention Alert (DAA)..... 5-156
    - Driver monitoring camera.... 5-137
    - Driver Monitoring (DM)..... 5-159
    - Emergency Lane Keeping (ELK)..... 5-207
    - Forward Sensing Camera (FSC)..... 5-125
    - Front Cross Traffic Alert (FCTA)..... 5-164
    - High Beam Control System (HBC)..... 5-139
    - i-ACTIVSENSE mute switch ..... 5-124
    - i-ACTIVSENSE status symbol (Warning/risk avoidance support system)..... 5-121
    - Lane Departure Warning System (LDWS)..... 5-143
    - Lane-keep Assist System (LAS)..... 5-204
    - Mazda Radar Cruise Control (MRCC)..... 5-169
    - Radar sensors..... 5-129
    - Rear Cross Traffic Alert (RCTA)..... 5-167
    - Secondary Collision Reduction..... 5-244
    - Smart Brake Support (SBS)... 5-214
    - Traffic Sign Recognition System (TSR)..... 5-151
    - 360° View Monitor..... 5-224
- K**
- Key..... 4-5

- Canceling the key temporary suspension function..... 8-8
  - Replacing the key battery..... 9-39
  - Starting the Engine with a dead key battery..... 8-9
  - Unlocking using the auxiliary key..... 8-8
- L**
- Liftgate..... 4-17
    - Liftgate cannot open..... 8-29
    - Power liftgate..... 4-20
  - Light
    - Washer fluid does not spray... 8-34
  - Lights
    - Hazard warning lights..... 5-90
    - Light bulbs..... 10-68
    - Light switch..... 5-75
    - Replacing light bulbs..... 9-36
    - Turn signal lever..... 5-80
- M**
- Maintenance
    - Dashboard..... 9-44
    - Dust-proof sheet of the active driving display..... 9-46
    - Exterior..... 9-41
    - Interior..... 9-43
    - Leather upholstery..... 9-45
    - Seat belts..... 9-46
    - Upholstery and synthetic leather..... 9-44
    - Wheel..... 9-42
  - Mazda Connect
    - Connected service (If applicable)..... 7-13
    - Mazda connect..... 7-4
    - Mazda connect overview..... 7-7
  - Mazda intelligent Drive Select (Mi-Drive)..... 5-102
  - Mazda M Hybrid Boost
    - Mazda M Hybrid Boost Battery..... 10-62
  - Mirrors
    - Mirror defogger..... 5-87
    - Outside mirrors..... 5-9
    - Rearview mirror..... 5-12
  - Moonroof..... 4-35
  - M Hybrid Boost
    - M Hybrid Boost..... 5-16
    - Push button start..... 5-13
- P**
- Panorama Sunroof
    - The panorama sunroof cannot be operated..... 8-31
  - Parking Sensor..... 5-258
- R**
- Rear View Monitor..... 5-250
  - Refueling..... 5-112
    - Fuel requirements..... 5-114
  - Registering Your Vehicle in A Foreign Country..... 10-24
- S**
- Safety Defects, Reporting (Canada)..... 10-22
  - Safety Defects, Reporting (U.S.A.)..... 10-21
  - Seat
    - Child-restraint system..... 3-46
    - Driving position memory..... 3-35
    - Rear seat..... 3-39
  - Seats
    - Armrests..... 3-41
    - Front seats..... 3-33
    - Head restraints..... 3-42
    - How to Use the Driving Position Memory..... 3-36

# Index

---

Leather upholstery maintenance.....	9-45
Seat ventilation.....	6-24
Seat warmer.....	6-19
Upholstery and synthetic leather maintenance.....	9-44
Seat Belts.....	3-23
Maintenance.....	9-46
Security System.....	4-36
Immobilizer system.....	4-38
Theft-Deterrent System.....	4-39
Steering Wheel	
Heated steering wheel.....	6-22
Power steering.....	5-106
Steering shift switches.....	5-59
Sunroof	
Panorama sunroof.....	4-31
<b>T</b>	
Tires	
Inspecting the tires.....	9-32
Replacing a tire or a wheel....	9-35
Rotating the tires.....	9-34
Tires.....	10-69
Tire pressure label.....	10-59
Tire Pressure Monitoring System (TPMS).....	5-107
Uniform tire quality grading system (UTQGS).....	10-27
Wheel maintenance.....	9-42
Tire Information	
Location of the tire label (placard).....	10-34

Steps for determining the correct load limit.....	10-45
Tire labeling.....	10-30
Tire maintenance.....	10-37
Vehicle loading.....	10-40
Towing	
Having the vehicle towed.....	8-5
Using the towing hooks.....	8-6
Turbocharged vehicles.....	5-267

## W

Warranty.....	10-23
Window	
Power window.....	4-28
Rear window defogger switch.....	5-86
The power windows cannot be operated.....	8-30
Windshield wiper de-icer.....	5-88
Winter Driving.....	5-264
Wipers	
Replacing windshield wiper blade rubbers.....	9-28
Replenishing windshield washer fluid.....	9-23
Washer fluid does not spray...	8-34
Windshield wipers operate at high speed.....	8-33
Windshield wiper de-icer.....	5-88
Windshield wiper/Washer switch.....	5-81