

GR *Supra*



1 NOTES**1-1. NOTES**

Information 4

2 QUICK REFERENCE**2-1. QUICK REFERENCE**

Entering..... 18

Set-up and use.....24

In transit27

3 CONTROLS**3-1. CONTROLS**

Cockpit 38

Sensors of the vehicle.....42

Operating state of the vehicle
.....45

Toyota Supra Command50

General settings64

Personal settings67

Connections72

Opening and closing81

Seats, mirrors, and steering
wheel..... 100Transporting children safely
..... 114

Driving..... 120

Displays 139

Lights 159

Safety 165

Driving stability control systems
..... 201

Driver assistance systems . 206

Driving comfort 234

Climate control 235

Interior equipment 244

Storage compartments..... 254

Cargo area 256

4 DRIVING TIPS**4-1. DRIVING TIPS**Things to remember when driv-
ing..... 262

Saving fuel 267

5 MOBILITY**5-1. MOBILITY**

Refueling..... 272

Wheels and tires 274

Engine compartment..... 300

Operating materials..... 303

Maintenance 312

Replacing components 314

Breakdown assistance 325

Care 335

6 REFERENCE**6-1. REFERENCE**

Technical data 344

Certification 347

Index

Alphabetical Index..... 362

NOTES

1

3

1-1. NOTES

Information 4

1

NOTES

Information

Using this Owner's Manual

Orientation

The fastest way to find information on a particular topic is by using the index.



Additional sources of information

Your Toyota dealer

Your Toyota dealer will be glad to answer questions at any time.

Symbols and displays

Symbols in the Owner's Manual

Symbol	Meaning
	Precautions that must be followed in order to avoid the possibility of injury to yourself and to others as well as serious damage to the vehicle.
	Measures that can be taken to help protect the environment.
"..."	Texts in vehicle used to select Customize functions.

Symbol	Meaning
›...‹	Verbal instructions to use with the voice activation system.
››...‹‹	Responses generated by the voice activation system.
1 2 3...	Indicates operating or working procedures. Follow the steps in numerical order.

Action steps

Action steps to be carried out are presented as a numbered list. The steps must be carried out in the defined order.

- 1 First action step.
- 2 Second action step.

Symbols on vehicle components

 This symbol on a vehicle component indicates that further information on the component is available in the Owner's Manual.

Vehicle features and options

This Owner's Manual describes all models and all standard, country-specific and optional equipment that is offered in the model series. Therefore, this Owner's Manual also describes and illustrates features and

functions that are not available in a vehicle, for example because of the selected optional features or the country-specific version.

This also applies to safety-related functions and systems.

When using these functions and systems, the applicable laws and regulations must be observed.

For any options and equipment not described in this Owner's Manual, refer to the Supplementary Owner's Manuals.

Toyota is happy to answer any questions that you may have about the features and options applicable to your vehicle.

Status of the Owner's Manual

Basic information

The manufacturer of your vehicle pursues a policy of constant development that is conceived to ensure that our vehicles continue to embody the highest quality and safety standards. In rare cases, therefore, the features described in this Owner's Manual may differ from those in your vehicle.

For Your Own Safety

Intended use

Follow the following when using the vehicle:

- Owner's Manual.
- Information on the vehicle. Do not remove stickers.
- Technical vehicle data.
- The traffic, speed, and safety laws where the vehicle is driven.
- Vehicle documents and statutory documents.

Warranty

Your vehicle is technically configured for the operating conditions and registration requirements applying in the country of first delivery, also known as homologation. If your vehicle is to be operated in a different country it might be necessary to adapt your vehicle to potentially differing operating conditions and registration requirements. If your vehicle does not comply with the homologation requirements in a certain country you may not be able to lodge warranty claims for your vehicle there. Further information on warranty is available from your Toyota dealer.

Maintenance and repairs

Advanced technology, e.g. the use of modern materials and high-performance electronics, requires suitable maintenance and repair work.

If work is performed improperly, for instance maintenance and repair, there is a risk of subsequent damage and related safety risks.

Improperly performed work on the vehicle paint can lead to a failure or malfunction of components, e.g., the radar sensors, and thereby result in a safety risk.

Parts and accessories

Toyota recommends the use of parts and accessory products approved by Toyota.

Approved parts and accessories, and advice on their use and installation are available from Toyota.

Toyota parts and accessories have been tested by Toyota for their safety and suitability in Toyota vehicles.

Toyota warrants genuine Toyota parts and accessories.

Toyota does not evaluate whether each Customize product from another manufacturer can be used with Toyota vehi-

cles without presenting a safety hazard, even if a country-specific official approval was issued. Toyota does not evaluate whether these products are suitable for Toyota vehicles under all usage conditions.

California Proposition 65 Warning

California law requires vehicle manufacturers provide the following warning:

WARNING

Engine exhaust and a wide variety of Automobile components and parts, including components found in the interior furnishings in a vehicle, contain or emit chemicals known to the State of California to cause cancer and birth defects and reproductive harm. In addition, certain fluids contained in vehicles and certain products of component wear contain or emit chemicals known to the State of California to cause cancer and birth defects or other reproductive harm. Battery posts, terminals and related accessories contain lead and lead compounds. Batteries also contain other chemicals known to the State of California to cause cancer. Wash your hands after handling. Used engine oil contains chemicals that have caused cancer in laboratory animals. Always protect your skin by washing thoroughly with soap and water. For more information go to www.P65Warnings.ca.gov/passenger-vehicle.

**WARNING**

Operating, servicing and maintaining a passenger vehicle or off-highway motor vehicle can expose you to chemicals including engine exhaust, carbon monoxide, phthalates, and lead, which are known to the State of California to cause cancer and birth defects or other reproductive harm. To minimize exposure, avoid breathing exhaust, do not idle the engine except as necessary, service your vehicle in a well-ventilated area and wear gloves or wash your hands frequently when servicing your vehicle. For more information go to www.P65Warnings.ca.gov/passenger-vehicle.

Service and warranty

We recommend that you read this publication thoroughly.

Detailed information about warranty is listed in the "Owner's Warranty Information Booklet" or "Owner's Manual Supplement".

Your vehicle has been specifically adapted and designed to meet the particular operating conditions and homologation requirements in your country and continental region in order to deliver the full driving pleasure while the vehicle is operated under those conditions. If you wish to operate your vehicle in another country or region, you may be required to adapt your vehicle to meet different prevailing operating conditions and

homologation requirements. You should also be aware of any applicable warranty limitations or exclusions for such country or region. In such case, please contact your Toyota dealer for further information.

Maintenance

Maintain the vehicle regularly to sustain the road safety, operational reliability and the warranty.

Specifications for required maintenance measures:

- Maintenance system.
- "Owner's Warranty Information Booklet" or "Owner's Manual Supplement".

If the vehicle is not maintained according to these specifications, this could result in serious damage to the vehicle. Such damage is not covered by the warranty.

Cyber Attack Risk

Installing electronic devices and radios increases the risk of cyber attacks through the installed parts, which may lead to unexpected accidents and leakage of personal information. Toyota does not make any guarantees for problems caused by installing non-genuine Toyota products.

Data memory

General information

Electronic control devices are installed in the vehicle. Electronic control units process data they receive from vehicle sensors, self-generate or exchange with each other. Some control units are necessary for the vehicle to function safely or provide assistance during driving, for instance driver assistance systems. Furthermore, control units facilitate comfort or infotainment functions.

Personal reference

Each vehicle is marked with a unique vehicle identification number. Depending on the country, the vehicle owner can be identified with the vehicle identification number, license plate and corresponding authorities. In addition, there are other ways to associate data collected from the vehicle with the driver or vehicle owner, e.g., the Toyota Supra Connect account used.

Operating data in the vehicle

Control units process data to operate the vehicle.

For example, this includes:

- Status messages for the vehicle and its Customize components, e.g., wheel rotational speed, wheel speed, deceleration, transverse acceleration, engaged safety belt indicator.
- Ambient conditions, e.g., temperature, rain sensor signals.

The processed data is only processed in the vehicle itself while the vehicle is being operated. Data is not stored beyond the operating time.

Electronic components, e.g. control units and ignition keys, contain components for storing technical information. Information about the vehicle condition, component usage, maintenance requirements or faults can be stored temporarily or permanently.

This information generally records the state of a component, a module, a system, or the environment, for instance:

- Operating states of system components, e.g., fill levels, tire inflation pressure, battery status.
- Malfunctions and faults in important system components, for instance lights and brakes.
- Responses by the vehicle to special situations such as air-bag deployment or engagement of the driving stability control systems.

- Information on vehicle-damaging events.

The data is required to perform the control unit functions. Furthermore, it also serves to recognize and correct malfunctions, and helps the vehicle manufacturer to optimize vehicle functions.

The majority of this data is volatile and is only processed within the vehicle itself. Only a small share of data is stored in event or fault memories based on an event.

When servicing, for instance during repairs, service processes, warranty cases, and quality assurance measures, this technical information can be read out from the vehicle together with the vehicle identification number.

Your Toyota dealer can read out the information. The diagnostic socket required by law in the vehicle is used to read out the data.

The data is collected, processed, and used by the relevant organizations in the service network. The data documents technical conditions of the vehicle, helps with the identification of the fault, compliance with warranty obligations and quality improvement.

The data from the vehicle can

also be used to check customer claims for warranty and guaranty.

Fault and event memories in the vehicle can be reset when your Toyota dealer performs repair or servicing work.

Data entry and data transfer into the vehicle

General information

Depending on the vehicle equipment, comfort and Customize settings can be stored in the vehicle and modified or reset at any time.

For example, this includes:

- Setting for the seat position.
- Suspension and climate control settings.

If necessary, data can be transferred to the entertainment and communication system of the vehicle, e.g. via smartphone.

This includes the following depending on the respective equipment:

- Multimedia data such as music, films or photos for playback in an integrated multimedia system.
- Address book data for use in conjunction with an integrated hands-free system or an integrated navigation system.
- Entered navigation destinations.

- Data on the use of Internet services.

This data can be stored locally in the vehicle or is found on a device that has been connected to the vehicle, e.g., a smart-phone, USB stick or MP3 player. If this data is stored in the vehicle, it can be deleted at any time.

This data is only transmitted to third parties upon personal request as part of the use of online services. The transmission depends on the selected settings for the use of the services.

Incorporation of mobile devices

Depending on the vehicle equipment, mobile devices connected to the vehicle, for instance smartphones, can be controlled via the vehicle control elements.

The sound and picture from the mobile device can be played back and displayed through the multimedia system. Certain information is transferred to the mobile device at the same time. Depending on the type of incorporation, this includes, for instance position data and other general vehicle information. This optimizes the way in which selected apps, for instance navigation or music playback, work.

There is no further interaction between the mobile device and the vehicle, such as active access to vehicle data.

How the data will be processed further is determined by the provider of the particular app being used. The extent of the possible settings depends on the respective app and the operating system of the mobile device.

Services

General information

If the vehicle has a wireless network connection, this enables data to be exchanged between the vehicle and other systems. The wireless network connection is realized via an in-vehicle transmitter and receiver unit or via personal mobile devices brought into the vehicle, for instance smartphones. This wireless network connection enables 'online functions' to be used. These include online services and apps supplied by the vehicle manufacturer or by other providers.

Services from the vehicle manufacturer

Where online services from the vehicle manufacturer are concerned, the corresponding functions are described in the

appropriate place, for instance the Owner's Manual or manufacturer's website. The relevant legal information pertaining to data protection is provided there too. Personal data may be used to perform online services. Data is exchanged over a secure connection, for instance with the IT systems of the vehicle manufacturer intended for this purpose.

Any collection, processing, and use of personal data above and beyond that needed to provide the services must always be based on a legal permission, contractual arrangement or consent. It is also possible to activate or deactivate the data connection as a whole. That is, with the exception of functions and services required by law such as Assist systems.

Services from other providers

When using online services from other providers, these services are the responsibility of the relevant provider and subject to their data privacy conditions and terms of use. The vehicle manufacturer has no influence on the content exchanged during this process. Information on the way in which personal data is collected and used in relation to services from third parties, the scope of such

data, and its purpose, can be obtained from the relevant service provider.

Statement on Warranty Coverage for Aftermarket and Recycled Parts (For U.S. Owners)

The Magnuson-Moss Warranty Act, 15 U.S.C. s.2301 et seq., makes it illegal for motor vehicle manufacturers to void a motor vehicle warranty or deny warranty coverage solely because an aftermarket or recycled part has been used to repair the vehicle or someone other than the authorized service provider performed service on the vehicle. This provision does not apply to a new motor vehicle purchased solely for commercial or industrial use.

Under federal law, a manufacturer may deny warranty coverage and charge for repairs to a vehicle if it is discovered that an aftermarket or recycled part installed on the vehicle is defective or was installed incorrectly and caused damage to another part of the vehicle otherwise covered under warranty. The Federal Trade Commission requires that a manufacturer demonstrate that an aftermarket or recycled part or service performed by a person other than an authorized service pro-

vider caused damage to another part of the vehicle otherwise covered under warranty before denying warranty coverage. Additionally, federal law allows a manufacturer to void a motor vehicle warranty or deny warranty coverage if the manufacturer provides the article or service to consumers free of charge under the warranty or the manufacturer has secured a waiver from the Federal Trade Commission.

Event data recorder

This vehicle is equipped with an event data recorder. The main purpose of this component is to record data that will help understand how vehicle systems performed in certain crash or near-crash situations, e.g., air-bag deployment or a collision with a road obstacle. The event data recorder is designed to record data on driving dynamics and safety systems for a short time of max. 30 seconds, typically less.

This vehicle's event data recorder is designed to record data on the following, for example:

- How the vehicle's various systems performed.
- Whether or not the driver and passenger safety belts were fastened.

- How far, if at all, the driver was depressing the accelerator and/or brake pedal.
- How fast the vehicle was traveling.

This data can help provide a better understanding of the circumstances in which crashes and injuries occur.

Under normal driving conditions, no data is recorded by the event data recorder and no personal data is stored, e.g., name, gender, age, and accident location.

However, other parties, e.g., law enforcement agencies, may combine the recorded data with the personally identifiable data that is routinely collected during a crash investigation.

Special equipment and access to the vehicle or event data recorder are required to read out recorded data. In addition to the vehicle manufacturer, other parties, e.g., law enforcement agencies, may have the special equipment necessary to read this information if these parties have access to the vehicle or event data recorder.

Vehicle identification number

General information

Depending on the national-mar-

ket version, the vehicle identification number is located in different positions in the vehicle. This chapter describes all positions that are possible for the series.

Engine compartment

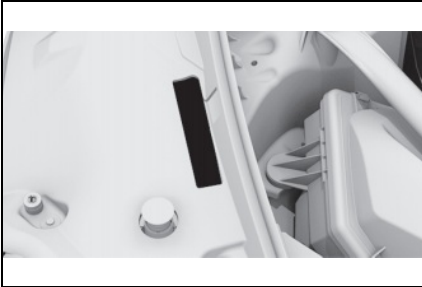

The vehicle identification number can be found in the engine compartment, on the right-hand side of the vehicle.

Right nameplate



The vehicle identification number can be found on the nameplate, on the right-hand side of the vehicle.

Left nameplate



The vehicle identification number can be found on the nameplate, on the left-hand side of the vehicle.

Windshield



The vehicle identification number can also be found behind the windshield.

“QR Code”

The word “QR Code” is registered trademark of DENSO WAVE INCORPORATED in Japan and other countries.

Other Precautions

WARNING

Do not modify the vehicle.

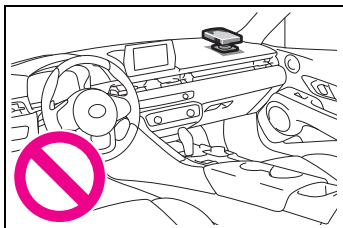

Do not modify the vehicle with any parts (ex. batteries, electrical components, etc.) other than Toyota genuine parts and accessories or Toyota approved parts, as doing so may cause an unexpected malfunction or an accident. For information on Toyota genuine parts and accessories, contact a Toyota dealer.

WARNING

Do not install any accessories to the windshield.

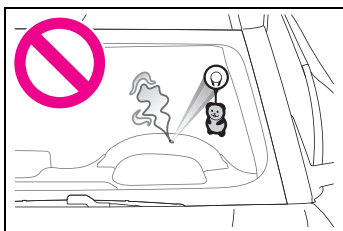

If an accessory is installed to the windshield or the rear view mirror, it may block your vision of the road or become a distraction, possibly leading to an accident. Also, if an object such as a suction cup is attached to the windshield, it may act as a lens and possibly cause a fire. Do not install a wide view mirror to the rear view mirror as it may come loose in a collision and cause injury.

WARNING

■ When the vehicle is parked

- Do not leave glasses, cigarette lighters, spray cans, or soft drink cans in the vehicle when it is in the sun. Doing so may result in the following:
 - Gas may leak from a cigarette lighter or spray can, and may lead to a fire.
 - The temperature inside the vehicle may cause the plastic lenses and plastic material of glasses to deform or crack.
 - Soft drink cans may fracture, causing the contents to spray over the interior of the vehicle, and may also cause a short circuit in the vehicle's electrical components.

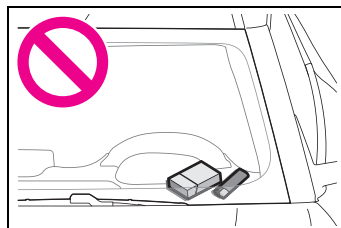

**WARNING****■ Items that should not be left in the storage spaces**

Do not leave glasses, lighters or spray cans in the storage spaces, as this may cause the following when cabin temperature becomes high:

- Glasses may be deformed by heat or cracked if they come into contact with other stored items.
- Lighters or spray cans may explode. If they come into contact with other stored items, the lighter may catch fire or the spray can may release gas, causing a fire hazard.

Reporting safety defects**For US customers**

The following only applies to vehicles owned and operated in the US.

If you believe that your vehicle has a defect which could cause a crash or could cause injury or death, you should immediately inform the National Highway Traffic Safety Administration (NHTSA) in addition to notifying Toyota Motor Sales, U.S.A., Inc. (Toll-free: 1-800-331-4331).

If NHTSA receives similar complaints, it may open an investigation, and if it finds that a safety defect exists in a group of vehicles, it may order a recall and remedy campaign. How-

ever, NHTSA cannot become involved in individual problems between you, your dealer, or Toyota Motor Sales, U.S.A., Inc.

To contact NHTSA, you may call the Vehicle Safety Hotline toll-free at 1-888-327-4236 (TTY: 1-800-424-9153); go to <http://www.safercar.gov>; or write to: Administrator, NHTSA, 1200 New Jersey Ave, S.E., Washington, DC 20590. You can also obtain other information about motor vehicle safety from <http://www.safercar.gov>.

For Canadian customers

Canadian customers who wish to report a safety-related defect to Transport Canada, Defect Investigations and Recalls, may call the toll-free customer support 1-800-333-0510. You can also obtain other information about motor vehicle safety from <http://www.tc.gc.ca/roadsafety>.

QUICK REFERENCE

2

2-1. QUICK REFERENCE

Entering.....	18
Set-up and use.....	24
In transit	27

2

Entering

Before driving

Vehicle inspection

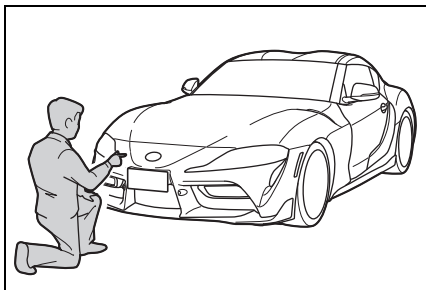

Before starting the engine, perform the necessary routine vehicle checks. It is the owner's responsibility to perform routine vehicle checks and any legally necessary yearly inspections, according to any local laws and regulations. For details about inspection procedures, refer to the Service Book (Maintenance Guide).

If a fuel can, combustible car care products, spray cans, etc. are left in the vehicle, there is a danger that they may catch fire and explode. Also, when the vehicle is parked with the doors and windows completely closed, do not leave containers of carbonated beverages in the vehicle, as the temperature inside the vehicle can increase to over 122°F, depending on the location.

⚠ WARNING

Make sure to securely stow all luggage.

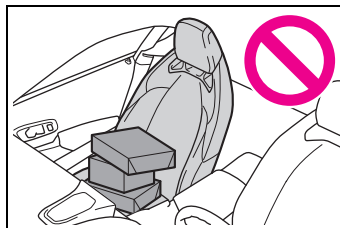

In the case of sudden braking or a collision, unsecured objects may fly about and strike the occupants, possibly causing injury. Make sure to stow luggage securely in the luggage compartment.

⚠ WARNING

Do not leave flammable objects in the vehicle.

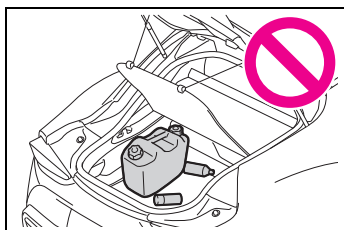

⚠ WARNING

Do not leave objects on the driver's side floor.

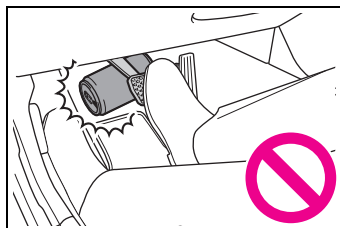

⚠ WARNING

If an object gets stuck behind the brake pedal, braking may be impossible and the accelerator pedal may not return after being depressed, leading to an extremely dangerous situation.

⚠ WARNING

Make sure that the floor mats are securely installed.

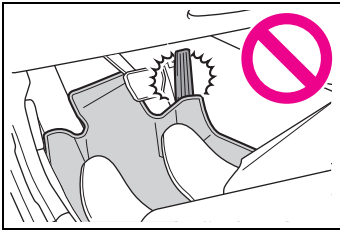

Make sure to only use genuine Toyota floor mats which are designed for this model and secure them in place using the provided fasteners. When the floor mats have been removed, such as when cleaning the vehicle, make sure to securely install the floor mats using the fasteners before driving the vehicle.

If a floor mat which cannot be installed securely, due to a damaged fastener, etc., is used, it may shift while driving and cover the accelerator pedal, possibly depressing it and causing an accident.

Additionally, never install two or more floor mats on top of each other. Not only will additional floor mats interfere with normal operation of the pedals, but there is a danger that a mat may curl behind the brake pedal and prevent it from being depressed.

⚠ WARNING

Be careful not to inhale exhaust gases.

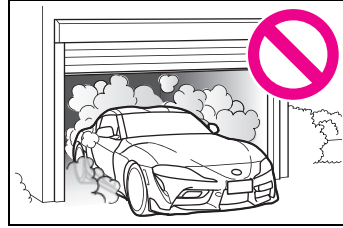

The exhaust includes colorless, odorless carbon monoxide (CO). Carbon monoxide (CO) can be inhaled without noticing and in the worst cases, can cause death. Make sure to not allow the engine to idle in a closed off garage or other location with poor ventilation.

If there is a hole or crack in the exhaust system, caused by corrosion, etc., exhaust gasses may enter the vehicle while driving. If you smell exhaust gasses in the vehicle, completely open all of the windows and have the vehicle inspected by Toyota dealer.

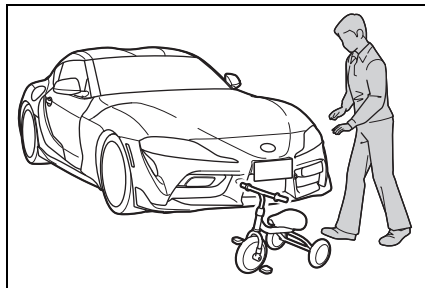
Confirm safety of surroundings

- There are blind spots around the vehicle which cannot be seen from the driver's seat. Make sure to check the area

around the vehicle for small children and low objects before driving.

- When backing up (reversing), if you cannot see the area behind the vehicle sufficiently, exit the vehicle and check the area before proceeding.

When in poor physical condition

Refrain from driving when you are fatigued or not feeling well.

Also, if driving for a long time, be sure to stop and rest periodically.

Opening and closing

Buttons on the remote control



- 1 Unlocking
- 2 Locking
- 3 Unlocking the trunk lid
- 4 Panic mode, pathway lighting

Unlocking the vehicle



Press the button on the remote control.

Depending on the settings, either only the driver's door or all vehicle access points are unlocked.

If only the driver's door is unlocked, press the button on the remote control again to unlock the other vehicle access points.

Locking the vehicle

- 1 Close the driver's door.
- 2  Press the button on the remote control.

All vehicle access points are locked.

Buttons for the central locking system

Overview

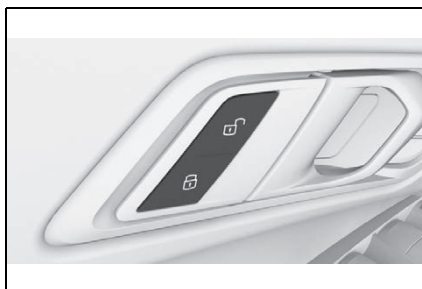

Buttons for the central locking system.

Locking



Pressing the button locks the vehicle if the front doors are closed.

The fuel filler flap remains unlocked.

Unlocking



Pressing the button unlocks the vehicle.

Panic mode

You can trigger the alarm system if you find yourself in a dangerous situation.

-  Press the button on the remote control and hold for at least 3 seconds.
- Briefly press the button on the remote control three times in succession.

To switch off the alarm: press any button.

Smart Key System

Concept

The vehicle can be accessed without operating the vehicle key.

Carrying the vehicle key with you, e.g., in your pants pocket, is sufficient.

The vehicle automatically detects the remote control when it is in close proximity or in the car's interior.

Unlocking the vehicle

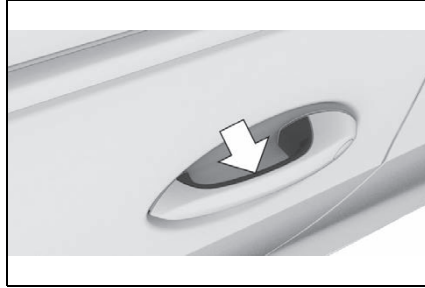

Grasp the handle of a vehicle door completely.

Locking the vehicle

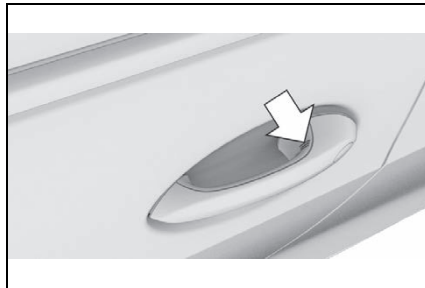

With the doors closed, touch the indentation (lock sensor) on the door handle with a finger for approximately 1 second.

Trunk lid

Opening



Press and hold the button on the remote control for approximately 1 second. Depending on the setting, the doors may also unlock, refer to page 82.

Closing

Close the trunk lid manually.

Displays and control elements

In the vicinity of the steering wheel

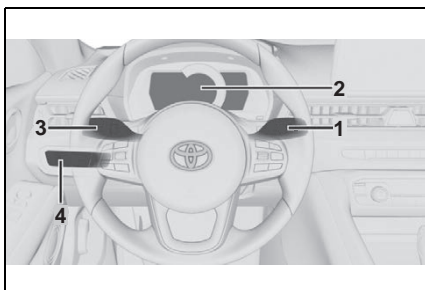

- 1 Wipers
- 2 Instrument cluster
- 3 Turn signal indicator, high beams
- 4 Light switch element

Indicator/warning lights

The indicator/warning lights can

light up in a variety of combinations and colors.

Several of the lights are checked for proper functioning and light up temporarily when the engine is started or standby state is switched on.

Driver's door

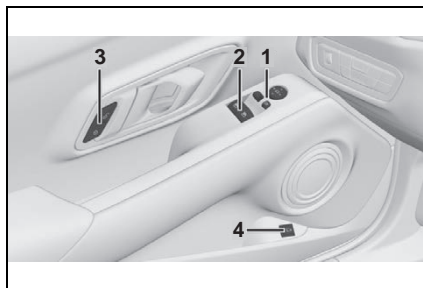

- 1 Exterior mirrors
- 2 Power windows
- 3 Central locking system
- 4 Unlocking the trunk lid

Switch console

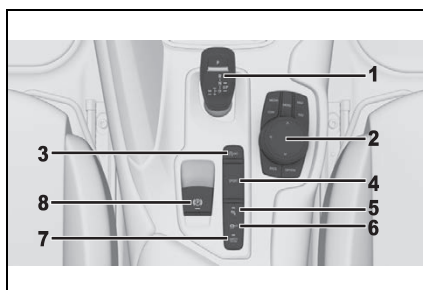

- 1 Selector lever
- 2 Controller
- 3 Auto Start/Stop cancel button
- 4 Sport mode button
- 5 Park Assistant button







- 6 VSC OFF button
- 7 Toyota Supra Safety button
- 8 Parking brake

Toyota Supra Command

Concept

Toyota Supra Command includes a large number of functions. These functions can be operated via controller and, depending on the equipment version, via touch screen or voice activation system.

Buttons on the Controller

Button	Function
	Opens the main menu.
	Opens the Communication menu.
	Opens the Media/Radio menu.
	Opens destination input menu for navigation.
	Opens navigation map.
	Opens the previous display.
	Opens the Options menu.

Voice activation

■ Activating the voice activation system

- 1  Press the button on the steering wheel.
- 2 Wait for the signal.
- 3 Say the command.



The symbol on the Control Display indicates that voice activation system is active.

If no other commands are possible, operate the function via Toyota Supra Command.

■ Terminating the voice activation system



Press the button on the steering wheel or ›Cancel‹.

Set-up and use

Seats, mirrors, and steering wheel

Manually adjustable seats

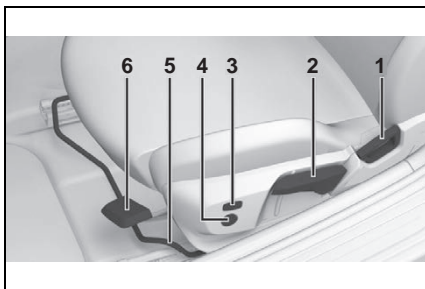

- 1 Backrest angle
- 2 Height
- 3 Backrest width*
- 4 Lumbar support*
- 5 Forward/back
- 6 Seat angle*

*: if equipped

Electrically adjustable seats*

*: if equipped

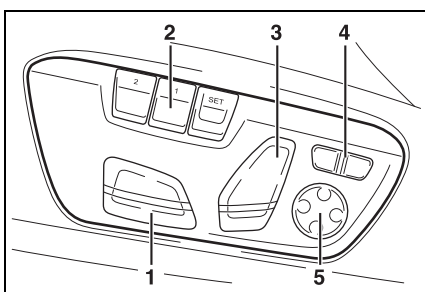

- 1 Forward/backward, height, seat tilt

- 2 Driver's seat memory
- 3 Backrest tilt
- 4 Backrest width
- 5 Lumbar support

Adjusting the exterior mirrors



- 1 Adjusting
- 2 Selecting a mirror, Automatic Curb Monitor, refer to page 111.
- 3 Folding in and out

Adjusting the steering wheel

Manual steering wheel adjustment

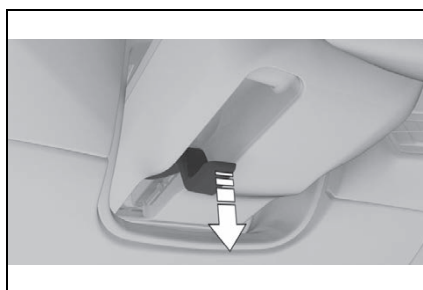

- 1 Fold the lever down.
- 2 Move the steering wheel to

the preferred height and angle to suit your seating position.

- 3 Fold the lever back up.

Memory function

Concept

The following settings can be stored and, if necessary, retrieved using the memory function:

- Seat position.
- Exterior mirror position.
- Height of the Head-up Display.

Storing

- 1 Set the desired position.
- 2 **SET** Press button on the driver's seat. The writing on the button lights up.
- 3 Press the desired button 1 or 2 at the door while the writing is lit. A signal sounds.

Calling up settings

Press the desired button 1 or 2.

Infotainment

Radio

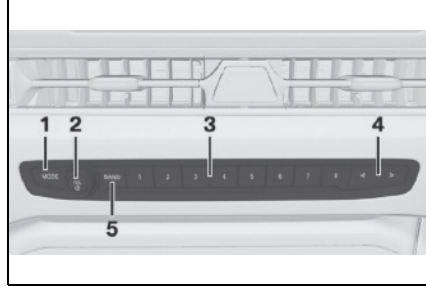

- 1 Changing the entertainment source
- 2 Sound output on/off, volume
- 3 Programmable memory buttons
- 4 Changing the station/track
- 5 Waveband/satellite radio

Connecting a mobile phone

General information

After the mobile phone is connected once to the vehicle, the mobile phone can be operated using Toyota Supra Command, the steering wheel buttons and voice activation.

Connecting the mobile phone via Bluetooth

Via Toyota Supra Command:

- 1 "My Vehicle"
- 2 "System settings"

- 3 "Mobile devices"
- 4 "Connect new device"
- 5 Select the functions for which the mobile phone is to be used.

The Bluetooth name of the vehicle is displayed on the Control Display.

- 6 To perform additional steps on the mobile phone, refer to the mobile phone owner's manual: e.g., search for or connect the Bluetooth device or a new device.

The Bluetooth name of the vehicle appears on the mobile phone display. Select the Bluetooth name of the vehicle.

- 7 Depending on the mobile device, a control number is displayed or the control number must be entered.
 - Compare the control number displayed on the Control Display with the control number on the display of the device.

Confirm the control number on the device and on the Control Display.

- Enter and confirm the same control number on the device and via Toyota Supra Command.

The device is connected and displayed in the device list.

Using the phone

Accepting a call

Incoming calls can be answered

in several ways.

- Via Toyota Supra Command:

 "Accept"

-  Press the button on the steering wheel.
- Via the selection list in the instrument cluster:

Use the thumbwheel on the steering wheel to select: "Accept"

Dialing a number

Via Toyota Supra Command:

- 1 "Communication"
- 2 "Dial number"
- 3 Enter the numbers.
- 4  Select the symbol. The connection is established via the mobile phone to which this function has been assigned.

Establish the connection via the additional phone:

- 1  Press the button.
- 2 "Call via"

Apple CarPlay preparation*

*: if equipped

Concept

CarPlay allows certain functions of a compatible Apple iPhone to be used via Siri voice operation and Toyota Supra

Command.

Functional requirements

- Compatible iPhone, iPhone 5 or later with iOS 9.3 or later.
- Corresponding mobile wireless contract.
- Bluetooth, Wi-Fi, and Siri voice operation are switched on on the iPhone.

Switching on Bluetooth and CarPlay

Via Toyota Supra Command:

- 1 "My Vehicle"
- 2 "System settings"
- 3 "Mobile devices"
- 4 "Settings"
- 5 Select the following setting:
 - "Bluetooth®"
 - Corresponding mobile wireless contract.

Pairing iPhone with CarPlay

Pair iPhone via Bluetooth with the vehicle.

Select CarPlay as the function:

▶ "Apple CarPlay"

The iPhone is connected to the vehicle and displayed in the device list.

In transit

Driving

Drive-ready state

Switching on drive-ready state



- 1 Depress the brake pedal.
- 2 Manual transmission: step on the clutchpedal and shift to Neutral.
- 3 Press the Start/Stop button.

Switching off drive-ready state

Manual transmission:

- 1 With the vehicle at a standstill, press the Start/Stop button.
The engine is switched off.
- 2 Shift into first gear or reverse.
- 3 Set the parking brake.

Automatic transmission:

- 1 Engage selector lever position P with the vehicle stopped.
- 2 Press the Start/Stop button.

The engine is switched off.

- 3 Set the parking brake.

Auto Start/Stop function

The Auto Start/Stop function switches the engine off automatically while stationary to save fuel. The engine starts automatically under the following preconditions:

Manual transmission:

- By pressing the clutch pedal.

Automatic transmission:

- By releasing the brake pedal.

Parking brake

Setting

Pull the switch.



The LED on the switch and the indicator light in the instrument cluster are illuminated.

Releasing

With drive-ready state switched on:

Manual transmission: press the switch while the brake pedal is pressed.



Automatic transmission: press the switch while the brake is pressed or selector lever position P is set.

The LED and indicator light go out.

The parking brake is released.

Manual transmission

Shifting

When shifting to a lower gear, excessive RPM can damage the engine. There is a risk of damage to property, among other potential damage. When shifting into 5th or 6th gear, press the gear shift lever to the right.

Reverse gear

Select only when the vehicle is stationary.

Automatic transmission

Engaging selector lever position D, N, R

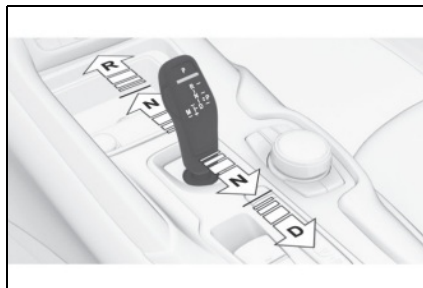

- Drive mode D.
- Neutral N.
- Reverse R.

With the driver's safety belt fastened, briefly push the selector lever in the desired direction, past a resistance point, if needed. The selector lever returns to the center position in

each case.

To prevent the vehicle from creeping after you select a drive mode or reverse, maintain pressure on the brake pedal until you are ready to start.

A selector lever lock prevents the inadvertent shifting to selector lever position R or the inadvertent shifting from selector lever position P.

Engage selector lever position R only when the vehicle is stationary.

Releasing the selector lever lock

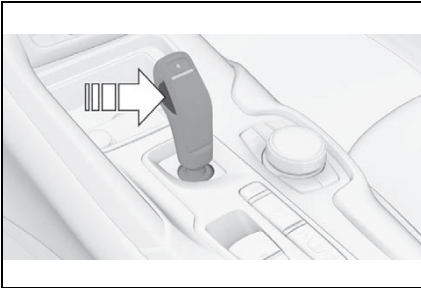

Press and hold the button to release the selector lever lock.

Engaging P

Engage selector lever position P only when the vehicle is stationary.

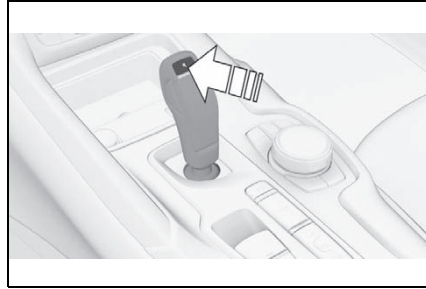

Press button P.

Automatic transmission, manual mode



Activate the manual mode:

Press the selector lever to the left from selector lever position D.

Manual mode:

- To shift down: press the selector lever forward.
- To shift up: pull the selector lever rearwards.

End the manual mode:

Push the selector lever to the right.

High beams, headlight flasher, turn signal

High beams, headlight flasher

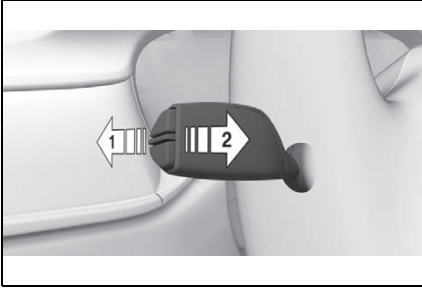

Push the lever forward or pull it backward.

- High beams on, arrow 1. The high beams light up when the low beams are switched on.
- High beams off/headlight flasher, arrow 2.

Turn signal

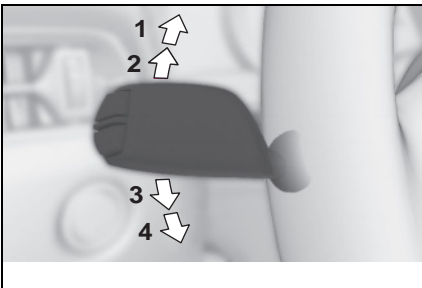

- 1 Right turn
- 2 Lane change to the right (move the lever partway and release it)

The right hand signals will flash 3 times.

- 3 Lane change to the left (move the lever partway and release it)

The left hand signals will flash 3 times.

- 4 Left turn

Lights and lighting

Light functions

Symbol	Function
OFF	Lights off. Daytime running lights.
	Parking lights.
AUTO	Automatic headlight control.
	Low beams.
	Instrument lighting.
	Right roadside parking light.
	Left roadside parking light.

Washer/wiper system

The wipers can be operated in the standby state.

Switching the wipers on/off and brief wipe

■ Switching on

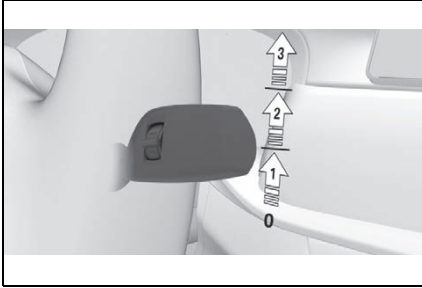

Press the lever up until the desired position is reached.

- Resting position of the wipers: position 0.
- Rain sensor: position 1.
- Normal wiper speed: position 2.
- Fast wiper speed: position 3.

■ Brief wipe and switching off

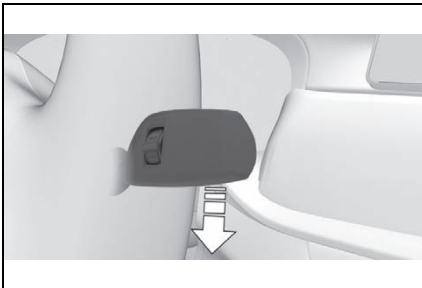

Press the lever down.

- Switching off: press the lever down until it reaches its standard position (position 0).
- Brief wipe: press the lever down from the standard position (position 0).

Rain sensor

■ Activating/deactivating

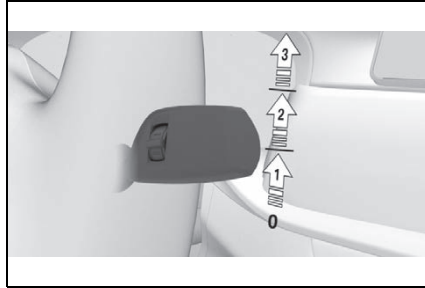

To activate: press the lever up once from its standard position, arrow 1.

To deactivate: press the lever back into the standard position.

■ Adjusting the sensitivity

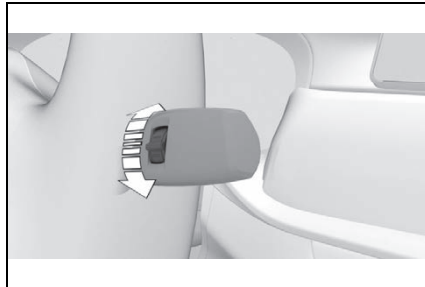





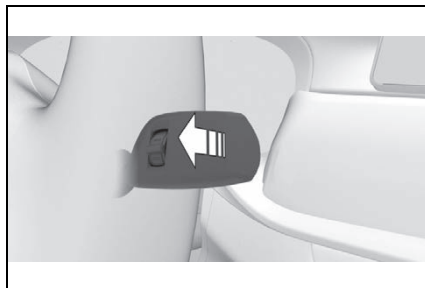



Turn the thumbwheel on the wiper lever.



Cleaning the windshield



Pull the wiper lever towards you.

Climate control

Button	Function
	Temperature.
	Recirculated-air mode.
	Maximum cooling.
	AUTO program.
	Air distribution, manual.
	Switching off.
	Defrost and defog the windshield.
	Rear window defroster.

Button	Function
	Seat heating.
	Climate control operation.
	Air flow, manual.

Intermediate stop

Refueling

Fuel cap

- 1 Press the rear edge of the fuel filler flap to open it.



- 2 Turn the fuel cap counter-clockwise.
- 3 Place the fuel cap in the bracket attached to the fuel filler flap.

Gasoline

For the best fuel efficiency, the

gasoline should be sulfur-free or very low in sulfur content.

Fuels that are marked on the gas pump as containing metal must not be used. →P.303

Wheels and tires

Tire inflation pressure specifications

The tire inflation pressure specifications can be found in the tire inflation pressure table in the printed Owner's Manual.

After correcting the tire inflation pressure

With Tire Pressure Monitor TPM:

The corrected tire inflation pressures are applied automatically. Make sure that the correct tire settings have been made.

With tires that cannot be found in the tire pressure values on the Control Display, reset the Tire Pressure Monitor TPM.

Checking the tire inflation pressure

Regularly check the tire inflation pressure and correct it as needed:

- At least twice a month.
- Before embarking on an extended trip.

Electronic oil measurement

Functional requirements

Depending on the previous displays, the status display appears when the engine is running or after the vehicle has been driven for at least 30 minutes.

Displaying the engine oil level

Via Toyota Supra Command:

- 1 "My Vehicle"
- 2 "Vehicle status"
- 3  "Engine oil level"

Different messages appear on the Control Display depending on the engine oil level. Pay attention to these messages.

Adding engine oil

General information

Safely park the vehicle and switch off drive-ready state before adding engine oil.

Adding



Only add engine oil when the message is displayed in the instrument cluster.

Observe the quantity to be added in the message.

Take care not to add too much engine oil.

Observe recommended engine oil types, refer to page 307.

Providing assistance

Hazard warning flashers



The button is located in the center console.

Roadside assistance

Via Toyota Supra Command:

- 1 "Toyota Supra Connect"
- 2 "Toyota Supra Assistance"
- 3 "Roadside assistance"

A voice connection is established.

Toyota Supra Connect

Concierge

The Concierge offers information on events, gas stations or hotels, and provides phone numbers and addresses. Many hotels can be booked directly by the Concierge.

Via Toyota Supra Command:

- 1 "Toyota Supra Connect"
- 2 "Toyota Supra Assistance"
- 3 "Concierge"

A voice connection to the Concierge is established.

Remote maintenance

Remote maintenance are services that help to maintain vehicle mobility.

Remote maintenance can comprise the following services:

- Roadside assistance.

After driving

When parking

When leaving the vehicle, turn the engine switch off, apply the

parking brake and lock the doors.

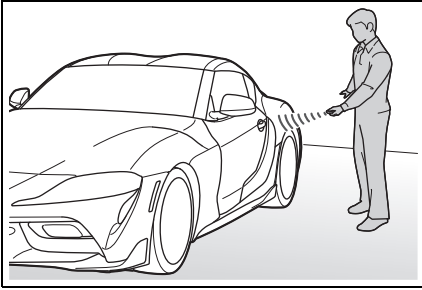

When parking, stop the vehicle in a safe and appropriate parking area, operate the “P” (parking) switch on the selector lever and turn the engine switch off.

! WARNING

When taking a nap in the vehicle, make sure to turn the engine switch off.

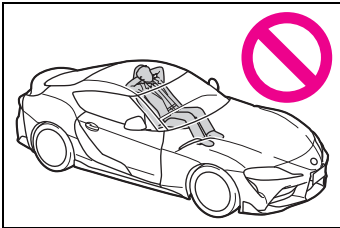

When taking a nap in the vehicle is unavoidable, park the vehicle in a safe place, turn the engine switch off, and if possible, sleep in the passenger seat. If the engine is left running, the accelerator pedal may be depressed or selector lever may be operated unintentionally, possibly leading to an accident. Also, if the engine is run at a high speed for a long time, the exhaust system and engine may become extremely hot, possibly causing to a fire.

! WARNING

Be careful when parking, as to not park the vehicle near flammable materials.

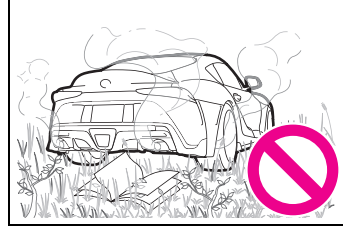

Do not park the vehicle near flammable materials, such as dry grass, leaves, paper, oil, etc. If these kinds of material touch a part of the exhaust system, it may cause a fire.

CONTROLS**3****3-1. CONTROLS**

Cockpit	38
Sensors of the vehicle....	42
Operating state of the vehicle.....	45
Toyota Supra Command	50
General settings.....	64
Personal settings	67
Connections	72
Opening and closing	81
Seats, mirrors, and steering wheel.....	100
Transporting children safely	114
Driving.....	120
Displays	139
Lights	159
Safety.....	165
Driving stability control systems	201
Driver assistance systems	206
Driving comfort.....	234
Climate control	235
Interior equipment	244
Storage compartments	254
Cargo area	256

Cockpit

Vehicle features and options

This chapter describes all standard, country-specific and optional features offered with the series. It also describes features and functions that are not necessarily available in your vehicle, e.g., due to the selected

options or country versions. This also applies to safety-related functions and systems. When using these functions and systems, the applicable laws and regulations must be observed.

In the vicinity of the steering wheel

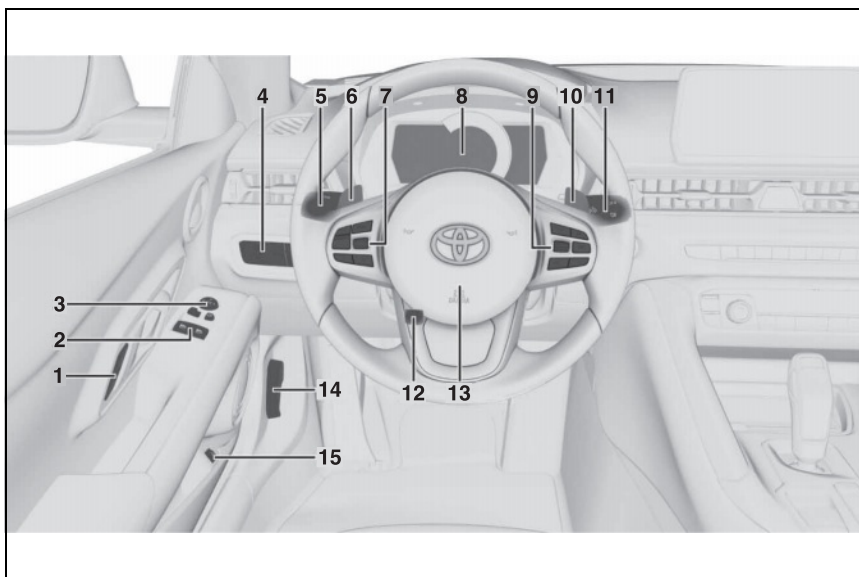

1 Central locking system



Unlock P.89



Lock P.89

2 Power windows P.98



3 Exterior mirror operation P.109

4 Lights



Lights off P.159

Daytime running lights P.162



Parking lights P.160



Automatic headlight control P.159

Automatic high-beam P.162



Low beams P.161



Instrument lighting
P.164



Right roadside parking
light P.161



Left roadside parking
light P.161

5 Turn signal lever



Turn signal P.126



High beams, headlight
flasher P.127



Automatic high-beam
P.162



Onboard Computer
P.139

6 Shift paddle P.135

7 Steering wheel buttons, left



Cruise control on/off
P.208



Dynamic radar cruise
control on/off P.212



Cruise control: store
speed
Speed Limit Assist: take over
suggested speed P.221



Continuing cruise con-
trol/Pausing cruise control

P.206



Dynamic radar cruise
control: increase distance
P.206



Dynamic radar cruise
control: reduce distance
P.206

Cruise control rocker switch
P.206

8 Instrument cluster P.139

9 Steering wheel buttons, right



MODE Selection lists P.151



Volume, see Owner's
Manual for Navigation, Enter-
tainment and Communication



Voice activation system
P.60



Telephone, see
Owner's Manual for Naviga-
tion, Entertainment and Com-
munication
Thumbwheel for selection
lists P.151

10 Shift paddle P.135

11 Wiper lever



Wiper P.127





AUTO Rain sensor P.128



Clean the windshield
P.129

12 Adjust the steering wheel
P.111

13  Horn, entire surface

15  Unlocking the trunk lid
P.84

14  Unlock hood P.302

In the vicinity of the center console

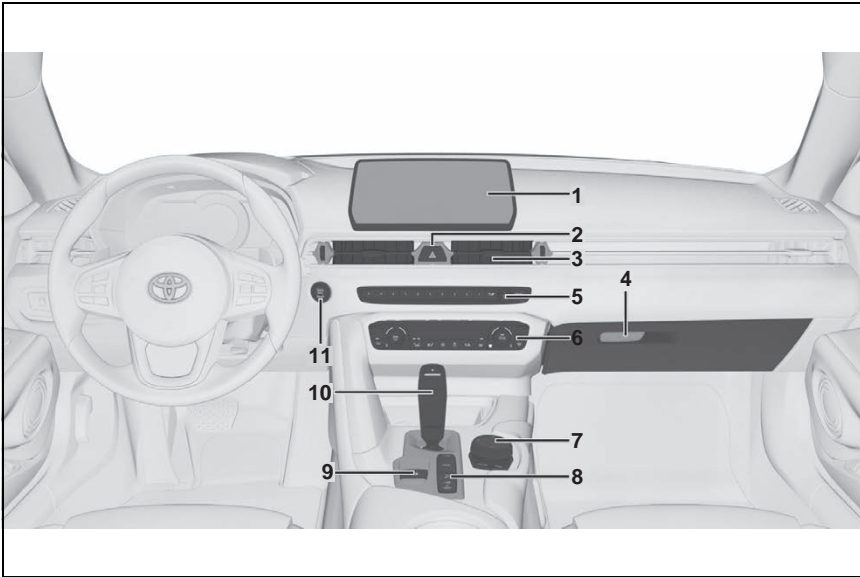

1 Control Display P.52

2  Hazard warning system P.327

3 Ventilation P.241

4 Glove compartment P.255

5 Radio/multimedia, see Owner's Manual for Navigation, Entertainment, and Communication

6 Automatic air conditioning P.235

7 Controller with buttons P.52

8  Sport mode button

P.138
SPORT driving mode

 Toyota Supra Safety
P.178

 Auto Start/Stop function P.120

 Parking Sensors P.42
Rearview camera P.228
RCTA (Rear cross trafficalert) function P.232

 VSC Vehicle Stability Control System P.203

9  Parking brake P.124

10 Automatic transmission selector lever P.132

11  Switch drive-ready state on/off P.120

In the vicinity of the roofliner

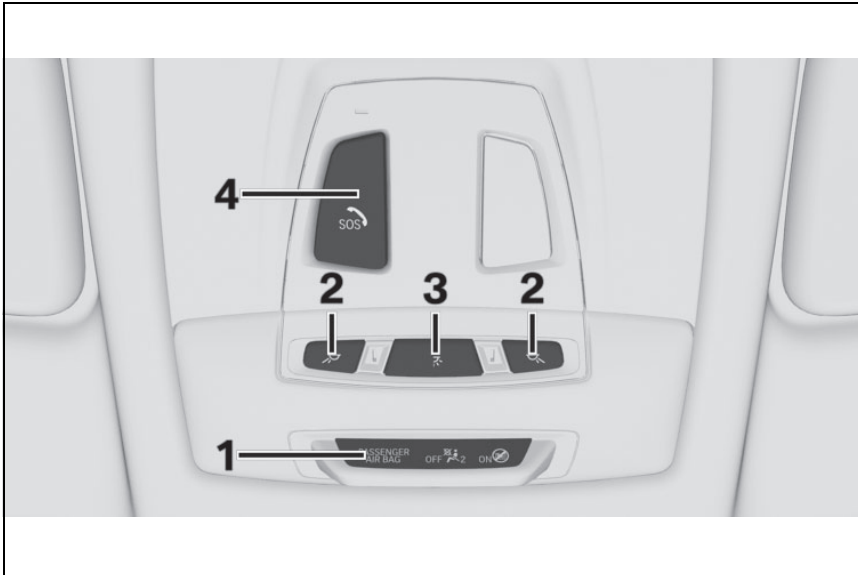



3

CONTROLS

1  Indicator light, front-seat passenger airbag P.177

2  Reading lights P.165

3  Interior lights P.164

4  Emergency call, SOS P.328

Sensors of the vehicle

Vehicle equipment

This chapter describes all standard, country-specific and optional features offered with the series. It also describes features and functions that are not necessarily available in your vehicle, e.g., due to the selected options or country versions. This also applies to safety-related functions and systems. When using these functions and systems, the applicable laws and regulations must be observed.

Overview

Depending on the equipment, the following cameras and sensors are installed in the vehicle:

- Cameras behind the windshield.
- Rearview camera.
- Front radar sensor.
- Radar sensors, side, rear.
- Ultrasound sensors in the bumpers.

Keep the vehicle cameras and sensors, as well as surrounding areas, clean and unobstructed.

Cameras

Cameras behind the windshield

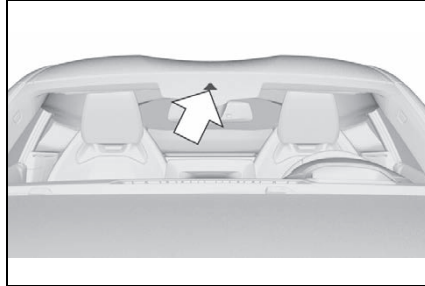

The cameras are located in the area of the interior mirror.

Rearview camera

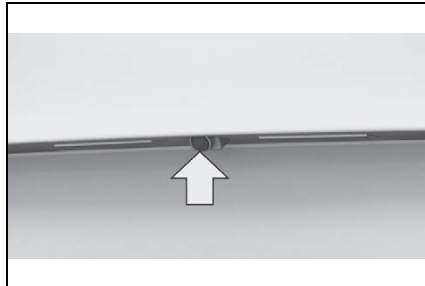

The camera is located in the handle of the trunk lid.

System limits of the cameras

The cameras may not be fully functional and may provide incorrect information in the following situations:

- In heavy fog, wet conditions, or snow fall.
- On steep hills, in steep

- depressions or in tight curves.
- When the camera field of view is covered, for instance by a fogged up windshield or labels.
 - When the camera lens is dirty or damaged.
 - When driving toward bright lights or strong reflections, e.g., because of a setting sun.
 - When it is dark outside.
 - Camera behind the windshield: if the camera has overheated and been temporarily switched off due to excessively high temperatures.
 - Camera behind the windshield: during calibration of the camera immediately after vehicle delivery.

If applicable, a Check Control message is displayed if the system fails.

Radar sensors

Safety information

⚠ WARNING

The vehicle radar sensors, and thus the driver assistance systems, can be negatively affected by external influences, e.g., interference. There is a risk of accident, injury, and property damage. Watch the surrounding traffic situation closely, be ready to take over steering and braking at any time, and actively intervene where appropriate.

Front radar sensor

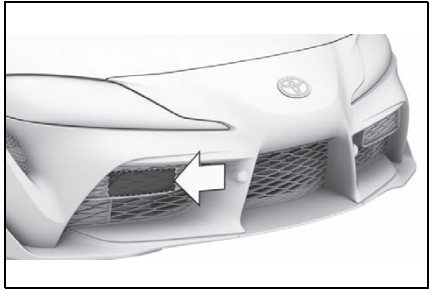

The radar sensor is located in the front bumper.

Radar sensors, side, rear*

*: if equipped

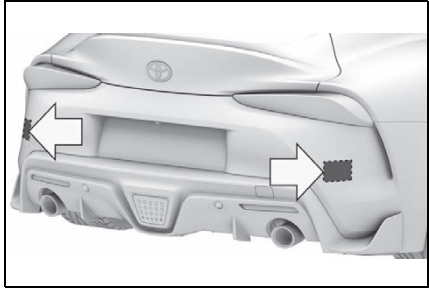

The radar sensors are located in the bumper.

System limits of the radar sensors

- The radar sensors may not be fully functional or may not be available in the following situations:
- If sensors are dirty, such as due to icing.
 - If sensors are covered, such as by labels, films or a number plate baseplate.

- If the sensor is not aligned correctly, for instance due to parking damage.
- If the radiation range of the sensors is covered, e.g., by protruding cargo.
- If the field of view of the sensors is covered, e.g., by garage walls, hedges or snow hills.
- After improperly performed work on the vehicle paint in the area of the sensors.
- On steep hilltops or in sharp dips in the road.

If applicable, a Check Control message is displayed if the system fails.

Ultrasound sensors

Ultrasound sensors in the front/rear bumpers*

*: if equipped



Ultrasound sensors of the Parking Sensor, for instance in the bumpers.

System limits of the ultrasound sensors

The detection of objects with ultrasound measurements can run into physical limits, e.g., in the following situations:

- In case of dirty sensors.
- In case of covered sensors, such as due to labels.
- If the sensor is not aligned correctly, for instance due to parking damage.
- After improperly performed work on the vehicle paint in the area of the sensors.
- For small children and animals.
- For persons with certain clothing, for instance coats.
- In case of external interference of the ultrasound, for instance from passing vehicles, loud machines or other ultrasonic sources.
- Under certain weather conditions, e.g., high relative humidity, wet conditions, snowfall, cold, extreme heat, or strong wind.
- With tow bars and trailer couplings of other vehicles.
- With thin or wedge-shaped objects.
- With moving objects.
- With elevated, protruding objects such as ledges.
- With objects with corners, edges, and smooth surfaces.
- With objects with a fine surface structure such as fences.
- For objects with porous surfaces.
- With small and low objects, for instance boxes.
- With soft obstacles or obstacles covered in foam material.
- With plants and bushes.
- In automatic car washes.

- On uneven surfaces, such as speed bumps.
- Due to heavy exhaust.
- Cargo that extends beyond the perimeter of the vehicle is not taken into account by the ultrasonic sensors.

If applicable, a Check Control message is displayed if the system fails.

Operating state of the vehicle

Vehicle features and options

This chapter describes all standard, country-specific and optional features offered with the series. It also describes features and functions that are not necessarily available in your vehicle, e.g., due to the selected options or country versions. This also applies to safety-related functions and systems. When using these functions and systems, the applicable laws and regulations must be observed.

3

CONTROLS

General information

Depending on the situation, the vehicle is in one of the three states:

- Idle state.
- Standby state.
- Drive-ready state.

Idle state

Principle

If the vehicle is in idle state, it is switched off.

General information

The vehicle is in idle state prior to opening from the outside and

after exiting and locking.

Safety information

WARNING

An unsecured vehicle can begin to move and possibly roll away. There is a risk of accident, injury, and property damage. Before leaving the vehicle, secure the vehicle against rolling away.

In order to ensure that the vehicle is secured against rolling away, follow the following:

- Set the parking brake.
- Automatic transmission: Make sure that selector lever position P is engaged.
- Manual transmission: Make sure that first gear is engaged on uphill gradients and reverse gear on downhill gradients.
- On uphill grades or on a downhill slope, turn the front wheels in the direction of the curb.
- On uphill grades or on a downhill slope, also secure the vehicle, for instance with a wheel chock.

WARNING

Unattended children or animals in the vehicle can cause the vehicle to move and endanger themselves and traffic, for example, due to the following actions:

- Establishing standby.
- Releasing the parking brake.
- Opening and closing the doors or windows.

- Engaging selector lever position N.
- Using vehicle equipment.

There is a risk of accident, injury, and property damage. Do not leave children or animals unattended in the vehicle. Take the vehicle key with you when exiting and lock the vehicle.

Automatic idle state

For instance, the idle state is automatically established under the following conditions:

- After several minutes, if no operation takes place on the vehicle.
- If the charge state of the vehicle battery is low.
- Depending on the setting via Toyota Supra Command: when one or both front doors are opened after driving when exiting the vehicle.

In some situations, the idle state is not set automatically, for instance during a phone call or when the low beams are switched on.

Establishing idle state when opening the front doors

After a trip, the sleep mode can be established by opening the front doors. For this purpose, the driver and front passenger must exit the vehicle.

Via Toyota Supra Command:

- 1 "My Vehicle"
- 2 "Vehicle settings"
- 3 "Doors/Key"
- 4 "Turn off after door opening"

Manual idle state

To establish idle state in the vehicle after end of trip:

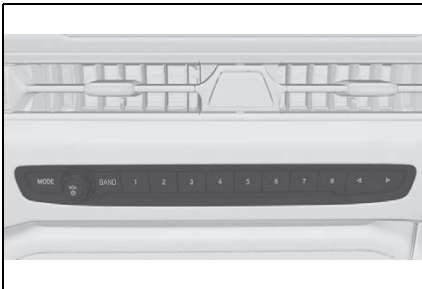

Press and hold the button until the OFF indicator on the instrument cluster goes out.

Standby state

Concept

When standby state is switched on, most functions can be used while the vehicle is stationary. Desired settings can be adjusted.

General information

The vehicle is in the standby state after the front doors are opened from the outside.

Standby, manual

General information

Standby can be switched back on after the vehicle is automatically set to idle state.

Via button on the radio



Press the button on the radio. The control display and the instrument cluster illuminate.

Via start/stop button



Press the Start/Stop button. The control display and the instrument cluster illuminate.

Display in the instrument cluster



OFF is displayed in the instrument cluster. The drive-train is switched off and standby state switched on.

Drive-ready state

Concept

Switching on drive-ready state corresponds to starting the engine.

General information

Some functions, such as VSC Vehicle Stability Control System, can only be used with drive-ready state switched on.

Safety information

WARNING

If the exhaust pipe is blocked or ventilation is insufficient, harmful exhaust gases can enter into the vehicle. The exhaust gases contain pollutants which are colorless and odorless. In enclosed areas, exhaust gases can also accumulate outside of the vehicle. There is danger to life. Keep the exhaust pipe free and ensure sufficient ventilation.

WARNING

An unsecured vehicle can begin to move and possibly roll away. There is a risk of accident, injury, and property damage. Before leaving the vehicle, secure the vehicle against rolling away.

In order to ensure that the vehicle is secured against rolling away, follow the following:

- Set the parking brake.
- Automatic transmission: Make sure that selector lever position P is engaged.
- Manual transmission: Make sure that first gear is engaged on uphill gradients and reverse gear on downhill gradients.
- On uphill grades or on a downhill slope, turn the front wheels in the direction of the curb.

- On uphill grades or on a downhill slope, also secure the vehicle, for instance with a wheel chock.

NOTICE

In the case of repeated starting attempts or repeated starting in quick succession, the fuel is not burned or is inadequately burned. The catalytic converter can overheat. There is a risk of damage to property. Avoid repeated starting in quick succession.

Switching on drive-ready state

Concept



Drive-ready state is switched on via the Start/Stop button:

Manual transmission

- 1 Depress the brake pedal.
- 2 Press on the clutch pedal and shift to Neutral.
- 3 Press the Start/Stop button.

The ignition is activated automatically for a brief time and is stopped as soon as the engine starts.

Most of the indicator/warning lights in the instrument cluster light up for a varied length of time.

Automatic transmission

- 1 Depress the brake pedal.
- 2 Press the Start/Stop button.

The ignition is activated automatically for a brief time and is stopped as soon as the engine starts.

Most of the indicator/warning lights in the instrument cluster light up for a varied length of time.

Gasoline engine

Depending on the motorization, full drive power and the entire speed range may not be available for approx. 30 seconds after starting the engine. In this case, the vehicle will not accelerate as usual, refer to page 147.

Display in the instrument cluster

READY in the instrument cluster indicates that drive-ready state is switched on.

Switching off drive-ready state

Manual transmission

- 1 With the vehicle at a standstill, press the Start/Stop button.

The engine is switched off.

The vehicle switches into standby state.

- 2 Shift into first gear or reverse.
- 3 Set the parking brake.

Automatic transmission

- 1 Engage selector lever position P with the vehicle stopped.
- 2 Press the Start/Stop button.

The engine is switched off. The vehicle switches into standby state.

- 3 Set the parking brake.

Toyota Supra Command

Vehicle features and options

This chapter describes all standard, country-specific and optional features offered with the series. It also describes features that are not necessarily available in your vehicle, e. g., due to the selected options or country versions. This also applies to safety-related functions and systems. When using these functions and systems, the applicable laws and regulations must be observed.

Operating concept

Principle

The Toyota Supra Command combines the functions of many switches.

General information

Depending on the equipment, the functions can be operated as follows:

- Via the Controller.
- Via the touchscreen.
- Via the voice activation system.

Safety information



WARNING

Operating the integrated information systems and communication devices while driving can distract from surrounding traffic. It is possible to lose control of the vehicle. There is a risk of accident, injury, and property damage. Only use the systems or devices when the traffic situation allows. As warranted, stop and use the systems and devices while the vehicle is stationary.

Input and display

Letters and numbers

Letters and numbers can be entered using the controller, the touchpad, control display or voice control depending on the equipment. The keyboard display changes automatically.

Symbol	Function
abc or ABC	Change between capital and lower-case letters.
	Insert blank space.
	Use voice activation.
OK	Confirm entry.

Entry comparison

When entering names and addresses, the choice is nar-

rowed down with every letter entered and letters may be added automatically.

Entries are continuously compared with data stored in the vehicle.

- Only those letters are offered during entry for which data is available.
- Destination search: place names can be entered in all languages that are available in Toyota Supra Command.

Activating/deactivating the functions

Several menu items are preceded by a checkbox. The checkbox indicates whether the function is activated or deactivated. Selecting the menu item activates or deactivates the function.

Function is activated.

Function is deactivated.













Status information

■ General information



The status field can be found in the upper area of the Control Display. Status information is displayed in the form of symbols.

■ Status field symbols



► Telephone



Symbol	Meaning
	Incoming or outgoing call.
	Missed call.
	Signal strength of cellular network.
	Network search.
	Cellular network is not available.
	The critical charge state of the mobile phone has been reached.
	Roaming is active.
	SMS text message received.
	Message received.
	Reminder.
	Sending not possible.
	Contacts are loaded.

► Entertainment

Symbol	Meaning
	Music hard disc.
	Bluetooth audio.
	USB audio interface.

► Additional symbols

Symbol	Meaning
	Check Control message.
	The sound output has been switched off.

Symbol	Meaning
	Request for the current vehicle position.
	Checking the current vehicle position.

Split screen, split screen display

■ General information

Additional information can be displayed in several menus on the right side of the split screen display, the so-called split screen, for instance information from the Onboard Computer.

The additional information remains visible even when switching to another menu on the split screen.

■ Switching on/off

-  Press the button.
- "Split screen"

■ Selecting the display

The display can be selected in menus, where the split screen is supported.

- Move the Controller to the right until the split screen is selected.
- Press the Controller.
- Select the desired setting.

■ Specifying the number of displays

It is possible to specify the number of displays.

- Move the Controller to the right until the split screen is selected.
- Press the Controller.
- "Personalize menu"
- Select the desired setting.
- Move the Controller to the left.

Control elements

Overview

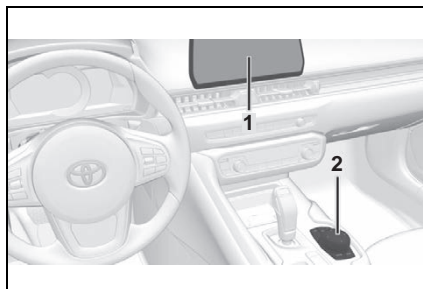

- Control Display
- Controller

Control Display

General information

To clean the Control Display, follow the care instructions, refer to page 342.

In the case of very high temperatures on the Control Display, for instance due to intense solar radiation, the brightness may be reduced down to complete deactivation. Once the

temperature is reduced, for instance through shade or air conditioning, the normal functions are restored.

Safety information

⚠ WARNING

When driving, loose items or devices connected to the vehicle with a cable, i.e., mobile phones, may be thrown around the vehicle, e.g., in the event of an accident or when braking or performing evasive maneuvers. There is a risk of injury and risk of damage to property. Secure loose objects or devices that are connected to the vehicle via a cable.

⚠ WARNING

Objects in the area in the front of the Control Display can slip and damage the Control Display. There is a risk of injury and risk of damage to property. Do not place objects in the area in front of the Control Display.

Switching on/off automatically

The Control Display is switched on automatically after unlocking. In certain situations, the Control Display is switched off automatically, for instance if no operation is performed on the vehicle for several minutes.

Switching on/off manually

The Control Display can also be switched off manually.

- 1  Press the button.
- 2 "Turn off control display"
Press the Controller or any button on the Controller to switch it back on again.

Controller with navigation system

General information

The buttons can be used to open the menus directly. The Controller can be used to select menu items and enter the settings.

Some Toyota Supra Command functions can be operated using the touchpad on the Controller, refer to page 59.

Operation

- Turn to switch between menu items, for example.

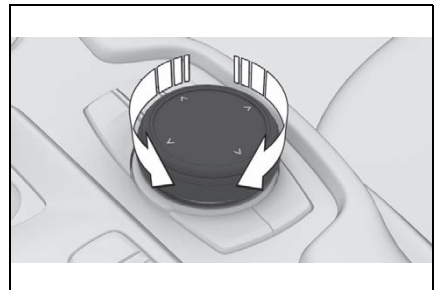



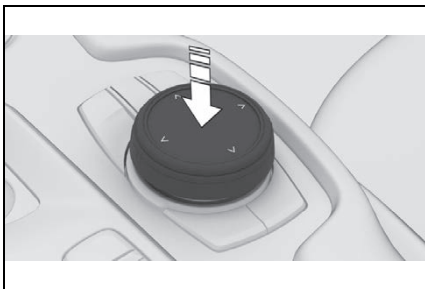

- Press to select a menu item, for example.

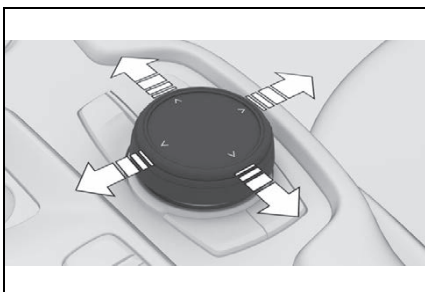

- Tilt in four directions to switch between displays, for example.



Buttons on the Controller

Button	Function
	Press once: calls up the main menu. Press twice: displays all menu items of the main menu.
	Opens the Media/Radio menu.
	Opens the Communication menu.
	Press once: opens the previous display. Press and hold: open the menu used last.
	Opens the Options menu.

Controller without navigation system

General information

The buttons can be used to open the menus directly. The Controller can be used to select menu items and enter the settings.

Operation

- Turn to switch between menu items, for example.

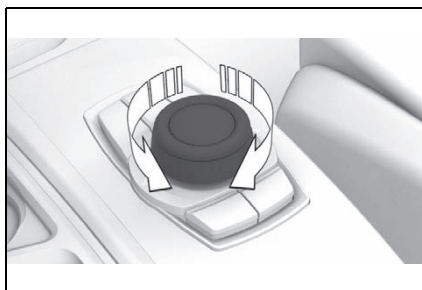



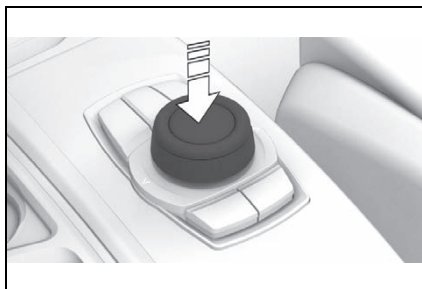

- Press to select a menu item, for example.

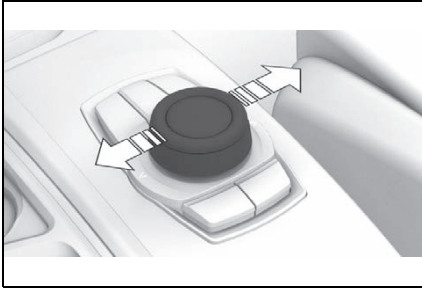

- Tilt in two directions to switch between displays, for example.



Buttons on the Controller

Button	Function
	Press once: call up main menu. Press twice: display all menu items of the main menu.
	Open the Media/Radio menu.
	Open the Communication menu.
	Press once: open the previous display. Press and hold: open the menus used last.
	Open the Options menu.

Operating via contral display

Opening the main menu

 Press the button.



The main menu is displayed.

All Toyota Supra Command functions can be called up via the main menu.

Adapting the main menu

1  Press the button twice.

All menu items of the main menu are displayed.

- 2 Select a menu item.
- 3 To move the menu item to the desired position, tilt the Controller to the right or left.

Selecting menu items

Highlighted menu items can be selected.

- 1 Turn the Controller until the desired menu item is highlighted.

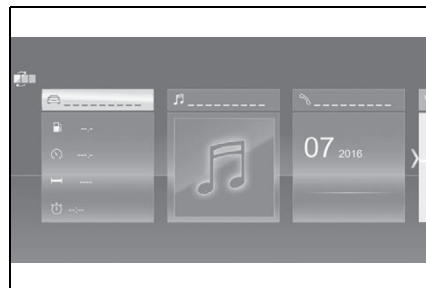

2 Press the Controller.

Adjusting menu contents

The display of menus "Media/Radio", "Communication" and "Connected Serv." can be adjusted, for instance to remove the entries of functions that are not used from the menu.

Via Toyota Supra Command:

- 1 Select the menu.
- 2 "Personalize menu"
- 3 Select desired menu contents to be displayed.

Changing between displays

After a menu item is selected, for instance "System settings", a new display appears.

- Move the Controller to the left.

The current display closes and the previous display is shown.

-  Press the button.

The previous display re-opens.

- Move the Controller to the right.

The new display opens.

An arrow indicates that additional displays can be opened.

Opening recently used menus

-  Press and hold this button.

The recently used menus are displayed.

Opening the Options menu

-  Press the button.

The "Options" menu is displayed.

The menu consists of various areas:

- Screen settings, for instance "Split screen".
- Control options for the selected main menu, for instance for "Media/Radio".
- If applicable, further operating options for the selected menu, for instance "Save station".

Changing settings

Settings, such as brightness, can be entered.

Via Toyota Supra Command:

- 1 "My Vehicle"
- 2 "System settings"
- 3 "Displays"
- 4 "Control display"
- 5 "Brightness at night"
- 6 Turn the Controller until the desired setting is displayed.
- 7 Press the Controller.

Entering letters and numbers

Input

- 1 Turn the Controller: select letter or number.
- 2 **OK**: confirm entry.

Deleting

Symbol	Function
I←	Press the Controller: delete letter or number.
I←	Hold the Controller down: delete all letters or numbers.

Using alphabetical lists

For alphabetical lists with more than 30 entries, the letters for which there is an entry are displayed at the left edge.

- 1 Turn the Controller to the left or right quickly.

All letters for which there are entries are displayed on the left edge.

- 2 Select the first letter of the desired entry.

The first entry of the selected letter is displayed.

Operating via Control Display

General information

The Control Display is equipped with a touchscreen.

Touch screen with your fingers. Do not use any objects.

Opening the main menu

🏠 Tap on the symbol.

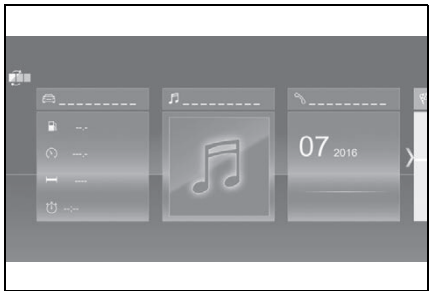

The main menu is displayed. All Toyota Supra Command functions can be called up via the main menu.

Adapting the main menu

- 1 📱 Tap on symbol.

All menu items of the main menu are displayed.

- 2 Drag the menu item to the desired position on the right or left.

Selecting menu items

Tap desired menu item.

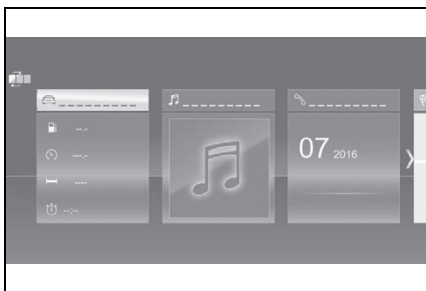

Dynamic contents

You can display dynamic contents within the menu items. The contents of the menu items update automatically, e.g., the active destination guidance in the navigation. To access the dynamic content directly, tap on the lower section of the menu item.

Via Toyota Supra Command:

- 1 "My Vehicle"
- 2 "Contents of main menu"

Changing between displays

After a menu item is selected, a new display opens.

An arrow indicates that additional displays can be opened.

- Swipe to the left.
- Tap arrow.

New display is opened.

Changing settings

Settings such as brightness can be changed via the touch-

screen.

Via Toyota Supra Command:

- 1 "My Vehicle"
- 2 "System settings"
- 3 "Displays"
- 4 "Control display"
- 5 "Brightness at night"
- 6 To perform the desired setting:
 - Slide in the selected field to the right or left, until the desired setting is displayed.
 - -, + Tap on symbol.

Entering letters and numbers



Input

- 1 Depending on the equipment, tap the  symbol on the Control Display.

A keyboard is displayed in the Control Display.

- 2 Enter letters and numbers.

Deleting

Symbol	Function
	Tapping the symbol: deletes the letter or number.
	Tapping and holding the symbol all letters: deletes all letters or numbers.

Operating navigation map

The navigation map can be moved with the Control Display.

Function	Operation
Enlarge/shrink map.	Drag in or out with the fingers.

Touchpad

General information

Depending on the equipment, some Toyota Supra Command functions can be operated using the touchpad on the Controller.

Selecting functions

Via Toyota Supra Command:

- 1 "My Vehicle"
- 2 "System settings"
- 3 "Touchpad"
- 4 Select the desired setting:
 - "Speller": enter letters and numbers.
 - "Map": using the map.
 - "Search fields": write letters without selecting the list field.
 - "Audio feedback": pronounces entered letters and numbers.

Entering letters and numbers

Entering letters requires some practice at the beginning. When

entering, pay attention to the following:

- The system distinguishes between upper and lower-case letters and numbers. To make entries, it may be necessary to change between upper and lower-case letters, numbers and characters, refer to page 57.
- Enter characters as they are displayed on the Control Display.
- Always enter associated characters, such as accents or periods so that the letter can be clearly recognized. The set language determines what input is possible. Where necessary, enter special characters via the Controller.

Entering special characters

Entry	Operation
Delete a character.	Swipe to the left on the touchpad.
Enter a blank space.	Swipe to the right in the center of the touchpad.

Entry	Operation
Enter a hyphen.	Swipe to the right in the upper area of the touchpad.
Enter an under-score.	Swipe to the right in the lower area of the touchpad.

Using the map

The map in the navigation system can be moved via the control display.

Function	Operation
Move map.	Swipe in the appropriate direction.
Enlarge/shrink map.	Drag in or out on the touchpad with fingers.
Display menu.	Tap once.

Programmable memory buttons

General information

The Toyota Supra Command functions can be stored on the programmable memory buttons and called up directly, for instance radio stations, navigation destinations and phone numbers.

Storing a function

- 1 Select function via Toyota Supra Command.
- 2 **1... 8** Press and hold the desired button until a signal sounds.

Running a function

- 1... 8 Press the button.

The function will work immediately. This means, for instance that the number is dialed when a phone number is selected.

Displaying the key assignment

Touch buttons with finger. Do not wear gloves or use objects. The button assignment is displayed at the top edge of screen.

Deleting the button assignments

- 1 Press and hold buttons 1 and 8 simultaneously for approx. 5 seconds.
- 2 "OK"

Operation via voice

Concept

Most functions displayed on the

Control Display can be operated by voice commands via the voice activation system. The system supports you with announcements during input.

- 2 Wait for the signal.
- 3 Say the command.



This symbol indicates that the voice activation system is active.

General information

- Functions that can only be used when the vehicle is stationary can only be operated via the voice activation system to a limited extent.
- The system uses a special microphone on the driver's side.
- ›...‹ in the Owner's Manual denotes verbal instructions to use with the voice activation system.

No other commands may be available. In this case, operate the function via Toyota Supra Command.

Terminating the voice activation system



Press the button on the steering wheel or ›Cancel‹.

3

CONTROLS

Functional requirements

- A language must be set via Toyota Supra Command that is supported by the voice activation system. To set the language, refer to page 64
- Always say commands in the language of the voice activation system.

Possible commands

General information

Most menu items on the Control Display can be voiced as commands.

Commands from other menus can also be spoken.

You may select list entries such as phone list entries via voice activation. Read these list entries out loud exactly as they are shown in the respective list.

Using the voice activation system

Activating the voice activation system

- 1  Press the button on the steering wheel.

Displaying possible commands

The following is displayed in the top area of the Control Display:

- Some possible commands for the current menu.

- Some possible commands from other menus.
- Status of the voice recognition.
-  Encrypted connection is not available.

Help on the voice activation system

- To have the available spoken instructions read out loud: ›Voice commands‹.
- To have information on the operating principle of the voice activation system read out loud: ›General information on voice control‹.
- To have help for the current menu read out loud: ›Help‹.

Information for Emergency Requests

Do not use the voice activation system to initiate an Emergency Request. In stressful situations, the voice and vocal pitch can change. This can unnecessarily delay the establishment of a phone connection.

Instead, use the SOS button, refer to page 328, close to the interior mirror.

Adjusting

Setting the voice dialog

You can set the system to use

standard dialog or a short version.

The short version of the voice dialog plays back short messages in abbreviated form.

Via Toyota Supra Command:

- 1 "My Vehicle"
- 2 "System settings"
- 3 "Language"
- 4 "Speech mode:"
- 5 Select the desired setting.

Speaking during voice output

It is possible to answer during inquiries of the voice activation system. The function can be deactivated if inquiries are often undesirably interrupted, for instance due to background noise or talking.

Via Toyota Supra Command:

- 1 "My Vehicle"
- 2 "System settings"
- 3 "Language"
- 4 "Speaking during voice output"

Online speech processing

Online speech processing provides a dictation function, a natural method of entering destinations and improves the quality of voice recognition. To use the functions, data is trans-

mitted to a service provider via an encrypted connection and stored locally there.

Via Toyota Supra Command:

- 1 "My Vehicle"
- 2 "System settings"
- 3 "Language"
- 4 "Server speech recognition"

Adjusting the volume

Turn the volume button during the spoken instructions until the desired volume is set.

- The volume remains constant even if the volume of other audio sources is changed.

System limits

- Certain noises can be detected and may lead to problems. Keep the doors and windows closed.
- Noises from the front passenger or the rear seat bench can impair the system. Avoid making other noise in the vehicle while speaking.
- Major language dialects can cause problems with the voice recognition feature. Speak loud and clear.

Using a smartphone via voice activation

A smartphone connected to the vehicle can be used via voice

activation.

Activate voice command response on the smartphone for this purpose.

- 1 Press and hold the  button on the steering wheel for approx. 3 seconds.

Voice command response is activated on the smartphone.

- 2 Release the  button.

If activation is successful, a confirmation appears on the Control Display.

If it was not possible to activate voice command response, the list of Bluetooth devices appears on the Control Display.

General settings

Vehicle features and options

This chapter describes all standard, country-specific and optional features offered with the series. It also describes features that are not necessarily available in your vehicle, e. g., due to the selected options or country versions. This also applies to safety-related functions and systems. When using these functions and systems, the applicable laws and regulations must be observed.

Language

Setting the language

Via Toyota Supra Command:

- 1 "My Vehicle"
- 2 "System settings"
- 3 If necessary, "Language"
- 4 "Language:"
- 5 Select the desired setting.

Setting the voice dialog

For voice dialog for the voice activation system, refer to page 62.

Time

Setting the time zone

Via Toyota Supra Command:

- 1 "My Vehicle"
- 2 "System settings"
- 3 "Date and time"
- 4 "Time zone:"
- 5 Select the desired setting.

Setting the time

Via Toyota Supra Command:

- 1 "My Vehicle"
- 2 "System settings"
- 3 "Date and time"
- 4 "Time"
- 5 Turn the Controller until the desired hours are displayed.
- 6 Press the Controller.
- 7 Turn the Controller until the desired minutes are displayed.
- 8 Press the Controller.

Setting the time format

Via Toyota Supra Command:

- 1 "My Vehicle"
- 2 "System settings"
- 3 "Date and time"
- 4 "Time format:"
- 5 Select the desired setting.

Automatic time setting

Depending on your vehicle's optional features, the time, date and, if needed, the time zone are updated automatically.

Via Toyota Supra Command:

- 1 "My Vehicle"
- 2 "System settings"
- 3 "Date and time"
- 4 "Automatic time setting"

Date

Setting the date

Via Toyota Supra Command:

- 1 "My Vehicle"
- 2 "System settings"
- 3 "Date and time"
- 4 "Date:"
- 5 Turn the Controller until the desired day is displayed.
- 6 Press the Controller.
- 7 Make the settings for the month and year.

Setting the date format

Via Toyota Supra Command:

- 1 "My Vehicle"
- 2 "System settings"
- 3 "Date and time"
- 4 "Date format:"
- 5 Select the desired setting.

Setting the units of measurement

Depending on the country version, you can set the units of measurement for some values, for instance consumption, distances, and temperature.

Via Toyota Supra Command:

- 1 "My Vehicle"
- 2 "System settings"
- 3 "Units"
- 4 Select the desired menu item.
- 5 Select the desired setting.

Activating/deactivating the display of the current vehicle position

Concept

If vehicle location has been activated, the current vehicle position can be displayed in the Toyota Supra Apps.

Activating/deactivating

Via Toyota Supra Command:

- 1 "My Vehicle"
- 2 "Vehicle settings"
- 3 "Vehicle tracking"
- 4 "Vehicle tracking"

Activating/deactivating popup windows

For some functions, popup windows are displayed automatically on the Control Display. Some of these popup windows can be activated or deactivated.

Via Toyota Supra Command:

- 1 "My Vehicle"
- 2 "System settings"
- 3 "Pop-ups"
- 4 Select the desired setting.

Control Display

Brightness

Via Toyota Supra Command:

- 1 "My Vehicle"
- 2 "System settings"
- 3 "Displays"
- 4 "Control display"
- 5 "Brightness at night"
- 6 Turn the Controller until the desired brightness is set.
- 7 Press the Controller.

Depending on the light conditions, the brightness settings may not be clearly visible.

Selecting the contents of the main menu

For some menu items of the main menu, the displayed con-

tents can be selected.

- 1  Press button.
- 2 "Contents of main menu"
- 3 Select the desired menu and the desired content.

Messages

Concept

The menu centrally displays all messages arriving in the vehicle in list form.

General information

The following messages can be displayed:

- Traffic messages.
- Vehicle messages.
- Communication messages, for example emails, SMS text messages or reminders.
- Service notification messages.

Messages are additionally displayed in the status field.

Retrieving messages

Via Toyota Supra Command:

- 1 "My Vehicle"
- 2 "System settings"
- 3 "Notifications"
- 4 Select the desired message.

The respective menu is opened, where the message is dis-

played.

Deleting messages

All messages, except vehicle messages, can be deleted from the list. Vehicle messages are displayed as long as they are relevant.

Via Toyota Supra Command:

- 1 "Notifications"
- 2 Select the desired message.
- 3  Press button.
- 4 "Delete this notification" or "Delete all notifications"

Adjusting

The following settings can be adjusted:

- Select the applications, from which messages will be permitted.
- Sort the messages according to date or priority.

Via Toyota Supra Command:

- 1 "My Vehicle"
- 2 "System settings"
- 3 "Notifications"
- 4 Select the desired setting.

Personal settings

Vehicle features and options

This chapter describes all standard, country-specific and optional features offered with the series. It also describes features that are not necessarily available in your vehicle, for instance, due to the selected options or country versions. This also applies to safety-related functions and systems. When using these functions and systems, the applicable laws and regulations must be observed.

Data protection

Data transfer

Concept

The vehicle offers different functions, whose use requires a data transfer to Toyota or a service provider. The data transfer can be deactivated for some functions.

General information

With data transfer deactivated, the respective function cannot be used.

Only make these settings while stationary.

Activating/deactivating

Follow the instructions on the Control Display.

Via Toyota Supra Command:

- 1 "My Vehicle"
- 2 "System settings"
- 3 "Data privacy"
- 4 Select the desired setting.

Deleting personal data in the vehicle

Concept

Depending on the usage, the vehicle stores personal data, such as stored radio stations. This personal data can be permanently deleted using Toyota Supra Command.

General information

Depending on the equipment package, the following data can be deleted:

- Driver profile settings.
- Stored radio stations.
- Stored programmable memory buttons.
- Travel and Onboard Computer information.
- Music hard disc.
- Navigation, for instance stored destinations.
- Phone book.
- Online data, for instance Favorites, cookies.

- Office data, for instance voice notes.
- Login accounts.

Altogether, the deletion of the data can take up to 15 minutes.

Functional requirement

Data can only be deleted while stationary.

Deleting data

Heed and follow the instructions on the Control Display.

Via Toyota Supra Command:

- 1 "My Vehicle"
- 2 "System settings"
- 3 "Data privacy"
- 4 "Delete personal data"
- 5 "Delete personal data"
- 6 "OK"
- 7 Exit and lock the vehicle.

The deletion process takes 15 minutes to complete.

If not all of the data was deleted, repeat the deletion.

Canceling deletion

Switch on the drive-ready state to cancel deletion of the data.

Driver profile

Concept

In the driver profiles, individual settings for several drivers can be stored and called up again when required.

General information

There are three driver profiles with which personal vehicle settings can be stored. Every remote control has one of these driver profiles assigned.

If the vehicle is unlocked using a remote control, the assigned personal driver profile will be activated. All settings stored in the driver profile are automatically applied.

If several drivers use their own remote control, the vehicle will adjust the personal settings during unlocking. These settings are also restored, if the vehicle has been used in the meantime by a person with a different remote control.

Changes to the settings are automatically stored in the driver profile currently activated.

If another driver profile is selected via Toyota Supra Command, the settings stored in it will be applied automatically.

The new driver profile is assigned to the vehicle key that

is currently in use.

There is an additional guest profile available that is not assigned to any vehicle key. It can be used to apply settings in the vehicle without changing the personal driver profiles.

Functional requirements

For the system to be able to identify the driver profile associated to a particular driver, the detected remote control must be clearly allocated to the driver.

This is the case when:

- The driver is only carrying his or her own remote control.
- The driver unlocks the vehicle.
- The driver gets into the vehicle through the driver's door.

Active driver profile

After switching on the Control Display, the name of the active driver profile is displayed.

Select driver profile, refer to page 70.

As soon as the engine is started or any key is pressed, the last selected display is shown on the Control Display.

To exit the welcome screen via Toyota Supra Command: "OK"

Adjusting

The settings for the following systems and functions are stored in the active driver profile. The scope of storable settings depends on country and equipment.

- Unlocking and locking.
- Lights.
- Climate control.
- Radio.
- Instrument cluster.
- Programmable memory buttons.
- Volumes, tone.
- Control Display.
- TV.
- Parking Sensors.
- Rearview camera.
- Head-up Display.
- Sport mode switch.
- Seat position, exterior mirror position.

Both the positions saved via the seat memory and the last position set are saved.

- Toyota Supra Safety.

Profile management

Selecting a driver profile

Regardless of the remote control in use, a different driver profile may be activated. This allows you to call up personal vehicle settings, even if you did not unlock the vehicle with your own remote control.

Via Toyota Supra Command:

- 1 "My Vehicle"
 - 2 "Driver profiles"
 - 3 Select driver profile.
 - 4 "OK"
- All settings stored in the called-up driver profile are automatically applied.
 - The called-up driver profile is assigned to the remote control being used at the time.
 - If the driver profile is already assigned to a different remote control, this driver profile will apply to both remote controls.

Guest profile

The guest profile is for individual settings that are stored in none of the three personal driver profiles.

Via Toyota Supra Command:

- 1 "My Vehicle"
- 2 "Driver profiles"
- 3 "Drive off (guest)"
- 4 "OK"

The guest profile cannot be renamed. It is not assigned to the current remote control.

Renaming a driver profile

A personal name can be assigned to the active driver profile to avoid confusion between the driver profiles.

Via Toyota Supra Command:

- 1 "My Vehicle"
- 2 "Driver profiles"
- 3 Select driver profile.
- ⚙️ The driver profile marked with this symbol can be renamed.
- 4 "Change driver profile name"
- 5 Enter profile name.
- 6 **OK** Select the symbol.

Resetting a driver profile

The settings of the active driver profile are reset to their factory settings.

Via Toyota Supra Command:

- 1 "My Vehicle"
- 2 "Driver profiles"
- 3 Select driver profile.
- ⚙️ The driver profile marked with this symbol can be reset.
- 4 "Reset driver profile"
- 5 "OK"

Exporting driver profiles

Most settings of the active driver profile can be exported.

Exporting is helpful when storing and retrieving personal settings, for instance before delivering the vehicle to a workshop. The stored driver profiles can be taken into another vehicle.

Via Toyota Supra Command:

- 1 "My Vehicle"

- 2 "Driver profiles"

- 3 Select driver profile.

⚙️ The driver profile marked with this symbol can be exported.

- 4 "Export driver profile"

- 5 Select a storage device for exporting the driver profile.

- "USB device"

Select USB storage device, as needed, refer to page 76.

Importing driver profiles

The existing settings of the active driver profile are overwritten with the settings of the imported driver profile.

Via Toyota Supra Command:

- 1 "My Vehicle"
- 2 "Driver profiles"
- 3 Select the driver profile to be overwritten.

⚙️ The driver profile marked with this symbol can be overwritten.

- 4 "Import driver profile"

- 5 Select a storage device for importing the driver profile.

- USB storage device: "USB device"

Select USB storage device as needed.

- 6 Select the driver profile to be imported.

System limits

A clear assignment between the remote control and driver may

not be possible in the following cases, for example.

- The passenger unlocks the vehicle with his or her own remote control, but another person is driving.
- The driver unlocks the vehicle via Smart Key System and has multiple remote controls with him or her.
- The driver changes, but the vehicle is not locked and unlocked.
- Multiple remote controls are located outside of the vehicle.

Connections

Vehicle features and options

This chapter describes all standard, country-specific and optional features offered with the series. It also describes features that are not necessarily available in your vehicle, for instance, due to the selected options or country versions. This also applies to safety-related functions and systems. When using these functions and systems, the applicable laws and regulations must be observed.

Concept

Various connection types are available for using mobile devices in the vehicle. The connection type to select depends on the mobile device and the desired function.

General information

The following overview shows possible functions and the suitable connection types for them. The scope of functions depends on the mobile device.

Function	Connection type
Making calls via the hands-free system. Using phone functions via Toyota Supra Command. Using the smart-phone Office functions.	Bluetooth.
Playing music from the smartphone or the audio player.	Bluetooth or USB.
Using compatible apps via Toyota Supra Command.	Bluetooth or USB.
USB storage device: Exporting and importing driver profiles. Exporting and importing stored trips. Playing music.	USB.
Playing videos from the smartphone or the USB storage device.	USB.
Use Apple CarPlay apps via Toyota Supra Command and voice operation.	Bluetooth and Wi-Fi.
Screen Mirroring: Showing the smart-phone display on the Control Display.	Wi-Fi

The following connection types require one-time pairing with the

vehicle:

- Bluetooth.
- Apple CarPlay.
- Screen Mirroring.

Paired devices are automatically recognized later on and connected to the vehicle.

Safety information

WARNING

Operating the integrated information systems and communication devices while driving can distract from surrounding traffic. It is possible to lose control of the vehicle. There is a risk of accident, injury, and property damage. Only use the systems or devices when the traffic situation allows. As warranted, stop and use the systems and devices while the vehicle is stationary.

Bluetooth connection

Functional requirements

- Compatible device with Bluetooth interface.
- The remote control is in the vehicle.
- The device is ready for operation.
- Bluetooth is switched on in the vehicle, refer to page 74, and on the device.
- Bluetooth default settings, such as for visibility, may be required on device; refer to your device operating instructions.

Switching on Bluetooth

Via Toyota Supra Command:

- 1 "My Vehicle"
- 2 "System settings"
- 3 "Mobile devices"
- 4 "Settings"
- 5 "Bluetooth®"

Activating/deactivating telephone functions

To use all supported functions of a mobile phone, the following functions must be activated prior to pairing the mobile phone with the vehicle.

Via Toyota Supra Command:

- 1 "My Vehicle"
- 2 "System settings"
- 3 "Mobile devices"
- 4 "Settings"
- 5 Select desired setting:
 - "Office"

Activate function to transmit short messages, e-mails, calendars, tasks, notes, and reminders to the vehicle. Costs can be incurred by transmitting all data to the vehicle.





- "Contact images"

Activate function to show the contact pictures.

- 6 Move the Controller to the left.

Pairing the mobile device with the vehicle

Via Toyota Supra Command:

- 1 "My Vehicle"
- 2 "System settings"
- 3 "Mobile devices"
- 4 "Connect new device"
- 5 Select functions:
 -  "Telephone"
 -  "Bluetooth® audio"
 -  "Apps"
 -  "Apple CarPlay"
 -  "Screen Mirroring"

The Bluetooth name of the vehicle is displayed on the Control Display.

- 6 On the mobile device, search for Bluetooth devices in the vicinity.

The Bluetooth name of the vehicle appears on the mobile device display.

Select the Bluetooth name of the vehicle.

- 7 Depending on the mobile device, a control number is displayed or the control number must be entered.
 - Compare the control number displayed on the Control Display with the control number on the display of the device.

Confirm the control number on the device and on the Control Display.

- Enter and confirm the same control number on the device and via Toyota Supra Command.

The device is connected and dis-

played in the device list, refer to page 79.

Frequently asked questions

All requirements are met and all required steps were completed in the specified order. Despite that, the mobile device does not function as expected.

In this case, the following explanations can help:

Why could the mobile phone not be paired or connected?

- There are too many Bluetooth devices connected to the mobile phone or vehicle.

In the vehicle, delete Bluetooth connections with other devices.

Delete all known Bluetooth connections from the device list on the mobile phone and start a new device search.

- The mobile phone is in power-save mode or has only a limited remaining battery life.

Charge mobile phone.

Why does the mobile phone no longer react?

- The applications on the mobile phone do not function anymore.

Switch the mobile phone off and on again.

- Too high or too low ambient temperature for mobile phone operation.

Do not subject the mobile phone to extreme ambient temperatures.

Why can phone functions not be used via Toyota Supra Command?

- The mobile phone may not be properly configured, for instance as Bluetooth audio device.

Connect the mobile phone with the telephone or additional phone function.

Why are no or not all phone book entries displayed or why are they incomplete?

- Transmission of the phone book entries is not yet complete.
- It is possible that only the phone book entries of the mobile phone or the SIM card are transmitted.
- It may not be possible to display phone book entries with special characters.
- It may not be possible to transmit contacts from social networks.
- The number of phone book entries to be stored is too high.
- Data volume of the contact too large, for instance due to stored information such as notes.

Reduce the data volume of the contact.

- A mobile phone can only be connected as audio source or as telephone.

Configure the mobile phone and connect it with the telephone or additional phone function.

How can the phone connection quality be improved?

- Adjust the strength of the Bluetooth signal on the mobile phone, depending on the mobile phone.
- Insert mobile phone into the wireless charging tray.
- Adjust the volume of the microphone and loudspeakers separately in the sound settings.

If all points in this list have been checked and the required function is still not available, contact the Toyota dealer.

USB connection

General information

Mobile devices with a USB port are connected to the USB port.

- Mobile phones.
- Audio devices such as MP3 players.
- USB storage devices.

Common file systems are supported. FAT32 and exFAT are the recommended formats.

A connected USB storage device will be supplied with charge current via the USB port if the device supports this. Follow the maximum charge current of the USB port.

The following uses are possible on USB ports with data transfer:

- Exporting and importing driver profiles, refer to page 69.
- Playing music files via USB audio.
- Playing videos via USB video.

Follow the following when connecting:

- Do not use force when plugging the connector into the USB port.
- Use a flexible adapter cable.
- Protect the USB storage device against mechanical damage.
- Due to the large number of USB media available on the market, it cannot be guaranteed that every device is operable on the vehicle.
- Do not expose USB media to extreme environmental conditions, such as very high temperatures; refer to the owner's manual of the device.
- Due to the many different compression techniques, proper playback of the media stored on the USB storage device cannot be guaranteed in all cases.
- To ensure proper transmission of the stored data, do not charge a USB storage device via the onboard socket, when it is connected to the USB port.
- Depending on how the USB storage device is being used,

settings may be required on the USB storage device, refer to the owner's manual of the device.

Not compatible USB media:

- USB hard drives.
- USB hubs.
- USB memory card readers with multiple inserts.
- HFS-formatted USB media.
- Devices such as fans or lamps.

Functional requirement

Compatible device with USB port.

Connecting the device

The USB storage device is displayed in the device list, refer to page 79.

Apple CarPlay*

*: if equipped

Concept

CarPlay allows certain functions of a compatible Apple iPhone to be used via Siri voice operation and Toyota Supra Command.

Functional requirements

- Compatible iPhone, Phone 5 or later with iOS 9.3 or later.
- Corresponding mobile wire-

less contract.

- Bluetooth, Wi-Fi, and Siri voice operation are activated on the iPhone.
- Booking the Toyota Supra Connect service: Apple CarPlay preparation.

Switching on Bluetooth and CarPlay

Via Toyota Supra Command:

- 1 "My Vehicle"
- 2 "System settings"
- 3 "Mobile devices"
- 4 "Settings"
- 5 Select the following settings:
 - "Bluetooth®"
 - "Apple CarPlay"

Pairing iPhone with CarPlay

Pair the iPhone with the vehicle via Bluetooth, refer to page 73.

Select CarPlay as the function:

- ▶ "Apple CarPlay"

The iPhone is connected to the vehicle and displayed in the device list, refer to page 79.

Operation

For more information, refer to the NAVIGATION SYSTEM OWNER'S MANUAL.

Frequently asked questions

All requirements are met and all required steps were completed in the specified order. Despite that, the mobile device does not function as expected.

In this case, the following explanations can help:

The iPhone has already been paired with Apple CarPlay. When a new connection is established, CarPlay can no longer be selected.

- Delete the iPhone concerned from the device list.
- On the iPhone, delete the vehicle concerned from the list of stored vehicles under Bluetooth and under Wi-Fi.
- Pair the iPhone as a new device.

If the steps listed have been carried out and the required function is still not available: contact the Toyota dealer.

Screen Mirroring

General information

Screen Mirroring enables mirroring (outputting) of the smartphone display on the Control Display.

Functional requirements

- Compatible smartphone with Screen Mirroring interface.
- Screen Mirroring is switched on on the smartphone.
- Wi-Fi is switched on in the vehicle.

Activating Wi-Fi

Via Toyota Supra Command:

- 1 "My Vehicle"
- 2 "System settings"
- 3 "Mobile devices"
- 4 "Settings"
- 5 "Vehicle Wi-Fi®"

Pairing a smartphone with Screen Mirroring

Via Toyota Supra Command:

- 1 "My Vehicle"
- 2 "System settings"
- 3 "Mobile devices"
- 4 "Connect new device"
- 5  "Screen Mirroring"

The Wi-Fi name of the vehicle is displayed on the Control Display.

- 6 Search for Wi-Fi devices in the surroundings of the smartphone.

The Wi-Fi name of the vehicle appears on the device display. Select the Wi-Fi name of the vehicle.

- 7 Confirm the connection via Toyota Supra Command.

The device is connected and displayed in the device list, refer to page 79.

Managing mobile devices

General information

- After one-time pairing, the devices are automatically recognized and reconnected when standby state is switched on.
- The data stored on the SIM card or in the mobile phone are transferred to the vehicle after recognition.
- For some devices, certain settings are necessary, for instance authorization; see the owner's manual of the device.



Displaying the device list





All devices paired with or connected to the vehicle are displayed in the device list.

Via Toyota Supra Command:

- 1 "My Vehicle"
- 2 "System settings"
- 3 "Mobile devices"

A symbol indicates, for which function a device is used.

Symbol	Function
	"Telephone"
	"Additional telephone"

Symbol	Function
	"Bluetooth® audio"
	"Apps"
	"Apple CarPlay"
	"Screen Mirroring"

Configuring the device

Functions can be activated or deactivated for paired and connected devices.

Via Toyota Supra Command:

- 1 "My Vehicle"
- 2 "System settings"
- 3 "Mobile devices"
- 4 Select the desired device.
- 5 Select the desired setting.

If a function is assigned to a device, the function will be deactivated where appropriate for a device that is already connected and the device will be disconnected.

Disconnecting the device

Via Toyota Supra Command:

- 1 "My Vehicle"
- 2 "System settings"
- 3 "Mobile devices"
- 4 Select a device.
- 5 "Disconnect device"

The device remains paired and can be connected again, refer to page 80.

Connecting the device

A disconnected device can be reconnected.

Via Toyota Supra Command:

- 1 "My Vehicle"
- 2 "System settings"
- 3 "Mobile devices"
- 4 Select device.
- 5 "Connect device"

The functions that were assigned to the device before disconnecting are assigned to the device when it is reconnected. The functions may be deactivated on a device already connected.

Deleting the device

Via Toyota Supra Command:

- 1 "My Vehicle"
- 2 "System settings"
- 3 "Mobile devices"
- 4 Select device.
- 5 "Delete device"

The device is disconnected and removed from the device list.

Swapping the telephone and additional phone

When a second phone is paired with the vehicle, this phone is stored as an additional phone. The assignment of phone and additional phone can be

changed.

Via Toyota Supra Command:

- 1 "My Vehicle"
- 2 "System settings"
- 3 "Mobile devices"
- 4 "Settings"
- 5 "Swap telephone/additional tel."

Opening and closing**Vehicle features and options**

This chapter describes all standard, country-specific and optional features offered with the series. It also describes features and functions that are not necessarily available in your vehicle, e.g., due to the selected options or country versions. This also applies to safety-related functions and systems. When using these functions and systems, the applicable laws and regulations must be observed.

Remote control**General information**

The vehicle is supplied with two remote controls with integrated key.

Each remote control contains a replaceable battery. Replacing the battery, refer to page 85.

Depending on the equipment and country version, various settings, refer to page 94, can be configured for the button functions.

A driver profile, refer to page 69, with personal settings can be assigned to a remote control.

To prevent possible locking in of

the remote control, take the remote control with you when exiting the vehicle.

Safety information** WARNING**

The vehicle key has a button cell battery. Batteries or button cells can be swallowed and lead to serious or fatal injuries within two hours, for example, due to internal burns or chemical burns. There is an injury hazard and danger to life. Keep the vehicle key and batteries out of reach for children. Immediately seek medical help if there is any suspicion that a battery or button cell has been swallowed or is located in any part of the body.

 WARNING

People or animals in the vehicle can lock the doors from the inside and lock themselves in. In this case, the vehicle cannot be opened from the outside. There is a risk of injury and danger to life. Take the remote control with you so that the vehicle can be opened from the outside.

 WARNING

For some national-market versions, unlocking from the inside is only possible with particular knowledge.

⚠ WARNING

There is a risk of injury and danger to life if people or animals remain in the vehicle for a long period of time and are exposed to extreme temperatures. Do not lock the vehicle from the outside when there are people or animals in it. Do not leave babies, toddlers or animals alone in the vehicle.

⚠ WARNING

Unattended children or animals in the vehicle can cause the vehicle to move and endanger themselves and traffic, for instance due to the following actions:

- Pressing the Start/Stop button.
- Releasing the parking brake.
- Opening and closing the doors or windows.
- Engaging selector lever position N.
- Using vehicle equipment.

There is a risk of accident, injury, and property damage. Do not leave children or animals unattended in the vehicle. Take the vehicle key with you when exiting and lock the vehicle.

Overview

- 1 Unlocking
- 2 Locking
- 3 Unlocking the trunk lid
- 4 Panic mode, pathway lighting

Unlocking**General information**

The behavior of the vehicle when unlocking with the remote control depends on the following settings, refer to page 94, for unlocking and locking:

- If only the driver's door and the fuel filler flap or all access to the vehicle will be unlocked.
- If the unlocking of the vehicle is confirmed with a light signal or a sound signal.
- If the welcome light, refer to page 161, is switched on when the vehicle is being unlocked.
- If the exterior mirrors are automatically folded out and in when the vehicle is unlocked and locked.
- If the driver's seat is set to the last position saved in the driver's profile. P.69

Unlocking the vehicle

Press the button on the remote control.

If, due to the settings, only the driver's door and fuel filler flap

were unlocked, press the button on the remote control again to unlock the other vehicle access points.

In addition, the following functions are executed:

- If a driver profile, refer to page 69, was assigned to the remote control, this driver profile will be activated and the settings that are stored in it will be applied.
- The interior lights are switched on, unless they were manually switched off. For switching the interior lights on/off manually, refer to page 165.
- Folded in exterior mirrors are folded out.

If the exterior mirrors were folded in via the button in the car's interior, they will not be folded out when unlocking.

- With alarm system: The alarm system, refer to page, will be switched off.

The light functions may depend on the ambient brightness.

Convenient opening

Opening



Press and hold the button on the remote control.

The windows are opened, as long as the button on the remote control is pressed.

Locking

General information

The behavior of the vehicle during locking with the remote control depends on the following settings, refer to page 94:

- If the locking of the vehicle is confirmed with a light signal or a sound signal.
- If the exterior mirrors are automatically folded in when the vehicle is locked. The exterior mirrors are not folded in when the hazard warning flashers are switched on.
- If the headlight courtesy delay feature is activated during locking.

Locking the vehicle

- 1 Close the driver's door.
- 2  Press the button on the remote control.

The following functions are executed:

- All doors, the trunk lid, and the fuel filler flap are locked.
- With alarm system: The alarm system will be switched on.

If the drive-ready state is still switched on when you lock the vehicle, the vehicle horn honks twice. In this case, the drive-ready state must be switched off by means of the

Start/Stop button.

With Smart Key System: convenient closing

Safety information

WARNING

With convenient closing, body parts can be jammed. There is a risk of injury. Make sure that the area of movement of the doors is clear during convenient closing.

Closing



Press and hold the button on the remote control after locking.

The windows are closed in the area close to the vehicle, as long as the button on the remote control is pressed.

Switching on the interior and exterior lights



Press the button on the remote control with the vehicle locked.

The function is not available for the first 10 seconds after locking.

- The interior lights are switched on, unless they were manually switched off. For switching the interior lights on/off manually, refer to page 165.
- Depending on the settings, the exterior lighting, refer to

page 161, will be switched on.

The light functions may depend on the ambient brightness.

Trunk lid

General information

To avoid locking the vehicle key in the vehicle, do not place the vehicle key in the cargo area.

You can set up if the doors will be unlocked when the trunk lid is opened with the remote control. Settings, refer to page 94.

Safety information

WARNING

Body parts can be jammed when operating the trunk lid. There is a risk of injury. Make sure that the area of movement of the trunk lid is clear during opening and closing.

WARNING

While opening, the trunk lid pivots back and up. There is a risk of injury and risk of damage to property. Make sure that the travel path of the trunk lid is clear while opening and closing.

Unlocking



Press and hold the button on the remote control for approx. 1 second.

Panic mode

You can trigger the alarm system if you find yourself in a dangerous situation.

- Press the button on the remote control and hold for at least 3 seconds.
- Briefly press the button on the remote control three times in succession.



To switch off the alarm: press any button.

Switching on the headlight courtesy delay feature

Press and hold the button on the remote control for approx. 1 second.



Set the duration, refer to page 162.

Replacing the battery

! WARNING

The battery inside the vehicle key is a button cell. Batteries or button cells can be swallowed, causing serious or even fatal injuries within two hours, e.g. due to internal burns or cauterisations. There is a danger of injury or danger to life. Keep vehicle keys and batteries out of the reach of children. Seek medical assistance immediately if you suspect that a battery or button cell has been swallowed or has got into a part of the body.



NOTICE

Using unsuitable batteries in a vehicle key can damage the vehicle key. There is a risk of material damage. Discharged batteries should only ever be replaced with batteries of the same voltage, same size and same specification.

- 1 Remove the integrated key from the remote control, refer to page 88.
- 2 Place the integrated key underneath the battery compartment cover, arrow **1**, and lift the cover with a lever movement of the integrated key, arrow **2**.

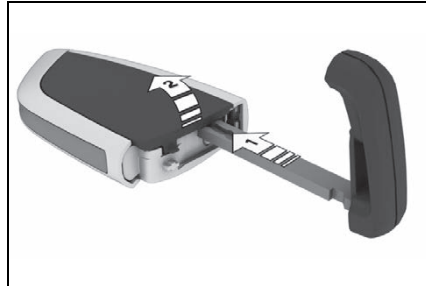

- 3 Push battery in the direction of the arrow using a pointed object and lift it out.

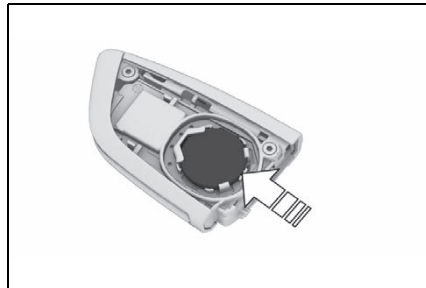

- 4 Insert a type CR 2032 3V battery with the positive side facing up.
- 5 Press the cover closed.
- 6 Push the integrated key into the vehicle key until the integrated key engages.



Have old batteries disposed of by your Toyota dealer or take them to a collection point.



Batteries contain harmful chemicals. It is prohibited by law to dispose of batteries together with household waste.

Additional remote controls

Additional remote controls are available from your Toyota dealer.

Loss of the remote controls

A lost remote control can be blocked and replaced by your Toyota dealer.

If the lost remote control has an assigned driver profile, refer to page 69, the connection to this remote control must be deleted. A new remote control can then be assigned to the driver profile.

Malfunction

General information

A vehicle message, refer to page 140, is displayed.

Remote control detection by the vehicle may malfunction under the following circumstances:

- The battery of the vehicle key is discharged. For replacing the battery, refer to page 85.
- Interference of the radio connection from transmission towers or other equipment with high transmitting power.
- Shielding of the remote control due to metal objects.

Do not transport the remote control together with metal objects.

- Interference of the radio connection from mobile phones or other electronic devices in direct proximity to the remote control.

Do not transport the remote control together with electronic devices.

- Interference of radio transmission by a charging process of mobile devices, for instance charging of a mobile phone.
- The remote control is in direct proximity of the wireless charging tray.

Place the remote control down at a different location.

In the case of interference, the vehicle can be unlocked and locked from the outside with the

integrated key, refer to page 87.

Switching the drive-ready state on via emergency detection of the remote control

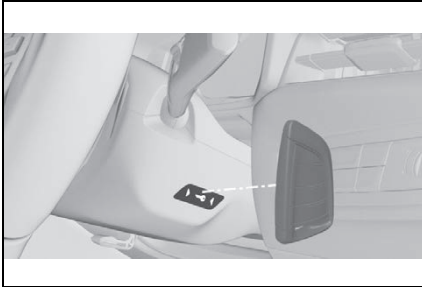

It is not possible to switch on the drive-ready state if the remote control has not been detected.

Proceed as follows in this case:

- 1** Hold the remote control with its back against the marked area on the steering column. Pay attention to the display in the instrument cluster.
- 2** If the remote control is detected: Switch on drive-ready state within 10 seconds.

If the remote control is not detected, slightly change the position of the remote control and repeat the procedure.

Frequently asked questions

What precautions can be taken to be able to open a vehicle with an accidentally locked in remote

control?

- The options provided by the Remote Services of the Toyota Supra Connect app include the ability to lock and unlock a vehicle.

This requires an active Toyota Supra Connect contract and the Toyota Supra Connect app must be installed on a smartphone.

- Unlocking the vehicle can be requested via the Concierge.

An active Toyota Supra Connect contract is required.

Integrated key

General information

The driver's door can be locked and unlocked without remote control using the integrated key.

The integrated key also fits the glove compartment.

Safety information

⚠ WARNING

For some national-market versions, unlocking from the inside is only possible with particular knowledge.

There is a risk of injury and danger to life if people or animals remain in the vehicle for a long period of time and are exposed to extreme temperatures. Do not lock the vehicle from the outside when there are people or animals in it. Do not leave babies, toddlers or animals alone in the vehicle.

**NOTICE**

The door lock is permanently joined with the door. The door handle can be moved. When pulling the door handle with the integrated key inserted, paint or the integrated key can be damaged. There is a risk of damage to property. Remove the integrated key before pulling the outside door handle.

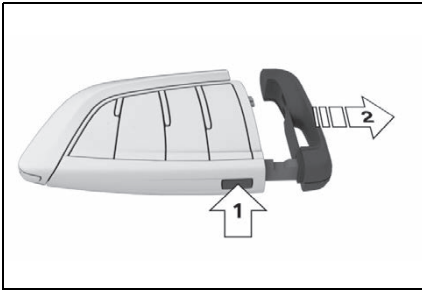
Removing

Press the button, arrow **1**, and pull out the integrated key, arrow **2**.

Locking/unlocking via the door lock

- 1** Pull and hold the door handle outward with one hand.

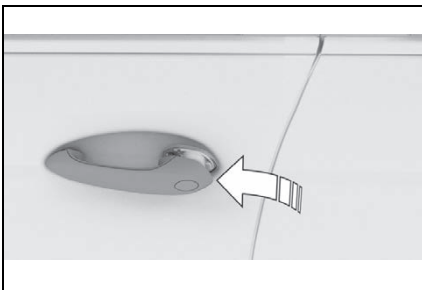

- 2** Guide one finger of your other hand from the back

under the cover and push the cover out.

Use the thumb for counter support to prevent the cover from falling out of the door handle.

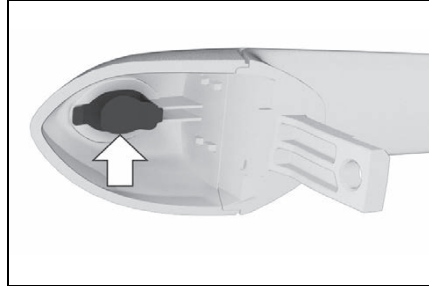

- 3** Remove the cover.
- 4** Unlock or lock the door lock using the integrated key.

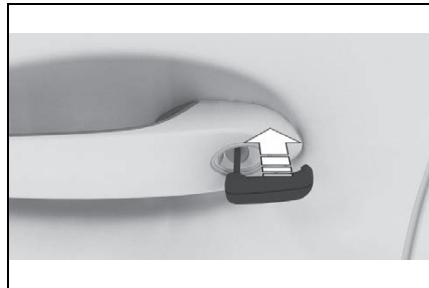

The other doors must be unlocked or locked from the inside.

Alarm system

The activated alarm system is triggered when the door is opened, if the vehicle has been unlocked via the door lock.

The alarm system is not switched on if the vehicle is locked with the integrated key.

Buttons for the central locking system

General information

In the event of a severe accident, the vehicle is automatically unlocked. The hazard warning system and interior lights come on.

Overview



Buttons for the central locking system.

Locking



Press the button with the front doors closed.

The fuel filler flap remains unlocked.

Unlocking



Press the button.

Opening

- Pull the door handle on the door to open the door. The

other doors remain locked.

-  Press the button to unlock all the doors. Pull the door opener.

Smart Key System

Concept

The vehicle can be accessed without operating the vehicle key.

Carrying the vehicle key with you, e.g., in your pants pocket, is sufficient.

The vehicle automatically detects the remote control when it is in close proximity or in the car's interior.

General information

Comfort entry supports the following functions:

- Unlocking and locking the vehicle from the door handle.

Functional requirements

- To lock the vehicle, the remote control must be located outside of the vehicle near the doors.
- The next unlocking and locking cycle is not possible until after approx. 2 seconds.

Important points

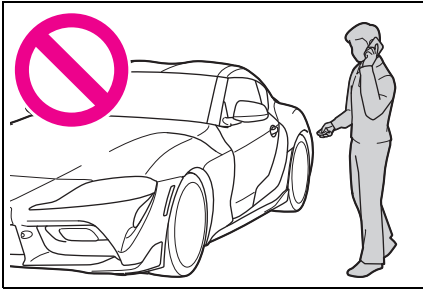

- The driver should always carry the remote control on their person and take it with them when they leave the vehicle.
- Depending on the location of the vehicle or the surrounding radio wave conditions, the remote control may not operate normally. Make sure not to carry the remote control with an electronic device, such as a mobile phone or computer.
- Make sure to always take the remote control with you when you leave the vehicle, in case the battery of the remote control is depleted or the remote control is malfunctioning.

Safety notes

WARNING

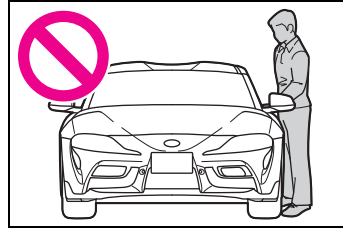

The vehicle transmits radio waves whenever the Smart Key System is used to lock or unlock the doors, open the trunk lid, or when the engine switch is operated. Therefore, this system may affect the operation of implantable cardiac pacemakers and implantable cardioverter defibrillators.

Persons with implantable cardiac pacemakers or implantable cardioverter defibrillators should stay 8.6 in./22 cm or more away from the vehicle when opening or closing a door. Also, they should refrain from leaning on the vehicle or looking through the windows from outside when a door is opened or closed.

Users of any electrical medical device other than implantable cardiac pacemakers, cardiac resynchronization therapy-pacemakers or implantable cardioverter defibrillators should consult their doctor or the manufacturer of the device for information about its operation under the influence of radio waves.

Effective range (areas within which Smart Key System radio waves are transmitted)

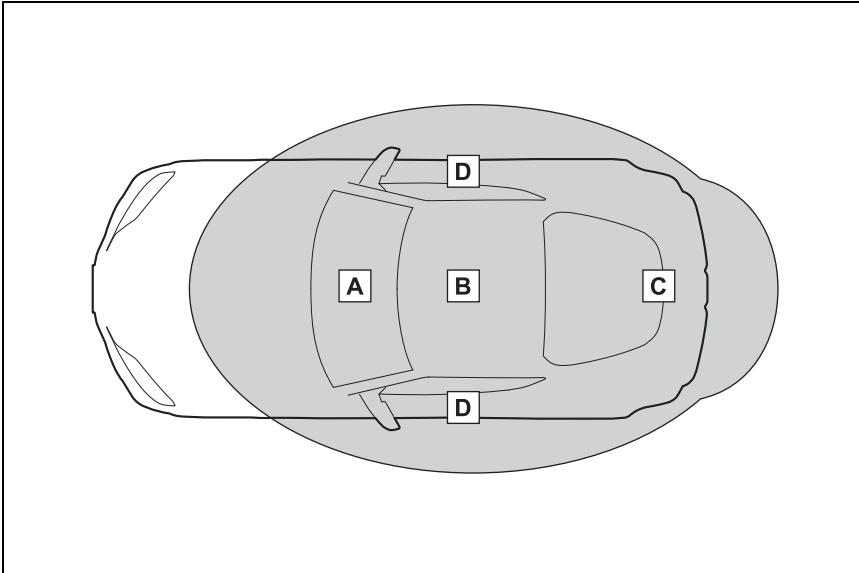

- A** Near the front of the center console
- B** Near the rear of the center console
- C** In the luggage compartment and near the rear bumper
- D** Near each door and door handle

Unlocking

General information

The behavior of the vehicle during unlocking via the Smart Key System depends on the following settings, refer to page 94:

- If the unlocking of vehicle is confirmed with a light signal or a sound signal.
- If the welcome light, refer to page 161, is switched on when the vehicle is being

unlocked.

- If the exterior mirrors are automatically folded out and in when the vehicle is unlocked and locked.

Unlocking the vehicle

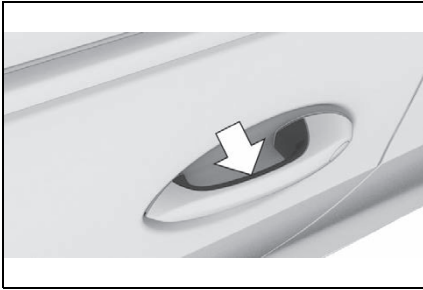

Grasp the handle of a vehicle door completely.

In addition, the following functions are executed:

- If a driver profile was assigned to the vehicle key, this driver profile will be activated and the settings that are stored in it will be applied.
- The interior lights are switched on, unless they were manually switched off.
- Folded in exterior mirrors are folded out.

If the exterior mirrors were folded in via the button in the car's interior, they will not be folded out when unlocking.

- With alarm system: The alarm system will be switched off.

Locking

General information

The behavior of the vehicle during locking via the Smart Key System depends on the following settings, refer to page 94:

- If the locking of the vehicle is confirmed with a light signal or a sound signal.
- If the exterior mirrors are automatically folded in when the vehicle is locked. The exterior mirrors are not folded in when the hazard warning flashers are switched on.
- If the headlight courtesy delay feature is activated during locking.

Locking the vehicle

Close the driver's door.

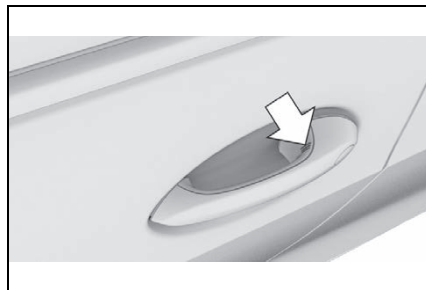

Touch the grooved surface on the handle of a closed vehicle door with your finger for approx. 1 second without grasping the door handle.

The following functions are executed:

- All doors, the trunk lid, and the fuel filler flap are locked.
- With alarm system: The alarm system will be switched on.

Trunk lid

General information

To avoid locking the vehicle key in the vehicle, do not place the vehicle key in the cargo area.

Depending on the vehicle equipment and country version, it is also possible to have the doors unlocked. To perform settings, refer to page 94.

Safety information

WARNING

Body parts can be jammed when operating the trunk lid. There is a risk of injury. Make sure that the area of movement of the trunk lid is clear during opening and closing.

WARNING

While opening, the trunk lid pivots back and up. There is a risk of injury and risk of damage to property. Make sure that the travel path of the trunk lid is clear while opening and closing.

NOTICE

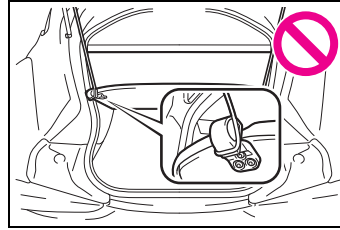

When closing the trunk lid, make sure that the straps of the luggage cover are not caught.

If a strap is caught on the luggage cover, when the trunk lid is closed, the strap hanger on the trunk lid may be damaged.

Opening and closing

Opening from the outside



Press and hold the button on the remote control for approx. 1 second.

When unlocking with the vehicle key, refer to page 84, the doors may also be unlocked.

Opening from the inside



Press the button in the storage compartment of the driver's door.

Closing



Grasp the recess grips and pull the trunk lid down.

Trunk emergency unlocking

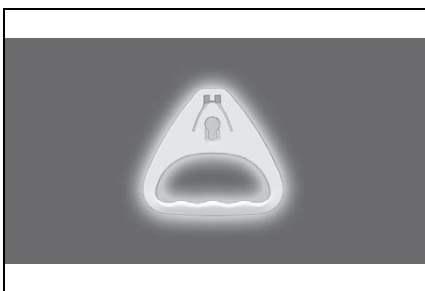

Pull the handle inside the cargo area.

The trunk lid unlocks.

Settings



General information

Depending on the package and country version, various settings are available for the remote control functions.

Unlocking

Doors

Via Toyota Supra Command:

- 1 "My Vehicle"
- 2 "Vehicle settings"
- 3 "Doors/Key"
- 4  "Driver's door" or  "All doors"
- 5 Select the desired setting:
 - "Driver's door only"

Only the driver's door and the fuel filler flap are unlocked. Pressing again unlocks the entire vehicle.



- "All doors"

The entire vehicle is unlocked.

Trunk lid

Depending on the vehicle equipment and country version, this setting may not be offered.

Via Toyota Supra Command:

- 1 "My Vehicle"
- 2 "Vehicle settings"
- 3 "Doors/Key"
- 4  "Tailgate" or  "Tailgate and door(s)"
- 5 Select the desired setting:
 - "Tailgate"

The trunk lid is opened.

- "Tailgate and door(s)"

The trunk lid is opened and the doors are unlocked.

Adjusting the last seat and mirror position

Via Toyota Supra Command:

- 1 "My Vehicle"
- 2 "Driver profiles"
- 3 Select driver profile.

 The setting can be made for the driver profile marked with this symbol.

- 4 "Last seat position automatic"

When the vehicle is unlocked, the driver's seat and exterior mirrors resume their last set positions.

The most recent position is independent of the positions saved via the seat memory.

Confirmation signals from the vehicle

Via Toyota Supra Command:

- 1 "My Vehicle"
- 2 "Vehicle settings"
- 3 "Doors/Key"
- 4 Deactivate or activate the desired confirmation signals:
 - "Flash for lock/unlock"

Unlocking is signaled by two flashes, locking by one.

Automatic locking

Via Toyota Supra Command:

- 1 "My Vehicle"
- 2 "Vehicle settings"

- 3 "Doors/Key"

- 4 "Lock automatically"

The vehicle locks automatically after a short period of time if no door is opened after unlocking.

Automatic unlocking

Via Toyota Supra Command:

- 1 "My Vehicle"
- 2 "Vehicle settings"
- 3 "Doors/Key"
- 4 "Unlock at end of trip"

After drive-ready state is switched off by pressing the Start/Stop button, the locked vehicle is automatically unlocked.

Folding mirrors automatically

Via Toyota Supra Command:

- 1 "My Vehicle"
- 2 "Vehicle settings"
- 3 "Doors/Key"
- 4 "Fold mirrors in when locked"

The exterior mirrors are automatically folded in during locking.

Establishing idle state after opening the front doors

Via Toyota Supra Command:

- 1 "My Vehicle"
- 2 "Vehicle settings"
- 3 "Doors/Key"

4 "Turn off after door opening"

Opening the front doors establishes the idle state, refer to page 45.

Alarm system

Concept

The alarm system issues a visual and acoustic signal when someone attempts to open the locked vehicle incorrectly.

General information

When the vehicle is locked, the vehicle alarm system reacts to the following changes:

- Opening a door, the hood or the trunk lid.
- Movements in the car's interior.
- Changes in the vehicle tilt, e. g., during attempts at stealing a wheel or when towing the vehicle.
- Disconnected battery voltage.
- Incorrect use of the diagnostic socket.
- Locking the vehicle while a device is connected to the diagnostic socket.

The alarm system signals the following changes visually and acoustically:

- Acoustic alarm: Depending on local regulations, the acoustic alarm may be suppressed.
- Visual alarm: By flashing of the hazard warning system

and headlights, where required.

Do not modify the system to ensure function of the alarm system.

Switching on/off

When you unlock and lock the vehicle, either with the remote control or with Comfort entry, the alarm system is switched off and on at the same time.

Opening the doors with the alarm system switched on

The alarm system is triggered when a door is opened if the door was unlocked using the integrated key in the door lock.

Switching off the alarm, refer to page 98.

Opening the trunk lid with the alarm system switched on

The trunk lid can be opened even when the alarm system is switched on.

After the trunk lid is closed, it is locked and monitored again provided the doors are locked. The hazard warning system flashes once.

Panic mode

You can trigger the alarm system if you find yourself in a dangerous situation.



- Press the button on the remote control and hold for at least 3 seconds.
- Briefly press the button on the remote control three times in succession.

To switch off the alarm: press any button.

Indicator light on the interior mirror

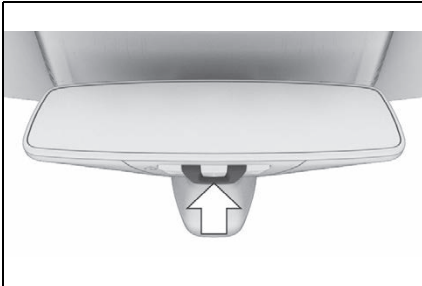

- The indicator light flashes briefly every 2 seconds: The alarm system is switched on.
- Indicator light flashes for approx. 10 seconds, then it flashes briefly every 2 seconds: Interior motion sensor and tilt alarm sensor are not active, as doors, hood, or trunk lid are not correctly closed. Correctly closed access points are secured.

When the still open access points are closed, interior motion sensor and tilt alarm sensor will be switched on.

- The indicator light goes out after unlocking: The vehicle has not been tampered with.
- The indicator light flashes after unlocking until drive-ready state is switched on, but no longer than approx. 5 minutes: An alarm has been triggered.

Tilt alarm sensor

The tilt of the vehicle is monitored.

The alarm system responds in situations such as attempts to steal a wheel or when the vehicle is towed.

Interior motion sensor

The car's interior is monitored to the height of the seats. The alarm system is switched on together with the interior motion sensor even when the window is open. Falling objects such as leaves can trigger the alarm unintentionally.

Avoiding unintentional alarms

General information

The tilt alarm sensor and interior

motion sensor can trigger an alarm, although no unauthorized action occurred.

Possible situations for an unwanted alarm:

- In automatic vehicle washes.
- In duplex garages.
- During transport on trains carrying vehicles, at sea or on a trailer.
- With animals in the vehicle.
- When the vehicle is locked after start of fueling.

The tilt alarm sensor and the interior motion sensor can be switched off in such situations.

Switching off the tilt alarm sensor and interior motion sensor



Press the button on the remote control within 10 seconds as soon as the vehicle is locked.

The indicator light lights up for approx. 2 seconds and then continues to flash.

The tilt alarm sensor and interior motion sensor are switched off until the vehicle is locked again.

Switching off the alarm

- Unlock the vehicle with the remote control.
- Unlock the vehicle with the integrated key and activate the drive-ready state via emergency detection of the

vehicle key, refer to page 86.

- With Smart Key System: when carrying the vehicle key, grasp the driver's door or front passenger door handle completely.

Power windows

General information

The windows can be opened with the vehicle key from the outside as well as closed with Smart Key System.

Additional information: Vehicle key, refer to page 81.

Safety information

WARNING

When operating the windows, body parts and objects can be jammed. There is a risk of injury and risk of damage to property. Make sure that the area of movement of the windows is clear during opening and closing.

Overview



Power windows

Functional requirements

The windows can be operated under the following conditions.

- Standby state is established.
- Drive-ready state is activated.

The remote control must be in the car's interior.

Opening

-  Press the switch to the resistance point.

The window opens while the switch is being held.

-  Press the switch beyond the resistance point.

The window opens automatically. Pressing the switch again stops the motion.

Closing

-  Pull the switch to the resistance point.

The window closes while the switch is being held.

-  Pull the switch beyond the resistance point.

The window closes automatically if the door is closed. Pulling again stops the motion.

Jam protection system

Concept

The jam protection prevents

objects or body parts becoming jammed between the door frame and window while a window is being closed.

General information

If resistance or a blockage is detected while a window is being closed, the closing action is interrupted.

Safety information

WARNING

Accessories on the windows such as antennas can impact jam protection. There is a risk of injury. Do not install accessories in the area of movement of the windows.

Closing without the jam protection system

In case of danger from the outside or if ice might prevent normal closing, proceed as follows:

- 1  Pull the switch past the resistance point and hold it there.

The window closes with limited jam protection. If the closing force exceeds a specific threshold, closing is interrupted.

- 2  Pull the switch past the resistance point again within approx. 4 seconds and hold it there.

The window closes without jam protection.

Seats, mirrors, and steering wheel

Vehicle features and options

This chapter describes all standard, country-specific and optional features offered with the series. It also describes features and functions that are not necessarily available in your vehicle, e.g., due to the selected options or country versions. This also applies to safety-related functions and systems. When using these functions and systems, the applicable laws and regulations must be observed.

Sitting safely

An ideal seating position that meets the needs of the occupants can make a vital contribution to relaxed, fatigue-free driving.

In the event of an accident, the correct seating position plays an important role. Follow the information in the following chapters:

- Seats, refer to page 100.
- Safety belts, refer to page 104.
- Head restraints, refer to page 109.
- Airbags, refer to page 166.

Seats

Safety information

WARNING

Seat setting while driving can lead to unexpected movements of the seat. There is a risk of accident, injury, and property damage. Only adjust the seats when the vehicle is stationary.

WARNING

With a backrest inclined too far to the rear, the efficacy of the safety belt can no longer be ensured. There is a risk of sliding under the safety belt in an accident. There is a risk of injuries and danger to life. Adjust the seat prior to starting the trip. Adjust the backrest so that it is in the most upright position as possible and do not adjust again while driving.

WARNING

There is a risk of jamming when moving the seats. There is a risk of injury and risk of damage to property. Make sure that the area of movement of the seat is clear prior to any adjustment.

Manually adjustable seats

Overview

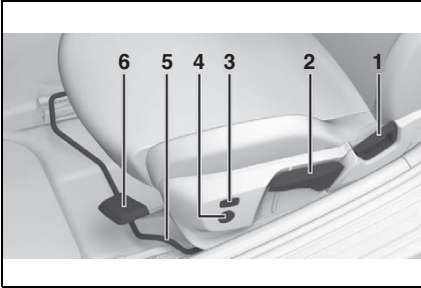

- 1** Backrest angle
- 2** Height
- 3** Backrest width*
- 4** Lumbar support*
- 5** Forward/back
- 6** Seat angle*

* : if equipped

Backrest angle

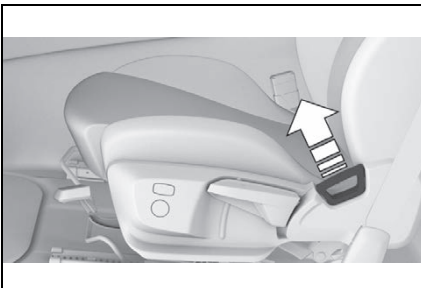

Pull the lever and apply your weight to or lift your weight off the backrest as required.

Height

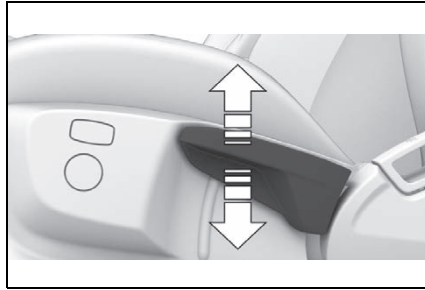

Pull the lever up or press the lever down repeatedly until the seat reaches the desired height.

Forward/back

⚠ WARNING

If the seat is not locked, it could move unexpectedly during a journey. You could lose control of the vehicle. There is a risk of accident and danger of injury. After making an adjustment, move the seat forwards and backwards slightly to ensure that it is properly engaged.

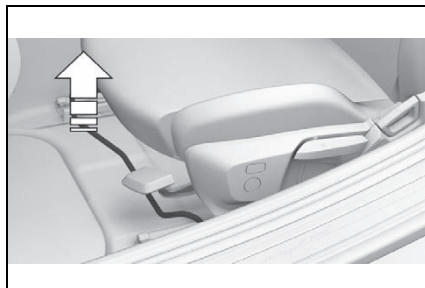

Pull the lever and slide the seat in the desired direction.

Seat angle

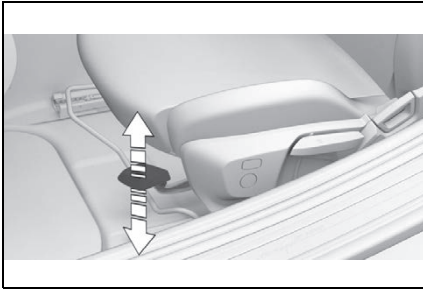

Pull the lever up or press the lever down repeatedly until the seat reaches the desired angle.

Electrically adjustable seats*

*: if equipped

General information

The seat adjustment for the driver's seat is stored for the driver profile currently used. When the vehicle is unlocked via the vehicle key, the position is automatically retrieved if the function, refer to page 69, is activated for this purpose.

The current seat position can be stored using the memory function, refer to page 112.

Overview

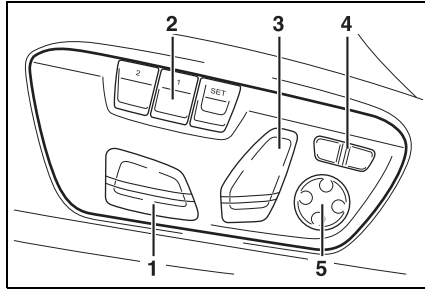

- 1 Forward/backward, height, seat tilt
- 2 Driver's seat memory
- 3 Backrest tilt
- 4 Backrest width
- 5 Lumbar support

Forward/backward

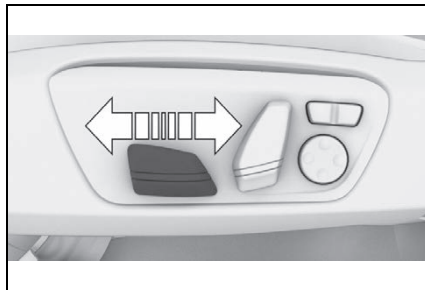

Push switch forward or backward.

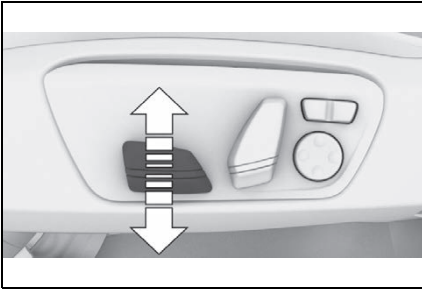
Height

Push switch up or down.

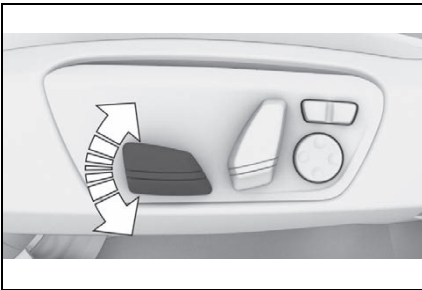
Seat tilt

Move switch up or down.

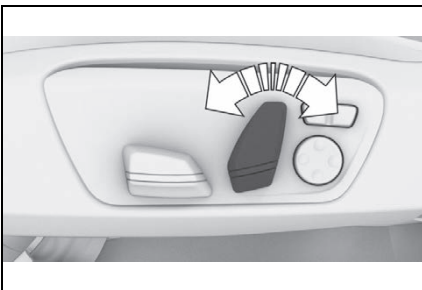
Backrest tilt

Move switch forward or backward.

Calibrating the front seats**■ General information**

As soon as the electric seat setting no longer functions precisely, a Check Control message is displayed on the control display.

To restore the accuracy of the electric seat setting, the front seats must be calibrated.

■ Safety information**⚠ WARNING**

There is a risk of jamming when moving the seats. There is a risk of injury and risk of damage to property. Make sure that the travel path of the seat is clear prior to any adjustment.

■ Calibrating the front seat

- 1** Press and hold the switch forward until the seat stops.
- 2** Press the switch forward again until the seat stops.
- 3** Readjust the seat to the desired position.

As soon as the message on the control display disappears, the calibration is complete. If the message remains active, repeat the calibration.

If the message is still shown after repeated calibration, have the system checked by your Toyota dealer.

Lumbar support

Concept

The curvature of the seat backrest can be adjusted in a way that it supports the lumbar region of the spine. The lower back and the spine are supported for upright posture.

Adjusting



- Press the front/rear section of the button: The curvature is increased/decreased.
- Press the upper/lower section of the button: The curvature is shifted up/ down.

Backrest width

Concept

Adjusting the backrest width may improve lateral support when taking corners.

General information

You can change the backrest width by adjusting the side wings of the backrest.

Adjusting



- Press the front section of the button: The backrest width decreases.
- Press the rear section of the button: The backrest width increases.

Safety belts

General information

The vehicle is fitted with two safety belts to ensure occupant safety. However the safety belt can only offer protection when adjusted correctly.

Always make sure that safety belts are being worn by the occupants before driving off. The airbags supplement the safety belts as an additional safety device. The airbags are not a substitute for safety belts.

All belt fastening points are designed to achieve the best possible protective effect of the safety belts with proper use of the safety belts and correct seat setting. Notes on sitting safely, refer to page 100.

Safety information

⚠ WARNING

Use of a safety belt to buckle more than one person will potentially defeat the ability of the safety belt to serve its protective function. There is a risk of injuries and danger to life. Do not allow more than one person to wear a single safety belt. Infants and children are not allowed on an occupant's lap, and must be transported and secured in designated child restraint systems.

⚠ WARNING

The efficacy of safety gear, including safety belts, can be limited or lost when safety belts are fastened incorrectly. An incorrectly fastened safety belt can cause additional injuries, for instance in the event of an accident or during braking and evasive maneuvers. There is a risk of injuries and danger to life. Make sure that all occupants are wearing safety belts correctly.

⚠ WARNING

The efficacy of safety gear, including safety belts, may not be fully functional or fail in the following situations:

- The safety belts or safety belt buckles are damaged, soiled, or changed in any other way.
- Safety belt tensioners or roll-up mechanism were modified.

Safety belts can be imperceptibly damaged in the event of an accident. There is a risk of injury and danger to life. Do not modify safety belts, safety belt buckles, safety belt tensioners, rollup mechanisms, or belt anchors and keep them clean. Have the safety belts checked after an accident at the your Toyota dealer.

Correct use of safety belts

- Wear the safety belt so that it fits tightly to your body over your pelvis and shoulder and is not twisted.
- Wear the safety belt low down on your hips in the pelvic region. The safety belt must not press on your stomach.
- Do not rub the safety belt against sharp edges, or guide it or jam it in across hard or fragile objects.
- Avoid thick clothing.
- Re-tighten the safety belt frequently upward in your upper body area.

Correct driving posture

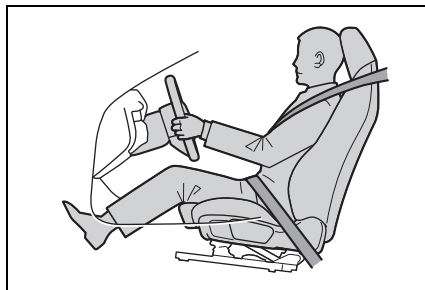

Having a correct driving posture is essential for safe driving.

Maintaining a correct driving posture not only helps reduce fatigue while driving, but helps ensure that the occupant protection devices, such as the seat belts and airbags, will operate correctly in a collision, reducing the impact to the occupants.

Correct use of the seat belts

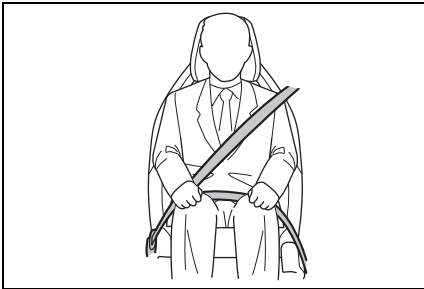

The most basic occupant protection device is the seat belt. The airbags are designed to supplement the seat belts, not be used in place of them. Wearing the seat belt correctly ensures that the occupants are securely held in the seats and helps prevent them from contacting interior parts or being thrown from the vehicle in a collision. Therefore, it is necessary for all occupants to wear their seat belt. If a seat belt is worn improperly, its effectiveness as an occupant protection device will be severely reduced. Pay attention to the following to ensure the correct driving posture and use of the seat belts.

Correct driving posture and use of the seat belts

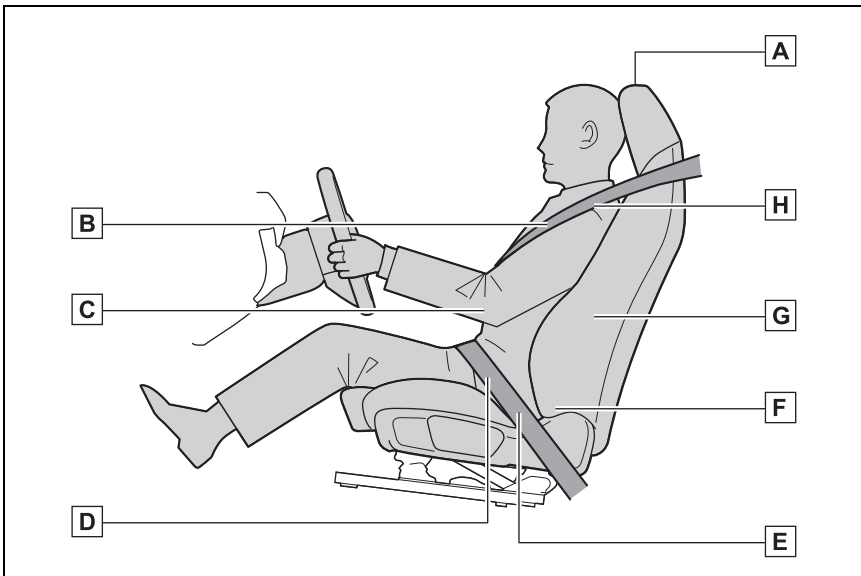

- A Position the head restraint so that the center of it is at the same height as the top of your ears
- B Make sure that the seat belt is not twisted
- C Adjust the seat so that your arms bend slightly at the elbow when gripping the upper part of the steering wheel
- D Make sure that the seat belt is snug and not loose at any point
- E Position the lap belt as low as possible over the hips
- F Sit well back in the seat with the seatback upright
- G Sit so your entire back is in contact with the seatback
- H Position the shoulder belt so that it does not contact your neck or slide off your shoulder

⚠ WARNING

Do not recline the seatback excessively while driving.



To reduce the risk of sliding under the lap belt during a collision, do not recline the seat more than necessary. If the seat is too reclined, the lap belt may slide past the hips and apply restraint forces directly to the abdomen, or your neck may contact the shoulder belt, increasing the risk of death or serious injury in the event of an accident. Adjustments should not be made while driving as the seat may unexpectedly move and cause the driver to lose control of the vehicle.

⚠ WARNING

Make sure that all passengers wear their seat belt correctly.

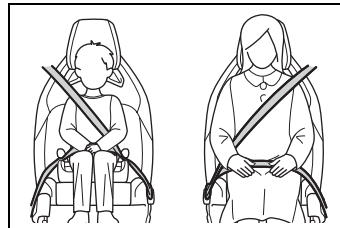
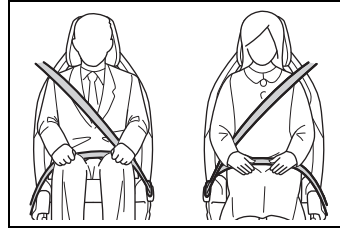

Use of seat belts may be mandatory under local laws and regulations. If a seat belt is not worn properly, an occupant may contact interior parts or be thrown from the vehicle in the case of sudden braking or a collision, possibly resulting in death or serious injury. Also, if an occupant has an incorrect riding posture, the airbags will be ineffectual as occupant protection devices and may actually cause injuries when they deploy.

⚠ WARNING

Correct use of the seat belts when pregnant:

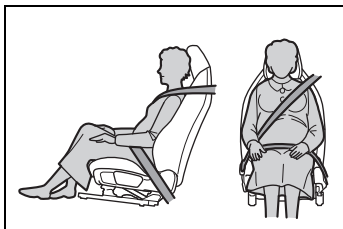

Pregnant women must wear a seat belt. Consult your physician for advice on correct way to wear a seat belt. Position the lap belt as low as possible over the hips and the shoulder belt completely over the shoulder, passing the center of the chest, so that the seat belt does not apply any pressure to the abdomen.

Buckling the safety belt

- 1 Guide the safety belt slowly over shoulder and hip to put it on.
- 2 Insert the tongue plate into the safety belt buckle. The safety belt buckle must engage audibly.

**Unbuckling the safety belt**

- 1 Hold the safety belt firmly.
- 2 Press the red button in the safety belt buckle.
- 3 Guide the safety belt back into its roll-up mechanism.

Safety belt warning for driver's seat and front passenger seat**General information**

The safety belt warning is issued when the driver's safety belt is not buckled.

The safety belt warning is also active when the front passenger seat belt is not buckled or objects are on the front passenger seat.

The safety belt warning is also activated when a passenger unbuckles a safety belt during the trip.

Display in the instrument cluster

The indicator light lights up and a signal sounds.

Make sure that the safety belts are positioned correctly. The safety belt warning can also be activated if objects are placed on the front passenger seat.

Front head restraints

Safety information

WARNING

Objects on the head restraint reduce the protective effect in the head and neck area. There is a risk of injury.

- Do not use seat or head restraint covers.
- Do not hang objects, for instance clothes hangers, directly on the head restraint.
- Only use accessories that have been determined to be safe for attachment to a head restraint.
- Do not use any accessories, for instance pillows, while driving.

Adjusting the height

The height of the head restraints cannot be adjusted.

Adjusting the distance

The distance to the back of the head is adjusted via the backrest tilt.

Adjust the distance so that the head restraint is as close as possible to the back of the head.

Removing

The head restraints cannot be removed.

Exterior mirrors

General information

The mirror on the front passenger side is more curved than the driver's side mirror.

The mirror setting is stored for the driver profile currently in use. When the vehicle is unlocked via the vehicle key, the position is automatically retrieved if the function, refer to page 69, is activated for this purpose.

The current exterior mirror position can be stored using the memory function, refer to page 112.

Safety information

WARNING

Objects in the mirror are closer than they appear. The distance to the road users behind could be incorrectly estimated, for instance while changing lanes. There is a risk of accident, injury, and property damage. Estimate the distance to the traffic behind by looking over your shoulder.

Overview



- 1 Adjusting
- 2 Selecting a mirror, Automatic Curb Monitor
- 3 Folding in and out

Adjusting the exterior mirrors

 Press the button.

The selected mirror moves along with the button movement.

Selecting a mirror

 To change over to the other mirror: Slide the switch.

Malfunction

In case of an electrical malfunction, adjust the mirror by pressing the edges of the mirror glass.

Folding in and out

NOTICE

Depending on the vehicle width, the vehicle can be damaged in vehicle washes. There is a risk of damage to property. Before washing, fold in the mirrors by hand or with the button.

 Press the button.

Folding is only possible up to a speed of approx. 15 mph/20 km/h.

Folding the mirrors in and out is helpful in the following situations:

- In vehicle washes.
- On narrow roads.

Mirrors that were folded in are folded out automatically at a speed of approx. 25 mph/40 km/h.

Automatic heating

Both exterior mirrors are automatically heated as needed and when the drive-ready state is switched on.

Automatic dimming feature

The exterior mirror on the driver's side is automatically dimmed. Photocells in the car's interior mirror, refer to page 111, are used to control this.

Automatic Curb Monitor, exterior mirror

Concept

If reverse gear is engaged, the mirror glass on the front passenger side is tilted downward. This improves your view of the curb and other low-lying obstacles when parking, for instance.

Activating

- 1  Slide the switch to the driver's side mirror position.
- 2 Engage selector lever position R.

Deactivating

Slide the switch to the passenger's side mirror position.

Interior mirror, automatic dimming feature

General information

The interior mirror is dimmed automatically.

Photocells are used for control:

- In the mirror glass.
- On the back of the mirror.

Overview

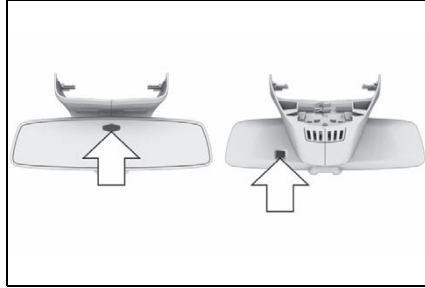

Functional requirements

- Keep the photocells clean.
- Do not cover the area between the interior mirror and the windshield.

Steering wheel

Safety information

WARNING

Steering wheel adjustments while driving can lead to unexpected steering wheel movements. There is a risk of accident, injury, and property damage. Adjust the steering wheel while the vehicle is stationary only.

Manual steering wheel adjustment

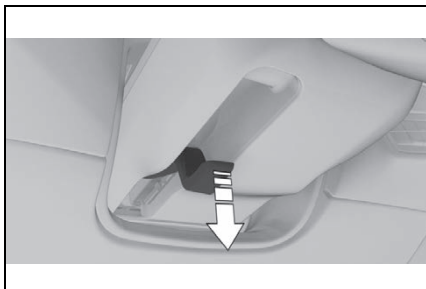

- 1 Fold the lever down completely.
- 2 Grip the steering wheel with both hands and move the steering wheel to the preferred height and angle to suit your seat position.
- 3 Fold the lever back up.

Memory function

Concept

The following settings can be stored and, if necessary, retrieved using the memory function:

- Seat position.
- Exterior mirror position.
- Height of the Head-up Display.

General information

Two memory locations with different settings can be set for each driver profile, refer to page 69.

The following settings are not stored:

- Backrest width.
- Lumbar support.

Safety information

! WARNING

Using the memory function while driving can lead to unexpected seat movements. There is a risk of accident, injury, and property damage. Only retrieve the memory function when the vehicle is stationary.

! WARNING

There is a risk of jamming when moving the seats. There is a risk of injury and risk of damage to property. Make sure that the area of movement of the seat is clear prior to any adjustment.

Overview

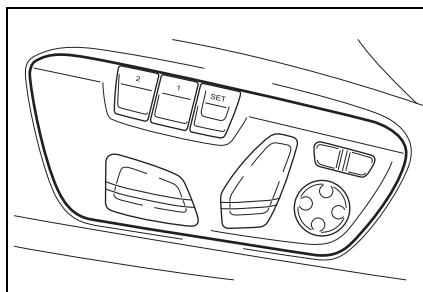

The memory buttons are located on the driver's seat.

Storing

- 1 Set the desired position.

- 2 **SET** Press the button. The writing on the button lights up.
- 3 Press desired button 1 or 2 while the LED is lit. A signal sounds.

Calling up settings

The stored position is called up automatically.
 Press the desired button 1 or 2.
 The stored position is called up.
 The procedure stops when a switch for setting the seat is pressed or one of the memory buttons is pressed again.
 While driving, the seat position adjustment on the driver's side is interrupted after a short time.

Seat heating*

*: if equipped

Overview

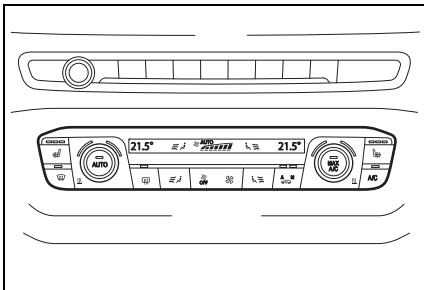

Switching on

Press the button once for each temperature level. The maximum temperature is reached when three LEDs are lit.

Switching off

Press and hold the button until the LEDs go out.

Transporting children safely

Vehicle features and options

This chapter describes all standard, country-specific and optional features offered with the series. It also describes features and functions that are not necessarily available in your vehicle, e.g., due to the selected options or country versions. This also applies to safety-related functions and systems. When using these functions and systems, the applicable laws and regulations must be observed.

When children are in the vehicle

WARNING

■ When a child is riding

Observe the following precautions. Failure to do so may result in death or serious injury.

For effective protection in automobile accidents and sudden stops, a child must be properly restrained, using a seat belt or child restraint system which is correctly installed. For installation details, refer to the operation manual enclosed with the child restraint system. General installation instruction is provided in this manual.

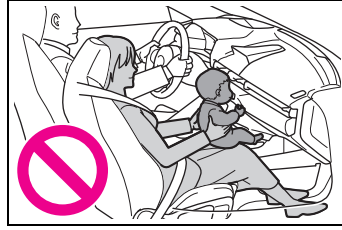

Do not allow occupants to ride with a child in their arms or on their lap. In the case of sudden braking or a collision, the child may hit their head on the instrument panel or windshield, or may even be thrown from the vehicle.



The seat belts are designed to protect persons of average adult height and weight. A child which is 5 ft, 150 cm or shorter should be sat in an appropriately sized child restraint system. Do not allow a child to be unrestrained in the vehicle while it is moving, as doing so is extremely dangerous.

**WARNING****■ When children are in the vehicle**

Never leave children unattended in the vehicle, and never allow children to have or use the key. Children may be able to start the vehicle or shift the vehicle into neutral. There is also a danger that children may injure themselves by playing with the windows or other features of the vehicle. In addition, heat build-up or extremely cold temperatures inside the vehicle can be fatal to children.

- When the vehicle is parked under direct sunlight, the temperature inside the vehicle can increase to over 122°F, even in winter. In this situation, occupants may suffer from dehydration or heatstroke.
- If a switch is operated accidentally, it may lead to unexpected injuries.
- Do not allow a child to open and close the doors. When closing a door, be careful so that the child's hands and feet do not get caught in the door.
- Do not allow a child to put their head or limbs out of the door window and be sure that they are clear of the window before operating the power window switch.

The right place for children**Safety information****WARNING**

Unattended children or animals in the vehicle can cause the vehicle to move and endanger themselves and traffic, for instance due to the following actions:

- Pressing the Start/Stop button.
- Releasing the parking brake.
- Opening and closing the doors or windows.
- Engaging selector lever position N.
- Using vehicle equipment.

There is a risk of accident, injury, and property damage. Do not leave children or animals unattended in the vehicle. Take the vehicle key with you when exiting and lock the vehicle.

**WARNING**

A heated vehicle may result in death to persons, especially children and animals. There is a risk of injuries and danger to life. Do not leave persons, especially children and animals unattended in the vehicle.

⚠ WARNING

Exposure to intense sunlight can cause child restraint systems and their components to become very hot. Persons may sustain burn injuries when touching the hot components. There is a risk of injury. Do not expose the child restraint system to direct sunlight or cover where necessary. If necessary, let the child restraint system cool down before transporting a child. Do not leave children unattended in the vehicle.

Children on the front passenger seat**General information**

Before using a child restraint system on the front passenger seat, ensure that the front, knee, and side airbags on the front passenger side are deactivated. For automatic deactivation of frontseat passenger airbags, refer to page 177.

Safety information**⚠ WARNING**

Active front-seat passenger airbags can injure a child in a child restraint system when the airbags are activated. There is a risk of injury. Make sure that the front-seat passenger airbags are deactivated and that the PASSENGER AIRBAG OFF indicator light lights up.

The safety belt cannot be fastened correctly on children shorter than 5 ft, 150 cm without suitable additional child restraint systems. The efficacy of safety gear, including safety belts, can be limited or lost when safety belts are fastened incorrectly. An incorrectly fastened safety belt can cause additional injuries, for instance in the event of an accident or during braking and evasive maneuvers. There is a risk of injuries and danger to life. Secure children shorter than 5 ft, 150 cm using suitable child restraint systems.

Installing child restraint systems**General information**

Pay attention to the specifications and the operating and safety information of the child restraint system manufacturer when selecting, installing, and using child restraint systems.

Safety information**⚠ WARNING**

The protective effect of child restraint systems and their fastening systems which have been damaged or exposed to an accident can be limited or lost. A child cannot be properly restrained in the event of an accident or braking and evasive maneuvers. There is a risk of injuries and danger to life. Do not use child restraint systems which have been damaged or exposed to an accident. If a child restraint system and its fastening system has been damaged or exposed to an accident, have these systems checked and replaced by your Toyota dealer.

⚠ WARNING

The stability of the child restraint system is limited or compromised with incorrect seat adjustment or improper installation of the child seat. There is a risk of injuries and danger to life. Make sure that the child restraint system fits securely against the backrest. If possible, adjust the backrest tilt for all affected backrests and correctly adjust the seats. Make sure that seats and backrests are securely engaged or locked.

On the front passenger seat**Deactivating airbags****⚠ WARNING**

Active front-seat passenger airbags can injure a child in a child restraint system when the airbags are activated. There is a risk of injury. Make sure that the front-seat passenger airbags are deactivated and that the PASSENGER AIRBAG OFF indicator light lights up.

Before installing a child restraint system in the front passenger seat, make sure that the front, knee and side airbags on the front passenger side are deactivated.

Deactivate the front-seat passenger airbags automatically, refer to page 177.

Seat position and height

After installing a child restraint system, move the front passenger seat as far back as it will go and, if possible, bring it up to medium height. This seat position and height ensure the best possible position for the belt and offers optimal protection in the event of an accident.

If the upper anchor of the safety belt is located in front of the belt guide of the child seat, move the front passenger seat carefully

forward until the best possible belt guide position is reached.

Backrest width

Adjustable backrest width: before installing a child restraint system in the front passenger seat, open the backrest width completely. Do not change the backrest width again and do not call up a memory position.

Child seat security

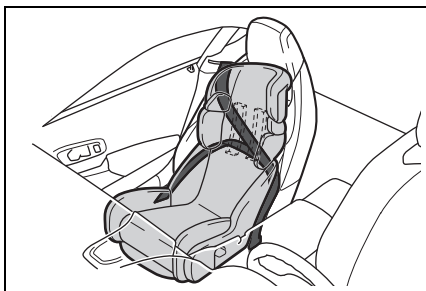

The safety belt on the passenger's side can be locked to fasten child restraint systems.

Locking the safety belt

- 1 Pull out the belt strap completely.
- 2 Secure the child restraint system with the safety belt.
- 3 Allow the belt strap to be pulled in and pull it tight against the child restraint system. The safety belt is locked.

Unlocking the safety belt

- 1 Unbuckle the safety belt buckle.
- 2 Remove the child restraint system.
- 3 Allow the belt strap to be pulled in completely.

Child restraint systems with tether strap

General information

When attaching child restraint systems to the upper attachment points, observe the specifications and the operating and safety information of the child restraint system manufacturer.

Safety information

WARNING

If the upper retaining strap is incorrectly used for the child restraint system, the protective effect can be reduced. There is a risk of injury. Make sure that the upper retaining strap is not guided across sharp edges and without twisting to the upper retaining strap.

⚠ WARNING

The attachment points for child restraint systems in the vehicle are intended for attaching child restraint systems only. When other objects are mounted, the anchors can be damaged. There is a risk of injury and risk of damage to property. Attach only child restraint systems at the corresponding attachment points.

Anchors

Symbol	Meaning
	<p>The respective symbol shows the anchor for the upper retaining strap. Seats with an upper top tether are marked with this symbol. It can be found on the rear seat backrest or the rear window shelf.</p>

Routing the retaining strap

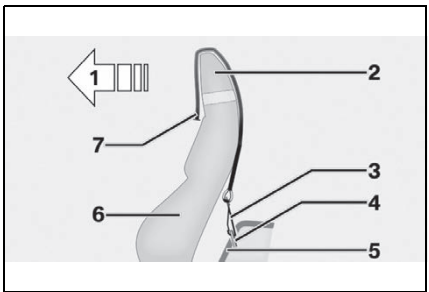

- 1 Direction of travel
- 2 Head restraint
- 3 Hook for the upper retaining strap
- 4 Mounting point/eyelet

- 5 Vehicle floor
- 6 Seat
- 7 Upper retaining strap

Attaching the upper retaining strap to the anchor

- 1 Open the anchor cover.
- 2 Guide the upper retaining strap over the head restraint to the anchor.
- 3 Attach the hook of the retaining strap to the anchor.
- 4 Tighten the retaining strap.

Driving

Vehicle features and options

This chapter describes all standard, country-specific and optional features offered with the series. It also describes features and functions that are not necessarily available in your vehicle, e.g., due to the selected options or country versions. This also applies to safety-related functions and systems. When using these functions and systems, the applicable laws and regulations must be observed.

Start/Stop button

Concept



Pressing the Start/Stop button switches drive-ready state on or off, refer to page 45.

Manual transmission: the drive-ready state is switched on when you depress the clutch pedal while pressing the Start/Stop button.

Automatic transmission: the drive-ready state is switched on when you depress the brake pedal while pressing the Start/Stop button.

Pressing the Start/Stop button again switches drive-ready state

back off and standby state, refer to page 45, is switched back on.

Driving away

- 1 Switch on drive-ready state.
- 2 Apply drive mode.
- 3 Release the parking brake.
- 4 Drive away.

Auto Start/Stop function

Concept

The Auto Start/Stop function helps save fuel. The system switches off the engine during a stop, for instance in traffic jam or at traffic lights. Drive-ready state remains switched on. The engine starts automatically for driving off.

General information

After each engine start using the Start/Stop button, the Auto Start/Stop function is ready. The function is activated from speeds of approx. 3 mph/5 km/h.

Depending on the selected driving mode, refer to page 138, the system is automatically activated or deactivated.

Engine stop

Functional requirements

Manual transmission

The engine is switched off automatically during a stop under the following conditions:

- Neutral is engaged and the clutch pedal is not pressed.
- The driver's safety belt is buckled or the driver's door is closed.

Automatic transmission

The engine is switched off automatically during a stop under the following conditions:

- The selector lever is in selector lever position D.
- The brake pedal remains pressed while the vehicle is stationary.
- The driver's safety belt is buckled or the driver's door is closed.

Manual engine stop

If the engine was not switched off automatically when the vehicle stopped, the engine can be switched off manually:

- Press the brake pedal forcefully again from the current pedal position.
- Engage selector lever position P.

If all functional preconditions are fulfilled, the engine switches off.

Air conditioner when the engine is switched off

The air flow from the air conditioner is reduced when the engine is switched off.

Displays in the instrument cluster

■ General information

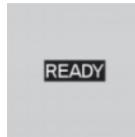

The display in the instrument cluster indicates that the Auto Start/Stop function is ready for automatically starting the engine.



The display indicates that the conditions for an automatic engine stop have not been met.

Functional limitations

The engine is not switched off automatically in the following situations:

- In case of a steep downhill grade.
- Brake not engaged strongly enough.
- The external temperature is high and automatic air conditioning is running.
- The car's interior has not yet been heated or cooled to the

required level.

- Where there is a risk of window condensation when the automatic air conditioning is switched on.
- Engine or other parts not at operating temperature.
- Engine cooling is required.
- The wheels are at a sharp angle or the steering wheel is being turned.
- Vehicle battery is heavily discharged.
- At higher elevations.
- The hood is unlocked.
- The parking assistant is activated.
- Stop-and-go traffic.
- Selector lever position in N or R.
- After driving in reverse.
- Use of fuel with high ethanol content.

Starting the engine

Functional requirements

Manual transmission

The engine starts automatically under the following preconditions:

- By releasing the clutch pedal.

Automatic transmission

The engine starts automatically

under the following preconditions:

- By releasing the brake pedal.

Driving off

After the engine starts, accelerate as usual.

Safety mode

After the engine switches off automatically, it will not start again automatically if any one of the following conditions are met:

- The driver's safety belt is unbuckled and the driver's door is open.
- The hood was unlocked.

Some indicator lights light up for a varied length of time.

The engine can only be started via the Start/Stop button.

System limits

Even if driving off was not intended, the deactivated engine starts up automatically in the following situations:

- Excessive warming of the car's interior when the air conditioning is switched on.
- Excessive cooling of the car's interior when the heating is switched on.
- Where there is a risk of window condensation when the

automatic air conditioning is switched on.

- The steering wheel is turned.
- Change from selector lever position D to N or R.
- Change from selector lever position P to N, D, or R.
- Vehicle battery is heavily discharged.
- Start of an oil level measurement.

Additional functions Auto Start/Stop

Depending on the vehicle equipment and country-specific version, the vehicle features a variety of sensors for assessing the traffic situation. The Auto Start/Stop function uses this information to adapt to various traffic situations in a proactive manner.

For instance, this applies to the following situations:

- If a situation is detected in which the stopping time is expected to be very short, the engine is not switched off automatically. A message appears on the Control Display, depending on the situation.
- If a situation is detected in which the vehicle needs to drive off immediately, the engine is started automati-

cally.

The function may be restricted if the navigation data is invalid, outdated or not available, for example.

Activating/deactivating the system manually

Concept

The engine is not automatically switched off.

The engine is started during an automatic engine stop.

Using the button

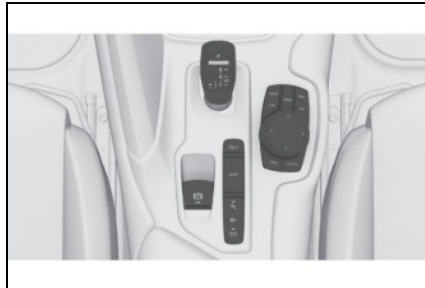

 Press the button.

Via selector lever position

The Auto Start/Stop function is also deactivated in selector lever position M.

Via the Sport mode switch

The Auto Start/Stop function is also deactivated in SPORT driving mode of the Sport mode

switch.

Switching off the vehicle during an automatic engine stop

■ General information

During an automatic engine stop, the vehicle can be switched off permanently, for instance when leaving it.

■ Manual transmission

- 1 Press the Start/Stop button.
 - Drive-ready state is switched off.
 - Standby state is switched on.
- 2 Shift into first gear or reverse.
- 3 Set the parking brake.

■ Automatic transmission

- 1 Press the Start/Stop button.
 - Drive-ready state is switched off.
 - Standby state is switched on.
 - Selector lever position P is engaged automatically.
- 2 Set the parking brake.

Automatic deactivation

General information

In certain situations, the Auto Start/Stop function is deactivated automatically for safety reasons, for instance if no driver is detected.

Malfunction

The Auto Start/Stop function no longer switches off the engine automatically. A vehicle message is displayed. It is possible to continue driving. Have the system checked by your Toyota dealer.

Parking brake

Concept

The parking brake is used to prevent the vehicle from rolling when it is parked.

Safety information

WARNING

An unsecured vehicle can begin to move and possibly roll away. There is a risk of accident, injury, and property damage. Before leaving the vehicle, secure the vehicle against rolling away.

In order to ensure that the vehicle is secured against rolling away, follow the following:

- Set the parking brake.
- Automatic transmission: Make sure that selector lever position P is engaged.
- Manual transmission: Make sure that first gear is engaged on uphill gradients and reverse gear on downhill gradients.
- On uphill grades or on a downhill slope, turn the front wheels in the direction of the curb.

⚠ WARNING

- On uphill grades or on a downhill slope, also secure the vehicle, for instance with a wheel chock.

⚠ WARNING

Unattended children or animals in the vehicle can cause the vehicle to move and endanger themselves and traffic, for instance due to the following actions:

- Pressing the Start/Stop button.
- Releasing the parking brake.
- Opening and closing the doors or windows.
- Engaging selector lever position N.
- Using vehicle equipment.

There is a risk of accident, injury, and property damage. Do not leave children or animals unattended in the vehicle. Take the vehicle key with you when exiting and lock the vehicle.



Overview



 Parking brake

Setting

With a stationary vehicle

-  Pull the switch.
-  The LED lights up.
-  The indicator light in the instrument cluster illuminates red. The parking brake is set.

While driving

■ **General information**

-  The indicator light in the instrument cluster illuminates red, a signal sounds, and the brake lights illuminate.

To use as emergency brake while driving:



Pull the switch and hold it. The vehicle brakes hard while the switch is being pulled.

A vehicle message is displayed.

If the vehicle is slowed down to a speed of approx. 2 mph/3 km/h the parking brake is set.

Releasing

Releasing manually

- 1 Switch on drive-ready state.
- 2  Manual transmission: press the switch while the brake pedal is pressed.
-  Automatic transmission:

press the switch while the brake is pressed or selector lever position P is set.

The LED and indicator light go out.
The parking brake is released.

Automatic release

The parking brake is released automatically when you drive away.

The LED and indicator light go out.

Malfunction

In the event of a failure or malfunction of the parking brake:

Secure the vehicle against rolling away, for instance with a wheel chock, after exiting the vehicle.

After a power failure

To reestablish parking brake functionality after a power failure:

- 1 Switch on standby state.
- 2  Pull the switch while stepping on the brake pedal or selector lever position P is set and then push.

This process may take a few seconds. Any sounds associated with this are normal.



The indicator light is no longer illuminated as soon as the parking brake is ready for operation again.

Turn signal

Turn signal in exterior mirror

When driving and during operation of the turn signals or hazard warning system, do not fold in the exterior mirrors, so that the signal lights on the exterior mirror are easy to see.

Using turn signals

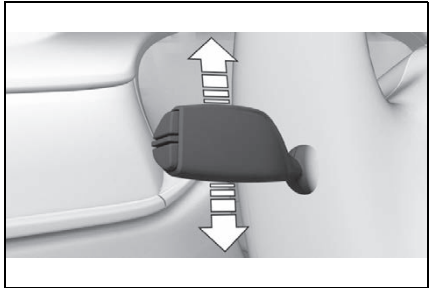

Press the lever past the resistance point.

Triple turn signal activation

Lightly tap the lever up or down.
The triple turn signal duration can be adjusted.

- Via Toyota Supra Command:
- 1 "My Vehicle"

- 2 "Vehicle settings"
- 3 "Exterior lighting"
- 4 "One-touch turn signal"
- 5 Select the desired setting.

Signaling briefly

Press the lever to the resistance point and hold it there for as long as you want the turn signal to flash.

High beams, headlight flasher

Push the lever forward or pull it backward.

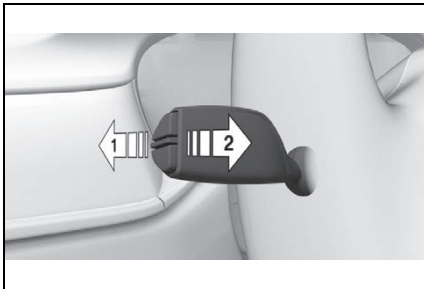

- 1** High beams on, arrow **1**.
The high beams light up when the low beams are switched on.
- 2** High beams off/headlight flasher, arrow **2**.

Washer/wiper system

General information

Do not use the wipers if the windshield is dry, as this may damage the wiper blades or

cause them to become worn more quickly.

The wipers can be operated in the standby state.

Safety information

! WARNING

If the wipers start moving in the folded away state, body parts can be jammed or damage may occur to parts of the vehicle. There is a risk of injury and risk of damage to property. Make sure that the vehicle is switched off when the wipers are in the folded away state and the wipers are folded in when switching on.

! NOTICE

The wiper blades can wear out or become damaged prematurely when wiping on a dry window for a longer period of time. The wiper motor can overheat. There is a risk of damage to property, among other potential damage. Do not use the wipers when the window is dry.

! NOTICE

If the wipers are frozen to the windshield, the wiper blades can be torn off and the wiper motor can overheat when switching on. There is a risk of damage to property, among other potential damage. Defrost the windshield prior to switching the wipers on.

Turn on window wiper system

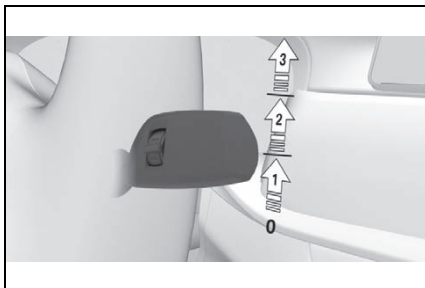

Press the lever up until the desired position is reached.

- Resting position of the wipers, position **0**.
- Rain sensor, position **1**.
- Normal wiper speed, position **2**.
- Fast wiper speed, position **3**.

When travel is interrupted with the wiper system switched on: when travel continues, the wipers resume at their previous speed.

Turn off the window wiper system and flick wipe

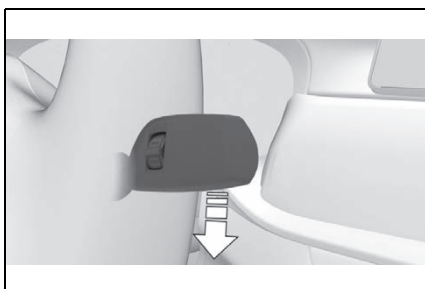

Press the lever down.

- Turn off: press the lever down

until it reaches the 0 position.

- Flick wipe: press the lever down from the 0 position.

The lever automatically returns to its 0 position when released.

Rain sensor

Concept

The rain sensor automatically controls the time between wipes depending on the intensity of the rainfall.

General information

The sensor is located on the windshield, directly in front of the interior mirror.

Safety information

 NOTICE

If the rain sensor is activated, the wipers can accidentally start moving in vehicle washes. There is a risk of damage to property. Deactivate the rain sensor in vehicle washes.

Activating

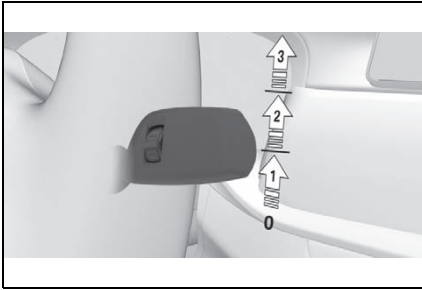

Press the lever up once from its standard position, arrow **1**.

Wiping is started.

The LED in the wiper lever is illuminated.

In frosty conditions, wiper operation may not start.

Deactivating

Press the lever back into the standard position.

Adjusting the rain sensor sensitivity

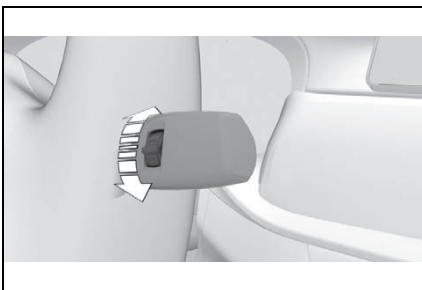

Turn the thumbwheel to adjust the sensitivity of the rain sensor.

Upward: high rain sensor sensitivity.

Downward: low rains sensor sensitivity.

Windshield washer system

Safety information

WARNING

The washer fluid can freeze onto the window at low temperatures and obstruct the view. There is a risk of accident, injury, and property damage. Only use the washer systems, if the washer fluid cannot freeze. Use anti-freeze if needed.

NOTICE

When the washer fluid reservoir is empty, the wash pump cannot work as intended. There is a risk of damage to property. Do not use the washer system when the washer fluid reservoir is empty.

Cleaning the windshield

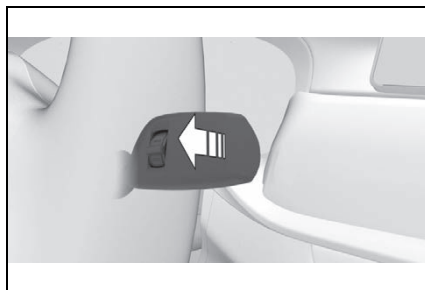

Pull the lever.

The system sprays washer fluid on the windshield and activates the wipers briefly.

Windshield washer nozzles

The windshield washer nozzles are automatically heated while standby state is switched on.

Fold-away position of the wipers

Principle

In the fold-out position, the wipers can be folded out from the windshield, which is important, for instance, when changing the wiper blades or for folding away under frosty conditions.

Safety information

WARNING

If the wipers start moving in the folded away state, body parts can be jammed or damage may occur to parts of the vehicle. There is a risk of injury and risk of damage to property. Make sure that the vehicle is switched off when the wipers are in the folded away state and the wipers are folded in when switching on.

NOTICE

If the wipers are frozen to the windshield, the wiper blades can be torn off and the wiper motor can overheat when switching on. There is a risk of damage to property. Defrost the windshield prior to switching the wipers on.

Folding away the wipers

- 1 Switch on standby state.
- 2 Move the wiper lever to the lowest position and hold it there until the wipers stop at a nearly vertical position.

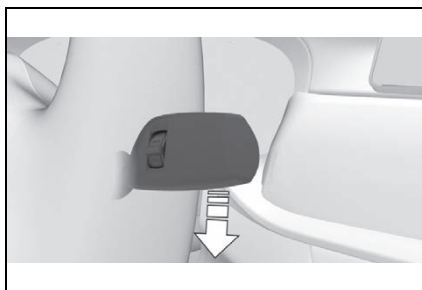

- 3 Fold the wipers all the way away from the windshield.

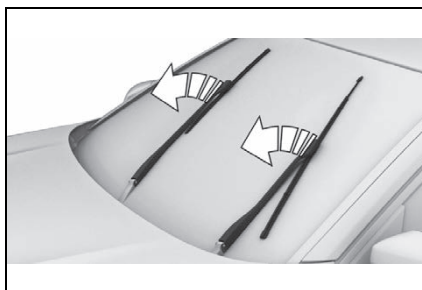

Folding down the wipers

After the wipers are folded back down, the wiper system must be reactivated.

- 1 Fold the wipers back down onto the windshield.
- 2 Switch on standby state and press and hold the wiper lever down again.

- 3 Wipers return to their resting position and are ready again for operation.

Manual transmission

Safety information

WARNING

An unsecured vehicle can begin to move and possibly roll away. There is a risk of accident, injury, and property damage. Before leaving the vehicle, secure the vehicle against rolling away.

In order to ensure that the vehicle is secured against rolling away, follow the following:

- Set the parking brake.
- Make sure that first gear is engaged on uphill gradients and reverse gear on downhill gradients.
- On uphill grades or on a downhill slope, turn the front wheels in the direction of the curb.
- On uphill grades or on a downhill slope, also secure the vehicle, for instance with a wheel chock.

NOTICE

When shifting to a lower gear, excessive RPM can damage the engine. There is a risk of damage to property, among other potential damage. When shifting into 5th or 6th gear, press the gearshift lever to the right.

Shift pattern

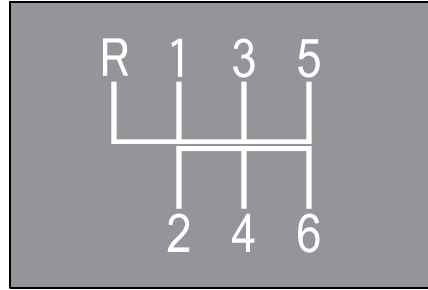

- 1–6: forward gears.
- R: reverse gear.

General information

Depending on the motorization, the RPM during a shifting operation is adjusted automatically as required for harmonious gear changing.

Reverse gear

Select only when the vehicle is stationary.

Rolling or pushing the vehicle

In some situations, the vehicle is to roll without its own power, for instance in a car wash, or be pushed.

- 1 Turn on standby state.
- 2 Press on the clutch pedal and shift out of a forward gear or reverse.
- 3 Release the parking brake.

Automatic transmission

Concept

The Automatic transmission combines the functions of manual shifting, if needed.

Safety information

WARNING

An unsecured vehicle can begin to move and possibly roll away. There is a risk of accident, injury, and property damage. Before leaving the vehicle, secure the vehicle against rolling away.

In order to ensure that the vehicle is secured against rolling away, follow the following:

- Set the parking brake.
- Make sure that selector lever position P is engaged.
- On uphill grades or on a downhill slope, turn the front wheels in the direction of the curb.
- On uphill grades or on a downhill slope, also secure the vehicle, for instance with a wheel chock.

Selector lever positions

Drive mode D

Selector lever position for normal vehicle operation. All gears for forward travel are activated automatically.

Reverse R

Engage selector lever position R only when the vehicle is stationary.

Neutral N

The vehicle may be pushed or roll without power, for instance in vehicle washes, refer to page 134, in selector lever position N.

Parking position P

Selector lever position, for instance for parking the vehicle. The transmission blocks the drive wheels in selector lever position P.

Engage selector lever position P only when the vehicle is stationary.

■ P is engaged automatically

Selector lever position P is engaged automatically in situations such as the following:

- After the drive-ready state is switched off and selector lever position R, D or M is engaged.
- After the standby state has been switched off when selector lever position N is engaged.
- The driver's seat belt is unbuckled and the driver's door is opened while the vehicle is stationary and selector

lever position D, M, or R is engaged.

Engaging selector lever positions

General information

To prevent the vehicle from creeping after you select a drive mode, maintain pressure on the brake pedal until you are ready to start.

In certain situations, e.g., to rock free on snow, it is possible to shift between reverse gear and gear position D without pressing the brake.

Functional requirements

Only when the drive-ready state is switched on and the brake pedal is depressed is it possible to change from selector lever position P to another selector lever position.

The selection lever position P cannot be changed until all technical requirements are met.

Engaging selector lever position D, N, R

A selector lever lock prevents the following faulty operation:

- Unintentional shifting into selector lever position R.
- Unintentional shifting from

selector lever position P into another selector lever position.

- 1 Fasten driver's safety belt.
- 2 Press and hold the button to release the selector lever lock.

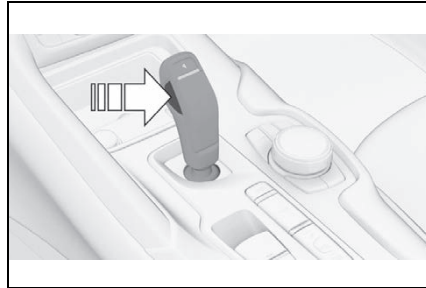

- 3 Push the selector lever in the desired direction, past a resistance point, if needed. The selector lever automatically returns to the center position when released.



Engaging selector lever position P

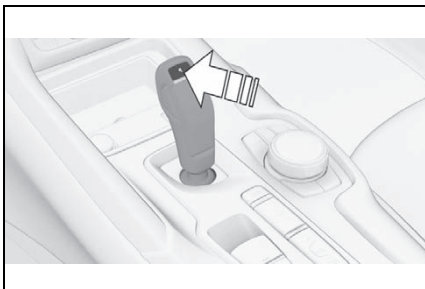

Press button P.

Rolling or pushing the vehicle

General information

In some situations, the vehicle is to roll without its own power for a short distance, for instance in a vehicle wash, or be pushed.

Engaging selector lever position N

 **NOTICE**

Selector lever position P is automatically engaged when standby state is switched off. The wheels are blocked. There is a risk of property damage. Do not switch off standby if the vehicle is meant to coast, e.g., in a car wash.

- 1** Switch on drive-ready state while pressing on the brake pedal.
- 2** If necessary, release the parking brake.

- 3** If necessary, loosen the belt.
- 4** If necessary, open the door.
- 5** Depress the brake pedal.
- 6** Touch the selector lever lock and engage selector lever position N.
- 7** Switch off drive-ready state.

In this way, standby state remains switched on, and a vehicle message is displayed.

The vehicle can roll.

 **NOTICE**

Selector lever position P is automatically engaged when standby state is switched off. There is a risk of damage to property. Do not switch standby state off in vehicle washes.

Irrespective of standby state, the selector lever position P is automatically engaged after approx. 35 minutes.

If there is a malfunction, you may not be able to change the selector lever position.

Electronically unlock the transmission lock, if needed, refer to page 136.

Kickdown

Kickdown is used to achieve maximum driving performance. Step on the accelerator pedal beyond the resistance point at the full throttle position.

Manual mode

Concept

Manual gear-shifting is possible in manual mode.

Activating manual mode



Press the selector lever to the left from selector lever position D.

The engaged gear is displayed in the instrument cluster, for instance 1M.

Shifting

- To shift down: press the selector lever forward.
- To shift up: pull the selector lever rearwards.

Ending the manual mode

Push the selector lever to the right.

D is displayed in the instrument cluster.

Shift paddles

Concept

The shift paddles on the steering wheel allow you to shift gears quickly while keeping both hands on the steering wheel.

General information

■ Shifting

The vehicle only shifts at suitable engine and road speeds.

■ Short-term manual mode

In selector lever position D, actuating a shift paddle switches into manual mode temporarily.

After conservative driving in manual mode without acceleration or shifting via the shift paddles for a certain amount of time, the transmission switches back to automatic mode.

It is possible to switch into automatic mode as follows:

- Pull and hold right shift paddle.
- In addition to the briefly pulled right shift paddle, briefly pull the left shift paddle.

■ Continuous manual mode

In selector lever position M, actuating a shift paddle switches into manual mode permanently.

Shifting

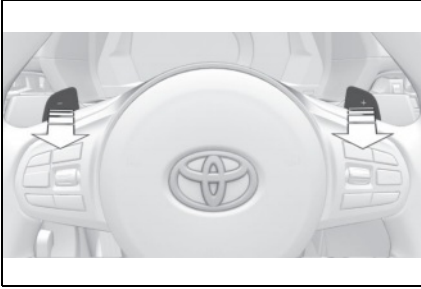

- Shifting up: pull the right shift paddle.
- Shifting down: pull left shift paddle.
- Downshifting to the lowest possible gear: keep the left shift paddle pulled.

The selected gear is briefly displayed in the instrument cluster, followed by the current gear.

Displays in the instrument cluster



The selector lever position is displayed, for example P.

Electronic unlocking of the transmission lock

General information

Electronically unlock the transmission lock to maneuver vehicle from a danger area.

Unlocking is possible, if the

starter can spin the engine.

Before unlocking the transmission lock, set the parking brake to prevent the vehicle from rolling away.

Engaging selector lever position N

- 1 Press and hold down brake pedal.
- 2 Press the Start/Stop button. The starter must audibly start. Hold the Start/Stop button pressed.
- 3 With your free hand, press the button on the selector lever, arrow 1, and press the selector lever into selector lever position N and hold, arrow N, until selector lever position N is displayed in the instrument cluster.

A vehicle message is displayed.



- 4 Release Start/Stop button and selector lever.
- 5 Release brake, as soon as the starter stops.

- 6 Maneuver the vehicle from the danger area and secure it against moving on its own.

For additional information, see the chapter on tow-starting and towing, refer to page 331.

Launch Control

Concept

Launch Control enables optimum acceleration on surfaces with good traction under dry surrounding conditions.

General information

The use of Launch Control causes premature component wear since this function represents a very heavy load for the vehicle.

Do not use Launch Control during the break-in, refer to page 262, period.

Do not steer the steering wheel when driving off with Launch Control.

Functional requirements

Launch Control is available when the engine is at operating temperature. The engine is at operating temperature after an uninterrupted trip of at least 6 miles/10 km.

Start with launch control

- 1 Switch on drive-ready state.
- 2 Press the sport button.

SPORT will be displayed on the instrument cluster, indicating sport mode has been selected.

- 3  Press the button.

TRACTION will be displayed on the instrument cluster and the VSC OFF indicator lamp will illuminate.

- 4 Select the D selector lever position.
- 5 Firmly depress the brake pedal with your left foot.
- 6 Fully depress and hold the accelerator pedal at the kick-down position.

A flag symbol will be shown in the instrument cluster.

- 7 The engine speed will be adjusted for launching. Release the brake pedal within 3 seconds.

Repeated use during a trip

After Launch Control has been used, the transmission must cool down for approx. 5 minutes before Launch Control can be used again. Launch Control adjusts to the surrounding conditions, when used again.

After using Launch Control

To increase vehicle stability, activate VSC Vehicle Stability

Control System again as soon as possible.

System limits

An experienced driver may be able to achieve better acceleration values in VSC OFF mode.

Sport mode button

Concept

The Sport mode button influences the driving dynamics properties of the vehicle.

General information

The following systems are affected, for instance:

- Engine characteristics.
- Automatic transmission.
- Adaptive variable suspension.
- Steering.
- Display in the instrument cluster.
- Cruise control.

Overview



Displays in the instrument cluster

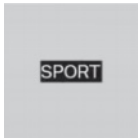

The selected driving mode is displayed in the instrument cluster.

Driving modes

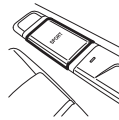

Button in the vehicle

Button	Driving mode	Configuration
SPORT	SPORT	Customize

When drive-ready state is switched on, the NORMAL driving mode is selected automatically.

Driving modes in detail

NORMAL

■ Concept

Balanced tuning between dynamic and efficient driving.

SPORT

■ Concept

Dynamic tuning for higher agility with an optimized chassis and suspension.

■ Switching on

 A rectangular button with the word "SPORT" in white capital letters on a dark background.

Press the button.

Customize

■ Concept

Customize settings can be adjusted in the customize driving mode.

■ Configuration

Via Toyota Supra Command:

- 1 "My Vehicle"
- 2 "Vehicle settings"
- 3 "Configure SPORT INDIVIDUAL"
- 4 Select the desired setting.

Reset Customize to the standard settings:

"Reset to SPORT STANDARD".

Displays

Vehicle features and options

This chapter describes all standard, country-specific and optional features offered with the series. It also describes features and functions that are not necessarily available in your vehicle, e.g., due to the selected options or country versions. This also applies to safety-related functions and systems. When using these functions and systems, the applicable laws and regulations must be observed.

Instrument cluster

Concept

The instrument cluster is a variable display. When the sport mode switch is used to change the driving mode, the instrument cluster displays change to match the driving mode.

General information

The display change in the instrument cluster can be deactivated via Toyota Supra Command.

Some of the displays in the instrument cluster may differ from the illustrations in this Owner's Manual.

Safety information

⚠ WARNING

If the driving information displays on the instrument cluster fail, e.g., the speedometer, do not use the vehicle. There is a risk of accident, injury, and property damage. Immediately park the vehicle in a safe manner. Turning drive-ready state off and on again may correct the malfunction, allowing you to continue driving. If the malfunction cannot be corrected, have the vehicle checked by your Toyota dealer.

Overview

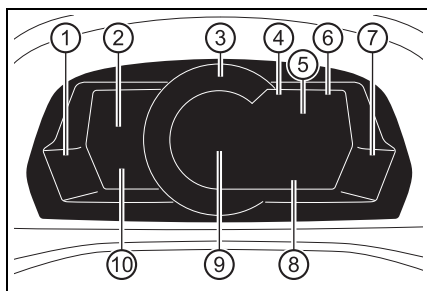

- 1 Fuel gauge P.147
- 2 Speedometer
- 3 Tachometer P.147
Status, Sport mode switch P.138
- 4 Time P.64
- 5 Variable displays P.140
- 6 External temperature P.149
- 7 Engine coolant temperature P.148
- 8 Vehicle messages P.140
Range P.149
- 9 Transmission display P.132
- 10 Variable displays P.140

Speed Limit Info P.206

Variable displays

In some areas of the instrument cluster, various assistance systems, for example the cruise control, can be displayed. The displays may vary depending on the equipment version and country variant.

Sport mode display

Concept

The display can be changed for sport mode.

Changing the display



Push the sport mode switch until SPORT is displayed.

The driving mode will change to sport mode.

Vehicle messages

Concept

The vehicle messages system monitors functions in the vehicle and notifies you of malfunctions in the monitored systems.

General information

A vehicle messages message is

displayed as a combination of indicator or warning lights and SMS text messages in the instrument cluster and, if applicable, in the Head-up Display.

In addition, an acoustic signal may sound and an SMS text message may appear on the Control Display.

Hiding vehicle messages

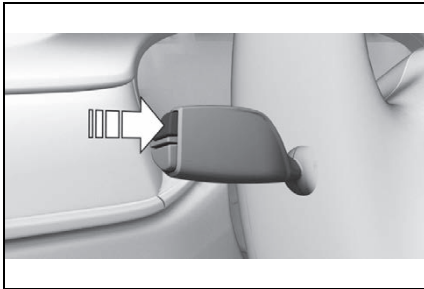

Press and hold the button on the turn signal lever.

Continuous display

Some vehicle messages are displayed continuously and are not cleared until the malfunction is eliminated. If several malfunctions occur at once, the messages are displayed consecutively.

The messages can be hidden for approx. 8 seconds. After this time, they are displayed again automatically.

Temporary display

Some vehicle messages are hidden automatically after approx. 20 seconds. The vehicle messages are stored and can be displayed again later.

Displaying stored vehicle messages

Via Toyota Supra Command:

- 1 "My vehicle"
- 2 "Vehicle status"
- 3  "Vehicle messages"
- 4 Select the SMS text message.

Display

Vehicle messages



At least one vehicle messages message is displayed or is stored.

SMS text messages

SMS text messages in combination with a symbol in the instrument cluster explain a vehicle message and the meaning of the indicator/warning lights.

Supplementary SMS text messages

Additional information, such as the reason for an error or mal-

function or the required action, can be called up via vehicle messages.

With urgent messages the added text will be automatically displayed on the Control Display.

Depending on the vehicle message, further help can be selected.

Via Toyota Supra Command:

- 1 "My vehicle"
- 2 "Vehicle status"
- 3  "Vehicle messages"
- 4 Select the desired text message.
- 5 Select desired setting

Messages after trip completion

Certain messages displayed while driving are displayed again after drive-ready state is switched off.

Indicator/warning lights

Concept

Indicator/warning lights in the instrument cluster display the status of some functions in the vehicle and indicate when a malfunction is present in the monitored systems.

General information

The indicator/warning lights can light up in a variety of combinations and colors.

Several of the lights are checked for proper functioning and light up temporarily when drive-ready state is switched on.

Red lights

Safety belt warning



Safety belt on the driver or passenger side is not buckled. The safety belt warning can also be activated if heavy objects are placed on the front passenger seat.

Make sure that the seat belts are positioned correctly.

Airbag system

Warning light illuminates briefly: Indicates that the entire airbag system and seat belt tensioners are operational when drive-ready state is switched on.

Warning light does not illuminate or illuminates continuously: the airbag system or the seat belt tensioners may not be operational. Have the vehicle checked immediately by your Toyota dealer.

Air bags, refer to page 166.



Brake system

The brake pads are worn or there is another issue with the brake system. The braking assistance may not be operational. A higher pedal force may be required for the braking process.

Have the vehicle checked immediately by your Toyota dealer.



BRAKE

General risk of collision

Warning light illuminates or flashes in conjunction with an acoustic signal if a collision is imminent.

Pre-Collision System (for pedestrians and bicycles), see page 185.



Parking brake

The parking brake is set.

For releasing the parking brake, refer to page 125.



Yellow lights

Anti-lock Braking System ABS



ABS

The system may not be operational. The Anti-lock Braking System is not available.

The ability to steer may be restricted during full braking.

Have checked immediately by your Toyota dealer.

Anti-lock Braking System ABS, refer to page 201.

VSC Vehicle Stability Control System is deactivated or Traction mode is activated



VSC is deactivated or Traction mode is activated.

VSC, refer to page 203, and Traction mode, refer to page 204.

VSC Vehicle Stability Control System

Warning light flashes: VSC is regulating the drive and brake power. The vehicle is stabilized. Reduce the vehicle speed and adjust your driving style to the road conditions.



Warning light illuminates: VSC has failed or is being initialized. Driving stability is restricted or has failed.

If the warning light illuminates continuously, have the vehicle checked immediately by your Toyota dealer.

VSC, refer to page 203.

Tire Pressure Monitor TPM

Warning light illuminates: Flat tire or tire pressure loss has been detected. Follow the information in the Check Control message.

Warning light flashes then illuminates continuously: Flat tires or tire pressure losses cannot be detected.

- Interference caused by systems or devices with the same radio frequency: after leaving the area of the interference, the system automatically becomes active again.
- A wheel without TPM wheel electronics is mounted: have it checked by your Toyota dealer as needed.
- Malfunction: have the system checked by your Toyota dealer.

Tire Pressure Monitor, refer to page 286.



Pollutant emissions

- The warning light illuminates:

Worsening exhaust emissions, e.g., due to an incorrectly fitted fuel cap.

- The warning light flashes under certain circumstances:

This indicates that there is excessive misfiring in the engine.

Reduce the vehicle speed and have the system checked immediately; otherwise, serious engine misfiring within a brief period can seriously damage emission control components, in particular the catalytic converter.

Have the vehicle checked by your Toyota dealer.

Diagnostic socket, refer to page 313.



Steering system

Steering system may not be working.

Have the system checked by your Toyota dealer.



Green lights

Turn signal

Turn signal switched on.



Unusually rapid flashing of the indicator light indicates that a turn signal bulb has failed.

Turn signal, refer to page 126.

Parking lights

Parking lights are switched on.



Parking lights/low beams, refer to page 160.

Low beams

Low beams are switched on.



Parking lights/low beams, refer to page 160.

Lane departure warning

Depending on vehicle equipment and national-market version:

The indicator light lights up: the system is switched on. A lane boundary has been detected on at least one side of the vehicle and the system is ready to intervene. Warnings will be issued.



Icon flashes green: the system is performing a steering intervention.

Lane departure warning, refer to page 189.

Automatic high-beam

Automatic high-beam is switched on.

High beams are switched on and off automatically depending on the traffic situation.



Automatic high-beam, refer to page 162.

Cruise Control

The system is active.

Additional information:



Driver assistance systems, Cruise Control, see page 208.

Dynamic radar cruise control switched on



The system is switched on.
 Additional information:
 Dynamic radar cruise control, see page 212.

Blue lights

High beams



High beams are switched on.
 High beams, refer to page 127.

Fuel gauge

Concept

The current fill level of the fuel tank is displayed.

General information

Vehicle tilt position may cause the display to vary.
 Information on refueling, refer to page 272.

Display



An arrow beside the fuel pump symbol shows which side of the vehicle the fuel filler is on.

Indicator light in the instrument cluster



The yellow indicator light illuminates, once the fuel reserve is reached.

Tachometer

Always avoid engine speeds in the red warning field. In this range, the fuel supply is reduced to protect the engine.

Shift lights

Concept

Depending on the vehicle equipment, the shift position indicators on the instrument cluster indicates the maximum shift point at which the best possible acceleration can be achieved.

General information

Depending on the equipment and nationalmarket version, the Shift lights are active in the sport mode of the Automatic transmission and with manual transmission.

Functional requirement

When the selected driving mode is sport mode, a shift light will be displayed.

Switching on shift lights

Automatic transmission:

- 1 Select SPORT using the sport mode switch.
- 2 Activate manual mode of the transmission.

Display



- Successive orange illuminated fields indicate the upcoming shift moment.
- The field lights up red. Do not wait any further to shift.

When the maximum speed is reached, the entire display flashes red and the supply of fuel is interrupted in order to protect the engine.

Standby state and drive-ready state

OFF

OFF is displayed in the instrument cluster. Drive-ready state is turned off and standby state turned on.

READY

READY is displayed in the instrument cluster. The Auto Start/Stop function is ready for automatic engine start.

For further information, see Idle state, standby state, and drive-ready state, refer to page 45.

Engine coolant temperature

Display

- When the engine temperature is low: Only the segments in the low temperature range will be illuminated. Drive with moderate engine speed and vehicle speed.
- When the engine temperature is normal: All segments to the middle temperature range will be illuminated.
- When the engine temperature is high: All segments to the high temperature range will be illuminated. A warning message will also be displayed.



To check the coolant level, refer to page 308.

Indicator light in the instrument cluster



A red indicator light is displayed.

External temperature

General information

If the indicator drops to +37°F/+3°C or lower, a signal sounds.

A vehicle message is displayed. There is an increased risk of ice on roads.

Safety information

WARNING

Even at temperatures above +37°F/+3°C there is a risk of icy roads, for instance on bridges or shady sections of the road. There is a risk of accident, injury, and property damage. Modify your driving style to the weather conditions at low temperatures.

Time

The time is displayed in the instrument cluster. Setting the time and time format, refer to page 64.

Range

Concept

The range indicates the distance that can still be covered with the current fuel level.

General information

The estimated range available with the remaining fuel is permanently displayed in the instrument cluster.

With a low remaining range, a vehicle message is briefly displayed. With a sporty driving style, for instance fast cornering, the engine function is not always ensured.

The vehicle message appears continuously below a range of approx. 30 miles/50 km.

Safety information

NOTICE

With a driving range of less than 30 miles/50 km the engine may no longer have sufficient fuel. Engine functions are not ensured anymore. There is a risk of damage to property. Refuel promptly.

Service notifications

Concept

The service requirement notifications indicate necessary

maintenance work.

General information

After turning on drive-ready state, the instrument cluster briefly displays the next service appointment or the distance remaining until the next recommended maintenance.

Display

Detailed information on service requirement notifications

More information may be displayed on the control display.



Via Toyota Supra Command:

- 1 "My vehicle"
- 2 "Vehicle status"
- 3  "Service required"

Maintenance work as well as possible legally mandated inspections are displayed.

- 4 Select an entry to call up detailed information.

Symbols

Symbols	Description
OK	No service is currently required.
	The time for recommended maintenance or a legally mandated inspection is approaching.
	The time for recommended maintenance has already passed.

Entering appointment dates

Enter the dates for the mandatory vehicle inspections.

Make sure that the vehicle's date and time are set correctly.

Via Toyota Supra Command:

- 1 "My vehicle"
- 2 "Vehicle status"
- 3  "Service required"
- 4 "Date:"
- 5 Select the desired setting.

Gear shift indicator

Concept

The gear shift indicator recommends the optimal gear for the current driving situation and supports an efficient driving style.

General information

Depending on the vehicle equipment and country version, the gear shift indicator is active in the manual mode of the automatic transmission and with manual transmission.

Manual transmission: displaying

Suggestions to shift gear up or down are displayed in the instrument cluster.

On vehicles without a gear shift indicator, the engaged gear is displayed.

Example	Description
	Efficient gear is set.
	Shift into efficient gear.

Automatic transmission: displaying

Suggestions to shift gear up or down are displayed in the instrument cluster.

On vehicles without a gear shift indicator, the engaged gear is displayed.

Example	Description
	Efficient gear is set.
	Shift into efficient gear.

Selection lists

Concept

The display can be operated when necessary.

- Entertainment source.
- Current audio source.
- List of most recent telephone calls.



If necessary, the corresponding menu will open on the Control Display.

Display

Items displayed may differ depending on the specifications of the vehicle.

Displaying and using the list

The lists can be displayed and operated using the buttons on the steering wheel.

Button	Function
	<p>Change the entertainment source.</p> <p>Pressing the button again will close the currently displayed list.</p>
	<p>Show list of most recent telephone calls.</p>
	<p>Turn the thumbwheel: select entertainment source or list entry.</p> <p>Press the thumbwheel to confirm the setting.</p> <p>The currently selected list can be displayed again in the instrument cluster by turning the thumbwheel.</p>

Onboard Computer in the instrument cluster

Concept

The Onboard Computer displays different vehicle data in the instrument cluster, such as average values.

Calling up information

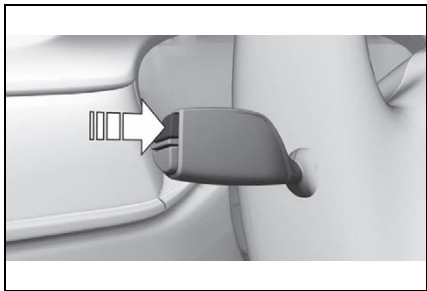

Press and hold the button on the turn signal lever.

Information is displayed in the instrument cluster. Pressing the button repeatedly displays additional information.

Information at a glance

The following information can be displayed on the Onboard Computer:

- Miles and trip miles.
- Current drivable range.
- Consumption display.
- Average consumption and average speed.
- Average consumption since leaving the factory.

Adjusting information for Onboard Computer

For some information of the Onboard Computer, it is possible to set whether it can be called up in the instrument cluster.

Via Toyota Supra Command:

- 1 "My vehicle"
- 2 "System settings"
- 3 "Displays"
- 4 "Instrument panel"
- 5 "Onboard info"
- 6 Select the desired setting.

Information in detail

Odometer and trip odometer

■ **Displaying/resetting miles**

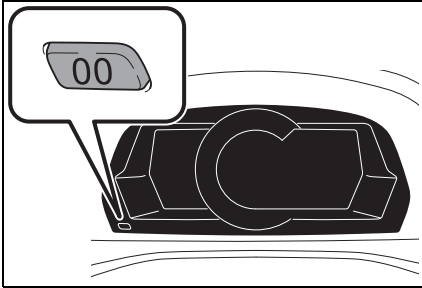

- Press the knob to display the trip miles.

When the drive-ready state is switched off, miles and trip miles are displayed.

- Keep the knob pressed down to reset the trip miles.

■ **Display**

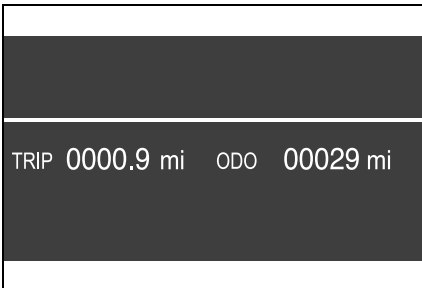

Current drivable range

■ **Concept**

The range indicates the distance that can still be covered with the current fuel level.

■ **General information**

The estimated range available

with the remaining fuel is permanently displayed in the instrument cluster.

With a low remaining range, a vehicle message is briefly displayed. With a sporty driving style, for instance taking curves aggressively, the engine function is not always ensured.

The vehicle message appears continuously below a range of approx. 30 miles/50 km.

■ **Safety information**

 **NOTICE**

With a driving range of less than 30 miles/50 km the engine may no longer have sufficient fuel. Engine functions are not ensured anymore. There is a risk of damage to property. Refuel promptly.

■ **Display**

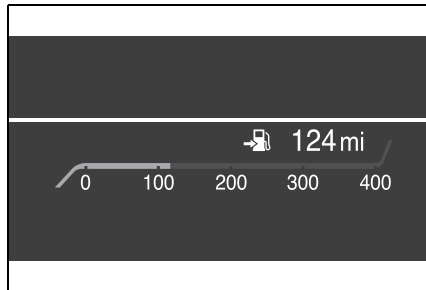

Consumption display

■ **Concept**

The current consumption displays the current consumption of fuel. Check whether you are currently driving in an efficient and environmentally friendly

manner.

■ **General information**

The current fuel consumption is displayed on the instrument cluster as a bar display.

■ **Display**

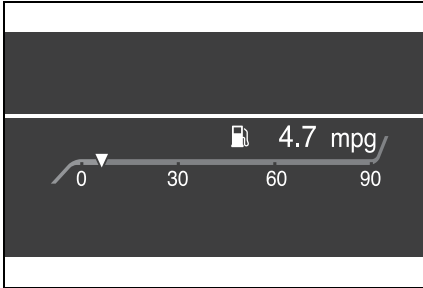

Average speed and average consumption

■ **General information**

Average speed and average consumption are calculated for the distance traveled since the last reset in the Onboard Computer.

Periods in which the vehicle is parked with the engine manually stopped are not included in the calculation of the average speed.

■ **Resetting average values**

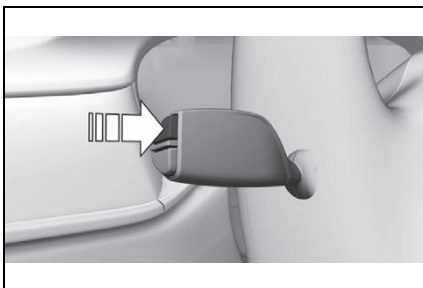

Press and hold the button on the turn signal lever.

■ **Display**

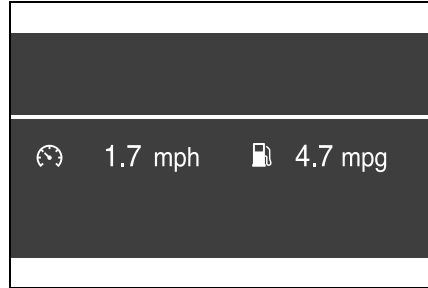

Onboard Computer on the Control Display

Concept

The Onboard Computer displays different vehicle data on the Control Display, such as average values.

General information

Two types of Onboard Computer are available on the Control Display:

- "Onboard info": average values, such as the consumption, are displayed. The values can be reset individually.
- "Trip computer": the values deliver an overview of a certain distance and can be reset as often as necessary.

Calling up the Onboard Computer or trip computer

Via Toyota Supra Command:

- 1 "My Vehicle"
- 2 "Driving information"
- 3 "Onboard info" or "Trip computer"



Resetting the Onboard computer

Via Toyota Supra Command:

- 1 "My Vehicle"
- 2 "Driving information"
- 3 "Onboard info"
- 4 "Consumption" or "Speed"
- 5 "OK"

Resetting the trip computer

Via Toyota Supra Command:

- 1 "My Vehicle"
- 2 "Driving information"
- 3 "Trip computer"
- 4 Move the Controller to the left, if needed.
 -  "Reset": all values are reset.
 -  "Automatic reset": all values are reset approx. 4 hours after the vehicle has come to a standstill.
- 5 If necessary, "OK"

Sport displays

Concept

Depending on the vehicle specifications, the current power output and torque can be displayed on the control display.

Display on the Control Display

Overview

The following information is displayed:

- Torque.
- Power.

Displays

Via Toyota Supra Command:

- 1 "My vehicle"
- 2 "Sport displays"

Speed warning

Concept

A speed limit can be set that when reached will cause a warning to be issued.

General information

The warning is repeated if the vehicle speed exceeds the set speed limit again, after it has dropped below it by 3 mph/5

km/h.

Configuring the speed limit warning

Via Toyota Supra Command:

- 1 "My Vehicle"
- 2 "Vehicle settings"
- 3 "Speed warning"
- 4 "Warning at:"
- 5 Turn the Controller until the desired speed is displayed.
- 6 Press the Controller.

Activating/deactivating the speed warning

Via Toyota Supra Command:

- 1 "My Vehicle"
- 2 "Vehicle settings"
- 3 "Speed warning"
- 4 "Speed warning"

Setting your current speed as the speed warning

Via Toyota Supra Command:

- 1 "My Vehicle"
- 2 "Vehicle settings"
- 3 "Speed warning"
- 4 "Select current speed"

Vehicle status

General information

The status can be displayed and





actions performed for several systems.

Opening the vehicle status

Via Toyota Supra Command:

- 1 "My vehicle"
- 2 "Vehicle status"

Information at a glance

-  "Tire Pressure Monitor": Status of the Tire Pressure Monitor, refer to page 286.
-  "Engine oil level": Electronic engine oil level check, refer to page 305.
-  "Vehicle messages": Vehicle messages are stored in the background and can be displayed on the Control Display. Displaying stored vehicle messages, refer to page 141.
-  "Service required": Displaying service notifications, refer to page 149.
-  "Remote maintenance Call": service request.

Head-up Display*

*: if equipped

Concept

This system projects important information into the driver's field of vision, for instance the speed.

The driver can get information without averting his or her eyes from the road.

General information

Follow the information on cleaning the Head-up Display, refer to page 342.

Overview



Switching on/off

Via Toyota Supra Command:

- 1 "My vehicle"
- 2 "System settings"
- 3 "Displays"
- 4 "Head-up display"
- 5 "Head-up display"

Display

Overview

The following information is displayed on the Head-up Display:

- Speed.
- Navigation instructions.

- Vehicle messages.
- Selection list in the instrument cluster.
- Driver assistance systems.

Some of this information is only displayed briefly as needed.

Selecting the view

Various views are available for the Head-up Display.

Via Toyota Supra Command:

- 1 "My vehicle"
- 2 "System settings"
- 3 "Displays"
- 4 "Head-up display"
- 5 Select the desired setting.

Setting the brightness

The brightness adapts automatically to the ambient brightness.

The basic setting can be adjusted manually.

Via Toyota Supra Command:

- 1 "My vehicle"
- 2 "System settings"
- 3 "Displays"
- 4 "Head-up display"
- 5 "Brightness"
- 6 Turn the Controller until the desired brightness is set.
- 7 Press the Controller.

When the low beams are switched on, the brightness of

the Head-up Display can be additionally influenced using the instrument lighting.

Adjusting the height

Via Toyota Supra Command:

- 1 "My vehicle"
- 2 "System settings"
- 3 "Displays"
- 4 "Head-up display"
- 5 "Height"
- 6 Turn the Controller until the desired height is reached.
- 7 Press the Controller.

The height of the Head-up Display can also be stored using the memory function, refer to page 112.

Setting the rotation

The Head-up Display view can be rotated.

Via Toyota Supra Command:

- 1 "My vehicle"
- 2 "System settings"
- 3 "Displays"
- 4 "Head-up display"
- 5 "Rotation"
- 6 Turn the Controller until the desired setting is selected.
- 7 Press the Controller.

Visibility of the display

The visibility of the displays in the Head-up Display is influenced by the following factors:

- Seat position.
- Objects on the protective glass of the Head-up Display.
- Dust or dirt on the protective glass of the Head-up Display.
- Windshield dirty on inside or outside.
- Sunglasses with certain polarization filters.
- Wet roads.
- Unfavorable light conditions.

If the image is distorted, have the basic settings checked by your Toyota dealer.

Special windshield

The windshield is part of the system.

The shape of the windshield makes it possible to display a precise image.

A film in the windshield prevents double images from being generated.

For this reason, it is strongly suggested to have the special windshield replaced by your Toyota dealer if necessary.

Lights

Vehicle features and options

This chapter describes all standard, country-specific and optional features offered with the series. It also describes features and functions that are not necessarily available in your vehicle, e.g., due to the selected options or country versions. This also applies to safety-related functions and systems. When using these functions and systems, the applicable laws and regulations must be observed.

Lights and lighting

Switches in the vehicle



The light switch element is located next to the steering wheel.

Symbol	Function
OFF	Lights off. Daytime running lights.
	Parking lights.
AUTO	Automatic headlight control. Adaptive light functions.
	Low beams.
	Instrument lighting.
	Right roadside parking light.
	Left roadside parking light.

3

CONTROLS

Automatic headlight control

Concept

The low beams are switched on and off automatically depending on the ambient brightness, for instance in tunnels, in twilight or if there is precipitation.

General information

A blue sky with the sun low on the horizon can cause the lights

to be switched on.

If the low beams are switched on manually, the automatic headlight control is deactivated.

Activating



Press the button on the light switch element.

The LED in the button lights up.



The indicator light in the instrument cluster is illuminated when the low beams are switched on.

System limits

The automatic headlight control cannot serve as a substitute for your personal judgment of lighting conditions.

For example, the sensors are unable to detect fog or hazy weather. In these situations, switch the light on manually.

Parking lights, low beams and roadside parking lights

General information

If the driver's door is opened when the drive-ready state is switched off, the exterior lighting is automatically switched off after a period of time.

Parking lights

General information

The parking lights can only be switched on in the low speed range.

Switching on



Press the button on the light switch element.



The indicator light in the instrument cluster lights up.

The vehicle is illuminated on all sides.

Do not use the parking lights for extended periods; otherwise, they might drain the battery and it would then be impossible to switch on drive-ready state.

Switching off



Press the button on the light switch element or switch on the drive-ready state.

After the drive-ready state is switched on, the automatic headlight control will be activated.

Low beams

Switching on



Press the button on the light switch element.

The low beams illuminate when drive-ready state is switched on.



The indicator light in the instrument cluster lights up.

Press the button again to switch on the low beams when the standby state is switched on.

Switching off

Depending on the country variant, the low beams can be switched off in the low speed range.

Depending on the surrounding conditions, the low beam headlights may not be able to be turned off.



Press the button on the light switch element.

Roadside parking lights

When the vehicle is parked, a one-sided roadside parking light can be switched on.

Button	Function
--------	----------



Right roadside parking light on/off.



Left roadside parking light on/off.

Switching off the roadside parking light:



Press the button on the light switch element or switch on the drive-ready state.

Welcome lights and headlight courtesy delay feature

Welcome lights

General information

Depending on the equipment, the exterior lighting of the vehicle can be set individually.

Activating/deactivating

Via Toyota Supra Command:

- 1 "My Vehicle"
- 2 "Vehicle settings"
- 3 "Exterior lighting"
- 4 Select desired setting:
 - "Welcome lights"

Individual light functions are switched on for a limited time.

Headlight courtesy delay feature

General information

The low beams stay illuminated for a particular time if the high beams are switched on after the drive-ready state is switched off.

Setting the duration

Via Toyota Supra Command:

- 1 "My Vehicle"
- 2 "Vehicle settings"
- 3 "Exterior lighting"
- 4 "Pathway lighting"
- 5 Select the desired setting.

Daytime running lights

General information

The daytime running lights light up when drive-ready state is switched on.

Activating/deactivating

In some countries, daytime running lights are mandatory, so it may not be possible to deactivate the daytime running lights.

Via Toyota Supra Command:

- 1 "My Vehicle"
- 2 "Vehicle settings"
- 3 "Exterior lighting"

4 "Daytime running lamps"

Automatic high-beam

Concept

The Automatic high-beam detects other traffic participants early on and automatically switches the high beams on or off depending on the traffic situation.

General information

The Automatic high-beam ensures that the high beams are switched on, whenever the traffic situation allows. In the low speed range, the high beams are not switched on by the system.

The system responds to light from oncoming traffic and traffic driving ahead of you, and to ambient lighting, for instance in towns and cities.

The high beams can be switched on and off manually at any time.

Activating

- 1 **AUTO** Press the button on the light switch element.

The LED in the button lights up.

2 Press and hold the button on the turn signal lever.

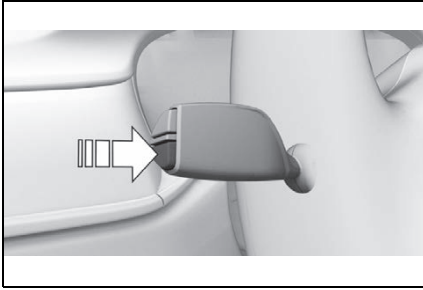

The indicator light in the instrument cluster is illuminated when the low beams are switched on.



The headlights are automatically switched between low beams and high beams.

The blue indicator light in the instrument cluster lights up when the system switches on the high beams.



Driving interruption with activated Automatic high-beam: the Automatic high-beam remains activated when driving continues.

The Automatic high-beam is deactivated when manually switching the high beams on and off, refer to page 127.

To reactivate the Automatic high-beam, press the button on the turn signal lever.

Deactivate Automatic High Beam Assistant

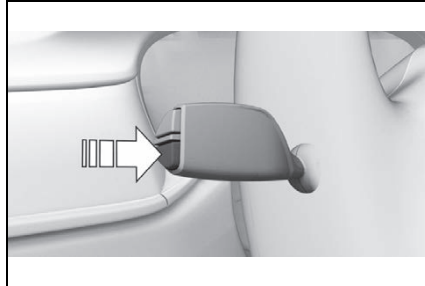

Press and hold the button on the turn signal lever.

Sensitivity of the Automatic High Beam Assistant

General information

The sensitivity of the Automatic High Beam Assistant can be adjusted.

⚠ WARNING

If adjustments have been made or the sensitivity has been modified, oncoming traffic may be momentarily blinded. There is a risk of accident, injury, or property damage. If adjustments have been made and the sensitivity has been modified, make sure that oncoming traffic is not momentarily blinded. Switch off the high-beam headlights manually if required.

Functional requirements

- Setting at standstill only.
- Drive readiness is switched on.

- Light is turned off.

Increase sensitivity

Push the turn signal lever to the front for approximately 10 seconds.

A Check Control message is displayed. The system responds more sensitively.

Resetting the sensitivity

Push the turn signal lever to the front again for approx. 10 seconds or switch off the drive-ready state.

The sensitivity of the Automatic High Beam Assistant is reset to the factory settings.

System limits

The Automatic High Beam Assistant cannot replace the driver's personal judgment of when to use the high beams. In situation that require this, therefore dimming manually.

The system is not fully functional in the following situations, and driver intervention may be necessary:

- In very unfavorable weather conditions, such as fog or heavy precipitation.
- When detecting poorly-lit road users such as pedestrians, cyclists, horseback riders and

wagons; when driving close to train or ship traffic; or at animal crossings.

- In tight curves, on hilltops or in depressions, in crossing traffic or half-observed oncoming traffic on highways.
- In poorly-lit towns and cities or in the presence of highly reflective signs.
- When the windshield in front of the interior mirror is fogged over, dirty or covered with stickers, etc.

Instrument lighting

Functional requirement

The parking lights or low beams must be switched on to adjust the brightness.

Settings



Adjust the brightness with the thumbwheel.

Interior lights

General information

Depending on the equipment version, interior lights, footwell lights and door entry lighting are automatically controlled.

Overview**Buttons in the vehicle**

Interior lights



Reading lights

Switching the interior lights on/off

Press the button.

To switch off permanently: press the button and hold for approx. 3 seconds.

Switching the reading lights on/off

Press the button.

Safety**Vehicle features and options**

This chapter describes all standard, country-specific and optional features offered with the series. It also describes features and functions that are not necessarily available in your vehicle, e.g., due to the selected options or country versions. This also applies to safety-related functions and systems. When using these functions and systems, the applicable laws and regulations must be observed.

Airbags

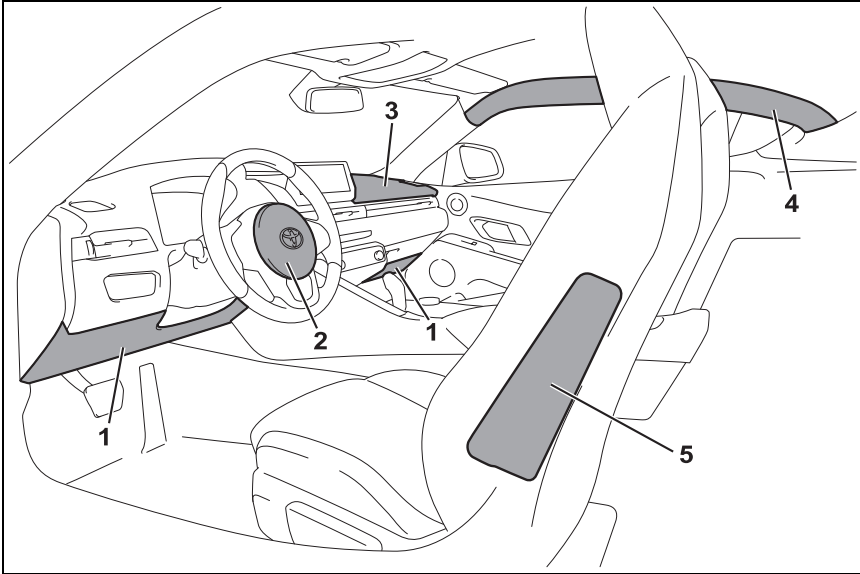

- 1 Knee airbag
- 2 Front airbag, driver
- 3 Front airbag, front passenger
- 4 Curtain shield airbag
- 5 Side airbag

Front airbags

Front airbags help protect the driver and the front passenger by responding to frontal impacts in which safety belts alone would not provide adequate protection.

Side airbag

In the event of a side impact, the side airbag protects the side of the body in the chest, lap, and head area.

Knee airbag

The knee airbag protects the legs in the event of a frontal impact.

Curtain shield airbag

The curtain shield airbag supports the head in the event of a side-on crash.

Protective effect**General information**

Airbags are not triggered in every impact situation, for instance in less severe accidents.

Information on optimum effect of the airbags**⚠ WARNING**

If the seat position is incorrect, the seat belts are fastened incorrectly or the deployment area of the airbags is impaired, the airbag system cannot provide protection as intended and may cause additional injuries due to deployment. There is a risk of injury and danger to life. Follow the information on achieving the optimum protective effect of the airbag system.

- Keep a distance from the airbags.
- Fasten the seat belts correctly.
- Always grasp the steering wheel on the steering wheel rim. Hold your hands at the 3 o'clock and 9 o'clock positions, to keep the risk of injury to your hands or arms as low as possible when the airbag is triggered.
- Adjust seat and steering wheel so that hands can be crossed over the steering wheel. Select the settings so that when reaching over the steering wheel the shoulders rest against the backrest and the upper body is as far away as possible from the steering wheel.
- Make sure that the front passenger is sitting correctly, i.e., keeps his or her feet and legs in the floor area and does not support them on the dashboard.
- Make sure that occupants keep their heads away from the side airbag.
- There should be no additional persons, animals or objects between an airbag and a person.
- Dashboard and windshield on the front passenger side must stay clear - do not attach adhesive labels or coverings and do not attach brackets or cables, for instance for GPS devices or mobile phones.
- Do not apply adhesive materials to the airbag cover panels, do not cover them or modify them in any way.
- Do not use the cover of the front airbag on the front passenger side as a storage area.
- Keep storage compartments near the airbags closed, e.g., glove compartment.
- Do not attach slip covers, seat

cushions or other objects to the front passenger seat that are not specifically suited for seats with integrated side airbags.

- Do not hang pieces of clothing, such as jackets, over the backrests.
- Never modify either the individual components or the wiring in the airbag system. This also applies to steering wheel covers, the dashboard, and the seats.
- Do not attach any objects to the steering wheel, e.g., mobile phone holders or trim elements.
- Do not remove the airbag system.

Even when you follow all instructions very closely, injury from contact with the airbags cannot be fully ruled out in certain situations.

The ignition and inflation noise may lead to short-term and, in most cases, temporary hearing impairment in sensitive occupants.

Vehicle modifications for a person with disabilities may affect the air bag system; contact the Toyota dealer for further information.

Warnings and information on the airbags are also found on the sun visors.

Functional readiness of the airbag system

Safety information

WARNING

Individual components can be hot after triggering of the airbag system. There is a risk of injury. Do not touch individual components.

WARNING

Improperly executed work can lead to failure, malfunction or unintentional triggering of the airbag system. In the case of a malfunction, the airbag system might not trigger as intended despite the accident severity. There is a risk of injuries and danger to life. Have the airbag system checked, repaired, dismantled and scrapped by your Toyota dealer.

Display in the instrument cluster



When drive-ready state is switched on, the warning light in the instrument cluster lights up briefly and thereby indicates the function readiness of the entire airbag system and the belt tensioners.

Malfunction



- Warning light does not come on when drive-ready state is switched on.
- The warning light lights up continuously.

The airbag system or the seat belt tensioners may be not operational. Have the vehicle checked immediately by your Toyota dealer.

Setting the front seat positions

The power that deploys the driver's/front passenger airbags depends on the position of the driver's/front passenger seat.

To maintain the accuracy of this function, calibrate the electrical front seats as soon as a respective message appears on the control display.

For further information: Electrically adjustable seats, see page 102.

SRS front airbag/SRS knee airbag

The airbags are not designed to be used in place of the seat belts.

The SRS front airbags and SRS knee airbags are designed to supplement the seat belts, not be used in place of them, to increase their effectiveness as an occupant protection device.

SRS is an acronym for Supplemental Restraint System

In the event of a collision, the seat belts restrain the occupants in their seats, but if the impact of

the collision is especially severe, there is danger of an occupant's head and chest contacting the steering wheel, dashboard and windshield. In this case, the SRS front airbags and SRS knee airbags deploy (inflate), instantly creating an air cushion to help reduce the impact on the occupants and restrain them from contacting the steering wheel, etc. with their head, chest and knees.

The SRS front air bags and SRS knee airbags deploy only when an impact exceeding a certain threshold is detected. In a collision, even if the impact is severe enough to cause the vehicle body to deform, the SRS airbags may not deploy if the impact of the collision is sufficiently dispersed by the crash structures of the vehicle body. If the force of the collision does not cause the airbags to deploy, the seatbelts will protect the occupants.

When an airbag deploys, as it will inflate nearly instantly, it may impact an occupant and cause an injury, or the loud noise emitted by ignition or deployment may cause temporary partial loss of hearing. Also, as an airbag and nearby parts will be extremely hot after the airbag deploys, touching them may cause burns. For these reasons,

deployment of the airbags is not entirely risk free. Therefore, in order to reduce this risk, the airbags are designed to only deploy when additional reduction of the impact applied to the occupants in a collision is necessary.

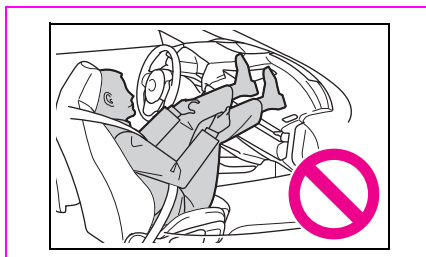

⚠ WARNING

Wear the seatbelt correctly and sit with the correct posture.

If you sit with your head too close to the steering wheel, when the SRS front airbag deploys, it may apply a very large impact to your body. Sit in the driver's seat with the correct posture and keep an appropriate distance away from the steering wheel.

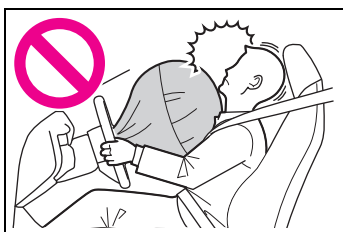
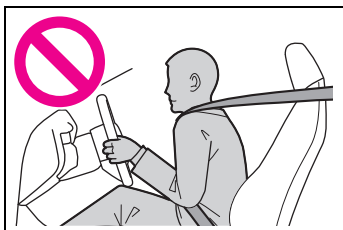

Do not position the passenger's seat too close to the dashboard or rest your feet on the dashboard, as doing so may lead to a serious injury if the SRS airbags deploy. Sit in the passenger's seat with the correct posture and keep an appropriate distance away from the dashboard.

⚠ WARNING

Do not attach anything to or lean anything against areas near the SRS airbags.

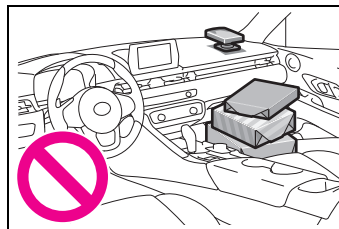
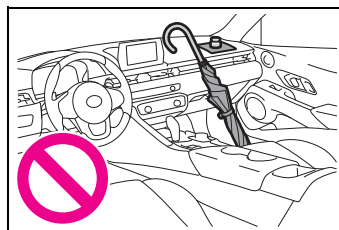

⚠ WARNING

Do not install or attach anything, such as a sticker to areas such as the steering wheel pad and near the SRS knee airbags. Also, do not attach any accessories, such as an air freshener, to the passenger's side instrument panel or place anything on the floor in front of the seat. If anything is attached to or left in these areas, they may prevent an airbag from deploying or become a projectile when the airbags deploy.

The SRS front airbags and SRS knee airbags will deploy when

When the vehicle is involved in a frontal collision which exceeds a threshold equivalent to colliding with a concrete wall which does not move or deform

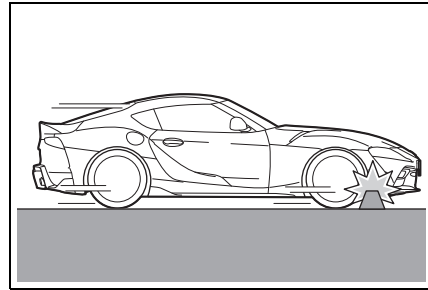
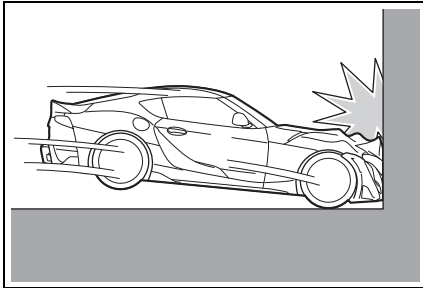

When the vehicle collides with a curb

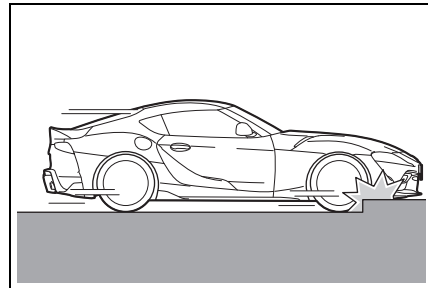

When the vehicle falls into a deep hole or ditch

When an impact which exceeds a threshold is applied to the vehicle at an angle of 30 degrees or less of the front left or right corner of the vehicle (A)

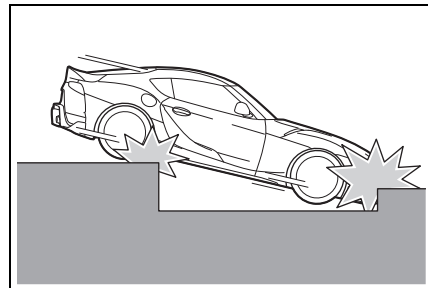
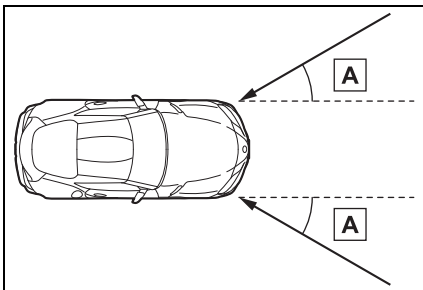

When the vehicle is jumped and lands hard

The SRS front airbags and SRS knee airbags may deploy when

When an impact which exceeds a threshold is applied to the underside of the vehicle

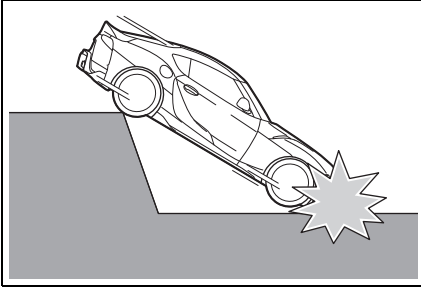

The threshold for the SRS front airbags and SRS knee airbags to deploy will increase considerably when

When the vehicle is involved in a frontal collision with parked vehicle with approximately the same mass

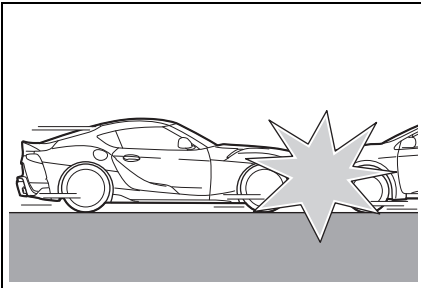

When the vehicle is involved in an underride collision with a truck

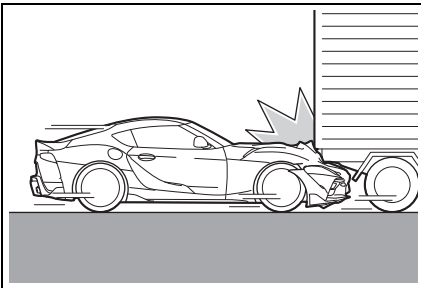

When the vehicle collides with a power pole or tree

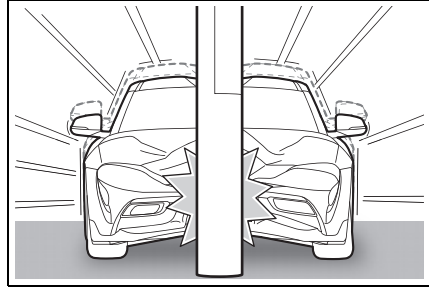

When the vehicle collides with an object which deforms or moves easily, such as a guard-rail

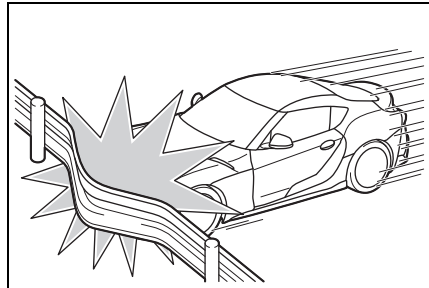

When the vehicle is involved in a rear-end collision

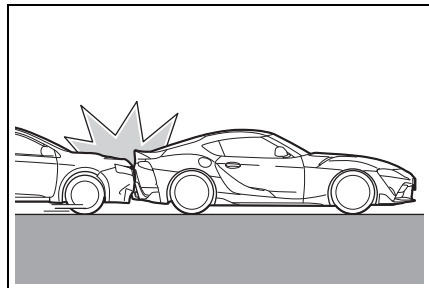

When the vehicle is involved in a side collision

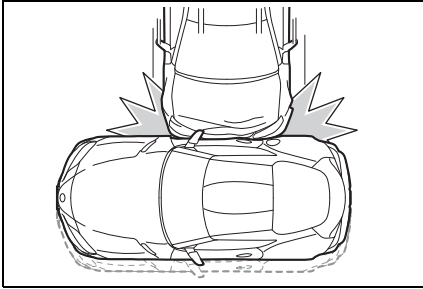

When the vehicle is involved in a rollover

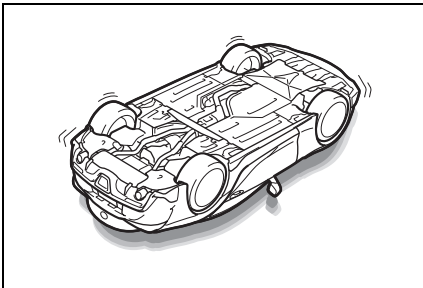

When a severe impact is applied to front of the vehicle while sliding

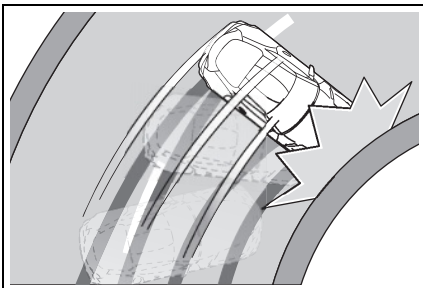

When a severe impact is applied to the front of the vehicle in a side collision

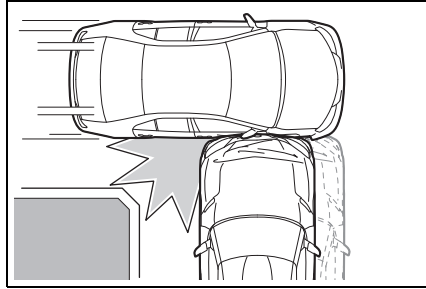

The SRS front airbags and SRS knee airbags will not deploy when

- When a subsequent collision occurs after the SRS front airbags or SRS knee airbags have operated
- When only a small impact is applied to the front of the vehicle in a collision
- When the SRS airbag warning light is illuminated

SRS side airbag/SRS curtain shield airbag

The airbags are not designed to be used in place of the seat belts.

The SRS side airbags and SRS curtain shield airbags are designed to deploy and protect the torso and head of occupants when a severe impact is applied to the side of the vehicle.

In the event of a side collision, the SRS side airbag and SRS curtain shield airbag on that side deploys (inflates), instantly cre-

ating an air cushion to help reduce the impact on the occupants and restrain them from contacting the door window, door, etc. with their head and torso. When an airbag deploys, as it will inflate nearly instantly, it may impact an occupant and cause an injury, or the loud noise emitted by ignition or deployment may cause temporary partial loss of hearing. Also, as an airbag and nearby parts will be extremely hot after the airbag deploys, touching them may cause burns. For these reasons, deployment of the airbags is not entirely risk free. Therefore, in order to reduce this risk, the airbags are designed to only deploy when additional reduction of the impact applied to the occupants in a collision is necessary.

If the force of the collision does not cause the airbags to deploy, the seatbelts will protect the occupants.

⚠ WARNING

Do not install seat covers which are not designed for use with this vehicle, or attach a cushion or any other accessory to either front seat or hang anything on either front seatback. Do not place objects around the side of either front seat. Refer to P.166 for the installation position of the SRS side airbags.

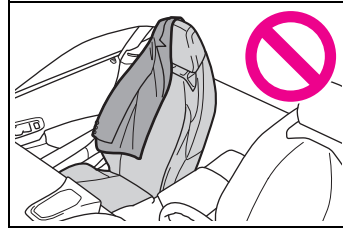

⚠ WARNING

Do not lean against the door or door window.

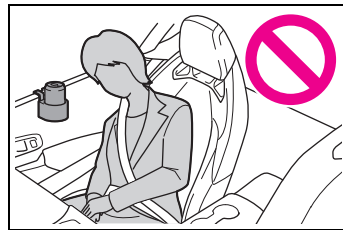

Also, do not install a cup holder or any other accessories near the SRS side airbags.

If anything is attached to or left in the deployment area of an SRS side airbag, the airbag may be prevented from deploying or the object may become a projectile when the airbag deploys, possibly leading to injury. Also, if an occupant is leaning into this area, the airbag may strike and injure the head or arm of the occupant when deploying.

⚠ WARNING

When using a cup holder, use the use the existing cup holders in the vehicle. Do not place anything but appropriately sized containers into the cup holders. Refrain from placing hot drinks or glass containers in the cup holders as they may cause burns or other injuries in the event of a collision or sudden braking.

The SRS side airbags and SRS curtain shield airbags will deploy when

When the vehicle is involved in a severe side collision

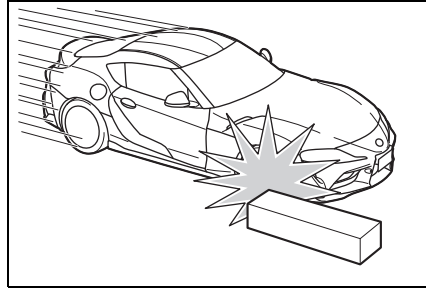
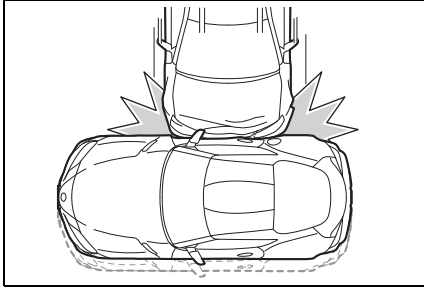

The threshold for the SRS side airbags and SRS curtain shield airbags to deploy will increase considerably when

When the vehicle is involved in a side collision in an area away from the cabin (engine compartment, luggage compartment, etc.)

The SRS side airbags and SRS curtain shield airbags may deploy when

When a severe impact is applied to the bottom of the vehicle, such as when driving over a large object in the road

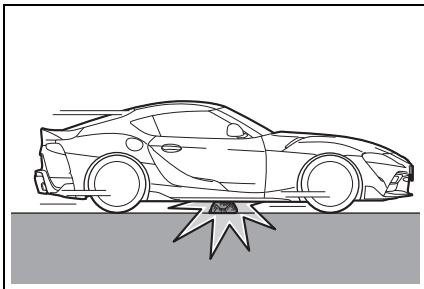

When severe impact is applied to a wheel or tire, or the suspension of the vehicle

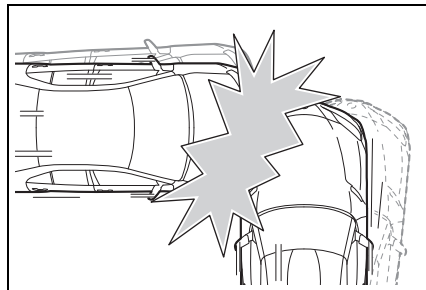

When the vehicle is involved in an offset angle side collision

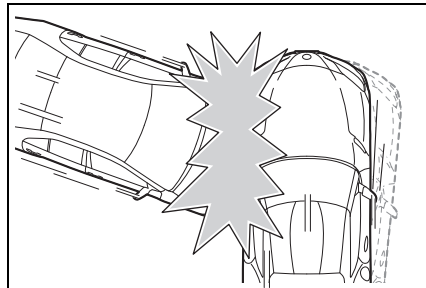

The SRS side airbags and SRS curtain shield airbags will not deploy when

- When a subsequent collision occurs after a SRS side airbag or SRS curtain shield airbag has operated
- When only a small impact is applied to the side of the vehicle in a collision
- When the SRS airbag warning light is illuminated
- When the majority of the initial force of an impact is applied only to a door

Strength of the driver's and front-seat passenger airbag

The explosive power that activates driver's/front-seat passenger airbags very much depends on the positions of the driver's/front passenger seat.

To maintain the accuracy of this function over the long term, calibrate the front seats as soon as a respective message appears on the Control Display.

Calibrating the front seats

WARNING

There is a risk of jamming when moving the seats. There is a risk of injury or risk of damage to property. Make sure that the area of movement of the seat is clear prior to any adjustment.

A corresponding message appears on the Control Display.

- 1 Press the switch and move the respective seat all the way forward, until it stops.
- 2 Press the switch forward again. The seat still moves forward slightly.
- 3 Readjust the seat to the desired position.

The calibration procedure is completed when the message on the Control Display disappears.

If the message continues to be displayed, repeat the calibration.

If the message does not disappear after a repeat calibration, have the system checked as soon as possible.

Automatic deactivation of the front-seat passenger airbags

Concept

The system reads if the front passenger seat is occupied by

measuring the human body's resistance.

Front, knee, and side airbag on the front passenger's side are activated or deactivated.

General information

Before transporting a child on the front passenger seat, refer to the safety information and instructions for children on the front passenger seat, see Children.

Safety information

WARNING

To ensure the front-seat passenger airbag function, the system must be able to detect whether a person is sitting in the front passenger seat. The entire seat cushion area must be used for this purpose. There is a risk of injuries or danger to life. Make sure that the front passenger keeps his or her feet in the floor area.

Malfunction of the automatic deactivation system

When transporting older children and adults, the front-seat passenger airbags may be deactivated in certain sitting positions. In this case, the indicator light for the front-seat passenger airbags lights up.

In this case, change the sitting position so that the front-seat passenger airbags are acti-

vated and the indicator light goes out.

If it is not possible to activate the airbags, have the person sit in the rear.

To enable correct recognition of the occupied seat cushion.

- Do not attach covers, cushions, ball mats or other items to the front passenger seat unless they are specifically determined to be safe for use on the front passenger seat.
- Do not place any electronic devices on the front passenger seat if a child restraint system is to be installed on it.
- Do not place objects under the seat that could press against the seat from below.
- No moisture in or on the seat.

Indicator light for the front-seat passenger airbags

The indicator light for the front-seat passenger airbag in the roofliner indicates the operating state of the front-seat passenger airbag.

The light indicates whether the airbags are either activated or deactivated.

After drive-ready state is switched on, the light briefly lights up and then indicates whether the airbags are either

activated or deactivated.

- The indicator light lights up when a child is properly seated in a child restraint system or when the seat is empty. The airbags on the front passenger side are not activated.
- The indicator light does not light up when, for instance a correctly seated person of sufficient size is detected on the seat. The airbags on the front passenger side are activated.



PASSENGER
AIR BAG OFF

Detected child restraint systems

The system generally detects children seated in a child restraint system, particularly in child restraint systems required by NHTSA at the point in time when the vehicle was manufactured. After installing a child restraint system, make sure that the indicator light for the front-seat passenger airbags lights up. This indicates that the child restraint system has been detected and the front-seat passenger airbags are not activated.

Toyota Supra Safety

Concept

Toyota Supra Safety enables central operation of the driver assistance systems.

General information

Depending on how the vehicle is equipped, Toyota Supra Safety consists of one or more systems that can help prevent an imminent collision.

- Pre-Collision System, refer to page 180.
- Pre-Collision System (for pedestrians and bicycles), refer to page 185.
- Lane departure warning, refer to page 189.
- Blind spot monitor, refer to page 194.

Safety information

⚠ WARNING
 The system cannot serve as a substitute for the driver's personal judgment in assessing the traffic situation. Based on the limits of the system, it cannot independently react to all traffic situations. There is a risk of accident, injury, and property damage. Adjust driving style to traffic conditions. Watch the surrounding traffic situation closely, be ready to take over steering and braking at any time, and actively intervene where appropriate.

⚠ WARNING
 Indicators and warnings cannot serve as a substitute for the driver's personal judgment. Due to its limits, the system may not issue warnings or responses, or these may be issued late or in a manner that is not consistent with their normal use. There is a risk of accident, injury, and property damage. Adjust driving style to traffic conditions. Watch surrounding traffic closely and actively intervene where appropriate.

Overview

Button in the vehicle



Toyota Supra Safety

Switching on/off

Some Toyota Supra Safety systems are automatically active after every departure. Some Toyota Supra Safety systems activate according to the last setting.

Button	Status
	Indicator lights up green: all Toyota Supra Safety systems are switched on.
	Indicator lights up orange: some Toyota Supra Safety systems are switched off or currently unavailable.
	Indicator does not light up: all Toyota Supra Safety systems are switched off.



Press the button:

The menu for the Toyota Supra Safety system is displayed.

If all Toyota Supra Safety systems were switched off, all systems are now switched on.

"Customize Settings": depending on the equipment version, the Toyota Supra Safety systems can be individually config-

ured. The individual settings are activated and stored. As soon as a setting is changed on the menu, all settings of the menu are activated.



Press the button repeatedly. The following settings are switched between:

"ALL ON": all Toyota Supra Safety systems are switched on. Basic settings are activated for the sub-functions, for instance setting for warning time.

"Customized": the Toyota Supra Safety systems are switched on according to the individual settings.

Some Toyota Supra Safety systems cannot be individually switched off.



Press and hold this button:

All Toyota Supra Safety systems are switched off.

Front collision mitigation

Concept

The system may prevent some accidents. In the event of an accident, the system may reduce impact speed.

The system sounds a warning before an imminent collision and activates brakes independently,

if needed.

General information

Depending on the equipment version, the system is controlled by the following sensors:

- Camera in the area of the interior mirror.
- Radar sensor in the front bumper.

The approach control warning is available even if cruise control has been deactivated.

With the vehicle approaching another vehicle intentionally, the approach control warning and braking are delayed in order to avoid false system reactions.

The system issues a two-phase warning of a possible risk of collision with vehicles at speeds above approx. 3 mph/5 km/h.

The timing of warnings may vary with the current driving situation.

Safety information

⚠ WARNING

The system cannot serve as a substitute for the driver's personal judgment in assessing the traffic situation. Based on the limits of the system, it cannot independently react to all traffic situations. There is a risk of accident, injury, and property damage. Adjust driving style to traffic conditions. Watch the surrounding traffic situation closely, be ready to take over steering and braking at any time, and actively intervene where appropriate.

⚠ WARNING

Indicators and warnings cannot serve as a substitute for the driver's personal judgment. Due to its limits, the system may not issue warnings or responses, or these may be issued late or in a manner that is not consistent with their normal use. There is a risk of accident, injury, and property damage. Adjust driving style to traffic conditions. Watch surrounding traffic closely and actively intervene where appropriate.

Overview

Button in the vehicle



Toyota Supra Safety

Sensors

The system is controlled by the following sensors:

- Cameras behind the windshield.
- With radar sensor: front radar sensor.

Additional information:

Sensors of the vehicle, refer to page 45.

Switching on/off

Switching on automatically

The system is automatically active after every driving off.

Switching on/off manually



Press the button.

The menu for the Toyota Supra Safety system is displayed.

If all Toyota Supra Safety systems were switched off, all systems are now switched on.

"Customize Settings": depending on the equipment version, the Toyota Supra Safety systems can be individually configured. The individual settings are activated and stored. As soon

as a setting is changed on the menu, all settings of the menu are activated.



Press the button repeatedly.

The following settings are switched between:

"ALL ON": all Toyota Supra Safety systems are switched on. Basic settings are activated for the subfunctions.

"Customize": the Toyota Supra Safety systems are switched on according to the individual settings.

Some Toyota Supra Safety systems cannot be individually switched off.



Press and hold this button.

All Toyota Supra Safety systems are switched off.

Button	Status
	Indicator lights up green: all Toyota Supra Safety systems are switched on.

Button	Status
	Indicator lights up orange: some Toyota Supra Safety systems are switched off or currently unavailable.
	Indicator does not light up: all Toyota Supra Safety systems are switched off.

Setting the warning time



Via Toyota Supra Command:

- 1 "My Vehicle"
- 2 "Vehicle settings"
- 3 "Toyota Supra Safety"
- 4 "Front collision warning"
- 5 Select desired setting:
 - "early"
 - "medium"
 - "late": only acute warnings are displayed.

Warning with braking function

Display

If there is a risk of collision with a detected vehicle, a warning light is shown on the instrument cluster and Head-up display as applicable.

Symbol	Measure
	Warning light illuminates red: Advance warning. Brake and increase distance.
	Warning light flashes red and acoustic signal sounds: Acute warning. Brake and make an evasive maneuver, if necessary.

Prewarning

This warning is provided, for instance when there is impending danger of a collision or the distance to the vehicle ahead is too small.

If a prewarning is provided, respond by braking as warranted.

Acute warning with braking function

An acute warning is displayed in case of the imminent danger of a collision when the vehicle approaches another object at a high differential speed.

Intervene in the case of an acute warning. Depending on the driving situation and the equipment version, the acute warning may be accompanied by a brief activation of the braking system.

With the warning time setting "late" the brief activation of the braking system is omitted.

If an acute warning is provided, the system may also provide assistance, such as through braking, when there is risk of collision.

Acute warnings may be provided even when there has been no prior warning.

Braking intervention

The warning prompts the driver to intervene. When the brake pedal is pressed quickly and hard, the maximum braking force of the vehicle is used.

The system may also assist in braking if there is a risk of collision.

When the vehicle is traveling at a low speed, the vehicle may come to a complete stop.

Manual transmission: during a brake intervention up to a complete stop, the engine may be shut down.

City brake function: the braking intervention occurs to up to approx. 53 mph/85 km/h.

With radar sensor: the braking intervention occurs to up to approx. 155 mph/250 km/h.

At speeds above approx. 130 mph/210 km/h, the braking intervention occurs as a brief braking

pressure. No automatic delay occurs.

The driver may interrupt the braking intervention function by stepping on the accelerator pedal or by actively moving the steering wheel.

The system's ability to detect objects may be limited in some circumstances. Refer to the information in this Owner's Manual regarding the limitations of the system and actively intervene as warranted.

System limits

Safety information

WARNING

Because of system limitations, this system may either not respond, or respond too late, incorrectly, or without cause. There is a risk of accident, injury, and property damage. Actively intervene as warranted. Refer to the information in this Owner's Manual regarding the scope of the system's operation and limitations.

Detection range

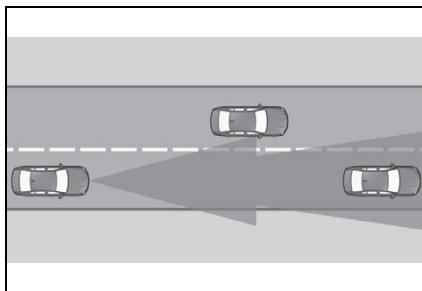

Only objects that are detected by the system are taken into account.

The following situations may not be detected, for instance:

Thus, a system reaction might not come or might come late.

The following situations may not be detected, for instance:

- Slow moving vehicles when you approach them at high speed.
- Vehicles that suddenly swerve in front of you, or sharply decelerating vehicles.
- Vehicles with an unusual rear appearance.
- Two-wheeled vehicles ahead of you.

Upper speed limit

If the vehicle speed exceeds approx. 155 mph/250 km/h, the system is deactivated temporarily. When the vehicle slows down to below this speed, the system is reactivated.

System limits of the sensors

Additional information:

- Cameras, refer to page 42.
- Radar sensors, refer to page 43.

Functional limitations

The system may not be fully functional in the following situations:

- In tight curves.
- If the driving stability control systems are limited or deactivated, for instance VSC OFF.
- Up to 10 seconds after the start of the engine via the Start/Stop button.

Also, do not use this system when towing.

Warning sensitivity

The more sensitive the warning settings are, for example the warning time, the more warnings are displayed. Therefore, there may also be an excess of premature or unjustified warnings and reactions.

Pre-Collision System (for pedestrians and bicycles)

Concept

The system can help prevent accidents involving pedestrians

and cyclists. In the event of an accident, the system may reduce impact speed. The system sounds a warning in the city speed range before an imminent collision and activates brakes independently, if needed.

General information

The system issues a warning of a possible risk of collision with pedestrians and cyclists at speeds above approx. 3 mph/5 km/h.

The system reacts to pedestrians and cyclists who are within the detection range of the system.

Depending on the equipment version, the system is controlled by the following sensors:

- Camera in the area of the interior mirror.
- Radar sensor in the front bumper.

Detection range

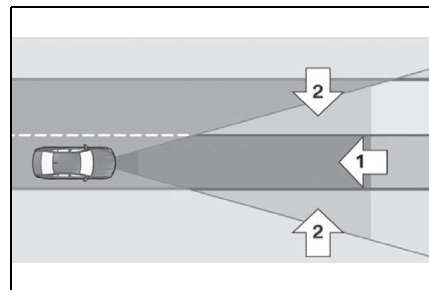

The detection area in front of the vehicle is divided into two areas:

- Central area, arrow **1**, directly in front of the vehicle.
- Expanded area, arrows **2**, to the right and left of the central area.

A collision is imminent if pedestrians are located within the central area. A warning is issued about pedestrians who are located within the extended area only if they are moving in the direction of the central area.

Safety information

WARNING

The system cannot serve as a substitute for the driver's personal judgment in assessing the traffic situation. Based on the limits of the system, it cannot independently react to all traffic situations. There is a risk of accident, injury, and property damage. Adjust driving style to traffic conditions. Watch the surrounding traffic situation closely, be ready to take over steering and braking at any time, and actively intervene where appropriate.

WARNING

Indicators and warnings cannot serve as a substitute for the driver's personal judgment. Due to its limits, the system may not issue warnings or responses, or these may be issued late or in a manner that is not consistent with their normal use. There is a risk of accident, injury, and property damage. Adjust driving style to traffic conditions. Watch surrounding traffic closely and actively intervene where appropriate.

Overview

Button in the vehicle



Toyota Supra Safety

Sensors

The system is controlled by the following sensors:

- Cameras behind the windshield.
- With radar sensor: front radar sensor.

Additional information:

Sensors of the vehicle, refer to P.45.

Switching on/off

Switching on automatically

The system is automatically active after every driving off.

Switching on/off manually



Press the button.

The menu for the Toyota Supra Safety system is displayed.

If all Toyota Supra Safety systems were switched off, all systems are now switched on.

"Customize Settings": depending on the equipment version, the Toyota Supra Safety systems can be individually configured. The individual settings are activated and stored. As soon as a setting is changed on the menu, all settings of the menu are activated.



Press the button repeatedly.

The following settings are switched between:

"ALL ON": all Toyota Supra Safety systems are switched on. Basic settings are activated for the subfunctions.

"Customize": the Toyota Supra Safety systems are switched on according to the individual settings.

Some Toyota Supra Safety systems cannot be individually switched off.



Press and hold this button.

All Toyota Supra Safety systems are switched off.

Button	Status
	Indicator lights up green: all Toyota Supra Safety systems are switched on.
	Indicator lights up orange: some Toyota Supra Safety systems are switched off or currently unavailable.
	Indicator does not light up: all Toyota Supra Safety systems are switched off.

3 CONTROLS

Warning with braking function

Display

If there is a risk of collision with a detected pedestrian or cyclist, a warning light is shown on the instrument cluster and Head-up display as applicable.

Warning light illuminates red and acoustic signal sounds: Risk of imminent collision detected.



Alternatively, depending on the vehicle equipment, a red warning triangle lights up in the instrument cluster.

Intervene immediately by braking or make an evasive maneuver.

Braking intervention

The warning prompts the driver to intervene. When the brake pedal is pressed quickly and hard, the maximum braking force of the vehicle is used.

If there is a risk of collision, the system may also assist with brake intervention.

When the vehicle is traveling at a low speed, the vehicle may come to a complete stop.

Manual transmission: during a brake intervention up to a complete stop, the engine may be shut down.

The braking intervention can be interrupted by stepping on the accelerator pedal with sufficient force or by actively moving the steering wheel.

System limits

Safety information

WARNING

Because of system limitations, this system may either not respond, or respond too late, incorrectly, or without cause. There is a risk of accident, injury, and property damage. Actively intervene as warranted. Refer to the information in this Owner's Manual regarding the scope of the system's operation and limitations.

Upper speed limit

The system responds to pedestrians and cyclists when the speed of the vehicle is below approx. 53 mph/85 km/h.

Detection range

The system's detection potential is limited.

Thus, a warning might not be issued or be issued late.

The following situations may not be detected, for instance:

- Partially covered pedestrians.
- Pedestrians that are not detected as such because of the viewing angle or contour.
- Pedestrians outside of the detection range.
- Pedestrians having a body size less than 32 in/80 cm.

System limits of the sensors

Additional information:

- Cameras, refer to page 42.
- Radar sensors, refer to page 43.

Functional limitations

The system may not be fully functional or may not be available in the following situations:

- If the driving stability control systems are deactivated, for instance VSC OFF.
- Up to 10 seconds after the start of the engine via the Start/Stop button.

Also, do not use this system when towing.

Lane departure warning

Concept

The lane departure warning alerts when the vehicle is about to run off the road or exit the lane.

General information

This camera-based system warns starting at a minimum speed.

The minimum speed is country-specific and is displayed in the menu for the Toyota Supra Safety systems.

Warnings are issued by means of a steering wheel vibration. The severity of the steering wheel vibration can be adjusted.

The system does not provide a warning if the turn signal is set in the respective direction before leaving the lane.

Depending on the equipment version, if in the speed range up to 155 mph/250 km/h a lane marking is crossed, the system may intervene with a brief active steering intervention in addition to vibrating. The system thus helps keep the vehicle in the lane.

Safety information

WARNING

The system cannot serve as a substitute for the driver's personal judgment in assessing road and traffic safety. There is a risk of accident, injury, and property damage. Adjust driving style to traffic conditions. Watch traffic closely and actively intervene where appropriate. Do not jerk the steering wheel in response to a warning.

⚠ WARNING

Indicators and warnings cannot serve as a substitute for the driver's personal judgment. Due to its limits, the system may not issue warnings or responses, or these may be issued late or in a manner that is not consistent with their normal use. There is a risk of accident, injury, and property damage. Adjust driving style to traffic conditions. Watch surrounding traffic closely and actively intervene where appropriate

Overview

Button in the vehicle

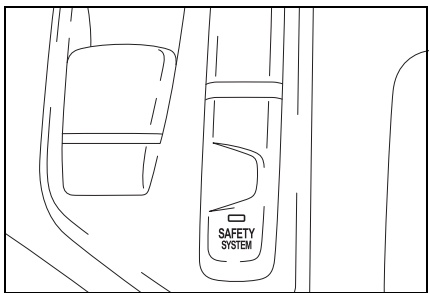

SAFETY SYSTEM Toyota Supra Safety

Sensors

The system is controlled by the following sensors:

- Cameras behind the windshield.

Additional information:
Sensors of the vehicle, refer to page 42.

Functional requirements

The camera must detect the lane markings for the lane departure warning to be active.

Turning on/off

Turning on automatically

Depending on the national-market version, the system is automatically active after every driving off.

Switching on/off manually



Press the button.

The menu for the Toyota Supra Safety system is displayed.

If all Toyota Supra Safety systems were switched off, all systems are now switched on.

"Customize Settings": depending on the equipment version, the Toyota Supra Safety systems can be individually configured. The individual settings are activated and stored. As soon as a setting is changed on the menu, all settings of the menu are activated.



Press the button repeatedly.

The following settings are switched between:

"ALL ON": all Toyota Supra Safety systems are switched on. Basic settings are activated for the subfunctions.

"Customize": the Toyota Supra Safety systems are switched on according to the individual settings.

Some Toyota Supra Safety systems cannot be individually switched off.



Press and hold this button.

All Toyota Supra Safety systems are switched off.

Button	Status
	Indicator lights up green: all Toyota Supra Safety systems are switched on.
	Indicator lights up orange: some Toyota Supra Safety systems are switched off or currently unavailable.
	Indicator does not light up: all Toyota Supra Safety systems are switched off.

Setting the warning time

Via Toyota Supra Command:

- 1 "My Vehicle"
- 2 "Vehicle settings"
- 3 "Toyota Supra Safety"

4 "Lane Departure Warn."

5 Select desired setting:

- "Early": the system promptly issues a warning whenever a hazardous situation is detected.
- "Medium": the system meets the standardized safety requirements.
- "Reduced": some warnings are suppressed depending on the situation, for instance during passing without a turn signal or when purposely driving over lane markings in curves.
- "Off": no warnings are issued.

Setting the intensity of the steering wheel vibration

Via Toyota Supra Command:

- 1 "My Vehicle"
- 2 "Vehicle settings"
- 3 "Steering wheel vibration"
- 4 Select the desired setting.

Switching steering intervention on/off

The steering intervention can be switched on and off separately for Blind spot monitor and lane departure warning.

Via Toyota Supra Command:

- 1 "My Vehicle"
- 2 "Vehicle settings"

3 "Toyota Supra Safety"

4 "Steering intervention"

Depending on the national-market version, the steering intervention is automatically active after every driving off.

Display in the instrument cluster

Indicator light illuminates green: System is switched on. A lane boundary has been detected on at least one side of the vehicle and the system is ready to intervene. Warnings will be issued. The system can perform steering interventions.



Indicator light flashes green: System is performing a steering intervention.

Warning function

If you leave the lane

If you leave the lane and if a lane marking has been detected, the steering wheel vibrates in accordance with the steering wheel vibration setting.

When the turn signal is switched on in the corresponding direction before changing the lane, a warning is not issued.

Steering intervention

If, in the speed range up to 130

mph/210 km/h a lane boundary is crossed, the system may intervene with a brief active steering intervention in addition to vibrating. The steering intervention helps keep the vehicle in the lane. The steering intervention can be noticed on the steering wheel and can be manually overridden at any time. During an active steering intervention, the display in the instrument cluster will blink.

For instance, the steering intervention will be suppressed in the following situations:

- With accelerating or braking hard.
- When the turn signal indicator is blinking.
- With hazard warning system switched on.
- In driving situation with high driving dynamics.
- The Vehicle Stability Control VSC adjusts.
- Immediately following a steering intervention by the vehicle systems.
- When actively merging back to your own lane after passing.

Warning signal

Depending on the equipment, in the event of multiple active steering interventions by the

system within 3 minutes without the driver's intervention at the steering wheel, an acoustic warning will sound. A short warning signal will sound at the second steering intervention. Beginning with the third steering intervention, an continuous warning will sound. In addition, a vehicle message is displayed. The warning signal and vehicle message are an encouragement to pay closer attention to the lane.

End of warning

For instance, the warning will be canceled in the following situations:

- Automatically after a few seconds.
- When returning to your own lane.
- When braking hard.
- When using the turn signal.
- If VSC Vehicle Stability Control System intervenes.

System limits

Safety information

WARNING

Because of system limitations, this system may either not respond, or respond too late, incorrectly, or without cause. There is a risk of accident, injury, and property damage. Actively intervene as warranted. Refer to the information in this Owner's Manual regarding the scope of the system's operation and limitations.

System limits of the sensors

Additional information:

- Cameras, refer to page 45.

Functional limitations

The system may not be fully functional in the following situations:

- In the event of missing, worn, poorly visible, merging, diverging, or multiple lane markings such as in construction areas.
- When lane markings are covered in snow, ice, dirt or water.
- In tight curves or on narrow lanes.
- When lane markings are covered by objects.
- When driving very close to the vehicle in front of you.

- Up to 10 seconds after the start of the engine via the Start/Stop button.

A vehicle message may be displayed when the system is not fully functional.

Blind spot monitor*

*: if equipped

Concept

Blind spot monitor detects vehicles in the blind spot or vehicles approaching from behind in the adjacent lane. The warning light in the exterior mirror warns the driver at different levels.

General information

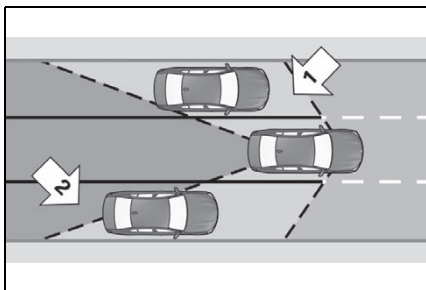

Radar sensors monitor the area behind and next to the vehicle when traveling faster than a minimum speed.

The minimum speed is country-specific and is displayed in the menu for the Toyota Supra Safety systems.

The system indicates whether

there are vehicles in the blind spot, arrow **1**, or approaching from behind in the adjacent lane, arrow **2**.

The warning light in the exterior mirror illuminates dimly.

Before you change lanes after setting the turn signal, the system issues a warning in the situations described above.

The warning light in the exterior mirror flashes and the steering wheel vibrates.

Safety information

WARNING

The system cannot serve as a substitute for the driver's personal judgment in assessing the traffic situation. Based on the limits of the system, it cannot independently react to all traffic situations. There is a risk of accident, injury, and property damage. Adjust driving style to traffic conditions. Watch the surrounding traffic situation closely, be ready to take over steering and braking at any time, and actively intervene where appropriate.

⚠ WARNING

Indicators and warnings cannot serve as a substitute for the driver's personal judgment. Due to its limits, the system may not issue warnings or responses, or these may be issued late or in a manner that is not consistent with their normal use. There is a risk of accident, injury, and property damage. Adjust driving style to traffic conditions. Watch surrounding traffic closely and actively intervene where appropriate

Overview

Button in the vehicle



SAFETY SYSTEM Toyota Supra Safety

Sensors

The system is controlled by the following sensors:

- Radar sensors, side, rear.

Additional information:
Sensors of the vehicle, refer to page 42.

Switching on/off

Switching on automatically

The Blind spot monitor is automatically activated after departure if the function was switched on at the end of the last trip.

Switching on/off manually

SAFETY SYSTEM Press the button.

The menu for the Toyota Supra Safety system is displayed.

If all Toyota Supra Safety systems were switched off, all systems are now switched on.

"Customize Settings": depending on the equipment version, the Toyota Supra Safety systems can be individually configured. The individual settings are activated and stored. As soon as a setting is changed on the menu, all settings of the menu are activated.

SAFETY SYSTEM Press the button repeatedly.

The following settings are switched between:

"ALL ON": all Toyota Supra Safety systems are switched on. Basic settings are activated for the subfunctions.

"Customized": the Toyota Supra

Safety systems are switched on according to the individual settings.

Some Toyota Supra Safety systems cannot be individually switched off.



Press and hold this button.

All Toyota Supra Safety systems are switched off.

Button	Status
	Indicator lights up green: all Toyota Supra Safety systems are switched on.
	Indicator lights up orange: some Toyota Supra Safety systems are switched off or currently unavailable.
	Indicator does not light up: all Toyota Supra Safety systems are switched off.

Setting the warning time

Via Toyota Supra Command:

- 1 "My Vehicle"
- 2 "Vehicle settings"
- 3 "Toyota Supra Safety"
- 4 "Blind spot monitor"
- 5 Select the desired setting.

"Off": with this setting, no warning is output.

Setting the force of the steering wheel vibration

Via Toyota Supra Command:

- 1 "My Vehicle"
- 2 "Vehicle settings"
- 3 "Steering wheel vibration"
- 4 Select the desired setting.

Warning function

Warning light in the exterior mirror

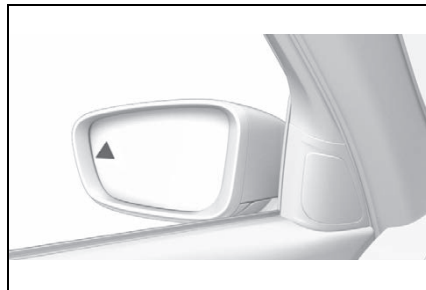

The warning light in the exterior mirror warns of a possible collision.

Prewarning

The dimmed warning light in the exterior mirror indicates when vehicles are in your blind spot or approaching from the rear.

Acute warning

If the turn signal is activated while a vehicle is in your hazard area, the steering wheel vibrates briefly and the warning light in the exterior mirror

flashes brightly.

The warning stops when the other vehicle has left the critical area or after deactivation of the turn signal.

Warning light flashing

When the vehicle is unlocked, the warning light in the exterior mirror flashes for self-testing purposes.

System limits

Safety information

WARNING

Because of system limitations, this system may either not respond, or respond too late, incorrectly, or without cause. There is a risk of accident, injury, and property damage. Actively intervene as warranted. Refer to the information in this Owner's Manual regarding the scope of the system's operation and limitations.

Upper speed limit

If the vehicle speed exceeds approx. 155 mph/250 km/h, the system is deactivated temporarily.

If the vehicle speed falls below approx. 155 mph/250 km/h, the system once again responds according to the setting.

System limits of the sensors

Additional information:

- Radar sensors, refer to page 42.

Functional limitations

The system may not be fully functional in the following situations:

- When a vehicle is approaching at a speed much faster than your own.
- In heavy fog, wet conditions, or snowfall.
- In tight curves or on narrow lanes.
- If the bumper is dirty, iced up, or covered, for instance by stickers.
- After improperly performed work on the vehicle paint.
- If cargo protrudes.

A vehicle message is displayed when the system is not fully functional.

Displaying warnings

Depending on the selected warning settings, e.g., warning time, more or fewer warnings can be displayed. However, there may also be an excess of premature warnings of critical situations.

Rear-end collision preparation

Principle

Depending on the equipment and national-market version, the rear-end collision preparation can react to vehicles approaching from behind.

General

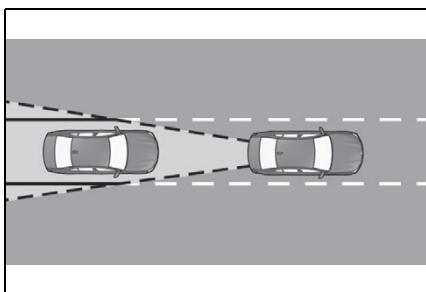

Radar sensors monitor the area behind the vehicle.

When a vehicle approaches from the rear at a certain speed, the system can react as follows:

- Where applicable, the hazard warning flashers will be switched on.
- Where applicable, the Pre-Crash functions are triggered.

Safety information

WARNING

The system cannot serve as a substitute for the driver's personal judgment in assessing the traffic situation. Based on the limits of the system, it cannot independently react to all traffic situations. There is a risk of accident, injury, and property damage. Adjust driving style to traffic conditions. Watch the surrounding traffic situation closely, be ready to take over steering and braking at any time, and actively intervene where appropriate.

WARNING

Indicators and warnings cannot serve as a substitute for the driver's personal judgment. Due to its limits, the system may not issue warnings or responses, or these may be issued late or in a manner that is not consistent with their normal use. There is a risk of accident, injury, and property damage. Adjust driving style to traffic conditions. Watch surrounding traffic closely and actively intervene where appropriate.

Overview

Sensors

The system is controlled by the following sensors:

- Radar sensors, side, rear.

Additional information:

Sensors of the vehicle, refer to page 42.

Switching on/off

The system is automatically active when the vehicle is turned on.

The system is deactivated in the following situations:

- When driving in reverse.

System limits

System limits of the sensors

Additional information:

- Radar sensors, refer to page 43.

Functional limitations

This function may be restricted if the speed of the approaching vehicle is much higher or similar to your own speed.

Autonomous Emergency Braking

Concept

In the event of an accident, the system can bring the vehicle to a halt automatically without intervention by the driver in certain situations. This can reduce the risk of a further collision and the consequences thereof.

At standstill

After coming to a halt, the brake is released automatically.

Harder vehicle braking

It can be necessary to bring the vehicle in certain situations to a halt quicker.

To do this, quickly apply extra force to the brake. The brake pressure will then be higher than the brake pressure generated by the automatic brake function. Automatic braking is interrupted.

Interrupting automatic braking

It can be necessary to interrupt automatic braking in certain situations, for instance for an evasive maneuver.

Interrupt automatic braking:

- By depressing the brake pedal for slightly longer.
- By pressing the accelerator pedal for slightly longer.

Driver attention control

General information

The system can detect decreasing alertness or fatigue of the driver during long, monotonous trips, for instance on highways. In this situation, it is recom-

mended that the driver takes a break.

Safety information

⚠ WARNING

The system cannot serve as a substitute for the driver's personal judgment in assessing one's physical state. An increasing lack of alertness or fatigue may not be detected or not be detected in time. There is a risk of accident, injury, and property damage. Make sure that the driver is rested and alert. Adjust driving style to traffic conditions.

Function

The system is switched on each time drive-ready state is switched on.

After travel has begun, the system monitors certain aspects of the driver's behavior, so that decreasing alertness or fatigue can be detected.

This procedure takes the following criteria into account:

- Personal driving style, for instance steering behavior.
- Driving conditions, for instance length of trip.

Starting at approx. 43 mph/70 km/h, the system is active and can also display a recommendation to take a break.

Break recommendation

Settings

The break recommendation can also be switched on or off and adjusted via Toyota Supra Command.

Via Toyota Supra Command:

- 1 "My Vehicle"
- 2 "Vehicle settings"
- 3 "Driver attention control"
- 4 Select desired setting:
 - "Standard": the break recommendation is made with a defined value.
 - "Sensitive": the break recommendation is issued earlier.
 - "Off": no break recommendation is made.

Display

If the driver becomes less alert or fatigued, a message is displayed in the Control Display with the recommendation to take a break.

During the display, the following settings can be selected:

- "Do not ask again"
- "Places to stop"
- "Remind me later"

The break recommendation is repeated after 20 minutes.

After a break, another recom-

mendation to take a break cannot be displayed until after approximately 45 minutes.

System limits

The function may be limited in the following situations and may be output an incorrect warning or no warning at all.

- When the clock is set incorrectly.
- When the vehicle speed is mainly below about 43 mph/70 km/h.
- With a sporty driving style, such as during rapid acceleration or when cornering fast.
- In active driving situations, such as when changing lanes frequently.
- When the road surface is poor.
- In the event of strong side winds.

The system is reset approx. 45 minutes after parking the vehicle, for instance in the case of a break during longer trips on highways.

Driving stability control systems

Vehicle features and options

This chapter describes all standard, country-specific and optional features offered with the series. It also describes features and functions that are not necessarily available in your vehicle, e.g., due to the selected options or country versions. This also applies to safety-related functions and systems. When using these functions and systems, the applicable laws and regulations must be observed.

Anti-lock Braking System ABS

Concept

ABS prevents locking of the wheels during braking. The vehicle maintains its steerability even during emergency braking, which increases the active driving safety.

General information

ABS is ready after each engine start.

Situations which the ABS cannot operate sufficiently:

- When entering a curve at an

excessively high rate of speed

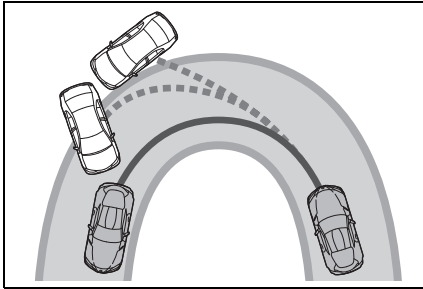

In this case, even if the ABS operates, it cannot operate sufficiently to avoid a possible dangerous situation. The driver is solely responsible for understanding their surroundings and driving at a safe speed.

Malfunction



The warning light on the instrument cluster illuminates.

ABS

A Check Control message is displayed.

- ABS is not available.
- The ability to steer is restricted during full braking.

Have checked immediately by your Toyota dealer.

Brake assist

The brake assistant automatically applies maximum braking assistance when the brake pedal is depressed quickly. This reduces the braking distance to a minimum for full braking.

To make full use of braking

assistance, do not reduce the pressure on the brake pedal during full braking.

Hill-start assist control

Concept

This system supports driving off on uphill grades.

Driving off

- 1 Hold the vehicle in place with the foot brake.
- 2 Release the foot brake and drive off without delay.

After the foot brake is released, the vehicle is held in place for approx. 2 seconds.

Depending on the vehicle loading, the vehicle may roll back slightly.

In order to prevent rolling back when driving off, use the parking brake.

- 1  Pull and release switch before driving off. The parking brake is set.
- 2 Step on the accelerator pedal sufficiently to drive off.

VSC Vehicle Stability Control System

Concept

Within the physical limits, the system helps to keep the vehicle on a steady course by reducing engine speed and by braking the individual wheels.

General information

VSC detects the following unstable driving conditions, for instance:

- Fishtailing, which can lead to oversteering.
- Loss of traction of the front wheels, which can lead to understeering.

Safety information

WARNING

The system cannot serve as a substitute for the driver's personal judgment in assessing the traffic situation. Based on the limits of the system, it cannot independently react to all traffic situations. There is a risk of accident, injury, and property damage. Adjust driving style to traffic conditions. Watch the surrounding traffic situation closely, be ready to take over steering and braking at any time, and actively intervene where appropriate.

WARNING

When driving with a roof load, e.g., roof bars, the vehicle's center of gravity is higher. This increases the risk of the vehicle tipping in critical driving situations. There is a risk of accident, injury, and property damage. Drive with roof load only with activated VSC.

Overview

Button in the vehicle

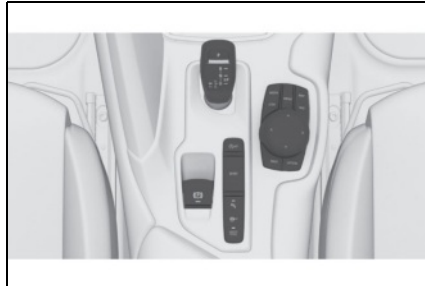

VSC OFF

Deactivating/activating VSC

General information

When VSC is deactivated, driving stability is reduced during acceleration and when driving in curves.

To increase vehicle stability, activate VSC again as soon as possible.

Deactivating VSC



Hold the button down until VSC OFF is displayed in the instrument cluster and the VSC OFF indicator light is illuminated.

Activating VSC



Press the button. VSC OFF and the VSC OFF indicator light go out.

Display

In the instrument cluster

When VSC is deactivated, VSC OFF is displayed in the instrument cluster.

Indicator/warning lights



The indicator light lights up: VSC is deactivated.



Warning light flashes: VSC is regulating the drive and brake power.

Warning light illuminates: VSC has failed.

Situations which the VSC cannot operate sufficiently

- When entering a curve at an excessively high rate of speed

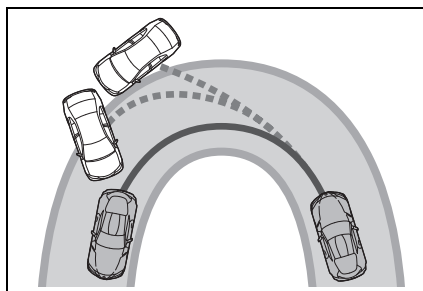

In this case, even if the VSC operates, it cannot operate sufficiently to avoid a possible dangerous situation. The driver is solely responsible for understanding their surroundings and driving at a safe speed.

Traction mode

Concept

Traction mode is a version of the VSC Vehicle Stability Control System where forward momentum is optimized.

The system ensures maximum headway on special road conditions or loose road surfaces, for instance unplowed snowy roads, but with somewhat limited driving stability.

General information

When Traction mode is activated, the vehicle has maximum traction. Driving stability is limited during acceleration and when driving in curves.

You may find it useful to briefly activate Traction mode in the

following situations:

- When driving in slush or on uncleared, snow-covered roads.
- When driving off from deep snow or loose ground.

Overview

Button in the vehicle

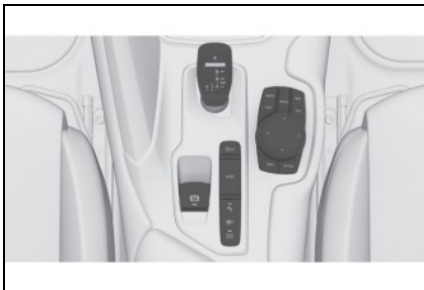

VSC OFF

Activating/deactivating Traction mode

Activating Traction mode

Press the button.



TRACTION is displayed in the instrument cluster and the indicator light for VSC OFF lights up.

Deactivating Traction mode

Press the button again.



TRACTION and the VSC OFF indicator light go out.

Display

Display in the instrument cluster

If Traction mode is activated, TRACTION is displayed in the instrument cluster.

Indicator light



Indicator light illuminates: Traction mode is activated.

Automatic program change

In certain situations, the VSC is activated automatically:

- If Dynamic radar cruise control with full-speed range is activated.
- On a braking intervention by the Toyota Supra Safety systems.
- The vehicle has a flat tire.

Active differential*

*: if equipped

The active differential provides for continuously variable locking of the rear axle differential, depending on the driving situation. It prevents a single rear wheel from spinning and depending on the situation, increases the drive power of the

wheel with greater road grip. This significantly improves the traction and driving dynamics of the vehicle.

The driver is responsible adapting his or her driving style to the situation.

Driver assistance systems

Vehicle features and options

This chapter describes all standard, country-specific and optional features offered with the series. It also describes features and functions that are not necessarily available in your vehicle, e.g., due to the selected options or country versions. This also applies to safety-related functions and systems. When using these functions and systems, the applicable laws and regulations must be observed.

Speed Limit Info

Speed Limit Info

Concept

Speed Limit Info shows the current valid maximum speed in the instrument cluster and the Head-up Display.

General information

The camera in the area of the interior mirror detects traffic signs at the edge of the road as well as variable overhead sign posts.

Traffic signs with extra symbols

are considered and compared with the vehicle's onboard data. The traffic sign will then be either displayed or ignored depending on the situation in the instrument cluster and the Head-up Display.

The system takes into account any information that is stored in the navigation system and also displays speed limits present on routes without signs.

Safety information

⚠ WARNING

The system cannot serve as a substitute for the driver's personal judgment in assessing the traffic situation. Based on the limits of the system, it cannot independently react to all traffic situations. There is a risk of accident, injury, and property damage. Adjust driving style to traffic conditions. Watch the surrounding traffic situation closely, be ready to take over steering and braking at any time, and actively intervene where appropriate.

Overview

Sensors

The system is controlled by the following sensors:

- Cameras behind the windshield.

Additional information:
Sensors of the vehicle, refer to page 42.

Displaying Speed Limit Info

General information

Depending on the vehicle equipment, Speed Limit Info is displayed permanently in the instrument cluster or via Toyota Supra Command.

Display via Toyota Supra Command

- 1 "My vehicle"
- 2 "System settings"
- 3 "Displays"
- 4 "Instrument panel"
- 5 "Road signs"

Display

Speed Limit Info

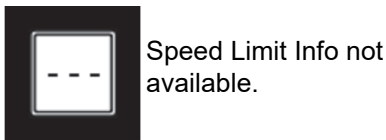

Warning signals

Depending on the settings, an acoustic signal sounds if the

detected speed limit is exceeded or the speed limit changes. The display also flashes if the detected speed limit is exceeded.

Settings

Via Toyota Supra Command:

- 1 "My vehicle"
- 2 "System settings"
- 3 "Displays"
- 4 "Instrument panel"
- 5 Select desired setting:
 - "Warn when speeding": activating/deactivating the flashing of the Speed Limit Info display in the instrument cluster and Head-up Display when the currently valid speed limit is exceeded.
 - "Excess speed display": the speed limit that is detected by the Speed Limit Info is displayed with a marking in the speedometer in the instrument cluster.

System limits

System limits of the sensors

Additional information:

- Cameras, refer to page 42.

Functional limitations

The system may not be fully

functional and may provide incorrect information in the following situations:

- When signs are fully or partially concealed by objects, stickers or paint.
- When driving very close to the vehicle in front of you.
- If the speed limits or road data stored in the navigation system are incorrect.
- If the speed limits vary with the time of day and the day of the week.
- In areas not covered by the navigation system.
- When roads differ from the navigation, such as due to changes in road routing.
- In case of electronic traffic signs.
- When passing buses or trucks with traffic signs applied to them.
- If the traffic signs are non-conforming.
- When signs that are valid for a parallel road are detected.
- In the presence of country-specific signs and road configurations.

Cruise control*

*: if equipped

Concept

Using this system, a desired speed can be adjusted using the buttons on the steering wheel. The system maintains the desired speed. The system accelerates and brakes automatically as needed.

General information

The system can be activated starting at 20 mph/30 km/h. Depending on the vehicle settings, the characteristics of the Cruise Control may change.

Safety information

⚠ WARNING

The system cannot serve as a substitute for the driver's personal judgment in assessing the traffic situation. Based on the limits of the system, it cannot independently react to all traffic situations. There is a risk of accident, injury, and property damage. Adjust driving style to traffic conditions. Watch the surrounding traffic situation closely, be ready to take over steering and braking at any time, and actively intervene where appropriate.

⚠ WARNING

The use of the system can lead to an increased risk of accidents in the following situations, for instance:

- On winding roads.

- In heavy traffic.
- On slippery roads, in fog, snow, or wet conditions, or on a loose road surface.



There is a risk of accident, injury, and property damage. Only use the system if driving at constant speed is possible.



⚠ WARNING

The set speed can be incorrectly adjusted or called up by mistake. There is a risk of accident, injury, and property damage. Adjust the set speed to the traffic conditions. Watch surrounding traffic closely and actively intervene where appropriate

Overview

Buttons on the steering wheel

Button	Function
	Cruise control on/off, refer to page 210.
	Press the button with the system interrupted: Continue cruise control with the last setting, refer to page 211.
	When active, press the button: Pause cruise control, refer to page 210.

Button	Function
	Store current speed.
Rocker switch:	
	Set speed, refer to page 210.

Switching cruise control on/off

Switching on

 Press the button on the steering wheel.

The indicator will come on. Cruise control is active. The current speed is maintained and stored as desired speed. VSC Vehicle Stability Control System is switched on, if necessary.

Switching off

 Press the button on the steering wheel.

The displays go out. The stored desired speed is deleted.

Pausing cruise control

Interrupting manually

 When active, press the button.

Interrupting automatically

The system is automatically interrupted in the following situations, for example:

- When braking manually.
- Manual transmission: the clutch pedal is depressed for a few seconds or released while a gear is not engaged.
- Manual transmission: if the gear engaged is too high for the current speed.
- Automatic transmission: selector lever position D is disengaged.
- Traction mode is activated or VSC Vehicle Stability Control System is deactivated.
- If VSC Vehicle Stability Control System intervenes.

Setting the speed

Maintaining and storing the speed

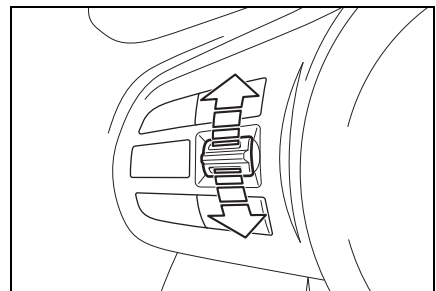

Press the rocker switch up or down once while the system is interrupted.

When the system is switched on, the current speed is maintained and stored as the desired speed.

The stored speed is displayed, refer to page 212, on the speedometer.

VSC Vehicle Stability Control System is switched on, if necessary.

The speed can also be stored by pressing a button.

SET Press the button.

Changing the speed

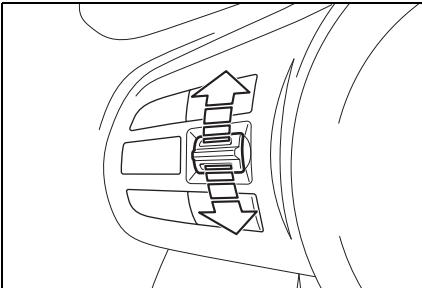

Press the rocker switch up or down repeatedly until the desired speed is set.

If active, the displayed speed is stored and the vehicle reaches the stored speed when the road is clear.

- Each time the rocker switch is pressed to the resistance point, the desired speed increases or decreases by 1 mph/1 km/h.
- Each time the rocker switch is

pressed past the resistance point, the desired speed changes by a maximum of 5 mph/10 km/h.

The maximum speed that can be set depends on the vehicle.

- Pressing the rocker switch to the resistance point and holding it accelerates or decelerates the vehicle without requiring pressure on the accelerator pedal.

After the rocker switch is released, the vehicle maintains its final speed. Pressing the switch beyond the resistance point causes the vehicle to accelerate more rapidly.

Continuing cruise control

! WARNING

The set speed can be incorrectly adjusted or called up by mistake. There is a risk of accident, injury, and property damage. Adjust the set speed to the traffic conditions. Watch surrounding traffic closely and actively intervene where appropriate

An interrupted cruise control can be continued by calling up the stored speed.

The difference between the current speed and the stored speed should be as little as possible.

RES CNCL Press the button with the system interrupted.

Cruise control is continued with the stored values.

In the following cases, the

stored speed value is deleted and cannot be called up again:

- When the system is switched off.
- When drive-ready state is switched off.

Displays in the instrument cluster

Indicator light



- Indicator light green: system is active.
- Gray indicator light: the system has been interrupted.
- No indicator light: system is switched off.

Status display

With the proper equipment, the value of the selected speed is briefly displayed digitally.

Displays in the Head-up Display

Some system information can also be displayed in the Head-up Display.



The symbol is displayed when the set desired speed is reached.

System limits

The desired speed is also maintained downhill.

The speed may not be maintained on uphill grades if the engine power is insufficient.

Do not use Cruise Control when towing.

Dynamic radar cruise control with full-speed range*

*: if equipped

Concept

Using this system, a desired speed and a distance to a vehicle ahead can be adjusted using the buttons on the steering wheel.

The system maintains the desired speed on clear roads. For this purpose, the vehicle accelerates or brakes automatically.

If a vehicle is driving ahead of you, the system adjusts the speed of your vehicle so that the set distance to the vehicle ahead is maintained. The speed is adjusted as far as the given situation allows.

General information

Depending on the vehicle settings, the characteristics of the Cruise Control may change.

The distance can be adjusted in several steps. For safety rea-

sons, it depends on the respective speed.

If the vehicle ahead of you brakes to a halt, and then proceeds to drive again within a brief period, the system is able to detect this within the given system limits.

Safety information

⚠ WARNING

The system cannot serve as a substitute for the driver's personal judgment in assessing the traffic situation. Based on the limits of the system, it cannot independently react to all traffic situations. There is a risk of accident, injury, and property damage. Adjust driving style to traffic conditions. Watch the surrounding traffic situation closely, be ready to take over steering and braking at any time, and actively intervene where appropriate.

⚠ WARNING

An unsecured vehicle can begin to move and possibly roll away. There is a risk of accident, injury, and property damage. Before leaving the vehicle, secure the vehicle against rolling away.

In order to ensure that the vehicle is secured against rolling away, follow the following:

- Set the parking brake.
- Automatic transmission: Make sure that selector lever position P is engaged.

- Manual transmission: Make sure that first gear is engaged on uphill gradients and reverse gear on downhill gradients.
- On uphill grades or on a downhill slope, turn the front wheels in the direction of the curb.
- On uphill grades or on a downhill slope, also secure the vehicle, for instance with a wheel chock.

⚠ WARNING

The set speed can be incorrectly adjusted or called up by mistake. There is a risk of accident, injury, and property damage. Adjust the set speed to the traffic conditions. Watch surrounding traffic closely and actively intervene where appropriate.

⚠ WARNING

Risk of accident due to too high speed differences to other vehicles, for instance in the following situations:







- When fast approaching a slowly moving vehicle.

There is a risk of injuries and danger to life. Watch traffic closely and actively intervene where appropriate.

- Vehicle suddenly swerving into own lane.
- When fast approaching standing vehicles.

Overview

Buttons on the steering wheel

Button	Function
	Cruise control on/off, refer to page 214.
	Store current speed.
	When active, press the button: Pause cruise control, refer to page 215. Press the button with the system interrupted: Continue cruise control with the last setting, refer to page 217.
	Increase distance, refer to page 216. Switch distance control on/off.
	Reduce distance, refer to page 216. Switch distance control on/off.
	Rocker switch: Set speed, refer to page 215.

Sensors

The system is controlled by the following sensors:

- Cameras behind the windshield.

- Front radar sensor.

Additional information:

Sensors of the vehicle, refer to page 42.

Area of application

The system is best used on well-constructed roads.

The system is functional at speeds beginning at approx. 20 mph/30 km/h.

The maximum speed that can be set is limited and, e.g., depends on the vehicle and the vehicle equipment version.

The system can also be activated when stationary.

Do not use Cruise Control and Distance Control when towing.

Switching on/off and interrupting cruise control

Switching on



Press the button on the steering wheel.

The indicator will come on.

Cruise control is active. The current speed is maintained and stored as desired speed.

VSC Vehicle Stability Control System is switched on, if necessary.

Switching off

To switch off the system while standing, step on brake pedal at the same time.

Press the following button on the steering wheel again:



Button on the steering wheel.

The displays go out. The stored desired speed is deleted.

Interrupting manually

When active, press the following button on the steering wheel:



Button on the steering wheel.

If interrupting the system while stationary, press on the brake pedal at the same time.

Interrupting automatically

The system is automatically interrupted in the following situations:

- When braking manually.
- Selector lever position D is disengaged.
- Traction mode is activated or VSC Vehicle Stability Control System is deactivated.
- If VSC Vehicle Stability Control System intervenes.
- If the safety belt is unbuckled and the driver's door is opened while the vehicle is

standing still.

- If the system has not detected objects for an extended period, for instance on a road with very little traffic without curb or shoulder markings.
- If the detection range of the radar is impaired, for instance by dirt or heavy fog.
- After a longer stationary period when the vehicle has been braked to a stop by the system.

Setting the speed

Maintaining and storing the speed

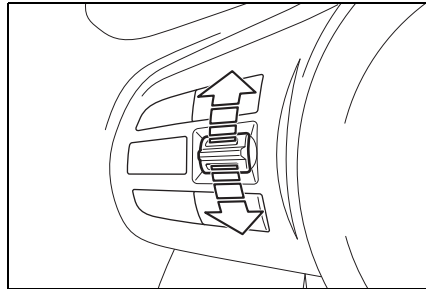

Press the rocker switch up or down once while the system is interrupted. The system will be activated.

The current speed is maintained and stored as desired speed.

The stored speed is displayed on the speedometer.

VSC Vehicle Stability Control System is switched on, if necessary.

The speed can also be stored by pressing a button.

SET Press the button.

Changing the speed

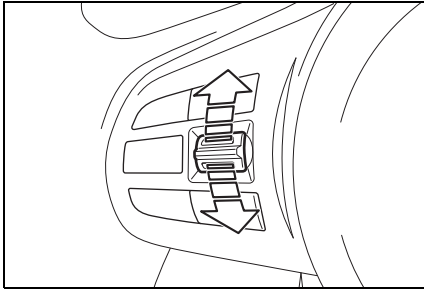

Press the rocker switch up or down repeatedly until the desired speed is set.

If active, the displayed speed is stored and the vehicle reaches the stored speed when the road is clear.

- Each time the rocker switch is pressed to the resistance point, the desired speed increases or decreases by 1 mph/1 km/h.
- Each time the rocker switch is pressed past the resistance point, the desired speed changes by a maximum of 5 mph/10 km/h.

Hold the rocker switch in position to repeat the action.

Adjusting distance

Safety information

WARNING

The system cannot serve as a substitute for the driver's personal judgment. Due to the system limits, braking can be late. There is a risk of accident, injury, and property damage. Be aware to the traffic situation at all times. Adjust the distance to the traffic and weather conditions and maintain the prescribed safety distance, possibly by braking.

Reduce distance



Press the button repeatedly until the desired distance is set.

Instrument cluster will display selected distance, refer to page 217.

Increase distance



Press the button repeatedly until the desired distance is set.

Instrument cluster will display selected distance, refer to page 217.

Continuing cruise control

⚠ WARNING

The set speed can be incorrectly adjusted or called up by mistake. There is a risk of accident, injury, and property damage. Adjust the set speed to the traffic conditions. Watch surrounding traffic closely and actively intervene where appropriate

An interrupted cruise control can be continued by calling up the stored speed.

The difference between the current speed and the stored speed should be as little as possible.



Press the button to resume system operation when it is canceled.

Cruise control is continued with the stored values.

In the following cases, the stored speed value is deleted and cannot be called up again:

- When the system is switched off.
- When drive-ready state is switched off.

Displays in the instrument cluster

Status display



The selected desired speed will be displayed.

Distance to vehicle ahead of you

Selected distance to the vehicle ahead of you is shown.

Symbol	Description
	Distance 1
	Distance 2
	Distance 3
	Distance 4 This value is set automatically after the system is switched on.
	System interrupted.
	No distance control display, as the accelerator pedal is being pressed.



Detected vehicle

Symbol	Description
	Green symbol: A vehicle has been detected ahead of you. The system maintains the set distance to the vehicle in front.

As soon as the detected vehicle drives off, the vehicle symbol in the distance indicator will move away.

To accelerate, activate ACC, for instance by briefly stepping on the accelerator pedal or pressing the rocker switch.

Indicator/warning lights

Symbol	Description
	Indicator light green: system is active.
	No indicator light: system is switched off.
	Vehicle symbol flashes: The conditions are not adequate for the system to work.
	The system was deactivated but applies the brakes until you actively resume control by pressing on the brake pedal or accelerator pedal.
	The vehicle symbol and distance bars flash red and an acoustic signal sounds: Brake and make an evasive maneuver, if necessary.

Displays in the Head-up Display

Desired speed

Some system information can also be displayed in the Head-up Display.



The symbol is displayed when the set desired speed is reached.

Distance information



The symbol is displayed when the distance from the vehicle traveling ahead is too short.

The distance information is active in the following situations:

- Dynamic radar cruise control switched off.
- Display in the Head-up Display selected, refer to page 156.
- Distance too short.
- Speed greater than approx. 40 mph/70 km/h.

System limits

System limits of the sensors

Additional information:

- Cameras, refer to page 42.
- Radar sensors, refer to page 43.

Detection range

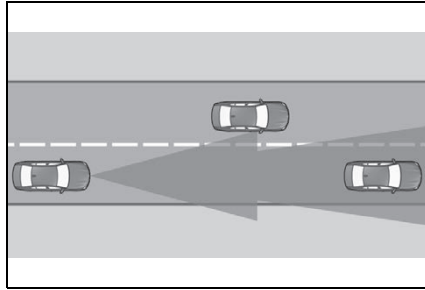

The detection capacity of the system and the automatic braking capacity are limited.

Two-wheeled vehicles for instance might not be detected.

Deceleration

The system does not decelerate in the following situations:

- For pedestrians or similarly slow-moving road users.
- For red traffic lights.
- For cross traffic.
- For oncoming traffic.

Swerving vehicles

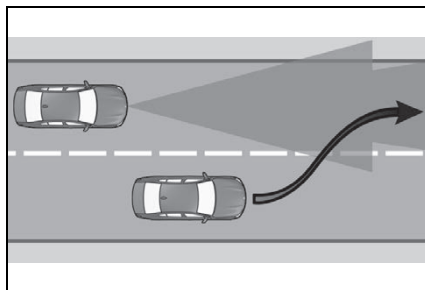

If a vehicle driving ahead of you suddenly swerves into your

lane, the system may not be able to automatically restore the selected distance. It may not be possible to restore the selected distance in certain situations, including if you are driving significantly faster than vehicles driving ahead of you, for instance when rapidly approaching a truck. When a vehicle driving ahead of you is reliably detected, the system requests that the driver intervene by braking and carrying out evasive maneuvers, if needed.

Cornering

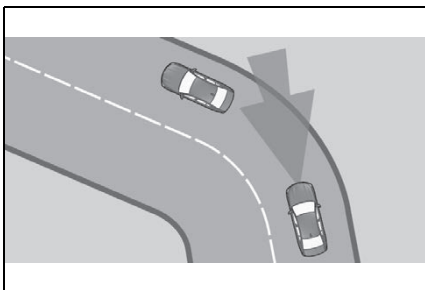

When the desired speed is too high for a curve, the speed is reduced slightly. Because curves may not be anticipated in advance, drive into a curve at an appropriate speed.

The system has a limited detection range. Situations can arise in tight curves where a vehicle driving ahead will not be detected or will be detected very late.

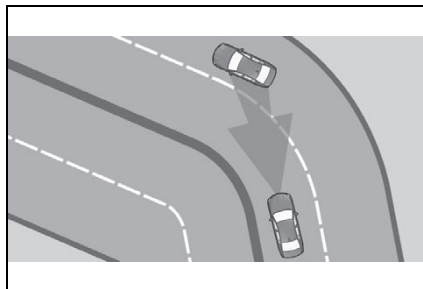

When you approach a curve the system may briefly report vehicles in the next lane due to the bend of the curve. If the system decelerates you may compensate it by briefly accelerating. After releasing the accelerator pedal the system is reactivated and controls speed independently.

Driving off

In some situations, the vehicle cannot drive off automatically; for example:

- On steep uphill grades.
- From bumps in the road.

In these cases, step on the accelerator pedal.

Weather

The following restrictions can occur under unfavorable weather or light conditions:

- Poorer vehicle recognition.
- Short-term interruptions for vehicles that are already recognized.

Drive attentively, and react to the current traffic situation. If necessary, intervene actively, for instance by braking, steering or evading.

Engine power

The desired speed is also maintained downhill. The speed may not be maintained on uphill grades if the engine power is insufficient.

Speed Limit Assist

Concept

When the systems in the vehicle e.g., Speed Limit Info, detect a change of the speed limit along the route, this new speed value can be applied for the following systems:

- Manual Speed Limiter.
- Cruise Control.
- Dynamic radar cruise control with full-speed range.

The speed value is suggested as the new desired speed to be applied. To apply the speed value, the corresponding system must be activated.

Safety information

! WARNING

The system cannot serve as a substitute for the driver's personal judgment in assessing the traffic situation. Based on the limits of the system, it cannot independently react to all traffic situations. There is a risk of accident, injury, and property damage. Adjust driving style to traffic conditions. Watch the surrounding traffic situation closely, be ready to take over steering and braking at any time, and actively intervene where appropriate.

! WARNING

The set speed can be incorrectly adjusted or called up by mistake. There is a risk of accident, injury, and property damage. Adjust the set speed to the traffic conditions. Watch surrounding traffic closely and actively intervene where appropriate

Overview

Buttons on the steering wheel

Button	Function
SET	Apply suggested speed manually.

Switching on/off and adjusting

- Via Toyota Supra Command:
- 1 "My vehicle"
 - 2 "Vehicle settings"

- 3 "Speed Assistant"
- 4 "Notes on speed limits"

Select the desired setting:

- "adjust manually": detected speed limit can be applied manually.
- "Show current limit": detected speed limits are displayed in the instrument cluster without being applied.
- "Off": Speed Limit Assist will be switched off.

Displays in the instrument cluster

A message is indicated in the instrument cluster when the system and cruise control are activated.

Symbol	Function
ASSIST	Indicator light illuminates green, together with the symbol for a cruise control system: Speed Limit Assist is active and detected speed limits can be applied manually for the displayed system.

Symbol	Function
	Detected change of a speed limit with immediate effect.
SET	Indicator light illuminates green: the detected speed limit can be applied with the SET button. As soon as the speed limit has been applied, a green checkmark is displayed.

Taking over the suggested speed

 As soon as the SET icon lights up, press the button.

Setting the speed adjustment

It is possible to set whether the speed limit will be accepted exactly, or with a tolerance.

Via Toyota Supra Command:

- 1 "My vehicle"
- 2 "Vehicle settings"
- 3 "Speed Assistant"
- 4 "Adjust speed limits"
- 5 Confirm the desired setting.

System limits

Speed Limit Assist is based on the Speed Limit Info system.

Thus, also observe the system limits of the Speed Limit Info

system, refer to page 206

Parking Sensors

Concept

Parking Sensor is a support when parking. Objects that you are approaching slowly in front of or behind the vehicle are indicated by signal tones and a display on the Control Display.

Depending on the equipment version: Obstacles at the side of the vehicle that are detected by the side ultrasonic sensors may also be reported by the side protection, refer to page 226, function.

General information

The ultrasound sensors for distance measurements are located in the bumpers and possibly on the sides of the vehicle.

The range, depending on the obstacle and environmental conditions, is approx. 6 ft/2 m.

An acoustic warning sounds in case of an impending collision at a distance to the object of approx. 27 in/70 cm.

For objects behind the vehicle, the acoustic warning is already issued at a distance to the object of approx. 5 ft/1.50 m.

Safety information

! WARNING

The system cannot serve as a substitute for the driver's personal judgment in assessing the traffic situation. Based on the limits of the system, it cannot independently react to all traffic situations. There is a risk of accident, injury and property damage. Adjust driving style to traffic conditions. Check surrounding traffic and vehicle's surroundings closely and actively intervene where appropriate.

! WARNING

Due to high speeds when Parking Sensors is activated, the warning can be delayed due to physical circumstances. There is a risk of injury and risk of damage to property. Avoid approaching an object too fast. Avoid driving off fast while Parking Sensors is not yet active.

Overview

Button in the vehicle

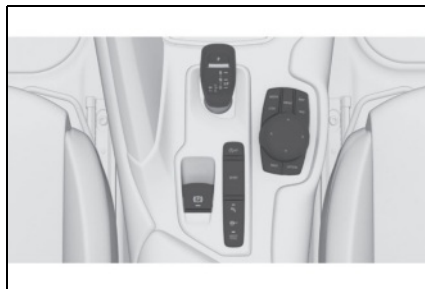

Park assistance button

Sensors

The system is controlled using the following sensors:

- Ultrasonic sensors in the bumpers.

Additional information:
Sensors of the vehicle, refer to page 42.

Switching on/off

Switching on automatically

The system switches on automatically in the following situations:

- If selector lever position R is engaged when the engine is running.
- Depending on the equipment version: while approaching detected obstacles if the speed is slower than approx. 2.5 mph/4 km/h. The activation distance depends on the situation in question.

You may switch automatic activation when obstacles are detected on and off.

Via Toyota Supra Command:

- 1 "My vehicle"
- 2 "Vehicle settings"
- 3 "Parking"
- 4 Where applicable: "Automatic Parking Sens. activation"

- 5 "Automatic Parking Sensors activ."

Depending on equipment, an additional camera view is also switched on.

Automatic deactivation during forward travel

The system switches off when a certain driving distance or speed is exceeded.

Switch the system back on, if needed.

Switching on/off manually



Press the park assistance button.

- On: the LED lights up.
- Off: the LED goes out.

The rearview camera image is displayed if the reverse gear is engaged when pressing the park assistance button.

Depending on the equipment version, the system cannot be switched off manually if the reverse gear is engaged.

WARNING

Signal tones

■ General information

An intermittent tone indicates when the vehicle is approaching an object. For instance, if an

object is detected to the left rear of the vehicle, a signal tone sounds from the left rear speaker.

The shorter the distance to the object, the shorter the intervals.

If the distance to a detected object is less than approx. 8 in/20 cm, a continuous tone is sounded.

If there are objects in front of and behind the vehicle at the same time, with a distance smaller than approx. 8 in/20 cm, an alternating constant tone will sound.

Automatic transmission: the intermittent tone and constant tone are switched off if the selector lever position P is engaged.

The intermittent tone is switched off after a short time when the vehicle is stationary.

If an object approaches when the vehicle is stationary, the acoustic signal is reactivated.

■ Volume

The Parking Sensor signal tone volume can be adjusted.

Via Toyota Supra Command:

- 1 "My vehicle"
- 2 "System settings"
- 3 "Tone"
- 4 "Volume settings"
- 5 "Parking Sens."

- 6 Set the desired value.

Visual warning



The approach of the vehicle to an object is shown on the Control Display. Objects that are farther away are already displayed on the Control Display before a signal sounds.

The display appears as soon as Parking Sensor is activated.

The range of the sensors is represented in the colors green, yellow and red when obstacles are detected.

Pathway lines are faded in for better estimation of the required space.

When the image of the rearview camera is displayed, the switch can be made to Parking Sensor or to a different view with obstacle markings as needed:

- 1 Press the Controller to the left, if needed.
- 2 E. g. "Park. sensors only"

RCTA (Rear cross traffic alert) function, refer to page 232: depending on the equipment, it

is warned in the Parking Sensor display against vehicles approaching in the front or rear from the side.

Depending on the equipment version: emergency brake function, Parking Sensors with emergency braking function

Concept

The emergency braking function of Parking Sensor initiates an emergency braking in case of acute risk of collision.

General information

Due to system limits, a collision cannot be prevented under all circumstances.

The function is available from walking speed while backing up or rolling backward.

A press of the accelerator pedal interrupts the braking intervention.

After emergency braking to a stop, further creeping toward an obstacle is possible. To creep toward the obstacle, lightly press the accelerator pedal and release it again.

If the accelerator pedal is heavily depressed, the vehicle drives off as usual. Manual braking is possible at any time.

The system uses the ultrasound sensors of Parking Sensor and parking assistant.

Safety information

! WARNING

The system cannot serve as a substitute for the driver's personal judgment in assessing the traffic situation. Based on the limits of the system, it cannot independently react to all traffic situations. There is a risk of accident, injury and property damage. Adjust driving style to traffic conditions. Check surrounding traffic and vehicle's surroundings closely and actively intervene where appropriate.

Activating/deactivating the system

Via Toyota Supra Command:

- 1 "My vehicle"
- 2 "Vehicle settings"
- 3 "Parking"
- 4 "Park. Sens. w. em. braking funct."
- 5 "Park. Sens. w. em. braking funct."

Side parking aid

Concept

The system warns of obstacles on the side of the vehicle.

General information

The system uses the ultrasound sensors of Parking Sensor and parking assistant.

Safety information

WARNING

The system cannot serve as a substitute for the driver's personal judgment in assessing the traffic situation. Based on the limits of the system, it cannot independently react to all traffic situations. There is a risk of accident, injury and property damage. Adjust driving style to traffic conditions. Check surrounding traffic and vehicle's surroundings closely and actively intervene where appropriate.

Display

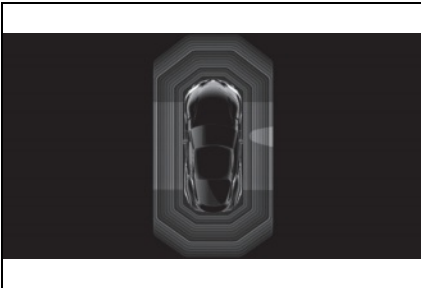

To protect the sides of the vehicle, obstacle markings are displayed on the sides of the vehicle.

- Color markings: warning against detected obstacles.
- Gray markings, hatched area: no obstacles were detected.
- No markings, black area: the

area next to the vehicle was not yet captured.

Limits of side parking aid

The system only displays stationary obstacles that were previously detected by sensors while passing them.

The system does not detect whether an obstacle moves later on. If the vehicle is stationary, the markings are shown in black after a certain time. The area next to the vehicle must be newly captured.

System limits

Safety information

WARNING

Because of system limitations, this system may either not respond, or respond too late, incorrectly, or without cause. There is a risk of accident, injury, or property damage. Actively intervene as warranted. Refer to the information in this Owner's Manual regarding the scope of the system's operation and limitations.

System limits of the sensors

Additional information:

- Ultrasonic sensors, refer to page 42.

Limits of ultrasonic measurement

The detection of objects with ultrasonic measurements can run into physical limits, e.g., in the following situations:

- With obstacles and persons at the edge of the lane.
- Low objects already displayed, for instance curbs, can move into the blind area of the sensors before or after a continuous tone sounds.

False warnings

Reaching the system limits can cause false warnings.

To prevent false alarms, switch off Automatic Park Sensors activ. on obstacle detection, refer to page 229, for instance in automatic vehicle washes.

Malfunction

A vehicle message is displayed.



White symbol is displayed, and the range of the sensors is dimmed on the Control Display.

Parking Sensor may not be operational. Have the system checked by your Toyota dealer.

Rearview camera

Concept

The rearview camera provides assistance in parking and maneuvering backwards. The area behind the vehicle is shown on the Control Display.

Additionally, assistance functions can be shown in the display, e.g., help lines.

Safety information

! WARNING

The system cannot serve as a substitute for the driver's personal judgment in assessing the traffic situation. Based on the limits of the system, it cannot independently react to all traffic situations. There is a risk of accident, injury and property damage. Adjust driving style to traffic conditions. Check surrounding traffic and vehicle's surroundings closely and actively intervene where appropriate.

Overview

Depending on the vehicle equipment: button in the vehicle



Park assistance button

Sensors

The system is controlled by the following sensors:

- Rearview camera.

Additional information:

Sensors of the vehicle, refer to page 42.

Switching on/off

Switching on automatically

The system is switched on automatically if selector lever position R is engaged when the engine is running.

Automatic deactivation during forward travel

The system switches off when a certain driving distance or speed

is exceeded.

Switch the system back on, if needed.

Depending on the vehicle equipment: switching on/off manually



Press the park assistance button.

- On: the LED lights up.
- Off: the LED goes out.

The parking assistance functions are shown on the Control Display.

Switching the view via Toyota Supra Command

If the rearview camera view is not displayed, change the view via Toyota Supra Command:

- 1 If necessary, tilt the controller to the side.
- 2  "Rear view camera"

The rearview camera image is displayed.

Functional requirements

- The rearview camera is switched on.
- Keep the recording range of the camera clear. Protruding cargo or roof rack systems can limit the detection range of the camera.

Display on the Control Display

General information

More than one assistance function can be active at the same time.

The assistance functions can be manually activated.

- 1 Move the Controller to the right, if needed.
- 2 With corresponding equipment:
- 3 With corresponding equipment:  "Camera image"

-  "Parking aid lines".

Pathway lines and turning radius lines are displayed, refer to page 230.

-  "Obstacle marking".

Depending on the vehicle equipment, the obstacles detected by Parking Sensors are displayed, refer to page 231, by markings.

Parking aid lines

■ Pathway lines

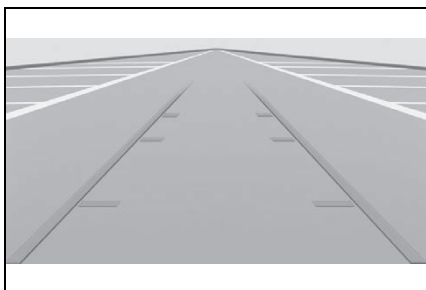

Pathway lines help you to estimate the space required when parking and maneuvering on level roads.

Pathway lines depend on the steering angle and are continuously adjusted to the steering wheel movements.

■ Turning radius lines

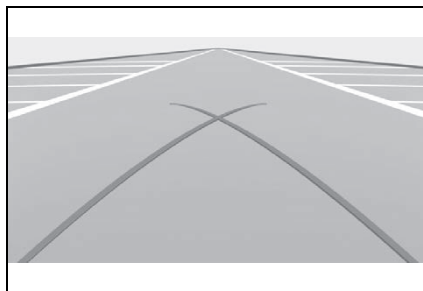

Turning radius lines can only be superimposed on the camera image together with pathway lines.

Turning radius lines show the course of the smallest possible turning radius on a level road.

Only one turning radius line is displayed after the steering wheel is turned past a certain angle.

■ Parking using pathway and turning radius lines

- 1 Position the vehicle so that the red turning radius line leads to within the limits of the parking space.
- 2 Turn the steering wheel to the point where the green pathway line covers the cor-

responding turning radius line.

Obstacle marking

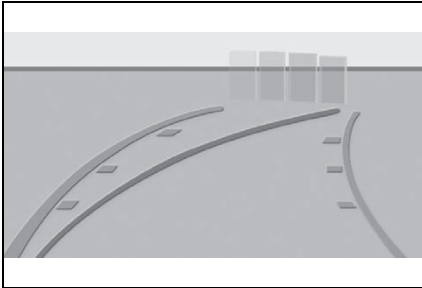

Depending on the vehicle equipment, obstacles behind the vehicle are detected by the Parking Sensors.

Obstacle markings can be faded into the image of the rearview camera.

The colored thresholds of the obstacle markings match the markings of the Parking Sensors.

Setting brightness and contrast via Toyota Supra Command

With the rearview camera switched on:

- 1 Move the Controller to the left, if needed.
- 2 "Camera image"
- 3
- "Brightness"
- "Contrast"

- 4 Set the desired value.

System limits

System limits of the sensors

Additional information:

- Cameras, refer to page 42.

Deactivated camera

If the camera is deactivated, for instance if the trunk lid is open, the camera image is displayed hatched in gray.

Detection of objects

Very low obstacles as well as high, protruding objects such as ledges may not be detected by the system.

Depending on the vehicle equipment, some assistance functions also consider data from the Parking Sensors.

Follow the notes in the Parking Sensors chapter.

The objects displayed on the Control Display may be closer than they appear. Do not estimate the distance from the objects on the display.

RCTA (Rear cross traffic alert) function*

*: if equipped

Concept

At blind driveways or when driving out of diagonal parking spaces, approaching cross traffic is detected sooner by the system than is possible from the driver's seat.

General information

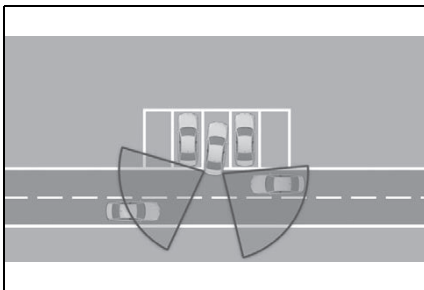

Two radar sensors in the rear bumper monitor the area behind the vehicle.

The system indicates approaching traffic.

Safety information

WARNING

The system cannot serve as a substitute for the driver's personal judgment in assessing the traffic situation. Based on the limits of the system, it cannot independently react to all traffic situations. There is a risk of accident, injury, and property damage. Adjust driving style to traffic conditions. Watch the surrounding traffic situation closely, be ready to take over steering and braking at any time, and actively intervene where appropriate.

Overview

Button in the vehicle



Park assistance button

Sensors

The system is controlled by the following sensors:



- Radar sensors, side, rear.

Additional information:

Sensors of the vehicle, refer to page 42.

Switching on/off

Activating/deactivating the system

- 1  Press park assistance button.
- 2 Move the Controller to the left.
- 3  "Settings"
- 4 "Cross traffic alert"
- 5 "Cross traffic alert"

Or via Toyota Supra Command:

- 1 "My vehicle"
- 2 "Vehicle settings"
- 3 "Parking"
- 4 "Cross traffic alert"
- 5 "Cross traffic alert"

Switching on automatically

If the system was activated on the Control Display, it is automatically switched on as soon as Parking Sensors or Panorama View is active and a gear is engaged.

If reverse gear is engaged, the rear system is switched on.

Switching off automatically

The system is automatically switched off in the following situations:

- When the speed exceeds

walking speed.

- When a certain driving distance is exceeded.
- With an active parking operation of the parking assistant.

WARNING

General information

The Control Display shows the corresponding view, an acoustic signal may sound as necessary, and the warning light in the exterior mirror flashes.

Warning light in exterior mirror

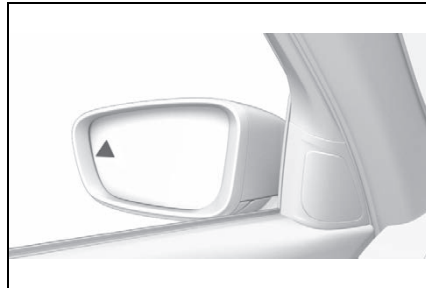

The warning light in the exterior mirror flashes if the rear sensors detect other vehicles when the vehicle is reversing.

Display in the Parking Sensors view

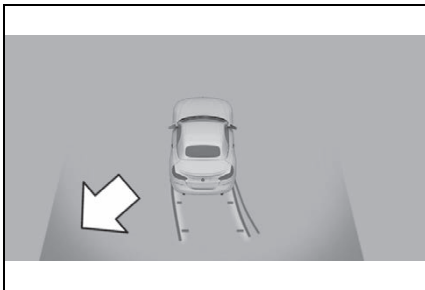

In the Parking Sensors view, the respective boundary area flashes red, if vehicles are detected by the sensors.

Acoustic warning

In addition to the optical indicator, a warning signal sounds if your own vehicle moves into the respective direction.

System limits

System limits of the sensors

Additional information:

- Radar sensors, refer to page 42.

Functional limitations

The system may not be fully functional in the following situations:

- In tight curves.
- When crossing objects move at a very slow or a very fast speed.
- If other objects are in the capture range of the sensors, that hide cross traffic.

Driving comfort

Vehicle features and options

This chapter describes all standard, country-specific and optional features offered with the series. It also describes features and functions that are not necessarily available in your vehicle, e.g., due to the selected options or country versions. This also applies to safety-related functions and systems. When using these functions and systems, the applicable laws and regulations must be observed.

Chassis components

The chassis components are optimized for the vehicle and its scope of application and thereby ensure the best possible Driving Dynamics.

Adaptive variable suspension*

*: if equipped

Principle

The Adaptive variable suspension is an intelligent, controllable sport chassis/suspension.

The suspension reduces body movements with a sporty driving style or on an uneven road.

General information

The intelligent control of the chassis increases the driving dynamics and driving comfort depending on the road condition and driving style.

Tuning

The system offers different shock absorber settings ranging from comfortable travel to sporty driving.

The shock absorbers are adjusted depending on the selected driving mode as well as the road condition and driving style.

Additional information:
Sport mode switch, refer to page 138.

Climate control

Vehicle features and options

This chapter describes all standard, country-specific and optional features offered with the series. It also describes features and functions that are not necessarily available in your vehicle, e.g., due to the selected options or country versions. This also applies to safety-related functions and systems. When using these functions and systems, the applicable laws and regulations must be observed.

Interior air quality

The air quality in the vehicle is improved by the following components:

- Emission tested car's interior.
- Microfilter.
- Air conditioning system to control the temperature, air flow and recirculated-air mode.
- Automatic recirculated-air control AUC.
- Parked-car ventilation.

Safety notes

⚠ WARNING

When using the air conditioning system, seat heaters, etc. for a long period of time, make sure that no body parts are kept near the air outlets or in direct contact with the seat, as doing so may lead to minor burns or chill burns. If you feel unusual while using the air conditioning system or seat heaters, stop use or change the setting immediately.

Air conditioning system refrigerant

- A label regarding the refrigerant of the air conditioning system is attached to the hood at the location shown in the following illustration.

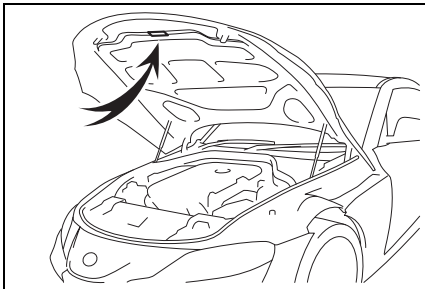

- The meaning of each symbol on the label are as follows:

	Caution
	Air conditioning system
	Air conditioning system lubricant type

	Requires registered technician to service air conditioning system
	Flammable refrigerant

⚠ NOTICE

■ **When repairing/replacing parts of the air conditioning system**

Have repair/replacement performed by your Toyota dealer. When a part of the air conditioning system, such as the evaporator, is to be replaced, it must be replaced with a new one.







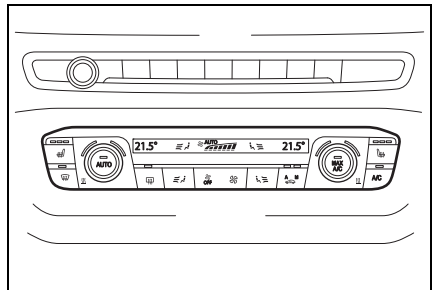

Automatic air conditioning



Overview

Buttons in the vehicle



Climate control functions

Button	Function
	Temperature, refer to page 237.
	Air-conditioning mode, refer to page 238.
	Maximum cooling, refer to page 238.
	AUTO program, refer to page 239.
	Recirculated-air mode, refer to page 239.
	Switch off, refer to page 237.
	Air distribution, manual, refer to page 240.
	Defrost and defog the windshield, refer to page 240.
	Rear window defroster, refer to page 241.

Button	Function
	Seat heating, refer to page 113.
	Air flow, manual, refer to page 240.

Switching on/off

Switching on

Press any button except for the following:

- Switching off.
- Rear window defroster.
- Seat heating.

Switching off

Complete system:



Press and hold the button.

Make sure that there is sufficient ventilation when staying in the vehicle for extended periods of time with the air conditioning system off, e.g., when sleeping.

Temperature

Concept

The automatic air conditioning achieves the set temperature as quickly as possible, if needed,

by using the maximum cooling or heating capacity, and then keeps it constant.

Adjusting



Turn the dial clockwise to increase the temperature and counterclockwise to decrease the temperature.



Via Toyota Supra Command:

- 1 "My Vehicle"
- 2 "Vehicle settings"
- 3 "Climate functions"
- 4 "Temperature adjustment, upper body"
- 5 Set the desired temperature.

Do not rapidly switch between different temperature settings. Otherwise, the automatic air conditioning will not have sufficient time to adjust the set temperature.

Air conditioning

Concept

The air in the car's interior will be cooled and dehumidified and, depending on the temperature setting, warmed again.

The car's interior can only be cooled with the drive-ready state switched on.

Switching on/off



Press the button.

Air conditioning is switched on with the engine running.

Depending on the weather, the windshield and side windows may fog up briefly when drive-ready state is switched on.

The air conditioning is switched on automatically with the AUTO program.

Condensation may form in the vehicle air-conditioning system. Condensation leaking under the vehicle is a technical problem and does not constitute a malfunction.

Maximum cooling

Concept

The system is set to the lowest temperature, optimum air flow and recirculated-air mode with the drive-ready state switched on.

General information

The function is available with external temperatures above approx. 32 °F/0 °C and with the drive-ready state switched on.

Switching on/off



Press the button.

The LED is illuminated with the system switched on.

Air flows out of the vents to the upper body region. The vents need to be open for this.

The air flow can be adjusted with the program active.

AUTO program

Concept

The AUTO program cools, ventilates or heats the car's interior automatically.

The air flow, air distribution and temperature will be controlled automatically depending on the interior temperature and the setting for the desired temperature.

Switching on/off



Press the button.

The LED is illuminated with the AUTO program switched on.

Depending on the selected temperature and outside influences, the air is directed to the windshield, side windows, upper

body, and into the floor area.

The air conditioning, refer to page 238, is switched on automatically with the AUTO program.

The AUTO program is switched off automatically, when manual air distribution is set.

Recirculated-air mode

Concept

You may react to unpleasant odors or pollutants in the immediate environment by temporarily suspending the supply of outside air. The system then recirculates the air flow within the vehicle.

Operation



Press the button repeatedly to select an operating mode.

The LED is illuminated when the recirculated-air mode is switched on.

When the left LED is illuminated: Automatic recirculated air mode

If the pollution sensor detects pollutants in the outside air, the air mode is automatically changed from outside air mode to recirculated air mode.

When the right LED is illuminated: Recirculated air mode

The air in the cabin is continuously

recirculated.

To prevent window fogging, recirculated-air mode switches off automatically after a certain amount of time, depending on the environmental conditions.

With constant recirculated-air mode, the air quality in the car's interior deteriorates and the fogging of the windows increases.

If there is window condensation, switch off recirculated-air mode or defog the windows, refer to page 240.

Controlling the air flow manually

Concept

The air flow for climate control can be adjusted manually.

General information

To manually adjust air flow switch off AUTO program first.

Operation



Press the left or right side of the button: decrease or increase air flow.

The selected air flow is shown on the climate control display.

The air flow may be reduced automatically to save battery power.

Controlling the air distribution manually

Concept

The air distribution for climate control can be adjusted manually.

Operation



Press the button repeatedly to select a program:

- Windows, upper body region, and floor area (only on the driver's side).
- Upper body region and floor area.
- Floor area.
- Windows and floor area (only on the driver's side).
- Upper body region.

The selected air distribution is shown on the climate control display.

If there is window condensation, defog the windows, refer to page 240.

Defrost windshield and remove condensation

Concept

Ice and condensation are

quickly removed from the windshield and the front side windows.

Switching on/off



Press the button.

The LED is illuminated with the system switched on.

The air flow can be adjusted manually with the system switched on.



If there is any window condensation, press the button on the driver's side or switch on the air conditioning. Make sure that air can flow to the windshield.

Rear window defroster



Press the button. The LED lights up.

The function is available with the engine running.

The rear window defroster switches off automatically after a certain period of time.

Microfilter

The microfilter removes dust and pollen from the incoming air. Have this filter changed during vehicle maintenance, refer to page 312.

Ventilation

Concept

The air flow directions can be individually adjusted.

Adjusting the ventilation

General information

The air flow directions can be adjusted for direct or indirect ventilation.

Open the vents and position them to ensure effective climate control.

Direct ventilation

The air flow is directed towards the passengers. The air flow heats or cools noticeably, depending on the adjusted temperature.

Indirect ventilation

The air flow is not directed towards the passengers. The car's interior is warmed or cooled indirectly, depending on the set temperature.

Front ventilation

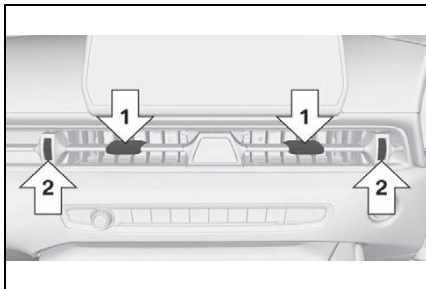

- Lever for changing the air flow direction, arrow 1.
- Thumbwheel for variable opening and closing of the vents, arrow 2.

Parked-car ventilation

Concept

The car's interior can be cooled or heated before driving off with the parked-car ventilation. Depending on set temperature and ambient temperature, the car's interior is ventilated or, depending on model variant, heated using the residual engine heat.

General information

The system can be switched on and off directly or via a preset departure time.

The activation time is determined based on the external temperature. The system promptly switches on before the

selected departure time.

Functional requirements

- The vehicle is in idle state or standby state and not in drive-ready state.
- Battery is sufficiently charged.

If parked-car ventilation is switched on, the vehicle battery will be discharged. Thus, limit the maximum activation time to save the vehicle battery. The system will be available again after the engine is started or after a short trip.

- Make sure that the vehicle's date and time are set correctly.
- Open the vents to allow air to flow out.

Switching on/off directly

General information

There are different ways to switch the system on or off.

The system switches off automatically after a certain period of time. The system continues to run for some time after being switched off.

Using the button

■ General information

When the vehicle is in standby state, the parked-car ventilation can be switched on or off via the

automatic air conditioning buttons.

■ **Switching on**

Press any button except:

- Rear window defroster.
- Lower air flow button side.
- Seat heating.
- Menu.

■ **Switching off**

The system switches off after leaving and locking the vehicle.



Press and hold the bottom button.

Via Toyota Supra Command

- 1 "My Vehicle"
- 2 "Vehicle settings"
- 3 "Climate functions"
- 4 "Comfort ventilation"
- 5 "Activate now"

Display

Symbol	Description
	Symbol on the automatic air conditioning indicates the system is switched on. REST is displayed on the automatic air conditioning. The residual engine heat is used.

Departure time

Concept

Different departure times can be adjusted to ensure a comfortable interior temperature in the vehicle at the time of departure.

- One-time departure time: the time can be set.

The system is switched on once.

- Departure time with weekday: time and day of the week can be set.

On the desired weekdays, the system will be switched on promptly before the set departure time.

The departure time is preselected in two steps:

- Set departure times.
- Activate departure times.

Parked-car ventilation at the departure time can only be activated once.

Allow for at least 10 minutes between setting/activating the departure time and departing at the planned time. This gives the air conditioning sufficient time to bring the vehicle interior to the desired temperature.

Setting the departure time

■ **Via Toyota Supra Command**

- 1 "My Vehicle"
- 2 "Vehicle settings"

- 3 "Climate functions"
- 4 "Comfort ventilation"
- 5 Select the desired departure time.
- 6 Set the departure time.
- 7 Select day of the week, if needed.

Activating the departure time

■ Functional requirement

If a departure time is to influence the switching on of parked-car ventilation, the respective departure time must be activated first.

■ Via Toyota Supra Command

- 1 "My Vehicle"
- 2 "Vehicle settings"
- 3 "Climate functions"
- 4 "Comfort ventilation"
- 5 "For departure time"
- 6 Activate the desired departure time.

Display

☞ The symbol on the automatic air conditioning signals an activated departure time.

Interior equipment

Vehicle features and options

This chapter describes all standard, country-specific and optional features offered with the series. It also describes features and functions that are not necessarily available in your vehicle, e.g., due to the selected options or country versions. This also applies to safety-related functions and systems. When using these functions and systems, the applicable laws and regulations must be observed.

Integrated Universal Remote Control

Concept

The integrated Universal Remote Control in the interior mirror can operate up to 3 functions of remote-controlled systems such as garage door drives, barriers, or lighting systems.

General information

The Integrated Universal Remote Control replaces up to 3 different hand-held transmitters. To operate the remote control, the buttons on the interior mirror must be programmed with the

desired functions. The hand-held transmitter for the particular system is required in order to program the remote control.

Before selling the vehicle, delete the stored functions for the sake of security.

If possible, do not install the antenna of the remote-controlled system, e.g. the garage door drive, near metal objects to ensure the best possible operation.

Safety information

WARNING

The operation of remote-controlled systems with the integrated universal remote control, such as the garage door, may result in injury, for example, body parts becoming jammed in a garage door. There is a risk of injury and risk of damage to property. Make sure that the area of movement of the respective system is clear during programming and operation. Also follow the safety information of the hand-held transmitter.

Compatibility



If this symbol is printed on the packaging or in the owner's manual of the system to be controlled, the system is generally compatible with the integrated Universal Remote Control.

Additional questions are answered by:

- Your Toyota dealer.
- www.homelink.com on the Internet.

HomeLink is a registered trademark of Gentex Corporation.

Control elements on the interior mirror

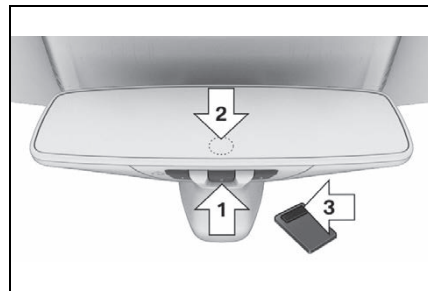

- Buttons, arrow **1**.
- LED, arrow **2**.
- The hand-held transmitter, arrow **3**, is required for programming.

Programming

General information

The battery of the hand-held transmitter must be fully charged at the time of programming to ensure an optimal range of the integrated universal remote control.

- 1** Switch on standby state.
- 2** Initial setup: Press and hold the two outer buttons on the

interior mirror simultaneously for approximately 10 seconds until the LED flashes green rapidly. This erases all programming of the buttons on the interior mirror.

- 3 Press the interior mirror button to be programmed. The LED on the interior mirror will slowly begin flashing orange.
- 4 Hold the hand-held transmitter for the system to be used approx. 1 to 12 in/2.5 to 30 cm away from the buttons on the interior mirror. The required distance depends on the hand-held transmitter.
- 5 Press and hold the button of the desired function on the hand-held transmitter.

Canada: if programming with the hand-held transmitter was interrupted, hold down the interior mirror button and repeatedly press and release the hand-held transmitter button for 2 seconds.

6

- The LED lights up green: programming completed.

Release the button.

- The LED flashes fast: programming is not complete.

Press the button on the interior mirror for 2 seconds and release. Perform this procedure three times to complete the programming procedure.

If the integrated universal remote control remains nonoperational, continue with the special features

for change code wireless systems.

- LED does not flash green after 60 seconds: programming not completed.

Repeat steps 3 to 6.

To program other functions on other buttons, repeat steps 3 to 5.

Special feature of the rolling code wireless system

If you are unable to operate the remote-controlled system after repeated programming, please check if the system to be controlled features a rolling code radio system.

Refer to the owner's manual for the system.

For systems with a rolling code radio system, the integrated Universal Remote Control and the system also have to be synchronized.

Please read the owner's manual to find out how to synchronize the system.

Synchronizing is easier with the aid of a second person.

Synchronizing the universal remote control with the system:

- 1 Park the vehicle within range of the remote-controlled system.
- 2 Program the relevant button on the interior mirror as described.

- 3 Locate and press the synchronizing button on the system being programmed, e.g. at the garage gate. You have approx. 30 seconds for the next step.
- 4 Hold down the programmed button on the interior mirror for approximately 3 seconds and then release it. If necessary, repeat this step up to three times in order to finish synchronization. Once synchronization is complete, the programmed function will be carried out.

Reprogramming individual buttons

- 1 Switch on standby state.
- 2 Press and hold the interior mirror button to be programmed.
- 3 As soon as the LED on the interior mirror flashes orange after approx. 20 seconds, release the button.
- 4 Hold the hand-held transmitter for the system to be used approx. 1 to 12 in/2.5 to 30 cm away from the buttons on the interior mirror. The required distance depends on the hand-held transmitter.
- 5 Press and hold the button of the desired function on the hand-held transmitter.

Canada: if programming with the

hand-held transmitter was interrupted, hold down the interior mirror button and repeatedly press and release the hand-held transmitter button for 2 seconds.

- 6 The LED can light up in different ways.
 - The LED lights up green: the programming procedure is completed.

Release the button.

- The LED flashes fast: the hand-held transmitter was detected but programming is not complete.

Press the button on the interior mirror for 2 seconds and release. Perform this procedure three times to complete the programming procedure.

If the universal remote control remains nonoperational, continue with the special features for change code wireless systems.

- LED does not flash green after 60 seconds: programming not completed.

Repeat steps 3 to 6.

If the programming procedure is not completed, the previous programming will remain unchanged.

Operation

 **WARNING**

The operation of remote-controlled systems with the integrated universal remote control, such as the garage door, may result in injury, for example, body parts becoming jammed in a garage door. There is a risk of injury and risk of damage to property. Make sure that the area of movement of the respective system is clear during programming and operation. Also follow the safety information of the hand-held transmitter.

The system, such as the garage door, can be operated using the button on the interior mirror while the drive-ready or standby state is switched on. To do this, hold down the button within receiving range of the system until the function is activated. The interior mirror LED stays lit while the wireless signal is being transmitted.

Deleting stored functions

All stored functions will be deleted. The functions cannot be deleted individually.

Press and hold the two outer buttons on the interior mirror simultaneously for approximately 10 seconds until the LED on the interior mirror flashes green rapidly.

Sun visor

Glare shield

Fold the sun visor down or up.

Vanity mirror

A vanity mirror is located in the sun visor behind a cover. When the cover is opened, the mirror lighting switches on.

Sockets

Concept

The lighter socket can be used as a socket for electrical equipment when standby and drive-ready state are switched on.

General information

The total load of all sockets must not exceed 140 watts at 12 volts.

Do not damage the socket by using non-compatible connectors.

Safety information

⚠ WARNING

Devices and cables in the unfolding area of the airbags such as portable navigation devices can hinder the unfolding of the airbag or be thrown around in the car's interior while unfolding. There is a risk of injury and risk of damage to property. Make sure that devices and cables are not in the airbag's area of unfolding.

⚠ WARNING

Battery chargers for the vehicle battery can work with high voltages and currents, which means that the 12 volt on-board network can be overloaded or damaged. There is a risk of injury and risk of damage to property. Only connect battery chargers for the vehicle battery to the starting aid terminals in the engine compartment.

⚠ WARNING

If metal objects fall or are plugged into electronic interfaces, e.g., sockets or USB ports, these objects can cause a short circuit and destroy the interface. There is a risk of injury and risk of damage to property. Make sure to prevent metal objects from falling or being plugged into electronic interfaces. Insert the socket or socket cover again after using the socket.

Center console

Pull off the cover.

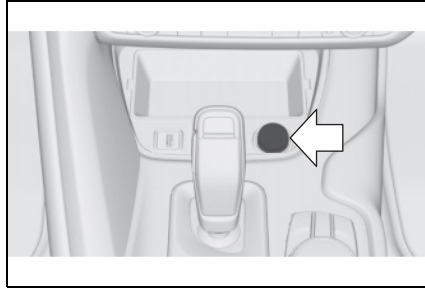

Cargo area*

*: if equipped

Open the cover.

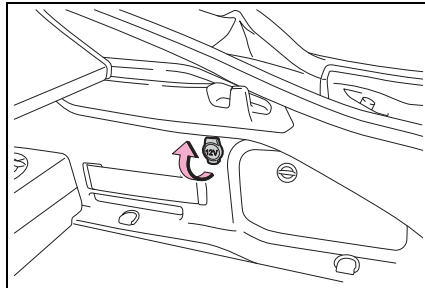

USB port

General information

Follow the information regarding the connection of mobile devices to the USB port in the section on USB connections, refer to page 76.

Safety information

⚠ WARNING

If metal objects fall or are plugged into electronic interfaces, e.g., sockets or USB ports, these objects can cause a short circuit and destroy the interface. There is a risk of injury and risk of damage to property. Make sure to prevent metal objects from falling or being plugged into electronic interfaces. Insert the socket or socket cover again after using the socket.

In the center console

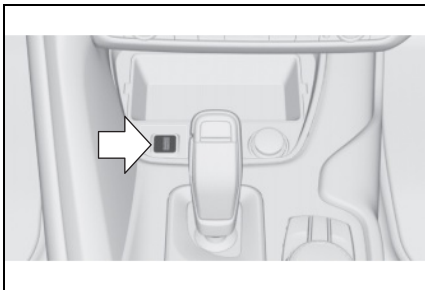

The USB port is located on the center console.

Properties:

- USB port Type A.
- For charging external devices.
- Charging current:
max. 1.5 A (vehicles without wireless charger)
max. 2.1 A (vehicles with wireless charger)
- For data transfer.

Wireless charging tray

Concept

The wireless charging tray allows wireless charging of mobile phones and other mobile devices certified according to the Qi standard.

General information

When inserting the device to be charged, ensure that there are no objects between the device to be charged and the wireless charging tray.

(⚡) The charging process is shown by the charge indicator on the control display.

This device has been tested for human exposure limits and found compliant at a minimum distance of 4 in/10 cm during operation. Therefore, a distance of 4 in/10 cm must be maintained in every direction when operating the device.

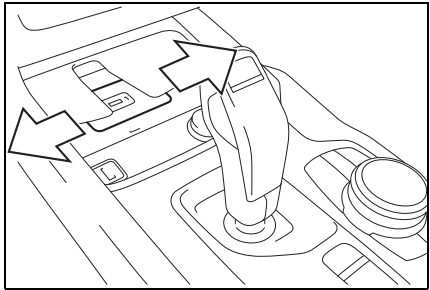

Mounting position of the product.

Safety information**WARNING**

When charging a Qi-compatible device in the wireless charging tray, metal objects on the tray with the device can become very hot. If storage media or electronic cards, e.g., chip cards, cards with magnetic strips, or cards that transmit signals, are placed on the tray together with the device, they may not function correctly. There is a risk of injury and risk of damage to property. When charging mobile devices, make sure there are no objects on the tray together with the device.

NOTICE

The tray is intended for mobile phones up to a particular size. Forceful inserting of the mobile phone into the tray can damage the tray or the mobile phone. There is a risk of damage to property. Observe the maximum dimensions for mobile phones. Do not force the mobile phone into the tray.

Functional requirements

- The mobile phone must compatibly support the required Qi standard.
- Standby state is switched on.
- Observe the maximum dimensions of the mobile phone.
- Use only protective jackets and covers up to a maximum thickness of 0.07 in/2 mm. Otherwise, the charging func-

tion may be impaired.

- The mobile phone to be charged is located in the center of the tray.

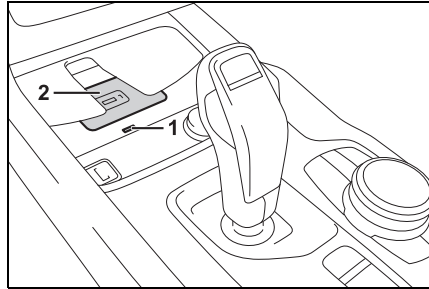
Operation**Overview**

- 1 LED
- 2 Storage area

Inserting the mobile phone

Place the mobile phone centered in the storage tray with the display facing up.

The mobile phone must not exceed the maximum size of approximately 6.0 x 3.1 x 0.7 in/154.5 x 80 x 18 mm.

LED displays

Color	Meaning
Blue	<p>The mobile phone is charging.</p> <p>Depending on the model and the vehicle, the blue LED is no longer illuminated once the inserted mobile phone with Qi capability is fully charged.</p>
Orange	<p>The mobile phone is not charging.</p> <p>Temperature on the mobile phone possibly too high or foreign object in the charging tray.</p>
Red	<p>The mobile phone is not charging.</p> <p>Contact your Toyota dealer.</p>

Forgotten warning

General information

If the vehicle is equipped with the forgotten warning function, a warning can be output if a mobile phone with Qi capability was forgotten in the wireless charging tray when leaving the vehicle.

The forgotten warning is displayed in the instrument cluster.

Activating

Via Toyota Supra Command:

- 1 “My Vehicle”
- 2 “System settings”
- 3 “Wireless charging tray”
- 4 “Forgotten mobile device alert”

System limits

The charge current may be reduced or the charging process may be temporarily interrupted in the following situations:

- Due to excessive temperatures on the surface of the tray and mobile phone.
- If there are objects between the mobile phone and the wireless charging tray.
- If storage media or electronic cards, e.g., chip cards, cards with magnetic strips, or cards for signal transmission, are located between the mobile phone and wireless charging tray.
- Due to protective sleeves and covers that exceed a thickness of 0.07 in/2 mm.
- Due to protective sleeves and covers made of unsuitable material, e.g., with magnetic parts.
- Due to add-on parts for mobile phone, e.g., holders.
- By settings on the mobile phone, for instance for charging. Follow the relevant

instructions control display and in the instructions for the mobile phone, if applicable.

LTE-Compensator - Information and User Manual

Your car is equipped with a wireless charging tray (WCA) to charge your mobile phone and connect it to the mobile network. To ensure the best possible connection a signal booster (LTE-Compensator) is used in conjunction with the WCA. The following paragraphs refer to this booster:

This is a CONSUMER device. BEFORE USE, you MUST REGISTER THIS DEVICE with your wireless provider and have your provider's consent. Most wireless providers consent to the use of Compensators. Some providers may not consent to the use of this device on their network. If you are unsure, contact your provider. You MUST operate this device with approved antennas and cables as specified by the manufacturer. Antennas MUST be installed at least 20 cm (8 inches) from any person. You MUST cease operating this device immediately if requested by the FCC or a licensed wireless service provider. Warning E911 location information may not be provided or may be inac-

curate for calls served by using this device.

Please observe additionally the following information

- Sprint Nextel will allow consumers to register their signal boosters by calling their toll-free number.
- T-Mobile online registration link: (www.T-Mobile.com/Booster-Registration); (<https://saqat.t-mobile.com/sites/SignalBooster#>).
- Verizon's online registration link: (<http://www.verizonwireless.com/wcms/consumer/register-signal-booster.html>).
- AT&T online registration link (<https://secure45.securewebsession.com/attsignal-booster.com/>).
- U.S.Cellular online registration link (<http://www.uscellular.com/uscellular/support/fcc-booster-registration.jsp>).

Before use you must register your booster device with your wireless provider.

If you should be requested by the FCC to cease operating your booster you are not allowed to insert your mobile phone in the charging tray anymore unless the booster is permanently deactivated by your Toyota

dealer.

You must not remove the booster from the car nor use it with any other than the pre-installed coupling device or antenna. Any modification of the existing antenna or coupling device as well as the use of other antennas or coupling devices will cause the cease of the booster's operating license.

The booster device fulfills the network protections standards as required by the FCC, such as intermodulation limits, oscillation detection and gain limits.

Booster Manufacturer: Kathrein Automotive

Model Number: LTECOMPB0

Part Number: 6803145-01

FCC-ID: 2ACC7LTECOMPB0

Storage compartments

Vehicle features and options

This chapter describes all standard, country-specific and optional features offered with the series. It also describes features and functions that are not necessarily available in your vehicle, e.g., due to the selected options or country versions. This also applies to safety-related functions and systems. When using these functions and systems, the applicable laws and regulations must be observed.

Safety information

WARNING

When driving, loose items or devices connected to the vehicle with a cable, i.e., mobile phones, may be thrown around the vehicle, e.g., in the event of an accident or when braking or performing evasive maneuvers. There is a risk of injury and risk of damage to property. Secure loose objects or devices that are connected to the vehicle via a cable.

! WARNING

Open flaps of the storage compartments, e.g., glove compartment, protrude into the interior when folded open and may be in the way of an airbag that deploys. In addition, objects in the open storage compartment can be thrown into the vehicle interior during the trip, for instance, in the event of an accident or when braking or making an evasive maneuver. There is a risk of injury. Always close storage compartments immediately after use.

! WARNING

Anti-slip pads such as anti-slip mats can damage the dashboard. Attached objects may come loose. There is a risk of injury and risk of damage to property. Do not use anti-slip pads.

Storage compartments

The vehicle interior contains multiple storage compartments for stowing objects.

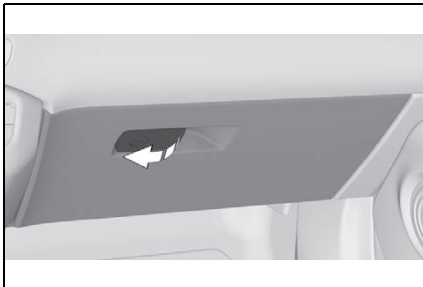
Glove compartment**Opening**

Pull the handle.

Closing

Fold the lid closed.

Locking

The glove compartment can be locked with an integrated key, refer to page 87. This prevents access to the glove compartment.

After the glove compartment is locked, the remote control can be handed over without the integrated key, for instance when the vehicle is parked by valet parking.

Compartments in the doors**General information**

There are storage compartments in the doors.

Safety information**! WARNING**

Breakable objects, such as glass bottles or glasses, can break in the event of an accident or a braking or evasive maneuver. Broken glass can be scattered in the car's interior. There is a risk of injury and risk of damage to property. Do not use any breakable objects while driving. Only stow breakable objects in closed storage compartments.

Cup holders

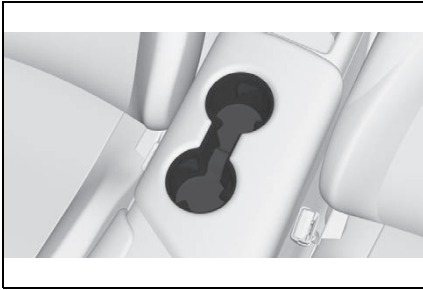

Safety information

⚠ WARNING

Unsuitable containers in the cup holders may damage the cup holders or be thrown about the car's interior in the event of an accident, an evasive maneuver, or forceful braking. Spilled liquids can distract from the surrounding traffic conditions, lead to an accident and damage vehicle components. Hot drinks can damage the cup holder or lead to scalding. There is a risk of injury and risk of damage to property. Do not force objects into the cup holder. Make sure that drink containers are secured firmly in the cup holder. Use lightweight, shatterproof, and sealable containers. Clean up spilled liquids immediately. Do not transport hot beverages.

Cargo area

Vehicle features and options

This chapter describes all standard, country-specific and optional features offered with the series. It also describes features and functions that are not necessarily available in your vehicle, e.g., due to the selected options or country versions. This also applies to safety-related functions and systems. When using these functions and systems, the applicable laws and regulations must be observed.

Loading

Safety information

⚠ WARNING

High gross vehicle weight can overheat the tires, damage them internally and cause a sudden tire pressure loss. Driving characteristics may be negatively impacted, reducing directional stability, lengthening the braking distances and changing the steering response. There is a risk of accident, injury, and property damage. Pay attention to the permitted load-carrying capacity of the tires and never exceed the permitted gross vehicle weight.

**WARNING**

When driving, loose items or devices connected to the vehicle with a cable, i.e., mobile phones, may be thrown around the vehicle, e.g., in the event of an accident or when braking or performing evasive maneuvers. There is a risk of injury and risk of damage to property. Secure loose objects or devices that are connected to the vehicle via a cable.

**WARNING**

Improperly stowed objects can slip and be thrown into the car's interior, for instance in the event of an accident, braking or an evasive maneuver. Vehicle occupants can be hit and injured. There is a risk of injury and risk of damage to property. Stow and secure objects and cargo properly.

**NOTICE**

Fluids in the cargo area can cause damage. There is a risk of damage to property. Make sure that no fluids leak in the cargo area.

Steps for Determining Correct Load Limit

- 1 Locate the statement "The combined weight of occupants and cargo should never exceed XXX kg or XXX lbs" on your vehicle's placard.
- 2 Determine the combined weight of the driver and passengers that will be riding in your vehicle.
- 3 Subtract the combined weight of the driver and passengers from XXX kg or XXX lbs.
- 4 The resulting figure equals the available amount of cargo and luggage load capacity. For example, if the "XXX" amount equals 1400 lbs and there will be five 150 lbs passengers in your vehicle, the amount of available cargo and luggage load capacity is 650 lbs (1400–750 (5 x 150) = 650 lbs).
- 5 Determine the combined weight of luggage and cargo being loaded on the vehicle. That weight may not safely exceed the available cargo and luggage load capacity calculated in Step 4.
- 6 If your vehicle will be towing a trailer, load from your trailer will be transferred to your vehicle. Consult this manual to determine how this reduces the available cargo and luggage load capacity of your vehicle.

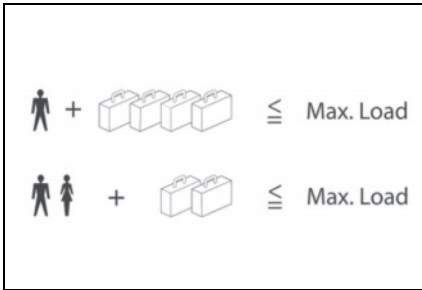
Load

The maximum load is the sum of the weight of the occupants and the cargo.

The greater the weight of the occupants, the less cargo that can be transported.

Stowing and securing cargo

- Cover sharp edges and corners on the cargo.
- Heavy cargo: stow as far forward and as low as possible, ideally directly behind the cargo partition.
- Fasten the aids for securing the load to the lashing eyes in the cargo area.
- Smaller and lighter cargo: secure with ratchet straps or with a cargo net or draw straps.
- Larger and heavy cargo: secure with cargo straps.

Lashing eyes in the cargo area*

*: if equipped

General information

Attach load securing aids, such as lashing straps, tensioning straps, draw straps or cargo nets, to the lashing eyes in the cargo area.

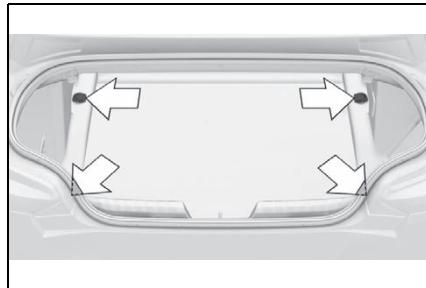
Lashing eyes

There are four lashing eyes in the cargo area for securing cargo.

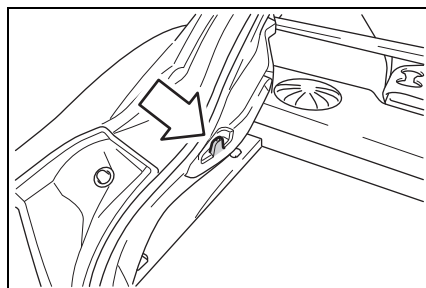
Multi-function hook**General information**

A multi-function hook is located on the left and right side in the cargo area.

Safety information

WARNING

Improper use of the multi-function hooks can lead to a risk of objects flying about during braking and evasive maneuvers, for example. There is a risk of injury and risk of damage to property. Only hang lightweight objects, such as shopping bags, from the multi-function hooks. Only transport heavy luggage in the cargo area if it has been appropriately secured.

Tensioning strap

A tensioning strap is available on the right side trim for fastening small objects.

Net

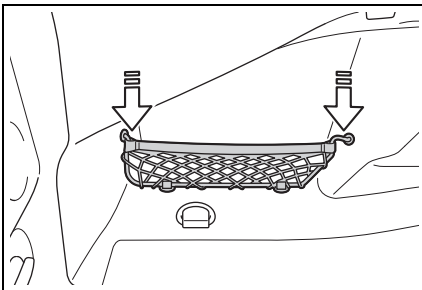

Small objects can be stowed in the net on the left side. To transport larger objects, slide the net down. Grab the top of the net as close as possible to the edge next to the holder. At first, a resistance must be overcome.

Storage compartment on the right side

General information

A storage compartment is available on the right side of the cargo area.

Opening

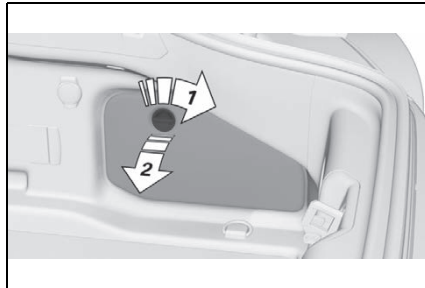

Unlock the cover of the right side panel, arrow **1**, and fold up, arrow **2**.

Luggage cover

Removing

The cover can be removed for stowing bulky items.

- 1 Unhook the retaining straps on the tailgate.

- 2 Slightly lift the cover, arrow 1, and pull backward from the holders, arrows 2.

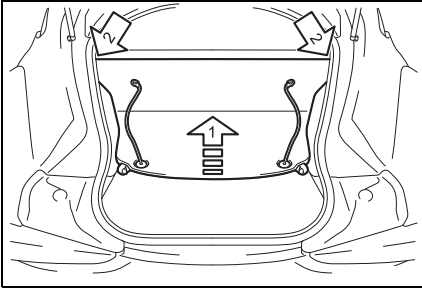

Inserting

To insert, proceed in reverse order. Make sure that the luggage cover is positioned correctly in the brackets.

DRIVING TIPS

4

4-1. DRIVING TIPS

- Things to remember when driving..... 262
- Saving fuel 267

Things to remember when driving

Vehicle features and options

This chapter describes all standard, country-specific and optional features offered with the series. It also describes features and functions that are not necessarily available in your vehicle, e.g., due to the selected options or country versions. This also applies to safety-related functions and systems. When using these functions and systems, the applicable laws and regulations must be observed.

Breaking-in period

General information

Moving parts need to begin working together smoothly.

The following instructions will help you to achieve a long vehicle life and good efficiency.

During break-in, do not use the Launch Control, refer to page 137.

Safety information

WARNING

Due to new parts and components, safety and driver assistance systems can react with a delay. There is a risk of accident, injury, and property damage. After installing new parts or with a new vehicle, drive conservatively and intervene early if necessary. Observe the break-in procedures of the respective parts and components.

Engine, transmission, and axle drive

Up to 1200 miles/2000 km

Do not exceed the maximum engine and road speed:

- For gasoline engine 4500 rpm and 100 mph/160 km/h.

Avoid full load or kickdown under all circumstances.

From 1200 miles/2000 km

The engine and vehicle speed can gradually be increased.

Tires

Tire traction is not optimal due to manufacturing circumstances when tires are brand-new; they achieve their full traction potential after a break-in time.

Drive conservatively for the first 200 miles/300 km.

Brake system

Brake discs and brake pads only reach their full effectiveness after approx. 300 miles/500 km. Drive moderately during this break-in period.

Clutch

The function of the clutch reaches its optimal level only after a distance driven of approx. 300 miles/500 km. During this break-in period, engage the clutch gently.

Following part replacement

Observe the break-in procedures again, if components mentioned above are replaced.

General driving notes**Closing the trunk lid****Safety information**** WARNING**

An open trunk lid protrudes from the vehicle and can endanger occupants and other road users or damage the vehicle in the event of an accident, braking or evasive maneuvers. In addition, exhaust gas or water may enter the vehicle interior. There is a risk of injury and risk of damage to property. Do not drive with the trunk lid open.

Ice on window glass** NOTICE**

The window will be lowered slightly when pulling on the door handle. In the event of frost, the window may freeze up and not be lowered. There is a risk of damage to property. When pulling on the door handle, make sure that the window is lowered. If necessary, remove snow and ice from the window. Do not open the door with force.

Hot exhaust gas system** WARNING**

High temperatures can occur underneath the body, for instance caused by the exhaust gas system, while driving. Contact with the exhaust gas system can cause burns. There is a risk of injury. Do not touch the hot exhaust gas system, including the exhaust pipe.

 WARNING

If combustible materials, such as leaves or grass, come in contact with hot parts of the exhaust gas system, these materials can ignite. There is a risk of fire and injuries. Do not remove the heat shields installed and never apply undercoating to them. Make sure that no combustible materials can come in contact with hot vehicle parts in driving operation, idle or during parking.

Mobile communications in the vehicle

 NOTICE

Vehicle electronics and mobile phones can influence one another. There is radiation due to the transmission operations of mobile phones. There is a risk of injury and risk of damage to property. Use only commercially available mobile communication devices, e.g., mobile phones, in the vehicle.

Driving in inclement weather

When visibility is poor due to fog

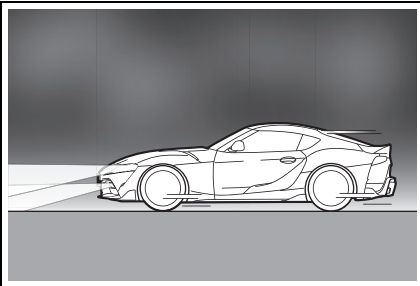

When visibility is poor due to fog, even if it is daytime, turn the low beam headlights on to make your vehicle more visible to other vehicles, etc. Drive with caution at a low speed, using the centerline, guardrails, tail-lights of a preceding vehicle, etc., as guide.

During strong wind

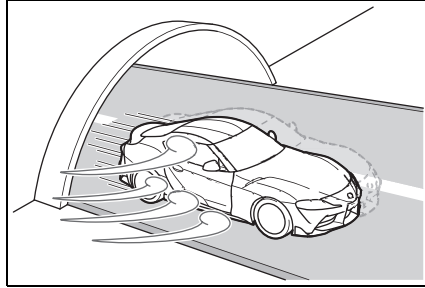

When the vehicle is being blown by crosswinds, drive at a lower speed and grip the steering wheel stronger than normal.

The vehicle is especially susceptible to crosswinds when exiting a tunnel or underpass, when driving on a bridge or embankment, or when passing or being passed by a truck or other large vehicle.

When it is raining

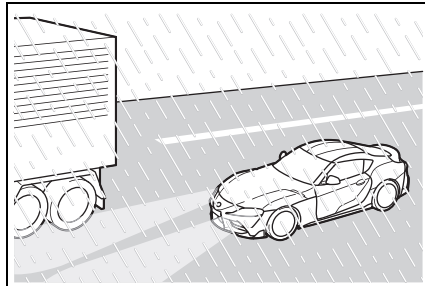

- During a rain storm or when the road surface is wet, the road surface may be slippery and visibility may be reduced. In this case, turn the low beam headlights on to make your vehicle more visible to

other vehicles, etc. Increase the distance between your vehicle and preceding vehicles and drive safely at a lower speed than normal, avoiding sudden acceleration, braking or steering operations.

- Use the rear defroster and air conditioning system to prevent the windows from fogging up.
- Hydroplaning is more likely to occur when driving on ruts or through large puddles.

Driving through water

General information

When driving through water, follow the following:

- Deactivate Auto Start/Stop function.
- Drive through calm water only.
- Drive through water only if it is not deeper than maximum 9.8 inches/25 cm.
- Drive through water no faster than walking speed, up to 3 mph/5 km/h.

Safety information

NOTICE

When driving too quickly through too deep water, water can enter into the engine compartment, the electrical system or the transmission. There is a risk of damage to property. When driving through water, do not exceed the maximum indicated water level and the maximum speed for driving through water.

Braking safely

General information

The vehicle is equipped with an Antilock Braking System ABS as a standard feature.

Perform full stop in situations that require such.

To achieve the best possible brake boosting, do not reduce the pressure on the brake pedal during full braking.

Steering is still responsive. You can still avoid any obstacles with a minimum of steering effort.

Pulsation of the brake pedal and sounds from the hydraulic circuits indicate that the Antilock Braking System ABS is in its active mode.

In certain braking situations, the perforated brake discs can emit functional noises. However, functional noises have no effect on the performance and opera-

tional reliability of the brake.

Objects in the area around the pedals

WARNING

Objects in the driver's floor area can limit the pedal distance or block a depressed pedal. There is a risk of accident, injury, and property damage. Stow objects in the vehicle such that they are secured and cannot enter into the driver's floor area. Use floor mats that are suitable for the vehicle and can be safely attached to the floor. Do not use loose floor mats and do not layer several floor mats. Make sure that there is sufficient clearance for the pedals. Ensure that the floor mats are securely fastened again after they were removed, for instance for cleaning.

Driving in wet conditions

When roads are wet, salted, or in heavy rain, gently press the brake pedal every few miles.

Ensure that this action does not endanger other traffic.

The heat generated during braking dries brake discs and brake pads and protects them against corrosion.

In this way braking efficiency will be available when you need it.

Hills

■ General information

Drive long or steep downhill gra-

dients in the gear that requires least braking effort. Otherwise, the brakes may overheat and reduce brake efficiency.

You can increase the engine's braking effect by shifting down, going all the way to first gear, if needed.

■ Safety information

WARNING

Light but constant pressure on the brake pedal can lead to high temperatures, brake wear, and even failure of the brake system. There is a risk of accident, injury, and property damage. Avoid placing excessive stress on the brake system.

WARNING

In Neutral or with drive-ready state switched off, safety functions, for instance engine braking effect, braking assistance and steering assistance, may be restricted or not available. There is a risk of accident, injury, and property damage. Do not attempt to drive in Neutral or with drive-ready state switched off.

Brake disc corrosion

Corrosion on the brake discs and contamination on the brake pads are increased by the following circumstances:

- Low mileage.
- Extended periods when the vehicle is not used at all.
- Infrequent use of the brakes.

- Aggressive, acidic, or alkaline cleaning agents.

Corrosion buildup on the brake discs will cause a pulsating effect on the brakes in their response - generally this cannot be corrected.

Condensation water under the parked vehicle

Condensation may form in the vehicle air-conditioning system. Condensation leaking under the vehicle is a technical problem and does not constitute a malfunction.

Driving on racetracks

Higher mechanical and thermal loads during racetrack operation lead to increased wear. This wear is not covered by the warranty. The vehicle is not designed for use in motor sports competition.

Have vehicle checked by your Toyota dealer before and after driving on a racetrack.

Saving fuel

Vehicle features and options

This chapter describes all standard, country-specific and optional features offered with the series. It also describes features and functions that are not necessarily available in your vehicle, e.g., due to the selected options or country versions. This also applies to safety-related functions and systems. When using these functions and systems, the applicable laws and regulations must be observed.

Reducing fuel consumption

General information

The vehicle contains advanced technologies for the reduction of consumption and emission values.

The fuel consumption depends on various factors, such as driving style, road conditions, maintenance or environmental factors.

Carrying out certain measures, such as a moderate driving style and regular maintenance, can influence fuel consumption and the environmental impact.

Remove unnecessary cargo

Additional weight increases fuel consumption.

Remove attached parts following use

Attached parts on the vehicle impair the aerodynamics and increase the fuel consumption.

Closing the windows

Open windows increase air resistance and therefore lead to greater fuel consumption.

Tires

General information

Tires can affect consumption in various ways, for instance tire size may influence consumption.

Check the tire inflation pressure regularly

Check and, if needed, correct the tire inflation pressure at least twice a month and before starting on a long trip.

Low tire inflation pressure increases rolling resistance and thus raises fuel consumption and tire wear.

Drive away without delay

Do not wait for the engine to warm-up while the vehicle remains stationary. Start driving right away, but at moderate engine speeds.

This is the quickest way of warming the cold engine up to operating temperature.

Look well ahead when driving

Driving smoothly and proactively reduces fuel consumption.

Avoid unnecessary acceleration and braking.

By maintaining a suitable distance to the vehicle driving ahead of you.

Avoid high engine speeds

Driving at low engine speeds lowers fuel consumption and reduces wear.

If necessary, observe the vehicle's gear shift indicator, refer to page 150.

Use coasting conditions

When approaching a red light, take your foot off the accelerator and let the vehicle coast to a halt.

For going downhill take your foot off the accelerator and let the

vehicle roll.

The flow of fuel is interrupted while coasting.

Switch off the engine during longer stops

Switching off the engine

Switch off the engine during longer stops, for instance at traffic lights, railroad crossings or in traffic congestion.

Auto Start/Stop function

The Auto Start/Stop function of the vehicle automatically switches off the engine during a stop.

If the engine is switched off and then restarted rather than leaving the engine running constantly, fuel consumption and emissions are reduced. Savings can begin within a few seconds of switching off the engine.

In addition, fuel consumption is also determined by other factors, such as driving style, road conditions, maintenance or environmental factors.

Switch off any functions that are not currently needed

Functions such as seat heating and the rear window defroster

require a lot of energy and increase fuel consumption, especially in city and stop-and-go traffic.

Switch off these functions if they are not needed.

Have maintenance carried out

Have the vehicle maintained regularly to achieve optimal vehicle efficiency and service life. Toyota recommends that maintenance work be performed by Toyota.

For information on the Maintenance System, refer to page 312.

MOBILITY**5****5-1. MOBILITY**

Refueling	272
Wheels and tires	274
Engine compartment...	300
Operating materials.....	303
Maintenance	312
Replacing components	314
Breakdown assistance	325
Care	335

Refueling

Vehicle features and options

This chapter describes all standard, country-specific and optional features offered with the series. It also describes features and functions that are not necessarily available in your vehicle, e.g., due to the selected options or country versions. This also applies to safety-related functions and systems. When using these functions and systems, the applicable laws and regulations must be observed.

Follow the following when refueling

General information

Follow the fuel recommendation, refer to page 303, prior to refueling.

When refueling, insert the filler nozzle completely into the filler pipe. Lifting up the fuel pump nozzle during refueling causes:

- Premature switching off.
- Reduced return of the fuel vapors.

The fuel tank is full when the filler nozzle clicks off the first time.

Make sure that the fuel cap is

closed properly after refueling, otherwise the emissions warning light may light up.

Follow safety regulations posted at the gas station.

Safety information

NOTICE

With a driving range of less than 30 miles/50 km the engine may no longer have sufficient fuel. Engine functions are not ensured anymore. There is a risk of damage to property. Refuel promptly.

NOTICE

Fuels are toxic and aggressive. Overfilling of the fuel tank can damage the fuel system. Painted surfaces may be damaged by contact with fuel. Escaping fuel can harm the environment. There is a risk of damage to property. Avoid overfilling.

Fuel cap

Opening

- 1 Briefly press the rear edge of the fuel filler flap.

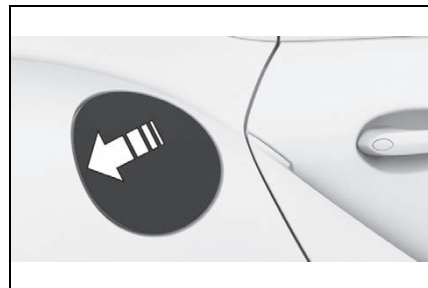

- 2 Turn the fuel cap counter-clockwise.

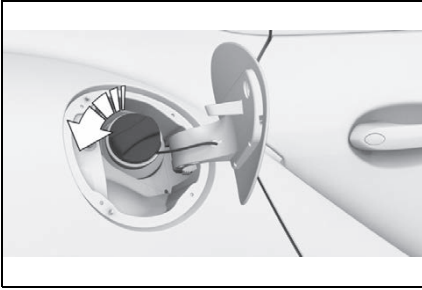

- 3 Place the fuel cap in the bracket attached to the fuel filler flap.

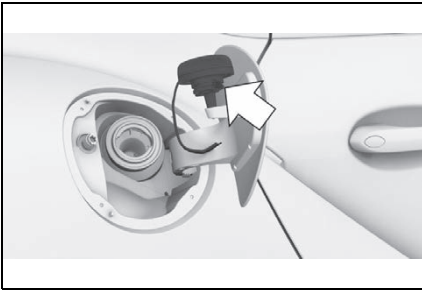

Closing

⚠ WARNING

The retaining strap of the fuel cap can be jammed and crushed during closing. The cap cannot be correctly closed. Fuel or fuel vapors can escape. There is a risk of injury and risk of damage to property. Pay attention that the retaining strap is not jammed or crushed when closing the cap.

- 1 Fit the cap and turn it clockwise until you clearly hear a click.
- 2 Press on the fuel filler flap until it engages.

Manually unlocking fuel filler flap

It may be necessary in certain situations to unlock the fuel filler flap manually, e.g. with an electrical fault.

Have fuel filler flap unlocked by your Toyota dealer.

Wheels and tires

Vehicle features and options

This chapter describes all standard, country-specific and optional features offered with the series. It also describes features and functions that are not necessarily available in your vehicle, e.g., due to the selected options or country versions. This also applies to safety-related functions and systems. When using these functions and systems, the applicable laws and regulations must be observed.

Tire inflation pressure

General information

The tire characteristics and tire inflation pressure influence the following:

- The service life of the tires.
- Road safety.
- Driving comfort.
- Fuel consumption.

Safety information

WARNING

A tire with too little or no tire inflation pressure may heat up significantly and sustain damage. This will have a negative impact on aspects of handling such as steering and braking response. There is a risk of accident, injury, and property damage. Regularly check the tire inflation pressure, and correct it as needed, for instance twice a month and before a long trip.

Tire inflation pressure specifications

In the tire inflation pressure table

The tire inflation pressure table, refer to page 277, contains all tire inflation pressure specifications for the specified tire sizes at the ambient temperature. The tire inflation pressure values apply to tire sizes approved by the manufacturer of the vehicle for the vehicle type.

To identify the correct tire inflation pressure, please note the following:

If the tire's speed code cannot be found, then the tire inflation pressure for the corresponding tire size applies.

- Tire sizes of your vehicle.
- Maximum permitted driving speed.

On the Control Display

The current tire inflation pressure values and the intended tire inflation pressure values for the mounted tires can be displayed on the Control Display.

To ensure that they are displayed correctly, the tire sizes must be stored in the system and must have been set, refer to page 286, for the mounted tires.

The current tire inflation pressure value is located on each tire.

The reference tire inflation pressure value is located in the lower area of the Control Display.

Checking the tire inflation pressure

General information

Tires heat up while driving. The tire inflation pressure increases with the tire temperature.

Tires have a natural, consistent loss of tire inflation pressure.

The displays of inflation devices may under-read by up to 0.1 bar/2 psi.

Checking using tire inflation pressure specifications in the tire inflation pressure table

The tire inflation pressure specifications in the tire inflation pressure table only relate to cold tires or tires at the same temperature as the ambient temperature.

Only check the tire inflation pressure levels when the tires are cold, i.e.:

- Driving range of max. 1.25 miles/2 km has not been exceeded.
- If the vehicle has not moved again for at least 2 hours after a trip.

Check the tire inflation pressure of the emergency wheel in the cargo area regularly, and correct it as needed.

- 1 Determine, refer to page 274, the intended tire inflation pressure levels for the mounted tires.
- 2 Check the tire inflation pressure in all four tires, using a pressure gauge, for example.
- 3 Correct the tire inflation pressure if the actual tire inflation pressure deviates from specified tire inflation pressure.
- 4 Check whether all valve caps are screwed onto the tire valves.

Checking using the tire inflation pressure specifications on the Control Display

Via Toyota Supra Command:

- 1 "My vehicle"
- 2 "Vehicle status"
- 3  "Tire Pressure Monitor"
- 4 Check whether the current tire inflation pressure levels deviate from the intended tire pressure value.
- 5 Correct the tire inflation pressure if the actual tire inflation pressure deviates from specified tire inflation pressure.

The display of the current tire pressure may be limited when the vehicle is stationary. After a short drive, the tire pressure is updated.

After correcting the tire inflation pressure

With tires that cannot be found in the tire pressure values on the Control Display, reset the Tire Pressure Monitor TPM.

Tire inflation pressures up to 100 mph/160 km/h

For speeds of up to 100 mph/160 km/h and for optimum driving comfort, note the pressure values in the tire inflation pressure table, refer to page 277, and adjust as necessary.

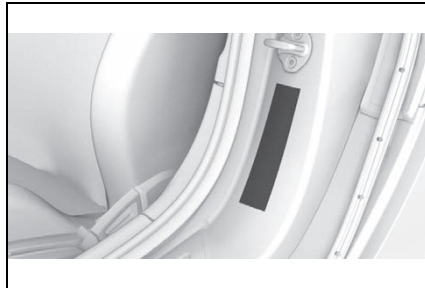

These pressure values can also be found on the tire inflation pressure label on the driver's door pillar.

Do not exceed a speed of 100 mph/160 km/h.

Tire inflation pressure values up to 100 mph/160 km/h

2.0 models

Tire size	Pressure specifications in bar/PSI
Specifications in bar/PSI with cold tires	
225/50 R 17 98 H M+S XL Std/RSC	2.2 / 32
255/40 R 18 99 V M+S XL Std	2.2 / 32
Front: 255/40 ZR 18 95 Y Std	2.2 / 32
Rear: 275/40 ZR 18 99 Y Std	2.2 / 32
Front: 255/35 ZR 19 96 Y XL Std	2.2 / 32
Rear: 275/35 ZR 19 100 Y XL Std	2.2 / 32

3.0 and 3.0 Premium models

Tire size	Pressure specifications in bar/PSI
Specifications in bar/PSI with cold tires	
225/50 R 17 98 H M+S XL Std/RSC	2.2 / 32
255/40 R 18 99 V M+S XL Std	2.6 / 38
Front: 255/40 ZR 18 95 Y Std	2.6 / 38
Rear: 275/40 ZR 18 99 Y Std	2.6 / 38
Front: 255/35 ZR 19 96 Y XL Std	2.6 / 38
Rear: 275/35 ZR 19 100 Y XL Std	2.6 / 38

Tire pressures, 100 mph/160 km/h

⚠ WARNING

When driving at speeds greater than 100 mph/160 km/h, incorrect tire pressures can negatively affect vehicle handling, e.g., safety or comfort while driving. The tires can become damaged, which may cause an accident. There is a risk of accident, injury, and property damage. To drive at maximum speeds, note the specified tire pressure for driving above 100 mph/160 km/h in the tire inflation pressure table, and adjust as necessary.

Tire inflation pressure values over 100 mph/160 km/h

2.0 models

Tire size	Pressure specifications in bar/PSI
Specifications in bar/PSI with cold tires	
225/50 R 17 98 H M+S XL Std/RSC	2.2 / 32
255/40 R 18 99 V M+S XL Std	2.2 / 32
Front: 255/40 ZR 18 95 Y Std Rear: 275/40 ZR 18 99 Y Std	2.2 / 32 2.2 / 32
Front: 255/35 ZR 19 96 Y XL Std Rear: 275/35 ZR 19 100 Y XL Std	2.2 / 32 2.2 / 32

3.0 and 3.0 Premium models

Tire size	Pressure specifications in bar/PSI
Specifications in bar/PSI with cold tires	
225/50 R 17 98 H M+S XL Std/RSC	2.2 / 32
255/40 R 18 99 V M+S XL Std	2.6 / 38
Front: 255/40 ZR 18 95 Y Std	2.6 / 38
Rear: 275/40 ZR 18 99 Y Std	2.6 / 38
Front: 255/35 ZR 19 96 Y XL Std	2.6 / 38
Rear: 275/35 ZR 19 100 Y XL Std	2.6 / 38

Tire identification marks**Tire size**

245/45 R 18 96 Y

245: nominal width in mm

45: aspect ratio in %

R: radial tire code

18: rim diameter in inches

96: load index, not for ZR tires

Y: speed rating, before the R on ZR tires

Maximum tire load

Maximum tire load is the maximum permissible weight for which the tire is approved.

Locate the maximum tire load on the tire sidewall and the Gross Axle Weight Rating –

GAWR – on the certification label on the driver door B-pillar. Divide the tire load by 1.1. It must be greater than one-half of the vehicle's Gross Axle Weight Rating – GAWR. Note, front vs. rear GAWR and tire loads, respectively.

Speed letter

Q = up to 100 mph/160 km/h

R = up to 106 mph/170 km/h

S = up to 112 mph/180 km/h

T = up to 118 mph/190 km/h

H = up to 131 mph/210 km/h

V = up to 150 mph/240 km/h

W = up to 167 mph/270 km/h

Y = up to 186 mph/300 km/h

(Y) = above 186 mph/300 km/h

Tire Identification Number

DOT code: DOT xxxx xxx 3820
 xxxx: manufacturer code for the tire brand
 xxx: tire size and tire design
 3820: tire age
 Tires with DOT codes meet the guidelines of the U.S. Department of Transportation.

Tire age

Recommendation

Regardless of the tire tread, replace tires at least every 6 years.

Manufacture date

You can find the manufacture date of the tire on the tire's sidewall.

Designation	Manufacture date
DOT ... 3820	38th week, 2020

Uniform Tire Quality Grading

Quality grades can be found where applicable on the tire sidewall between tread shoulder and maximum section width.
 E.g.: Treadwear 200; Traction AA; Temperature A

DOT Quality Grades

Treadwear
 Traction AA A B C
 Temperature A B C
 All passenger vehicle tires must conform to Federal Safety Requirements in addition to these grades

Treadwear

The treadwear grade is a comparative rating based on the wear rate of the tire when tested under controlled conditions on a specified government test course. E.g., a tire graded 150 would wear one and one-half, 1 g, times as well on the government course as a tire graded 100. The relative performance of tires depends upon the actual conditions of their use, however, and may depart significantly from the norm due to variations in driving habits, service practices and differences in road characteristics and climate.

Traction

The traction grades, from highest to lowest, are AA, A, B, and C.
 Those grades represent the tire's ability to stop on wet pavement as measured under controlled conditions on specified

government test surfaces of asphalt and concrete. A tire marked C may have poor traction performance.

The traction grade assigned to this tire is based on straight-ahead braking traction tests, and does not include acceleration, cornering, hydroplaning, or peak traction characteristics.

Temperature

The temperature grades are A, the highest, B, and C, representing the tire's resistance to the generation of heat and its ability to dissipate heat when tested under controlled conditions on a specified indoor laboratory test wheel. Sustained high temperature can cause the material of the tire to degenerate and reduce tire life, and excessive temperature can lead to sudden tire failure.

The grade C corresponds to a level of performance which all passenger vehicle tires must meet under the Federal Motor Vehicle Safety Standard No. 109. Grades Band A represent higher levels of performance on the laboratory test wheel than the minimum required by law.

WARNING

The temperature grade for this tire is established for a tire that is properly inflated and not overloaded. Excessive speed, underinflation, or excessive loading, either separately or in combination, can cause heat buildup and possible tire failure. There is a risk of accident, injury and property damage.

M+S

Winter tires, as well as all-season tires with better winter performance than summer tires, can be identified by the M+S marking on the tire side wall.

Tire tread

Safety information

WARNING

If the tire tread depth is too low, driving safety may be impaired in critical situations. There is a risk of accident, injury, and property damage. Follow applicable legal requirements for minimum tread depth.

Minimum tread depth

Generally speaking, the legal minimum tread depths may differ for summer tires, winter tires, and all-season tires. To ensure optimum handling, e.g., in wet or snowy conditions, it may be useful to change a tire before it reaches the legal minimum

tread depth. For more information, contact your Toyota dealer.

Wear indicator

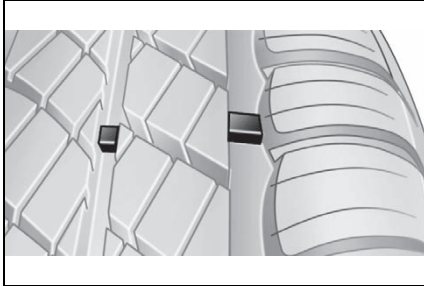

The tire manufacturer's wear indicators are distributed around the tire circumference and have a height of at least 0.06 in/1.6 mm. The wear indicators serve as indicators for the wear of the tire tread.

The positions of the wear indicators are marked on the tire sidewall with TWI, Tread Wear Indicator.

Tire damage

General information

Inspect your tires regularly for damage, foreign objects lodged in the tread, and tread wear.

Indications of tire damage or other vehicle malfunctions:

- Unusual vibrations.
- Unusual tire or running noises.
- Unusual handling such as a strong tendency to pull to the

left or right.

- Uneven wear pattern, e.g., increased wear in the area of the tire shoulder.

Damage can be caused by the following situations, for instance:

- Driving over curbs.
- Road damage.
- Tire inflation pressure too low.
- Vehicle overloading.
- Incorrect tire storage.

Safety information

⚠ WARNING

Damaged tires can lose tire inflation pressure, which can lead to loss of vehicle control. There is a risk of accident, injury, and property damage. If tire damage is suspected while driving, immediately reduce speed and stop. Have wheels and tires checked. Drive carefully to your Toyota dealer. Have the vehicle towed or transported as needed. Do not repair damaged tires, but have them replaced.

⚠ WARNING

The wheels, tires and chassis components can become damaged when driving over curbs, road damage, or other obstacles. Larger wheels have a smaller tire cross-section. The smaller the tire cross-section, the higher the risk of tire damage. There is a risk of accident, injury, and property damage. If possible, avoid driving over curbs, road damage or other obstacles, or drive over them slowly and carefully.

Changing wheels and tires

Mounting and wheel balancing

Have mounting and wheel balancing carried out by your Toyota dealer.

Suitable wheels and tires

General information

Only certain wheel/tire combinations are suitable depending on vehicle and equipment. The vehicle manufacturer determines wheel/tire combinations on the basis of the following criteria:

- Tire size, e.g., tire width, aspect ratio
- Wheel size, e.g., rim diameter, offset

For more information on wheel/tire combinations and special equipment, contact Toyota dealer.

Safety information

WARNING

Wheels and tires that are not suitable for the vehicle can damage parts of the vehicle. There is a risk of accident, injury, and property damage. The vehicle manufacturer recommends that you use only wheels and tires that have been recommended for the vehicle type.

WARNING

Mounted steel wheels can cause technical problems, for instance unexpected loosening of the lug bolts and damage to the brake disks. There is a risk of accident, injury, and property damage. Do not mount steel wheels.

WARNING

Wheel/tire combinations that are not suitable for the vehicle can affect vehicle handling and a number of system functions, e.g., the Anti-lock Braking System or Vehicle Stability Control. There is a risk of accident, injury, and property damage. The manufacturer of the vehicle recommends that you use wheels and tires that have been recommended by the vehicle manufacturer for the vehicle type. Following tire damage, have the original wheel/tire combination remounted on the vehicle as soon as possible.

Recommended tire brands

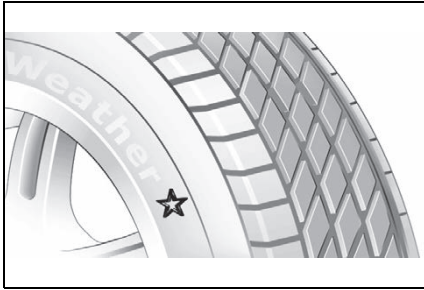

Tire types are developed for each vehicle and optimized specifically for the individual requirements of that vehicle, e.g.:

- Handling
- Comfort
- Noise characteristics

Specially developed tires are marked with a star on the tire sidewall. After replacing wheels and tires, the vehicle manufacturer recommends using star-marked tires again. The vehicle manufacturer recommends that you use tires of the same make and tread design.

New tires

Tire traction is not optimal due to manufacturing circumstances when tires are brand-new; they achieve their full traction potential after a break-in time.

Drive conservatively for the first 200 miles/300 km.

Retreaded tires

⚠ WARNING

Retreaded tires can have different tire casing structures. With advanced age the service life can be limited. There is a risk of accident, injury, and property damage. The manufacturer of the vehicle does not recommend the use of retreaded tires.

Maximum speed

Safety information

⚠ WARNING

If the maximum permissible speed of your mounted tires is exceeded, the tires may be damaged. There is a risk of accident, injury, and property damage. Do not exceed the maximum permissible speed of the tires.

Maximum speed of winter tires

If the maximum speed of the vehicle is higher than the permissible speed of the winter tires, the maximum permissible speed must be indicated with a sign placed in the field of vision. The info label is available from your Toyota dealer.

Winter tires

General information



Winter tires are recommended for operating on winter roads.

Winter tires can be identified by the symbol with mountain and snowflake, as well as the M+S marking on the tire sidewall.

So-called all-season tires with M+S designation, but without symbol with mountain and snowflake, have better winter characteristics than summer tires but generally do not achieve the performance of winter tires.

Rotating wheels between axles

WARNING

A wheel change between the axles on vehicles with different tire sizes or rim sizes on the front and rear axles can cause damage to the tires and the vehicle. There is a risk of accident, injury, and property damage. Do not rotate the tires between the axles on vehicles with different tire sizes or rim sizes on the front and rear axles.

Storing tires

Tire inflation pressure

Do not exceed the maximum tire inflation pressure indicated on the side wall of the tire.

Storage

Store wheels and tires in a cool, dry and dark place.

Always protect tires against all contact with oil, grease, and solvents.

Do not leave tires in plastic bags.

Remove dirt from wheels or tires.

Snow chains



NOTICE

■ Driving with tire chains

Do not fit tire chains. Tire chains may damage the vehicle body and suspension, and adversely affect driving performance.

Selecting tire chains

Tire chains cannot be mounted. Snow tires should be used instead.

Tire Pressure Monitor TPM

Concept

The system monitors tire inflation pressure in the four mounted tires. The system warns you if there is a loss of pressure in one or more tires.

General information

Sensors in the tire valves measure the tire inflation pressure and tire temperature.

The system detects the mounted tires automatically. The system displays the specified nominal pressure values on the Control Display and compares these values to the actual tire pressure values.

If tires are being used that are not specified on the tire inflation

pressure details on the vehicle, refer to page 274, such as tires with special approval, the system needs to be actively reset. The system will then take over the actual tire inflation pressures as the target pressures.

When operating the system, also note the additional information found in the Tire inflation pressure, refer to page 274.

Safety information



WARNING

The display of the target pressures is not a substitute for the tire inflation pressure details on the vehicle. Incorrect entries in the tire settings can lead to incorrect target tire inflation pressure values. In this case, it cannot be guaranteed that the notification of a loss of tire inflation pressure will be reliable. There is a risk of injury and risk of damage to property. Ensure that the tire sizes of the mounted tires are displayed correctly and match the details on the tires and on the vehicle.

Functional requirements

The following conditions must be met for the system; otherwise, reliable flagging of a loss of tire inflation pressure is not assured:

- After each tire or wheel change, the system detects and updates the mounted tires and displays them after a short trip on the Control Dis-

play.

Enter the information about the mounted tires in the tire settings when the system does not automatically detect the tires.

- TPM does not activate until after driving for a few minutes:
- After a tire or wheel replacement.
- Reset, for tires without special approval.
- After changing the tire setting.
- For tires with special approval:
- After a tire or wheel replacement, a reset was performed with the correct tire inflation pressure.
- After the tire inflation pressure was adjusted to a new value, a reset was performed.
- Wheels with TPM wheel electronics.

Tire settings

General information

The information about the mounted tires can be entered in the tire settings if the system does not automatically detect the tires.

The tire sizes of the mounted tires can be gathered from the tire inflation pressure details on the vehicle, refer to page 274, or directly on the tires.

The tire details do not need to be re-entered when the tire inflation pressure is corrected.

For summer and winter tires, the tire details entered last are stored. After a tire or wheel replacement, the settings of the tire sets used last can be selected.

Opening the menu

Via Toyota Supra Command:

- 1 "My vehicle"
- 2 "Vehicle status"
- 3 (!) "Tire Pressure Monitor"

Changing settings

Via Toyota Supra Command:

- 1 "Tire settings"
- 2 Selecting tires:
 - "Summer tires"
 - "Winter tires/all-season tires"
- 3 "Current:"
- 4 Select the tire type that is mounted on the rear axle:
 - Tire size, e.g., 245/45 R18 96 Y.
 - For tires with special approval: "Other tire"
- 5 Select the maximum road speed that will be used with the tires.
- 6 "Confirm settings"

The measurement of the current tire inflation pressure is started. The measurement progress is displayed.

Status display

Current status

The system status can be displayed on the Control Display, e.g., whether or not the system is active.

Via Toyota Supra Command:

- 1 "My vehicle"
- 2 "Vehicle status"
- 3 (U) "Tire Pressure Monitor"

The current status is displayed.

Current tire inflation pressure

The current tire inflation pressure is displayed for each tire.

The current tire inflation pressures may change during driving operation or depending on the external temperature.

Current tire temperature

Depending on the model, the current tire temperatures are displayed.

The current tire temperatures may change while driving or due to the external temperature.

Tire conditions

General information

Tire and system status are indi-

cated by the color of the wheels and a SMS text message on the Control Display.

Any existing messages are not deleted if the displayed target pressure is not reached after the tire inflation pressure is corrected.

All wheels green

- The system is active and bases warnings on the displayed target pressures.
- For tires with special approval: the system is active and bases warnings on the tire inflation pressures stored during the last reset.

One to four yellow wheels

A flat tire or major drop in the tire inflation pressure has occurred in the indicated tires.

Gray wheels

It may not be possible to identify tire inflation pressure losses.

Possible causes:

- Malfunction.
- During tire inflation pressure measurement, after confirmation of the tire settings.
- For tires with special approval: the system is being reset.

Reset the tire inflation pressure

Via Toyota Supra Command:

- 1 "My vehicle"
- 2 "Vehicle status"
- 3 "Tire Pressure Monitor"
- 4 "Tire settings"
- 5 Selecting tires:
 - "Summer tires"
 - "Winter tires/all-season tires"
- 6 "Current:"
 - ▶ When not selecting "Other tire":
- 7 "Load state"
- 8 "Confirm settings"
- 9 Drive the vehicle.
 - ▶ When selecting "Other tire":
- 7 "Tire settings"
- 8 Switch on drive-ready state and do not drive off.
- 9 Reset tire inflation pressure: "Perform reset".
- 10 Drive away.

After driving faster than 19 mph/30 km/h for a short period, the set tire inflation pressures are accepted as the target tire inflation pressures. The reset is completed automatically while driving.

After a successfully completed reset, the wheels on the Control Display are shown in green.

You may interrupt this trip at any

time. When you continue the reset resumes automatically.

Messages: for tires without special approval

General information

A low tire inflation pressure may cause the VSC Vehicle Stability Control System to be switched on.

Safety information

WARNING

A damaged regular tire with low or missing tire inflation pressure impacts handling, such as steering and braking response. There is a risk of accident, injury and property damage. Do not continue driving if the vehicle is equipped with normal tires.

If a tire inflation pressure check is required

■ Message

A symbol with a vehicle message appears on the Control Display.

Symbol	Possible cause
	Leak detected on the tire. Inflation was not carried out according to specifications, e.g., when the tire has not been sufficiently inflated or in the case of a natural steady tire pressure loss.

■ Measure

Check the tire pressure and correct as needed.

If the tire inflation pressure is too low

■ Message



A yellow warning light is illuminated in the instrument cluster.

In addition, a symbol with a vehicle message appears on the Control Display.

Symbol	Possible cause
	There is a tire inflation pressure loss.

■ Measure

- 1 Reduce the vehicle speed. Do not exceed a speed of 80 mph/130 km/h.
- 2 Stop at a filling station, etc. and check the tire inflation pressure of all 4 tires as soon as possible. Adjust the tire inflation pressure or have

repairs performed as necessary.

If there is a significant loss of tire inflation pressure

■ Message



A yellow warning light is illuminated in the instrument cluster.

In addition, a symbol with the affected tire appears in a vehicle message on the Control Display.

Symbol	Possible cause
	There is a flat tire or a major loss in tire inflation pressure.

■ Measure

Reduce your speed and stop cautiously. Avoid sudden braking and steering maneuvers.

Messages: for tires with special approval

General information

A low tire inflation pressure may cause the VSC Vehicle Stability Control System to be switched on.

Safety information

⚠ WARNING

A damaged regular tire with low or missing tire inflation pressure impacts handling, such as steering and braking response. There is a risk of accident, injury and property damage. Do not continue driving if the vehicle is equipped with normal tires.

If a tire inflation pressure check is required

■ **Message**

A symbol with a vehicle message appears on the Control Display.

Symbol	Possible cause
	<p>Inflation was not carried out according to specifications, e.g., the tire has not been sufficiently inflated.</p> <p>The system has detected a wheel change, but no reset was done.</p> <p>The tire inflation pressure has fallen below the level of the last reset.</p> <p>No reset was performed for the system. The system issues a warning based on the tire inflation pressures stored during the last reset.</p>

■ **Measure**

- 1 Check the tire pressure and correct as needed.
- 2 Perform a system reset.

If the tire inflation pressure is too low

■ **Message**



A yellow warning light is illuminated in the instrument cluster.

In addition, a symbol with a vehicle message appears on the Control Display.

Symbol	Possible cause
	<p>There is a tire inflation pressure loss.</p> <p>No reset was performed for the system. The system issues a warning based on the tire inflation pressures stored during the last reset.</p>

■ **Measure**

- 1 Reduce the vehicle speed. Do not exceed a speed of 80 mph/130 km/h.
- 2 At the next opportunity, for instance at a gas station, check the tire inflation pressure in all four tires and correct if necessary.
- 3 Reset the system.

If there is a significant loss of tire inflation pressure

■ Message



A yellow warning light is illuminated in the instrument cluster.

In addition, a symbol with the affected tire appears in a vehicle message on the Control Display.

Symbol	Possible cause
	<p>There is a flat tire or a major loss in tire inflation pressure.</p> <p>No reset was performed for the system.</p> <p>The system issues a warning based on the tire inflation pressures stored during the last reset.</p>

■ Measure

Reduce your speed and stop cautiously. Avoid sudden braking and steering maneuvers.

Actions in the event of a flat tire

- 1 Identify the damaged tire.

Check the tire inflation pressure in all four tires, for instance using the tire pressure gauge of a flat tire kit. For tires with special approval: if the tire inflation pressure in all four tires is correct, the TPM may not have been reset. In this case, perform the reset.

If tire damage cannot be found, contact your Toyota dealer.

- 2 Repair the flat tire, e.g., with a flat tire kit or by changing the wheel.

Use of sealant, for instance from the flat tire kit, may damage the TPM wheel electronics. Have the electronics replaced at the next opportunity.

System limits

Temperature

The tire inflation pressure depends on the tire's temperature.

Driving or exposure to the sun will increase the tire's temperature, thus increasing the tire inflation pressure.

The tire inflation pressure is reduced when the tire temperature falls again.

These circumstances may cause a warning when temperatures fall very sharply.

Following a temperature-related warning, the target pressures are displayed on the Control Display again after a short distance.

Sudden tire pressure loss

The system cannot indicate sudden serious tire damage caused by external circumstances.

Failure to perform a reset

Tires with special approval: the system will not function correctly if a reset was not performed, for example a flat tire may be indicated although the tire inflation pressures are correct.

Malfunction**Message**

The yellow warning light flashes and is then illuminated continuously. A vehicle message is displayed. It may not be possible to identify tire pressure losses.

Measure

- A wheel without TPM wheel electronics, such as an emergency wheel, is mounted: have the wheels checked, if needed.
- Malfunction: have the system checked.
- Interference caused by systems or devices with the same radio frequency: after leaving the area of the interference, the system automatically becomes active again.
- For tires with special approval: the system was unable to complete the reset.

Perform a system reset again.

- Tire Pressure Monitor malfunction: have the system checked by your Toyota dealer.

Declaration according to NHTSA/FMVSS 138 Tire Pressure Monitoring System

- Each tire, including the spare (if provided) should be checked monthly when cold and inflated to the inflation pressure recommended by the vehicle manufacturer on the vehicle placard or tire inflation pressure label. (If your vehicle has tires of a different size than the size indicated on the vehicle placard or tire inflation pressure label, you should determine the proper tire inflation pressure for those tires.) As an added safety feature, your vehicle has been equipped with a tire pressure monitoring system (TPMS) that illuminates a low tire pressure telltale when one or more of your tires is significantly under-inflated. Accordingly, when the low tire pressure telltale illuminates, you should stop and check your tires as soon as possible, and inflate them to the proper pressure. Driving on a significantly under-inflated tire causes the tire to overheat

and can lead to tire failure. Under-inflation also reduces fuel efficiency and tire tread life, and may affect the vehicle's handling and stopping ability. Please note that the TPMS is not a substitute for proper tire maintenance, and it is the driver's responsibility to maintain correct tire pressure, even if under-inflation has not reached the level to trigger illumination of the TPMS low tire pressure telltale. Your vehicle has also been equipped with a TPMS malfunction indicator to indicate when the system is not operating properly. The TPMS malfunction indicator is combined with the low tire pressure telltale. When the system detects a malfunction, the telltale will flash for approximately one minute and then remain continuously illuminated. This sequence will continue upon subsequent vehicle start-ups as long as the malfunction exists. When the malfunction indicator is illuminated, the system may not be able to detect or signal low tire pressure as intended. TPMS malfunctions may occur for a variety of reasons, including the installation of replacement or alternate tires or wheels on the vehicle that prevent the TPMS from func-

tioning properly. Always check the TPMS malfunction telltale after replacing one or more tires or wheels on your vehicle to ensure that the replacement or alternate tires and wheels allow the TPMS to continue to function properly.

Repairing a flat tire

Safety measures

- Park the vehicle as far away as possible from passing traffic and on solid ground.
- Switch on the hazard warning system.
- Secure the vehicle against rolling away by setting the parking brake.
- Turn the steering wheel until the front wheels are in the straight-ahead position and engage the steering wheel lock.
- Have all vehicle occupants get out of the vehicle and ensure that they remain outside the immediate area in a safe place, such as behind a guardrail.
- If necessary, set up a warning triangle at an appropriate distance.

Mobility System

Concept

With the Mobility System, minor tire damage can be sealed temporarily to enable continued travel. To accomplish this, sealant is pumped into the tires, which seals the damage from the inside.

General information

- The filled in tire sealant closes the damage from the inside when it hardens.
- Follow the instructions for using the tire repair set, which are provided on the compressor and sealant bottle.
- The tire repair set may be insufficient if the tire damage measures more than approx. 0.16 in/4 mm.
- Do not remove foreign objects that have penetrated the tire. Remove foreign objects only when they are visibly protruding from the tire.
- The compressor can be used to check the tire inflation pressure.

Overview

Storage

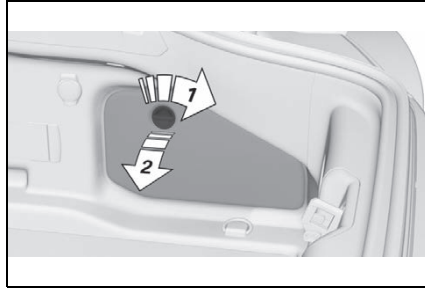

Storage for the tire repair set is provided in the cargo area behind the right side trim panel.

Sealant bottle and filler hose

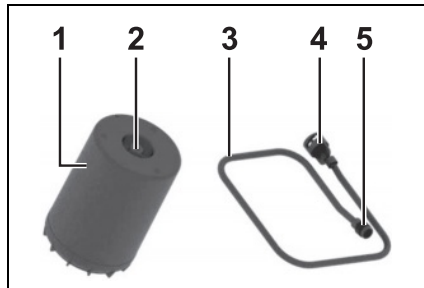

- 1 Sealant bottle
- 2 Sealant bottle outlet
- 3 Filler hose
- 4 Sealant bottle connection
- 5 Wheel valve connection

Compressor

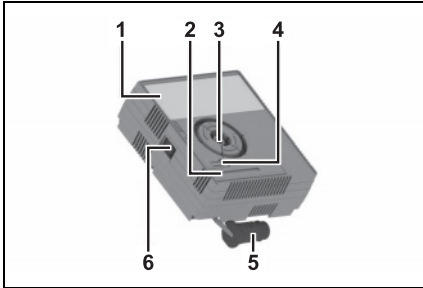

- 1 Compressor
- 2 Tire pressure display
- 3 Sealant bottle mount
- 4 Pressure reducing valve button
- 5 Connector for socket
- 6 Power switch

Safety precautions

- Park the vehicle as far away as possible from passing traffic and on solid ground.
- Turn on the hazard warning system.
- Set the parking brake.
- Turn the steering wheel until the front wheels are in the straight-ahead position and engage the steering wheel lock.
- As soon as permitted by the traffic flow, have all vehicle occupants get out and make sure that they remain outside the hazardous area such as behind a guardrail.
- If necessary, set up the hazard triangle or hazard warning

lights at an appropriate distance.

- Remove the warning label for the maximum permissible speed from the sealant bottle and attach it in the visible area in the vehicle interior.

Preparing the tire repair kit

- 1 Insert the sealant bottle into the mount on the housing of the compressor.

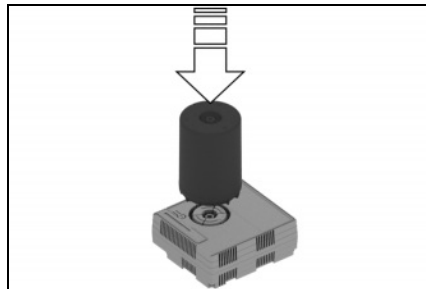

- 2 Turn the sealant bottle clockwise by 90° to the stop.

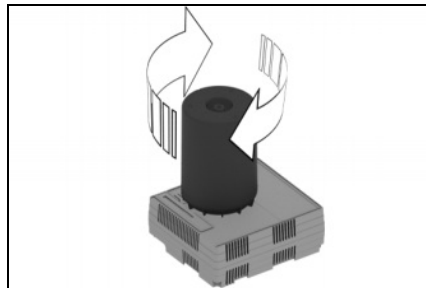

- 3 Connect the filler hose to the outlet of the sealant bottle

and turn clockwise by 90° to the stop.

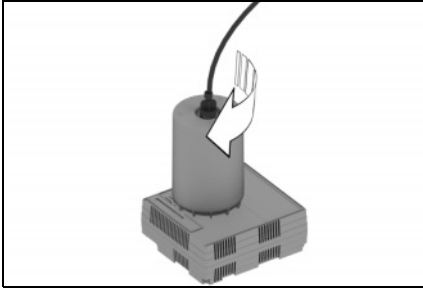

- 4** Unscrew the valve cap from the wheel and screw the connecting piece of the filler hose onto the valve.

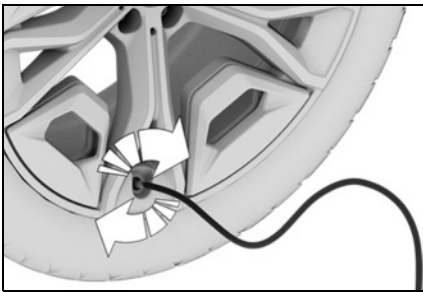

- 5** With the compressor switched off, insert the connector into the power socket in the vehicle interior.

Filling the tire with sealant

Safety information

⚠ WARNING

If the exhaust pipe is blocked or ventilation is insufficient, harmful exhaust gases can penetrate the vehicle. The exhaust gases contain pollutants which are colorless and odorless. In enclosed areas, exhaust gases can also accumulate outside of the vehicle. There is a danger to life. Keep the exhaust pipe free and ensure sufficient ventilation.

⚠ NOTICE

The compressor can overheat during extended operation. There is a risk of damage to property. Do not run the compressor for more than 10 minutes.

Filling the tire with sealing compound

- 1** With standby state or drive-ready state switched on, switch on the compressor.
Let the compressor run for max. 10 minutes to fill in the tire sealant and reach a tire pressure of 2.5 bar/36 psi. While the tire is being filled with tire sealant, the tire pressure can briefly reach approx. 6 bar/87 psi. Do not turn off the compressor in this phase.
- 2** Switch off the compressor.

Checking the tire pressure

Read the tire pressure on the tire pressure display of the compressor. The tire pressure must be at least 2.5 bar/36 psi.

Tire pressure too high

If the tire pressure is too high, reduce the tire pressure with the pressure reducing valve on the compressor.

Minimum tire inflation pressure is not reached

Do not continue driving unless a minimum tire pressure of 2.5 bar/36 psi is reached. Contact your Toyota dealer.

Minimum tire inflation pressure is reached

- 1 Pull the connector out of the socket in the vehicle interior.
- 2 Disconnect the hose from the sealant bottle and the valve on the wheel.
- 3 Unscrew the valve cap.
- 4 Stow the tire repair set in the cargo area.
- 5 Immediately drive 6 miles/10 km to ensure that the tire sealant is evenly distributed in the tire.

Do not exceed the permissible maximum speed of 50 mph/80 km/h.

If possible, do not drive at speeds less than 12 mph/20 km/h.

Tire sealant may spray from the damaged area during the initial wheel rotations.

Adjusting the tire pressure

- 1 Stop at a suitable location.
- 2 Connect the hose directly to the compressor and turn clockwise by 90° until it audibly engages.
- 3 Unscrew the valve cap from the wheel and screw the connecting piece of the hose onto the valve.

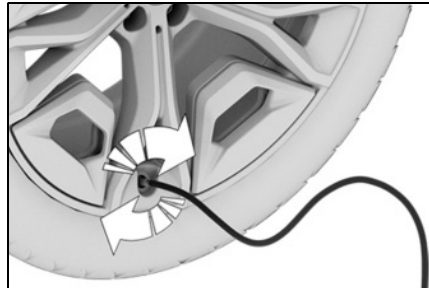

- 4 Insert the connector into the socket in the vehicle interior.
- 5 Read the tire pressure on the tire pressure display of the compressor.
Do not continue driving unless a minimum tire pressure of 1.3 bar/19 psi is displayed. Contact your Toyota dealer.
- 6 Correct the tire pressure to 2.5 bar/36 psi.
 - Increase tire pressure: with standby or driving readiness

turned on, turn on the compressor and let it run for a maximum of 10 minutes.

- Reduce tire pressure: press the pressure reducing valve button on the compressor.

Remove and stow the tire repair set

- 1 Switch off the compressor.
- 2 Pull the connector out of the socket in the vehicle interior.
- 3 Disconnect the hose from the compressor and the valve on the wheel.
- 4 Unscrew the valve cap.
- 5 Stow the tire repair set together with the hose in the cargo area.

Continuing the trip

Reset the Tire Pressure Monitor TPM, refer to page 286

Do not exceed the permissible maximum speed of 50 mph/80 km/h.

Do not exceed a maximum distance travelled of 125 miles/200 km.

Replace the faulty tire and the sealant bottle from the tire repair set as soon as possible.

System limits

Contact your Toyota dealer.

When checking the tire pressure: using sealant can damage the wheel electronics. In this case, have the electronics replaced at the next opportunity.

Changing wheels/tires

General information

If a tire is punctured and loses pressure, it is not necessary to replace the tire immediately if a tire repair kit (Mobility System) is used.

If needed, the tools for changing wheels are available as accessories from your Toyota dealer.



NOTICE

Using an impact wrench to loosen or tighten the wheel lock bolt can damage it. There is a risk of damage to property, among other potential damage. Only use a lug wrench to loosen and tighten the wheel lock bolt.

Lug bolt lock*

*: if equipped

Concept

The wheel lug bolts have a special coding. The lug bolts can only be released with the adapter which matches the coding.

Overview

The adapter of the lug bolt lock is in the onboard vehicle tool kit or in a storage compartment close to the onboard vehicle tool kit.

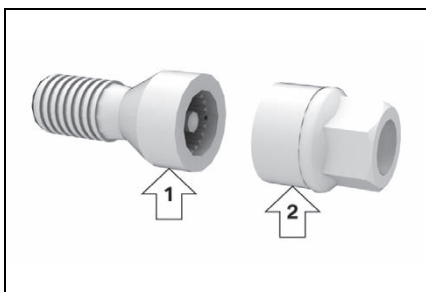

- Lug bolt, arrow 1.
- Adapter, arrow 2.

Unscrewing

- 1 Attach the adapter to the lug bolt.
- 2 Unscrew the lug bolt.
- 3 Remove the adapter after unscrewing the lug bolt.

Screwing on

- 1 Attach the adapter to the lug bolt. If necessary, turn the adapter until it fits on the lug bolt.
- 2 Screw on the lug lock bolt. The tightening torque is 101 lbs ft/140 Nm.
- 3 Remove the adapter and stow it after screwing on the lug bolt.

Engine compartment

Vehicle features and options

This chapter describes all standard, country-specific and optional features offered with the series. It also describes features and functions that are not necessarily available in your vehicle, e.g., due to the selected options or country versions. This also applies to safety-related functions and systems. When using these functions and systems, the applicable laws and regulations must be observed.

Overview

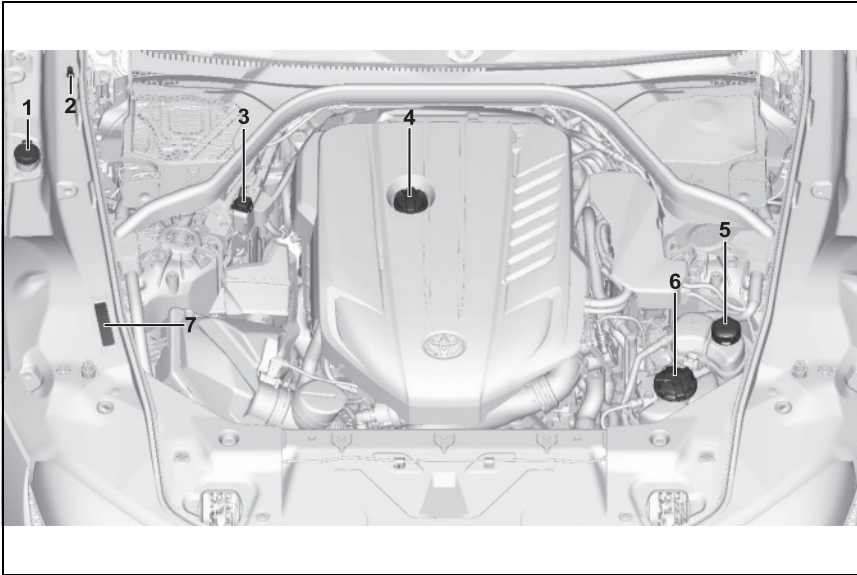

- 1 Filler neck for washer fluid
- 2 Jump-starting, negative battery terminal
- 3 Jump-starting, positive battery terminal
- 4 Oil filler neck
- 5 Coolant reservoir, auxiliary cooling
- 6 Coolant reservoir, engine
- 7 Vehicle identification number

5

MOBILITY

Hood

Safety information

! WARNING

Improperly executed work in the engine compartment can damage components and lead to a safety hazard. There is a risk of accident, injury, and property damage. The vehicle manufacturer recommends having work in the engine compartment performed by your Toyota dealer.

! WARNING

The engine compartment accommodates moving components. Certain components in the engine compartment can also move with the vehicle switched off, for instance the radiator fan. There is a risk of injury. Do not reach into the area of moving parts. Keep articles of clothing and hair away from moving parts.

⚠ WARNING
There are protruding parts, for instance locking hook, on the inside of the hood. There is a risk of injury. If the hood is open, pay attention to protruding parts and keep clear of these areas.

⚠ WARNING
An incorrectly locked hood can open while driving and restrict visibility. There is a risk of accident, injury, and property damage. Stop immediately and correctly close the hood.

⚠ WARNING
Body parts can be jammed when opening and closing the hood. There is a risk of injury. Make sure that the area of movement of the hood is clear during opening and closing.

⚠ NOTICE
Folded-away wipers can be jammed when the hood is opened. There is a risk of damage to property. Make sure that the wipers with the wiper blades mounted are folded down onto the windshield before opening the hood.

Opening

1 Pull lever, arrow 1.

Hood is unlocked.

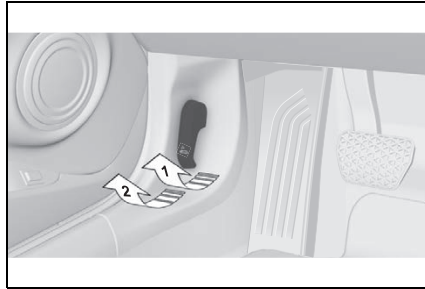

2 After the lever is released, pull the lever again, arrow 2.

Hood can be opened.

3 Be careful of protruding parts on the hood.

Closing

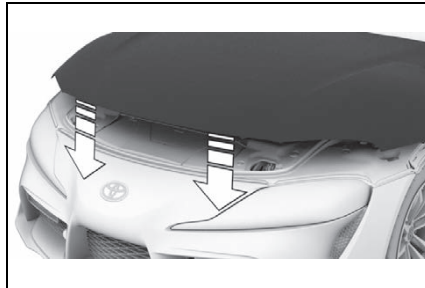

Energetically close the hood from approx. 20 in/50 cm.

The hood must engage on both sides.

Operating materials

Vehicle features and options

This chapter describes all standard, country-specific and optional features offered with the series. It also describes features that are not necessarily available in your vehicle, for instance, due to the selected options or country versions. This also applies to safety-related functions and systems. When using these functions and systems, the applicable laws and regulations must be observed.

Fuel recommendation

General information

Depending on the region, many gas stations sell fuel that has been customized to winter or summer conditions. Fuel that is available in winter, for instance helps make a cold start easier.

Gasoline

General information

For the best fuel consumption, the gasoline should be sulfur-free or very low in sulfur content.

Fuels that are marked on the

gas pump as containing metal must not be used.

Fill up using fuel with a maximum ethanol content of 10 %, e.g., E10.

To achieve nominal values for mileage and consumption, follow the specified fuel quality in the sales literature.

Knocking noises, strange sounds, and driving issues may occur when using fuel with an ethanol content of 10 % to max. 15 %. These have no effect on the engine service life.

Safety information

WARNING

The use of poor-quality fuels may result in harmful engine deposits or damage. Additionally, problems relating to drivability, starting and stalling, especially under certain environmental conditions such as high ambient temperature and high altitude, may occur.

If drivability problems are encountered, we recommend switching to a high quality gasoline brand and a higher octane grade - AKI number - for a few tank fills. To avoid harmful engine deposits, it is highly recommended to purchase gasoline from Top Tier retailers.

Failure to comply with these recommendations may result in the need for unscheduled maintenance.

**WARNING**

Even small quantities of the wrong fuel or wrong fuel additives can damage the fuel system and engine. Furthermore, the catalytic converter can be permanently damaged. There is a risk of injury and risk of damage to property. Do not refuel or add the following in the case of gasoline engines:

- Leaded gasoline.
- Metallic additives, for instance manganese or iron.

Do not press the Start/Stop button after refueling with the wrong fuel. Contact your Toyota dealer.

**NOTICE**

Incorrect fuels can damage the fuel system and the engine. There is a risk of damage to property. Do not use fuels with a higher percentage of ethanol than recommended. Do not refuel with fuels containing methanol, e.g. M5 to M100.

**NOTICE**

Fuel that does not meet the minimum quality requirements can cause the engine to malfunction or become damaged. There is a risk of damage to property. Do not fill with fuel that does not comply with the minimum quality.

Recommended fuel grade

▶ 2.0 models

Toyota recommends AKI 91.

▶ 3.0 and 3.0 Premium models

Toyota recommends AKI 93.

Refuel with this gasoline to

achieve the rated performance and consumption values.

Minimum fuel grade

The minimum grade is AKI 87.

Using fuel with this minimum AKI rating may result in driving issues and strange sounds.

Knocking noises may occur, especially when starting the engine at high temperatures.

This has no effect on the engine's service life.

Engine oil**Vehicle features and options**

This chapter describes all standard, country-specific and optional features offered with the series. It also describes features that are not necessarily available in your vehicle, for instance, due to the selected options or country versions. This also applies to safety-related functions and systems. When using these functions and systems, the applicable laws and regulations must be observed.

General information

The engine oil consumption is dependent on your driving style and driving conditions.

Therefore, regularly check the

engine oil level after refueling by taking a detailed measurement.

The engine oil consumption can increase in the following situations, for example:

- Sporty driving style.
- Break-in of the engine.
- Idling of the engine.
- With use of engine oil types that are not recommended.

Different vehicle messages appear on the Control Display depending on the engine oil level.

The vehicle manufacturer recommends having the engine oil changed by your Toyota dealer. The suitable viscosity grade is indicated on a sign in the engine compartment.

Safety information



NOTICE

An engine oil level that is too low causes engine damage. There is a risk of damage to property. Immediately add engine oil.



NOTICE

Too much engine oil can damage the engine or the catalytic converter. There is a risk of damage to property. Do not add too much engine oil. When too much engine oil is added, have the engine oil level corrected by your Toyota dealer.

Electronic oil measurement

General information

The electronic oil measurement has two measuring principles:

- Monitoring.
- Detailed measurement.

When making frequent short-distance trips or using a sporty driving style, for instance when taking curves aggressively, regularly perform a detailed measurement.

Monitoring

■ Concept

The engine oil level is monitored electronically while driving and can be shown on the Control Display.

If the engine oil level is outside its permissible operating range, a vehicle message is displayed.

■ Functional requirements

A current measured value is available after approx. 30 minutes of normal driving.

■ Displaying the engine oil level

Via Toyota Supra Command:

- 1 "My Vehicle"
- 2 "Vehicle status"
- 3  "Engine oil level"

The engine oil level is displayed.

■ System limits

When making frequent short-distance trips or using a sporty driving style, it may not be possible to calculate a measured value. In this case, the measured value for the last, sufficiently long trip is displayed.

Detailed measurement

■ Concept

The engine oil level is checked when the vehicle is stationary and displayed via a scale.

If the engine oil level is outside its permissible operating range, a vehicle message is displayed.

■ General information

During the measurement, the idle speed is increased somewhat.

■ Functional requirements

- Vehicle is parked in a horizontal position.
- Manual transmission: gear-shift lever in idle position, clutch and accelerator pedals not depressed.
- Automatic transmission: selector lever in selector lever position N or P and accelerator pedal not depressed.
- Engine is running and is at operating temperature.

■ Performing a detailed measurement

Via Toyota Supra Command:

- 1 "My Vehicle"
- 2 "Vehicle status"
- 3  "Engine oil level"
- 4 "Measure engine oil level"
- 5 "Start measurement"

The engine oil level is checked and displayed via a scale.

Adding engine oil

General information

Only add engine oil when the message is displayed in the instrument cluster. The quantity to be added is indicated in the message shown on the Control Display.

Only add suitable types of engine oil, refer to page 307.

Safely park the vehicle and switch off drive-ready state before adding engine oil.

Take care not to add too much engine oil.

Safety information

WARNING

Operating fluids, e.g., oil, grease, coolant, fuel, may contain harmful ingredients. There is a risk of injury and danger to life. Follow the instructions on the containers. Do not allow operating fluids to come into contact with your clothing, skin, or eyes. Do not fill operating fluids into different bottles. Store operating fluids out of reach of children.

NOTICE

An engine oil level that is too low causes engine damage. There is a risk of damage to property. Immediately add engine oil.

NOTICE

Too much engine oil can damage the engine or the catalytic converter. There is a risk of damage to property. Do not add too much engine oil. When too much engine oil is added, have the engine oil level corrected by your Toyota dealer.

Overview

The oil filler neck is located in the engine compartment, refer to page 301.

Adding engine oil

- 1 Open the hood, refer to page 302.

- 2 Open the lid counterclockwise.



- 3 Add engine oil.
- 4 Close the cap.

Engine oil types to add

General information

The engine oil quality is critical for the life of the engine.

Only add the types of engine oil which are listed.

Safety information

NOTICE

Oil additives can damage the engine. There is a risk of damage to property. Do not use oil additives.

NOTICE

Incorrect engine oil can cause malfunctions in the engine or damage it. There is a risk of damage to property. When selecting an engine oil, make sure that the engine oil has the correct oil rating.

Suitable engine oil types

When topping up engine oil, the following oil specification applies:

Gasoline Engine
Toyota Genuine Motor Oil 0W-20 Supra
BMW Longlife-17 FE+ 0W-20

Alternative engine oil types

If an engine oil suitable for continuous use is not available, up to 1 US quart/liter of an engine oil with the following oil rating can be added:

■ **API grade**

API SN PLUS
API SP

■ **Viscosity grade (SAE)**

When selecting an engine oil, make sure that the engine oil has a suitable viscosity grade. The suitable viscosity grade is indicated on a sign in the engine compartment.

More information about suitable oil specifications and engine oil viscosity grades can be requested from your Toyota dealer.

Engine oil change

 **NOTICE**

Engine oil that is not changed in timely fashion can cause increased engine wear and thus engine damage. There is a risk of damage to property. Do not exceed the service data indicated in the vehicle.

The vehicle manufacturer recommends that you have your Toyota dealer change the engine oil.

Coolant

Vehicle features and options

This chapter describes all standard, country-specific and optional features offered with the series. It also describes features that are not necessarily available in your vehicle, for instance, due to the selected options or country versions. This also applies to safety-related functions and systems. When using these functions and systems, the applicable laws and regulations must be observed.

General information

Coolant consists of water and additives.

Coolant consists of water and coolant additive. Not all com-

mercially available additives are suitable for the vehicle. The vehicle manufacturer recommends using coolant with the BMW LC-18 specification. Do not mix additives of different colors. Observe the water - additive mixture ratio of 50:50. Information about suitable additives is available from your Toyota dealer.

Safety information

WARNING

With the engine hot and the cooling system open, coolant can escape and lead to scalding. There is a risk of injury. Only open the cooling system with the engine cooled down.

WARNING

Additives are harmful to health. Using the wrong additives can damage the engine. There is a risk of injury and risk of property damage. Do not allow additives to come into contact with skin, eyes or articles of clothing. Use suitable additives only.

NOTICE

Too much water reduces the coolant's frost protection and corrosion protection. There is a risk of property damage. Use a 50:50 mixing ratio of water to coolant additive.

Coolant level

General information

Depending on the motorization, there are up to two coolant reservoirs in the engine compartment. Check and top up the coolant levels on a regular basis.

The coolant reservoir may be overfilled with coolant when the vehicle is delivered from the factory or following maintenance and repair work. The specified coolant level is achieved with longer operating periods.

The coolant level is indicated using the maximum mark in the filler neck of the coolant reservoir.

Additional information:

For an overview, refer to page 301.

Checking the coolant level

- 1 Let the engine cool.
- 2 Turn off the climate control system. Climate control, refer to page 235.
- 3 Open the hood, refer to page 302.
- 4 Turn the lid of the coolant reservoir slightly counter-clockwise to allow any excess pressure to dissipate, then open it.

- 5 Open the coolant reservoir lid.
- 6 The coolant level is correct when it is just below the maximum mark in the filler neck.

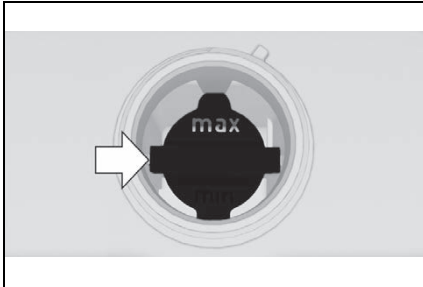

- 7 Close the cap.

Adding

- 1 Let the engine cool.
- 2 Turn off the climate control system. Climate control, refer to page 235.
- 3 Open the hood, refer to page 302.
- 4 Turn the lid of the coolant reservoir slightly counter-clockwise to allow any excess pressure to dissipate, then open it.
- 5 Open the coolant reservoir lid.
- 6 If the coolant is low, slowly add coolant up to the specified level; do not overfill.
- 7 Close the cap.

Disposal



Comply with the relevant environmental protection regulations when disposing of coolant and coolant additives.

Washer fluid

General information

All washer nozzles are supplied from one reservoir.

Use a mixture of tap water and windshield washer concentrate. If desired, a windshield washer concentrate containing anti-freeze can be used.

Recommended minimum fill quantity: 0.2 US gal/1 liter.

Safety information**WARNING**

Some antifreeze agents can contain harmful substances and are flammable. There is a risk of fire and a risk of injury. Follow the instructions on the containers. Keep antifreeze away from ignition sources. Do not refill operating materials into different bottles. Store operating materials out of reach of children.

United States: the washer fluid mixture ratio is regulated by the U.S. EPA and many individual states; do not exceed the allowable washer fluid dilution ratio limits that apply. Follow the usage instructions on the washer fluid container.

WARNING

Washer fluid can ignite and catch fire on contact with hot engine parts. There is a risk of injury and risk of damage to property. Only add washer fluid when the engine is cooled down. Next, fully close the lid of the washer fluid reservoir.

NOTICE

Silicon-containing additives in the washer fluid for the water-repelling effect on the windows can lead to damage to the washing system. There is a risk of damage to property. Do not add silicon-containing additives to the washer fluid.

NOTICE

Mixing different windshield washer concentrates or antifreeze can damage the washing system. There is a risk of damage to property. Do not mix different windshield washer concentrates or antifreeze. Follow the information and mixing ratios provided on the containers.

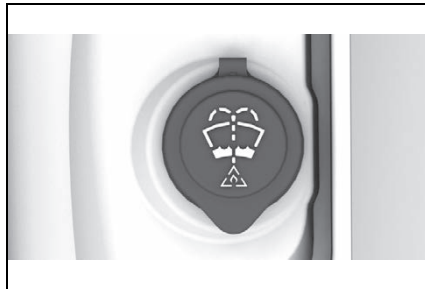
Overview

The washer fluid reservoir is located in the engine compartment.

Malfunction

The use of undiluted windshield washer concentrate or alcohol-based antifreeze can lead to incorrect readings at temperatures below +5°F/-15°C.

Maintenance

Vehicle features and options

This chapter describes all standard, country-specific and optional features offered with the series. It also describes features and functions that are not necessarily available in your vehicle, e.g., due to the selected options or country versions. This also applies to safety-related functions and systems. When using these functions and systems, the applicable laws and regulations must be observed.

Maintenance system

The maintenance system provides service notifications and thereby provides support in maintaining road safety and the operational reliability of the vehicle.

In some cases, scopes and intervals of the maintenance system may vary according to the country version. Replacement work, spare parts, fuels and lubricants, and wear materials are calculated separately. Further information is available from a Toyota dealer.

Condition Based Service CBS

Concept

Condition Based Service CBS determines the maintenance recommendation using sensors and special algorithms that take into account the driving conditions of the vehicle.

The system makes it possible to adapt the amount of maintenance corresponding to your user profile.

General information

Information on service notifications, refer to page 149, can be displayed on the Control Display.

Storage periods

Storage periods during which the vehicle battery was disconnected are taken into account.

Have any time-dependent maintenance measures, e.g., changing the brake fluid, engine oil, or microfilter/activated carbon filter, performed by your Toyota dealer.

"Owner's Warranty Information Booklet" or "Owner's Manual Supplement"

Please consult "Owner's Warranty Information Booklet" or "Owner's Manual Supplement" for additional information on service and maintenance work.

The manufacturer of your vehicle recommends that maintenance and repair be performed by a Toyota dealer. Records of regular maintenance and repair work should be retained.

Scheduled maintenance

Scheduled maintenance should be performed at specified intervals according to the maintenance schedule.

For details about maintenance items and schedules, refer to the "Scheduled Maintenance Guide" or "Owner's Manual Supplement".

Diagnostic socket

General information

The alarm system is triggered when the vehicle is locked while devices are connected to the diagnostic socket. Remove any devices connected at the diagnostic socket before locking the

vehicle.

Additional information:

Indicator/warning lights, refer to page 142.

Safety information

NOTICE

The diagnostic socket is an intricate component intended to check the vehicle's primary emissions system when used in conjunction with specialized equipment. Improper use of the diagnostic socket, or using the diagnostic socket for anything other than its intended purpose, can cause the vehicle to malfunction and result in personal and property damage. As such, it is strongly recommended that access to the diagnostic socket be restricted to your Toyota dealer, or other persons who have specialized training and equipment and who are able to use the diagnostic socket correctly.

Position



There is a diagnostic socket on the driver's side for checking the primary components in the vehicle's emissions.

Exhaust emissions

- The warning light illuminates:

Worsening exhaust emissions, e.g., due to an incorrectly fitted fuel cap. Have the vehicle checked as soon as possible.

- The warning light flashes under certain circumstances:

This indicates that there is excessive misfiring in the engine.



Reduce the vehicle speed and have the system checked immediately; otherwise, serious engine misfiring within a brief period can seriously damage emission control components, in particular the catalytic converter.

Have the vehicle checked by your Toyota dealer.

Replacing components

Vehicle features and options

This chapter describes all standard, country-specific and optional features offered with the series. It also describes features and functions that are not necessarily available in your vehicle, e.g., due to the selected options or country versions. This also applies to safety-related functions and systems. When using these functions and systems, the applicable laws and regulations must be observed.

Onboard vehicle tool kit

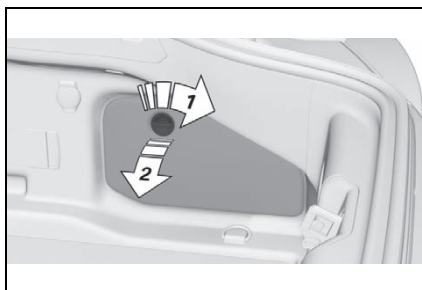

The onboard vehicle tool kit is located under a cover on the right side of the cargo area.

Unlock the cover of the right side panel, arrow 1, and fold open, arrow 2.

Wiper blades

Safety information

NOTICE

The window may sustain damage if the wiper falls onto it without the wiper blade installed. There is a risk of damage to property. Hold the wiper firmly when changing the wiper blade. Do not fold or switch on the wiper without a wiper blade installed.

NOTICE

Folded-away wipers can be jammed when the hood is opened. There is a risk of damage to property. Make sure that the wipers with the wiper blades mounted are folded down onto the windshield before opening the hood.

NOTICE

When replacing the wiper blades, perform the procedure quickly and do not leave the wiper arms lifted without the wiper blades for longer than necessary.

Replacing the front wiper blades

- 1 To change the wiper blades, fold up the wiper arms, refer to page 130.
- 2 Stop the vehicle.

- 3 Lift the wiper all the way off of the windshield.

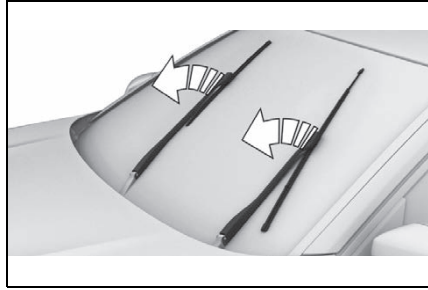

- 4 Press the button, arrow 1, and pull out the wiper blade, arrow 2.

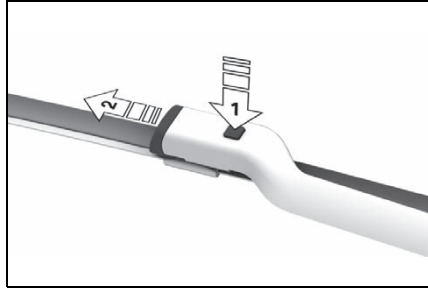

- 5 Insert the new wiper blade and press it on until it you hear it snap into the holder.
- 6 Fold down the wipers.

Lights and bulbs

General information

Lights and bulbs make an essential contribution to vehicle safety.

All headlights and lights are made using LED technology.

In the event that they are no longer operating properly, have the

headlights and lights checked by your Toyota dealer.

Safety information

WARNING

Focused laser light can irritate or permanently damage the retina of the eye. There is a risk of injury. The manufacturer of your vehicle recommends that the work on the lighting system including bulb replacement be performed by your Toyota dealer.

WARNING

Intensive brightness can irritate or damage the retina of the eye. There is a risk of injury. Do not look directly into the headlights or other light sources. Do not remove the LED covers.

Headlight glass

Condensation can form on the inside of the headlight glass in cool or humid weather. When driving with the lights switched on, the condensation evaporates after a short time. The headlight glass does not need to be changed.

If despite driving with the headlights switched on, increasing humidity forms, for instance water droplets in the light, have the headlights checked.

Vehicle battery

General information

The battery is maintenance-free.

If the event of a manufacturer recommends having any necessary work, e.g., replacing the vehicle battery, performed by your Toyota dealer.

More information regarding the battery can be requested from your Toyota dealer.

The manufacturer of your vehicle recommends that you have your Toyota dealer register the vehicle battery to the vehicle after the battery has been replaced. Once the battery has been registered again, all comfort features will be available without restriction and any vehicle messages displayed which relate to comfort features will disappear.

When replacing the battery

The installed battery is designed specifically for this vehicle. If an inappropriate battery is used, operation of the Auto Start Stop function may be restricted in order to protect the battery. Also, the battery may deteriorate faster than normal and the engine may not be able to be restarted. Contact your Toyota

dealer for details.

Safety information





⚠ WARNING
 Contact with live components can lead to an electric shock. There is a risk of injury and danger to life. Do not touch any components that are under voltage.

⚠ WARNING
 Vehicle batteries that are not recommended can damage vehicle systems and impair vehicle functions. There is a risk of accident, injury, and property damage. Only use vehicle batteries recommended by the vehicle manufacturer. For information on suitable vehicle batteries, contact your Toyota dealer.

Hazard icons

The following hazard icons can be found on the vehicle battery:

Symbol	Meaning
	No smoking, no open flames, no sparks.
	Wear safety goggles.
	Keep away from children.
	Risk of chemical burn: wear gloves, do not tilt battery.

Symbol	Meaning
	Flush acid splashes with water immediately. In the event of contact with the eyes or swallowing, seek a physician immediately.
	No direct daylight, no frost.
	Follow the operating instructions.
	Explosive gas mixture. Do not close any openings of the battery.

Charging the battery

General information

Make sure that the battery is always sufficiently charged to guarantee that the battery remains usable for its full service life.



A discharged battery is indicated by a red indicator light.

Charge the battery when acceleration is insufficient.

The following circumstances can have a negative effect on the performance of the battery:

- Frequent short-distance drives.

- The vehicle is not used for more than a month.

Safety information

WARNING

Battery chargers for the vehicle battery can work with high voltages and currents, which means that the 12 volt on-board network can be overloaded or damaged. There is a risk of injury and risk of damage to property. Only connect battery chargers for the vehicle battery to the starting aid terminals in the engine compartment.

Charging the battery

Charge the battery only when the engine is off and via the starting aid terminals, refer to page 329, in the engine compartment.

Power failure

After a power loss, some equipment needs to be newly initialized or individual settings updated, for example:

- Memory function: store the positions again.
- Time: update.
- Date: update.

Disposing of old batteries



Have old batteries disposed of by your Toyota dealer or take them to a collection point.

Maintain the battery in an upright position for transport and storage. Secure the battery so that it does not tip over during transport.



Batteries contain harmful chemicals. It is prohibited by law to dispose of batteries together with household waste.

Fuses

General information

The fuses are located at different places in the vehicle.

Safety information

WARNING

Incorrect and repaired fuses can overload electrical lines and components. There is a risk of fire, injury, and property damage. Never attempt to repair a blown fuse. Do not replace a nonworking fuse with a substitute of another color or amperage rating.

In the car's interior

The fuses are located in the car's interior in the front passen-

ger floor area behind a cover.

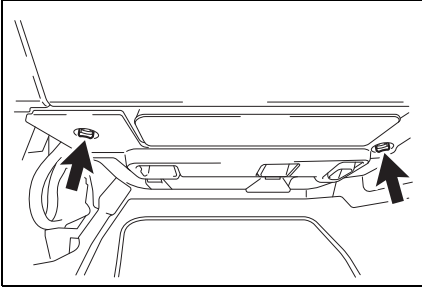

Loosen fasteners, arrows, and open cover.

The fuse box is located on the front right.

In the cargo area

The fuses are located in the cargo area on the right side behind a cover.

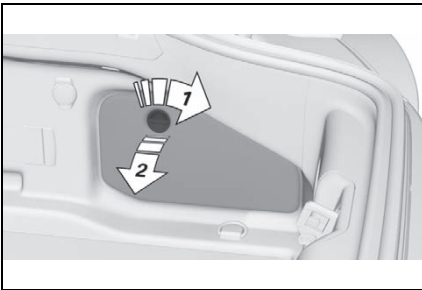

Unlock the cover of the right side panel, arrow 1, and fold open, arrow 2.

Additional fuse boxes

Additional fuse boxes are located in the vehicle. In the case of a malfunction, contact your Toyota dealer.

Replacing fuses

The vehicle manufacturer recommends that you have your Toyota dealer replace the fuses.

Fuse informations

- BDC

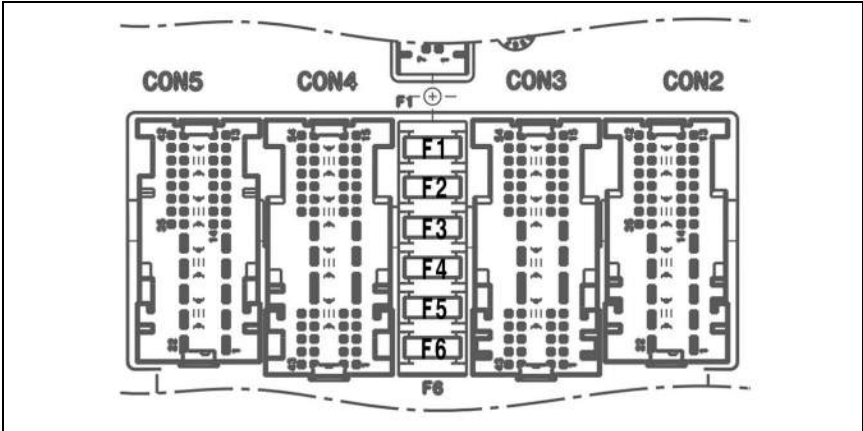

- Front

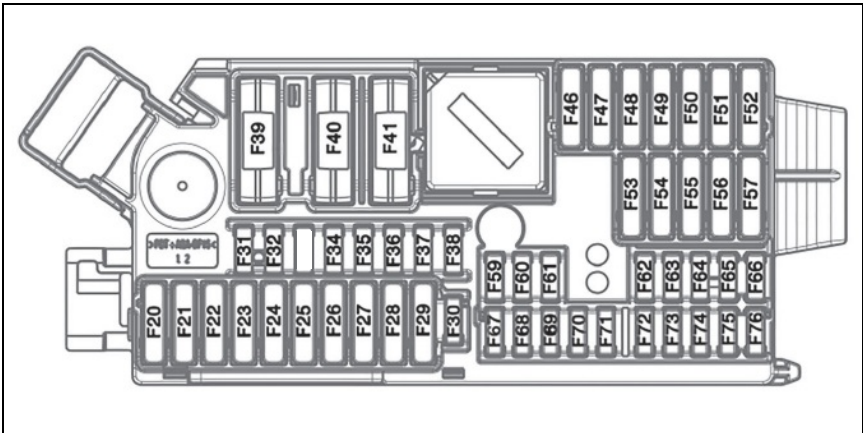

● Rear

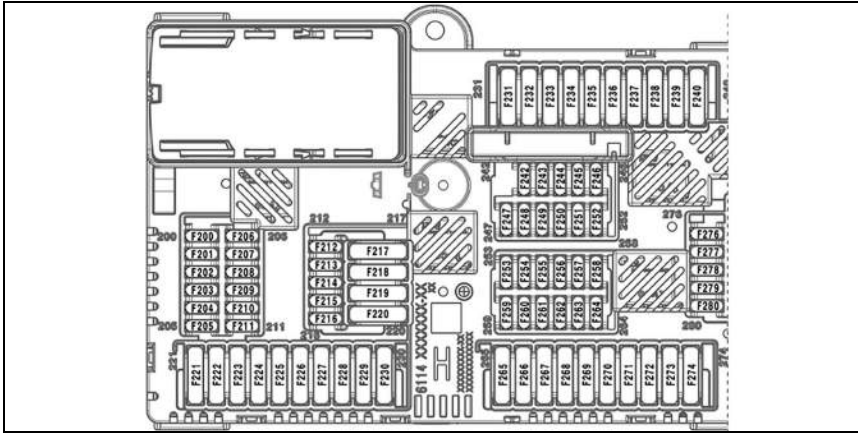

● Fuse values













BDC →		F:						FB front →		F:																												
		1	2	3	4	5	6			20	21																											
		[A]	5	7.5	7.5	5	20	20	[A]	30	30																											
F:	22	23	24	25	26	27	28	29	30	31	32	34	35	36	37	38	39	40	41	46	47	48	49	50	51	52	53	54	55									
[A]	30	30	30	20	40	10	40	20	15	15	5	5	5	5	5	5	60	40	-	20	20	20	10	30	30	20	30	20	30									
F:	56	57	59	60	61	62	63	64	65	66	67	68	69	70	71	72	73	74	75	76																		
[A]	30	10	5	4	5	5	5	5	5	5	5	5	5	5	5	5	7.5	5	10	10	5																	
												FB rear →		F:																								
														200	201	202	203	204	205	206	207	208	209	210	211	212	213	214	215	216	217	218	219	220	221	222	223	
														[A]	-	-	-	7.5	5	-	5	*	5	5	5	-	15	-	5	5	5	40	20	-	30	-	-	-
F:	224	225	226	227	228	229	230	231	232	233	234	235	236	237	238	239	240	242	243	244	245	246	247	248	249	250	251	252	253	254								
[A]	-	30	40	30	-	40	30	30	40	-	-	-	-	-	*	-	20	7.5	-	5	-	-	10	-	-	5	20	5	20	5								
F:	255	256	257	258	259	260	261	262	263	264	265	266	267	268	269	270	271	272	273	274	276	277	278	279	280													
[A]	5	7.5	5	5	15	5	-	5	-	10	30	40	30	40	30	-	30	-	20	-	-	-	5	*	5													







F: Fuse









[A]: Ampere (Fuse - Value)













*: Spare Slot













	F28
	F28, F32
A/C	F3, F40, F204
	F40
	F231
	F48, F52, F269, F271
	F55, F56, F64, F65, F67, F68
	F75
	F1, F49, F57, F210
	F215, F217
	F59
	F32, F36, F244
	F34, F73
	F36, F63
	F206, F244, F271
	F20, F21





	F3
OBD	F2
	F2
	F2, F29
	F2
DRIVING ASSISTANCE	F1, F59, F60, F76, F204, F208, F209, F255
	F4, F212, F214
MEDIA	F1, F32, F59, F212, F214, F215, F216, F217, F218, F220
	F214
BDC	F39
	F252
	F32, F70, F209
	F46, F273
	F3, F254
	F4, F5, F6, F244
	F51

	F4
	F70
	F51, F63, F70, F203, F206, F209
	F1, F3, F39
	F36, F61, F62, F67, F68, F71
	F4
	F67, F68

Symbol	Meaning
	VSC Vehicle Stability Control System
	Parking brake
	Air conditioning
	Blower motor, Interior ventilation
	Rear window heating
	Seat heating
	Seat setting
	Crash-security module

Symbol	Meaning
	Switching center column, Light switch element, steering Operating panel Audio
	HiFi amplifier, Video module TV
	Rear-view mirror
	Overhead function center, Exterior door handle electronics
	Instrument cluster
	Additional battery: Dual Accumulator System (DSS)
	Fuel pump control electronics, Natural Vacuum Leak Detection, Gas generator for battery safety terminal, Remote control receiver
	Electric window opener
	Heating and air-conditioning system
	Vehicle's diagnostic port (interface)
	Vertical Dynamic platform
	Vertical Dynamic platform
	Vertical Dynamic platform

Symbol	Meaning
	Mono Camera (Kafas)
	Head Unit
MEDIA	Active Sound Design
	USB Hub
BDC	Body Domain Controller
	Controller (Toyota Supra Command)
	Electric fan (air cooler), Controlled differential lock
	12 V socket, Cigarette lighter
	Interior lights in the boot
	Door lock, Exterior door handle electronics, Telematic Communication Box
	Electronic gear box control
	Telematic Communication Box, Exterior door handle electronics
	Electric fan, Rear Power distributor
	Engine control

Symbol	Meaning
	Switching center column, Light switch element, Body Domain Controller
	Control panels centre console, Interior light in the glove box, Interior light in the sunvisor, Exterior mirror, Selector lever
	Telematic Communication Box, Exterior door handle electronics passenger side
	Switcher block driver's door, Exterior mirror

Breakdown assistance

Vehicle features and options

This chapter describes all standard, country-specific and optional features offered with the series. It also describes features and functions that are not necessarily available in your vehicle, e.g., due to the selected options or country versions. This also applies to safety-related functions and systems. When using these functions and systems, the applicable laws and regulations must be observed.

If a malfunction occurs while driving

WARNING

If a malfunction occurs while driving, immediately stop the vehicle in a safe place.

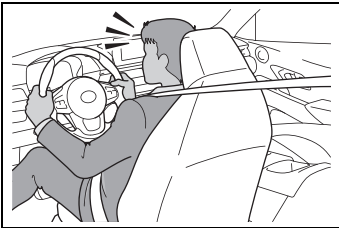

If a warning light illuminates or flashes, or a warning message is displayed, immediately stop the vehicle in a safe place. Do not open the hood to inspect the engine, as doing so may lead to serious injury, such as steam burns. If a warning message is displayed, perform the necessary procedures according to the displayed message or explanation in the owner's manual.

These warning messages indicate that a malfunction has occurred in a system or function of the vehicle. If you continue to drive the vehicle, the engine may stop suddenly, possibly leading to an accident. Also, even if no warning lights are illuminated or messages are displayed, if any abnormal sounds, smells or vibrations are detected, or if the engine stops suddenly, refrain from opening the hood to inspect the engine and consult your Toyota dealer.

WARNING

If you hear a loud noise or feel something impact the underside of the vehicle while driving, immediately stop the vehicle in a safe place.

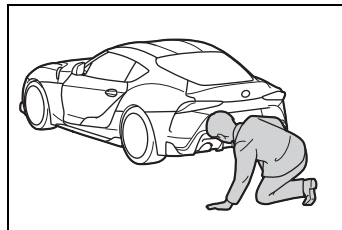

After stopping the vehicle in a safe place, check the underside of the vehicle for any leaking brake fluid, oil or fuel. If any fluid is leaking, stop driving immediately and have the vehicle inspected by your Toyota dealer.

⚠ WARNING

Brake and fuel lines run under the floor of the vehicle. If any of these lines are damaged, the brakes may fail or leaking fuel may ignite and cause a fire.

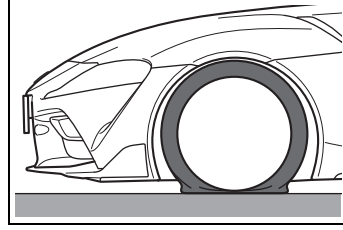
**⚠ WARNING**

During normal driving, do not turn off the engine. Turning the engine off while driving will not cause loss of steering or braking control, but the power assist to these systems will be lost. This will make it more difficult to steer and brake, so you should pull over and stop the vehicle as soon as it is safe to do so.

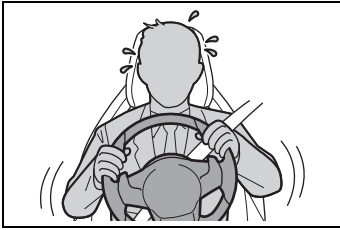
**⚠ WARNING**

While driving, if a tire has been punctured or has ruptured, firmly grip the steering wheel, gradually reduce the vehicle speed and stop the vehicle in a safe place. Avoid sudden braking and steering operations as doing so may cause you to lose control of the vehicle. Gradually reduce the vehicle speed and stop the vehicle in a safe place.

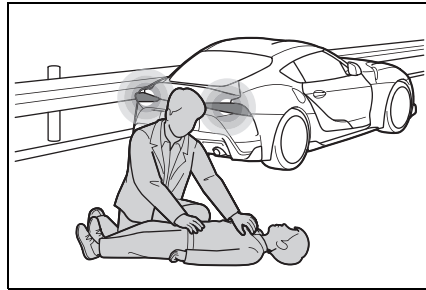
If you have been involved in a collision

If you have been involved in a collision, perform the following:

- 1** Immediately leave the vehicle and move to a safe place in order to avoid secondary collisions. Make sure to turn the engine switch off to help prevent the vehicle from catching fire. If the airbags have deployed (inflated), the airbag related parts will be extremely hot. Avoid touching the parts with your hands or any part of your body.
- 2** If someone has been injured, contact emergency services and request assistance. If someone has no obvious external injuries, but they may have a head injury, keep

their airway open while moving them as little as possible. If there is danger of the vehicle being involved in a secondary collision, move the injured person to a safe place while keeping them as horizontal as possible.

Hazard warning flashers



The button is located in the center console.

The red light in the button flashes when the hazard warning flashers are activated.

Warning triangle*

*: if equipped

- 1 Unlock the cover, arrow 1, and fold open, arrow 2.

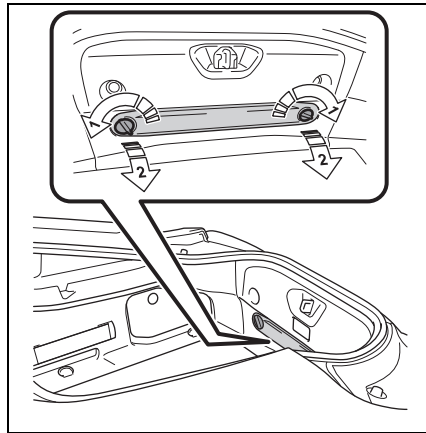

- 2 Remove the warning triangle.

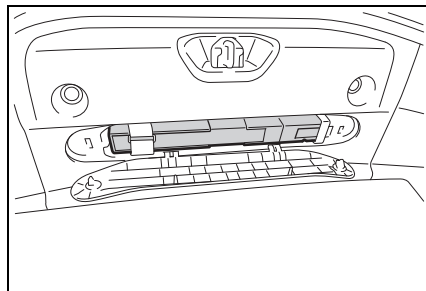

Roadside assistance

Concept

Contact the roadside assistance if assistance is needed in the event of a breakdown.

General information

In the event of a breakdown, data on the vehicle's condition is transmitted to the roadside assistance.

Roadside assistance can also

be contacted via a vehicle message, refer to page 141.

Functional requirements

- Active Toyota Supra Connect contract.
- Cellular network reception.
- Standby state is switched on.

Starting roadside assistance

Via Toyota Supra Command:

- 1 "Toyota Supra Connect"
- 2 "Toyota Supra Assistance"
- 3 "Roadside assistance"

A voice connection is established.

Emergency call

Automatic emergency call

Concept

In case of an emergency, an emergency call can be triggered automatically by the system or manually.

General information

Only press the SOS button in an emergency.

The automatic emergency call establishes a connection with the Toyota Emergency Call Center.

For technical reasons, the emergency call cannot be guaranteed under unfavorable conditions.

Overview



SOS button.

Functional requirements

- Active Toyota Supra Connect contract.
- Standby state is switched on.
- The automatic emergency call is functional.
- The SIM card integrated in the vehicle has been activated.

Automatic triggering

Under certain conditions, for instance if the airbags trigger, an emergency call is automatically initiated immediately after an accident of corresponding severity. Automatic emergency call is not affected by pressing

the SOS button.

Manual triggering

- 1 Tap the cover.
- 2 Press and hold the SOS button until the LED in the area of the button illuminates green.
 - The LED is illuminated green when an emergency call has been initiated.

If a cancel prompt appears on the Control Display, the emergency call can be aborted.

If the situation allows, wait in your vehicle until the voice connection has been established.

- The LED flashes green when a connection to the Toyota Emergency Call Center has been established.

The Toyota Emergency Call Center then makes contact with the occupants of the vehicle and initiates further steps to help.

Even if you are unable to respond, the Toyota Emergency Call Center can take further steps to help you under certain circumstances.

For this, data is transmitted to the Toyota Emergency Call Center which serves to determine the necessary rescue measures. E.g., the current position of the vehicle, if it can be established.

Even if the Toyota Emergency Call Center is no longer heard through the loudspeakers, the Toyota Emer-

gency Call Center may still be able to hear the occupants of the vehicle.

The Toyota Emergency Call Center ends the Emergency call.

Jump-starting

General information

If the battery is discharged, the engine can be started using the battery of another vehicle and two jumper cables. Only use jumper cables with fully insulated clamp handles.

Safety information

WARNING

Contact with live components can lead to an electric shock. There is a risk of injuries and danger to life. Do not touch any components that are under voltage.

WARNING

If the jumper cables are connected in the incorrect order, sparking may occur. There is a risk of injury. Pay attention to the correct order during connection.

WARNING

In the case of body contact between the two vehicles, a short circuit can occur during jump-starting. There is a risk of injury and risk of damage to property. Make sure that no body contact occurs.

Preparation

- 1 Check whether the battery of the other vehicle has a voltage of 12 volts. The voltage information can be found on the battery.
- 2 Switch off the engine of the assisting vehicle.
- 3 Switch off any electronic systems/power consumers in both vehicles.

Starting aid terminals

The starting aid terminal in the engine compartment acts as the positive battery terminal.

A special connection on the body in the engine compartment acts as the negative battery terminal.

Additional information:

Overview of engine compartment, refer to page 301.

Open the cover of the positive battery terminal.

Connecting the cables

Before you begin, switch off all unnecessary electronic systems/power consumers, such as the radio, on the assisting and receiving vehicle.

- 1 Open the cover of the starting aid terminal.

- 2 Attach one terminal clamp of the positive jumper cable to the positive terminal of the battery, or to the corresponding starting aid terminal of the vehicle providing assistance.
- 3 Attach the terminal clamp on the other end of the cable to the positive terminal of the battery, or to the corresponding starting aid terminal of the vehicle to be started.
- 4 Attach one terminal clamp of the negative jumper cable to the negative terminal of the battery, or to the corresponding engine or body ground of assisting vehicle.
- 5 Attach the second terminal clamp to the negative terminal of the battery, or to the corresponding engine or body ground of the vehicle to be started.

Starting the engine

Never use spray fluids to start the engine.

- 1 Start the engine of the assisting vehicle and let it run for several minutes at an increased idle speed.
- 2 Start the engine of the vehicle that is to be started in the usual way.

If the first starting attempt is not successful, wait a few minutes before making another attempt in

order to allow the discharged battery to recharge.

- 3 Let both engines run for several minutes.
- 4 Disconnect the jumper cables in the reverse order.

Check the battery and recharge, if needed.

Tow-starting and towing

Safety information

WARNING

When towing with the Toyota Supra Safety systems activated, individual functions may not work correctly. There is a risk of an accident, injury, and property damage. Switch off all Toyota Supra Safety system before towing.

Manual transmission

Safety information

WARNING

The vehicle can become damaged when lifting and securing it. There is a risk of injury and risk of damage to property.

- Only lift the vehicle using a suitable device.
- Do not lift or secure the vehicle on the towing eye, rims, body components, or chassis components.

- For transport, secure the vehicle by placing special tire straps over the tire tread surfaces in the vehicle's longitudinal direction.

Towing or pushing the vehicle

A broken-down vehicle can be towed or pushed.

Follow the following instructions:

- Make sure that the standby state is switched on; otherwise, the low beams, tail lights, turn signals, and wipers may be unavailable.
- Do not tow the vehicle with the rear axle tilted, as the front wheels could turn.
- When the engine is stopped, there is no power assistance. Consequently, more effort needs to be applied when braking and steering.
- Larger steering wheel movements are required.
- The towing vehicle must not be lighter than the vehicle being towed; otherwise, it will not be possible to control handling.
- Do not exceed a towing speed of 30 mph/50 km/h.
- Do not exceed a towing distance of 30 miles/50 km.

Additional information:

Rolling or pushing the vehicle,

refer to page 131.

Tow truck

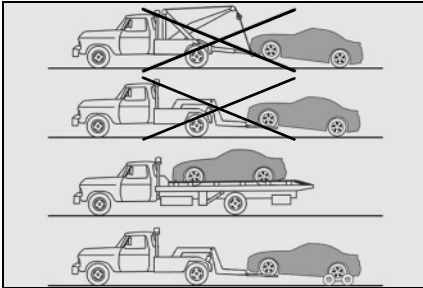

Have the vehicle transported by a tow truck with spectacle lift, on a loading platform, or with a tow dolly.

When using a tow dolly, make sure that none of the wheels touch the ground. This method should be used for distances of 124 miles/200 km. Note the loads and speeds specified by the tow dolly manufacturer.

Automatic transmission: transporting the vehicle

General information

The vehicle must be transported on a loading platform or tow dolly.

Safety information

⚠ WARNING

The vehicle can become damaged when lifting and securing it. There is a risk of injury and risk of damage to property.

- Only lift the vehicle using a suitable device.
- Do not lift or secure the vehicle on the towing eye, rims, body components, or chassis components.
- For transport, secure the vehicle by placing special tire straps over the tire tread surfaces in the vehicle's longitudinal direction.

Pushing the vehicle

To remove a broken-down vehicle from the hazard area, it can be pushed for distances of approx. 328 ft/100 m at a speed of max. 6 mph/10 km/h.

For rolling or pushing the vehicle, refer to page 134.

Tow truck

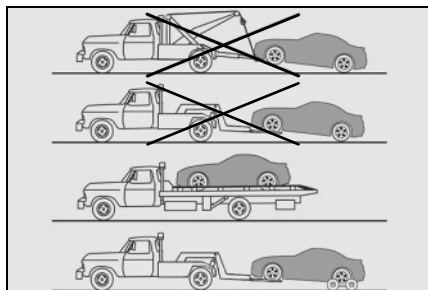

Have vehicle transported on a loading platform or use a tow

dolly.

When using a tow dolly, make sure that none of the wheels touch the ground. This method should be used for distances of max. 124 miles/200 km. Follow the instructions, as well as specified loads and speeds, given by the tow dolly manufacturer.

Towing other vehicles

General information

Switch on the hazard warning system, depending on local regulations.

If the electrical system has failed, clearly identify the vehicle being towed by placing a sign or a warning triangle in the rear window.

Safety information

WARNING

If the approved gross vehicle weight of the towing vehicle is lighter than the vehicle to be towed, the towing eye can tear off or it will not be possible to control vehicle handling. There is a risk of accident, injury, and property damage. Make sure that the gross vehicle weight of the towing vehicle is heavier than the vehicle to be towed.



NOTICE

If the tow bar or tow rope is attached incorrectly, damage to other vehicle parts can occur. There is a risk of damage to property. Correctly attach the tow bar or tow rope to the tow fitting.

Tow bar

The tow fittings used should be on the same side on both vehicles.

Should it prove impossible to avoid mounting the tow bar at an offset angle, please follow the following:

- Maneuvering capability is limited going around corners.
- The tow bar will generate lateral forces if it is secured with an offset.

Tow rope

Observe the following notes when using the tow rope:

- Use nylon ropes or straps, which will enable the vehicle to be towed without jerking.
- Make sure the tow rope is not twisted when fastening.
- Check the fastening of the tow fitting and tow rope in regular intervals.
- Do not exceed a towing speed of 30 mph/50 km/h.
- Do not exceed a towing distance of 3 miles/5 km.

- When starting to tow the vehicle, make sure that the tow rope is taut.

Tow fitting

Principle

The tow fitting is a device that can be screwed onto the vehicle in order to, e.g., secure tow cables or tow rods.

General information



The screw-in tow fitting should always be carried in the vehicle.

The tow fitting can be screwed in at the front or rear of the vehicle.

The tow fitting is found in the onboard vehicle tool kit, refer to page 314.

Safety information

NOTICE

If the tow fitting is not used as intended, there may be damage to the vehicle or to the tow fitting. There is a risk of damage to property. Follow the notes on using the tow fitting.

Using the tow fitting

When using the tow fitting, note the following:

- Use only the tow fitting provided with the vehicle.
- Turn the tow fitting at least 5 turns clockwise and screw it in as far as it will go. If necessary, tighten with a suitable object.
- After use, unscrew the tow fitting counter clockwise.
- Use the tow fitting for towing on paved roads only.
- Avoid lateral loading of the tow fitting, for instance do not lift the vehicle by the tow fitting.
- Check the attachment of the tow fitting in regular intervals.

Screw thread for tow fitting

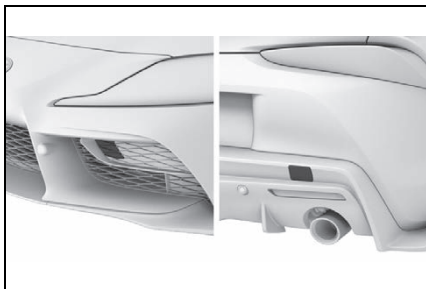

Press on the mark on the edge of the cover to push it out.

For covers which have an opening instead of a marking, pull the cover out by the opening.

Tow-starting

Do not tow-start the vehicle.

Start the engine by jump-starting, refer to page 329, if possible.

Have the reasons for the starting difficulties corrected by your Toyota dealer.

Care

Vehicle features and options

This chapter describes all standard, country-specific and optional features offered with the series. It also describes features and functions that are not necessarily available in your vehicle, e.g., due to the selected options or country versions. This also applies to safety-related functions and systems. When using these functions and systems, the applicable laws and regulations must be observed.

Washing the vehicle

General information

Regularly remove foreign objects such as leaves in the area below the windshield when the hood is raised.

Wash your vehicle frequently, particularly in winter. Intense soiling and road salt can damage the vehicle.

Safety information

 **WARNING**

When driving, high temperatures can occur underneath the vehicle body, e.g., due to the exhaust system, brakes or radiator. Contact with the hot components can cause burns. There is a risk of injury. Do not touch hot components. Do not perform work in the vicinity of hot components until after they have cooled down.

 **WARNING**

When washing with an open fuel filler flap, damage may occur. There is a danger of damage to property. Close the fuel filler flap before washing. Clean dirt behind the fuel filler flap with a cloth.

Steam-jet cleaner and high pressure cleaner

Safety information

 **NOTICE**

When using high-pressure cleaners, components can be damaged due to the pressure or high temperatures or because an insufficient distance was maintained. There is a risk of property damage. Make sure that sufficient distance is maintained. Do not spray continuously on one spot. Follow the operating instructions for the high pressure cleaners.

Distances and temperature

When cleaning with a steam/high-pressure cleaner, make sure to use the specified

temperatures and distances.

Maximum temperature: 140 °F/60 °C. Minimum distance of 12 in/30 cm to the following components:

- Sensors.
- Cameras.
- Seals.
- Lights.
- Air inlets in front of vehicle.
- Cables.
- Plug connectors.

Automatic vehicle washes

Safety information

 **NOTICE**

Water can penetrate in the windshield area due to high-pressure washers. There is a risk of damage to property. Avoid high-pressure washers.

 **NOTICE**

Improper use of automatic vehicle washes can cause damage to the vehicle. There is a risk of damage to property. Follow the following instructions:

- Give preference to cloth vehicle washes or those that use soft brushes in order to avoid paint damage.
- Note the permissible vehicle dimensions for the car wash.

**NOTICE**

- Avoid vehicle washes with guide rails higher than 4 in/10 cm to avoid damage to the chassis.
- Observe the tire width of the guide rail to avoid damage to tires and rims.
- Fold in exterior mirrors to avoid damage to the exterior mirrors.
- Deactivate the wiper and, if necessary, rain sensor to avoid damage to the wiper system.
- Do not treat the convertible top with wax. Ensure that a cycle without wax or a special cycle for convertibles is available to avoid damage to the convertible top.

Driving into a vehicle wash with a manual transmission

In a car wash, the vehicle must be able to roll freely. To roll or push the vehicle, refer to page 131.

Driving into a vehicle wash with an automatic transmission**■ Safety information****NOTICE**

Selector lever position P is automatically engaged when standby state is switched off. There is a risk of damage to property. Do not switch standby state off in vehicle washes.

■ General information

In a vehicle wash, the vehicle must be able to roll freely.

To roll or push the vehicle, refer to page 134.

Some vehicle washes do not permit persons in the vehicle. The vehicle cannot be locked from the outside when in selector lever position N. A signal sounds when an attempt is made to lock the vehicle.

Driving out of a vehicle wash

Make sure that the remote control is in the vehicle.

Switch on drive-ready state, refer to page 47.

Lights

Do not rub wet lights dry and do not use abrasive, acidic cleaning agents or cleaning agents containing alcohol.

Soak areas that have been dirtied, for instance from insects, with shampoo and wash off with water.

Thaw ice with de-icing spray; do not use an ice scraper.

After washing the vehicle

After washing the vehicle, apply the brakes briefly to dry them. Otherwise, their braking effect may be reduced. The heat gen-

erated while braking dries brake disks and brake pads and protects them against corrosion.

Completely remove all residues on the windows, to minimize loss of visibility due to smearing and to reduce wiper noises and wiper blade wear.

Vehicle care

Vehicle care products

Safety information

WARNING

Cleansers can contain substances that are dangerous and harmful to your health. There is a risk of injury and risk of damage to property. When cleaning the interior, open the doors or windows. Only use cleaning agents that are intended for cleaning the respective component. Follow the instructions on the packaging.

Vehicle paint

General information

Regular care contributes to driving safety and value retention. Environmental influences in areas with elevated air pollution or natural contaminants, such as tree resin or pollen can affect the vehicle's paintwork. Tailor the frequency and extent of your vehicle care to these influences.

Aggressive substances such as spilled fuel, oil, grease or bird droppings, must be removed immediately to prevent the finish from being altered or discolored.

Matte finish

Perform the following to protect the vehicle.

- Working from top to bottom, liberally apply water to the vehicle body, wheel wells and underside of the vehicle to remove any dirt and dust.
- Wash the vehicle body using a sponge or soft cloth, such as a chamois.
- For hard-to-remove marks, use a neutral detergent and rinse thoroughly with water.
- Wipe away any water.
- Never use wax or abrasive compounds.

Safety information

WARNING

Improperly performed work on the vehicle paint can lead to a failure or malfunction of the radar sensors and thereby result in a safety risk. There is a risk of accidents or risk of damage to property. Have paintwork or paintwork repairs on bumpers of vehicles with radar sensors performed by your Toyota dealer only.

**NOTICE****■ To prevent paint deterioration and corrosion on the body and components (aluminum wheels etc.)**

Observe the following precautions:

- Wash the vehicle immediately in the following cases:
 - After driving near the sea coast
 - After driving on salted roads
 - If coal tar or tree sap is present on the paint surface
 - If dead insects, insect droppings or bird droppings are present on the paint surface
 - After driving in an area contaminated with soot, oily smoke, mine dust, iron powder or chemical substances
 - If the vehicle becomes heavily soiled with dust or mud
 - If liquids such as benzene and gasoline are spilled on the paint surface
- If the paint is chipped or scratched, have it repaired immediately.
- To prevent the wheels from corroding, remove any dirt and store in a place with low humidity when storing the wheels.

For the matte finish, pay attention to the following as well:

- If anything is spilled on a painted surface, wipe it off as soon as possible. If spilled washer fluid or alkaline fluids are left as is, the paint in the affected area may deteriorate, causing blemishing.

- Do not wax or apply coating to the vehicle. Doing so may cause a change in the body surface's texture or irregularities in the paint.

Leather care

Remove dust from the leather regularly, using a cloth or vacuum cleaner.

Otherwise, particles of dust and road grime chafe in pores and folds, and lead to increased wear and premature degradation of the leather surface.

To guard against discoloration, such as from clothing, clean leather and provide leather care roughly every two months.

Clean light-colored leather more frequently because soiling on such surfaces is substantially more visible.

Use leather care products; otherwise, dirt and grease will gradually break down the protective layer of the leather surface.

Synthetic leather care

Clean synthetic leather regularly with a damp microfiber cloth or vacuum cleaner.

Otherwise, dust and road grime particles will rub into pores and folds, causing significant abrasion and premature degradation of the surface.

In case of major soiling, use a moist soft sponge or microfiber cloth with suitable interior cleaners.

Immediately remove aggressive substances such as sunscreen to prevent the synthetic leather from being altered or discolored.

Fabric care

General information

In case of major contaminations such as beverage stains, use a moist soft sponge or microfiber cloth with a suitable interior cleaners.

Immediately remove aggressive substances, e.g., sunscreen, to prevent alterations or discolorations of the fabric.

Safety information

 **NOTICE**

Open hook and loop fasteners, zippers, or applications, e.g., studs on clothing can damage the seat covers and the other fabric and leather covers in the vehicle. There is a risk of property damage. Make sure that the fasteners are closed.

Upholstery material care

Vacuum regularly with a vacuum cleaner.

Clean extensively down to the seams. Avoid rubbing the mate-

rial vigorously.

Textile care

Use a microfiber cloth for cleaning minor contamination.

Dampen the cloth with water.

Caring for special components

Light-alloy wheels

When cleaning the vehicle, use only neutral wheel cleaners having a pH value from 5 to 9. Do not use abrasive cleaning agents or steam jets above 140 °F/60 °C. Follow the manufacturer's instructions.

Corrosive, acidic or alkaline cleaning agents can damage surface of the rims and the protective layer of adjacent components, e.g., the brakes.

After cleaning, apply the brakes briefly to dry them. The heat generated during braking dries brake discs and brake pads and protects them against corrosion.

Chrome surfaces

Carefully clean components such as the radiator grille or door handles with plenty of water, possibly with shampoo added, particularly when they have been exposed to road salt.

Rubber components

Environmental influences can cause surface soiling of rubber parts and a loss of gloss. Use only water and suitable cleaning agents for cleaning.

Treat especially worn rubber parts with rubber care agents at regular intervals. When cleaning rubber seals, do not use any silicone-containing vehicle care products in order to avoid damage or noises.

Wiper blades

The wiper blades are cleaned by using the washer system.

Avoid cleaning the wiper blades manually, as this may reduce wiper performance.

Plastic components

NOTICE

Cleansers that contain alcohol or solvents, such as lacquer thinners, heavy-duty grease removers, fuel, or such, can damage plastic parts. There is a risk of damage to property. Clean with a microfiber cloth. Dampen cloth lightly with water.

Do not soak the roofliner.

Safety belts

WARNING

Chemical solvent cleaners can destroy the fabric of the safety belts and lead to safety belts no longer having their protective effect. There is a risk of injury and danger to life. Use only a mild soap solution for cleaning the safety belts.

Dirty belt straps impede the reeling action and thus should be avoided for safety reasons.

Use only a mild soap solution for cleaning the installed belt straps.

Safety belts should only be allowed to retract if they are dry.

Carpets and floor mats

WARNING

Objects in the driver's floor area can limit the pedal distance or block a depressed pedal. There is a risk of accident, injury, and property damage. Stow objects in the vehicle such that they are secured and cannot enter into the driver's floor area. Use floor mats that are suitable for the vehicle and can be safely attached to the floor. Do not use loose floor mats and do not layer several floor mats. Make sure that there is sufficient clearance for the pedals. Ensure that the floor mats are securely fastened again after they were removed, for instance for cleaning.

The floor mats can be removed from the car's interior for clean-

ing.

If the floor carpets are very dirty, clean with a microfiber cloth and water or a textile cleaner. To prevent matting of the carpet, rub back and forth in the direction of travel only.

Sensors and camera lenses

To clean sensors and camera lenses, use a cloth moistened with a small amount of glass detergent.

Displays, screens, and protective glass of the Head-up Display



NOTICE

Chemical cleansers, moisture or fluids of any kind can damage the surface of displays and screens. There is a risk of damage to property. Clean with a clean, antistatic microfiber cloth.



NOTICE

The surface of displays can be damaged with improper cleaning. There is a risk of damage to property. Avoid pressure that is too high and do not use any scratching materials.

Use a dry, clean antistatic microfiber cloth.

Clean the protective glass of the Head-up Display, refer to page 156, using a microfiber cloth and commercially available dish-washing soap.

Long-term vehicle storage

When the vehicle is shut down for longer than three months, special measures must be taken. Further information is available from your Toyota dealer.

REFERENCE**6****6-1. REFERENCE**

Technical data 344

Certification 347

Technical data

Vehicle features and options

This chapter describes all standard, country-specific and optional features offered with the series. It also describes features and functions that are not necessarily available in your vehicle, e.g., due to the selected options or country versions. This also applies to safety-related functions and systems. When using these functions and systems, the applicable laws and

regulations must be observed.

General information

The technical data and specifications in this Owner's Manual are used as guidance values. The vehicle-specific data can deviate from this, for instance due to the selected special equipment, country version or country-specific measurement method. Detailed values can be found in the approval documents, on labels on the vehicle or can be obtained from your Toyota dealer.

Dimensions

The dimensions can vary depending on the model version, equipment or country-specific measurement method.

The specified heights do not take into account attached parts, for instance a roof antenna, roof racks or spoiler. The heights can deviate, for instance due to the selected special equipment, tires, load and chassis version.

Width with mirrors	in/mm	79.8 / 2026
Width without mirrors	in/mm	73.0 / 1854 ^{*3}
		73.5 / 1867 ^{*4}
Height	in/mm	51.1 / 1299 ^{*1}
		50.9 / 1292 ^{*2}
Length	in/mm	172.5 / 4381
Wheelbase	in/mm	97.2 / 2470
Turning radius diameter	ft/m	36.1 / 11

*1: 2.0 models

*2: 3.0 and 3.0 Premium models

*3: Vehicles without wheel guards

*4: Vehicles with wheel guards

Weights

2.0 models		
Permissible gross mass	lbs/kg	3770 / 1710
Load	lbs/kg	430 / 195
Approved front axle load	lbs/kg	1819 / 825
Approved rear axle load	lbs/kg	2006 / 910

3.0 and 3.0 Premium models		
Permissible gross mass	lbs/kg	3990 / 1810 ^{*1}
		4001 / 1815 ^{*2}
Load	lbs/kg	509 / 231 ^{*1}
		498 / 226 ^{*2}
Approved front axle load	lbs/kg	1907 / 865
Approved rear axle load	lbs/kg	2127 / 965

*1: Vehicles with manual transmission

*2: Vehicles with automatic transmission

Capacities

Fuel tank, approx.	US gal/liters	13.7 / 52
--------------------	---------------	-----------

Observe further information on fuel quality, refer to page 303.

Engine

Model	B46B20O1	B58B30O1
Type	4-cylinder in line, 4-cycle, gasoline (with turbo-charger)	6-cylinder in line, 4-cycle, gasoline (with turbo-charger)
Bore and stroke	3.23 × 3.72 in. (82.0 × 94.6 mm)	3.23 × 3.72 in. (82.0 × 94.6 mm)
Displacement	121.93 cu. in. (1998 cm ³)	182.95 cu. in. (2998 cm ³)

Engine oil

Gasoline Engine

Toyota Genuine Motor Oil 0W-20 Supra

BMW Longlife-17 FE+ 0W-20

See the further information on engine oil grade, refer to page 304.

Cooling system

Coolant type	Antifreeze and Corrosion Inhibitor Frostox HT-12
--------------	--

Manual transmission

Fluid type	Manual Transmission Fluid MTF-LT-5
------------	------------------------------------

Automatic transmission

Fluid type	Automatic Gearbox Oil ATF 3+
------------	------------------------------

Differential

- ▶ Vehicles without LSD (Limited Slip Differential)

Oil type and viscosity	Hypoid Axle Oil G3
------------------------	--------------------

- ▶ Vehicles with LSD (Limited Slip Differential)

Oil type and viscosity	Hypoid Axle Oil G4
------------------------	--------------------

Brakes

Fluid type	Brake Fluid DOT 4, Low Viscosity
------------	----------------------------------

Certification

Information

The following note is for all radio-based Components of the vehicle and the vehicle integrated information systems and communication devices:

The radio-based components of this vehicle are in accordance with the basic requirements and the rest relevant provisions of the Directive 2014/53 / EU. Further information is available from your Toyota dealer.

- (1) L'appareil ne doit pas produire de brouillage;
- (2) L'appareil doit accepter tout brouillage radioelectrique subi, meme si le brouillage est susceptible d'en compromettre le fonctionnement.

Alarm System

USA/Canada/Guam

USA/Canada/Guam



Model MUW3

FCC ID: P3O001692

IC:4429A-ITSSSEN

Changes or modifications not expressly approved by the party responsible for compliance could void the user's authority to operate the equipment.

This device complies with part 15 of the FCC Rules. Operation is subject to the following two conditions:

- (1) This device may not cause harmful interference, and
- (2) this device must accept any interference received, including interference that may cause undesired operation.

This device contains licence-exempt transmitter(s)/receiver(s) that comply with Innovation, Science and Economic Development Canada's licence exempt RSS(s). Operation is subject to the following two conditions:

- (1) This device may not cause interference.
- (2) This device must accept any interference, including interference that may cause undesired operation of the device.

L'émetteur/recepteur exempt de licence contenu dans le present appareil est conforme aux CNR d'Innovation, Sciences et Developpement économique Canada applicables aux appareils radio exempts de licence. L'exploitation est autorisee aux deux conditions suivantes:

Antenna and Amplifier

USA

This device complies with part 15 of the FCC Rules. Operation is subject to the following two conditions:

- (1) This device may not cause harmful interference, and
- (2) this device must accept any interference received, including interference that may cause undesired operation.

Body Domain Controller

USA/Canada

USA

FCC ID: 2AOJX-BDC03

FCC ID: 2AA98-BDC03

FCC

This device complies with Part 15 of the FCC Rules. Operation is subject to the following two conditions:

- (1) this device may not cause interference, and
- 2) this device must accept any interference, including interference that may cause undesired operation.

Changes or modifications not expressly approved by the party responsible for compliance could void the user's authority to operate the equipment.

Canada

IC: 23602-BDC03

IC: 11505A-BDC03

ISED CANADA

This device complies with Industry Canada licence- exempt RSS standard(s).

Operation is subject to the following two conditions:

- (1) this device may not cause harmful interference, and
- (2) this device must accept any interference received, including interference that may cause undesired operation.

Le présent appareil est conforme aux CNR d'Industrie Canada applicables aux appareils radio exempts de licence.

L'exploitation est autorisée aux deux conditions suivantes:

- (1) l'appareil ne doit pas produire de brouillage, et
- (2) l'utilisateur de l'appareil doit accepter tout brouillage radioélectrique subi, même si le brouillage est susceptible d'en compromettre le fonctionnement.

Display Key

USA/Canada

USA

For US & Canada owners only

For Transmitter:

FCC ID: 2ADB4DK1S

IC: 23042-DK1S

Compliance statement:

This device complies with Part 15 of the FCC Rules and with Industry Canada licence-exempt RSS standard(s).

- (1) This device may not cause harmful interference, and
- (2) this device must accept any interference received, including interference that may cause undesired operation.

Any unauthorized modifications or changes to these devices could void the user's authority to operate this equipment.

The transmitter unit and receiver comply with part 15 of the FCC/Federal Communication Commission regulations and with Industry Canada licence-exempt RSS standard(s). Operation is governed by the following:

Canada

Pour les propriétaires au Canada seulement:

L'unité émetteur et le récepteur sont conformes à la partie 15 des règlements de la Commission FCC / Federal Communication et avec Industrie Canada exempts de licence standard RSS (s). Le fonctionnement est régi comme suit :

Pour l'émetteur:

FCC ID: 2ADB4DK1S

IC: 23042-DK1S

Déclaration de conformité:

Le présent appareil est conforme aux CNR d'Industrie Canada applicables aux appareils radio exempts de licence. L'exploitation est autorisée aux deux conditions suivantes:

- (1) l'appareil ne doit pas produire de brouillage, et
- (2) l'utilisateur de l'appareil doit accepter tout brouillage radioélectrique subi, même si le brouillage est susceptible d'en compromettre le fonctionnement

Front Radar Sensor

USA/Bermuda/Canada

USA/Bermuda

Model: ARS4-A

FCC ID: OAYARS4A

Model: ARS5-A

FCC ID: OAYARS5A

This device complies with Part 15 of the FCC Rules and with Industry Canada licence-exempt RSS standard(s). Operation is subject to the following two conditions:

- (1) This device may not cause harmful interference, and
- (2) This device must accept any interference received, including interference that may cause undesired operation.

Radiofrequency radiation exposure Information:

This equipment complies with FCC radiation exposure limits set forth for an uncontrolled environment. This equipment should be installed and operated with minimum distance of 20 cm between the radiator and your body.

This transmitter must not be co-located or operating in conjunction with any other antenna or transmitter.

FCC Notice

Changes or modifications not expressly approved by the party responsible for compliance could void the user's authority to operate the equipment.

Canada

Model: ARS4-A

IC: 4135A-ARS4A

Model: ARS5-A

IC: 4135A-ARS5A

This device complies with Industry Canada licence-exempt RSS standard(s). Operation is subject to the following two conditions:

- (1) This device may not cause harmful interference, and
- (2) This device must accept any interference received, including interference that may cause undesired operation.

Le présent appareil est conforme aux CNR d'Industrie Canada applicables aux appareils radio exempts de licence. L'exploitation est autorisée aux deux conditions suivantes:

- (1) l'appareil ne doit pas produire de brouillage, et
- (2) l'utilisateur de l'appareil doit accepter tout brouillage radioélectrique subi, même si le brouillage est susceptible d'en compromettre le fonctionnement.

Radiofrequency radiation exposure Information:

This equipment complies with IC radiation exposure limits set forth for an uncontrolled environment. This equipment should be installed and operated with minimum distance of 20 cm between the radiator and your body.

This transmitter must not be co-located or operating in conjunction with any other antenna or transmitter.

Cet équipement est conforme aux limites d'exposition aux rayonnements IC établies pour un environnement non contrôlé. Cet équipement doit être installé et utilisé avec un minimum de 20 cm de distance entre la source de rayonnement et votre corps.

Headunit

USA/Canada

USA (FCC) and Canada (IC)

Register model name: ENTRY001

Product code: NB00003***

FCC CAUTION

Changes or modifications not expressly approved by the party responsible for compliance could void the user's authority to operate the equipment. This device complies with Part 15 of FCC Rules and Industry Canada licence-exempt RSS standard(s). Operation is subject to the following two conditions: (1) this device may not cause interference, and (2) this device must accept any interference, including interference that may cause undesired operation of this device.

Le présent appareil est conforme aux la partie 15 des règles de la FCC et CNR d'Industrie Canada applicables aux appareils radio exempts de licence. L'exploitation est autorisée aux deux conditions suivantes : (1) l'appareil ne doit pas produire de brouillage, et (2) l'utilisateur de l'appareil doit accepter tout brouillage radioélectrique subi, même si le brouillage est susceptible d'en compromettre le fonctionnement.

This equipment complies with FCC/IC radiation exposure limits set forth for an uncontrolled environment and meets the FCC radio frequency (RF) Exposure Guidelines in Supplement C to OET65 and RSS-102 of the IC radio frequency (RF) Exposure rules. This equipment has very low levels of RF energy that it deemed to comply without maximum permissive exposure evaluation (MPE). But it is desirable that it should be installed and operated keeping the radiator at least 20cm or more away from person's body (excluding extremities: hands, wrists, feet and ankles).

Cet équipement est conforme aux limites d'exposition aux rayonnements énoncées pour un environnement non contrôlé et respecte les règles les radioélectriques (RF) de la FCC lignes directrices d'exposition dans le Supplément C à OET65 et d'exposition aux fréquences radioélectriques (RF) CNR-102 de l'IC. Cet équipement émet une énergie RF très faible qui est considérée conforme sans évaluation de l'exposition maximale autorisée. Cependant, cet équipement doit être installé et utilisé en gardant une distance de 20 cm ou plus entre le dispositif rayonnant et le corps (à l'exception des extrémités : mains, poignets, pieds et chevilles).

Integrated Universal Remote Control

Canada

Cet appareil est conforme aux règlements de la FCC, section 15 et à la norme RSS-210 d'Industrie Canada. Le fonctionnement est assujéti aux deux conditions suivantes :

(1) Cet appareil ne doit pas causer d'interférences nuisibles et

(2) Cet appareil doit accepter toute interférence reçue, y compris celle qui pourrait entraîner un dysfonctionnement.

MISE EN GARDE:

L'émetteur a subi des tests et est conforme aux règlements de la FCC et d'IC. Les changements ou modifications non approuvés explicitement par la partie responsable de la conformité pourraient rendre caduque l'autorisation de l'utilisateur de se servir du dispositif.

Cet appareil est conforme aux limites d'exposition aux radiations de la FCC établies pour un environnement non contrôlé. Les utilisateurs finaux doivent respecter les instructions d'utilisation spécifiques pour satisfaire aux exigences de conformité aux expositions de RF. L'émetteur doit se trouver à 20 cm au minimum de l'utilisateur et ne doit pas être situé au même endroit que tout autre émetteur ou antenne ni fonctionner avec un autre émetteur ou antenne.

Le terme « IC » figurant devant le numéro de certification/d'enregistrement signifie uniquement que le dispositif satisfait aux spécifications techniques d'Industrie Canada.

USA

This device complies with FCC rules part 15 and Industry Canada RSS-210. Operation is subject to the following two conditions:

(1) This device may not cause harmful interference, and

(2) This device must accept any interference that may be received including interference that may cause undesired operation.

WARNING:

The transmitter has been tested and complies with FCC and IC rules. Changes or modifications not expressly approved by the party responsible for compliance could void the user's authority to operate the device.

This equipment complies with FCC radiation exposure limits set forth for an uncontrolled environment. End Users must follow the specific operating instructions for satisfying RF exposure compliance. This transmitter must be at least 20 cm from the user and must not be co-located or operating in conjunction with any other antenna or transmitter.

The term "IC:" before the certification/registration number only signifies that Industry Canada technical specifications were met.

LTE-Compensator

USA

The booster device fulfils the network protection standards as required by the FCC, such as intermodulation limits, oscillation detection and gain limits.

Booster Manufacturer: Continental Advanced Antenna GmbH

Model Number: LTECOMPBO

Part Number: 6803145-01

FCC-ID: 2ACC7LTECOMPBO

Mid Range Radar

USA/Canada/Guam/Palau/ Mariana Islands

USA/Canada

FCC ID: NF3-MRREVO14F

User manual statement according to §15.19:

NOTICE:

This device complies with Part 15 of the FCC Rules. Operation is subject to the following two conditions:

- (1) this device may not cause harmful interference, and
- (2) this device must accept any interference received, including interference that may cause undesired operation.

User manual statement according to §15.21:

Changes or modifications made to this equipment not expressly approved by Robert BOSCH GmbH may void the FCC authorization to operate this equipment.

User manual statements according to §15.105:

This equipment has been tested and found to comply with the limits for a Class A digital device, pursuant to Part 15 of the FCC Rules. These limits are designed to provide reasonable protection against harmful interference when the equipment is operated in a commercial environment. This equipment generates, uses, and can radiate radio frequency energy and, if not installed and used in accordance with the instruction manual, may cause harmful interference to radio communications. Operation of this equipment in a residential area is likely to cause harmful interference in which case the user will be required to correct the interference at his own expense.

RF Exposure Information according 2.1091 / 2.1093 / KDB 447498 / OET bulletin 65:

Radiofrequency radiation exposure Information:

This equipment complies with FCC radiation exposure limits set forth for an uncontrolled environment. This equipment should be installed and operated with minimum distance of 20 cm between the radiator and your body. This transmitter must not be co-located or operating in conjunction with any other antenna or transmitter.

IC: 3887A-MRRE14FCR

User manual statement according to RSS-GEN NOTICE:

This device complies with Industry Canada license-exempt RSS standard(s). Operation is subject to the following two conditions: (1) this device must not cause interference, and (2) this device must accept any interference, including interference that may cause undesired operation of the device.

Le présent appareil est conforme aux CNR d'Industrie Canada applicables aux appareils radio exempts de licence. L'exploitation est autorisée aux deux conditions suivantes: (1) l'appareil ne doit pas produire de brouillage, et (2) l'utilisateur de l'appareil doit accepter tout brouillage radio-électrique subi, même si le brouillage est susceptible d'en compromettre le fonctionnement.

RF Exposure Information according to RSS-102

Radiofrequency radiation exposure Information:

This equipment complies with FCC and IC radiation exposure limits set forth for an uncontrolled environment. This equipment should be installed and operated with minimum distance of 20 cm between the radiator and your body. This transmitter must not be co-located or operating in conjunction with any other antenna or transmitter.

Cet équipement est conforme aux limites d'exposition aux rayonnements IC établies pour un environnement non contrôlé. Cet équipement doit être installé et utilisé avec un minimum de 20 cm de distance entre la source de rayonnement et votre corps. Ce transmetteur ne doit pas être placé au même endroit ou utilisé simultanément avec un autre transmetteur ou antenne.

Guam/Palau/Mariana Islands

FCC ID: NF3-MRREVO14F

User manual statement according to §15.19:

NOTICE:

This device complies with Part 15 of the FCC Rules Operation is subject to the following two conditions:

(1) this device may not cause harmful interference, and

(2) this device must accept any interference received, including interference that may cause undesired operation.

User manual statement according to §15.21:

Changes or modifications made to this equipment not expressly approved by Robert BOSCH GmbH may void the FCC authorization to operate this equipment.

User manual statements according to §15.105:

This equipment has been tested and found to comply with the limits for a Class A digital device, pursuant to Part 15 of the FCC Rules.

These limits are designed to provide reasonable protection against harmful interference when the equipment is operated in a commercial environment. This equipment generates, uses, and can radiate radio frequency energy and, if not installed and used in accordance with the instruction manual, may cause harmful interference to radio communications. Operation of this equipment in a residential area is likely to cause harmful interference in which case the user will be required to correct the interference at his own expense.

RF Exposure Information according

2.1091/2.1093/KDB 447498/OET bulletin 65:

Radiofrequency radiation exposure Information:

This equipment complies with FCC radiation exposure limits set forth for an uncontrolled environment. This equipment should be installed and operated with minimum distance of 20 cm between the radiator and your body. This transmitter must not be co-located or operating in conjunction with any other antenna or transmitter.

NFC Reader

USA/Canada

Canada

Continental

Model: A2C12393700

IC:7812D-A2C12393700

This device complies with Industry Canada license-exempt RSS standard(s). Operation is subject to the following two conditions:

- (1) this device may not cause interference, and
- (2) this device must accept any interference, including interference that may cause undesired operation of the device.

Le présent appareil est conforme aux CNR d'Industrie Canada applicables aux appareils radio exempts de licence. L'exploitation est autorisée aux deux conditions suivantes:

- (1) l'appareil ne doit pas produire de brouillage, et
- (2) l'utilisateur de l'appareil doit accepter tout brouillage radioélectrique subi, même si le brouillage est susceptible d'en compromettre le fonctionnement

USA

FCC ID:KR5A2C12393700

This device complies with Part 15 of the FCC Rules. Operation is subject to the following two conditions:

- (1) this device may not cause harmful interference, and
- (2) this device must accept any interference received, including interference that may cause undesired operation.

Changes or modifications not expressly approved by the party responsible for compliance could void the user's authority to operate the equipment.

Receiver Audio Module

Canada

This Class B digital apparatus complies with Canadian ICES-003.

Cet appareil numérique de la classe B est conforme à la norme NMB-003 du Canada.

Le présent appareil est conforme aux CNR d'Industrie Canada applicables aux appareils radio exempts de licence. L'exploitation est autorisée aux deux conditions suivantes:

- (1) l'appareil ne doit pas produire de brouillage, et
- (2) l'utilisateur de l'appareil doit accepter tout brouillage radioélectrique subi, même si le brouillage est susceptible d'en compromettre le fonctionnement.

USA

FCC statements

This device complies with Part 15 of the FCC Rules. Operation is subject to the following two conditions:

- (1) this device may not cause harmful interference, and
- (2) this device must accept any interference received, including interference that may cause undesired operation.

Caution to Users/FCC Warning

Changes or modifications not expressly approved by the party responsible for compliance could void the user's authority to operate the equipment

Remote Control

USA/Canada/Jamaica

USA

FCC ID: N5F-ID21A

This device complies with Part 15 of the FCC rules and contains licence-exempt transmitter(s)/receiver(s) that comply with Innovation, Science and Economic Development Canada's licence-exempt RSS(s). Operation is subject to the following two conditions:

- (1) this device may not cause interference,
- (2) this device must accept any interference, including interference that may cause undesired operation of the device.

Changes or modifications made to this equipment not expressly approved by Valeo Comfort and Driving Assistance may void the FCC authorization to operate this equipment.

Canada

IC: 3248A-ID21A

This device complies with Industry Canada licence-exempt RSS standard(s). Operation is subject to the following two conditions:

- (1) this device may not cause interference, and
- (2) this device must accept any interference, including interference that may cause undesired operation of the device.

L'émetteur/récepteur exempt de licence contenu dans le présent appareil est conforme aux CNR d'Innovation, Sciences et Développement économique Canada applicables aux appareils radio exempts de licence standard. L'exploitation est autorisée aux deux conditions suivantes:

- (1) l'appareil ne doit pas produire de brouillage et
- (2) l'utilisateur de l'appareil doit accepter tout brouillage radioélectrique subi, même si le brouillage est susceptible d'en compromettre le fonctionnement

Side Radar Sensor

USA/Canada: SP2018

USA Model: B3TR

FCC: LTQB3TR "CAUTION TO USERS"

Changes or modifications not expressly approved by the party responsible for compliance could void the user's authority to operate the equipment.

This device complies with Part 15 of the FCC Rules and with RSS of the Industry Canada.

Operation is subject to the following two conditions:

- (1) This device may not cause harmful interference, and
- (2) This device must accept any interference received, including interference that may cause undesired operation.

Canada

Delphi

Model: B3TR

IC: 3659A-B3TR

This device complies with Industry Canada licence- exempt RSS standard(s).

Operation is subject to the following two conditions:

- (1) this device may not cause interference, and
- (2) this device must accept any interference, including interference that may cause undesired operation of the device.

Le présent appareil est conforme aux CNR d'Industrie Canada applicables aux appareils radio exempts de licence.

L'exploitation est autorisée aux deux conditions suivantes:

- (1) l'appareil ne doit pas produire de brouillage, et
- (2) l'utilisateur de l'appareil doit accepter tout brouillage radioélectrique subi, même si le brouillage est susceptible d'en compromettre le fonctionnement.

Smart Access

USA/Canada: SP2018

Witte

BMW G3x NFC

FCC: 2APBZ030816

FCC: V2T030816

This device complies with Part 15 of the FCC Rules. Operation is subject to the following two conditions:

- (1) this device may not cause harmful interference, and
- (2) this device must accept any interference received, including interference that may cause undesired operation.

FCC Warning!

Changes or modifications made to this equipment not expressly approved by WITTE Velbert GmbH & Co. KG may void the FCC authorization to operate this equipment.

IC: 23755-030816

IC: 7575A-030816

This device complies with RSS-210 of Industry Canada. Operation is subject to the following two conditions:

- (1) this device may not cause harmful interference, and
- (2) this device must accept any interference received, including interference that may cause undesired operation.

Changes or modifications made to this equipment not expressly approved by WITTE Velbert GmbH & Co. KG may void the RSS-210 of Industry Canada authorization to operate this equipment.

Frequency range: 13,56 MHz +/- 7kHz

Maximum magnetic field strength: 7,5 A/m

Le présent appareil est conforme aux CNR d'Industrie Canada applicables aux appareils radio exempts de licence. L'exploitation est autorisée aux deux conditions suivantes:

- (1) l'appareil ne doit pas produire de brouillage, et
- (2) l'appareil doit accepter tout brouillage radioélectrique subi, même si le brouillage est susceptible d'en compromettre le fonctionnement

Gamme de fréquences: 13,56 MHz +/- 7kHz

Le champ magnétique maximale: 7,5 A/m

Telematics Communication Box

USA/Canada

USA

Federal Communications Commission (FCC)
Compliance Statement – United States

Model: ATM-01 R2-US-4G, ATM-01 T2-US-4G

FCC ID: QWY-V1140-101-1

Model: ATM-01 R2-US-4GW

FCC ID: QWY-ATM-R-622

ATM-01 T2-US-4GW

FCC ID: QWY-ATM-T-622

Model: ATM-02 US-R1

FCC ID: QWY-ATM2-R-11

Model: ATM-02 US-T1

FCC ID: QWY-ATM2-T-11

Model: WAVE-01-LOW-R1

Contains IC: BEJ-TM04ANNABM0

Model: WAVE-01-HIGH-R1

Contains ID: BEJTM05NNNABM0

WAVE-11-HIGH-R2, WAVE-11-HAF-R2

Contains FCC ID: T8GSAN9000

Contains FCC ID: T8GSAN9001

Model: WAVE-01-LOW-T1

Contains FCC ID: BEJ-TM04ANNABM0

Model: WAVE-01-HIGH-T1

Contains FCC ID: BEJ-TM05NNNABM0

This device complies with Part 15 of the FCC Rules.

Operation is subject to the following two conditions:

(1) This device may not cause harmful interference, and

(2) this device must accept any interference received, including interference that may cause undesired operation.

Caution: Changes or modifications not expressly approved by the party, responsible for compliance, could void the user's authority to operate the equipment.

This device and its antenna must not be co-located or operating in conjunction with any other antenna or transmitter.

This equipment should be operated with a minimum distance of 20 cm between the radiator and your body.

Canada

Model: ATM-01 R2-US-4G, ATM-01 T2-US-4G

Contains IC: 6588A-V11401011

Model: ATM-01 R2-US-4GW

IC: 6588A-ATMR622

Model: ATM-01 T2-US-4GW

IC: 6588A-ATMT622

Model: ATM-02 US-R1

IC: 6588A-ATM2R11

Model: ATM-02 US-T1

IC: 6588A-ATM2T11

WAVE-11-HIGH-R2, WAVE-11-HAF-R2

Contains IC: 6434A- SAN9000

Contains IC: 6434A- SAN9001

Model: WAVE-01-LOW-T1, WAVE-01-LOW-R1

Contains IC: 2703H-TM04ANNABM0

Model: WAVE-01-HIGH-T1, WAVE-01-HIGH-R1

Contains IC: 2703H-TM05NNNABM0

This device complies with part 15 of the FCC Rules and Industry Canada license-exempt RSS standard(s).

Operation is subject to the following two conditions:

(1) This device may not cause harmful interference, and

(2) this device must accept any interference received, including interference that may cause undesired operation.

Le présent appareil est conforme aux CNR d'Industrie Canada applicables aux appareils radio exempts de licence.

L'exploitation est autorisée aux deux conditions suivantes:

(1) l'appareil ne doit pas produire de brouillage, et

(2) l'utilisateur de l'appareil doit accepter tout brouillage radioélectrique subi, même si le brouillage est susceptible d'en compromettre le fonctionnement.

WAVE-01-LOW-R1, WAVE-01-HIGH-R1

WAVE-01-LOW-T1, WAVE-01-HIGH-T1

This equipment complies with IC radiation exposure limits set forth for an uncontrolled environment.

This equipment should be installed and operated with minimum distance 20 cm between the radiator & your body.

NOTE: THE MANUFACTURER IS NOT RESPONSIBLE FOR ANY RADIO OR TV INTERFERENCE CAUSED BY UNAUTHORIZED MODIFICATIONS TO THIS EQUIPMENT. SUCH MODIFICATIONS COULD VOID THE USER'S AUTHORITY TO OPERATE THE EQUIPMENT.

Avis d'Industrie Canada sur l'exposition aux rayonnements

Cet appareil est conforme aux limites d'exposition aux rayonnements d'Industrie Canada pour un environnement non contrôlé.

Il doit être installé de façon à garder une distance minimale de 20 centimètres entre la source de rayonnements et votre corps.

REMARQUE: LE FABRICANT N'EST PAS RESPONSABLE DES INTERFÉRENCES RADIO-ÉLECTRIQUES CAUSÉES PAR DES MODIFICATIONS NON AUTORISÉES APPORTÉES À CET APPAREIL. DE TELLES MODIFICATIONS POURRAIT ANNULER L'AUTORISATION ACCORDÉE À L'UTILISATEUR DE FAIRE FONCTIONNER L'APPAREIL.

Tire Pressure Monitoring System

USA/Canada

FCC ID: MRX AG5SP4

IC: 2546A-AG5SP4

Model:AG5SP4-D

This device complies with Part 15 of the FCC Rules and with Licence exempt RSS Standards of Industry Canada. Operation is subject to the following two conditions:

- (1) This device may not cause harmful interference, and
- (2) this device must accept any interference received, including interference that may cause undesired operation.

Le présent appareil est conforme aux CNR d'Industrie Canada applicables aux appareils radio exempts de licence. L'exploitation est autorisée aux deux conditions suivantes:

- (1) l'appareil ne doit pas produire de brouillage, et
- (2) l'utilisateur de l'appareil doit accepter tout brouillage radioélectrique subi, même si le brouillage est susceptible d'en compromettre le fonctionnement.

WARNING:

Changes or modifications not expressly approved by the party responsible for compliance could void the user's authority to operate the equipment. The term "IC:" before the radio certification number only signifies that Industry Canada technical specifications were met.

USA/Canada

FCC ID: YGOTSSRE4A

This device complies with Part 15 of the FCC Rules. Operation is subject to the following two conditions:

- (1) this device may not cause harmful interference, and
- (2) this device must accept any interference received, including interference that may cause undesired operation.

WARNING: Any changes or modification not expressly approved by the party responsible for compliance could void the user's authority to operate this equipment.

IC: 4008C-TSSRE4A

This device contains licence-exempt transmitter(s)/receiver(s) that comply with Innovation, Science and Economic Development Canada's licence-exempt RSS(s). Operation is subject to the following two conditions:

- (1) this device may not cause harmful interference, and
- (2) this device must accept any interference received, including interference that may cause undesired operation.

Transmitter/Receiver**Canada/USA**

Model: FBD-4

IC: 7812D-FBD4

This device complies with Industry Canada license-exempt RSS standard(s). Operation is subject to the following two conditions:

- (1) this device may not cause harmful interference, and
- (2) this device must accept any interference received, including interference that may cause undesired operation.

Le présent appareil est conforme aux CNR d'Industrie Canada applicables aux appareils radio exempts de licence. L'exploitation est autorisée aux deux conditions suivantes :

- (1) l'appareil ne doit pas produire de brouillage, et
- (2) l'utilisateur de l'appareil doit accepter tout brouillage radioélectrique subi, même si le brouillage est susceptible d'en compromettre le fonctionnement.

FCC ID: KR5FBD4

This device complies with Part 15 of the FCC Rules. Operation is subject to the following two conditions:

- (1) this device may not cause harmful interference, and
- (2) this device must accept any interference received, including interference that may cause undesired operation.

Changes or modifications not expressly approved by the party responsible for compliance could void the user's authority to operate the equipment.

Wireless Charging

USA/Canada

USA

Molex WCH-189

FCC/INDUSTRY CANADA NOTICE

This device complies with part 15 of the FCC rules and with Industry Canada license-exempt RSS standard(s). Operation is subject to the following two conditions:

- (1) This device may not cause harmful interference, and
- (2) this device must accept any interference received, including interference that may cause undesired operation.

FCC ID: RK7189-00, RK7184-00

IC 4774A-18900, 4774A-18400

Any changes or modifications not expressly approved by Molex CVS Dabendorf GmbH could void the user's authority to operate this equipment.

The device has been tested for human exposure limits and found compliant at a minimum distance of 2 in/5 cm during operation.

Thus during the operation of the device a distance of 2 in/5 cm must be respected in every direction.

BURY WCA CS NFC LCI

FCC ID QZ9-WCACS

This device complies with part 15 of the FCC Rules and Industry Canada license-exempt RSS standard(s). Operation is subject to the following two conditions:

- (1) This device may not cause harmful interference, and
- (2) this device must accept any interference received, including interference that may cause undesired operation.

FCC § 15.21 Information to user

Changes or modifications not expressly approved by the party responsible for compliance could void the user's authority to operate the equipment.

RF Exposure Requirements

To comply with FCC RF exposure compliance requirements, the device must be installed to provide a separation distance of at least 20 cm from all persons.

Canada

Molex WCH-189

FCC/Notice d'industrie du Canada

Cet équipement est considéré comme conforme aux conditions de la section 15 de la réglementation de la FCC. Il répond aux deux conditions suivantes:

1. Ce dispositif ne causera aucune interférence nuisible;
2. Ce dispositif peut accepter toute interférence reçue, notamment l'interférence entraînant un fonctionnement indésirable.

FCC ID: RK7189-00, RK7184-00

IC: 4774A-18900, 4774A-18400

Les changements ou modifications non approuvés expressément par Molex peuvent entraîner la caducité de l'autorisation d'utiliser l'équipement.

BURY WCA CS NFC LCI

IC: 5927A-WCACS

This device complies with part 15 of the FCC rules and with Industry Canada license-exempt RSS standard(s). Operation is subject to the following two conditions:

- (1) This device may not cause harmful interference, and
- (2) this device must accept any interference received, including interference that may cause undesired operation.

Le présent appareil est conforme aux CNR d'Industrie Canada applicables aux appareils radio exempts de licence. L'exploitation est autorisée aux deux conditions suivantes:

- (1) l'appareil ne doit pas produire de brouillage, et
- (2) l'utilisateur de l'appareil doit accepter tout brouillage radioélectrique subi, même si le brouillage est susceptible d'en compromettre le fonctionnement.

Index



Alphabetical Index..... 362



Alphabetical Index

A

- A/C button, see Air conditioning 238
- ABS, Antilock Brake System .201
- ACC, see Dynamic radar cruise control with full-speed range 212
- Acceleration Assistant, see Launch Control..... 137
- Accessories and parts 6
- Activated charcoal filter 241
- Active Guard, see Toyota Supra Safety 178
- Adaptive variable suspension 234
- Additional coolant tank cooling, Capacity 346
- Additives, engine oil types 307
- Air circulation, see Recirculated-air mode..... 239
- Air conditioning..... 238
- Air distribution, manual..... 240
- Air flow, automatic air conditioning 240
- Air outlets, see Ventilation 241
- Air pressure, tires 274
- Airbags 166
- Airbags, indicator and warning light..... 168
- Alarm system..... 96
- Alarm, unintentional..... 97
- All-season tires, see Winter tires 285
- Antilock Brake System, ABS .201
- Anti-slip control, see VSC 203
- Anti-theft protection, locking .. 83
- Anti-theft protection, see Lug bolt lock 299
- Apple CarPlay, connection to the vehicle 77
- Approved axle load 345
- Approved total weight..... 345
- Assistance when driving off, see Hill-start assist control..... 202
- Assistance with breakdown .. 327
- AUTO program, automatic air conditioning 239
- Auto Start/Stop function 120
- Automatic air conditioning 236
- Automatic cruise control with Stop & Go 212
- Automatic Curb Monitor, exterior mirror 111
- Automatic deactivation, front-seat passenger airbags 177
- Automatic headlight control .. 159
- Automatic high-beam 162
- Automatic locking 95
- Automatic transmission..... 132
- Automatic transmission, Fluid 346
- Automatic transmission, see Automatic transmission..... 132
- Automatic unlocking 95
- Automatic vehicle wash..... 336
- Autonomous Emergency Braking 199
- Axle loads, weights 345

B

- Backrest curvature, see Lumbar support 104
- Backrest tilt 103
- Backrest, seats 100
- Backrest, width 104
- Bar for tow-starting/towing.... 333
- Battery, changing, remote control of the vehicle 85
- Battery, disposing of 318
- Battery, vehicle 316
- Being towed, see Tow-starting and towing..... 331

Belts, see Safety belts 104
 Beverage holder, see Cup holders 256
 Blind spot monitor 194
 Bluetooth connection 73
 Bottle holder, see Cup holders 256
 Brake assist 202
 Brake discs, breaking in, see Brake system 263
 Brake lights, see Lights and bulbs 315
 Brake pads, breaking in, see Brake system 263
 Brake system 263
 Brake, Fluid 346
 Braking, information 265
 Break recommendation, see Driver attention control 199
 Breakdown assistance 327
 Break-in 262
 Brightness, Control Display 66
 Bulb replacement, see Lights and bulbs 315
 Bulbs, replacing, see Lights and bulbs 315
 Button, SOS, see Intelligent emergency call 328
 Button, Start/Stop 120
 Buttons on the steering wheel 38
 Bypassing, see Jump-starting 329

C

Cable for tow-starting/towing 333
 California Proposition 65 Warning 6
 Calling up mirror adjustment .. 95
 Calling up seat adjustment 95
 Calling up steering wheel adjustment 95
 Camera lenses, care 342

Camera, rearview camera 228
 Camera-based assistance systems, see Toyota Supra Safety 178
 Camera-based cruise control, see Dynamic radar cruise control with full-speed range 212
 Cameras, see Sensors of the vehicle 42
 Can holder, see Cup holders 256
 Car seats, see Transporting children safely 115
 Car wash 336
 Car washing 335
 Care of displays, screens 342
 Care, Head-up Display 342
 Care, see Washing the vehicle 335
 Care, vehicle 338
 Cargo area 256
 Cargo area, loading, see Stowing and securing cargo 258
 Cargo straps, see Lashing eyes in the cargo area 258
 Cargo, stowing and securing 258
 Carpet, care 341
 CarPlay, connection to the vehicle 77
 Catalytic converter, see Hot exhaust gas system 263
 CBS Condition Based Service 312
 CC, see Cruise control 208
 Center console 40
 Central locking system 89
 Central screen, see Control Display 52
 Changes, technical, see For Your Own Safety 5
 Changing parts 314
 Changing wheels 299
 Changing wheels/tires 283

- Chassis number, see Vehicle identification number..... 12
- Checking the engine oil level electronically 305
- Checking the oil level electronically 305
- Child restraint systems, mounting..... 116
- Child restraint systems, see Transporting children safely115
- Child seat, mounting..... 116
- Child seats, see Transporting children safely 115
- Children, seating position 115
- Children, transporting safely 115
- Chrome surfaces, care 341
- Chrome-plated surfaces, care341
- Cleaning displays, screens ...342
- Cleaning, Head-up Display342
- Climate control 236
- Combination switch, see Turn signals..... 126
- Combination switch, see Washer/wiper system..... 127
- Comfort entry 89
- Comparison of entries, see Entry comparison 50
- Compartments in the doors ..255
- Compressor 296
- Condensation water under the parked vehicle 267
- Condensation, removing from the windows..... 240
- Condition Based Service CBS 312
- Confirmation signal from the vehicle 95
- Connecting electrical devices, see Sockets 248
- Connections, Screen Mirroring78
- Control Display..... 52
- Control Display, settings 64
- Control systems, driving stability201
- Controller53
- Convenient closing with the remote control84
- Convenient opening with the remote control83
- Coolant309
- Coolant level309
- Coolant temperature148
- Cooling system.....309
- Cooling, maximum238
- Corrosion on brake discs266
- Cosmetic mirror248
- Cruise control208
- Cruise control with distance control, see Dynamic radar cruise control with full-speed range212
- Cruise control without distance control, see Cruise control ..208
- Cruise control, active with Stop & Go.....212
- Cruising range149
- Cup holder.....256
- Curtain shield airbag.....166
- Customize Settings, see Driver profiles.....69
- Customize Settings, see Sport mode switch.....138

D

- Damage, tires282
- Data memory.....8
- Data protection, settings67
- Data, see Deleting personal data in the vehicle.....68
- Data, technical344
- Date.....65
- Daytime running lights.....162
- Defogging the windows240
- Defrosting the windows240

Deleting personal data..... 68
 Departure time, parked-car ventilation..... 243
 Device list, displaying..... 79
 Devices, managing..... 79
 Diagnostic socket 313
 Differential oil 346
 Dimensions 344
 Dimmable exterior mirrors 110
 Dimmable interior mirror 111
 Direct dial buttons, see Programmable memory buttons..... 60
 Direction indicator, see Turn signals 126
 Display in the windshield, see Head-up Display 156
 Display lighting, see Instrument lighting 164
 Displays 139
 Displays and symbols 4
 Displays, screens..... 342
 Disposal, coolant 310
 Disposal, vehicle battery 318
 Distance control, see Parking Sensors 223
 Driver assistance, see Toyota Supra Safety 178
 Driver attention control..... 199
 Driver Fatigue Detector..... 199
 Driver profiles 69
 Drive-ready state, idle state, and standby state 48
 Driving Assistant, see Toyota Supra Safety 178
 Driving comfort 234
 Driving instructions, break-in..... 262
 Driving mode, see Sport mode switch 138
 Driving notes, general 263
 Driving on racetracks 267
 Driving stability control systems 201

Driving tips..... 263
 Drying air, see Air conditioning 238
 Dynamic radar cruise control with full-speed range..... 212

E

Electronic oil measurement... 305
 Emergency brake function when parking, Parking Sensors with emergency braking function..... 226
 Emergency service, see Breakdown assistance..... 327
 Emergency unlocking, fuel filler flap 273
 Emergency unlocking, transmission lock 136
 Energy savings, see Gear shift indicator 150
 Engine..... 345
 Engine compartment..... 301
 Engine compartment, working in 301
 Engine coolant..... 309
 Engine coolant, Capacity 346
 Engine oil 304, 346
 Engine oil change..... 308
 Engine oil filler neck..... 306
 Engine oil temperature..... 148
 Engine oil types to add 307
 Engine oil, adding..... 306
 Engine start, jump-starting.... 329
 Engine temperature..... 148
 Engine, Auto Start/Stop function 120
 Entry comparison, navigation. 50
 Equipment, interior..... 244
 Error displays, see Vehicle messages 140
 Exchanging wheels/tires..... 283
 Exhaust gas system 263

Exhaust, see Exhaust gas system.....263
 Exterior lighting during unlocking.....82
 Exterior lighting with the vehicle locked.....84
 Exterior mirror, Automatic Curb Monitor 111
 Exterior mirror, automatic dimming feature..... 110
 Exterior mirrors 109
 Exterior mirrors, malfunction 110
 External start 329
 External temperature 149
 Eyelet for towing 334
 Eyes, see Lashing eyes in the cargo area258

F

Failure message, see Vehicle messages 140
 False alarm, see Avoiding unintentional alarms.....97
 Fan, see Air flow.....240
 Fastening safety belts, see Safety belts 104
 Filler neck for engine oil 306
 Flat tire message, TPM290
 Flat tire warning light, TPM ...290
 Flat tire, changing wheels299
 Flat tire, repairing.....294
 Flat tire, see Tire Pressure Monitor TPM.....286
 Flooding265
 Floor carpet, care341
 Floor mats, care341
 Fog, removing from the windows240
 Fold-away position of the wipers 130
 Foot brake.....265
 For Your Own Safety5

Front airbags.....166
 Front collision mitigation.....180
 Front fog lights, see Lights and bulbs315
 Front lights, see Lights and bulbs315
 Front seats100
 Front-seat passenger airbags, automatic deactivation.....177
 Front-seat passenger airbags, indicator light.....177
 Fuel303
 Fuel cap272
 Fuel filler flap272
 Fuel filler flap, unlocking manually273
 Fuel gauge.....147
 Fuel quality.....303
 Fuel recommendation303
 Fuel, tank capacity345
 Fuses318

G

Garage door opener, see Integrated Universal Remote Control.....244
 Gasoline303
 Gear change, Automatic transmission132
 Gear shift indicator.....150
 General driving notes.....263
 General settings64
 Glare shield, see Sun visor...248
 Go function212
 Go function, ACC.....212
 GPS geolocation, vehicle position65

H

Handbrake, see Parking brake124

Hand-held transmitter, alternating code246
Hazard warning flashers.....327
Head restraints, front..... 109
Headlight control, automatic.159
Headlight courtesy delay feature 162
Headlight courtesy delay feature, switching on 85
Headlight flasher 127
Headlight glass..... 316
Headlights, see Lights and bulbs 315
Head-up Display 156
Head-up Display, care 342
Head-up Display, see Memory function 112
Head-up Display, standard view 157
Heavy cargo, stowing cargo..258
Height, vehicle..... 344
High beams 127
High beams/low beams, see Automatic high-beam 162
Hill start assistant, see Hill-start assist control..... 202
Hills..... 266
Hill-start assist control 202
Hill-start assist control, see VSC 203
Holder for beverages, see Cup holders 256
HomeLink, see Integrated Universal Remote Control..... 244
Hood 301
Horn..... 38
Hot exhaust gas system 263
Humidity in the headlight, see Headlight glass..... 316

I

Ice warning, see External temperature149
Icy roads, see External temperature.....149
Identification marks, tires.....279
Identification number, see Vehicle identification number12
Idle state, standby state, and drive-ready state.....48
Indicator and warning lights, see Vehicle messages.....140
Individual air distribution.....240
Inflation pressure monitor, see Tire Pressure Monitor TPM..286
Inflation pressure, tires.....274
Information4
Initialize, Tire Pressure Monitor TPM.....289
Instrument cluster139
Instrument lighting164
Integrated key87
Integrated Universal Remote Control.....244
Intelligent emergency call.....328
Intended use5
Interior equipment244
Interior lights.....164
Interior lights during unlocking82
Interior lights with the vehicle locked84
Interior mirror, automatic dimming feature 111
Interior motion sensor97
Intersection warning, see Front collision mitigation.....180
Interval display, see Service requirements.....149

J

- Jam protection system, windows 99
- Joystick, Automatic transmission 132
- Jump-starting 329

K

- Key, mechanical 87
- Key, see Remote control 81
- Keyless Go, see Comfort entry 89
- Kickdown, Automatic transmission 132
- Knee airbag 166

L

- Label on recommended tires 284
- Lane departure warning 189
- Lane threshold, warning 189
- Language, setting on the Control Display 64
- Lashing eyes in the cargo area 258
- Launch Control 137
- Leather care 339
- LEDs, replacing, see Lights and bulbs 315
- Length, vehicle 344
- Letters and numbers, entering 57
- Lever
 - Shift lever 131
- License plate light, see Lights and bulbs 315
- Light in the exterior mirror, see Blind spot monitor 194
- Light in the exterior mirror, see RCTA (Rear cross traffic alert) function 232
- Light replacement, see Lights and bulbs 315

- Light switch 159
- Light-alloy wheels, care 340
- Light-emitting diodes, replacing, see Lights and bulbs 315
- Lighting 159
- Lights 159
- Lights and bulbs 315
- Lights, care 337
- List of all messages 66
- Load 258
- Loading 256
- Location, vehicle position 65
- Lock, lug bolts 299
- Locking using the remote control 83
- Locking, automatic 95
- Locking, see Opening and Closing 81
- Locking, settings 94
- Low beams 161
- Low beams, automatic, see Automatic high-beam 162
- Lower back support 104
- Lug bolt lock 299
- Lumbar support 104

M

- Maintenance 312
- Maintenance requirements, see Condition Based Service CBS 312
- Maintenance system 312
- Maintenance, see Service requirements 149
- Make-up mirror 248
- Malfunction displays, see Vehicle messages 140
- Malfunction, remote control 86
- Manual air distribution 240
- Manual air flow 240
- Manual brake, see Parking brake 124

Manual mode, Automatic transmission..... 132

Manual operation, fuel filler flap 273

Manual transmission 131

Manual transmission, Fluid... 346

Matte finish 338

Maximum cooling..... 238

Maximum speed display, see
Speed Limit Info 206

Measurement, units of 65

Memory function 112

Menu, instrument cluster, see
Selection lists 151

Menus, operating, see Toyota
Supra Command 50

Messages 66

Messages, see Vehicle messages 140

Microfilter 241

Minimum tread depth, tires ... 281

Mirror, see Memory function . 112

Mobile communication devices
in the vehicle 264

Mobile devices, managing..... 79

Mobility System 295

Modifications, technical, see For
Your Own Safety..... 5

Monitor, see Control Display... 52

Mounting of child restraint systems..... 116

Multi-function hook 258

Multifunction steering wheel,
buttons 38

N

Neck restraints, front, see Head
restraints..... 109

Net, cargo area 259

Neutral cleaner, see Light-alloy
wheels 340

New wheels and tires 283

NORMAL, see Sport mode switch
..... 138

Nylon rope for tow-starting/towing 333

O

Obstacle marking, rearview camera 230

Octane rating, see Recommended fuel grade..... 304

Oil 304

Oil change 308

Oil change interval, see Service requirements..... 149

Oil filler neck..... 306

Oil types to add, engine 307

Oil, adding 306

Onboard vehicle tool kit..... 314

On-call service, see Breakdown assistance 327

Opening and closing 81

Operating concept, Toyota Supra Command 50

Operating with the Controller .. 55

Operation via touchscreen 57

Overheating of engine, see Coolant temperature 148

Overwintering, see Long-term vehicle storage 342

P

Paint, vehicle..... 338

Panic alarm, see Panic mode .. 97

Panic mode 97

Parked-car ventilation 242

Parking aid, see Parking Sensors 223

Parking brake..... 124

Parking lights..... 160

Parking Sensors 223

Parking Sensors with emergency braking function 190
 Parking Sensors with emergency braking function, see Emergency brake function 226
 Parts and accessories 6
 Passenger's side mirror, tilting, see Automatic Curb Monitor, exterior mirror 111
 Pathway lines, rearview camera 230
 Performance display, see Sport displays 155
 Personal data, deleting 68
 Personal profile, see Driver profiles 69
 Plastic parts, care 341
 Power failure 318
 Power windows 98
 Pre-Collision System (for pedestrians and bicycles) 185
 Pressure monitor, see Tire Pressure Monitor TPM 286
 Pressure, tires 274
 Prevention of rear collision ... 198
 Profiles, see Driver profiles 69
 Programmable memory buttons, Toyota Supra Command 60
 Protective function, windows, see Jam protection system ... 99
 Push-and-turn reel, see Controller 53

R

Racetrack operation 267
 Radar sensors, see Sensors of the vehicle 42
 Radiator fluid 309
 Radio-operated remote control, see Remote control 81
 Rain sensor 128
 RCTA (Rear cross traffic alert) function 232
 Rear collision warning, see Prevention of rear collision 198
 Rear lights, see Lights and bulbs 315
 Rear window defroster 241
 Rearview camera 228
 Recirculated-air filter, see Microfilter/activated-charcoal filter 241
 Recirculated-air mode 239
 Recommended fuel grade 304
 Recommended tire brands ... 284
 Refueling 272
 Remote control of the vehicle, changing the battery 85
 Remote control, additional 86
 Remote control, integrated key 87
 Remote control, loss 86
 Remote control, malfunction ... 86
 Remote control, opening/closing 81
 Remote control, universal 244
 Replacing parts 314
 Replacing wheels/tires 283
 Reporting safety malfunctions 15
 RES CNCL button, see Cruise control 208
 RES CNCL button, see Dynamic radar cruise control with full-speed range 212
 Reserve warning, see Range. 149
 Reset, Tire Pressure Monitor TPM 289
 Retreaded tires 284
 Reversing lights, bulb replacement, see Lights and bulbs. 315
 Roadside Assistance, see Breakdown assistance 327
 Roadside parking lights 161

Rolling code hand-held transmitter.....246
 RON recommended fuel grade304
 Roof load capacity345
 Roofliner41
 Rope for tow-starting/towing 333
 Rubber components, care.....341

S

Safe braking.....265
 Safety belt warning for driver's seat and front passenger seat108
 Safety belts104
 Safety belts, care.....341
 Safety systems, see Airbags.166
 Safety systems, see Toyota
 Supra Safety178
 Saving fuel267
 Screen Mirroring, connection .78
 Screen, see Control Display....52
 Screwdriver, see Onboard vehicle tool kit314
 Sealant, see Mobility System 295
 Seat heating113
 Seat, see Memory function....112
 Seating position for children.115
 Seats, front100
 Securing cargo258
 Selection list in instrument cluster.....151
 Selector lever, Automatic transmission.....132
 Sensors of the vehicle42
 Sensors, care.....342
 Service and warranty7
 Service requirements.....149
 Service requirements, see Condition Based Service CBS312
 SET button, see Cruise control208

SET button, see Dynamic radar cruise control with full-speed range.....212
 Set speed, see Dynamic radar cruise control with full-speed range.....212
 Settings on Control Display64
 Settings, locking/unlocking.....94
 Shift lever
 Manual transmission131
 Shift paddles on the steering wheel132
 Side airbag166
 Side protection226
 Signaling, horn38
 Signals when unlocking, see Confirmation signals from the vehicle95
 Sitting safely100
 Sizes, see Dimensions344
 Smallest turning radius.....344
 SMS text message, supplementary141
 Snow chains.....286
 Sockets.....248
 SOS button, see Intelligent emergency call328
 Special equipment, see Vehicle features and options4
 Speed Limit Assist221
 Speed limit display, see Speed Limit Info206
 Speed Limit Info.....206
 Sport chassis/suspension, see Adaptive variable suspension234
 Sport displays.....155
 Sport mode switch138
 Sport program, Automatic transmission132
 SPORT, see Sport mode switch138

- Stability control systems.....201
 Standard equipment, see Vehicle features and options 4
 Standard view, Head-up Display 157
 Standby state, idle state and drive-ready state 48
 Start/Stop button 120
 Start/stop, automatic function 120
 Status control display, tires ..288
 Status information, Toyota Supra Command..... 51
 Status of Owner's Manual5
 Status, vehicle 156
 Steering wheel, adjusting 111
 Steering wheel, buttons..... 38
 Steering wheel, see Memory function 112
 Steptronic Sport transmission, see Automatic transmission 132
 Storage compartments, locations 255
 Storage, tires 285
 Storing the vehicle 342
 Stowing and securing cargo .258
 Straps for cargo, see Lashing eyes in the cargo area 258
 Sun visor 248
 Supplementary SMS text message 141
 Suspension settings, see Sport mode switch 138
 Switch for driving dynamics, see Sport mode switch 138
 Switches, see Cockpit 38
 Symbols and displays 4
- T**
- Tail lights, see Lights and bulbs 315
- Technical changes, see For Your Own Safety5
 Technical data344
 Temperature display, see External temperature.....149
 Temperature, automatic air conditioning237
 Temperature, engine oil148
 Theft alarm system, see Alarm system96
 Tilt alarm sensor97
 Tilt, backrest103
 Tilting the passenger's side mirror, see Automatic Curb Monitor, exterior mirror 111
 Time64
 Tire brands, recommended ...284
 Tire damage282
 Tire identification marks279
 Tire inflation pressure274
 Tire pressure274
 Tire Pressure Monitor TPM286
 Tire repair kit, see Mobility System295
 Tire sealant, see Mobility System295
 Tire settings287
 Tire tread281
 Tires and wheels.....274
 Tires, changing283
 Tool314
 Torque display, see Sport displays155
 Touchscreen57
 Tow bar333
 Tow fitting.....334
 Tow rope333
 Towing331
 Tow-starting331
 Toyota Supra Command50
 Toyota Supra Safety178
 TPM Tire Pressure Monitor286

Traction control 204
 Traction mode 204
TRACTION, driving dynamics 204
Transmission
 Manual transmission 131
Transmission lock, electronic
 unlocking 136
Transmission, see Automatic
 transmission 132
Transporting children safely . 115
Tread, tires 281
Triple turn signal activation... 126
Trunk lid 93
Trunk lid via remote control 84
Trunk lid, emergency unlocking
 94
Trunk lid, see Trunk lid 93
Trunk, emergency unlocking... 94
Turn signal, indicator light 146
Turn signals, bulb replacement,
 see Lights and bulbs 315
Turning circle 344
Turning radius lines, rearview
 camera 230

U

Ultrasonic sensors, see Sensors
 of the vehicle 42
Unintentional alarm, avoiding 97
Units of measurement 65
Universal remote control 244
Unlock button, Automatic trans-
 mission 132
Unlocking with the remote con-
 trol 82
Unlocking, automatic 95
Unlocking, see Opening and
 Closing 81
Unlocking, settings 94
Updates made after the editorial
 deadline 5
Upholstery material care 340

USB connection 76
USB interface, position in vehicle
 249
Use, intended 5
Used battery, disposing of 318

V

Vanity mirror 248
Vehicle battery 316
Vehicle breakdown, see Break-
 down assistance 327
Vehicle care 338
Vehicle care products 338
Vehicle features and options 4
Vehicle identification number .. 12
Vehicle key, see Remote control
 81
Vehicle messages 140
Vehicle paint 338
Vehicle position, vehicle location
 65
Vehicle Stability Control VSC 203
Vehicle status 156
Vehicle storage 342
Vehicle wash 336
Vehicle, break-in 262
Vehicle, washing 335
Vent, see Ventilation 241
Ventilation 241
Ventilation, see Parked-car ven-
 tilation 242
Venting, see Ventilation 241
VIN, see Vehicle identification
 number 12
Voice activation system 60
VSC Vehicle Stability Control
 System 203

W

Warning against cross traffic 232

- Warning and indicator lights, see
 Vehicle messages 140
- Warning light in the exterior mirror, see Blind spot monitor . 194
- Warning light in the exterior mirror, see RCTA (Rear cross traffic alert) function 232
- Warning messages, see Vehicle messages 140
- Warning triangle 327
- Warranty 5
- Washer nozzles, windshield.. 130
- Washer system 127
- Washing the vehicle 335
- Water on roads 265
- Water, see Condensation water under the parked vehicle 267
- Weights 345
- Welcome light during unlocking 82
- Welcome lights 161
- Wheel cleaner, light-alloy wheels 340
- Wheelbase, vehicle 344
- Wheels and tires..... 274
- Wheels, changing..... 283
- Width, vehicle 344
- Window defroster, rear 241
- Window, defrosting and defogging..... 240
- Windows, powered..... 98
- Windshield washer nozzles... 130
- Windshield washer system, see Washer/wiper system..... 127
- Windshield wiper, see Wiper system 127
- Winter storage, see Long-term vehicle storage 342
- Winter tires..... 285
- Wiper blades, replacing 315
- Wiper system 127
- Wiper, fold-away position 130
- Wiper, see Washer/wiper system 127
- Wordmatch principle, see Entry comparison 50
- Wrench, see Onboard vehicle tool kit..... 314



