



4RUNNER

2 0 2 5

OWNER'S MANUAL



Pictorial index	Search by illustration	
For safety and security	Make sure to read through them (Main topics: Child seat, theft deterrent system)	1
Vehicle status information and indicators	Reading driving-related information (Main topics: Meters, multi-information display)	2
Before driving	Opening and closing the doors and windows, adjustment before driving (Main topics: Keys, doors, seats)	3
Driving	Operations and advice which are necessary for driving (Main topics: Starting engine, refueling)	4
Interior features	Usage of the interior features (Main topics: Air conditioner, storage features)	5
Maintenance and care	Caring for your vehicle and maintenance procedures (Main topics: Interior and exterior, light bulbs)	6
When trouble arises	What to do in case of malfunction and emergency (Main topics: Battery discharge, flat tire)	7
Vehicle specifications	Vehicle specifications, customizable features (Main topics: Fuel, oil, tire inflation pressure)	8
For owners	Reporting safety defects for U.S. owners, seat belt and SRS airbag instructions for Canadian owners	9
Index	Search by symptom	
	Search alphabetically	

For your information.....	6
Reading this manual	13
How to search	14
Pictorial index	16

1 For safety and security

1-1. For safe use

Before driving	28
For safe driving	29
Seat belts	31
SRS airbags	36
Front passenger occupant classification system	44
Exhaust gas precautions..	48

1-2. Child safety

Riding with children	50
Child restraint systems.....	51

1-3. Emergency assistance

Safety Connect	65
----------------------	----

1-4. Theft deterrent system

Engine immobilizer system	70
Alarm.....	71

2 Vehicle status information and indicators

2-1. Instrument cluster

Warning lights and indicators	74
Gauges and meters (7-inch display).....	81
Gauges and meters (12.3- inch display)	85
Multi-information display (7- inch display)	91

Multi-information display (12.3-inch display)	100
Fuel consumption information	110

3 Before driving

3-1. Key information

Keys	114
Digital Key	117

3-2. Opening, closing and locking the doors

Side doors	119
Power running boards ...	124
Back door	127
Smart key system.....	145

3-3. Adjusting the seats

Front seats	151
Rear seats.....	152
Head restraints	158

3-4. Adjusting the steering wheel and mirrors

Steering wheel.....	161
Inside rear view mirror...	162
Digital Rear-view Mirror.	164
Outside rear view mirrors	173

3-5. Opening, closing the windows and moon roof

Power windows	177
Power back window.....	180
Moon roof	182

3-6. Favorite settings

Driving position memory	186
My Settings.....	189

4 Driving

4-1. Before driving

- Driving the vehicle..... 193
- Cargo and luggage 200
- Vehicle load limits 204
- Trailer towing..... 205
- Dinghy towing 217

4-2. Driving procedures

- Engine (ignition) switch . 218
- Automatic transmission. 222
- Turn signal lever..... 226
- Parking brake 227
- Brake Hold 231

4-3. Operating the lights and wipers

- Headlight switch 234
- Fog light switch 237
- AHB (Automatic High Beam) 238
- Windshield wipers and washer..... 241
- Rear window wiper and washer..... 243

4-4. Refueling

- Opening the fuel tank cap 246

4-5. Using the driving support systems

- Toyota Safety Sense 3.0 software update 248
- Toyota Safety Sense 3.0 250
- PCS (Pre-Collision System) 259
- LTA (Lane Tracing Assist) 270

- LDA (Lane Departure Alert) 275
- PDA (Proactive driving assist) 281
- RSA (Road Sign Assist). 288
- Dynamic radar cruise control 290
- Cruise control 301
- Emergency Driving Stop System 305
- TDA (Trailer Driving Assist) 308
- Stop & Start system..... 309
- BSM (Blind Spot Monitor) 316
- Intuitive parking assist... 323
- RCTA (Rear Cross Traffic Alert) function 330
- RCD (Rear Camera Detection) 335
- PKSB (Parking Support Brake)..... 339
- Parking Support Brake function (static objects front and rear of the vehicle)..... 344
- Parking Support Brake function (moving vehicles rear of the vehicle) 347
- Parking Support Brake function (pedestrians rear of the vehicle) 348
- Toyota parking assist monitor 350
- Panoramic view monitor 363
- Multi-terrain Monitor 399
- Driving mode select switch 412

1

2

3

4

5

6

7

8

9

Four-wheel drive system (part-time 4WD models)	414
Four-wheel drive system (full- time 4WD models).....	417
AUTO LSD system.....	419
Rear differential lock system	421
Crawl Control	422
Multi-terrain Select	425
Downhill assist control sys- tem	428
Driving assist systems ..	431
SDM (Stabilizer with Discon- nection Mechanism)	436
Trailer brake controller ..	437
Trailer Backup Guide	440
4-6. Driving tips	
Off-road precautions	445
Winter driving tips	448

5 Interior features

5-1. Using the air conditioning system and defogger	
Manual air conditioning sys- tem	454
Automatic air conditioning system.....	460
Heated steering wheel/seat heaters/seat ventilators	467
5-2. Using the interior lights	
Interior lights list	469
5-3. Using the storage features	
List of storage features .	472
Luggage compartment fea- tures	478

5-4. Using the other interior fea- tures

Other interior features ...	480
Removable speaker	496
Garage door opener	504

6 Maintenance and care

6-1. Maintenance and care

Cleaning and protecting the vehicle exterior	514
Cleaning and protecting the vehicle interior	517

6-2. Maintenance

Maintenance requirements	520
General maintenance	522
Emission inspection and maintenance (I/M) programs	525

6-3. Do-it-yourself maintenance

Do-it-yourself service precau- tions.....	526
Hood.....	528
Engine compartment	530
Tires	539
Tire inflation pressure	553
Wheels	555
Air conditioning filter	557
Electronic key battery	558
Checking and replacing fuses	560
Light bulbs	563

7 When trouble arises

7-1. Essential information

- Emergency flashers 568
- If your vehicle has to be stopped in an emergency 568
- If the vehicle is submerged or water on the road is rising 569

7-2. Steps to take in an emergency

- If your vehicle needs to be towed..... 571
- If you think something is wrong 574
- Fuel pump shut off system 575
- If a warning light turns on or a warning buzzer sounds 576
- If a warning message is displayed..... 587
- If you have a flat tire..... 593
- If the engine will not start 604
- If you lose your keys 605
- If the electronic key does not operate properly 606
- If the vehicle battery is discharged 608
- If your vehicle overheats 612
- If the vehicle becomes stuck 614

8 Vehicle specifications

8-1. Specifications

- Maintenance data (fuel, oil level, etc.) 616
- Fuel information..... 624
- Tire information 626

8-2. Customization

- Customizable features... 637

8-3. Initialization

- Items to initialize..... 653

9 For owners

9-1. For owners

- Reporting safety defects for U.S. owners..... 656
- Reporting safety defects for Canadian owners 656
- Seat belt instructions for Canadian owners (in French) 657
- SRS airbag instructions for Canadian owners (in French) 658

Index

- What to do if... (Troubleshooting) 666
- Alphabetical Index 669

1

2

3

4

5

6

7

8

9

For your information

Main Owner's Manual

Please note that this manual applies to all models and explains all equipment, including options. Therefore, you may find explanations for equipment not installed on your vehicle and the illustrations used may differ from your vehicle.

All specifications provided in this manual are current at the time of printing. Over time, your vehicle may receive updates that modify the vehicle and make material in this manual incomplete and/or inaccurate. Because of Toyota's interest in continual product improvement, Toyota reserves the right to make changes to this manual at any time without notice.

If Toyota chooses to update the manual, updated versions can be viewed by selecting your vehicle by model and year at the following URL or on your mobile device if you have access to the Toyota app.

www.toyota.com/owners

Noise from under vehicle after turning off the engine

Approximately five hours after the engine is turned off, you may hear sound coming from

under the vehicle for several minutes. This is the sound of a fuel evaporation leakage check and it does not indicate a malfunction.

Cyber Attack Risk

Installing electronic devices and radios increases the risk of cyber attacks through the installed parts, which may lead to unexpected accidents and leakage of personal information. Toyota does not make any guarantees for problems caused by installing non-genuine Toyota products.

Accessories, spare parts and modification of your Toyota

A wide variety of non-genuine spare parts and accessories for Toyota vehicles are currently available in the market. You should know that Toyota does not warrant these products and is not responsible for their performance, repair, or replacement, or for any damage they may cause to, or adverse effect they may have on, your Toyota vehicle.

This vehicle should not be modified with non-genuine Toyota products. Modification with non-genuine Toyota products could affect its performance, safety or

durability, and may even violate governmental regulations. In addition, damage or performance problems resulting from the modification may not be covered under warranty.

Also, remodeling like this will have an effect on advanced safety equipment such as Toyota Safety Sense 3.0 and there is a danger that it will not work properly or the danger that it may work in situations where it should not be working.

Installation of a mobile two-way radio system

The installation of a mobile two-way radio system in your vehicle could affect electronic systems such as:

- Multiport fuel injection system/sequential multiport fuel injection system
- Toyota Safety Sense 3.0
- Anti-lock brake system
- Vehicle dynamics integrated management
- SRS airbag system
- Seat belt pretensioner system

Be sure to check with your Toyota dealer for precautionary measures or special instructions regarding installation of a mobile two-way radio system.

Vehicle data recording

This vehicle is equipped with sophisticated computers that record certain data regarding vehicle controls and operations.

■ Data recorded by the computers*¹

*¹: The recorded data varies according to the vehicle grade level and options with which it is equipped.

Certain data, such as the following, is recorded depending on the operation timing and status of each function.

- Basic vehicle behavior related data (engine speed, accelerator/brake pedal operation, vehicle speed, etc.)
- Operating state of the driving support systems (recorded during system operation, includes basic vehicle behavior related data)
- Driving support system sensor data
- Image data (images from the front, rear and side cameras)*²

*²: The vehicle has multiple cameras. For details on from which cameras images are recorded, contact your Toyota dealer.

● Location information

These computers do not record conversations, sounds, or images of the inside of the vehi-

cle.

Also, personal information which may be used to identify the owner of the vehicle (name, gender, age, etc.) is not recorded.

■ Usage of recorded data and personal information by the Toyota Safety Sense 3.0

The operating state of each system, data from each sensor, image data (images from the front/rear cameras), and position information is recorded by the Toyota Safety Sense 3.0 in the following situations. Toyota obtains this information when the vehicle is brought to the dealership or when sent to the Toyota servers.

- In certain collisions or collision-like situations
- When driving on roads with certain traffic situations, such as congestion, poor road surfaces, poor weather, etc.
- When driving on certain roads, such as roads which were recently opened or extended
- After the engine is started, for a certain amount of time

To learn more about the vehicle data collected, used and shared by Toyota, please visit www.toyota.com/privacyvts/.

■ Data provision and use purpose by third parties

Data recorded by the computers may be used for collision analysis, malfunction diagnosis, automated driving, advanced safety and map related technologies (technology, product development, product improvement, etc.) and products and services which use data (maps used for automated driving and advanced safety technologies, driving condition analysis, analysis of the driving environment, such as road infrastructure, traffic condition communication, etc. Herein referred to as “individual services”).

Also, this data may be used for customer support related to a collision, collision analysis or resolution.

In situations such as the following, Toyota may disclose the recorded data to a third party:

- When the consent of the vehicle owner (or the lessee if the vehicle is leased) has been given
- When officially requested by the police, a court of law or a government agency
- When it is to be used by Toyota in a lawsuit
- When data is to be used research purposes after processing so that the data is not

tied to a specific vehicle or vehicle owner

In addition to the above, Toyota may disclose the data recorded by the Toyota Safety Sense 3.0 to a third party in the following situations:

- When separate consent of the vehicle owner (or the lessee if the vehicle is leased) has been given. This includes situations when the user subscribes to an individual service which is provided by a second party and uses vehicle recorded data, where the provider has obtained the user's consent for providing data to a third-party
- When providing data to a company involved in autonomous driving software, etc. for the purpose of research and development (technology, product development, product improvement, etc.) of automated driving, advanced safety and map related technologies
- When providing image data and position information to a company involved in map creation, etc. for the purpose of research and development map related technologies
- When providing image data and position information to a local government for the purpose of road maintenance,

etc.

- When providing processed image data and position information to traffic condition communication individual services
- When providing image data from near a fire, or other area that emergency services are dispatched, to the fire department of a local government which has entered a separate contract with Toyota

Image information recorded by the vehicle can be erased by your Toyota dealer.

The image recording function can be disabled. However, if the function is disabled, data from when systems operate will not be available.

If you wish to stop the collection of Toyota Safety Sense 3.0 data by the Toyota servers for the purpose of research and development and provision to individual services, contact your Toyota dealer.

Usage of data collected through Safety Connect (U.S.mainland only)

If your Toyota has Safety Connect and if you have subscribed to those services, please refer to the Safety Connect Telematics Subscription Service Agreement for information on data collected and its usage.

- To learn more about the vehicle data collected, used and shared by Toyota, please visit www.toyota.com/privacyvts/.

Statement on Warranty Coverage for Aftermarket and Recycled Parts (For U.S. Owners)

The Magnuson-Moss Warranty Act, 15 U.S.C. s.2301 et seq., makes it illegal for motor vehicle manufacturers to void a motor vehicle warranty or deny warranty coverage solely because an aftermarket or recycled part has been used to repair the vehicle or someone other than the authorized service provider performed service on the vehicle. This provision does not apply to a new motor vehicle purchased solely for commercial or industrial use.

Under federal law, a manufacturer may deny warranty coverage and charge for repairs to a vehicle if it is discovered that an aftermarket or recycled part installed on the vehicle is defective or was installed incorrectly and caused damage to another part of the vehicle otherwise covered under warranty. The Federal Trade Commission requires that a manufacturer demonstrate that an aftermar-

ket or recycled part or service performed by a person other than an authorized service provider caused damage to another part of the vehicle otherwise covered under warranty before denying warranty coverage. Additionally, federal law allows a manufacturer to void a motor vehicle warranty or deny warranty coverage if the manufacturer provides the article or service to consumers free of charge under the warranty or the manufacturer has secured a waiver from the Federal Trade Commission.

Event data recorder

This vehicle is equipped with an event data recorder (EDR). The main purpose of an EDR is to record, in certain crash or near crash-like situations, such as an air bag deployment or hitting a road obstacle, data that will assist in understanding how a vehicle's systems performed. The EDR is designed to record data related to vehicle dynamics and safety systems for a short period of time, typically 30 seconds or less.

The EDR in this vehicle is designed to record such data as:

- How various systems in your vehicle were operating;

- Whether or not the driver and passenger safety belts were buckled/fastened;
- How far (if at all) the driver was depressing the accelerator and/or brake pedal; and,
- How fast the vehicle was traveling.

These data can help provide a better understanding of the circumstances in which crashes and injuries occur.

NOTE: EDR data are recorded by your vehicle only if a non-trivial crash situation occurs; no data are recorded by the EDR under normal driving conditions and no personal data (e.g., name, gender, age, and crash location) are recorded. However, other parties, such as law enforcement, could combine the EDR data with the type of personally identifying data routinely acquired during a crash investigation.

To read data recorded by an EDR, special equipment is required, and access to the vehicle or the EDR is needed. In addition to the vehicle manufacturer, other parties, such as law enforcement, that have the special equipment, can read the information if they have access to the vehicle or the EDR.

- Disclosure of the EDR data
Toyota will not disclose the data recorded in an EDR to a third party

except when:

- An agreement from the vehicle's owner (or the lessee for a leased vehicle) is obtained
- In response to an official request by the police, a court of law or a government agency
- For use by Toyota in a lawsuit
- However, if necessary, Toyota may:
 - Use the data for research on vehicle safety performance
 - Disclose the data to a third party for research purposes without disclosing information about the specific vehicle or vehicle owner

Scraping of your Toyota

The SRS airbag and seat belt pretensioner devices in your Toyota contain explosive chemicals. If the vehicle is scrapped with the airbags and seat belt pretensioners left as they are, this may cause an accident such as fire. Be sure to have the systems of the SRS airbag and seat belt pretensioner removed and disposed of by a qualified service shop or by your Toyota dealer before you scrap your vehicle.

Perchlorate Material

Special handling may apply, See www.dtsc.ca.gov/hazardouswaste/perchlorate.

Your vehicle has components

that may contain perchlorate. These components may include airbags, seat belt pretensioners, wireless remote control batteries, and the batteries in the tire pressure warning valve and transmitters.

“QR Code”

The word “QR Code” is registered trademark of DENSO WAVE INCORPORATED in Japan and other countries.



WARNING

■ General precautions while driving

Driving under the influence: Never drive your vehicle when under the influence of alcohol or drugs that have impaired your ability to operate your vehicle. Alcohol and certain drugs delay reaction time, impair judgment and reduce coordination, which could lead to an accident that could result in death or serious injury.

Defensive driving: Always drive defensively. Anticipate mistakes that other drivers or pedestrians might make and be ready to avoid accidents.

Driver distraction: Always give your full attention to driving. Anything that distracts the driver, such as adjusting controls, talking on a cellular phone or reading can result in a collision with resulting death or serious injury to you, your occupants or others.

■ General precaution regarding children's safety



Never leave children unattended in the vehicle, and never allow children to have or use the key.



Children may be able to start the vehicle or shift the vehicle into neutral. There is also a danger that children may injure themselves by playing with the windows, the moon roof (if equipped), or other features of the vehicle. In addition, heat build-up or extremely cold temperatures inside the vehicle can be fatal to children.

Reading this manual



Explains symbols used in this manual.

Symbols in this manual

Symbols	Meanings
	WARNING: Explains something that, if not obeyed, could cause death or serious injury to people.
	NOTICE: Explains something that, if not obeyed, could cause damage to or a malfunction in the vehicle or its equipment.
1 2 3...	Indicates operating or working procedures. Follow the steps in numerical order.

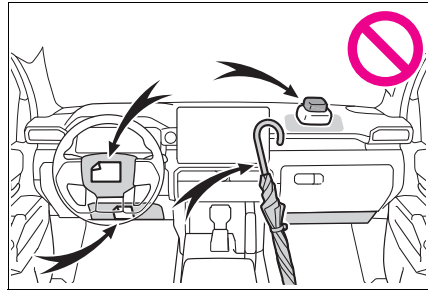
Symbols	Meanings
	Indicates the action (pushing, turning, etc.) used to operate switches and other devices.
	Indicates the outcome of an operation (e.g. a lid opens).



Symbols	Meanings
	Indicates the component or position being explained.
	Means Do not , Do not do this , or Do not let this happen .

Symbols in illustrations

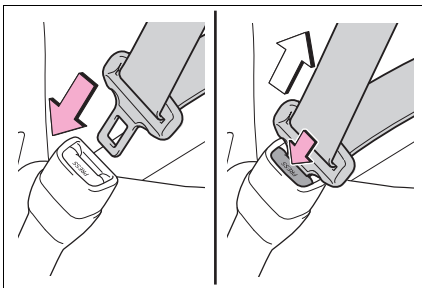

How to search

■ Searching by name

- Alphabetical index: →P.669

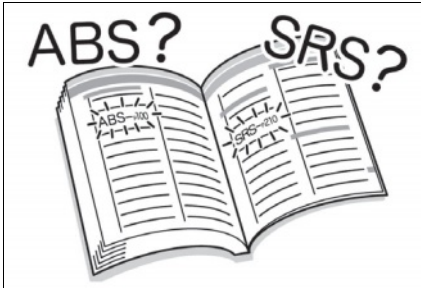

■ Searching by installation position

- Pictorial index: →P.16

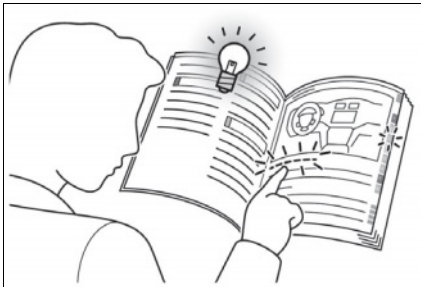

■ Searching by symptom or sound

- What to do if... (Troubleshooting): →P.666



■ Searching by title

- Table of contents: →P.2

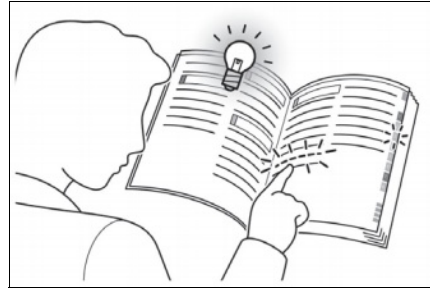

Pictorial index

■ Exterior

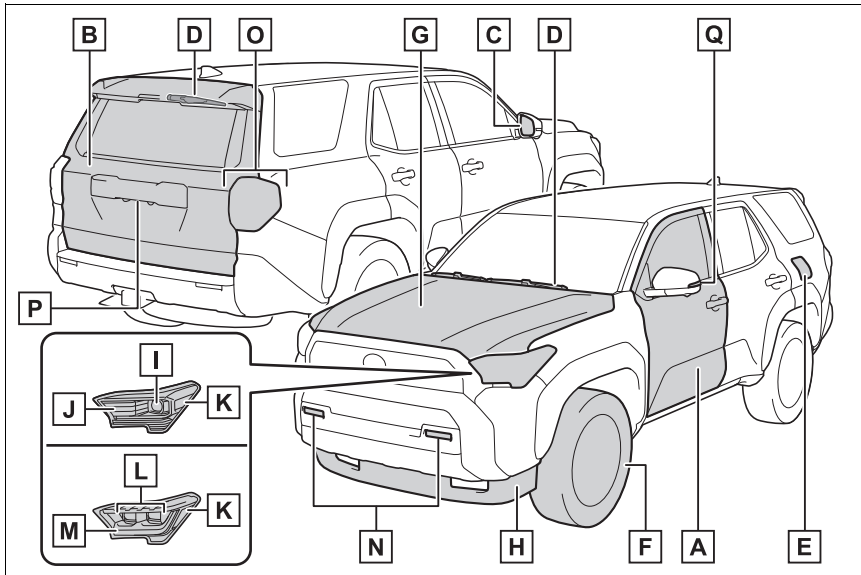

- A Side doors P.119**
 - Locking/unlocking P.119
 - Opening/closing the side windows P.177
 - Locking/unlocking by using the mechanical key P.606
 - Warning messages P.576
- B Back door P.127**
 - Locking/unlocking P.128
 - Opening/closing the back door P.129
 - Power back door* P.130
 - Opening/closing the power back window P.180
 - Warning messages P.576
- C Outside rear view mirrors P.173**
 - Adjusting the mirror angle P.173
 - Folding the mirrors P.174
 - Driving position memory* P.186

- Defogging the mirrors P.455, 462
- D** **Windshield wipers**..... **P.241**
Rear window wiper **P.243**
 Precautions for winter season..... P.448
 To prevent freezing (windshield wiper de-icer)..... P.457, 465
- E** **Fuel filler door** **P.246**
 Refueling method..... P.246
 Fuel type/fuel tank capacity P.617
- F** **Tires**..... **P.539**
 Tire size/inflation pressure P.622
 Winter tires/tire chains P.448
 Checking/rotation/tire pressure warning system P.539
 Coping with flat tires..... P.593
- G** **Hood**..... **P.528**
 Opening P.528
 Engine oil P.618
 Coping with overheating P.612
- H** **Front spoiler** **P.446**

Light bulbs of the exterior lights for driving

(Replacing method: P.563, Watts: P.623)

- I** **Head lights/daytime running lights** **P.234**
- J** **Turn signal lights** **P.226**
Parking lights **P.234**
- K** **Side marker lights**..... **P.234**
- L** **Headlights**..... **P.234**
- M** **Turn signal lights** **P.226**
Daytime running lights **P.234**
Parking lights **P.234**
- N** **Fog lights**..... **P.237**

O	Tail lights	P.234
	Turn signal lights	P.226
	Side marker lights	P.234
	Stop lights	
	Back-up lights	
	Changing the shift position to R	P.222
P	License plate lights	P.234
Q	Turn signal lights	P.226

* : If equipped

■ Instrument panel

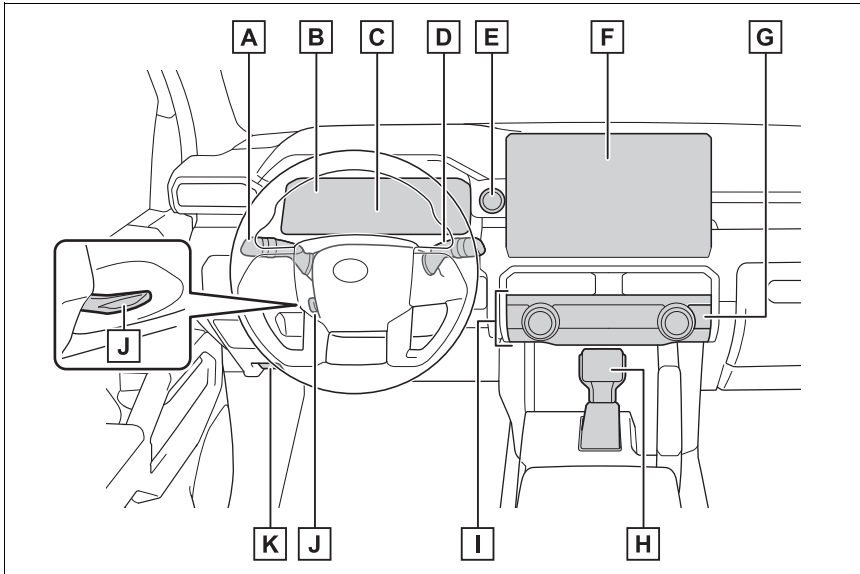

- A Turn signal lever..... P.226**
- Headlight switch P.234**
 Headlights/parking lights/tail lights/license plate lights/
 daytime running lights P.234
 Fog lights P.237
- B Multi-information display P.91, 100**
 Display P.91, 100
 When a warning message is displayed..... P.587
- C Meters P.81, 85**
 Reading the meters/adjusting the instrument panel light P.74
 Warning lights/indicator lights P.74
 When a warning light turns on P.576
- D Windshield wiper and washer switch..... P.241**
Rear windshield wiper and washer switch P.243
 Usage..... P.241, 243
 Adding washer fluid..... P.538

	Warning messages	P.587
E	Engine switch	P.218
	Starting the engine/changing the modes	P.218
	Emergency stop of the engine	P.568
	When the engine will not start	P.604
	Warning messages	P.587
F	Multimedia system ^{*1}	
G	Emergency flasher switch	P.568
H	Shift lever	P.222
	Changing the shift position	P.224
	Precautions for towing	P.571
	When the shift lever does not move	P.223
I	Air conditioning system	P.454, 460
	Usage	P.454, 460
	Rear window defogger	P.455, 462
J	Tilt and telescopic steering control switch ^{*2/}	
	tilt and telescopic steering lock release lever ^{*2}	P.161
	Adjustment	P.161
	Driving position memory ^{*2}	P.186
K	Hood lock release lever	P.528

^{*1}: Refer to "MULTIMEDIA OWNER'S MANUAL".

^{*2}: If equipped

■ Switches

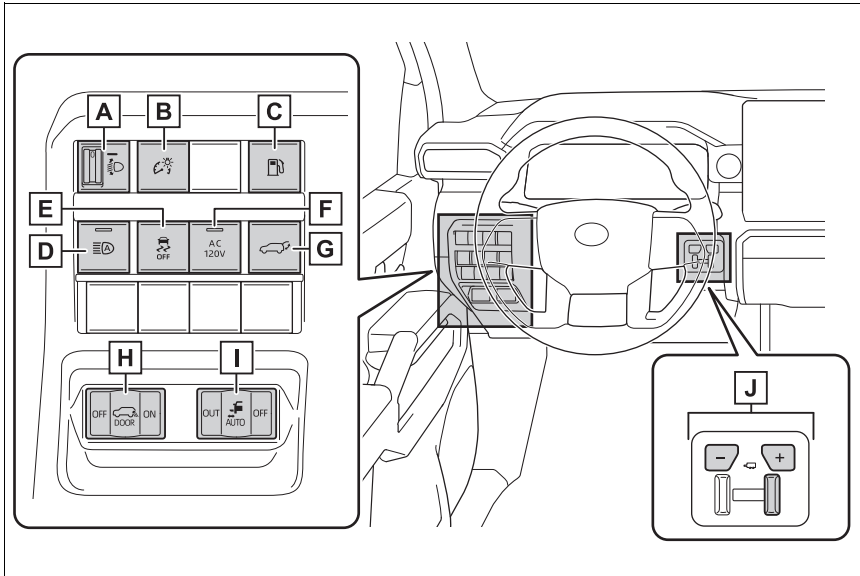

- A** Headlight leveling dial P.236
- B** Instrument panel light control switch P.84, 90
- C** Fuel lid opener switch P.247
- D** Automatic High Beam switch P.238
- E** VSC (Vehicle Stability Control) OFF switch P.432
- F** AC 120V switch * P.490
- G** Power back door opener switch * P.131
- H** Trailer hitch light switch * P.470
- I** Power running boards switch * P.126
- J** Trailer brake control switch * P.438

*: If equipped

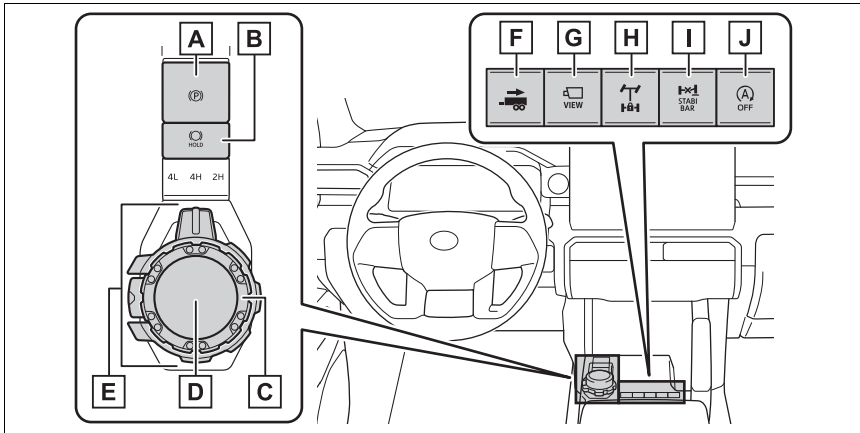

- A Parking brake switch P.227**
 Applying/releasing the parking brake P.227
 Precautions for winter season..... P.449
 Warning buzzer/messages..... P.229, 576
- B Brake hold switch P.231**
- C Mode select switch P.412, 423, 426, 428**
- D Mode switch**
 “TOW HAUL” switch P.225
 “DRIVE MODE” switch P.412
 “MTS” (Multi-terrain Select) switch * P.426
 “DAC/CRAWL” switch * P.423, 428
- E Front-wheel drive control switch * P.414, 417**
- F Trailer Backup Guide switch * P.440**
- G Camera switch * P.365, 399**
- H Rear differential lock switch * P.421**
- I SDM**
 (Stabilizer with Disconnection Mechanism) switch * P.436
- J Stop & Start cancel switch * P.310**

*: If equipped

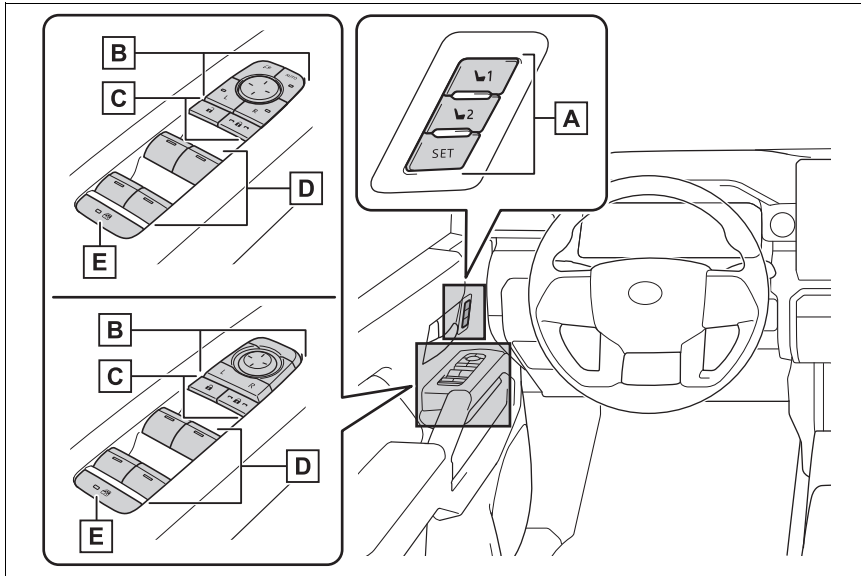

- A** Position memory buttons * P.187
- B** Outside rear view mirror switches P.173
- C** Door lock switches P.122
- D** Power window switches P.177
- E** Window lock switch P.179

*: If equipped

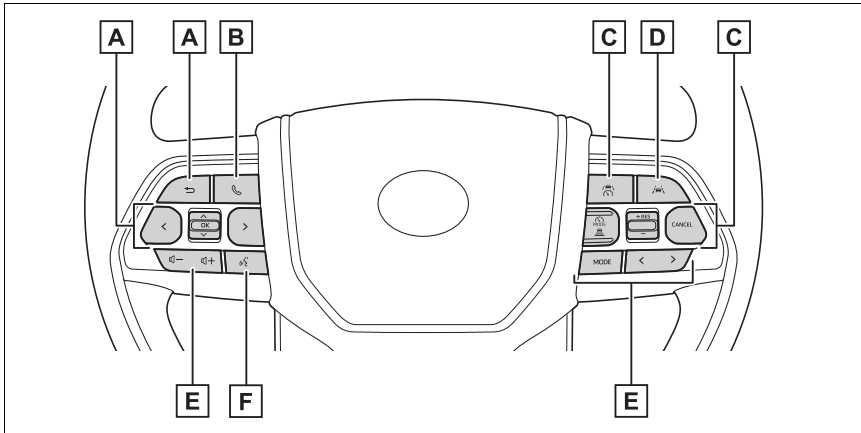

- A Meter control switches P.92, 101**
- B Phone switch ***
- C Cruise control switches**
 - Dynamic radar cruise control P.294
 - Cruise control P.301
- D LTA (Lane Tracing Assist) switch P.273**
- E Audio remote control switches ***
- F Talk switch ***

* : Refer to "MULTIMEDIA OWNER'S MANUAL".

■ Interior

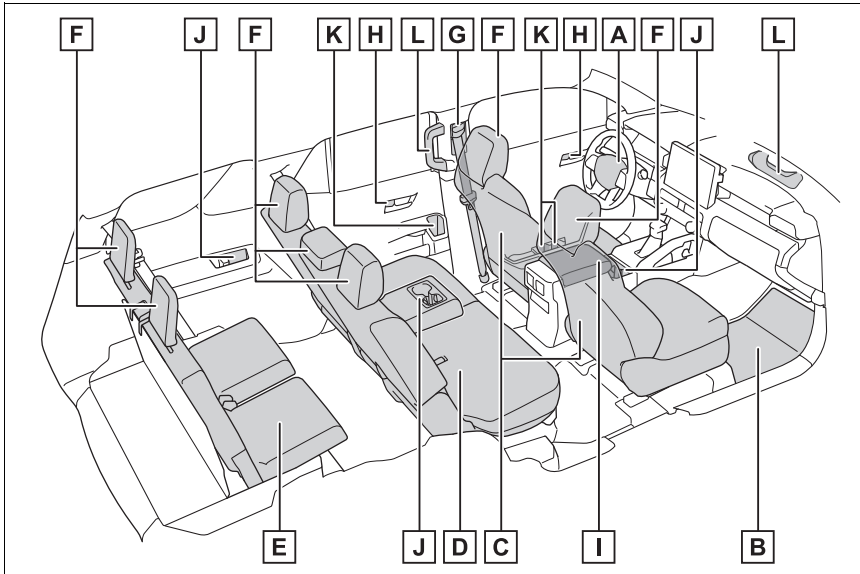

A	SRS airbags	P.36
B	Floor mats	P.28
C	Front seats	P.151
D	Second seats	P.152
E	Third seats *	P.152
F	Head restraints	P.158
G	Seat belts	P.31
H	Inside lock buttons	P.122
I	Console box	P.475
J	Cup holders	P.474
K	Bottle holders	P.474
L	Assist grip	P.489

* : if equipped

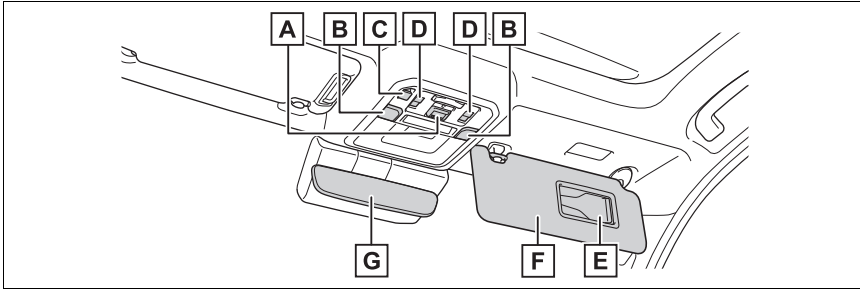

A	“SOS” button	P.65
B	Personal/interior lights	P.469
C	Power back window switch	P.180
D	Moon roof switches *	P.182
E	Vanity mirrors	P.495
	Ticket holders	P.478
F	Sun visors	P.495
G	Inside rear view mirror *	P.162
	Digital Rear-view Mirror *	P.164

* : If equipped

For safety and security

1

1-1. For safe use

Before driving	28
For safe driving	29
Seat belts	31
SRS airbags	36
Front passenger occupant classification system	44
Exhaust gas precautions	48

1-2. Child safety

Riding with children	50
Child restraint systems...	51

1-3. Emergency assistance

Safety Connect	65
----------------------	----

1-4. Theft deterrent system

Engine immobilizer system	70
Alarm.....	71

Before driving

Observe the following before starting off in the vehicle to ensure safety of driving.

Installing floor mats

Use only floor mats designed specifically for vehicles of the same model and model year as your vehicle. Fix them securely in place onto the carpet.

- 1 Insert the retaining hooks (clips) into the floor mat eyelets.

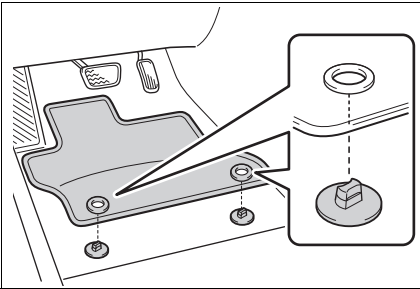

- 2 Turn the upper knob of each retaining hook (clip) to secure the floor mats in place.

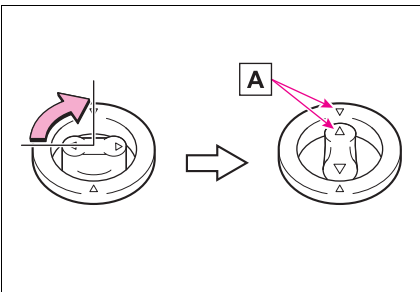

Always align the \triangle marks **A**.

The shape of the retaining hooks (clips) may differ from that shown in the illustration.

! WARNING

Observe the following precautions. Failure to do so may cause the driver's floor mat to slip, possibly interfering with the pedals while driving. An unexpectedly high speed may result or it may become difficult to stop the vehicle. This could lead to an accident, resulting in death or serious injury.

■ When installing the driver's floor mat

- Do not use floor mats designed for other models or different model year vehicles, even if they are Toyota Genuine floor mats.
- Only use floor mats designed for the driver's seat.
- Always install the floor mat securely using the retaining hooks (clips) provided.
- Do not use two or more floor mats on top of each other.
- Do not place the floor mat bottom-side up or upside-down.

WARNING

■ Before driving

- Check that the floor mat is securely fixed in the correct place with all the provided retaining hooks (clips). Be especially careful to perform this check after cleaning the floor.

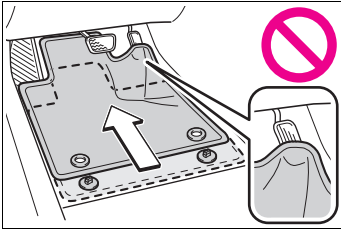

- With the engine stopped and the shift lever in P, fully depress each pedal to the floor to make sure it does not interfere with the floor mat.

For safe driving

For safe driving, adjust the seat and mirror to an appropriate position before driving.

Correct driving posture

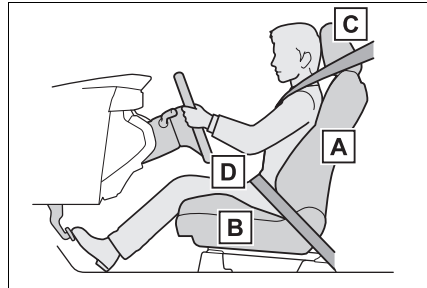

- A** Adjust the angle of the seat-back so that you are sitting straight up and so that you do not have to lean forward to steer. (→P.151)
- B** Adjust the seat so that you can depress the pedals fully and so that your arms bend slightly at the elbow when gripping the steering wheel. (→P.151)
- C** Lock the head restraint in place with the center of the head restraint closest to the top of your ears. (→P.158)
- D** Wear the seat belt correctly. (→P.31)

**WARNING****■ For safe driving**

Observe the following precautions.

Failure to do so may result in death or serious injury.

- Do not adjust the position of the driver's seat while driving. Doing so could cause the driver to lose control of the vehicle.
- Do not place a cushion between the driver or passenger and the seatback. A cushion may prevent correct posture from being achieved, and reduce the effectiveness of the seat belt and head restraint.
- Do not place anything under the front seats. Objects placed under the front seats may become jammed in the seat tracks and stop the seat from locking in place. This may lead to an accident and the adjustment mechanism may also be damaged.
- Always observe the legal speed limit when driving on public roads.
- When driving over long distances, take regular breaks before you start to feel tired. Also, if you feel tired or sleepy while driving, do not force yourself to continue driving and take a break immediately.

child becomes large enough to properly wear the vehicle's seat belt. (→P.51)

Adjusting the mirrors

Make sure that you can see rear of the vehicle clearly by adjusting the inside rear view mirror (if equipped), Digital Rear-view Mirror (if equipped) and outside rear view mirrors properly.

(→P.162, 164, 173)

Correct use of the seat belts

Make sure that all occupants are wearing their seat belts before driving the vehicle. (→P.31)

Use a child restraint system appropriate for the child until the

Seat belts

Make sure that all occupants are wearing their seat belts before driving the vehicle.

WARNING

Observe the following precautions to reduce the risk of injury in the event of sudden braking, sudden swerving or an accident. Failure to do so may cause death or serious injury.

■ Wearing a seat belt

- Ensure that all passengers wear a seat belt.
- Always wear a seat belt properly.
- Each seat belt should be used by one person only. Do not use a seat belt for more than one person at once, including children.
- Toyota recommends that children be seated in the rear seat and always use a seat belt and/or an appropriate child restraint system.
- To achieve a proper seating position, do not recline the seat more than necessary. The seat belt is most effective when the occupants are sitting up straight and well back in the seats.
- Do not wear the shoulder belt under your arm.
- Always wear your seat belt low and snug across your hips.

- Vehicles with third seats: Make sure that the seat belts are removed from the hangers when using the seat belts for the third seats. (→P.157)

■ Pregnant women

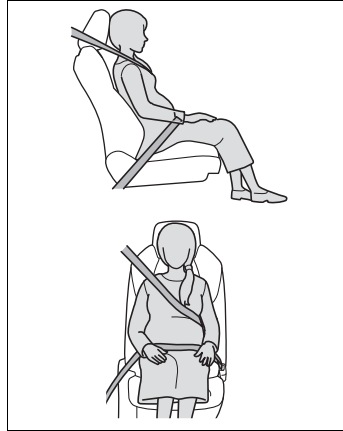

Obtain medical advice and wear the seat belt in the proper way. (→P.32)

Women who are pregnant should position the lap belt as low as possible over the hips in the same manner as other occupants, extending the shoulder belt completely over the shoulder and avoiding belt contact with the rounding of the abdominal area.

If the seat belt is not worn properly, not only the pregnant woman, but also the fetus could suffer death or serious injury as a result of sudden braking or a collision.

■ People suffering illness

Obtain medical advice and wear the seat belt in the proper way. (→P.32)

■ When children are in the vehicle

→P.59

**WARNING**

■ **Seat belt damage and wear**

- Do not damage the seat belts by allowing the belt, plate, or buckle to be jammed in the door.
- Inspect the seat belt system periodically. Check for cuts, fraying, and loose parts. Do not use a damaged seat belt until it is replaced. Damaged seat belts cannot protect an occupant from death or serious injury.
- Ensure that the belt and plate are locked and the belt is not twisted. If the seat belt does not function correctly, immediately contact your Toyota dealer.
- Replace the seat assembly, including the belts, if your vehicle has been involved in a serious accident, even if there is no obvious damage.
- Do not attempt to install, remove, modify, disassemble or dispose of the seat belts. Have any necessary repairs carried out by your Toyota dealer. Inappropriate handling may lead to incorrect operation.

Correct use of the seat belts



- Extend the shoulder belt so

that it comes fully over the shoulder, but does not come into contact with the neck or slide off the shoulder.

- Position the lap belt as low as possible over the hips.
- Adjust the position of the seatback. Sit up straight and well back in the seat.
- Do not twist the seat belt.

■ Child seat belt usage

The seat belts of your vehicle were principally designed for persons of adult size.

- Use a child restraint system appropriate for the child, until the child becomes large enough to properly wear the vehicle's seat belt. (→P.51)
- When the child becomes large enough to properly wear the vehicle's seat belt, follow the instructions regarding seat belt usage. (→P.31)

■ Seat belt extender

If your seat belts cannot be fastened securely because they are not long enough, a personalized seat belt extender is available from your Toyota dealer free of charge.

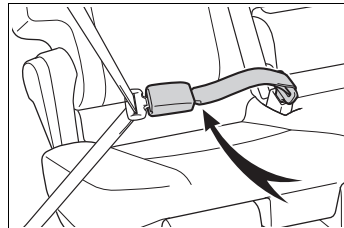

WARNING

■ Using a seat belt extender

Observe the following precautions to reduce the risk of injury in the event of sudden braking, sudden swerving or an accident. Failure to do so may cause death or serious injury.

- Do not wear the seat belt extender if you can fasten the seat belt without the extender.
- Do not use the seat belt extender when installing a child restraint system because the belt will not securely hold the child restraint system, increasing the risk of death or serious injury in the event of an accident.
- The personalized extender may not be safe on another vehicle, when used by another person, or at a different seating position other than the one originally intended.

NOTICE

■ When using a seat belt extender

When releasing the seat belt, press on the buckle release button on the extender, not on the seat belt. This helps prevent damage to the vehicle interior and the extender itself.

Fastening and releasing the seat belt

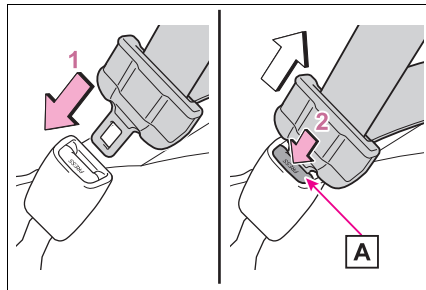

- 1 To fasten the seat belt, push the plate into the buckle until a click sound is heard.
- 2 To release the seat belt, press the release button **A**.

If the seat belt cannot be pulled out of the retractor, firmly pull the belt and release it.

■ Emergency locking retractor (ELR)

The retractor will lock the belt during a sudden stop or on impact. It may also lock if you lean forward too quickly. A slow, easy motion will allow the belt to extend so that you can move around fully.

■ Automatic locking retractor (ALR)

When a passenger's shoulder belt is completely extended and then retracted even slightly, the belt is locked in that position and cannot be extended. This feature is used to hold the child restraint system (CRS) firmly. To free the belt again, fully retract the belt and then pull the belt out once more. (→P.51)

■ After using the seat belts (second center seat and second left side seat)

Stow the seat belt buckles.

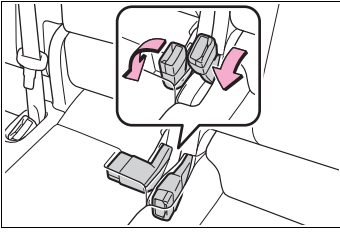

Adjusting the seat belt shoulder anchor height (front seats)

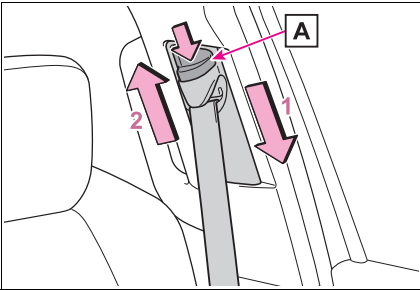

- 1 Push the seat belt shoulder anchor down while pressing the release button **A**.
- 2 Push the seat belt shoulder anchor up while pressing the release button **A**.

Move the height adjuster up and down as needed until you hear a click.

! WARNING

■ Adjustable shoulder anchor

Always make sure the shoulder belt is positioned across the center of your shoulder. The belt should be kept away from your neck, but not falling off your shoulder. Failure to do so could reduce the amount of protection in an accident and cause death or serious injuries in the event of a sudden stop, sudden swerve or accident.

Seat belt pretensioners

When the vehicle is subjected to a severe frontal or side impact or rollover, the pretensioners retract the seat belts of the front seats and second outer seats to securely restrain the occupants.

The pretensioners will not operate in minor frontal or side impacts, or rear impacts.

■ Replacing the belt after the pretensioner has been activated

If the vehicle is involved in multiple collisions, the pretensioner will activate for the first collision, but will not activate for the second or subsequent collisions.

■ PCS-linked control

If the PCS (Pre-Collision System) determines that the possibility of a collision with a vehicle is high, the seat belt pretensioners will be prepared to operate.

**WARNING****■ Seat belt pretensioners**

Observe the following precautions to reduce the risk of injury in the event of sudden braking, or an accident.

Failure to do so may result in death or serious injury.

- Do not place anything, such as a cushion, on the front passenger's seat. Doing so will disperse the passenger's weight, which prevents the sensor from detecting the passenger's weight properly. As a result, the seat belt pretensioner for the front passenger's seat may not operate in the event of a collision.
- If a pretensioner has operated, the SRS warning light will illuminate. In this situation, the seat belt cannot be used and must be replaced by your Toyota dealer.

SRS airbags

The SRS airbags deploy when the vehicle is subjected to certain types of severe impact that may cause significant injury to the occupants. The airbags work together with the seat belts to help reduce the risk of death or serious injury.

SRS airbag system

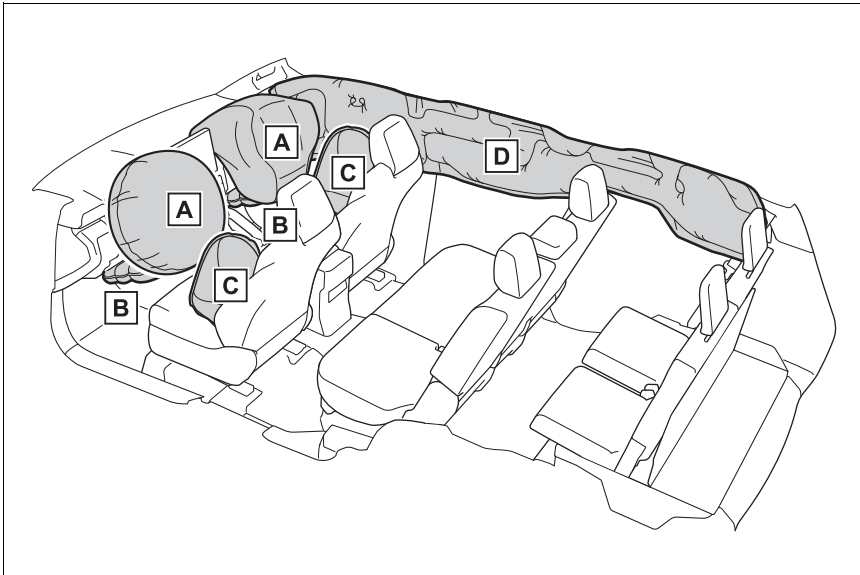

- A** SRS driver airbag/front passenger airbag
Help reduce impact to the head and chest of the driver and front passenger
- B** SRS knee airbags
Help reduce impact to the driver and front passenger
- C** SRS side airbags
Help reduce impact to the chest of the occupants of the front seats
- D** SRS curtain shield airbags
 - Help reduce impact to the heads of the occupants of the front and rear outer seats
 - Can help prevent the occupants from being thrown from the vehicle in the event of a vehicle rollover

Your vehicle is equipped with ADVANCED AIRBAGS designed based on US motor vehicle safety standards (FMVSS208). The airbag sensor assembly (ECU) controls airbag deployment based on information obtained from the sensors, etc., shown in the system components diagram above. This information includes crash severity and occupant information. As the airbags deploy, a chemical reaction in the inflators quickly fills the airbags with non-toxic gas to help restrain the motion of the occupants.

■ If the SRS airbags deploy (inflate)

- Slight abrasions, burns, bruising, etc., may be sustained from SRS airbags, due to the extremely high speed of deployment (inflation) by hot gases.
- A loud noise and white powder will be emitted.
- Parts of the airbag module (steering wheel hub, airbag cover and inflator) as well as the parts around the airbags may be hot for several minutes. The airbag itself may also be hot.
- The windshield may crack.
- All of the doors will be unlocked. (→P.120)
- The brakes and stop lights will be controlled automatically. (→P.432)
- The interior lights will turn on automatically. (→P.471)
- The emergency flashers will turn on automatically. (→P.568)
- Fuel supply to the engine will be stopped. (→P.575)

■ Emergency call (vehicles with Safety Connect)

- For Safety Connect subscribers, if any of the following situations occur, the system is designed to send an emergency call to the response center, notifying them of the vehicle's location (without needing to push the "SOS" button) and an agent will attempt to speak with the occupants to ascertain

the level of emergency and assistance required. If the occupants are unable to communicate, the agent automatically treats the call as an emergency and helps to dispatch the necessary emergency services. (→P.65)

- When an SRS airbag has been deployed
- When a seat belt pretensioner has operated
- When the vehicle has been involved in a severe rear-end collision

■ The SRS airbags deploy in a frontal impact when

- The following SRS airbags will deploy in the event of an impact that exceeds a threshold level (level of force corresponding to an approximately 12 - 18 mph [20 - 30 km/h] frontal collision with a fixed wall that does not move or deform):
 - SRS front airbags
 - SRS knee airbags
- The threshold level at which the SRS airbags will deploy will be higher than normal in the following situations:
 - When the vehicle collides with an object, such as a parked vehicle or sign pole, which moves or deforms on impact
 - If the vehicle is involved in an underride collision, such as a collision in which the front of the vehicle "underrides", or goes under, the bed of a truck
- Depending on the type of collision, only the following may deploy:

- Seat belt pretensioners
- The SRS airbags for the front passenger's seat will not deploy if there is no passenger in the front passenger seat. However, the SRS airbags for the front passenger's seat may deploy, even if the seat is unoccupied, if luggage is put on the seat.
- In the event of an especially severe frontal collision, the left and right SRS curtain shield airbags may also deploy.

■ The SRS airbags deploy in a side impact when

- The following SRS airbags will deploy in the event of an impact that exceeds the set threshold level (level of force corresponding to the impact force produced by an approximately 3300 lb. [1500 kg] vehicle colliding with the passenger compartment at a perpendicular angle at an approximate speed of 12 - 18 mph [20 - 30 km/h]):
- SRS side airbags
- SRS curtain shield airbags
- If the vehicle is involved in a rollover, the following SRS airbags will deploy:
- Both left and right SRS curtain shield airbags

■ The SRS airbags deploy in an underside impact when

- The following airbags may deploy if the underside of the vehicle collides with a hard object:
- SRS front airbags
- SRS knee airbags
- SRS side airbags
- SRS curtain shield airbags

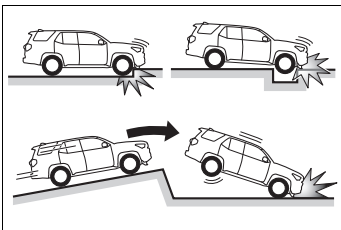

- The following airbags may deploy if the vehicle becomes significantly tilted or is strongly impacted by skidding into a curb, etc.:
- SRS curtain shield airbags

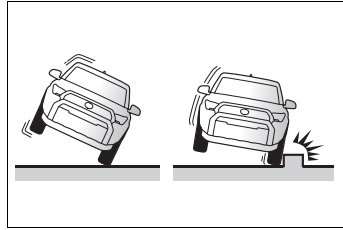

■ The SRS airbags will not deploy when

- The following SRS airbags will not normally deploy in side or rear collisions, vehicle rollovers, or low speed frontal collisions. However, if such a collision causes sufficient sudden deceleration, the SRS airbags may deploy.
- SRS front airbags
- SRS knee airbags

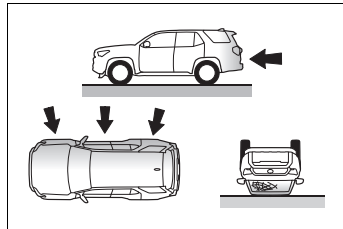

- The following SRS airbags may not deploy if the vehicle is collided with at a certain angle or in a side collision where an area of the vehicle other than the passenger compartment is collided with:
- SRS side airbags
- SRS curtain shield airbags

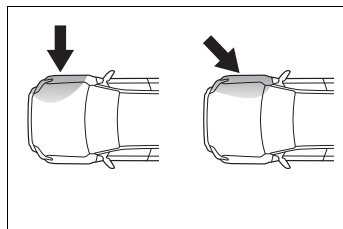

- The following SRS airbags will not

normally deploy in front or rear collisions, vehicle rollovers, or low speed side collisions:

- SRS side airbags

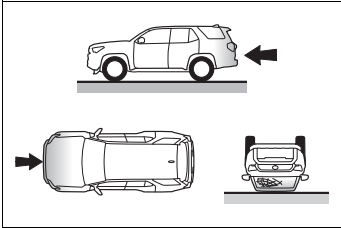

- The following SRS airbags will not normally deploy in rear collisions, end over end vehicle rollovers, or low speed front or side collisions:
- SRS curtain shield airbags

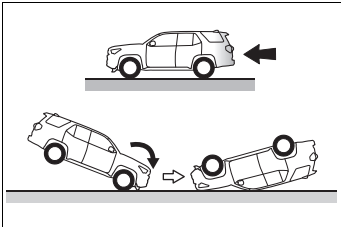

■ When to contact your Toyota dealer

In the following situations, the vehicle will require inspection and/or repair. Contact your Toyota dealer as soon as possible.

- When any of the SRS airbags have been deployed
- When the front of the vehicle is damaged or deformed, or was involved in a collision that was not severe enough to cause any of the following SRS airbags to deploy:
 - SRS front airbags
 - SRS knee airbags

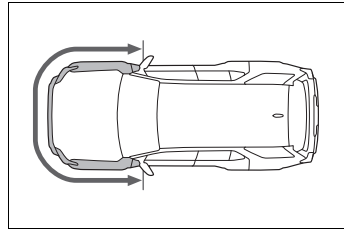

- When a door or its surrounding area is damaged, deformed or has had a hole made in it, or was involved in a collision that was not severe enough to cause any of the following SRS airbags to deploy:
 - SRS side airbags
 - SRS curtain shield airbags

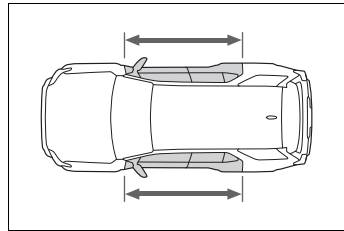

- When the pad section of the steering wheel, the dashboard near the front passenger SRS airbag or the lower side of the instrument panel is scratched, cracked, or otherwise damaged.
- When the surface of a seat with an SRS side airbag is scratched, cracked, or otherwise damaged.
- When the part of a front pillar, rear pillar or roof side rail garnish (padding) which covers a SRS curtain shield airbag is scratched, cracked, or otherwise damaged.

▲ WARNING

■ SRS airbag precautions

Observe the following precautions. Failure to do so may result in death or serious injury.

**WARNING**

- The driver and all passengers must wear their seat belts correctly. The SRS airbags are supplemental devices to be used with the seat belts.

- The SRS driver airbag deploys with considerable force, and can cause death or serious injury, especially if the driver is very close to the airbag. The National Highway Traffic Safety Administration (NHTSA) advises:

Since the risk zone for the driver's airbag is the first 2 - 3 in. (50 - 75 mm) of inflation, placing yourself 10 in. (250 mm) from your driver airbag provides you with a clear margin of safety. This distance is measured from the center of the steering wheel to your breastbone. If your current driving position places you less than 10 in. (250 mm) away from the driver airbag, you can change your driving position in several ways:

- Move your seat to the rear as far as possible while still being able to reach the pedals comfortably.
- Slightly recline the seatback. Although vehicle designs vary, many drivers can achieve the 10 in. (250 mm) distance, even with the driver seat all the way forward, simply by reclining the seatback somewhat. If reclining the seatback makes it hard to see the road, raise yourself by using a firm, non-slippery cushion, or raise the seat if your vehicle has that feature.

- If your steering wheel is adjustable, tilt it downward. This points the airbag toward your chest instead of your head and neck. The seat should be adjusted as recommended by the NHTSA, while still being able to control the vehicle with the pedals and steering wheel, and maintaining your view of the instrument panel controls.

- If a seat belt extender has been connected to a front seat belt buckle but the latch plate of the seat belt has not been fastened to the seat belt extender, the SRS airbag system will judge that the occupant is wearing the seat belt even though the seat belt has not been fastened. In this case, the SRS front airbags may not deploy correctly in a collision, resulting in death or serious injury. Be sure to wear the seat belt correctly when using a seat belt extender.

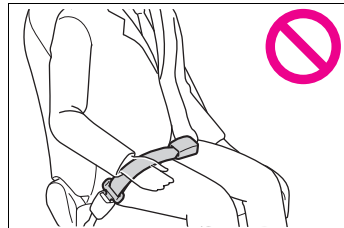

- The SRS front passenger airbag deploys with considerable force, and can cause death or serious injury, especially if the front passenger is very close to the airbag. The front passenger seat should be positioned as far possible from the airbag with the seatback adjusted so that the passenger is sat upright.

WARNING

- Improperly seated and/or restrained infants and children can be killed or seriously injured by a deploying airbag. An infant or child who is too small to use a seat belt should be properly secured using a child restraint system. Toyota strongly recommends that all infants and children be placed in the rear seats of the vehicle and properly restrained. The rear seats are safer for infants and children than the front passenger seat. (→P.51)

- Do not sit on the edge of the seat or lean against the dashboard.

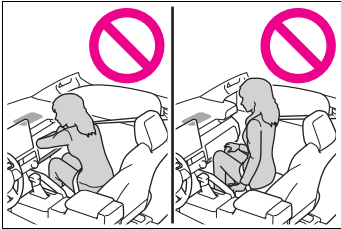

- Do not allow a child to stand in front of the SRS front passenger airbag or sit on the lap of a front passenger.

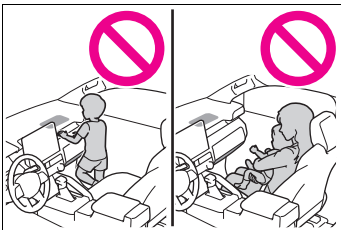

- Front seat occupants should never hold items on their lap.

- Do not lean against the door, roof side rail, or front, side, or rear pillar.



- Do not allow anyone to kneel on a seat toward the door or put their head or hands outside the vehicle.

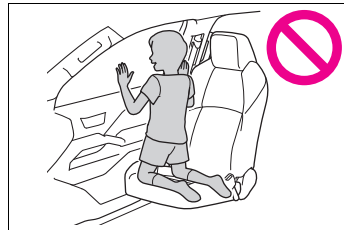

- Do not attach anything to or lean anything against areas such as the dashboard, steering wheel pad and lower portion of the instrument panel.

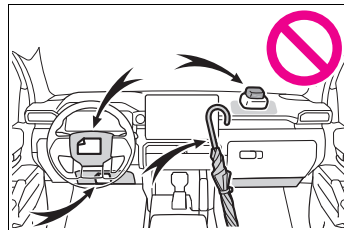

**WARNING**

- Do not attach anything to areas such as the doors, windshield, side windows, front or rear pillars, roof side rails and assist grips.

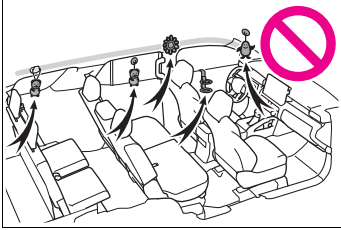

- Do not hang coat hangers or other hard objects on the coat hooks. These items could become projectiles if the SRS curtain shield airbags deploy, possibly leading to death or serious injury.
- If a vinyl cover is attached to the area where the SRS knee airbag deploys, be sure to remove it.
- Do not use seat accessories which cover the parts from which the SRS airbags deploy, as they may interfere with inflation of the SRS airbags. Such accessories may prevent the SRS airbags from deploying correctly, may disable the system or cause the SRS airbags to inflate unintentionally, possibly resulting in death or serious injury.
- Do not strike or apply significant force to the SRS airbag system components, front doors or their surrounding area. Doing so may cause the SRS airbags to malfunction.

- Do not touch any components of the SRS airbags immediately after the SRS airbags have deployed (inflated) as they may be hot.

- If breathing becomes difficult after the SRS airbags have deployed, open a door or window to allow fresh air in, or leave the vehicle if it is safe to do so. Wash off any residue as soon as possible to prevent skin irritation.

- If a part where an SRS airbag is stored is damaged or cracked, have it replaced by your Toyota dealer.

- Do not place anything, such as a cushion, on the front passenger's seat. Doing so will disperse the passenger's weight, which prevents the sensor from detecting the passenger's weight properly. As a result, the SRS front airbags for the front passenger's seat may not deploy in the event of a collision.

■ Modification and disposal of SRS airbag system components

Do not dispose of your vehicle or perform any of the following modifications without consulting your Toyota dealer. The SRS airbags may malfunction or deploy unintentionally, possibly leading to death or serious injury.

- Removal, installation, disassembly or repair of the SRS airbags
- Repair, removal or modification of the following parts or their surrounding
 - Steering wheel
 - Instrument panel

**WARNING**

- Dashboard
- Seats
- Seat upholstery
- Front pillars
- Side pillars
- Rear pillars
- Roof side rails
- Front door panels
- Front door trim
- Front door speakers
- Modifications to the front door panels (such as making holes in them)
- Repair or modification of the following parts or their surrounding
 - Front fender
 - Front bumper
 - Sides of the vehicle interior
- Installation of the following parts or accessories
 - Bull bars or kangaroo bars
 - Snow plows
 - Winches
- Modifications to the vehicle's suspension
- Installation of electronic devices such as mobile two-way radios (RF-transmitter) and CD players
- Modifications to your vehicle for a persons with a physical disability

Front passenger occupant classification system

Your vehicle is equipped with a front passenger occupant classification system. This system detects the conditions of the front passenger seat and activates or deactivates the following SRS airbags.

- SRS front passenger airbag
- SRS front passenger knee airbag

System components

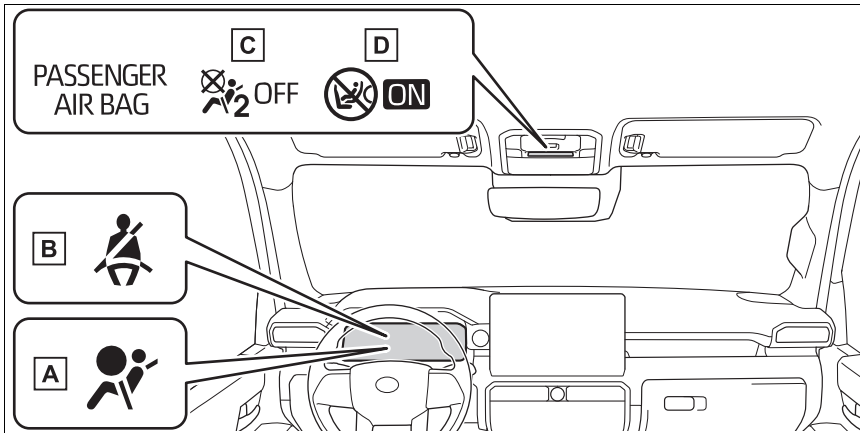

- A** SRS warning light
- B** Front passenger's seat belt reminder light
- C** "AIR BAG OFF" indicator light
- D** "AIR BAG ON" indicator light

Front passenger occupant classification system conditions and operation

■ Adult*¹

Indicators/warning lights	“AIR BAG ON” and “AIR BAG OFF” indicator lights	“AIR BAG ON”
	SRS warning light	Off
	Front passenger’s seat belt reminder light	Off* ² or flashing* ³
Devices	Front passenger airbag	Activated
	Front passenger knee airbag	

■ Child*⁴

Indicators/warning lights	“AIR BAG ON” and “AIR BAG OFF” indicator lights	“AIR BAG OFF” or “AIR BAG ON”* ⁴
	SRS warning light	Off
	Front passenger’s seat belt reminder light	Off* ² or flashing* ³
Devices	Front passenger airbag	Deactivated or activated* ⁴
	Front passenger knee airbag	

■ Child restraint system with infant*⁵

Indicators/warning lights	“AIR BAG ON” and “AIR BAG OFF” indicator lights	“AIR BAG OFF”* ⁶
	SRS warning light	Off
	Front passenger’s seat belt reminder light	Off* ² or flashing* ³
Devices	Front passenger airbag	Deactivated
	Front passenger knee airbag	

■ Unoccupied

Indicators/warning lights	“AIR BAG ON” and “AIR BAG OFF” indicator lights	“AIR BAG OFF”
	SRS warning light	Off
	Front passenger’s seat belt reminder light	
Devices	Front passenger airbag	Deactivated
	Front passenger knee airbag	

■ System malfunction

Indicators/warning lights	“AIR BAG ON” and “AIR BAG OFF” indicator lights	“AIR BAG OFF”
	SRS warning light	On
	Front passenger’s seat belt reminder light	
Devices	Front passenger airbag	Deactivated
	Front passenger knee airbag	

*1: The system judges a person of adult size as an adult. When a smaller adult sits in the front passenger seat, the system may not recognize them as an adult depending on their physique and posture.

*2: In the event the front passenger is wearing a seat belt

*3: In the event the front passenger does not wear a seat belt

*4: For some children, child in seat, child in booster seat or child in convertible seat, the system may not recognize them as a child. Factors which may affect this can be the physique or posture.

*5: Never install a rear-facing child restraint system on the front passenger seat. A forward-facing child restraint system should only be installed on the front passenger seat when it is unavoidable. (→P.51)

*6: In case the indicator light is not illuminated, consult this manual on how to install the child restraint system properly. (→P.53)

**WARNING****■ Front passenger occupant classification system precautions**

Observe the following precautions regarding the front passenger occupant classification system. Failure to do so may cause death or serious injury.

- Wear the seat belt properly.
- Make sure the front passenger's seat belt plate has not been left inserted into the buckle before someone sits in the front passenger seat.
- Make sure the "AIR BAG OFF" indicator light is not illuminated when using the seat belt extender for the front passenger seat. If the "AIR BAG OFF" indicator light is illuminated, disconnect the extender tongue from the seat belt buckle, and reconnect the seat belt. Reconnect the seat belt extender after making sure the "AIR BAG ON" indicator light is illuminated. If you use the seat belt extender while the "AIR BAG OFF" indicator light is illuminated, the SRS airbags for the front passenger will not activate, which could cause death or serious injury in the event of a collision.
- Do not apply a heavy load to the front passenger seat or equipment (e.g. seatback pocket).
- Do not put weight on the front passenger seat by putting your hands or feet on the front passenger seat seatback from the rear passenger seat.
- Do not let a rear passenger lift the front passenger seat with their feet or press on the seatback with their legs.

- Do not put objects under the front passenger seat.
- Do not recline the front passenger seatback so far that it touches a rear seat. This may cause the "AIR BAG OFF" indicator light to be illuminated, which indicates that the SRS airbags for the front passenger will not activate in the event of a severe accident. If the seatback touches the rear seat, return the seatback to a position where it does not touch the rear seat. Keep the front passenger seatback as upright as possible when the vehicle is moving. Reclining the seatback excessively may lessen the effectiveness of the seat belt system.
- If an adult sits in the front passenger seat, the "AIR BAG ON" indicator light is illuminated. If the "AIR BAG OFF" indicator is illuminated, ask the passenger to sit up straight, well back in the seat, feet on the floor, and with the seat belt worn correctly. If the "AIR BAG OFF" indicator still remains illuminated, either ask the passenger to move to the rear seat, or if that is not possible, move the front passenger seat fully rearward.
- When it is unavoidable to install a forward-facing child restraint system on the front passenger seat, install the child restraint system on the front passenger seat in the proper order. (→P.53)
- Do not modify or remove the front seats.

**WARNING**

- Do not kick the front passenger seat or subject it to severe impact. Otherwise, the SRS warning light may come on to indicate a malfunction of the front passenger occupant classification system. In this case, contact your Toyota dealer immediately.
- Child restraint systems installed on the rear seat should not contact the front seatbacks.
- Do not use a seat accessory, such as a cushion and seat cover, that covers the seat cushion surface.
- Do not modify or replace the upholstery of the front seat.

Exhaust gas precautions

Harmful substance to the human body is included in exhaust gases if inhaled.

**WARNING**

Exhaust gases contain harmful carbon monoxide (CO), which is colorless and odorless. Observe the following precautions. Failure to do so may cause exhaust gases to enter the vehicle and may lead to an accident caused by light-headedness, or may lead to death or a serious health hazard.

■ Important points while driving

- Keep the back door closed.
- If you smell exhaust gases in the vehicle even when the back door is closed, open the windows and have the vehicle inspected at your Toyota dealer as soon as possible.

■ When parking

- If the vehicle is in a poorly ventilated area or a closed area, such as a garage, stop the engine.
- Do not leave the vehicle with the engine running for a long time.
If such a situation cannot be avoided, park the vehicle in an open space and ensure that exhaust fumes do not enter the vehicle interior.

**WARNING**

- Do not leave the engine running in an area with snow build-up, or where it is snowing. If snow-banks build up around the vehicle while the engine is running, exhaust gases may collect and enter the vehicle.

■ Exhaust pipe

The exhaust system needs to be checked periodically. If there is a hole or crack caused by corrosion, damage to a joint or abnormal exhaust noise, be sure to have the vehicle inspected and repaired by your Toyota dealer.

Riding with children

Observe the following precautions when children are in the vehicle.

Use a child restraint system appropriate for the child, until the child becomes large enough to properly wear the vehicle's seat belt.

- It is recommended that children sit in the rear seats to avoid accidental contact with the shift lever, wiper switch, etc.
- Use the rear door child-protector lock or the window lock switch to avoid children opening the door while driving or operating the power window accidentally.
(→P.123, 179)
- Do not let small children operate equipment which may catch or pinch body parts, such as the power window, hood, back door, seats, etc.



WARNING

■ When children are in the vehicle

Never leave children unattended in the vehicle, and never allow children to have or use the key.

Children may be able to start the vehicle or shift the vehicle into neutral. There is also a danger that children may injure themselves by playing with the windows, the moon roof (if equipped) or other features of the vehicle. In addition, heat build-up or extremely cold temperatures inside the vehicle can be fatal to children.

Child restraint systems

Before installing a child restraint system in the vehicle, there are precautions that need to be observed, different types of child restraint systems, as well as installation methods, etc., written in this manual.

Use a child restraint system when riding with a small child that cannot properly use a seat belt. For the child's safety, install the child restraint system to a rear seat. Be sure to follow the installation method that is in the operation manual enclosed with the restraint system.

Table of contents

Points to remember: P.51

Child restraint system: P.53

When using a child restraint system: P.54

Child restraint system installation method

- Fixed with a seat belt: P.56
- Fixed with a child restraint LATCH anchor: P.60
- Using an anchor bracket (for top tether strap): P.63

Points to remember

The laws of all 50 states of the U.S.A. as well as Canada now require the use of child restraint systems.

- Prioritize and observe the warnings, as well as the laws and regulations for child restraint systems.
- Use a child restraint system until the child becomes large enough to properly wear the vehicle's seat belt.
- Choose a child restraint system that suits your vehicle and is appropriate to the age and size of the child.

WARNING

■ When a child is riding

Observe the following precautions.

Failure to do so may result in death or serious injury.

- For effective protection in automobile accidents and sudden stops, a child must be properly restrained, using a seat belt or child restraint system which is correctly installed. For installation details, refer to the operation manual enclosed with the child restraint system. General installation instruction is provided in this manual.

**WARNING**

- Toyota strongly urges the use of a proper child restraint system that conforms to the weight and size of the child, installed on the rear seat. According to accident statistics, the child is safer when properly restrained in the rear seat than in the front seat.
- Holding a child in your or someone else's arms is not a substitute for a child restraint system. In an accident, the child can be crushed against the windshield or between the holder and the interior of the vehicle.

■ Handling the child restraint system

If the child restraint system is not properly fixed in place, the child or other passengers may be seriously injured or even killed in the event of sudden braking, sudden swerving, or an accident.

- If the vehicle were to receive a strong impact from an accident, etc., it is possible that the child restraint system has damage that is not readily visible. In such cases, do not reuse the restraint system.
- Make sure you have complied with all installation instructions provided with the child restraint system manufacturer and that the system is properly secured.
- Keep the child restraint system properly secured on the seat even if it is not in use. Do not store the child restraint system unsecured in the passenger compartment.
- If it is necessary to detach the child restraint system, remove it from the vehicle or store it securely in the luggage compartment.

Child restraint system

■ Types of child restraint system installation methods

Confirm with the operation manual enclosed with the child restraint system about the installation of the child restraint system.

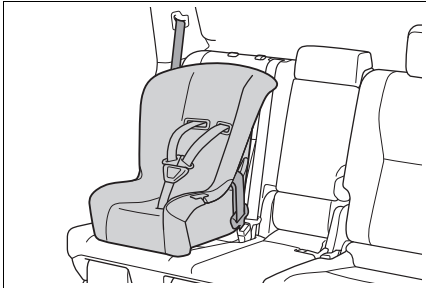
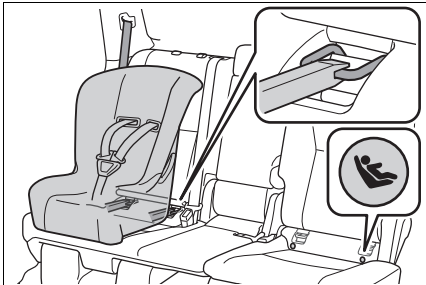
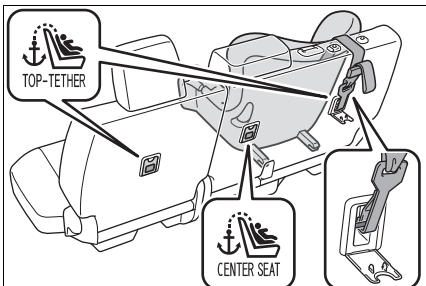
Installation method	Page
<p>Seat belt attachment</p>	 <p>P.56</p>
<p>Child restraint LATCH anchors attachment</p>	 <p>P.60</p>
<p>Anchor brackets (for top tether strap) attachment</p>	 <p>P.63</p>

When using a child restraint system

■ When installing a child restraint system to a front passenger seat

For the safety of a child, install child restraint systems to a rear seats. When installing child restraint system to a front passenger seat is unavoidable, adjust the seat as follows and install the child restraint system.

- Move the front seat fully rearward. If the passenger seat height can be adjusted, move it to the upper most position.
- Adjust the seatback angle to the most upright position.

When installing a forward-facing child seat, if there is a gap between the child seat and the seatback, adjust the seatback angle until good contact is achieved.

- If the head restraint interferes with the child restraint system installation and the head restraint can be removed, remove the head restraint. Otherwise, put the head restraint in the upper most position.

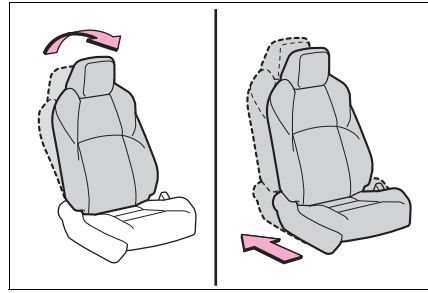

⚠ WARNING

■ When using a child restraint system

Observe the following precautions. Failure to do so may result in death or serious injury.

- Never install a rear-facing child restraint system on the front passenger seat even if the “AIR BAG OFF” indicator light is illuminated. In the event of an accident, the force of the rapid inflation of the front passenger airbag can cause death or serious injury to the child if the rear-facing child restraint system is installed on the front passenger seat.
- A forward-facing child restraint system may be installed on the front passenger seat only when it is unavoidable. A child restraint system that requires a top tether strap should not be used in the front passenger seat since there is no top tether strap anchor for the front passenger seat.

WARNING

- A forward-facing child restraint system may be installed on the front passenger seat only when it is unavoidable. When installing a forward-facing child restraint system on the front passenger seat, adjust the seat-back angle to the most upright position, move the seat to the rearmost position, and raise the seat to the upper most position, even if the "AIR BAG OFF" indicator light is illuminated. If the head restraint interferes with the child restraint system installation and the head restraint can be removed, remove the head restraint. If the head restraint cannot be removed, raise it to the uppermost position.



- Do not allow the child to lean his/her head or any part of his/her body against the door or the area of the seat, front or rear pillars, or roof side rails from which the SRS side airbags or SRS curtain shield airbags deploy even if the child is seated in the child restraint system. It is dangerous if the SRS side and curtain shield airbags inflate, and the impact could cause death or serious injury to the child.



- When a booster seat is installed, always ensure that the shoulder belt is positioned across the center of the child's shoulder. The belt should be kept away from the child's neck, but not so that it could fall off the child's shoulder.
- Use child restraint system suitable to the age and size of the child and install it to the rear seat.
- If the driver's seat interferes with the child restraint system and prevents it from being attached correctly, attach the child restraint system to the right-hand second seat.

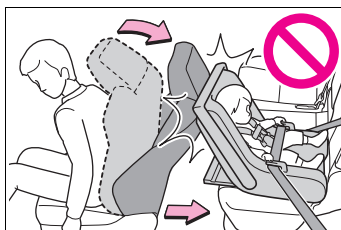

**WARNING**

- Adjust the front passenger seat so that it does not interfere with the child restraint system.
- When installing a child restraint system on the second center seat, align both seatbacks at the same angle. The seatbacks must be adjusted to the same angle. Otherwise, the child restraint system cannot be securely restrained and this may cause death or serious injuries in the event of sudden braking, sudden swerving or an accident.
- Child restraint system installed on the third seat (if equipped) should not contact the second seatbacks.

Child restraint system fixed with a seat belt

A child restraint system for a small child or baby must itself be properly restrained on the seat with the lap portion of the lap/shoulder belt.

■ Installing child restraint system using a seat belt (child restraint lock function belt)

Install the child restraint system in accordance to the operation manual enclosed with the child restraint system.

■ Rear-facing — Infant seat/convertible seat

1 Adjust the rear seat.

If there is a gap between the child restraint system and the seatback,

adjust the seatback angle until good contact is achieved.

2 Place the child restraint system on the rear seat facing the rear of the vehicle.

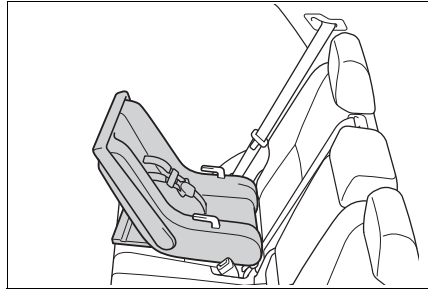

3 Run the seat belt through the child restraint system and insert the plate into the buckle. Make sure that the belt is not twisted.

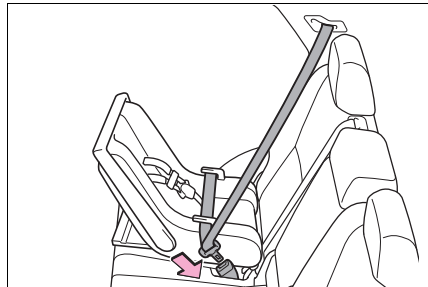

4 Fully extend the shoulder belt and allow it to retract to put it in lock mode. In lock mode, the belt cannot be extended.

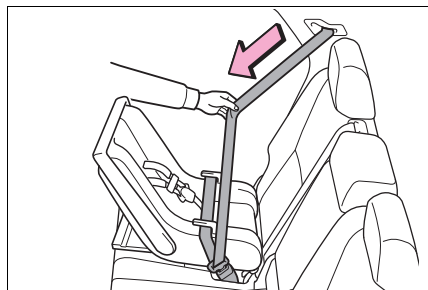

- 5 While pushing the child restraint system down into the rear seat, allow the shoulder belt to retract until the child restraint system is securely in place.

After the shoulder belt has retracted to a point where there is no slack in the belt, pull the belt to check that it cannot be extended.

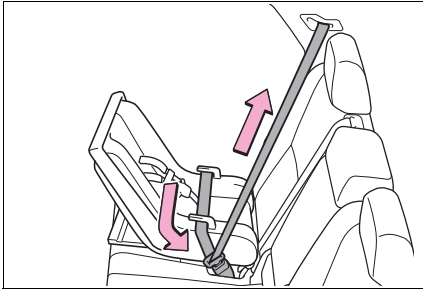

- 6 After installing the child restraint system, rock it back and forth to ensure that it is installed securely. (→P.59)

■ Forward-facing — Convertible seat

- 1 Adjust the seat.

When using the front passenger seat: If installing the child restraint system to the front passenger seat is unavoidable, refer to P.54 for front passenger seat adjustment.

When using the rear seat: If there is a gap between the child restraint system and the seatback, adjust the seatback angle until good contact is achieved.

- 2 If the head restraint interferes with the child restraint system installation and the head restraint can be removed,

remove the head restraint. (→P.158)

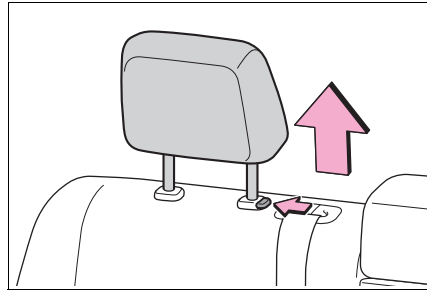

- 3 Place the child restraint system on the seat facing the front of the vehicle.

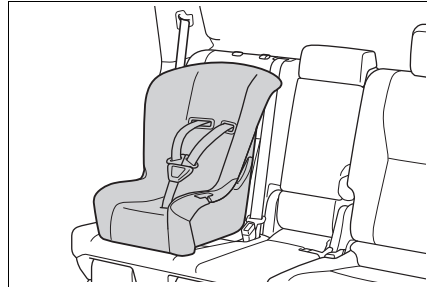

- 4 Run the seat belt through the child restraint system and insert the plate into the buckle. Make sure that the belt is not twisted.

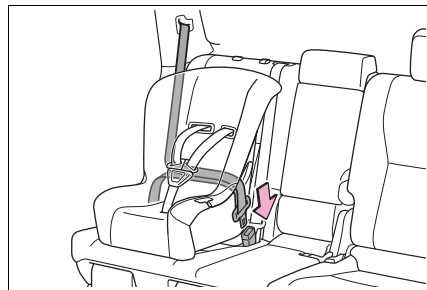

- 5 Fully extend the shoulder belt and allow it to retract to put it

in lock mode. In lock mode, the belt cannot be extended.

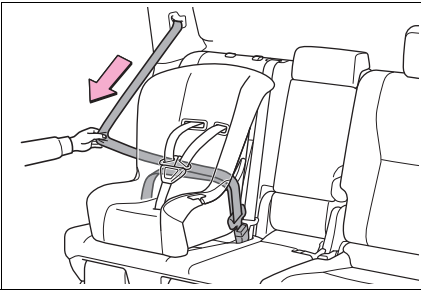

- 6 While pushing the child restraint system into the rear seat, allow the shoulder belt to retract until the child restraint system is securely in place.

After the shoulder belt has retracted to a point where there is no slack in the belt, pull the belt to check that it cannot be extended.

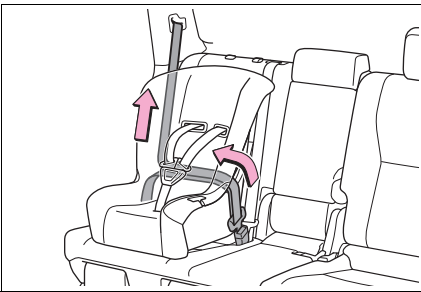

- 7 If the child restraint has a top tether strap, follow the child restraint manufacturer's operation manual regarding the installation, using the top tether strap to latch onto the top tether strap anchor. (→P.63)
- 8 After installing the child restraint system, rock it back

and forth to ensure that it is installed securely. (→P.59)

■ Booster seat

- 1 If installing the child restraint system to the front passenger seat is unavoidable, refer to P.54 for front passenger seat adjustment.
- 2 High back type: If the head restraint interferes with your child restraint system, and the head restraint can be removed, remove the head restraint. (→P.158)

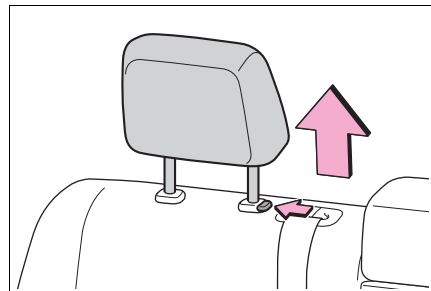

- 3 Place the child restraint system on the seat facing the front of the vehicle.

▶ Booster type

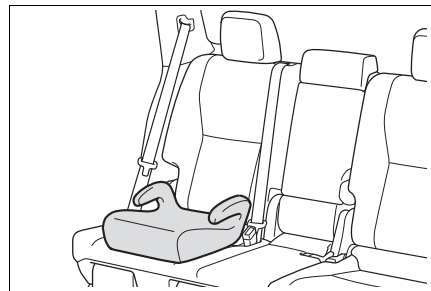

► High back type

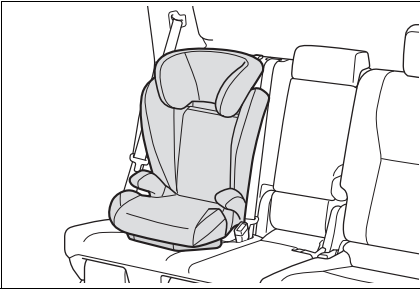

- 4** Sit the child in the child restraint system. Fit the seat belt to the child restraint system according to the manufacturer's instructions and insert the plate into the buckle. Make sure that the belt is not twisted.

Check that the shoulder belt is correctly positioned over the child's shoulder and that the lap belt is as low as possible. (→P.31)

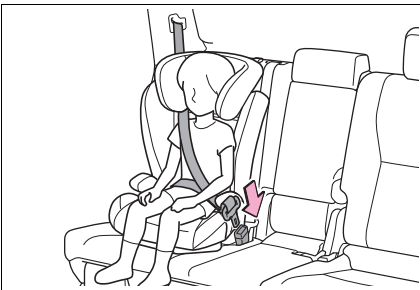

■ **Removing a child restraint system installed with a seat belt**

Press the buckle release button and fully retract the seat belt.

When releasing the buckle, the child restraint system may spring up due to the rebound of the seat cushion. Release the buckle while holding down the child restraint

system.

Since the seat belt automatically reels itself, slowly return it to the stowing position.

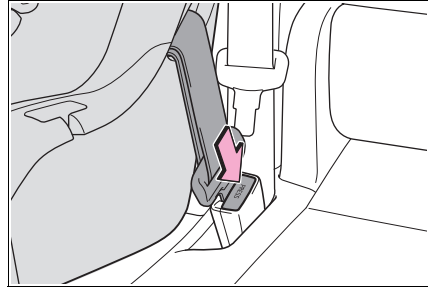

⚠ WARNING

■ **When installing a child restraint system**

Observe the following precautions.

Failure to do so may result in death or serious injury.

- Do not allow children to play with the seat belt. If the seat belt becomes twisted around a child's neck, it may lead to choking or other serious injuries that could result in death. If this occurs and the buckle cannot be unfastened, scissors should be used to cut the belt.
- Ensure that the belt and plate are securely locked and the seat belt is not twisted.
- Shake the child restraint system left and right, and forward and backward to ensure that it has been securely installed.
- After securing a child restraint system, never adjust the seat.

**WARNING**

- When a booster seat is installed, always ensure that the shoulder belt is positioned across the center of the child's shoulder. The belt should be kept away from the child's neck, but not so that it could fall off the child's shoulder.
- Follow all installation instructions provided by the child restraint system manufacturer.
- When securing some types of child restraint systems in rear seats, it may not be possible to properly use the seat belts in positions next to the child restraint without interfering with it or affecting seat belt effectiveness. Be sure your seat belt fits snugly across your shoulder and low on your hips. If it does not, or if it interferes with the child restraint, move to a different position. Failure to do so may result in death or serious injury.
- When installing a child restraint system on the second row center seat, adjust both seatbacks at the same angle. Otherwise, the child restraint system cannot be securely restrained and this may cause death or serious injuries in the event of sudden braking, sudden swerving or an accident.

■ **When installing a booster seat**

To prevent the belt from going into ALR lock mode, do not fully extend the shoulder belt. ALR mode causes the belt to tighten only. This could cause injury or discomfort to the child. (→P.33)

■ **Do not use a seat belt extender**

If a seat belt extender is used when installing a child restraint system, the seat belt will not securely hold the child restraint system, which could cause death or serious injury to the child or other passengers in the event of sudden braking, sudden swerving or an accident.

Child restraint system fixed with a child restraint LATCH anchor

■ **Child restraint LATCH anchors**

LATCH anchors are provided for the second outboard seats. (Buttons displaying the location of the anchorages are attached to the seats.)

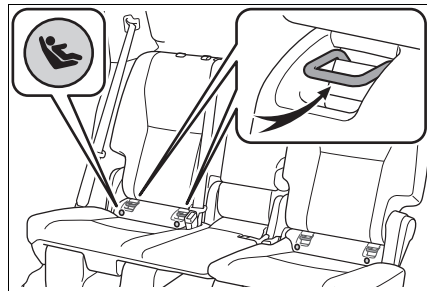

■ **When installing in the second outboard seats**

Install the child restraint system in accordance to the operation manual enclosed with the child restraint system.

- 1 Adjust the seatback angle to the most upright position. When installing a forward-

facing child seat, if there is a gap between the child seat and the seatback, adjust the seatback angle until good contact is achieved.

- 2 If the head restraint interferes with the child restraint system installation and the head restraint can be removed, remove the head restraint. Otherwise, put the head restraint in the upper most position. (→P.158)

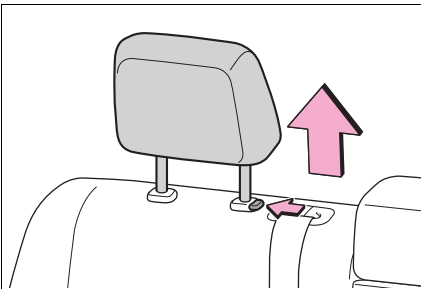

- 3 Open the cover.

Put the cover between the seat cushion and seatback.

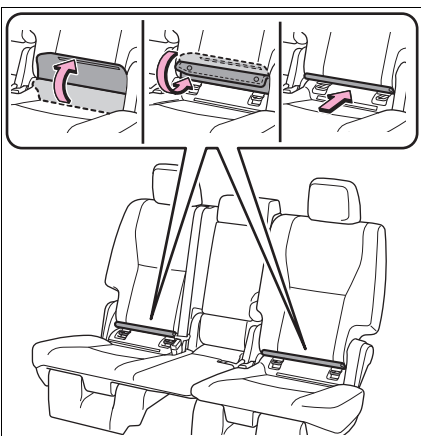

- ▶ With flexible lower attachments
- 4 Latch the hooks of the lower attachments onto the LATCH anchors.

For owners in Canada:
The symbol on a child restraint system indicates **A** the presence of a lower connector system.

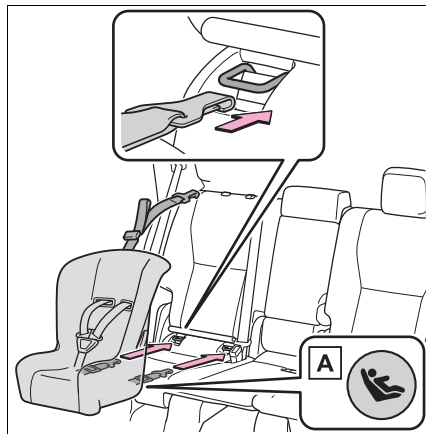

A Canada only

- ▶ With rigid lower attachments
- 4 Latch the buckles onto the LATCH anchors.

For owners in Canada:
The symbol on a child restraint system indicates **A** the presence of a

lower connector system.

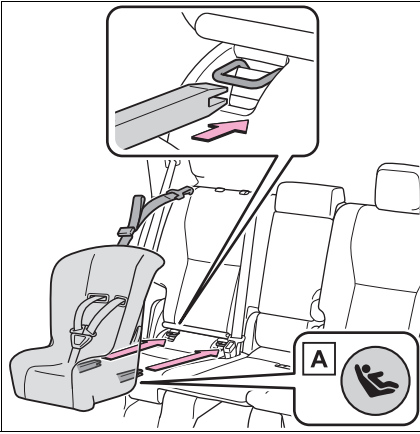

A Canada only

- 5 If the child restraint has a top tether strap, follow the child restraint manufacturer's operation manual regarding the installation, using the top tether strap to latch onto the top tether strap anchor. (→P.63)
- 6 After installing the child restraint system, rock it back and forth to ensure that it is installed securely. (→P.59)

■ Laws and regulations pertaining to anchors

The LATCH system conforms to FMVSS225 or CMVSS210.2.

Child restraint systems conforming to FMVSS213 or CMVSS213 specifications can be used.

This vehicle is designed to conform to SAE J1819.

⚠ WARNING

■ When installing a child restraint system

Observe the following precautions.

Failure to do so may result in death or serious injury.

- When using the LATCH anchors, be sure that there are no foreign objects around the anchors and that the seat belt is not caught behind the child restraint system.
- Follow all installation instructions provided by the child restraint system manufacturer.
- Child restraint systems cannot be installed in the second center seat. Do not install the child restraint system in the second center seat using the LATCH anchors.
- When securing some types of child restraint systems in rear seats, it may not be possible to properly use the seat belts in positions next to the child restraint without interfering with it or affecting seat belt effectiveness. Be sure your seat belt fits snugly across your shoulder and low on your hips. If it does not, or if it interferes with the child restraint, move to a different position. Failure to do so may result in death or serious injury.
- If the seat is adjusted, reconfirm the security of the child restraint system.

Using an anchor bracket (for top tether strap)

■ Anchor brackets (for top tether strap)

Anchor brackets are provided for each second seat.

Use anchor brackets when fixing the top tether strap.

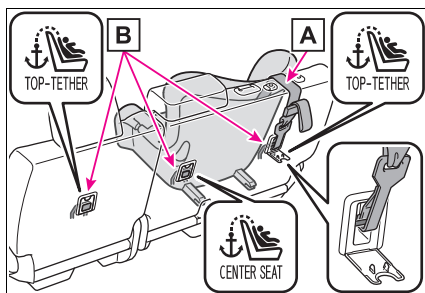

A Top tether strap

B Anchor brackets

■ Fixing the top tether strap to the anchor bracket

Install the child restraint system in accordance to the operation manual enclosed with the child restraint system.

- 1 Adjust the head restraint to the upmost position.

If the head restraint interferes with the child restraint system or top strap installation and the head restraint can be removed, remove

the head restraint. (→P.158)

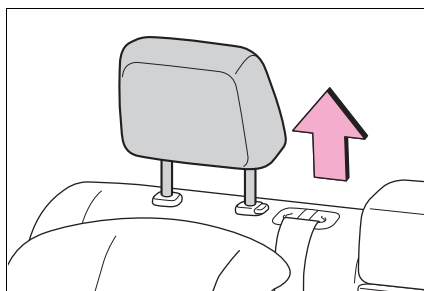

- 2 Open the anchor bracket cover, latch the hook onto the anchor bracket and tighten the top tether strap.

Make sure the top tether strap is securely latched. (→P.59)

When installing the child restraint system with the head restraint being raised, be sure to have the top tether strap pass underneath the head restraint.

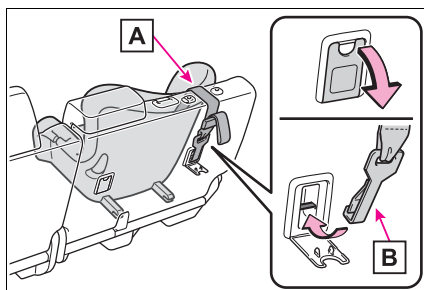

A Top tether strap

B Hook

■ Laws and regulations pertaining to anchors

The LATCH system conforms to FMVSS225 or CMVSS210.2. Child restraint systems conforming to FMVSS213 or CMVSS213 specifications can be used. This vehicle is designed to conform to SAE J1819.

**WARNING****■ When installing a child restraint system**

Observe the following precautions.

Failure to do so may result in death or serious injury.

- Firmly attach the top tether strap and make sure that the belt is not twisted.
- Do not attach the top tether strap to anything other than the anchor bracket.
- Follow all installation instructions provided by the child restraint system manufacturer.
- When installing the child restraint system with the head restraint being raised, after the head restraint has been raised and then the anchor bracket has been fixed, do not lower the head restraint.
- If the seat is adjusted, reconfirm the security of the child restraint system.

**NOTICE****■ Anchor brackets (for top tether strap)**

When not in use, make certain to close the cover. If it remains open, the lid may be damaged.

Safety Connect*

*: If equipped

Safety Connect is a subscription-based telematics service that uses Global Positioning System (GPS) data and embedded cellular technology to provide safety and security features to subscribers. Safety Connect is supported by Toyota's designated response center, which operates 24 hours per day, 7 days per week.

Safety Connect service is available by subscription on select, telematics hardware-equipped vehicles.

By using the Safety Connect service, you are agreeing to be bound by the Telematics Subscription Service Agreement and its Terms and Conditions, as in effect and amended from time to time, a current copy of which is available at Toyota.com. All use of the Safety Connect service is subject to such then-applicable Terms and Conditions.

System components

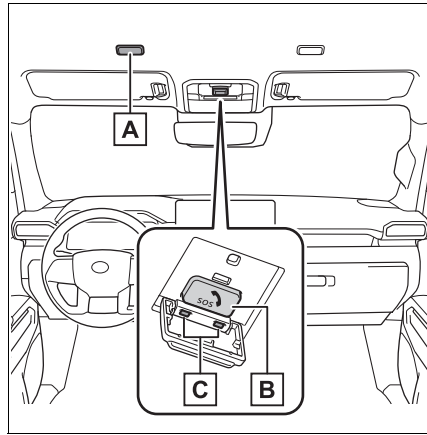

- A** Microphone
- B** "SOS" button
- C** LED light indicators

■ Certification

→P.686

Services

Subscribers have the following Safety Connect services available:

- Automatic Collision Notification*

Helps drivers receive necessary response from emergency service providers. (→P.67)

*: U.S. Patent No. 7,508,298 B2

- Stolen Vehicle Location

Helps drivers in the event of vehicle theft. (→P.67)

- Emergency Assistance Button ("SOS")

Connects drivers to response-center support. (→P.67)

- **Enhanced Roadside Assistance**

Provides drivers various on-road assistance. (→P.67)

Subscription

After you have signed the Telematics Subscription Service Agreement and are enrolled, you can begin receiving services.

A variety of subscription terms is available for purchase. Contact your Toyota dealer, call the following or push the “SOS” button in your vehicle for further subscription details.

- **The United States**

1-800-331-4331

- **Canada**

1-888-869-6828

- **Puerto Rico**

1-877-855-8377

■ Safety Connect Services Information

- Phone calls using the vehicles Bluetooth® technology will not be possible during Safety Connect.
- Safety Connect is available beginning Fall 2009 on select Toyota models (in the contiguous United States only). Contact with the Safety Connect response center is dependent upon the telematics device being in operative condition, cellular connection availability, and GPS satellite signal

reception, which can limit the ability to reach the response center or receive emergency service support. Enrollment and Telematics Subscription Service Agreement required. A variety of subscription terms is available; charges vary by subscription term selected and location.

- Automatic Collision Notification, Emergency Assistance and Stolen Vehicle Location will function in the United States, including Hawaii and Alaska, Puerto Rico and in Canada, and Enhanced Roadside Assistance will function in the United States, Puerto Rico and in Canada.

- Automatic Collision Notification, Emergency Assistance, Stolen Vehicle and Enhanced Road Assistance will not function in the United States Virgin Islands. For vehicles first sold in the USVI, no Safety Connect services will function in and outside the United States Virgin Islands.

- Safety Connect services are not subject to section 255 of the Telecommunications Act and the device is not TTY compatible.

■ Languages

The Safety Connect response center will offer support in multiple languages. The Safety Connect system will offer voice prompts in English, Spanish, and French. Please indicate your language of choice when enrolling.

■ When contacting the response center

You may be unable to contact the response center if the network is busy.

Safety Connect LED light Indicators

When the engine switch is turned to ON, the red indicator light comes on for 2 seconds then turns off. Afterward, the green indicator light comes on, indicating that the service is active.

The following indicator light patterns indicate specific system usage conditions:

■ Green

- After “IGNITION ON”, the Green and Red LED are repeatedly flashing
- Only the Green LED is illuminated when the operation is normally ready

■ Red

- After “IGNITION ON”, the Green and Red LED are repeatedly flashing
- Turns off when the system is operating normally
- Illuminates when the mobile phone battery needs to be replaced.
- Illuminates in diagnostic mode to indicate a DTC
- Illuminates in diagnostic mode to indicate a specific vehicle history (RoB).

Safety Connect services

■ Automatic Collision Notification

In case of either airbag deployment or severe rear-end collision, the system is designed to automatically call the response center. The responding agent receives the vehicle’s location and attempts to speak with the vehicle occupants to assess the level of emergency. If the occupants are unable to communicate, the agent automatically treats the call as an emergency, contacts the nearest emergency services provider to describe the situation, and requests that assistance be sent to the location.

■ Stolen Vehicle Location

If your vehicle is stolen, Safety Connect can work with local authorities to assist them in locating and recovering the vehicle. After filing a police report, call the Safety Connect response center at 1-800-331-4331 in the United States, 1-877-855-8377 in Puerto Rico or 1-888-869-6828 in Canada, and follow the prompts for Safety Connect to initiate this service.

In addition to assisting law enforcement with recovery of a stolen vehicle, Safety-Connect-equipped vehicle location data may, under certain circum-

stances, be shared with third parties to locate your vehicle. Further information is available at Toyota.com.

■ **Emergency Assistance Button (“SOS”)**

In the event of an emergency on the road, push the “SOS” button to reach the Safety Connect response center. The answering agent will determine your vehicle’s location, assess the emergency, and dispatch the necessary assistance required.

If you accidentally press the “SOS” button, tell the response-center agent that you are not experiencing an emergency.

■ **Enhanced Roadside Assistance**

Enhanced Roadside Assistance adds GPS data to the already included warranty-based Toyota roadside service.

Subscribers can press the “SOS” button to reach a Safety Connect response-center agent, who can help with a wide range of needs, such as: towing, flat tire, fuel delivery, etc. For a description of the Roadside Assistance services and their limitations, please see the Safety Connect Terms and Conditions, which are available at Toyota.com.

Safety information for Safety Connect

Important! Read this information about exposure to radio frequency signals before using Safety Connect;

The Safety Connect system installed in your vehicle is a low-power radio transmitter and receiver. It receives and also sends out radio frequency (RF) signals.

In August 1996, the Federal Communications Commission (FCC) adopted RF exposure guidelines with safety levels for mobile wireless phones. Those guidelines are consistent with the safety standards previously set by the following U.S. and international standards bodies.

- ANSI (American National Standards Institute) C95.1 [1992]
- NCRP (National Council on Radiation Protection and Measurement) Report 86 [1986]
- ICNIRP (International Commission on Non-Ionizing Radiation Protection) [1996]

Those standards were based on comprehensive and periodic evaluations of the relevant scientific literature. Over 120 scientists, engineers, and physicians from universities, and govern-

ment health agencies and industries reviewed the available body of research to develop the ANSI Standard (C95.1).

The design of Safety Connect complies with the FCC guidelines in addition to those standards.

■ Free /Open Source Software Information

This product contains Free/Open Source Software (FOSS). The License information and/or the source code of such FOSS can be found at the following

<https://opensource.lge.com/osSch/list?type=ALL&search=TL21BNU>

Engine immobilizer system

The vehicle's keys have built-in transponder chips that prevent the engine from starting if a key has not been previously registered in the vehicle's on-board computer.

Never leave the keys inside the vehicle when you leave the vehicle.

This system is designed to help prevent vehicle theft but does not guarantee absolute security against all vehicle thefts.

Operating the system

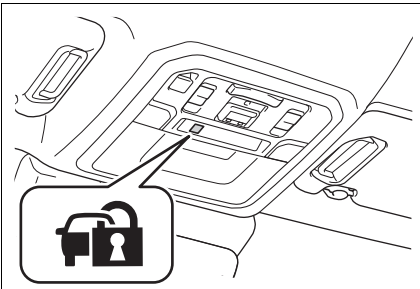

The indicator light flashes after the engine switch has been turned off to indicate that the system is operating.

The indicator light stops flashing after the engine switch has been turned to ACC or ON to indicate that the system has been canceled.

■ System maintenance

The vehicle has a maintenance-free type engine immobilizer system.

■ Conditions that may cause the system to malfunction

- If the grip portion of the key is in contact with a metallic object
- If the key is in close proximity to or touching a key to the security system (key with a built-in transponder chip) of another vehicle

■ Certification

→P.687



NOTICE

■ To ensure the system operates correctly

Do not modify or remove the system. If modified or removed, the proper operation of the system cannot be guaranteed.

Alarm

The alarm uses light and sound to give an alert when an intrusion is detected. The alarm is triggered in the following situations when the alarm is set:

- A locked door or back door is unlocked or opened in any way other than using the entry function or wireless remote control. (The doors will lock again automatically.)
- The hood is opened.

Setting/deactivating/stopping the alarm system

■ Items to check before locking the vehicle

To prevent unexpected triggering of the alarm and vehicle theft, make sure of the following:

- Nobody is in the vehicle.
- The windows and the moon roof (if equipped) are closed before the alarm is set.
- No valuables or other personal items are left in the vehicle.

■ Setting

Close the doors, back door and hood, and lock all the doors. The system will be set automatically after 30 seconds.

The indicator light changes from being on to flashing when the system is set.

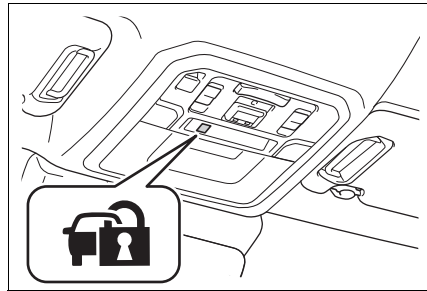

■ Deactivating or stopping

Do one of the following to deactivate or stop the alarms:

- Unlock the doors.
- Turn the engine switch to ACC or ON, or start the engine. (The alarm will be deactivated or stopped after a few seconds.)

■ Setting the alarm

The alarm can be set if all the doors are closed even with the hood open.

■ System maintenance

The vehicle has a maintenance-free type alarm system.

■ Triggering of the alarm

The alarm may be triggered in the following situations: (Stopping the alarm deactivates the alarm system.)

- The doors are unlocked using the mechanical key.

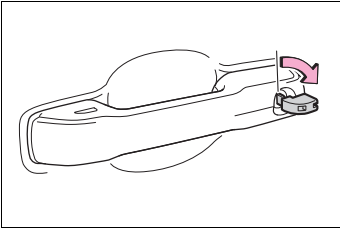

- A person inside the vehicle opens a door, back door or hood, or unlocks the vehicle.



- The battery is recharged or replaced when the vehicle is locked. (→P.609)

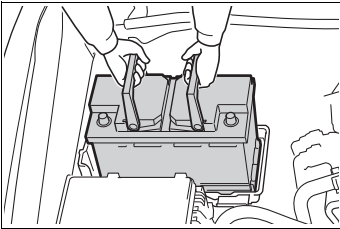

■ Alarm-operated door lock

In the following cases, depending on the situation, the door may automatically lock to prevent improper entry into the vehicle:

- When a person remaining in the vehicle unlocks the door and the alarm is activated.
- While the alarm is activated, a person remaining in the vehicle unlocks the door.
- When recharging or replacing the battery.

■ Customization

Some functions can be customized. (→P.637)



NOTICE

■ To ensure the system operates correctly

Do not modify or remove the system. If modified or removed, the proper operation of the system cannot be guaranteed.

Pre-alarm

If a door is unlocked with the mechanical key while the alarm is being set, the pre-alarm will sound for 10 seconds.

If either the door is locked again or the pre-alarm is stopped within those 10 seconds, an alarm will sound.

Do any of the following in order to deactivate or stop the pre-alarm:

- Close the doors, and lock all doors by smart key system or wireless remote control.
- Turn the engine switch to ACC or ON, or start the engine (The alarm will be deactivated and stop after a few seconds.)

Vehicle status information and indicators

2

2-1. Instrument cluster

Warning lights and indicators	74
Gauges and meters (7-inch display).....	81
Gauges and meters (12.3-inch display)	85
Multi-information display (7-inch display)	91
Multi-information display (12.3-inch display).....	100
Fuel consumption information	110

Warning lights and indicators

The warning lights and indicators on the instrument cluster, overhead console and outside rear view mirrors inform the driver of the status of the vehicle's various systems.

Instrument cluster

For the purpose of explanation, the following illustrations display all warning lights and indicators illuminated.

■ Vehicles with 7-inch display

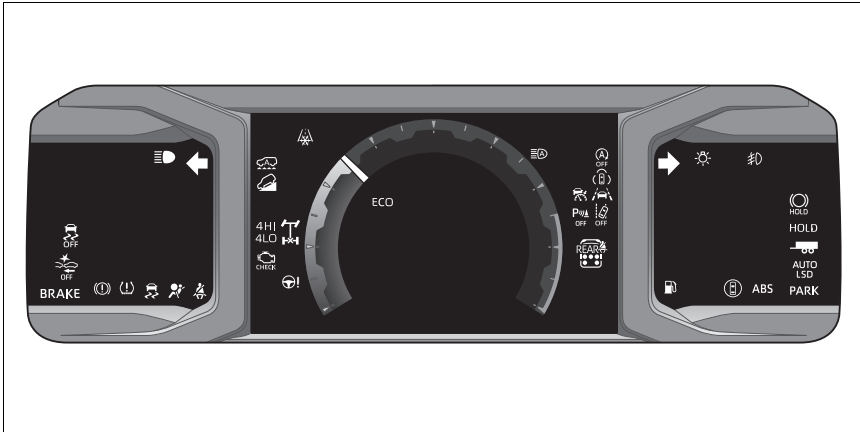

The units used on the meters and some indicators may differ depending on the target region.

■ Vehicles with 12.3-inch display

The meter type can be changed on “⚙ Settings” of the multi-information display. (→P.108)

▶ Type 1

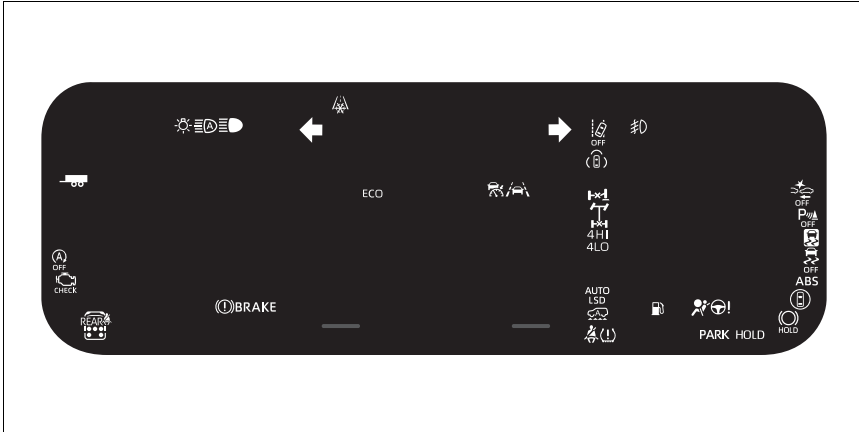

The units used on the meters and some indicators may differ depending on the target region.

▶ Type 2

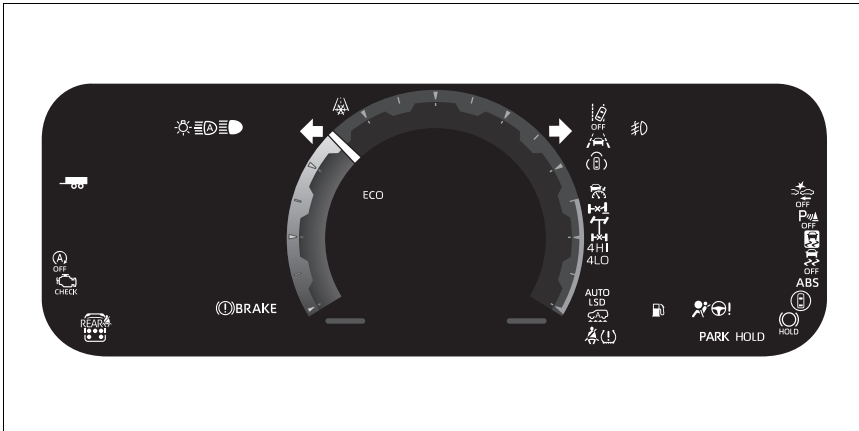

The units used on the meters and some indicators may differ depending on the target region.

► Type 3

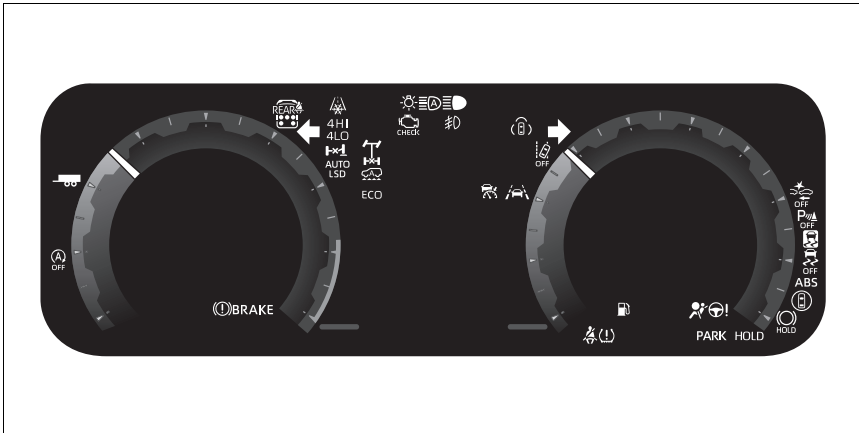

The units used on the meters and some indicators may differ depending on the target region.

Warning lights

Warning lights inform the driver of malfunctions in the indicated vehicle's systems.



Brake system warning light*¹ (→P.576)



(Canada)
(Red)

Brake system warning light*¹ (→P.576)



(Yellow)

Brake system warning light*¹ (→P.576)



High coolant temperature warning light*² (→P.576)



Charging system warning light*² (→P.577)



Low engine oil pressure warning light*² (→P.577)



(U.S.A.)

Malfunction indicator lamp*¹ (→P.577)



(Canada)

Malfunction indicator lamp*¹ (→P.577)



SRS warning light*¹ (→P.577)



(U.S.A.)

ABS warning light*¹ (→P.578)



(Canada)

ABS warning light*¹ (→P.578)















(Red)











Electric power steering system warning light*¹ (→P.578)



(Yellow)

Electric power steering system warning light*¹ (→P.578)

-  PCS warning light*¹
(→P.578)
-  LDA indicator
(→P.578)
(Yellow)
-  LTA indicator
(→P.579)
(Yellow)
-  Driving assist information indicator*¹
(→P.579)
-  PDA indicator
(→P.579)
(Yellow)
-  Dynamic radar cruise control indicator
(→P.579)
(Yellow)
-  Cruise control indicator
(→P.580)
(Yellow)
-  Stop & Start cancel indicator*¹ (if equipped)
(→P.580)
(Flashes)
-  Intuitive parking assist OFF indicator*¹ (if equipped)
(→P.580)
(Flashes)
-  Slip indicator light*¹
(→P.580)
-  Inappropriate pedal operation warning light*² (→P.581)
-  Brake hold operated indicator*¹ (→P.581)
(Flashes)
-  Parking brake indicator
(U.S.A.)
(Flashes)

-  Parking brake indicator (→P.581)
(Canada)
(Flashes)
-  Center differential lock indicator (if equipped)
(→P.581)
(Flashes)
-  Rear differential lock indicator (if equipped)
(→P.582)
(Flashes)
-  High speed four-wheel drive indicator (if equipped)
(→P.582)
(Yellow)
-  Low speed four-wheel drive indicator (if equipped)
(→P.582)
(Flashes)
-  Tire pressure warning light*¹ (→P.582)
-  Low fuel level warning light (→P.583)
-  Driver's and front passenger's seat belt reminder light
(→P.583)
-  Rear passengers' seat belt reminder lights
(→P.583)
-  Trailer brake warning light (if equipped)
(→P.584)

*¹: These lights come on when the engine switch is turned to ON to indicate that a system check is being performed. They will turn off after the engine is started, or after a few seconds. There may be a malfunction in a system if the lights do not come on, or turn off. Have the vehicle inspected by your Toyota dealer.

*²: This light illuminates on the multi-information display with a

message.



WARNING

■ If a safety system warning light does not come on

Should a safety system light such as the ABS and SRS warning light not come on when you start the engine, this could mean that these systems are not available to help protect you in an accident, which could result in death or serious injury. Have the vehicle inspected by your Toyota dealer immediately if this occurs.

Indicators

The indicators inform the driver of the operating state of the vehicle's various systems.



Turn signal indicator
(→P.226)



(U.S.A.)

Headlight indicator
(→P.234)



(Canada)

Tail light indicator
(→P.234)



Headlight high beam indicator
(→P.236)



AHB indicator (→P.238)



Front fog light indicator
(→P.237)



PCS warning light^{*1, 2}
(→P.259)



(*3)

Dynamic radar cruise control indicator
(→P.290)



(*3)

Cruise control indicator
(→P.301)



(*3)

LDA indicator (→P.270, 275)



LDA OFF indicator^{*1}
(→P.279)

































(*3)

LTA indicator (→P.270)



Driving assist information indicator^{*1, 2} (→P.316, 330, 339)

-  PDA indicator (→P.281)
(*3)
-  Intuitive parking assist detection indicator*4 (if equipped) (→P.323)
-  Intuitive parking assist OFF indicator*1, 2 (if equipped) (→P.323)
-  Slip indicator light*2 (→P.432)
(Flashes)
-  VSC OFF indicator*1, 2 (→P.432)
-  Smart key system indicator*5 (→P.432)
-  Outside rear view mirror indicators*6 (→P.316, 330)
-  Stop & Start indicator*1 (if equipped) (→P.309)
-  Stop & Start cancel indicator*1, 2 (if equipped) (→P.309)
-  Brake hold standby indicator*2 (→P.231)
-  Brake hold operated indicator*2 (→P.231)
-  Security indicator*7 (→P.70, 71)
-  Low outside temperature indicator*8 (→P.82, 88)
-  Parking brake indicator (→P.227)
(U.S.A.)
-  Parking brake indicator (→P.227)
(Canada)

-  "ECO" mode indicator (→P.412)
-  "SPORT" mode indicator (if equipped) (→P.412)
-  "SPORT S" mode indicator (if equipped) (→P.412)
-  "SPORT S+" mode indicator (if equipped) (→P.412)
-  "COMFORT" mode indicator (if equipped) (→P.412)
-  "CUSTOM" mode indicator (if equipped) (→P.412)
-  Downhill assist control system indicator*2 (if equipped) (→P.428)
-  High speed four-wheel drive indicator (if equipped) (→P.414)
(*3)
-  Low speed four-wheel drive indicator (if equipped) (→P.414, 417)
(*3)
-  "AUTO LSD" indicator*2 (if equipped) (→P.419)
-  Center differential lock (if equipped) (→P.417)
-  Rear differential lock indicator (if equipped) (→P.421)
-  Crawl Control indicator (if equipped) (→P.422)
-  AUTO mode indicator (if equipped) (→P.425)
-  DIRT mode indicator (if equipped) (→P.425)
-  SAND mode indicator (if equipped) (→P.425)



MUD mode indicator (if equipped) (→P.425)



DEEP SNOW mode indicator (if equipped) (→P.425)



ROCK mode indicator (if equipped) (→P.425)



“TOW HAUL” indicator (→P.225)



SDM indicator (if equipped) (→P.436)



“AIR BAG ON/OFF” indicator^{*1, 7} (→P.44)



Stop lights indicator^{*9}

^{*1}: The light comes on when the system is turned off.

^{*2}: These lights come on when the engine switch is turned to ON to indicate that a system check is being performed. They will turn off after the engine is started, or after a few seconds. There may be a malfunction in a system if the lights do not turn on, or turn off. Have the vehicle inspected by your Toyota dealer.

^{*3}: Depending on the operating condition, the color and illuminating/flashing state of the light change.

^{*4}: Vehicles without multimedia display or rear camera on.

^{*5}: This light illuminates on the multi-information display with a message.

^{*6}: This light illuminates on the outside rear view mirrors.

^{*7}: This light illuminates on the over-

head console.

^{*8}: When the outside temperature is approximately 37°F (3°C) or lower, the indicator will flash for approximately 10 seconds, then stay on.

^{*9}: This light comes on when the stop lights are illuminated by the operation of the brake pedal or the driving assist system.

■ Intuitive parking assist OFF indicator

Vehicles without multimedia display: The indicators turn off when the shift position is changed to R regardless of whether the intuitive parking assist function is turned on or off.

Gauges and meters (7-inch display)

The meters display various drive information.

Meter display

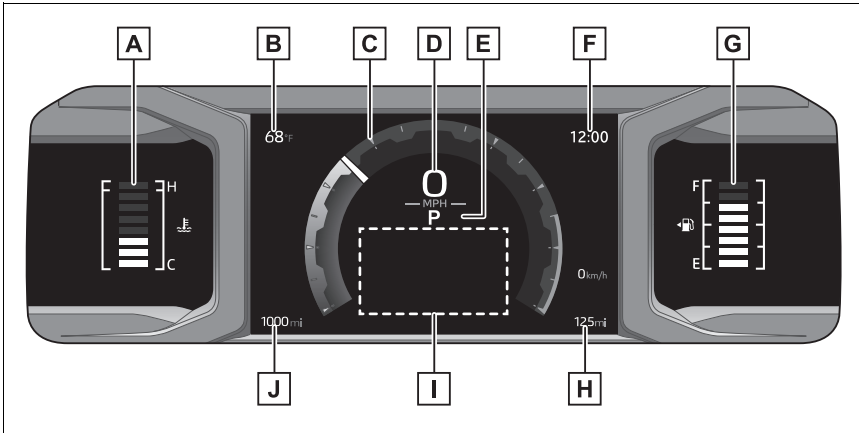

The units used on the meter and display may differ depending on the target region.

A Engine coolant temperature gauge

Displays the engine coolant temperature.

B Outside temperature (→P.82)

C Analog meter

The dial type of analog meter can be changed on  of the multi-information display. (→P.97)

Tachometer: Displays the engine speed in revolutions per minute.

Analog speed meter: Displays the vehicle speed.

D Digital speedometer

Displays the vehicle speed.

E Shift position and shift range indicator

Displays the selected shift position or selected shift range. (→P.222)

F Clock (→P.84)

Automatically adjusts the time by using the GPS time information (GPS clock). For details, refer to “MULTIMEDIA OWNER’S MANUAL”.

G Fuel gauge

Displays the quantity of fuel remaining in the tank.

In the following situations, the actual quantity of fuel remaining in the tank may not be displayed correctly. Refer to P.83 if the actual quantity of fuel remaining in the tank is not displayed correctly.

- A small amount of fuel is added.
- Fuel is added with the fuel gauge near or at “F”.
- The vehicle is stopped on an uneven surface, such as a slope.
- The vehicle is driven on a slope or around a curve.

H Distance to empty

Displays driving range with remaining fuel. (→P.83)

I Multi-information display

Presents the driver with a variety of vehicle data. (→P.91)

Displays warning messages if a malfunction occurs. (→P.587)

J Odometer and distance until next engine oil change display

Odometer:

Displays the total distance the vehicle has been driven.

Distance until next engine oil change:

Displays the distance the vehicle can be driven until an oil change is necessary.

The distance until the next engine oil change will also be displayed in the following situations:

- When the engine switch is turned to ON.
- When a warning message indicating that oil maintenance should be performed soon or is required is displayed.
- Resetting: →P.532

■ The meters and display illuminate when

The engine switch is in ON.

■ When the drive mode is changed

Background color is changed following the selected driving mode. (→P.412)

■ If the units of measure for speedometer can be changed

The other units of measure is also displayed as shown in the illustrations.

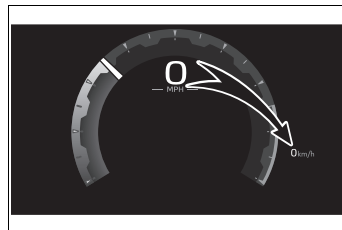
**■ Outside temperature display**

- Displays the outside temperature within the range of -40°F (-40°C) to 140°F (60°C).
- When the outside temperature is approximately 37°F (3°C) or lower, the indicator  will flash

for approximately 10 seconds, then stay on.

- In the following situations, the correct outside temperature may not be displayed, or the display may take longer than normal to change.
- When stopped, or driving at low speeds (less than 12 mph [20 km/h])
- When the outside temperature has changed suddenly (at the entrance/exit of a garage, tunnel, etc.)
- When "--" or "E" is displayed, the system may be malfunctioning. Take your vehicle to your Toyota dealer.

■ Fuel gauge and driving range display

The fuel gauge and driving range display are linked. If the fuel gauge and driving range display do not update after refueling a small amount, they can be updated by performing the following procedure:

- 1 Stop the vehicle on a level surface.

Wait until the fuel in the fuel tank stabilizers.

- 2 Turn the engine switch off.
- 3 While pressing and holding OK of the meter control switch, turn the engine switch to ON.
- 4 Continue holding OK of the meter control switch for approximately 5 seconds.

Release the button when the odometer begins blinking. Updating will be complete when the odometer blinks for approximately 5 seconds and then returns to the normal display.

■ Distance to empty

- This distance is computed based on your average fuel consumption. As a result, the actual dis-

tance that can be driven may differ from that displayed.

- When only a small amount of fuel is added to the tank, the display may not be updated. When refueling, turn the engine switch off. If the vehicle is refueled without turning the engine switch off, the display may not be updated.
- When "Refuel" is displayed, the remaining fuel amount is low and the distance that can be driven with the remaining fuel cannot be calculated. Refuel immediately.

■ Liquid crystal display

→P.91

■ Free/open Source Software Information

This product contains Free/Open Source Software (FOSS). The license information and/or the source code of such FOSS can be found at the following URL.

<https://www.yazaki-group.com/rd-tech/oss/890>

■ Customization

The gauges and meters can be customized in  of the multi-information display. (→P.637)

WARNING

■ The information display at low temperatures

Allow the interior of the vehicle to warm up before using the liquid crystal information display. At extremely low temperatures, the information display monitor may respond slowly, and display changes may be delayed.

**WARNING**

For example, there is a lag between the driver's shifting and the new gear number appearing on the display. This lag could cause the driver to downshift again, causing rapid and excessive engine braking and possibly an accident resulting in death or injury.

**NOTICE**

- **To prevent damage to the engine and its components**
- Do not let the indicator needle of the tachometer enter the red zone, which indicates the maximum engine speed.
- The engine may be overheating if the engine coolant temperature gauge is in the red zone (H). In this case, immediately stop the vehicle in a safe place, and check the engine after it has cooled completely. (→P.612)

Adjusting the clock

The clocks on the following can be adjusted on the multimedia system screen.

- Multi-information display
- Multimedia system screen

For details, refer to "MULTIMEDIA OWNER'S MANUAL".

■ Clock settings screen

If "Clock:00" is displayed when  is selected on the multi-information display, the system may be malfunctioning.

Have the vehicle inspected by your

Toyota dealer.

Instrument panel light control

The brightness of the instrument panel lights can be adjusted.

Pressing the button will adjust brightness of the instrument panel light.

The brightness of the instrument panel lights can be adjusted by pressing the button.

Short press: 1 step change of brightness level.

Long press: continues change of brightness level until released.

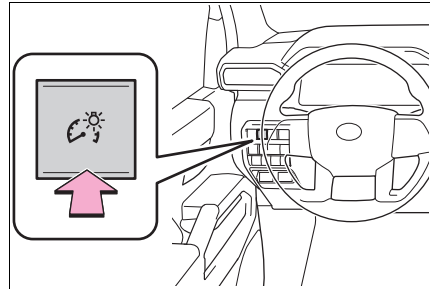
**■ Instrument cluster brightness adjustment**

The instrument cluster brightness levels when the tail lights are on and off can be adjusted individually. However, when the surroundings are bright (daytime, etc.), turning on the tail lights will not change the instrument cluster brightness.

Gauges and meters (12.3-inch display)

The meters display various drive information.

Meter display

■ Locations of gauges and meters

The meter type can be changed on “ Settings” of the multi-information display. (→P.108)

► Type 1/Type 2

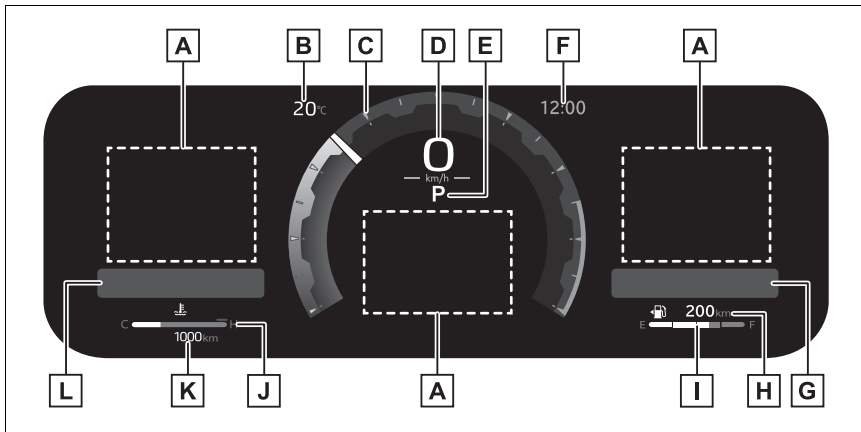

The units of measure may differ depending on the intended destination of the vehicle.

A Multi-information display

Presents the driver with a variety of vehicle data. (→P.100)
Displays warning messages if a malfunction occurs. (→P.587)

B Outside temperature (→P.88)

C Analog meter (Type 2 only)

The dial type of analog meter can be changed on “ Settings” of the multi-information display. (→P.108)

Tachometer: Displays the engine speed in revolutions per minute.

Analog speedometer: Displays the vehicle speed.

D Digital speedometer

Displays the vehicle speed.

E Shift position and shift range indicator

Displays the selected shift position or selected shift range (→P.222)

F Clock (→P.90)

Automatically adjusts the time by using the GPS time information (GPS clock). For details, refer to “MULTIMEDIA OWNER’S MANUAL”.

G Widget (Audio system-linked display)

Displays the selected audio source or track on the meter. (→P.104)

While list of items for content display area (→P.102) is displayed, widget will not be displayed.

H Distance to empty

Displays driving range with remaining fuel. (→P.89)

I Fuel gauge

Displays the quantity of fuel remaining in the tank.

In the following situations, the actual quantity of fuel remaining in the tank may not be displayed correctly. Refer to P.89 if the actual quantity of fuel remaining in the tank is not displayed correctly.

- A small amount of fuel is added.
- Fuel is added with the fuel gauge near or at “F”.
- The vehicle is stopped on an uneven surface, such as a slope.
- The vehicle is driven on a slope or around a curve.

J Engine coolant temperature gauge

Displays the engine coolant temperature.

K Odometer and distance until next engine oil change display

Odometer:

Displays the total distance the vehicle has been driven.

Distance until next engine oil change:

Displays the distance the vehicle can be driven until an oil change is necessary.

The distance until the next engine oil change will also be displayed in the following situations:

- When the engine switch is turned to ON.
- When a warning message indicating that oil maintenance should be performed soon or is required is displayed.
- Resetting: →P.532

L Widget (Fuel Economy)

Displays fuel economy information. (→P.103)

While list of items for content display area (→P.102) is displayed, widget will not be displayed.

► Type 3

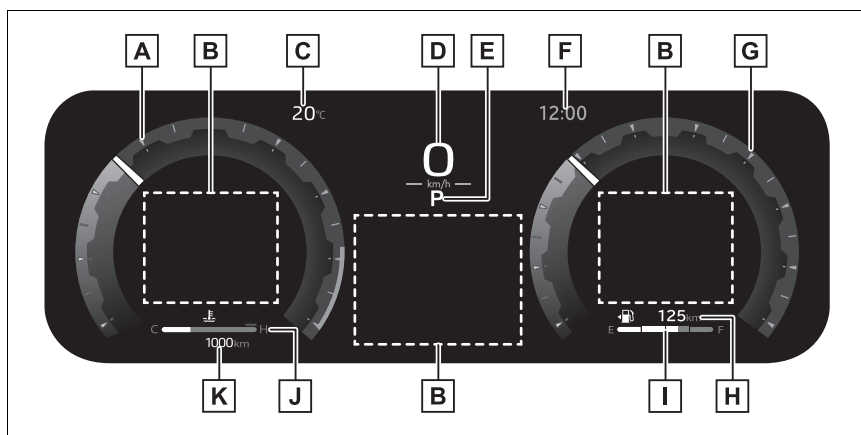
**A** Tachometer

Displays the engine speed in revolutions per minute.

B Multi-information display

Presents the driver with a variety of vehicle data. (→P.100)

Displays warning messages if a malfunction occurs. (→P.587)

C Outside temperature (→P.88)**D** Digital speedometer

Displays the vehicle speed.

E Shift position and shift range indicator

Displays the selected shift position or selected shift range (→P.222)

F Clock (→P.90)

Automatically adjusts the time by using the GPS time information (GPS clock). For details, refer to “MULTIMEDIA OWNER’S MANUAL”.

G Analog speedometer

Displays the vehicle speed.

H Distance to empty

Displays driving range with remaining fuel. (→P.89)

I Fuel gauge

Displays the quantity of fuel remaining in the tank.

In the following situations, the actual quantity of fuel remaining in the tank may not be displayed correctly. Refer to P.89 if the actual quantity of fuel remaining in the tank is not displayed correctly.

- A small amount of fuel is added.

- Fuel is added with the fuel gauge near or at “F”.
- The vehicle is stopped on an uneven surface, such as a slope.
- The vehicle is driven on a slope or around a curve.

J Engine coolant temperature gauge

Displays the engine coolant temperature.

K Odometer and distance until next engine oil change display

Odometer:

Displays the total distance the vehicle has been driven.

Distance until next engine oil change:

Displays the distance the vehicle can be driven until an oil change is necessary.

The distance until the next engine oil change will also be displayed in the following situations:

- When the engine switch is turned to ON.
- When a warning message indicating that oil maintenance should be performed soon or is required is displayed.
- Resetting: →P.532

■ The meters and display illuminate when

The engine switch is in ON.

■ When the drive mode is changed

Background color is changed following the selected driving mode. (→P.412)

■ If the units of measure for speedometer can be changed

The other units of measure is also displayed as shown in the illustrations.

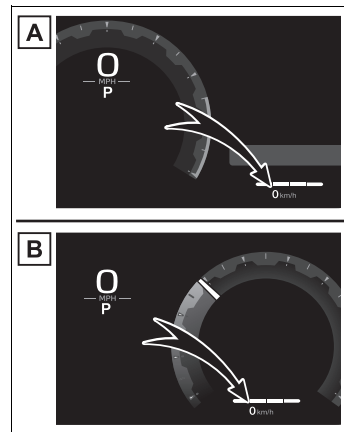

A Type 1/Type 2

B Type 3

■ Outside temperature display

- Displays the outside temperature within the range of -40°F (-40°C) to 140°F (60°C).
- When the outside temperature is approximately 37°F (3°C) or lower, the indicator  will flash for approximately 10 seconds,

then stay on.

- In the following situations, the correct outside temperature may not be displayed, or the display may take longer than normal to change:
 - When stopped, or driving at low speeds (less than 20 mph [12 km/h])
 - When the outside temperature has changed suddenly (at the entrance/exit of a garage, tunnel, etc.)
- When "--" or "E" is displayed, the system may be malfunctioning. Take your vehicle to your Toyota dealer.

■ Fuel gauge and driving range display

The fuel gauge and driving range display are linked. If the fuel gauge and driving range display do not update after refueling a small amount, they can be updated by performing the following procedure:

- 1 Stop the vehicle on a level surface.

Wait until the fuel in the fuel tank stabilizes.

- 2 Turn the engine switch off.
- 3 While pressing and holding OK of the meter control switch, turn the engine switch to ON.
- 4 Continue holding OK of the meter control switch for approximately 5 seconds.

Release the button when the odometer begins blinking. Updating will be complete when the odometer blinks for approximately 5 seconds and then returns to the normal display.

■ Distance to empty

- This distance is computed based on your average fuel consumption. As a result, the actual distance that can be driven may differ

from that displayed.

- When only a small amount of fuel is added to the tank, the display may not be updated. When refueling, turn the engine switch off. If the vehicle is refueled without turning the engine switch off, the display may not be updated.
- When "Refuel" is displayed, the remaining fuel amount is low and the distance that can be driven with the remaining fuel cannot be calculated. Refuel immediately.

■ Liquid crystal display

→P.101

■ Free/Open Source Software Information

Free and Open Source Software Information

This product contains free and open source software. License information and/or source code for such free/open source software are available at the following URL:

<https://www.denso.com/global/en/opensource/meter/toyota/>

■ Customization

The gauges and meters can be customized in "⚙ Settings" of the multi-information display. (→P.637)



WARNING

■ The information display at low temperatures

Allow the interior of the vehicle to warm up before using the liquid crystal information display. At extremely low temperatures, the information display monitor may respond slowly, and display changes may be delayed.

**WARNING**

For example, there is a lag between the driver's shifting and the new gear number appearing on the display. This lag could cause the driver to downshift again, causing rapid and excessive engine braking and possibly an accident resulting in death or injury.

**NOTICE**

- **To prevent damage to the engine and its components**
- Do not let the indicator needle of the tachometer enter the red zone, which indicates the maximum engine speed.
- The engine may be overheating if the engine coolant temperature gauge is in the red zone (H). In this case, immediately stop the vehicle in a safe place, and check the engine after it has cooled completely. (→P.612)

Adjusting the clock

The clocks on the following can be adjusted on the multimedia system screen.

- Multi-information display
- Multimedia system screen

For details, refer to "MULTIMEDIA OWNER'S MANUAL".

■ Clock settings screen

If "Clock:00" is displayed when "⚙ Settings" is selected on the multi-information display, the system may be malfunctioning. Have the vehicle inspected by your

Toyota dealer.

Adjusting the instrument panel light control

The brightness of the instrument panel lights can be adjusted.

Pressing the button will adjust brightness of the instrument panel light.

The brightness of the instrument panel lights can be adjusted by pressing the button.

Short press: 1 step change of brightness level.

Long press: continues change of brightness level until released.

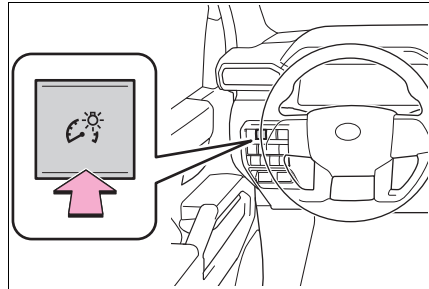
**■ Instrument cluster brightness adjustment**

The instrument cluster brightness levels when the tail lights are on and off can be adjusted individually.

However, when the surroundings are bright (daytime, etc.), turning on the tail lights will not change the instrument cluster brightness.

Multi-information display (7-inch display)

The multi-information display is used to display fuel efficiency related information and various types of driving-related information. The multi-information display can also be used to change the display settings and other settings.

Display contents

■ Display

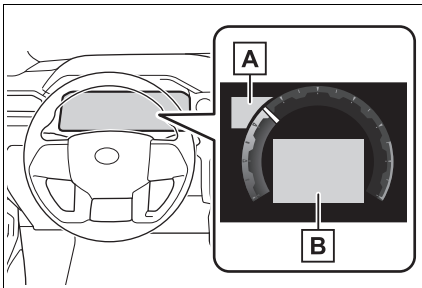

A RSA (Road Sign Assist) (if equipped)

Displays recognized signs while the RSA (Road Sign Assist) is operating. (→P.288)

B Content display area

By selecting menu icons on the multi-information display, a variety of driving-related information can be displayed. The multi-information display can also be used to change display settings and other vehicle settings.







Warning or advice pop-up displays are also displayed in certain situa-

tions.

■ Menu icons

Information related to each icon can be displayed by selecting the icon with the meter control switches.

Some of the information may be displayed automatically depending on the situation.

-  Driving information display (→P.92)
-  Driving support system information display (→P.93)
-  Audio system-linked display (→P.94)
-  Vehicle information display (→P.94)
-  Settings display (→P.97)
-  Warning message display (→P.587)

■ Liquid crystal display

Small spots or light spots may appear on the display. This phenomenon is characteristic of liquid crystal displays, and there is no problem continuing to use the display.

▲ WARNING

■ Caution for use while driving

- When operating the multi-information display while driving, pay extra attention to the safety of the area around the vehicle.
- Do not look continuously at the multi-information display while driving as you may fail to see pedestrians, objects on the road, etc., ahead of the vehicle.

**WARNING**

■ The information display at low temperatures

→P.83

Changing the meter display

The multi-information display is operated using the meter control switches.

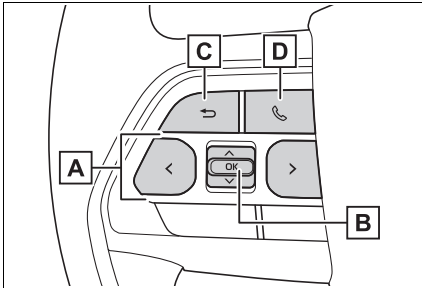

- A** \wedge/\vee : Select menu icons
 \langle / \rangle : Change displayed content, scroll up/down the screen and move the cursor up/down
- B** Press: Enter/Set
 Press and hold: Reset/Display customizable items
- C** Return to the previous screen
- D** Call sending/receiving and history display

Linked with the hands-free system, sending or receiving call is displayed. For details regarding the hands-free system, refer to the "MULTIMEDIA OWNER'S MANUAL".

Content of driving information

■ Display items

- Fuel economy
- Eco Driving Indicator/Distance to empty

■ Fuel economy

Use the displayed values as a reference only.

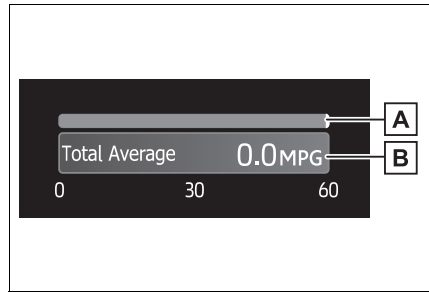

- A** Current fuel consumption
 Displays instantaneous current fuel consumption.
- B** Average fuel economy (after reset)

To reset the average fuel economy display, press and hold the OK meter control switch.

The average fuel economy display can be changed in .

(→P.97)

- Average fuel economy (after start)

Displays the average fuel consumption since engine start.

- Average fuel economy (after refuel)

Displays the average fuel consumption since the vehicle was refueled.

■ Eco Driving Indicator/Distance to empty

● Eco Driving Indicator

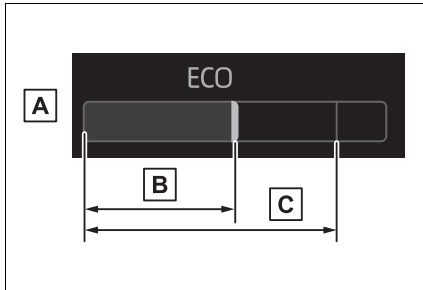

A Eco Driving Indicator Zone Display

Suggests the Zone of Eco driving with current Eco driving ratio based on acceleration.

B Eco driving ratio based on acceleration

If the acceleration exceeds the Zone of Eco driving, the right side of the Eco Driving Indicator Zone Display will illuminate.

C Zone of Eco driving

● Distance to empty

Displays the driving range with remaining fuel. (→P.83)

■ Distance to empty

- This distance is computed based on your average fuel consumption. As a result, the actual distance that can be driven may differ from that displayed.
- When only a small amount of fuel is added to the tank, the display may not be updated. When refueling, turn the engine switch to OFF.

If the vehicle is refueled without turning the engine switch to OFF, the display may not be updated.

- When “Refuel” is displayed, the remaining fuel amount is low and the distance that can be driven with the remaining fuel cannot be calculated. Refuel immediately.

Driving support system information display

■ Driving support system information

Select to display the operational status of the following systems:

- LDA (Lane Departure Alert) (→P.275)
- LTA (Lane Tracing Assist) (→P.270)
- Dynamic radar cruise control (→P.290)
- Cruise control (→P.301)
- PCS (Pre-Collision System) (→P.259)
- PDA (Proactive driving assist) (→P.281)

■ Navigation system-linked display

Select to display the following navigation system-linked information:

- Route guidance to destination
- Compass display (heading-up display)

Audio system-linked display

The operating conditions of the audio system can be displayed on the multi-information display.

Vehicle information display

■ Trailer brake (if equipped)

Displays trailer brake control status (→P.437) and trailer type*.

*: To select the trailer, press and hold the OK meter control switch. (→P.92)

■ Trailer Mode BSM

Displays trailer length* and trailer blind spot status (→P.316).

*: To select the trailer, press and hold the OK meter control switch. (→P.92)

■ Drive information

2 items that are selected using the “Drive Info Items” setting (average speed, distance and total time) can be displayed vertically.

Use the displayed information as a reference only.

Following items will be displayed.

- “Average Speed”: Displays the average vehicle speed

since engine start*

- “Distance”: Displays the distance driven since engine start*
- “Total Time”: Displays the elapsed time since engine start*

*: These items are reset each time the engine stops.

■ Trip information

2 items that are selected using the “TRIP A Items” or “TRIP B Items” setting (average speed, distance and total time) can be displayed vertically.

Use the displayed information as a reference only.

- “Average Speed”: Displays the average vehicle speed since the display was reset*
- “Distance”: Displays the distance driven since the display was reset*
- “Total Time”: Displays the elapsed time since the display was reset*

*: To reset, display the desired item and press and hold the meter control switch.

■ Tire inflation pressure

Displays inflation pressure of each tire.

■ Traction monitor display (4WD models)

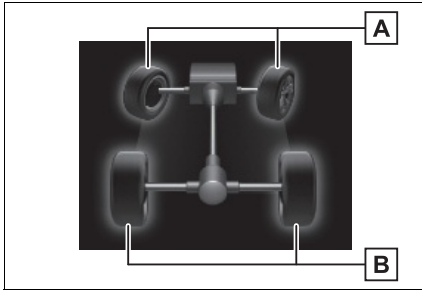

A Front tire direction display

Displays the operation amount and direction of the steering wheel via changes to the front tires on the display.

B Wheel spin display

When a tire is spinning, its icon on the display changes its color and blinks.

This item is displayed only when driving mode is set to sport mode.

The illustration used is intended as an example, and may differ from the image that is actually displayed on the multi-information display.

■ Clinometer

Clinometer displays the vehicle inclination to the front, rear, left and right within a range of 0° to approximately 30°.

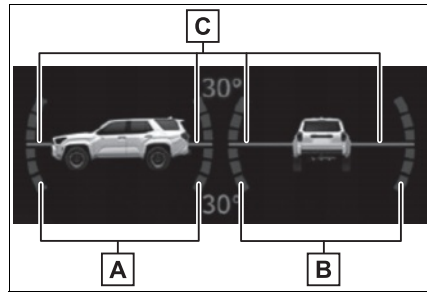

A Degree markers of incline to the front and rear

Indicates the vehicle inclination in degrees in the front and rear directions.

B Degree markers of incline to the left and right

Indicates the vehicle inclination in degrees in the left and right directions.

C Pointer

Indicates the degree of the vehicle inclination in comparison to a parallel line.

■ Voltmeter and Engine oil pressure gauge

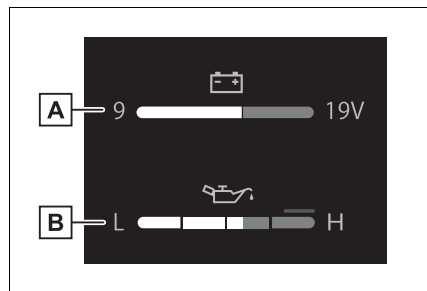

A Voltmeter

Displays the charge state

B Engine oil pressure gauge

Displays the engine oil pressure

■ Engine oil temperature gauge and Transmission oil temperature gauge

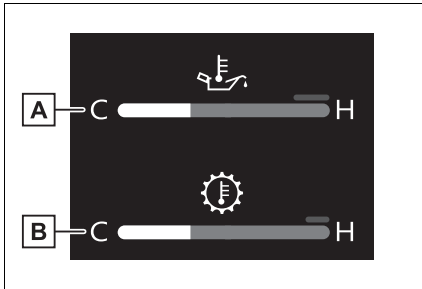

A Engine oil temperature gauge

Displays the engine oil temperature

B Transmission oil temperature gauge

Displays the transmission oil fluid temperature

■ Boost gauge

Displays the boost pressure.



⚠ NOTICE

■ Voltmeter

When the voltmeter indicates 19 V or higher or 9 V or lower while the engine is running, there may be a battery or charging system malfunction. Have the vehicle inspected at your Toyota dealer.

■ Engine oil pressure gauge

When the value of the engine oil pressure gauge drops while the engine is running, stop the vehicle in a safe place immediately and check the amount of engine oil. (→P.531)

When the oil pressure drops even though the engine oil amount has not decreased, or if the oil pressure does not increase when engine oil is added, contact your Toyota dealer, as there may be a problem with the lubrication system.

Trailer settings screen

● Trailer settings screen

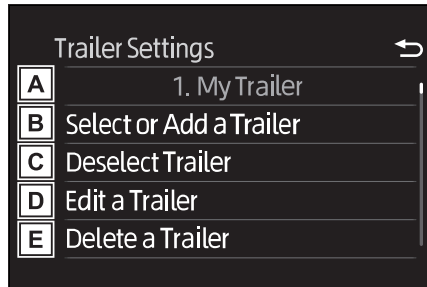

A Displays the name of the currently selected trailer or “No Trailer Selected” if a trailer has not yet been selected

B Add a new trailer or select an existing saved trailer

- Maximum of 10 trailers can be saved.
- Select the trailer name, length, hitch type, brake type and number of axles.
- The parameters which can be set depend on which of the trailer systems are installed on the vehicle. (Trailer Brake Controller,

Trailer Backup Guide and Trailer Mode BSM)

- C** Deselect the currently selected trailer
 - Used when a 4-pin trailer connector has been disconnected. (4-pin trailer connector disconnection cannot be automatically detected by Trailer Brake Controller)
- D** Edit the parameters of a saved trailer (name, length, hitch type, brake type and number of axles)
 - The parameters which can be edited depend on which of the trailer systems are installed on the vehicle (Trailer Brake Controller, Trailer Backup Guide and Trailer Mode BSM)
- E** Delete a saved trailer
 - Trailer detail screen

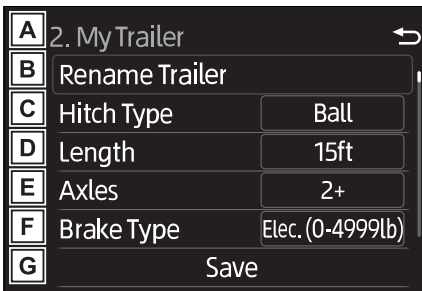

- A** Displays the name of the current trailer which is being added or edited.
- B** Change the name of the trailer.
- C** Change the hitch type of the trailer between ball hitch (conventional), gooseneck or fifth wheel. Note that goose-

neck and fifth wheel trailers are not supported for some features (Trailer Backup Guide and Trailer Mode BSM)

- D** Change the length of the trailer. If the exact length is not listed, round up the actual length of the trailer to the closest available value.

“Auto” length detection can also be selected.
- E** Change the number of axles.
- F** Change the brake type (electric or electric over hydraulic) and weight of the trailer, or turn trailer brakes off for that trailer.
- G** Save the trailer information

If there are any errors with the trailer values, re-select the value or delete and re-save the trailer. If the error continues, contact your Toyota dealer.

Settings display

■ Meter display settings that can be changed

- Language

Select to change the language displayed.
- Units

Select to change the units of measure displayed.
- Meter Style

The design of the meter display can be changed.

- **Dial Type**

Select to change dial type.

-  (Driving information display settings)

- Fuel economy display

Select to change the average fuel consumption display between after start/after reset/after refuel.

(→P.92)

-  (Audio settings)

Select to display/not display the audio system linked display.

-  (Vehicle information display settings)

Select to change the displayed content of the following:

- Drive information and Trip A/B items

Select to set the first and second items of the drive information display to any of the following: average vehicle speed/distance/elapsed time.

- Pop-up display

Select to enable/disable pop-up displays for each relevant system.

- Multi-information display off

Select to turn the multi-information display off.

To turn the multi-information display on again, press any of the meter control switches.

- Default setting

Select to reset the meter display settings to the default setting.

■ Vehicle functions and settings that can be changed

→P.637

■ Suspension of the settings display

- Some settings cannot be changed while driving. When changing settings, park the vehicle in a safe place.
- If a warning message is displayed, operation of the settings display will be suspended.

WARNING

■ Cautions during setting up the display

If the engine is running when changing the display settings, ensure that the vehicle is parked in a place with adequate ventilation. In a closed area such as a garage, exhaust gases including harmful carbon monoxide (CO) may collect and enter the vehicle. This may lead to death or a serious health hazard.

NOTICE

■ During setting up the display

To prevent battery discharge, ensure that the engine is running while setting up the display features.

Stop & Start system information (if equipped)

- Stop & Start system operation time (after start)/status notification

Displays the current amount of time the engine has been stopped by the operation of the Stop & Start sys-

tem.

Also shows the status of the Stop & Start system with a pop-up display. (→P.313)

- **Stop & Start system settings**

The length of time of the Stop & Start system will operate when the “A/C” switch of the air conditioning system is on can be set to 2 different levels in “ Settings” of the multi-information display. (→P.313)

Suggestion function

Displays suggestions to the driver in the following situations. To select a response to a displayed suggestion, use the meter control switches.

- **Suggestion to turn on the headlights**

If the headlight switch is in other than  or AUTO, and the vehicle speed is 3 mph (5 km/h) or higher for a certain amount of time when the surroundings are dark, a suggestion message will be displayed.

- **Suggestion to turn off the headlights**

If the headlights are left on for a certain amount of time after the engine switch has been turned off, a suggestion message will be displayed.

When the headlight switch is in the AUTO position: The mes-

sage asking if you wish to turn the headlights off is displayed. To turn the headlights off, select “Yes”.

If the driver’s door is opened after the engine switch is turned off, this suggestion message will not be displayed.

- **Suggestion to enable the power back door***

If the power back door system is disabled (setting on  set to off) and the power back door switch on the instrument panel is operated, a suggestion message will be displayed asking if you wish to enable the power back door system. To enable the power back door system, select “Yes”.

After enabling the power back door system, press the power back door switch again to open or close the power back door.

*: If equipped

- **Customization**

The suggestion function can be turned on/off. (→P.637)

Multi-information display (12.3-inch display)

The multi-information display is used to display fuel efficiency related information and various types of driving-related information. The multi-information display can also be used to change the display settings and other settings.

Display contents

Following information is displayed in each area on the multi-information display.

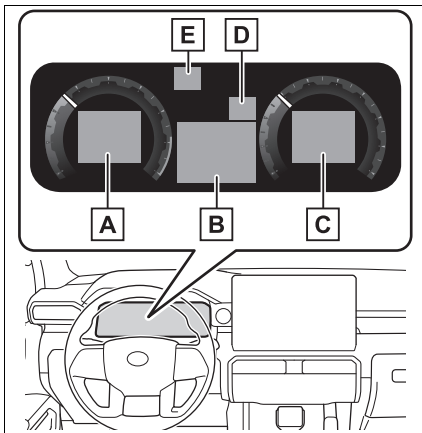

- A** Content display area (left)
- B** Content display area (center)
- C** Content display area (right)
- D** Driving support system information display area

When driving information support

system is displayed on the content display area, the system operating state will not be displayed in this area.

- E** RSA (Road Sign Assist) display area (if equipped) (→P.288)

Content display area (center)

- Blank
- Driving support system information display (→P.103)
- Map display (→P.104)
- Trailer settings screen (→105)
- Settings display (→P.108)
- Warning message display

Content display area (left/right)

- Blank
- Fuel Economy (→P.103)
- Eco Driving Indicator (→P.103)
- Driving support system information display (→P.103)
- Navigation system-linked display (→P.104)
- Audio system-linked display (→P.104)
- Drive information display (→P.104)
- Tire inflation pressure (→P.105)
- Traction monitor display (if equipped) (→P.105)

- Trailer brake (if equipped) (→P.106)
- Trailer mode BSM (→P.106)
- Clinometer (if equipped) (→P.106)
- Voltmeter and Engine oil pressure gauge (→P.107)
- Engine oil temperature gauge and Transmission oil temperature gauge (→P.107)
- Boost gauge (→P.108)

■ **Liquid crystal display**

Small spots or light spots may appear on the display. This phenomenon is characteristic of liquid crystal displays, and there is no problem continuing to use the display.

⚠ WARNING

■ **Caution for use while driving**

- When operating the multi-information display while driving, pay extra attention to the safety of the area around the vehicle.
- Do not look continuously at the multi-information display while driving as you may fail to see pedestrians, objects on the road, etc., ahead of the vehicle.

■ **The information display at low temperatures**
→P.89

Changing the meter display

The multi-information display is operated using the meter control switches.

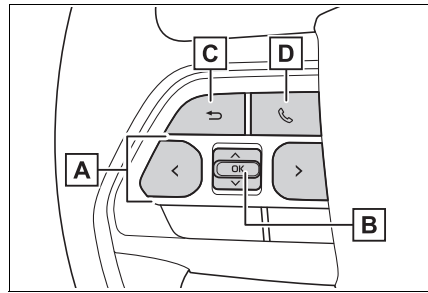

- A** \wedge/\sphericalangle : Change displayed content and scroll up/down the screen
 \langle / \rangle : Change the screen and move the cursor
- B** Press: Enter/Set
Press and hold: Reset/Display customizable items/Display the cursor
- C** Return to the previous screen
- D** Call sending/receiving and history display

Linked with the hands-free system, sending or receiving call is displayed. For details regarding the hands-free system, refer to the "MULTIMEDIA OWNER'S MANUAL".

Changing the display

The multi-information display is operated using the meter control switches.

■ **Changing the meter display type setting**

The meter display type setting can be changed on "⚙ Set-

tings". (→P.108)

■ **Changing the screen**

Select items from the combination of 3 screens to display on each 3 content display areas.

Press < or > of the meter control switches to scroll the screen.

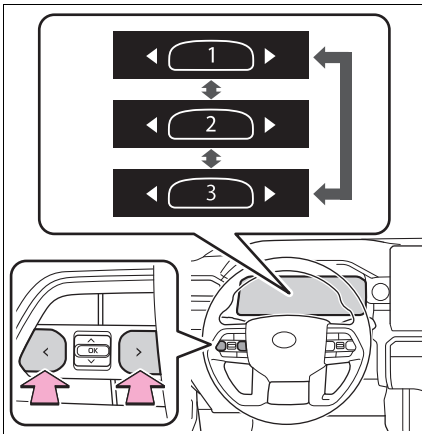

■ **Changing the display contents**

Switches items displayed on each contents display area (left/center/right).

- 1 Press and hold OK to display the cursor on the content display area (center).
- 2 Press < or > to move the cursor and select the content display area.
- 3 Press ^ or v to select the display items.

■ **Items displayed in the content display area**

Select items to enable/disable on the content display area (left/right).

- 1 Press and hold OK to display area (center).
- 2 Press < or > to move the cursor and select the content display area.
- 3 Contents display area (left):
Press < to display contents list.
Contents display area (right):
Press > to display contents list.
- 4 Press ^ or v to select the display items.
- 5 Press OK to enable/disable items.

⚠ WARNING

■ **Caution for use while driving**
For safety, avoid operating the meter control switches while driving as much as possible, and do not look continuously at the multi-information display while driving. Stop the vehicle and operate the meter control switches. Failure to do so may cause a steering wheel operation error, resulting in an unexpected accident.

Fuel Economy

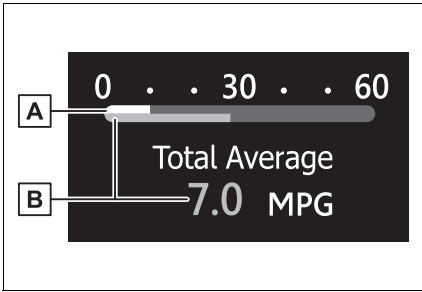

A Current fuel economy
Displays the instantaneous current fuel consumption.

B Average fuel economy
Displays the average fuel economy since the function was reset or the average fuel economy after starting or refueling.*1, 2, 3

The average fuel economy selected by Fuel Economy on the “⚙ Settings” screen is displayed.

*1: Use the displayed fuel consumption as a reference only.

*2: Average fuel economy after starting is reset each time the engine stops.

*3: Average fuel economy since function was reset can be reset by pressing and holding OK.

Eco Driving Indicator

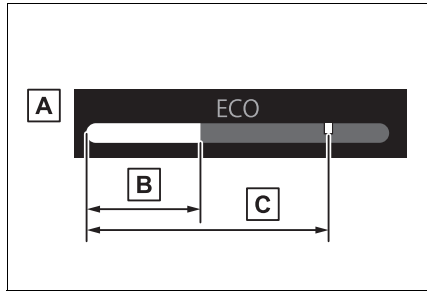

A Eco Driving Indicator Zone Display
Suggests the Zone of Eco driving with current Eco driving ratio based on acceleration.

B Eco driving ratio based on acceleration
If the acceleration exceeds the Zone of Eco driving, the right side of the Eco Driving Indicator Zone Display will illuminate.

C Zone of Eco driving

Driving support system information display

Select to display the operational status of the following systems:

- LDA (Lane Departure Alert) (→P.275)
- LTA (Lane Tracing Assist) (→P.270)
- Dynamic radar cruise control (→P.290)
- Cruise control (→P.301)
- PDA (Proactive driving assist) (→P.281)

- PCS (Pre-Collision System)
(→P.259)

Map display

Displays the map data according to the navigation system.

Switches the displayed map size by pressing OK .

Navigation system-linked display

Select to display the following navigation system-linked information:

- Route guidance to destination
- Compass display (heading-up display)

Audio system-linked display

The operating conditions of the audio system can be displayed on the multi-information display.

Driving information display

■ Drive information

2 items that are selected using the “Drive Info Items” setting (average speed, distance and total time) can be displayed vertically.

Use the displayed information as a reference only.

Following items will be displayed.

- “Average Speed”: Displays the average vehicle speed since engine start*
- “Distance”: Displays the distance driven since engine start*
- “Total Time”: Displays the elapsed time since engine start*

*: These items are reset each time the engine stops.

■ Trip information

2 items that are selected using the “TRIP A Items” or “TRIP B Items” setting (average speed, distance and total time) can be displayed vertically.

Use the displayed information as a reference only.

- “Average Speed”: Displays the average vehicle speed since the display was reset*
- “Distance”: Displays the distance driven since the display was reset*
- “Total Time”: Displays the elapsed time since the display was reset*

*: To reset, display the desired item and press and hold OK .

Tire inflation pressure

Displays inflation pressure of each tire.

Traction monitor display (4WD models)

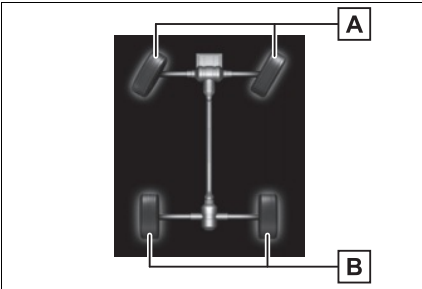

A Front tire direction display
 Displays the operation amount and direction of the steering wheel via changes to the front tires on the display.

B Wheel spin display
 When a tire is spinning, its icon on the display changes its color and blinks.

This item is displayed only when driving mode is set to sport mode. The illustration used is intended as an example, and may differ from the image that is actually displayed on the multi-information display.

Trailer settings screen

- Trailer settings screen

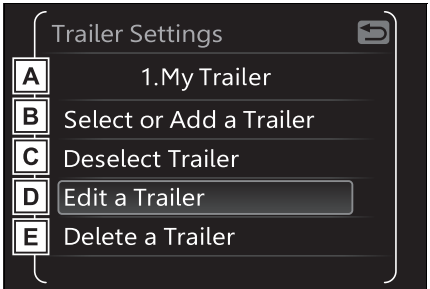

A Displays the name of the currently selected trailer or “No Trailer Selected” if a trailer has not yet been selected

B Add a new trailer or select an existing saved trailer

- Maximum of 10 trailers can be saved.
- Select the trailer name, length, hitch type, brake type and number of axles.
- The parameters which can be set depend on which of the trailer systems are installed on the vehicle. (Trailer Brake Controller, Trailer Backup Guide and Trailer Mode BSM)

C Deselect the currently selected trailer

- Used when a 4-pin trailer connector has been disconnected. (4-pin trailer connector disconnection cannot be automatically detected by Trailer Brake Controller)

D Edit the parameters of a saved trailer (name, length, hitch type, brake type and number of axles)

- The parameters which can be edited depend on which of the trailer systems are installed on the vehicle (Trailer Brake Controller, Trailer Backup Guide and Trailer Mode BSM)

E Delete a saved trailer

- Trailer detail screen

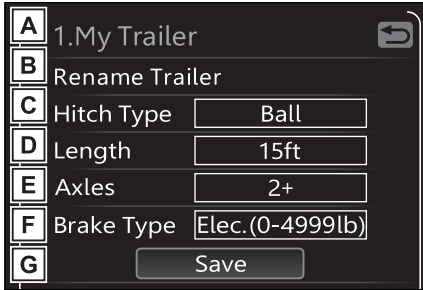

A Displays the name of the current trailer which is being added or edited.

B Change the name of the trailer.

C Change the hitch type of the trailer between ball hitch (conventional), gooseneck or fifth wheel. Note that gooseneck and fifth wheel trailers are not supported for some features (Trailer Backup Guide and Trailer Mode BSM)

D Change the length of the trailer. If the exact length is not listed, round up the actual length of the trailer to the closest available value.

“Auto” length detection can also be selected.

E Change the number of axles.

F Change the brake type (electric or electric over hydraulic) and weight of the trailer, or turn trailer brakes off for that trailer.

G Save the trailer information

If there are any errors with the trailer values, re-select the value or delete and re-save the trailer. If the error continues, contact your Toyota dealer.

Trailer brake (if equipped)

Displays trailer brake control status (→P.437) and trailer type*.

*: To select the trailer, press and hold the OK meter control switch. (→P.101)

Trailer mode BSM

Displays trailer length* and trailer blind spot status (→P.316).

*: To select the trailer, press and hold the OK meter control switch. (→P.101)

Clinometer (if equipped)

Clinometer displays the vehicle inclination to the front, rear, left and right within a range of 0° to approximately 30°.

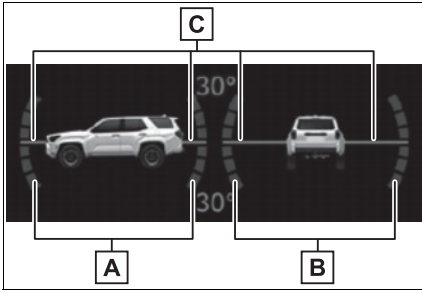

A Degree markers of incline to the front and rear

Indicates the vehicle inclination in degrees in the front and rear directions.

B Degree markers of incline to the left and right

Indicates the vehicle inclination in degrees in the left and right directions.

C Pointer

Indicates the degree of the vehicle inclination in comparison to a parallel line.

Voltmeter and Engine oil pressure gauge

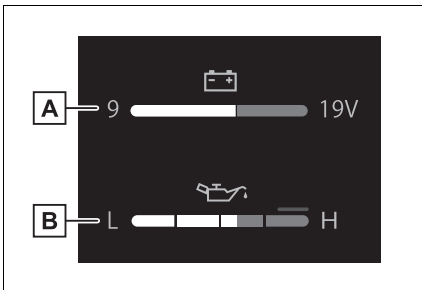

A Voltmeter

Displays the charge state

B Engine oil pressure gauge

Displays the engine oil pressure

NOTICE

Voltmeter

When the voltmeter indicates 19 V or higher or 9 V or lower while the engine is running, there may be a battery or charging system malfunction. Have the vehicle inspected at your Toyota dealer.

Engine oil pressure gauge

When the value of the engine oil pressure gauge drops while the engine is running, stop the vehicle in a safe place immediately and check the amount of engine oil. (→P.531)

When the oil pressure drops even though the engine oil amount has not decreased, or if the oil pressure does not increase when engine oil is added, contact your Toyota dealer, as there may be a problem with the lubrication system.

Engine oil temperature gauge and Transmission oil temperature gauge

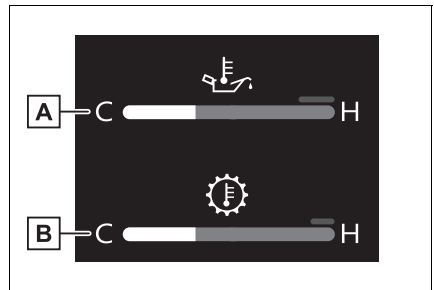

A Engine oil temperature gauge

Displays the engine oil temperature

B Transmission oil temperature gauge

Displays the transmission oil fluid temperature

Boost gauge

Displays the boost pressure.



Settings display

■ **Meter display settings that can be changed**

- Language

Select to change the language displayed.

- Units

Select to change the units of measure displayed.

- Meter Type

Select to change the meter type setting.

- Meter Style

Select to change the meter style.

- Dial Type

Select to change dial type.

- Fuel economy display

Select to change the average fuel consumption display between after start/after reset/after refuel.

(→P.103)

- Drive information and Trip A/B

items

Select to set the first and second items of the drive information display to any of the following: average vehicle speed/distance/elapsed time.

- Pop-up display

Select to enable/disable pop-up displays for each relevant system.

- Default setting

Select to reset the meter display settings to the default setting.

■ **Vehicle functions and settings that can be changed**

→P.637

■ **Suspension of the settings display**

- Some settings cannot be changed while driving. When changing settings, park the vehicle in a safe place.
- If a warning message is displayed, operation of the settings display will be suspended.

⚠ WARNING

■ **Cautions during setting up the display**

If the engine is running while changing certain settings on the settings display, ensure that the vehicle is parked in a place with adequate ventilation. In a closed area such as a garage, exhaust gases including harmful carbon monoxide (CO) may collect and enter the vehicle. This may lead to death or a serious health hazard.

**NOTICE****■ During setting up the display**

To prevent battery discharge, ensure that the engine is running while setting up the display features.

Stop & Start system information (if equipped)

- Stop & Start system operation time (after start)/status notification

Displays the current amount of time the engine has been stopped by the operation of the Stop & Start system.

Also shows the status of the Stop & Start system with a pop-up display. (→P.313)

- Stop & Start system settings

The length of time of the Stop & Start system will operate when the “A/C” switch of the air conditioning system is on can be set to 2 different levels in “ Settings” of the multi-information display. (→P.313)

Suggestion function

Displays suggestions to the driver in the following situations. To select a response to a displayed suggestion, use the meter control switches.

- **Suggestion to turn on the headlights**

If the headlight switch is in other

than  or AUTO, and the vehicle speed is 3 mph (5 km/h) or higher for a certain amount of time when the surroundings are dark, a suggestion message will be displayed.

- **Suggestion to turn off the headlights**

If the headlights are left on for a certain amount of time after the engine switch has been turned off, a suggestion message will be displayed.

When the headlight switch is in the AUTO position: The message asking if you wish to turn the headlights off is displayed. To turn the headlights off, select “Yes”.

If the driver’s door is opened after the engine switch is turned off, this suggestion message will not be displayed.

- **Suggestion to enable the power back door***

If the power back door system is disabled (setting on  set to off) and the power back door switch on the instrument panel is operated, a suggestion message will be displayed asking if you wish to enable the power back door system. To enable the power back door system, select “Yes”.

After enabling the power back door system, press the power back door switch again to open or close the power back door.

*: If equipped

■ Customization

The suggestion function can be turned on/off. (→P.637)

Fuel consumption information

Fuel consumption information can be displayed on the multimedia system.

Consumption

■ Current fuel consumption screen

- 1 Select  on the main menu.

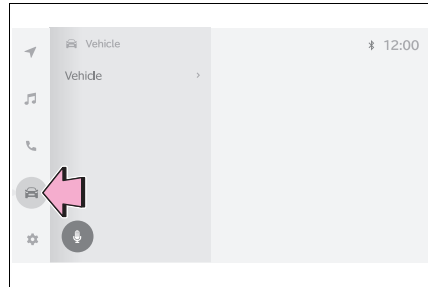

- 2 Select "Trip information".

If a screen other than "Current" is displayed, select "Current".

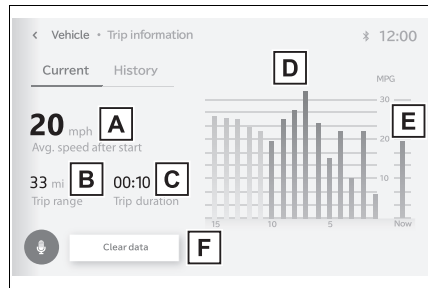

A Average vehicle speed since the engine was started.

B Trip range

C Elapsed time since the

engine was started.

- D** Fuel consumption in the past 15 minutes
- E** Current fuel consumption
- F** Resetting the consumption data

Use the displayed average fuel consumption as a reference. The image is an example only, and may vary slightly from actual conditions.

History fuel consumption screen

- 1 Select  on the main menu.

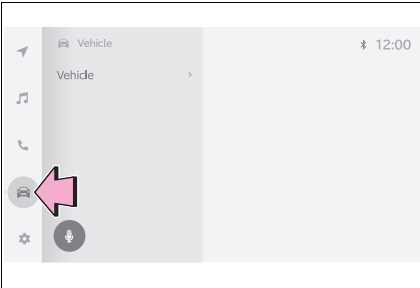

- 2 Select "Trip information".

If a screen other than "History" is displayed, select "History".

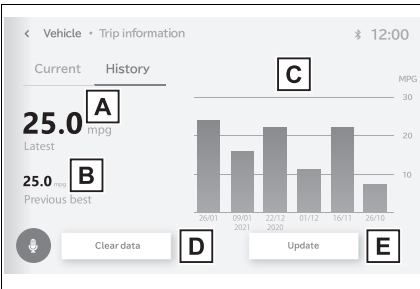

- A** Latest fuel consumption
- B** Best recorded fuel consumption

- C** Previous fuel consumption record
- D** Resetting the history data
- E** Updating the latest fuel consumption data

Use the displayed average fuel consumption as a reference. The image is an example only, and may vary slightly from actual conditions.

Updating the history data

Update the average fuel consumption by selecting "Update" to measure the current fuel consumption again.

Resetting the data

The fuel consumption data can be deleted by selecting "Clear data".

Trip range

Displays the estimated maximum distance that can be driven with the quantity of fuel remaining.

As a result, the actual distance that can be driven may differ from that displayed.

3-1. Key information

Keys	114
Digital Key	117

3-2. Opening, closing and locking the doors

Side doors	119
Power running boards.	124
Back door	127
Smart key system	145

3-3. Adjusting the seats

Front seats	151
Rear seats	152
Head restraints	158

3-4. Adjusting the steering wheel and mirrors

Steering wheel	161
Inside rear view mirror	162
Digital Rear-view Mirror	164
Outside rear view mirrors	173

3-5. Opening, closing the windows and moon roof

Power windows	177
Power back window	180
Moon roof	182

3-6. Favorite settings

Driving position memory	186
My Settings	189

Keys

The keys

The following keys are provided with the vehicle.

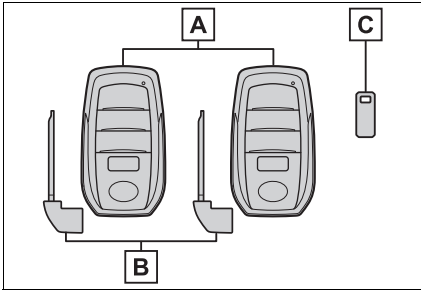

A Electronic keys

- Operating the smart key system (→P.145)
- Operating the wireless remote control function (→P.116)

B Mechanical keys

C Key number plate

■ When riding in an aircraft

When bringing an electronic key onto an aircraft, make sure you do not press any buttons on the electronic key while inside the aircraft cabin. If you are carrying an electronic key in your bag, etc., ensure that the buttons are not likely to be pressed accidentally. Pressing a button may cause the electronic key to emit radio waves that could interfere with the operation of the aircraft.

■ Electronic key battery depletion

- The standard battery life is 1 to 2 years.
- If the battery becomes low, an alarm will sound in the cabin and a message will be shown on the multi-information display when the

engine is stopped.

- To reduce key battery depletion when the electronic key is to not be used for long periods of time, set the electronic key to the battery-saving mode. (→P.147)
- As the electronic key always receives radio waves, the battery will become depleted even if the electronic key is not used. The following symptoms indicate that the electronic key battery may be depleted. Replace the battery when necessary.
 - The smart key system or the wireless remote control does not operate.
 - The detection area becomes smaller.
 - The LED indicator on the key surface does not turn on.
- You can replace the battery by yourself (→P.558). However, as there is a danger that the electronic key may be damaged, it is recommended that replacement is carried out by your Toyota dealer.
- To avoid serious deterioration, do not leave the electronic key within 3 ft. (1 m) of the following electrical appliances that produce a magnetic field:
 - TVs
 - Personal computers
 - Cellular phones, cordless phones and battery chargers
 - Recharging cellular phones or cordless phones
 - Table lamps
 - Induction cookers
- If the electronic key is near the vehicle for longer than necessary, even if the smart key system is not used, the key battery may become depleted faster than normal. When not using the smart key system, it is recommended not to stay with the electronic key near the vehicle longer than necessary.

■ **If a message regarding the state of the electronic key or engine switch mode, etc. is shown**

To prevent trapping the electronic key inside the vehicle, leaving the vehicle carrying the electronic key on your person without turning the engine switch to OFF or other passengers from unintentionally taking the key out of the vehicle, etc., a message that prompts the user to confirm the state of the electronic key or engine switch mode may be shown on the multi-information display.

In those cases, follow the instructions on the display immediately.

■ **If “Key Battery Low Replace Key Battery” is displayed on the multi-information display**

The electronic key has a low battery. Replace the electronic key battery. (→P.558)

■ **Replacing the battery**

→P.558

■ **Confirmation of the number of registered keys**

The number of keys already registered to the vehicle can be confirmed. Ask your Toyota dealer for details.

■ **If “A New Key has been Registered Contact Your Dealer for Details” is shown on the multi-information display**

This message will be displayed each time the driver’s door is opened when the doors are unlocked from the outside for approximately 10 days after a new electronic key has been registered. If this message is displayed but you have not had a new electronic key registered, ask your Toyota dealer to check if an unknown electronic key (other than those in your possession) has been registered.



NOTICE

■ **To prevent key damage**

- Do not drop the keys, subject them to strong shocks, or bend them.
- Do not expose the keys to high temperatures for a long period of time.
- Do not get the keys wet or wash them in an ultrasonic washer, etc.
- Do not attach metallic or magnetic materials to the keys or place the keys close to such materials.
- Do not disassemble the keys.
- Do not attach a sticker or anything else to the surface of the electronic key.
- Do not place the keys near objects that produce magnetic fields, such as TVs, audio systems and induction cookers, or medical electrical equipment, such as low-frequency therapy equipment.

■ **Carrying the electronic key on your person**

Carry the electronic key 3.9 in. (10 cm) or more away from electric appliances that are turned on. Radio waves emitted from electric appliances within 3.9 in. (10 cm) of the electronic key may interfere with the key, causing the key to not function properly.

■ **In case of a smart key system malfunction or other key-related problems**

→P.606

■ **When an electronic key is lost**

→P.605

Wireless remote control

The electronic keys are equipped with the following wireless remote control:

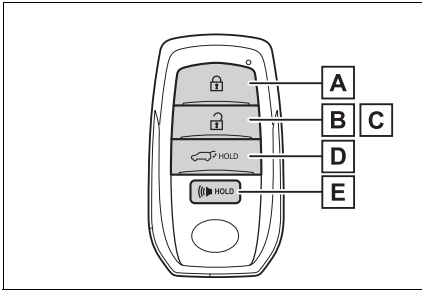

- A** Locks the doors (→P.119)
- B** Unlocks the doors (→P.119)
- C** Opens the windows*¹ and the moon roof*^{1, 2} (→P.119)
- D** Opens and closes the power back door*² (→P.130)
- E** Sounds the alarm

*¹: This setting must be customized at your Toyota dealer.

*²: If equipped

■ Theft deterrent panic mode

When (HOLD) is pressed for longer than about one second, an alarm will sound intermittently and the vehicle lights will flash to deter any person from trying to break into or damage your vehicle.

To stop the alarm, press any button on the electronic key.

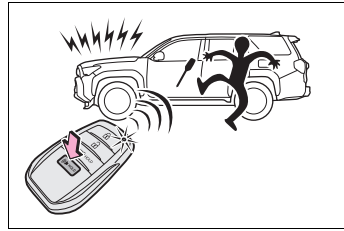

Using the mechanical key

To take out the mechanical key, slide the release lever **A** and take the key out.

The mechanical key can only be inserted in one direction, as the key only has grooves on one side. If the key cannot be inserted in a lock cylinder, turn it over and re-attempt to insert it.

After using the mechanical key, store it in the electronic key. Carry the mechanical key together with the electronic key. If the electronic key battery is depleted or the entry function does not operate properly, you will need the mechanical key. (→P.606)

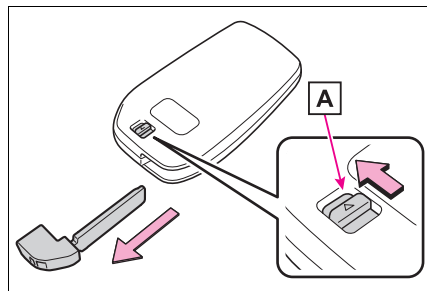

■ When required to leave the vehicle's key with a parking attendant

Lock the glove box as circumstances demand. (→P.474)

Remove the mechanical key for

your own use and provide the attendant with the electronic key only.

■ **If you lose your mechanical keys**

→P.605

■ **If a wrong key is used**

The key cylinder rotates freely, isolated from the internal mechanism.

Digital Key*

*: If equipped

A smartphone can be used instead of the electronic key of the vehicle by installing the dedicated Digital Key App on a smartphone. Also, Digital Key can be shared with your family or friends using the Digital Key App.

■ **Free/open source software information**

This product contains Free/open source software (FOSS).

License information and/or the source code of this FOSS can be obtained at the following URL:

<https://www.denso.com/global/en/opensource/dkey/toyota/>

Digital Key usage conditions

In order to use the Digital Key, you need to install the Toyota App. Register the Vehicle to the customer's Toyota App profile, and subscribe to Remote Services, and enroll in Digital Key.

Digital Key precautions

- A Digital Key can be used when the smartphone and server can communicate. The Digital Key may become unusable if the smartphone is not connected to the Internet. Be sure to carry the electronic

key of the vehicle if traveling to a location with unreliable communications.

- If the smartphone battery is depleted, the smartphone cannot be used as Digital Key. If the battery level is low, be sure to charge the smartphone prior to going out.
- The Digital Key system is related to the smart key system. If the smart key system has been deactivated in the vehicle customization setting, the Digital Key will also be disabled.
- Depending on the radio wave environment, the Digital Key may not be able to be used.
→P.147
- When transferring vehicle ownership, make sure to delete the Digital Keys.
- If the vehicle is not operated for 14 days or more, the Digital Key will not connect automatically. Therefore, it may take some time before the system operates after a door handle is touched.
- A part of the services may be stopped for a certain period of time due to server maintenance. However, registered Digital Keys can be used during the maintenance.
- A smartphone with the Digital Key App enabled will be able

to lock and unlock the doors, start the engine and perform any other operations as same as the electronic key of the vehicle. Be especially careful not to lose the smartphone or allow it to be stolen.

If the smartphone is lost or stolen, contact your Toyota dealer immediately.

- When taking your vehicle to a Toyota dealer for an inspection or repairs, make sure to bring an electronic key.
- With the Digital Key alone, no vehicle lights will illuminate when approached to the vehicle. Also, with the Digital Key alone, some functions, such as the power back door's close & lock (walk-away) function, etc., cannot be used.

Side doors

Unlocking and locking the doors from the outside

■ Smart key system (entry function)

Carry the electronic key to enable this function.

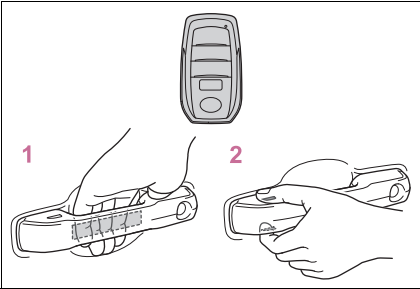

- 1 Grip the driver's door handle to unlock the door. Holding the driver's door handle for approximately 2 seconds unlocks all the doors. Grip front passenger door handle to unlock all the doors.*

Make sure to touch the sensor on the back of the handle.

The doors cannot be unlocked for 3 seconds after the doors are locked.

- 2 Touch the lock sensor (indentation on the upper part or lower part of the handle) to lock all the doors.

Check that the door is securely locked.

*: The door unlock settings can be changed.

■ Wireless remote control

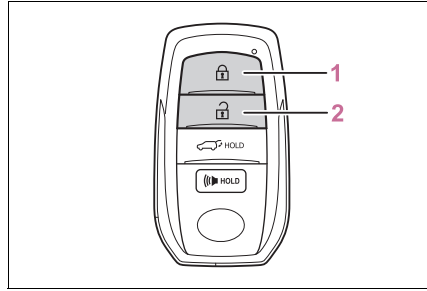

- 1 Locks all the doors

Check that the door is securely locked.

- 2 Unlocks all the doors

Pressing the button unlocks the driver's door. Pressing the button again within 5 seconds unlocks the other door.





Press and hold to open the windows*¹ and the moon roof*^{1, 2}

*1: This setting must be customized at your Toyota dealer.

*2: If equipped



■ Switching the door unlock function

It is possible to set which doors the entry function unlocks using the wireless remote control. Perform the switching operation in the vehicle or within approximately 3.2 ft. (1 m) of the vehicle.

- 1 Turn the engine switch off.
- 2 When the indicator light on the key surface is not on, press and hold ,  (if equipped) or  HOLD for approximately 5 seconds while pressing and holding .

The setting changes each time an operation is performed, as shown

below. (When changing the setting continuously, release the buttons, wait for at least 5 seconds, and repeat step 2.)

Multi-information display/Beep	Unlocking function
 <p data-bbox="130 508 330 565">Exterior. Beeps 3 times</p>	<p data-bbox="345 346 545 500">Holding the driver's door handle unlocks only the driver's door.</p>
 <p data-bbox="130 773 330 830">Exterior. Beeps twice</p>	<p data-bbox="345 522 545 642">Holding the front passenger door handle unlocks all the doors.</p> <p data-bbox="345 667 545 847">Holding driver's door handle or front passenger door handle unlocks all the doors.</p>

*1: Vehicles with 7-inch display

*2: Vehicles with 12.3-inch display

To prevent unintended triggering of the alarm, unlock the doors using the wireless remote control and open and close a door once after the settings have been changed. (If a door is not opened within 60 seconds after  is pressed, the doors will be locked again and the alarm will automatically be set.)

In a case that the alarm is triggered, immediately stop the alarm. (→P.71)

Impact detection door lock release system

In the event that the vehicle is subject to a strong impact, all the doors are unlocked. Depending on the force of the impact or the type of accident, however, the system may not operate.

Operation signals

A buzzer sounds and the emergency flashers flash to indicate that the doors have been locked/unlocked. (Locked: once; Unlocked: twice)

A buzzer sounds to indicate that the windows and moon roof (if equipped) are operating.

Security feature

If a door is not opened within approximately 60 seconds after the vehicle is unlocked, the security feature automatically locks the vehicle again. (However, depending on the location of the electronic key, the key may be detected as being in the vehicle. In this case, vehicle may be unlocked.)

When the doors cannot be locked by the lock sensor on the upper part of the door handle

If the door will not lock even when the topside sensor area is touched, try touching both the topside and underside sensor areas at the same time.

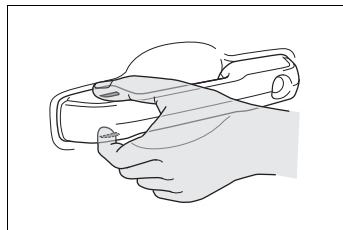

Open door warning buzzer

If an attempt to lock the doors is made when a door is not fully closed, a buzzer sounds continuously for 5 seconds. Fully close the door to stop the buzzer, and lock the vehicle once more.

Setting the alarm

Locking the doors will set the alarm system. (→P.71)

■ Conditions affecting the operation of the smart key system or wireless remote control

→P.147

■ If the smart key system or the wireless remote control does not operate properly

- Use the mechanical key to lock and unlock the doors. (→P.606)
- Replace the key battery with a new one if it is depleted. (→P.558)

■ If the battery is discharged

The doors cannot be locked and unlocked using the smart key system or wireless remote control. Lock or unlock the doors using the mechanical key. (→P.606)

■ Rear seat reminder function

As the first reminder so as not to forget luggage, etc. in the rear seat, when the engine switch is turned off after any of the following conditions are met, a buzzer will sound and a message will be displayed on the multi-information display for approximately 6 seconds.

Also, as the second reminder, when the doors are locked, a buzzer will sound and the emergency flashers will flash for a few seconds, and a message will be displayed on the multi-information display.

- The engine is started within approximately 10 minutes after opening and closing a rear door.
- A rear door has been opened and closed after the engine was started.

The second reminder will not be activated if a rear door was opened before the doors are locked. However, if a rear door is opened and then closed within approximately 2 seconds, the rear seat reminder function may not operate.

The rear seat reminder function determines that luggage, etc., has been placed in a rear seat based on

opening and closing of a rear door. Therefore, depending on the situation, the rear seat reminder function may not operate and you may still forget luggage, etc., in the rear seat, or it may operate unnecessarily.

The rear seat reminder function can be enabled/disabled. (→P.637)

■ Customization

Some functions can be customized. (→P.637)

WARNING

■ To prevent an accident

Observe the following precautions while driving the vehicle. Failure to do so may result in a door opening and an occupant falling out of the vehicle, resulting in death or serious injury.

- Ensure that all doors are properly closed and locked.
- Do not pull the inside handle of the doors while driving.

Be especially careful for the front doors, as the doors may be opened even if the inside lock buttons are in locked position.

- Set the rear door child-protector locks when children are seated in the rear seats.

WARNING

■ When opening or closing a door

Check the surroundings of the vehicle such as whether the vehicle is on an incline, whether there is enough space for a door to open and whether a strong wind is blowing. When opening or closing the door, hold the door handle tightly to prepare for any unpredictable movement.

■ **When using the wireless remote control and operating the power windows or moon roof (if equipped)**

Operate the power window or moon roof after checking to make sure that there is no possibility of any passenger having any of their body parts caught in the window or moon roof. Also, do not allow children to operate the wireless remote control. It is possible for children and other passengers to get caught in the power window or moon roof.

Unlocking and locking the doors from the inside

■ **Door lock switches (to lock/unlock)**

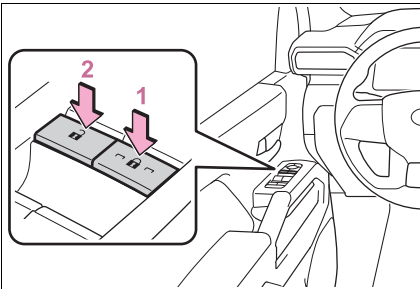

- 1 Locks all the doors
- 2 Unlocks all the doors

■ **Inside lock buttons**

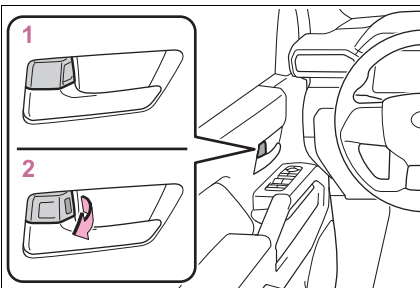

- 1 Locks the door

2 Unlocks the door

The front doors can be opened by pulling the inside handle even if the lock buttons are in the lock position.

■ **Locking the front doors from the outside without a key**

- 1 Move the inside lock button to the lock position.
- 2 Close the door.

The door cannot be locked if the engine switch is in ACC or ON, or the electronic key is left inside the vehicle. However, the key may not be detected correctly and the door may be locked.

■ **If a symbol indicating one or more doors are open is shown on the multi-information display**

The hood or one or more of the doors are not fully closed. The system also indicates which doors are not fully closed. If the vehicle reaches a speed of 3 mph (5 km/h), a buzzer sounds to indicate that the door(s) are not yet fully closed.

Make sure that the hood and all the doors are closed.

■ **When all the doors are locked with the entry function or wireless remote control**

- The doors cannot be unlocked with the door lock switch.
- The door lock switch can be reset by unlocking all the doors with the entry function or wireless remote control.

Rear door child-protector lock

The door cannot be opened from inside the vehicle when the lock is set.

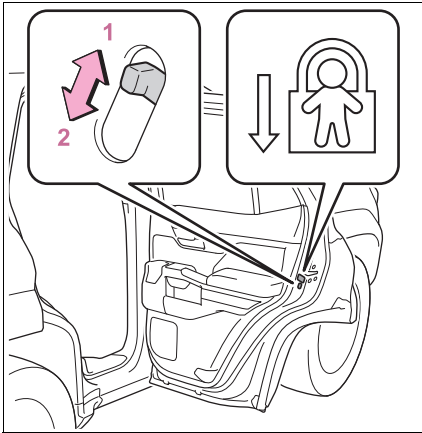

- 1 Unlock
- 2 Lock

These locks can be set to prevent children from opening the rear doors. Push down on each rear door switch to lock both rear doors.

Automatic door locking and unlocking systems

The following functions can be set or canceled:

For instructions on customizing, refer to P.637.

Function	Operation
Shift position linked door unlocking function	All doors are automatically unlocked when the shift position is shifted to P.
Driver's door linked door unlocking function	All doors are automatically unlocked when driver's door is opened within approximately 45 seconds after turning the engine switch off.

Function	Operation
Speed linked door locking function	All doors are automatically locked when vehicle speed is approximately 12 mph (20 km/h) or higher.
Shift position linked door locking function	All doors are automatically locked when the shift position is shifted to a position other than P.

Power running boards*

*: If equipped

The power running boards deploy when opening a door or by using the switch inside the vehicle.

The power running boards stow by closing a door, operating the switch inside the vehicle, or by driving 3 mph (5 km/h) or higher.



WARNING

■ Cautions regarding the power running boards

Observe the following precautions.

Failure to do so may cause serious injury.

- Check to make sure that all passengers and people in the vehicle's surrounding area do not have a hand on the boards or any part of their body in a position where it could be caught between the boards and the vehicle when the power running boards is being operated.
- Confirm that the boards have completely deployed or stowed before getting in or out of the vehicle. If someone gets in or out of the vehicle during the power running boards operation, the boards may stop deploying or stowing.
- Take care when pressing the power steps switch. The boards will deploy or stow and may hit other people or objects.

- Always check that the power steps switch is turned off when cleaning the boards, before jacking up or placing any object under the vehicle, or if boards are not operating correctly.

- Do not allow children to operate the power running boards. Operating the power running boards so that the boards contacts someone can cause serious injury, and in some instances, even death.

- If the engine continues to run after operating, the electric step may become hot. Take care not to touch the metal parts with any exposed skin when getting in and out of the vehicle, as this may cause burns.

■ Jam protection function

Observe the following precautions.

Failure to do so may cause serious injury.

Do not place any body part between the boards and vehicle.

The jam protection function may not work depending on the shape of the object that is caught.

Side door linked operation

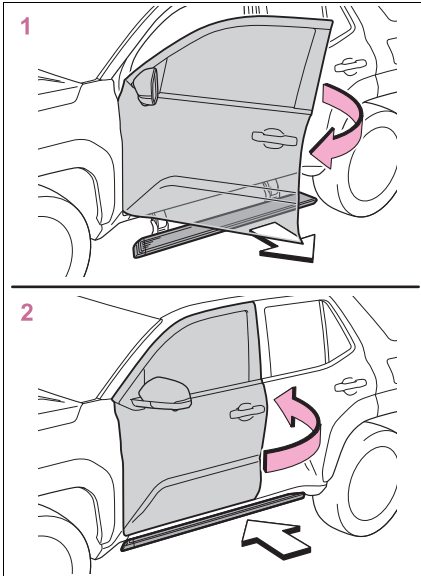

- 1 Opening a door: The appropriate board deploys.
- 2 Closing a door: The appropriate board stows.

■ Jam protection function

If a board contacts an obstacle when deploying, it will stow. If an obstacle gets caught between a board and the vehicle when stowing, the board will deploy.

If an obstacle is detected 3 times in a row during power running board operation, the board will stop at the position it contacts the obstacle. When the side door on the same side as the board is opened and closed, or switch is operated once the obstacle is cleared, the board will attempt to stow or deploy again.

■ Automatic stowing function

The boards will be automatically stowed, for safety, under the following conditions:

- A board is not completely stowed
- Vehicle speed is approximately 3 mph (5 km/h) or higher

The boards will not automatically deploy again when vehicle speed returns to less than 3 mph (5 km/h).

■ If “Power Steps Unable to Deploy See Owner’s Manual” is displayed on the multi-Information display

The board may not be completely deployed.

Close and open the door once more or use the switch inside the vehicle (→P.126) and completely deploy the board.

■ If “Power Steps Unable to Retract See Owner’s Manual” is displayed on the multi-Information display

The boards may not be completely stowed.

Check that nothing is caught between the boards and the vehicle.

■ If “Power Steps System Malfunction Visit Your Dealer” is displayed on the multi-Information display

The system may be malfunctioning. Have the vehicle inspected by Toyota dealer.

■ When snow or mud is attached to the boards or the boards are frozen

The power running boards may not operate correctly. Before stepping on a board, check that it is completely deployed. If the power running boards are not operating correctly, turn the power steps switch off and refrain from use.

■ After recharging/reconnecting the battery

If the power running boards have not completely deployed or stowed, the boards may not move in the intended direction the first time they are operated. However, from the

second time onwards, the boards will resume normal operation.

■ When getting in and out of the vehicle

Take care because clothes and shoes may become dirty due to contact with the lower part of the vehicle body.

stowed, for safety, under the following condition:

- Vehicle speed is approximately 3 mph (5 km/h) or higher

Deploying and stowing the power running boards from inside

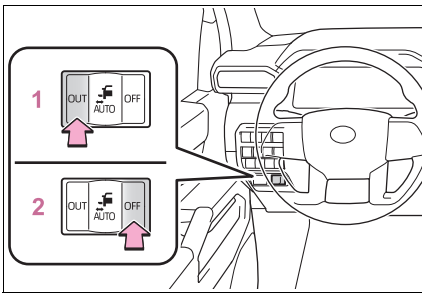

- 1 Deploys the running boards on both sides.
- 2 Stows the running boards on both sides.

Putting the switch in the neutral position sets the power running boards to AUTO mode. AUTO mode allows the deploying/stowing of the boards to be linked to opening/closing of the side doors.

Both power running boards are deployed when “OUT” position is selected. Operation only if steps are not already deployed.

Both power running boards are stowed when “OFF” position is selected. Operation only if steps are not already stowed.

■ Automatic stowing function

The boards will be automatically

Back door

The back door can be locked/unlocked and opened/closed by the following procedures.



WARNING

Observe the following precautions.

Failure to do so may result in death or serious injury.

■ Before driving

- Make sure that the back door is fully closed.
If the back door is not fully closed, it may open unexpectedly while driving and hit nearby objects or luggage in the luggage compartment may be thrown out, causing an accident.
- Do not allow children to play in the luggage compartment.
If a child is accidentally locked in the luggage compartment, they could get heat exhaustion or other injuries.
- Do not allow a child to open or close the back door.
Doing so may cause the back door to move unexpectedly, or cause the child's hands, head, or neck to be caught by the closing back door.

■ Important points while driving

- Keep the back door closed while driving.
If the back door is left open, it may hit near-by objects or luggage in the luggage compartment may be thrown out, causing an accident.

- Never let anyone sit in the luggage compartment.
In the event of sudden braking, sudden swerving or a collision, they are susceptible to death or serious injury.

■ Operating the back door

Observe the following precautions.

Failure to do so may cause parts of the body to be caught, resulting in death or serious injury.

- Remove any heavy loads, such as snow and ice, from the back door before opening it. Failure to do so may cause the back door to suddenly shut again after it is opened.
- When opening or closing the back door, thoroughly check to make sure the surrounding area is safe.
- If anyone is in the vicinity, make sure they are safe and let them know that the back door is about to open or close.
- Use caution when opening or closing the back door in windy weather as it may move abruptly in strong wind.

WARNING

- Vehicles without power back door: The back door may suddenly shut if it is not opened fully. It is more difficult to open or close the back door on an incline than on a level surface, so beware of the back door unexpectedly opening or closing by itself. Make sure that the back door is fully open and secure before using the luggage compartment.

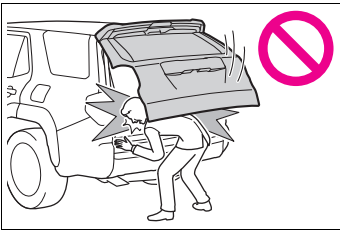

- Vehicles with power back door: The back door may suddenly shut if it is not opened fully, while on a steep incline. Make sure that the back door is secured before using the luggage compartment.

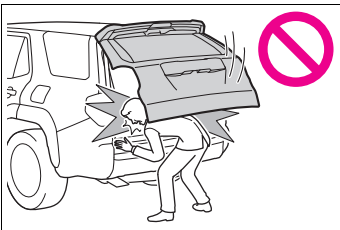

- When closing the back door, take extra care to prevent your fingers, etc. from being caught.



- Vehicles without power back door: When closing the back door, make sure to press it lightly on its outer surface. If the back door handle is used to fully close the back door, it may result in hands or arms being caught.

- Vehicles without power back door: Do not pull on the back door damper stay (→P.130) to close the back door, and do not hang on the back door damper stay. Doing so may cause hands to be caught or the back door damper stay to break, causing an accident.

- Vehicles with power back door: Do not pull on the back door spindle (→P.142) to close the back door, and do not hang on the back door spindle. Doing so may cause hands to be caught or the back door spindle to break, causing an accident.

- If a bicycle carrier or similar heavy object is attached to the back door, it may suddenly shut again after being opened, causing someone's hands, head or neck to be caught and injured. When installing an accessory part to the back door, using a genuine Toyota part is recommended.

Unlocking and locking the back door from the outside

■ Using the entry function

Carry the electronic key to enable this function.

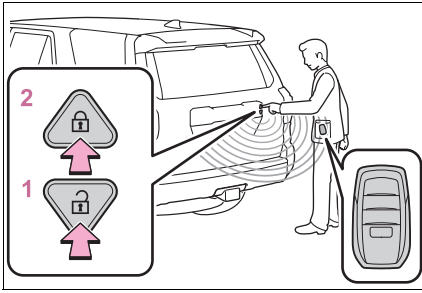

1 Unlocks all the doors

The doors cannot be unlocked for 3 seconds after the doors are locked.

2 Locks all the doors

Check that the door is securely locked.

■ Using the wireless remote control

→P.119

■ Operation signals

→P.120

■ Security feature

→P.120

Unlocking and locking the back door from the inside

■ Using the door lock switches

→P.122

Opening/closing the back door (vehicles without power back door)

■ Open

Raise the back door while pressing up the back door opener switch.

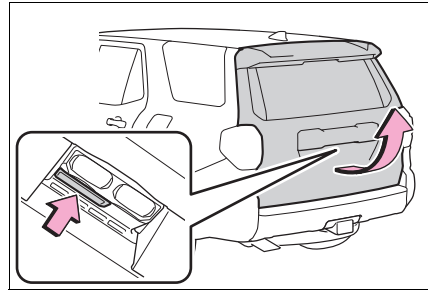

■ Close

Lower the back door using the back door handles **A**, and make sure to push the back door down from the outside to close it.

Be careful not to pull the back door sideways when closing the back door with the handles.

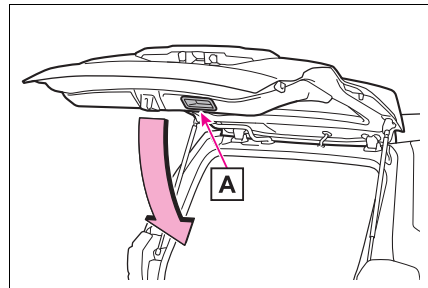

■ Luggage compartment lights

- The luggage compartment lights turn on when the back door is opened.
- When the engine switch is turned to OFF, the lights will go off automatically after 20 minutes.

■ If the back door opener is inoperative

The back door can be unlocked from the inside.

- 1 Remove the cover.

To prevent damage, cover the tip of the screwdriver with a rag.

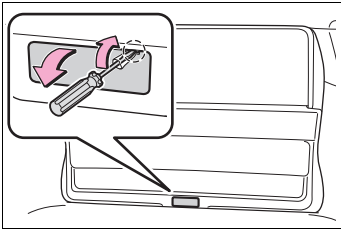

2 Loosen the screw.

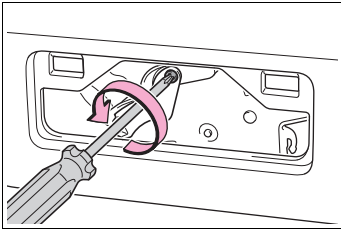

3 Turn the cover.

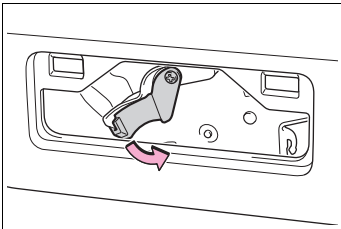

4 Move the lever.

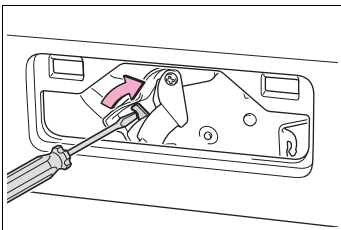

5 When installing, reverse the steps listed.

■ **Open door warning buzzer**

→P.120

 **NOTICE**

■ **Back door damper stays**

The back door is equipped with damper stays that hold the back door in place.

Observe the following precautions.

Failure to do so may cause damage to the back door damper stay, resulting in malfunction.

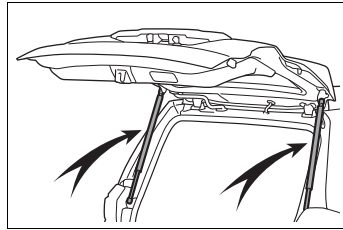

● Do not attach any foreign objects, such as stickers, plastic sheets, or adhesives to the damper stay rod.

● Do not touch the damper stay rod with gloves or other fabric items.

● Do not attach any accessories other than genuine Toyota parts to the back door.

● Do not place your hand on the damper stay or apply lateral forces to it.

Opening/closing the back door (vehicles with power back door)

■ **Using the wireless remote control**

Press and hold the switch.

The power back door automatically opens/closes.

The power back door can be operated whether it is locked* or

unlocked.

Pressing the switch while the power back door is opening/closing stops the operation. When the switch is pressed and held again during the halted operation, the back door will perform the reverse operation.

*: Opening of the power back door when it is locked can be disabled by a customized setting.
(→P.642)

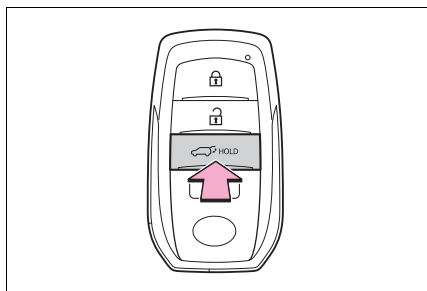

■ Using the power back door switch on the instrument panel

Press and hold the switch.

The power back door automatically opens/closes.

Unlock the back door before operating.

Pressing the switch while the power back door is opening/closing stops the operation. When the switch is pressed and held again during the halted operation, the back door will perform the reverse operation.

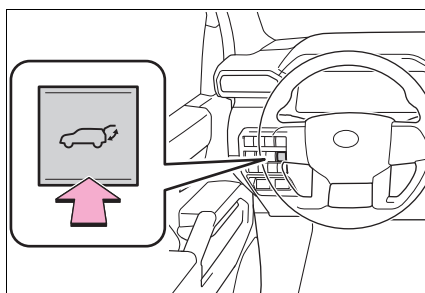

■ Using the switches on the back door

● Open

When the back door is unlocked: Press the back door opener switch.

When the back door is locked: While carrying the electronic key on your person, press and hold the back door opener switch.

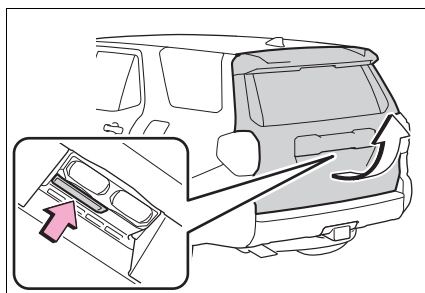

The power back door automatically opens.

Pressing the switch while the power back door is opening stops the operation.



● Close

Press the  switch on the lower part of the back door. The power back door automatically closes.

Pressing the  switch while the power back door is operating will stop the operation. When the 

switch is pressed again during the halted operation, the back door will perform the reverse operation.

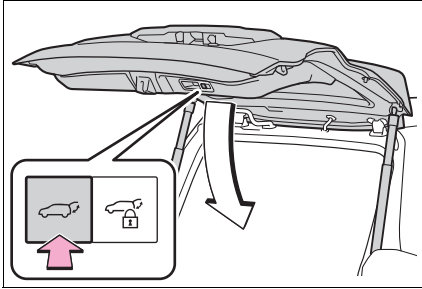

- Close the back door and lock all doors (close & lock function)

Close all of the doors except the back door, carrying an electronic key and press the  switch on the lower part of the back door.

A different buzzer than the normal one will sound and the back door will begin closing automatically. All the doors except the back door are locked and then back door will also be locked at the same time it is closed. Operation signals will indicate that all the doors have been closed and locked. (→P.120)

Pressing the  switch while the back door is operating will stop the operation. When the switch is pressed again during the halted operation, the back door will be closed.

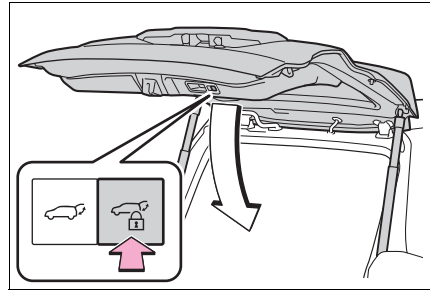

- Close the back door and lock all doors after moving away from the back door (close & lock [Walk-Away] function)*

*: This setting must be customized at your Toyota dealer.

- 1 Close all of the doors except the back door, carrying an electronic key and press the  switch on the lower part of the back door.

A different buzzer than the normal one will sound and the close & lock (Walk-Away) function will go into standby.

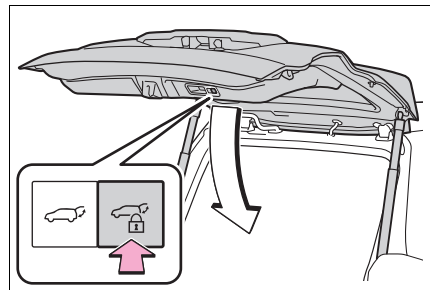

- 2 While the buzzer is sounding, move away from the back door.

When the sensor detects that you are away from the back door, the emergency flashers will flash (on some models) and the buzzer will sound.

Depending on the direction of moving away from the back door, the location and how to hold the electronic key or circumstances, it may not be detected properly.

All the doors other than the back door will be locked, and after the back door is closed, the back door will also be locked. When all the doors have been closed and locked, the buzzer will sound (on some models) and the emergency flashers will flash.

The standby state is canceled if you do not move away from the back door for 30 seconds. To operate the function again, perform the procedure again from the beginning.

If you approach the back door carrying the electronic key, the back door operation will stop, all the doors will be unlocked, and the buzzer will sound (on some models) and the emergency flashers will flash.

If the  switch is pressed after the back door operation has stopped, the close & lock (Walk-Away) function will go into standby again.

■ Using the back door handle

Lower the back door using the back door handle **A**.

The back door closing assist (→P.136) will be activated, and the power back door will fully close automatically.

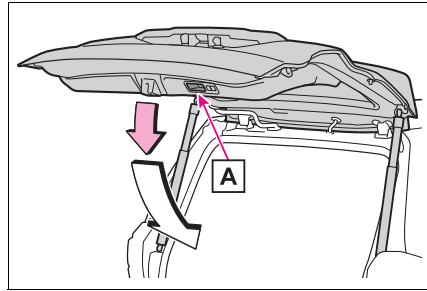

■ Using the Hands Free Power Back Door

The Hands Free Power Back Door enables automatic opening and closing of the power back door by putting your foot near the lower right part of the rear bumper and moving it away from the rear bumper. When operating the Hands Free Power Back Door, make sure that the engine switch is in OFF, the Hands Free Power Back Door operation is enabled and you are carrying an electronic key.

- 1 While carrying an electronic key, stand within the smart key system operation range, approximately 11.8 to 19.7 in. (30 to 50 cm) from the rear bumper.

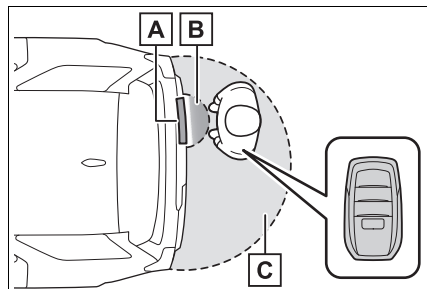

- A** Kick sensor
- B** Hands Free Power Back Door operation detection area
- C** Smart key system operation detection area (→P.146)

- 2 Perform a kick operation by moving your foot to within approximately 3.9 in. (10 cm) of the rear bumper and then pulling it back.

Perform the entire kick operation within 1 second.

The back door will not start operating while a foot is detected under the rear bumper.

Operate the Hands Free Power Back Door without contacting the rear bumper with your foot.

If another electronic key is in the cabin or luggage compartment, it may take slightly longer than normal for the operation to occur.

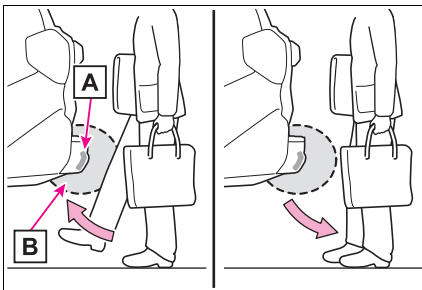

- A** Kick sensor
 - B** Hands Free Power Back Door operation detection area
- 3 When the kick sensor detects that your foot is pulled back, a buzzer will sound and the

back door will automatically fully open/close.

If a foot is moved under the rear bumper while the back door is opening/closing, the back door will stop moving.

If a foot is moved under the rear bumper again during the halted operation, the back door will perform the reverse operation.

■ Closing and locking the back door after moving away from the back door using the kick sensor (Hands Free close & lock [Walk-Away] function)*

*: This setting must be customized at your Toyota dealer.

The Hands Free Power Back Door enables automatic closing and locking of the power back door by putting your foot near the right lower part of the rear bumper, moving it away from the rear bumper, and moving away from the back door. When operating the Hands Free Power Back Door, make sure that the engine switch is in OFF, the Hands Free Power Back Door (kick sensor) operation is enabled and you are carrying an electronic key.

- 1 While carrying an electronic key, stand within the Smart key system operation range, approximately 11.8 to 19.7 in.

(30 to 50 cm) from the rear bumper.

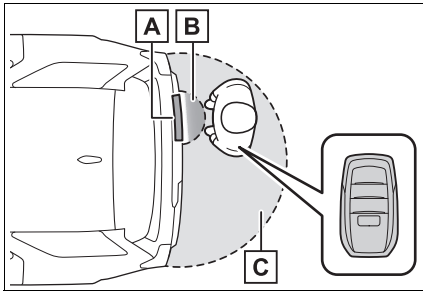

- A** Kick sensor
- B** Hands Free Power Back Door operation detection area
- C** Smart key system operation detection area (→P.146)

- 2 Perform a kick operation by moving your foot to within approximately 3.9 in. (10 cm) of the rear bumper and then pulling your foot back after the buzzer sounds.

Perform the entire kick operation within 1 second.

The back door will not start operating while a foot is detected under the rear bumper.

Operate the Hands Free Power Back Door without contacting the rear bumper with your foot.

If another electronic key is in the cabin or luggage compartment, it may take slightly longer than normal for the operation to occur.

If the buzzer sounds twice, perform

a kick operation again.

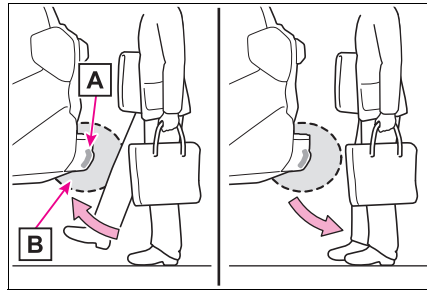

- A** Kick sensor
- B** Hands Free Power Back Door operation detection area

- 3 When the kick sensor detects that your foot is pulled back, a different buzzer than the normal one will sound and the Hands Free close & lock (Walk-Away) function will go into standby.
- 4 While the buzzer is sounding, move away from the back door.

When the sensor detects that you are away from the back door, the emergency flashers will flash (on some models), and the buzzer will sound.

Depending on the direction of moving away from the back door, the location and how to hold the electronic key or circumstances, it may not be detected properly.

All the doors other than the back door will be locked, and after the back door is closed, the back door will also be locked. When all the doors have been closed and locked, the buzzer (if equipped) will sound and the emergency flashers will flash.

The standby state is canceled if you

do not move away from the back door in 30 seconds. To operate the function again, perform the procedure again from the beginning.

If you approach the back door carrying the electronic key, the back door operation will stop, all the doors will be unlocked, and the buzzer will sound (on some models) and the emergency flashers will flash.

If the power back door is operated after the back door operation has stopped, the Hands Free close & lock (Walk-Away) function will go into standby again.

■ Luggage compartment lights

- The luggage compartment lights turn on when the back door is opened.
- When the engine switch is turned to OFF, the lights will go off automatically after 20 minutes.

■ Back door closer

In the event that the back door is left slightly open, the back door closer will automatically close it to the fully closed position.

Whatever the state of the engine switch, the back door closer operates.

■ Power back door operating conditions

The power back door can automatically open and close under the following conditions:

- When the back door window is completely closed.
- When the power back door system is enabled. (→P.144)
- When the back door is unlocked.

However, if the back door opener switch is pressed and held while carrying the electronic key on your person, the power back door will be operated even if the back door is

locked. (→P.131)

- When the engine switch is in ON, in addition to the above for the opening operations, the back door operates for any of the following conditions:

- Parking brake is engaged
- The brake pedal is depressed
- The shift lever is in P.

■ Operation of the power back door

- A buzzer sounds to indicate that the back door is opening/closing.
- When the power back door system is disabled, the power back door does not operate but it can be opened and closed by hand.
- When the power back door automatically opens, if an abnormality due to people or objects is detected, operation will stop.

■ Jam protection function

Sensors are equipped on both sides of the power back door. If anything obstructs the power back door while it is closing, the back door will automatically operate in the opposite direction or stop.

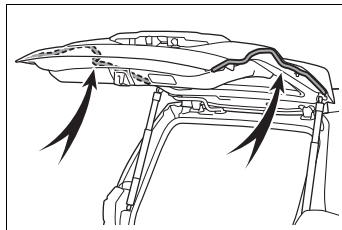

■ Fall-down protection function

While the power back door is opening automatically, applying excessive force to it will stop the opening operation to prevent the power back door from suddenly shutting.

■ Back door closing assist

If the back door is lowered manually when the back door is stopped at an open position, the back door will fully close automatically.

■ Back door reserve lock function

This function is a function which reserves locking of all doors, beforehand, when the power back door is open.

When the following procedure is performed, all the doors except the power back door are locked and then power back door will also be locked at the same time it is closed.

- 1 Close all doors, except the back door.
- 2 During the power back door closing operation, lock the doors using the smart key system (→P.119) or the wireless remote control. (→P.119)

Operation signals will indicate that all the doors have been closed and locked (→P.120).

- If the electronic key is placed inside the vehicle after starting a close operation via the door reserve lock function, the electronic key may become locked inside the vehicle.
- If the power back door does not fully close due to the operation of the jam protection function, etc., while the back door is automatically closing after a door reserve lock operation is performed, the door reserve lock function is canceled and all the doors will unlock.
- Before leaving the vehicle, make sure that all the doors are closed and locked.



■ Close & lock function operating conditions

This function can be operated when all of the following conditions are met:

- An electronic key is not detected within the vehicle.
- All of the doors other than the power back door are closed.
- The engine switch is in OFF.

■ Situations in which the close & lock function may not operate properly

In the following situations, the close & lock function may not operate properly:

- If the  switch on the lower part of the power back door is pressed by a hand which is holding an electronic key
- If the  switch on the lower part of the power back door is pressed when the electronic key is in a bag, etc. that is placed on the ground
- If the  switch on the lower part of the power back door is pressed with the electronic key not near the vehicle.

■ Close & lock (Walk-Away) function* operating conditions

This function can be operated when all of the following conditions are met:

- Close & lock (Walk-Away) function is enabled.
- An electronic key is not detected within the vehicle.
- All of the doors other than the back door are closed.
- The brake pedal is not depressed.
- The engine switch is in OFF.
- The electronic key is within the effective range (detection areas).

*: This setting can be customized by your Toyota dealer.

■ Situations in which the close & lock (Walk-Away) function* may not operate properly

*: This setting must be customized at your Toyota dealer.

In the following situations, the function may not operate properly:

- When the smart key system does not operate properly.
- When the close & lock function does not operate properly.
- When moving away from the back door while the close & lock (Walk-Away) function is in the standby state.
- When the number of electronic keys registered in the vehicle increases.

■ Hands Free Power Back Door operating conditions

The Hands Free Power Back Door will open/close automatically when the following conditions are met:

- The Hands Free Power Back Door (kick sensor) operation is enabled (→P.144)
- The engine switch is in OFF, or ON with the shift lever in P.
- The electronic key is within the operational range. (→P.146)
- A foot is put near the right lower part of the rear bumper and moved away from the rear bumper.
The power back door may also be operated by putting a hand, an elbow, a knee, etc. near the right lower part of the rear bumper and moving it away from the rear bumper. Make sure to put it close enough to the right lower part of the rear bumper.

■ Situations in which the Hands Free Power Back Door may not operate properly

In the following situations, the Hands Free Power Back Door may not operate properly:

- When a foot remains under the rear bumper
- If the rear bumper is strongly hit with a foot or is touched for a while

If the rear bumper has been touched for a while, wait for a short time before attempting to operate the

Hands Free Power Back Door again.

- When operated while a person is too close to the rear bumper
- When an external radio wave source interferes with the communication between the electronic key and the vehicle (→P.147)
- When the vehicle is parked near an electrical noise source which affects the sensitivity of the Hands Free Power Back Door, such as a pay parking spot, gas station, electrically heated road, or fluorescent light
- When the vehicle is near a TV tower, electric power plant, radio station, large display, airport or other facility that generates strong radio waves or electrical noise
- When water is applied to the rear bumper, such as when the vehicle is being washed or in heavy rain
- When mud, snow, ice, etc. is attached to the rear bumper
- When the vehicle has been parked for a while near objects that may move and contact the rear bumper, such as plants
- When an accessory is installed to the rear bumper

If an accessory has been installed, turn the Hands Free Power Back Door (kick sensor) operation setting off.

■ Preventing unintentional operation of the Hands Free Power Back Door (vehicles with Hands Free Power Back Door)

When an electronic key is in the operation range, the Hands Free Power Back Door may operate unintentionally, so be careful in the following situations.

To prevent unintentional operation, turn the Hands Free Power Back Door (kick sensor) operation setting off. (→P.144)

- When water is applied to the rear bumper, such as when the vehicle is being washed or in heavy rain
 - When dirt is wiped off the rear bumper
 - When a small animal or small object, such as a ball, moves under the rear bumper
 - When an object is moved from under the rear bumper
 - If someone is swinging their legs while sitting on the rear bumper
 - If the legs or another part of someone's body contacts the rear bumper while passing by the vehicle
 - When the vehicle is parked near an electrical noise source which affects the sensitivity of the Hands Free Power Back Door, such as a pay parking spot, gas station, electrically heated road, or fluorescent light
 - When the vehicle is near a TV tower, electric power plant, radio station, large display, airport or other facility that generates strong radio waves or electrical noise
 - When the vehicle is parked in a place where objects such as plants are near the rear bumper
 - If luggage, etc. is set near the rear bumper
 - If accessories or a vehicle cover is installed/removed near the rear bumper
 - When the vehicle is being towed
- **Hands Free close & lock (Walk-Away) function* operating conditions**

This function can be operated when all of the following conditions are met:

- Hands Free close & lock (Walk-Away) function is enabled*.
- Hands Free Power Back Door is enabled.

- An electronic key is not detected within the vehicle.
 - All of the doors other than the back door are closed.
 - The engine switch is in OFF.
 - The electronic key is within the effective range (detection areas).
- *: This setting can be customized by your Toyota dealer.

■ **Situations in which the Hands Free close & lock (Walk-Away) function* may not operate properly**

In the following situations, the function may not operate properly:

- When the smart key system does not operate properly.
- When the close & lock function does not operate properly.
- When moving away from the back door while the Hands Free close & lock (Walk-Away) function is in the standby state.
- When the number of electronic keys registered in the vehicle increases.
- When the Hands Free Power Back Door does not operate properly.*

*: This setting can be customized by your Toyota dealer.

■ **When reconnecting the battery**

To enable the power back door to operate properly, close the back door manually.

■ **If the back door opener is inoperative**

The back door can be unlocked from the inside.

- 1 Remove the cover.

To prevent damage, cover the tip of the screwdriver with a rag.

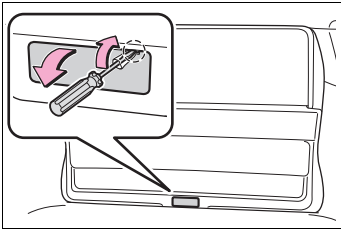

2 Loosen the screw.

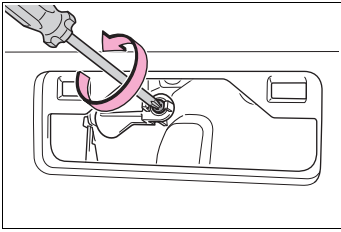

3 Turn the cover.

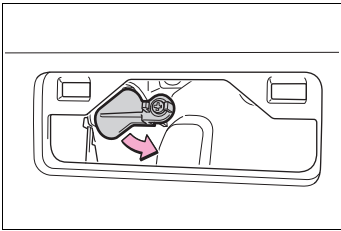

4 Move the lever.

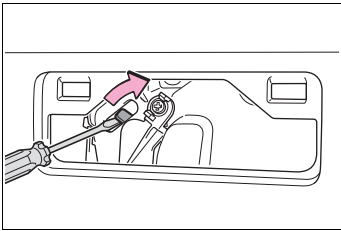

5 When installing, reverse the steps listed.

■ Customization

Some functions can be customized.
(Customizable features: →P.637)

⚠ WARNING

■ Back door closer

- In the event that the back door is left slightly open, the back door closer will automatically close it to the fully closed position. It takes several seconds before the back door closer begins to operate. Be careful not to catch fingers or anything else in the back door, as this may cause bone fractures or other serious injuries.

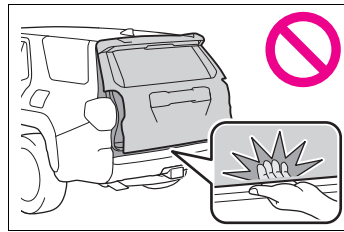

- Use caution when using the back door closer as it still operates when the power back door system is canceled.

■ Power back door

Observe the following precautions when operating the power back door. Failure to do so may cause death or serious injury.

- Check the safety of the surrounding area to make sure there are no obstacles or anything that could cause any of your belongings to get caught.
- If anyone is in the vicinity, make sure they are safe and let them know that the back door is about to open or close.

**WARNING**

- If the power back door system is turned off while the back door is operating automatically, the automatic operation is stopped. The back door then has to be operated manually. Take extra care when on an incline, as the back door may open or close unexpectedly.
- If the operating conditions of the power back door are no longer met, a buzzer may sound and the back door may stop opening or closing. The back door then has to be operated manually. Take extra care when on an incline, as the back door may open or close abruptly.
- On an incline, the back door may suddenly shut after it opens. Make sure the back door is fully open and secure.
- In the following situations, the power back door may detect an abnormality and automatic operation may be stopped. In this case, the back door has to be operated manually. Take extra care when on an incline, as the back door may open or close abruptly.
- When the back door contacts an obstacle
- When the battery voltage suddenly drops, such as when the engine switch is turned to ON or the engine is started during automatic operation

- If a bicycle carrier or similar heavy object is attached to the back door, the power back door may not operate, causing itself to malfunction, or the back door may suddenly shut again after being opened, causing someone's hands, head or neck to be caught and injured. When installing an accessory part to the back door, using a genuine Toyota part is recommended.

Jam protection function

Observe the following precautions.

Failure to do so may cause death or serious injury.

- Never use any part of your body to intentionally activate the jam protection function.
- The jam protection function may not work if something gets caught just before the back door fully closes. Be careful not to catch fingers or anything else.
- The jam protection function may not work depending on the shape of the object that is caught. Be careful not to catch fingers or anything else.

Hands Free Power Back Door

Observe the following precautions when operating the Hands Free Power Back Door.

Failure to do so may cause death or serious injury.

- Check the safety of the surrounding area to make sure there are no obstacles or anything that could cause any of your belongings to get caught.

**WARNING**

- When putting your foot near the lower right part of the rear bumper and moving it from the rear bumper, be careful not to touch the exhaust pipes until they have cooled down sufficiently, as touching hot exhaust pipes can cause burns.
- Do not leave the electronic key within the effective range (detection area) of the luggage compartment.

■ **Close & lock (Walk-Away) function and Hands Free close & lock (Walk-Away) function***

*: This setting can be customized by your Toyota dealer.

The back door starts to close automatically when leaving the back door. Check the safety of the surrounding area to make sure there are no obstacles or anything that could cause any of your belongings to get caught.

**NOTICE**

■ **Back door spindles**

The back door is equipped with spindles that hold the back door in place.

Observe the following precautions.

Failure to do so may cause damage to the back door spindle, resulting in malfunction.

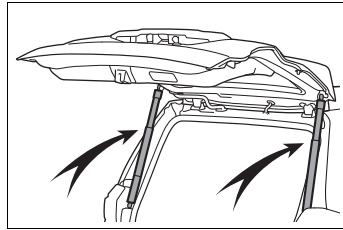

- Do not attach any foreign objects, such as stickers, plastic sheets, or adhesives to the spindle rod.
- Do not attach any accessories other than genuine Toyota parts to the back door.
- Do not place your hand on the spindle or apply lateral forces to it.

■ **To prevent back door closer malfunction**

Do not apply excessive force to the back door while the back door closer is operating. Applying excessive force may cause the back door closer to malfunction.

■ **To prevent damage to the power back door**

- Make sure that there is no ice between the back door and frame that would prevent movement of the back door. Operating the power back door when excessive load is present on the back door may cause a malfunction.

**NOTICE**

- Do not apply excessive force to the back door while the power back door is operating.
- Take care not to damage the sensors (installed on the right and left edges of the power back door) with a knife or other sharp object. If the sensor is disconnected, the power back door will not close automatically.

■ Close & lock function

When closing the power back door using the close & lock function, a different buzzer than the normal one will sound before the operation begins.

To check that the operation has started correctly, check that a different buzzer than the normal one has sounded.

Additionally, when the power back door is fully closed and locked, operation signals will indicate that all of the doors have been locked.

Before leaving the vehicle, make sure that the operation signals have operated and that all of the doors are locked.

■ Hands Free Power Back Door precautions

The kick sensor is located behind lower right part of the rear bumper. Observe the following to ensure that the Hands Free Power Back Door function operates properly:

- Keep the lower right part of the rear bumper clean at all times. If the lower right part of the rear bumper is dirty or covered with snow, the Hands Free Power Back Door may not operate. In this situation, clean off the dirt or snow, move the vehicle from the current position and then check if the Hands Free Power Back Door operates. If it does not operate, have the vehicle inspected by your Toyota dealer.
- Do not apply coatings that have a rain clearing (hydrophilic) effect, or other coatings, to the lower right part of the rear bumper.
- Do not park the vehicle near objects that may move and contact the lower right part of the rear bumper, such as grass or trees. If the vehicle has been parked for a while near objects that may move and contact the lower right part of the rear bumper, such as grass or trees, the Hands Free Power Back Door may not operate. In this situation, move the vehicle from the current position and then check if the Hands Free Power Back Door operates. If it does not operate, have the vehicle inspected by your Toyota dealer.

**NOTICE**

- Do not subject the rear bumper or its surrounding area to a strong impact. If the rear bumper or its surrounding area has been subjected to a strong impact, the Hands Free Power Back Door may not operate properly. If the Hands Free Power Back Door does not operate in the following situations, have the vehicle inspected by your Toyota dealer.
 - The kick sensor or its surrounding area has been subjected to a strong impact.
 - The lower right part of the rear bumper is scratched or damaged.
- Do not disassemble the rear bumper.
- Do not attach stickers to the rear bumper.
- Do not paint the rear bumper.
- If a bicycle carrier or similar heavy object is attached to the power back door, disable the Hands Free Power Back Door (kick sensor). (→P.144)

Changing settings of the power back door system (vehicles with power back door)

The settings of the power back door system can be changed by displaying the “Vehicle Settings”  screen from the setting screen of the multi-information display. (→P.637)

The changed power back door settings are not reset by turning the engine switch to OFF. In order to restore the original settings, they need to be changed back on the setting screen of the multi-information display.

Adjusting the open position of the back door (vehicles with power back door)

The open position of the power back door can be adjusted.

- 1 Stop the back door in the desirable position. (→P.130)
- 2 Press and hold the switch on the lower part of the back door for approximately 2 seconds.

When the settings are completed, the buzzer sounds 4 times.

When opening the back door the next time, the back door will stop at that position.

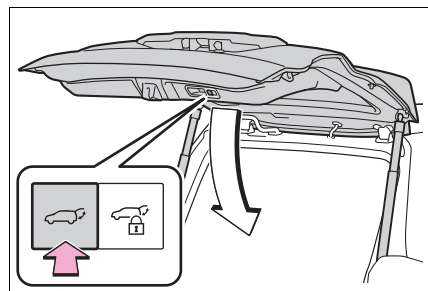

Canceling the adjusted open position of the back door

Press and hold the switch on the lower part of the back door for approximately 7 seconds.

After the buzzer sounds 4 times, it sounds twice more. When the

power back door does the opening operation the next time, the door will open to the initial settings position.

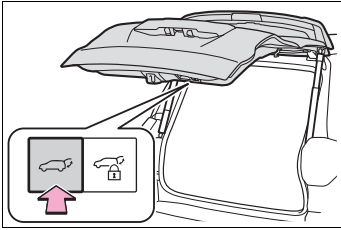

■ Customization

The opening position can be set with the multi-information display. (→P.637)

Priority for the stop position is given to the last position set by either the switch on the lower part of the back door or multi-information display.

Rear step bumper

The rear step bumper is intended for rear end protection and easier step-up loading.

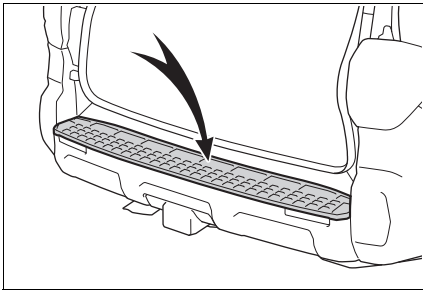

Smart key system

The following operations can be performed simply by carrying the electronic key on your person, for example in your pocket. The driver should always carry the electronic key.

- Locks and unlocks the doors (→P.119)
- Locks and unlocks the back door (→P.119)
- Starts the engine (→P.218)

■ Antenna location

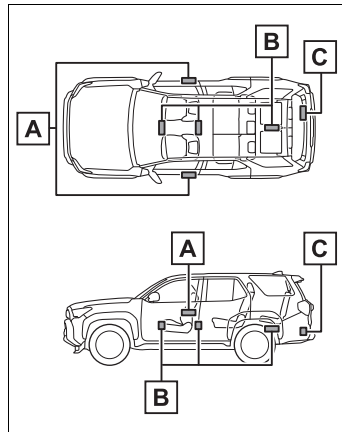

- A** Antennas outside the cabin
- B** Antennas inside the cabin
- C** Antenna outside the luggage compartment

■ **Effective range (areas within which the electronic key is detected)**

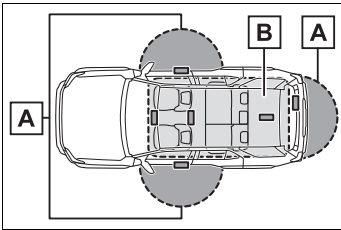

A When locking or unlocking the doors

The system can be operated when the electronic key is within about 2.3 ft. (0.7 m) of an outside door handle. (Only the doors detecting the key can be operated.)

B When starting the engine or changing engine switch modes

The system can be operated when the electronic key is inside the vehicle.

■ **If an alarm sounds or a warning message is displayed**

An alarm sounds and warning message displays shown on the multi-information display are used to protect against unexpected accidents or theft of the vehicle resulting from erroneous operation. When a warning message is displayed, take appropriate measures based on the displayed message.

When only an alarm sounds, circumstances and correction procedures are as follows.

- When an exterior alarm sounds once for 5 seconds

Situation	Correction procedure
An attempt was made to lock the vehicle while a door was open.	Close all of the doors and lock the doors again.

- When an interior alarm sounds continuously

Situation	Correction procedure
The engine switch was turned to ACC while the driver's door was open (or the driver's door was opened when the engine switch was in ACC).	Turn the engine switch off and close the driver's door.

■ **If “Smart Key System malfunction See owner’s manual” is displayed on the multi-information display**

The system may be malfunctioning. Have the vehicle inspected by Toyota dealer immediately.

■ **If “Key Detected in Vehicle” is shown on the multi-information display**

An attempt was made to lock the doors using the smart key system while the electronic key was still inside the vehicle. Retrieve the electronic key from the vehicle and lock the doors again.



■ **Battery-saving function**

The battery-saving function will be activated in order to prevent the electronic key battery and the battery from being discharged while the vehicle is not in operation for a long time.

- In the following situations, the smart key system may take some time to unlock the doors. Also the illuminated entry system may not operate properly.
- The electronic key is left in the vicinity of the vehicle for a certain period of time.
- The smart key system has not been used for 5 days or longer.
- If the smart key system has not been used for 14 days or longer, the doors cannot be unlocked at any doors except the driver's door. In this case, take hold of the driver's door handle, or use the wireless remote control or the mechanical key, to unlock the doors.

■ Turning an electronic key to battery-saving mode

- When battery-saving mode is set, battery depletion is minimized by stopping the electronic key from receiving radio waves.

Press  twice while pressing and holding . Confirm that the electronic key indicator flashes 4 times. While the battery-saving mode is set, the smart key system cannot be used. To cancel the function, press any of the electronic key buttons.

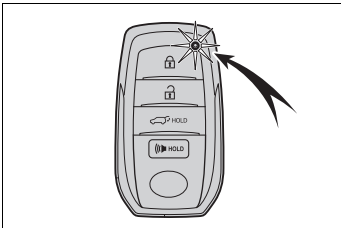

- Electronic keys that will not be used for long periods of time can be set to the battery-saving mode in advance.

■ When electronic key function stops

If the position of the electronic key has not changed for a certain amount of time such as when the electronic key is left somewhere, the function of the electronic key stops to reduce depletion of the battery.

In this case, function can automatically be restored by moving the position of the key such as by lifting it up.

■ Conditions affecting operation

The smart key system uses weak radio waves. In the following situations, the communication between the electronic key and the vehicle may be affected, preventing the smart key system, wireless remote control and engine immobilizer system from operating properly.

- When the electronic key battery is depleted
- Near a TV tower, electric power plant, gas station, radio station, large display, airport or other facility that generates strong radio waves or electrical noise
- When the electronic key is in contact with, or is covered by the following metallic objects
 - Cards to which aluminum foil is attached
 - Cigarette boxes that have aluminum foil inside
 - Metallic wallets or bags
 - Coins
 - Hand warmers made of metal
 - Media such as CDs and DVDs
- When other wireless key (that emits radio waves) is being used nearby
- When carrying the electronic key together with the following devices that emit radio waves
 - Portable radio, cellular phone, cordless phone or other wireless communication devices
 - Another electronic key or a wireless key that emits radio waves

- Personal computers or personal digital assistants (PDAs)
- Digital audio players
- Portable game systems
- If window tint with a metallic content or metallic objects are attached to the rear window
- When the electronic key is placed near a battery charger or electronic devices
- When the vehicle is parked in a pay parking spot where radio waves are emitted.

If the doors cannot be locked/unlocked using the smart key system, lock/unlock the doors by performing any of the following:

- Bring the electronic key close to either front door handle and operate the entry function.
- Operate the wireless remote control. If the doors cannot be locked/unlocked using the above methods, use the mechanical key. (→P.606)

If the engine cannot be started using the smart key system, refer to P.607.

■ Note for the entry function

- Even when the electronic key is within the effective range (detection areas), the system may not operate properly in the following cases:
 - The electronic key is too close to the window or outside door handle, near the ground, or in a high place when the doors are locked or unlocked.
 - The electronic key is on the instrument panel, or floor, or in the door pockets or glove box when the engine is started or engine switch modes are changed.
 - The electronic key is blocked by a body between the electronic key and the vehicle when the door is unlocked.
- Do not leave the electronic key on top of the instrument panel or near

the door pockets when exiting the vehicle. Depending on the radio wave reception conditions, it may be detected by the antenna outside the cabin and the door will become lockable from the outside, possibly trapping the electronic key inside the vehicle.

- As long as the electronic key is within the effective range, the doors may be locked or unlocked by anyone. However, only the doors detecting the electronic key can be used to unlock the vehicle.
- Even if the electronic key is not inside the vehicle, it may be possible to start the engine if the electronic key is near the window.
- The doors may unlock if a large amount of water splashes on the door handle, such as in the rain or in a car wash, when the electronic key is within the effective range. (The doors will automatically be locked after approximately 60 seconds if the doors are not opened and closed.)
- If the wireless remote control is used to lock the doors when the electronic key is near the vehicle, there is a possibility that the door may not be unlocked by the entry function. (Use the wireless remote control to unlock the doors.)
- Touching the door lock sensor while wearing gloves may delay or prevent lock operation. Remove the gloves and touch the lock sensor again.
- When the lock operation is performed using the lock sensor, recognition signals will be shown up to two consecutive times. After this, no recognition signals will be given.
- If the door handle becomes wet while the electronic key is within the effective range, the door may lock and unlock repeatedly. In this case, follow the following correction procedures to wash the vehi-

- cle:
- Place the electronic key in a location 6 ft. (2 m) or more away from the vehicle. (Take care to ensure that the key is not stolen.)
 - Set the electronic key to battery-saving mode to disable the smart key system. (→P.147)
 - If the electronic key is inside the vehicle and a door handle becomes wet during a car wash, a message may be shown on the multi-information display and a buzzer will sound outside the vehicle. To turn off the alarm, lock all the doors.
 - The lock sensor may not work properly if it comes into contact with ice, snow, mud, etc. Clean the lock sensor and attempt to operate it again.
 - A sudden approach to the effective range or door handle may prevent the doors from being unlocked. In this case, return the door handle to the original position and check that the doors unlock before pulling the door handle again, or use the lock sensor on the lower part of the door handle.
 - If there is another electronic key in the detection area, it may take slightly longer to unlock the doors after the door handle is gripped.
- **When the vehicle is not driven for extended periods**
- To prevent theft of the vehicle, do not leave the electronic key within 6 ft. (2 m) of the vehicle.
 - The smart key system can be deactivated in advance.
 - Setting the electronic key to battery-saving mode helps to reduce key battery depletion. (→P.147)
- **To operate the system properly**
- Make sure to carry the electronic key when operating the system. Do not get the electronic key too close to the vehicle when operating the system from the outside of

the vehicle.

- Depending on the position and holding condition of the electronic key, the key may not be detected correctly and the system may not operate properly. (The alarm may go off accidentally, or the door lock prevention function may not operate.)

■ **If the smart key system does not operate properly**

- Locking and unlocking the doors: →P.606
- Starting the engine: →P.607

■ **Customization**

Some functions can be customized. (→P.637)

■ **If the smart key system has been deactivated in a customized setting**

- Locking and unlocking the doors: Use the wireless remote control or mechanical key. (→P.119, 606)
- Starting the engine and changing engine switch modes: →P.607
- Stopping the engine: →P.219

■ **Certification**

→P.687

**WARNING****■ Caution regarding interference with electronic devices**

- People with implantable cardiac pacemakers, cardiac resynchronization therapy-pacemakers or implantable cardioverter defibrillators should keep away from the smart key system antennas. (→P.145)
The radio waves may affect the operation of such devices. If necessary, the entry function can be disabled. Ask your Toyota dealer for details, such as the frequency of radio waves and timing of the emitted radio waves. Then, consult your doctor to see if you should disable the entry function.
- Users of any electrical medical device other than implantable cardiac pacemakers, cardiac resynchronization therapy-pacemakers or implantable cardioverter defibrillators should consult the manufacturer of the device for information about its operation under the influence of radio waves.
Radio waves could have unexpected effects on the operation of such medical devices.

Ask your Toyota dealer for details on disabling the entry function.

Front seats

The seats can be adjusted (longitudinally, vertically, etc.). Adjust the seat to ensure the correct driving posture.

Adjustment procedure

▶ Manual seat (if equipped)

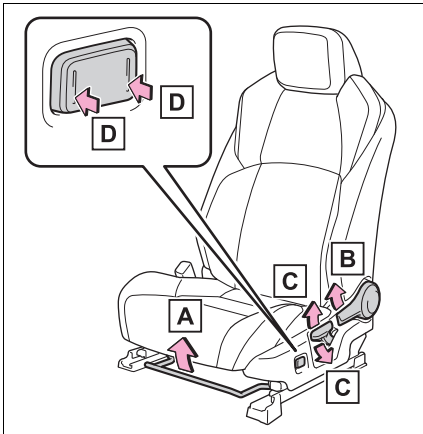

- A** Seat position adjustment lever
- B** Seatback angle adjustment lever
- C** Vertical height adjustment lever
- D** Seat lumbar support adjustment switch (driver's seat only)

▶ Power seat (if equipped)

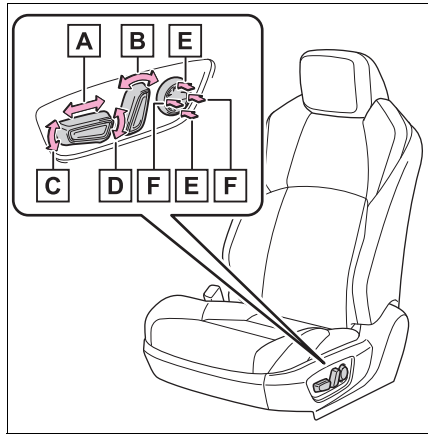

- A** Seat position adjustment switch
- B** Seatback angle adjustment switch
- C** Seat cushion (front) angle adjustment switch
- D** Vertical height adjustment switch
- E** Lumbar support height adjustment switch
- F** Lumbar support adjustment switch

■ When adjusting the seat

- Make sure that any surrounding passengers or objects are not contact the seat.
- Take care when adjusting the seat so that the head restraint does not touch the ceiling.

■ Power easy access system (if equipped)

The driver's seat and steering wheel move in accordance with engine switch mode and the driver's seat belt condition. (→P.186)

⚠ WARNING

■ **When adjusting the seat position**

- Take care when adjusting the seat position to ensure that other passengers are not injured by the moving seat.
- Do not put your hands under the seat or near the moving parts to avoid injury. Fingers or hands may become jammed in the seat mechanism.
- Make sure to leave enough space around the feet so they do not get stuck.

■ **Seat adjustment**

- To reduce the risk of sliding under the lap belt during a collision, do not recline the seat more than necessary. If the seat is too reclined, the lap belt may slide past the hips and apply restraint forces directly to the abdomen, or your neck may contact the shoulder belt, increasing the risk of death or serious injury in the event of an accident. Adjustments should not be made while driving as the seat may unexpectedly move and cause the driver to lose control of the vehicle.
- Manual seat only: After adjusting the seat, make sure that the seat is locked in position.

Rear seats

Adjustment procedure

■ **Second seats**

Pull the lever and adjust the seatback angle.

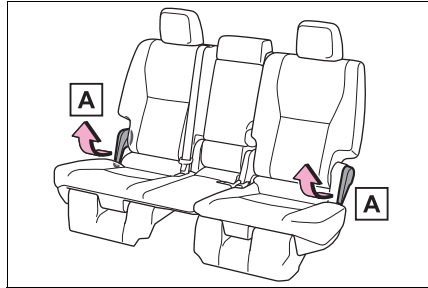

A Seatback angle adjustment lever

■ **Third seats (if equipped)**

Pull the lever and adjust the seatback angle.

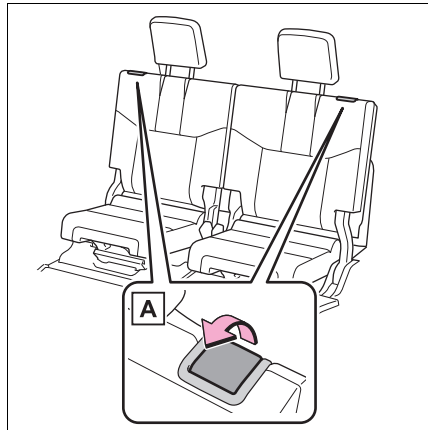

A Seat position adjustment lever

⚠ WARNING

■ **When operating the seatback**

Observe the following precautions. Failure to do so may cause death or serious injury.

- Keep other passengers from being hit with the seatback.
- Do not bring your hands close to the moving parts or between the seats, as well as do not let any part of your body get caught.
- After adjusting the seat, make sure that the seat is locked in position.

■ **Adjusting the reclining angle**

Do not fold the seatback more than required. During a collision, your body could slip beneath the seat belt resulting in extreme pressure being applied to your abdomen, or the shoulder belt could wrap around your neck, which may result in death or serious injury.

When entering and exiting the third seat (if equipped)

For easy access to the third seat, perform step 1 in “Tumbling the second seats”. (→P.153)

When tumbling the second seats

■ **Before tumbling the second seats**

- 1 Lower the head restraints to the lowest position. (→P.158)

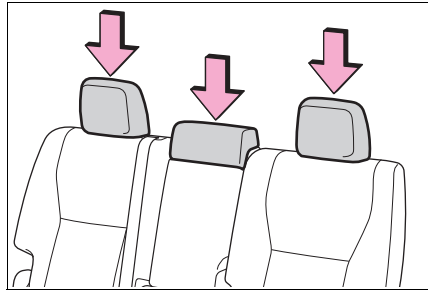

- 2 Stow the seat belt buckles (second center seat and second left side seat).

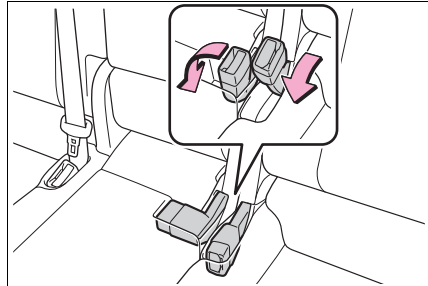

- 3 Stow the armrest. (→P.489)
- 4 Adjust the front seat so that it does not interfere with the second seat. (→P.151)

■ **Tumbling the second seats**

- 1 Pull the seatback adjustment lever **A** or tumble lever **B** (vehicle with third seats) on the seatback of the second seat.

The seatback is folded forward and the seat springs up.

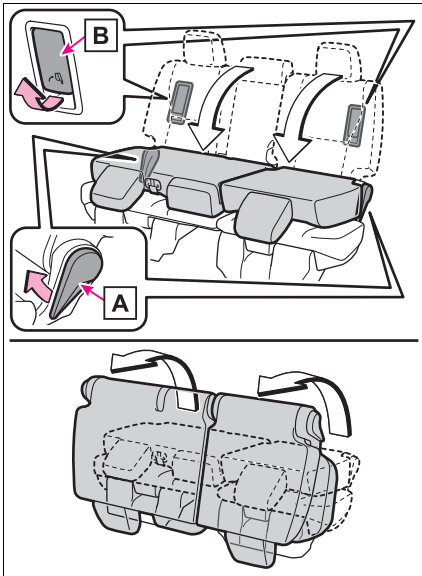

cushion, and install them on the seat hooks.

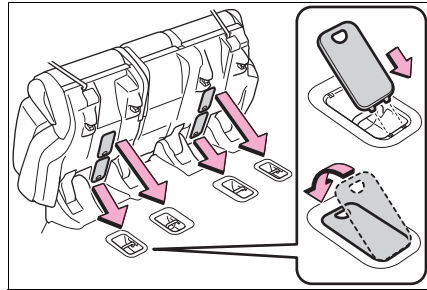

■ **Returning the second seat to its original position**

- 1 Remove the seat hook covers from the seat hooks, and return them to their original positions.

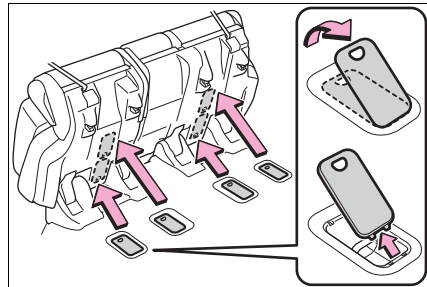

- 2 Vehicles without third seats: Open the cover on the back of the seat cushion and take out the tumble band, and attach the tumble band to the assist grip.

Pass the tumble band through the assist grip, attach the hook to the band and tighten the tumble band. After securing the seat, close the tumble band cover.

- 2 Vehicles without third seats: Remove the tumble band from the assist grip.

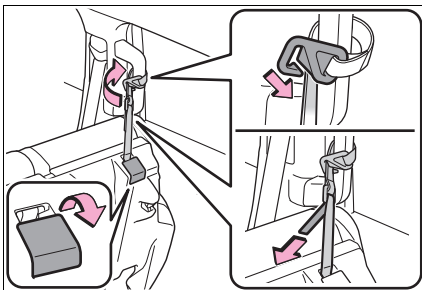

- 3 Remove the seat hook covers from the back of the seat

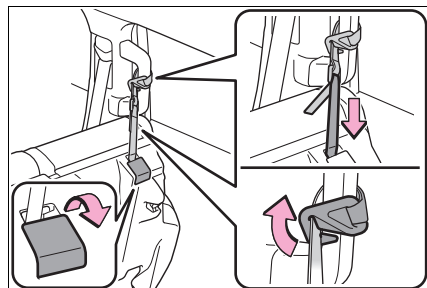

If removing from the assist grip is difficult, loosen the band.

- 3** Vehicles without third seats:
Stow the tumble band to its original position, and then close the cover.

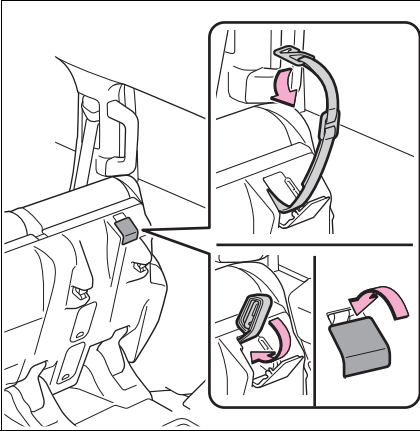

- 4** Return the seat to its original position.

Push the seat until it is locked.

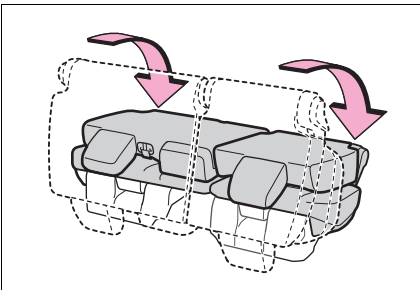

- 5** Return the seatback securely to the locked position.

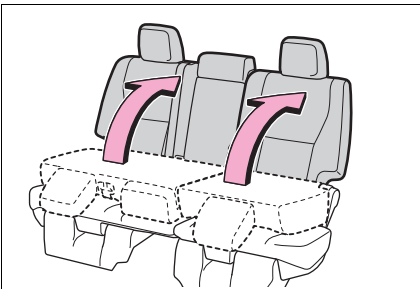

⚠ WARNING

■ When tumbling the second seat

Observe the following precautions. Failure to do so may result in death or serious injury.

- Do not tumble the seat while driving.
- Stop the vehicle on level ground, set the parking brake and shift the shift lever to P.
- Check that there is no luggage and that there are no other people around the seat before tumbling operation.
- Do not insert hands or feet into the moving parts of the seat.
- Do not allow children to operate the seat.

■ After tumbling the second seat

- Do not allow anyone to sit on a folded seatback or in the luggage compartment while driving.
- Do not allow children to enter the luggage compartment.
- Be sure to secure the seat using the tumble band after tumbling the second seat. If the seat is not secured, the seat may return while driving, resulting in serious injury.
- Be sure to install the seat hook covers on the seat hooks, or you may get burned when they become hot.

⚠ WARNING

■ **When returning the second seat to its original position**

- Make sure the seat legs are securely latched to the floor when putting back the seats.

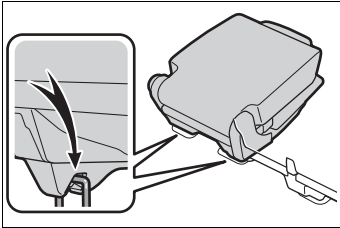

- When returning the second seat to the original position, be careful not to get hand, foot or any luggage caught between the second seat and the floor.

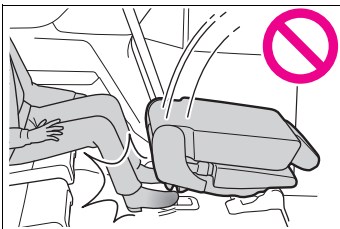

■ **After returning the second seat to its original position**

- Gently shake the second seat to the front and rear and check that it is secure.
- Do not pinch the seat belt.

When stowing the third seat (if equipped)

■ **Before stowing the third seats**

- 1 Pass the seat belts through the seat belt hangers and secure the seat belt plates.

This prevents the shoulder belt

from being damaged.

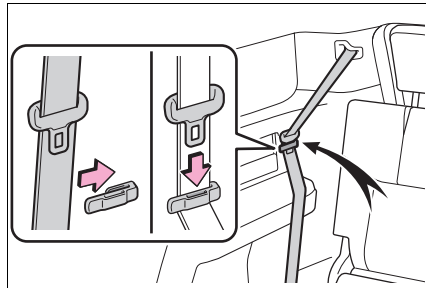

- 2 Adjust the seatback of the second seat so that it does not interfere with the third seat. (→P.152)

■ **Stowing the third seats**

- 1 Pull the strap **A** fold down to the head restraint.

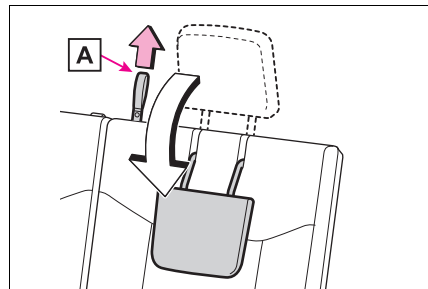

- 2 Pull the strap **A** or the seatback adjustment lever **B** on the seatback of the third seat and fold the seatback.

The seat cushion is stowed into the

floor when the seatback is folded.

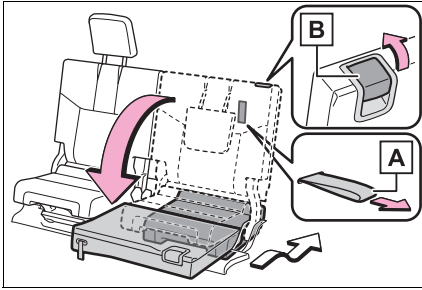

■ **Returning the third seat to its original position**

- 1 Pull the strap **A** and return the seatback securely to the locked position.

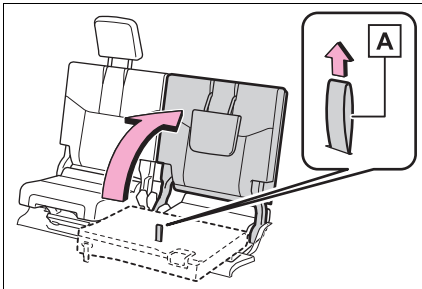

- 2 Pull the grip and pull out the seat cushion.

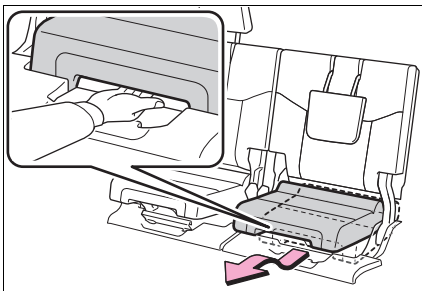

- 3 Raise the head restraint.

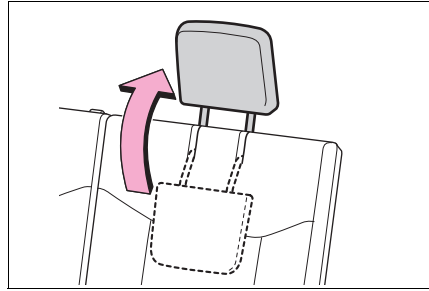

- 4 Remove the seat belt from the seat belt hanger before using the third seat.

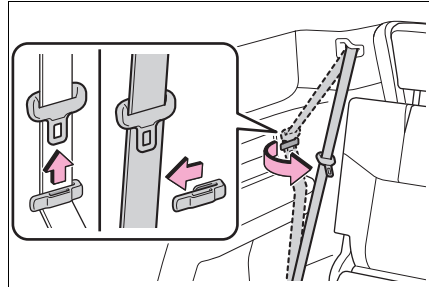

⚠ WARNING

■ **When stowing the third seats**

Observe the following precautions.

Failure to do so may result in death or serious injury.

- Check that there is no luggage and that there are no other people around the seat before stowing operation.
- Conduct the procedure slowly and carefully.
- Do not insert hands or feet into the moving parts of the seat.
- Do not allow children to operate the seat.
- Do not use the seat if only the seat cushion has been stowed.

⚠ WARNING

- **After returning the third seat to its original position**
- Gently shake the third seat to the front and rear and check that it is secure.
- Do not pinch the seat belt.
- Make sure that the seat belt is removed from the hanger as before.

Head restraints

Head restraints are provided for all seats.

⚠ WARNING

■ **Head restraint precautions**

Observe the following precautions regarding the head restraints. Failure to do so may result in death or serious injury.

- Use the head restraints designed for each respective seat.
- Adjust the head restraints to the correct position at all times.
- After adjusting the head restraints, push down on them and make sure they are locked in position.
- Do not drive with the head restraints removed.
- Vehicles with third seat: When sitting on the third seat, make sure that the head restraint is not folded.

Adjusting a head restraint

■ **Front seats and outboard second seats**

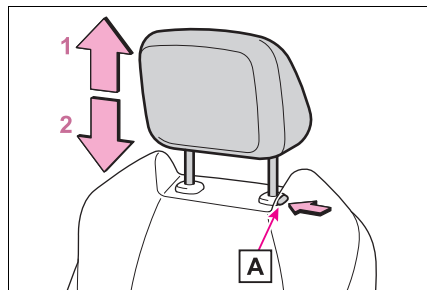

1 Up

Pull the head restraints up.

2 Down

Push the head restraint down while pressing the lock release button **A**.

■ **Second center seat**

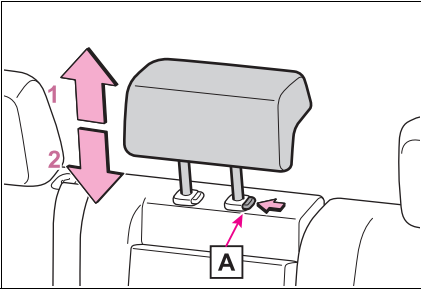

1 Up

Pull the head restraints up.

2 Down

Push the head restraint down while pressing the lock release button **A**.

■ **Third seats (vehicle with third seats)**

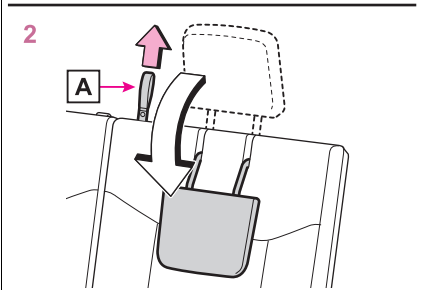
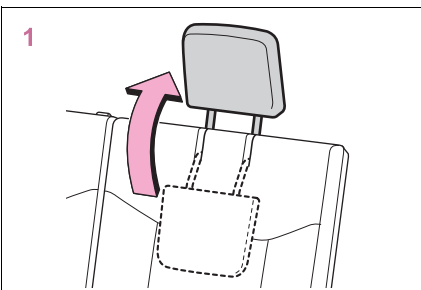

1 To use

Lift up the head restraint until it locks.

2 To fold

Pull the strap **A** to fold the head restraint.

■ **Adjusting the height of the head restraints (front seats and outboard second seats)**

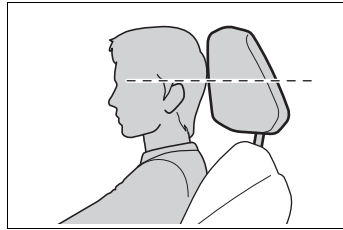

Make sure that the head restraints are adjusted so that the center of the head restraint is closest to the top of your ears.

■ **Adjusting the second center seat head restraint**

Always raise the head restraint one level from the stowed position when using.

Removing the head restraints

■ **Front seats and outboard second seats**

Pull the head restraint up while pressing the lock release button **A**.

If the head restraint touches the ceiling, making the removal difficult, change the seat height or angle. (→P.151, 152)

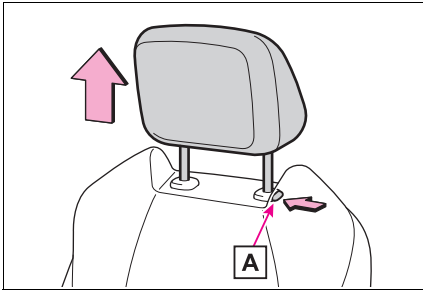

■ **Second center seat**

Lift the head restraint while pressing both of the release buttons **A** and **B**.

If the head restraint touches the ceiling, making the removal difficult, change the seat angle. (→P.152)

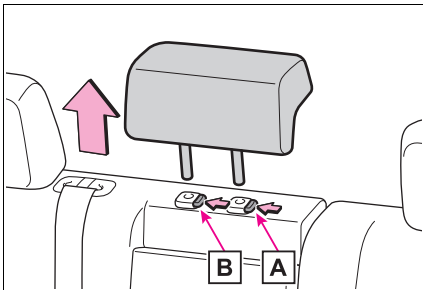

■ **Third seats (if equipped)**

The head restraint cannot be removed.

Installing the head restraints

■ **Front seats and outboard second seats**

Align the head restraint with the installation holes and push it down to the lock position.

Press and hold the lock release button **A** when lowering the

head restraint.

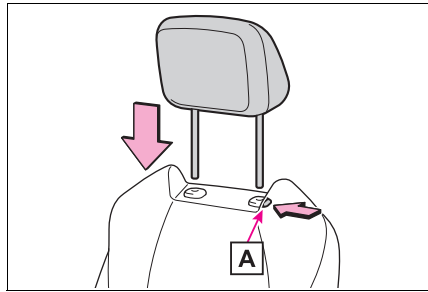

■ **Second center seat**

Align the head restraint with the installation holes and push it down to the lock position.

Press and hold the lock release button **A** when lowering the head restraint.

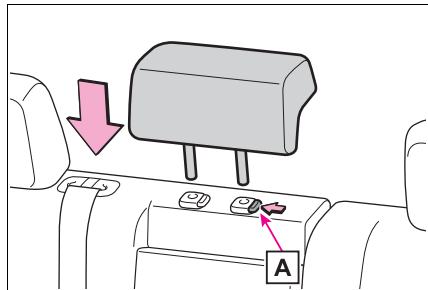

Steering wheel

Adjustment procedure

► Manual adjustment type

- 1 Hold the steering wheel and push the lever down.

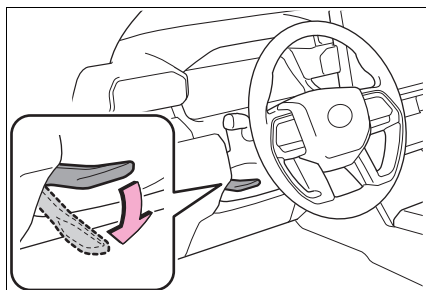

- 2 Adjust to the ideal position by moving the steering wheel horizontally and vertically.

After adjustment, pull the lever up to secure the steering wheel.

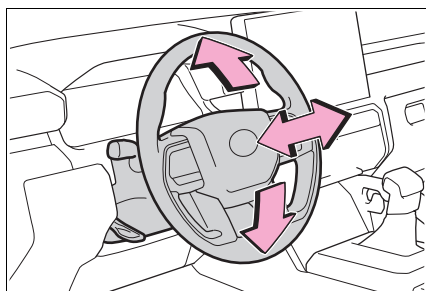

► Power adjustment type

Operating the switch moves the steering wheel in the following directions:

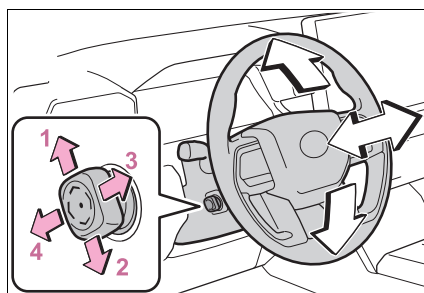

- 1 Up
- 2 Down
- 3 Toward the driver
- 4 Away from the driver

■ **The steering wheel can be adjusted when (power adjustment type)**

The engine switch is in ACC or ON*.

*: If the driver's seat belt is fastened, the steering wheel can be adjusted regardless of engine switch mode.

■ **Automatic adjustment of the steering position (if equipped)**

A desired steering position can be entered to memory and recalled automatically by the driving position memory system. (→P.186)

■ **Power easy access system (if equipped)**

The steering wheel and driver's seat move in accordance with engine switch mode and the driver's seat belt condition. (→P.186)

■ **After adjusting the steering wheel (manual adjustment type)**

Make sure that the steering wheel is securely locked.

The horn may not sound if the steering wheel is not securely locked.

■ **Customization**

Some functions can be customized. (→P.637)

WARNING

■ Caution while driving

Do not adjust the steering wheel while driving.

Doing so may cause the driver to mishandle the vehicle and cause an accident, resulting in death or serious injury.

■ After adjusting the steering wheel (manual adjustment type)

Make sure that the steering wheel is securely locked. Otherwise, the steering wheel may move suddenly, possibly causing an accident, resulting in death or serious injury.

Sounding the horn

Press on or close to the  mark.

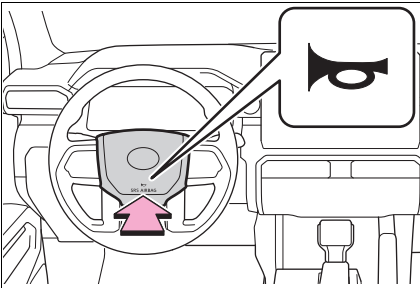

Inside rear view mirror*

*: If equipped

The rear view mirror's position can be adjusted to enable sufficient confirmation of the rear view.

Adjusting the height of rear view mirror

The height of the rear view mirror can be adjusted to suit your driving posture.

Adjust the height of the rear view mirror by moving it up and down.

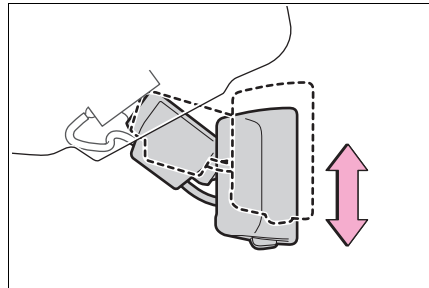

WARNING

■ Caution while driving

Do not adjust the position of the mirror while driving. Doing so may lead to mishandling of the vehicle and cause an accident, resulting in death or serious injury.

Anti-glare function

- ▶ Manual anti-glare inside rear view mirror Reflected light from the headlights of vehicles behind can be reduced by operating the lever.

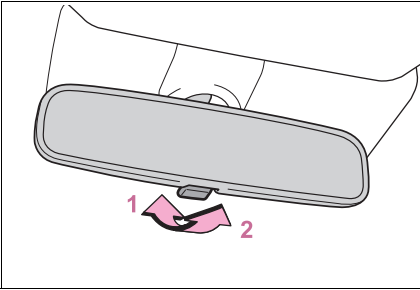

- 1 Normal position
- 2 Anti-glare position

- ▶ Auto anti-glare inside rear view mirror

Responding to the level of brightness of the headlights of vehicles behind, the reflected light is automatically reduced.

■ To prevent sensor error (vehicles with an auto anti-glare inside rear view mirror)

To ensure that the sensors operate properly, do not touch or cover them.

- ▶ Type A

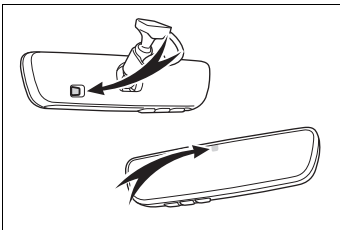

- ▶ Type B

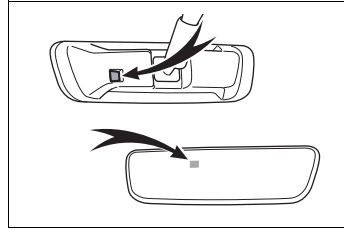

Digital Rear-view Mirror*

*: If equipped

The Digital Rear-view Mirror is a system that uses the camera on the rear of the vehicle and displays its image on the display of the Digital Rear-view Mirror.

The Digital Rear-view Mirror can be changed between optical mirror mode and digital mirror mode by operating the lever.

The Digital Rear-view Mirror allows the driver to see the rear view despite obstructions, such as the head restraints or luggage, ensuring rear visibility. Also, the rear seats are not displayed and privacy of the passengers is enhanced.



WARNING

Observe the following precautions.

Failure to do so may result in death or serious injury.

■ Before using the Digital Rear-view Mirror

- Make sure to adjust the mirror before driving. (→P.166)
- Change to optical mirror mode and adjust the position of the Digital Rear-view Mirror so that the area behind your vehicle can be viewed properly.

- Change to digital mirror mode and adjust the display settings.
- As the range of the image displayed by the Digital Rear-view Mirror is different from that of the optical mirror, make sure to check this difference before driving.

System components

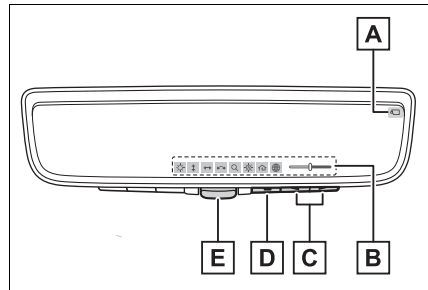

A Camera indicator

Indicates that the camera is operating normally.

B Icon display area

Displays icons, adjusting gauge, etc. (→P.166)

C Select/adjust button

Press to change the setting of the item you want to adjust.

D Menu button

Press to display the icon display area and select the item you want to adjust.

E Lever

Operate to change between digital mirror mode and optical mirror mode.

Changing modes

Operate the lever to change between digital mirror mode and optical mirror mode.

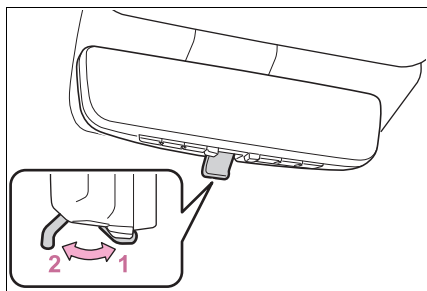

1 Digital mirror mode

Displays an image of the area behind the vehicle.

 will illuminate in this mode.

2 Optical mirror mode

Turns off the display of the Digital Rear-view Mirror allows it to be used as an optical mirror.

■ Digital mirror mode operating condition

The engine switch is turned to ON. When the engine switch is changed from ON to OFF or ACC, the image will disappear after several seconds.

■ When using the Digital Rear-view Mirror in digital mirror mode

- If it is difficult to see the displayed image due to light reflected off the Digital Rear-view Mirror, the camera being dirty, or if lights of a vehicle behind your vehicle or the displayed image are bothering you, change to optical mirror mode.
- When the back door is open, the Digital Rear-view Mirror image may not display properly. Before driving, make sure the back door

is closed.

- If the display is difficult to see due to reflected light, close the sunshade for the moon roof (if equipped)
- Any of the following conditions may occur when driving in the dark, such as at night. None of them indicates that a malfunction has occurred.
 - Colors of objects in the displayed image may differ from their actual color.
 - Depending on the height of the lights of the vehicle behind, the area around the vehicle may appear white and blurry.
 - Automatic image adjustment for brighter surrounding image may cause flickering.

If it is difficult to see the displayed image or flickering bothers you, change to optical mirror mode.

- The Digital Rear-view Mirror may become hot while it is in digital mirror mode. This is not a malfunction.
- Depending on your physical condition or age, it may take longer than usual to focus on the displayed image. In this case, change to optical mirror mode.
- Do not let passengers stare at the displayed image when the vehicle is being driven, as doing so may cause motion sickness.

■ When the system malfunctions

If the symbol shown in the illustration is displayed when using the Digital Rear-view Mirror in digital mirror mode, the system may be malfunctioning. The symbol will disappear in a few seconds. Operate the lever, change to optical mirror mode and have the vehicle inspected by your Toyota dealer.

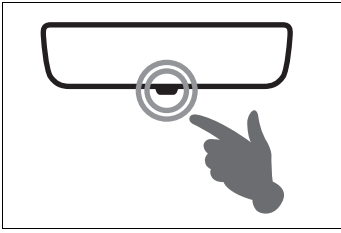

Adjusting the mirror

■ **Adjusting the mirror height**

The height of the rear view mirror can be adjusted to suit your driving posture.

Change to optical mirror mode, adjusting the height of the rear view mirror by moving it up and down.

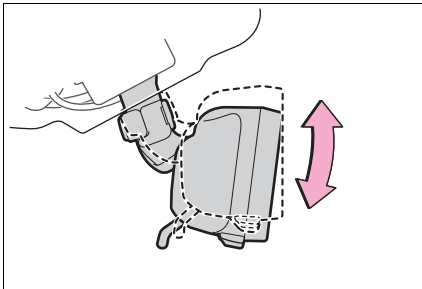

■ **Display settings (digital mirror mode)**



Settings of the display in the digital mirror mode, on/off operation of the automatic anti-glare function, etc. can be changed.

1 Press the menu button.

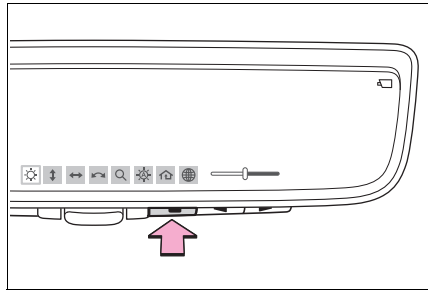



The icons will be displayed.





2 Press the menu button repeatedly and select the item you want to adjust.

3 Press  or  to change the setting.

The icons will disappear if a button is not operated for approximately 5 seconds or more.

Icons	Settings
	Select to adjust the brightness of the display.
	Select to adjust the area displayed up/down.
	Select to adjust the area displayed to the left/right.
	Select to adjust the angle of the displayed image.
	Select to zoom in/out the displayed image.

Icons	Settings
	<p>Select to enable/disable the automatic anti-glare function.*</p> <p>Responding to the brightness of the headlights of vehicles behind, the reflected light is automatically adjusted.</p> <p>The automatic anti-glare function is enabled each time the engine switch is changed to ON.</p>
	<p>Select to display HomeLink® Training Tutorial to assist customers to train their Garage Door Opener System. (→P.504)</p>
	<p>Select to change the language of the HomeLink® Training Tutorial.</p>

*: This is a function for the optical mirror mode, however, the setting can also be changed while using the digital mirror mode.

■ Enabling/disabling the automatic anti-glare function (optical mirror mode)

The automatic anti-glare function in the optical mirror mode can be enabled/disabled. The setting can be changed in both the digital mirror mode and the optical mirror mode.

- ▶ When using the digital mirror mode



→P.166

- ▶ When using the optical mirror mode

- 1 Press the menu button.

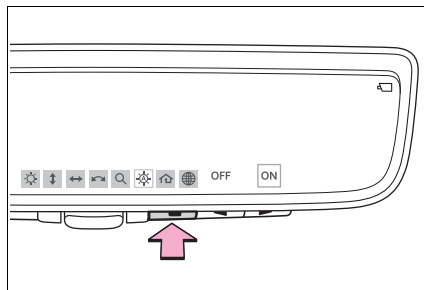
The setting display will be displayed.



- 2 Press  or  to enable ("ON")/disable ("OFF") the automatic anti-glare function.

The icons will disappear if a button is not operated for approximately 5 seconds or more.

■ Adjusting the display (digital mirror mode)

- If the displayed image is adjusted, it may appear distorted. This is not a malfunction.
- If the brightness of the Digital Rear-view Mirror is set too high, it may cause eye strain. Adjust the Digital Rear-view Mirror to an appropriate brightness. If your eyes become tired, change to optical mirror mode.
- The brightness of the Digital Rear-view Mirror will change automatically according to the brightness of the area in front of your vehicle.

■ To prevent the light sensors from malfunctioning

To prevent the light sensors from malfunctioning, do not touch or cover them.

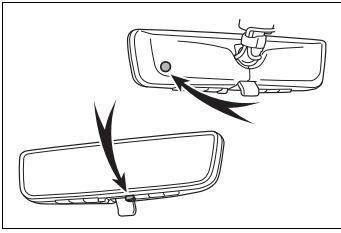

⚠ WARNING

Observe the following precautions.

Failure to do so may result in death or serious injury.

■ While driving

- Do not adjust the position of the Digital Rear-view Mirror or adjust the display settings while driving.

Stop the vehicle and operate the Digital Rear-view Mirror control switches.

Failure to do so may cause a steering wheel operation error, resulting in an unexpected accident.

- Always pay attention to the vehicle's surroundings.

The size of the vehicles and other objects may look different when in digital mirror mode and optical mirror mode.

When backing up, make sure to directly check the safety of the area around your vehicle, especially behind the vehicle.

Additionally, if a vehicle approaches from the rear in the dark, such as at night, the surrounding area may appear dim.

■ To prevent causes of fire

If the driver continues using the Digital Rear-view Mirror while smoke or odor comes from the mirror, it may result in fire. Stop using the system immediately and contact your Toyota dealer.

Cleaning the Digital Rear-view Mirror

■ Cleaning the mirror surface

If the mirror surface is dirty, the image on the display may be difficult to see.

Clean the mirror surface gently using a soft dry cloth.

■ Cleaning the camera

If the camera lens is dirty or covered with foreign matter, such as water droplets, snow, mud, etc., the displayed image may not be clear. In this case, rinse the camera lens with a large quantity of water and then wipe it clean with a soft cloth dampened with water.

■ The camera

The camera for the Digital Rear-view Mirror is located as shown.

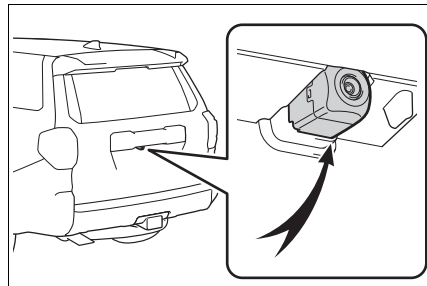



NOTICE

■ **To prevent the Digital Rear-view Mirror from malfunctioning**

- Do not use detergents, such as thinner, benzene, and alcohol to clean the mirror. They may discolor, deteriorate or damage the mirror surface.
- Do not smoke, use matches, use cigarette lighters or allow open flames near the mirror. It may damage the mirror or cause a fire.
- Do not remove, disassemble or modify the mirror.

■ **To prevent the camera from malfunctioning**

- Observe the following precautions, otherwise the Digital Rear-view Mirror may not operate properly.
- Do not strike or hit the camera or subject it to a strong impact, as the camera installation position and angle may be changed.
- Do not remove, disassemble or modify the camera.
- When washing the camera, rinse it with a large quantity of water and then wipe it clean with a soft cloth dampened with water.
Do not strongly rub the camera lens, as it may be scratched and will not be able to transmit a clear image.
- Do not allow organic solvent, car wax, window cleaner or glass coat to adhere to the camera cover. If this happens, wipe it off as soon as possible.

- Do not apply hot water to the camera in cold weather, as the sudden change of temperature may cause the camera to not operate properly.
- When using a high pressure washer to wash the vehicle, do not directly spray the camera and its surrounding area, as doing so may cause the camera to not operate properly.
- Do not subject the camera to a strong impact as this could cause a malfunction.
If this happens, have the vehicle inspected by your Toyota dealer as soon as possible.
- Do not block the vent holes of the mirror. Otherwise, the mirror may be hot, leading to a malfunction or a fire.

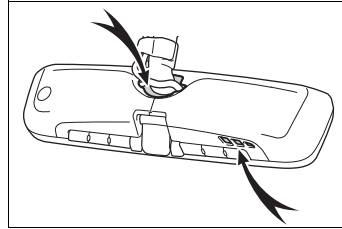





If you notice any symptoms

If you notice any of the following symptoms, refer to the following table for the likely cause and the solution.

If the symptom is not resolved by the solution, have the vehicle inspected by your Toyota dealer.

Symptom	Likely cause	Solution
The image is difficult to see.	The mirror surface is dirty.	Clean the mirror surface gently, using a soft dry cloth.
	Sunlight or headlights are shining directly into the Digital Rear-view Mirror.	Change to optical mirror mode. (If the light is coming through the moon roof [if equipped], close the electronic sunshade.)

Symptom	Likely cause	Solution
The image is difficult to see.	<ul style="list-style-type: none"> • The vehicle is in a dark area. • The vehicle is near a TV tower, broadcasting station, electric power plant, or other location where strong radio waves or electrical noise may be present. • The temperature around the camera is extremely high/low. • The ambient temperature is extremely low. • It is raining or humid. • Sunlight or headlights are shining directly into the camera lens. • The vehicle is under fluorescent lights, sodium lights, mercury lights, etc. • Water vapor from the tailpipe is obstructing the camera. 	Change to optical mirror mode. (Change back to digital mirror mode when the conditions have improved.)
	Foreign matters (such as water droplets, snow, mud, etc.) is on the camera lens.	<ul style="list-style-type: none"> • Change to optical mirror mode. • Rinse the camera with a large quantity of water, wipe it clean with a soft cloth dampened with water, and then change back to digital mirror mode.
The image is out of alignment.	The back door is not fully closed.	Fully close the back door.
	The camera or its surrounding area has received a strong impact.	Change to optical mirror mode and have the vehicle inspected by your Toyota dealer.

Symptom	Likely cause	Solution
<p>The display is dim and  is displayed.</p> <p> goes off.</p>	<p>The system may be malfunctioning.</p>	<p>Change to optical mirror mode and have the vehicle inspected by your Toyota dealer.</p>
<p> is displayed.</p>	<p>The Digital Rear-view Mirror is extremely hot. (The display will gradually become more dim. If the temperature continues to increase, the Digital Rear-view Mirror will turn off.)</p>	<p>Reducing the cabin temperature is recommended to reduce the temperature of the mirror.</p> <p>( will disappear when the mirror becomes cool.)</p> <p>If  does not disappear even though the mirror is cool, have the vehicle inspected by your Toyota dealer.</p>
<p>The lever cannot be operated properly.</p>	<p>The lever may be malfunctioning.</p>	<p>Change to optical mirror mode and have the vehicle inspected by your Toyota dealer. (To change to optical mirror mode, press and hold the menu button for approximately 10 seconds.)</p>

Outside rear view mirrors

The rear view mirror's position can be adjusted to change the rear view.

When using the outside rear view mirrors in a cold weather

When it is cold and the outside rear view mirrors are frozen, it may not be possible to fold/extend them or adjust the mirror surface. Remove the ice, snow, etc. covering the outside rear view mirrors.

! WARNING

Important points while driving

Observe the following precautions while driving.

Failure to do so may result in loss of control of the vehicle and cause an accident, resulting in death or serious injury.

- Do not adjust the mirrors while driving.
- Do not drive with the mirrors folded.
- Both the driver and passenger side mirrors must be unfolded and properly adjusted before driving.

Adjustment procedure

▶ Type A

- 1 To select a mirror to adjust, press the switch.

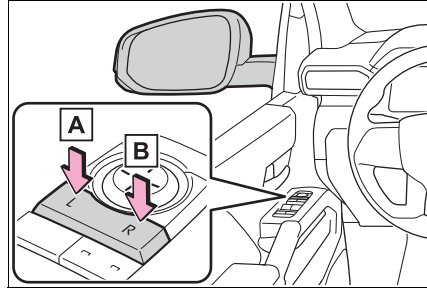

A Left

B Right

- 2 To adjust the mirror, press the switch.

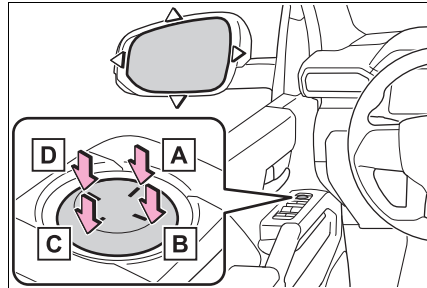

A Up

B Right

C Down

D Left

► Type B

1 When selecting the mirror to adjust, the indicator on the switch illuminates.

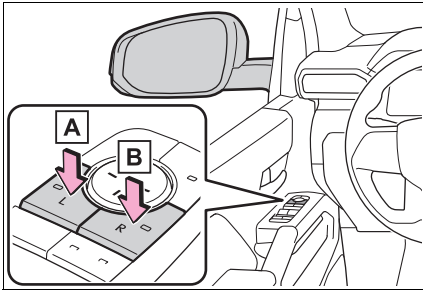

A Left

B Right

Pressing the same switch again will put the switch in neutral.

2 To adjust the mirror, press the switch.

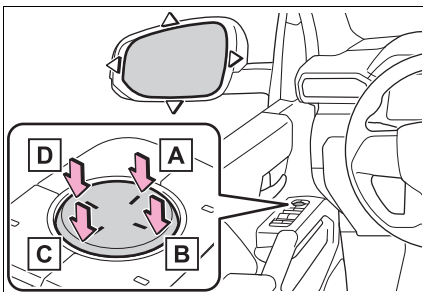

A Up

B Right

C Down

D Left

■ **Mirror angle can be adjusted when**

The engine switch is in ACC or ON.

■ **Defogging the mirrors**

The outside rear view mirrors can

be cleared using the mirror defoggers. Turn on the rear window defogger to turn on the outside rear view mirror defoggers. (→P.455)

■ **Automatic adjustment of the mirror angle (if equipped)**

A desired mirror face angle can be entered to memory and recalled automatically by the driving position memory. (→P.187)

⚠ WARNING

■ **When the mirror defoggers are operating**

Do not touch the rear view mirror surfaces, as they can become very hot and burn you.

■ **Folding the mirrors (manual type)**

Push the mirror back in the direction of the vehicle's rear.

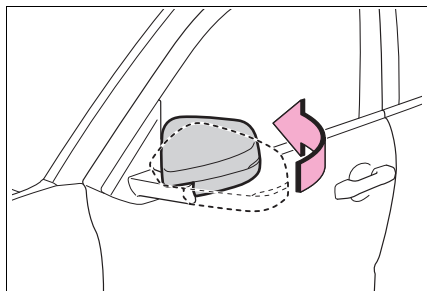

■ **Folding and unfolding the mirrors (power type)**

■ **Using the switch**

Press the switch to fold the mirrors.

Press it again to extend them to the original position.

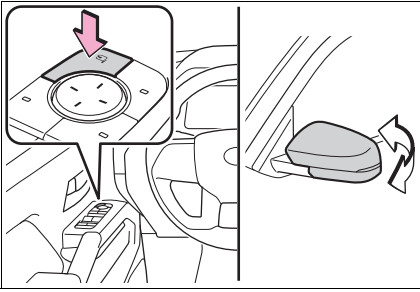

■ Setting automatic mode

Press the “AUTO” switch to set automatic mode.

When in automatic mode, the indicator **A** will come on.

Automatic mode allows the folding or extending of the mirrors to be linked to locking/unlocking of the doors.

Pressing the switch once more will return to manual mode.

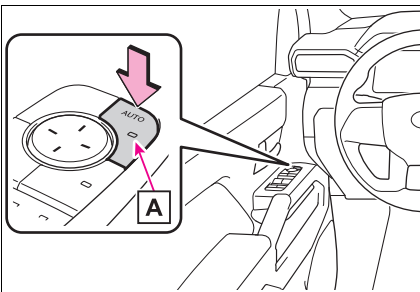

■ When disconnecting and reconnecting battery terminals

The automatic folding/extending mirror function will return to off as default. To turn the function on, press the switch again to select on.

■ Customization

The automatic mirror folding and extending operation can be changed.
(Customizable features: →P.637)

⚠ WARNING

■ When a mirror is moving

To avoid personal injury and mirror malfunction, be careful not to get your hand caught by the moving mirror.

Linked mirror function when reversing (if equipped)

When either “L” or “R” of the mirror select switch is selected, the outside rear view mirrors will automatically angle downwards when the vehicle is reversing in order to give a better view of the ground.

To disable this function, select neither “L” nor “R”.

■ Adjusting the mirror angle when the vehicle is reversing

With the shift lever in R, adjust the mirror angle at a desired position.

The adjusted angle will be memorized and the mirror will automatically tilt to the memorized angle whenever the shift lever is shifted to R from next time.

The memorized downward tilt position of the mirror is linked to the normal position (angle adjusted with the shift position in other than R). Therefore, if the normal position is changed after adjustment, the tilt position will also change.

When the normal position is changed, readjust the angle in

reversing.

Power windows

Opening and closing the power windows

The power windows can be opened and closed using the switches.

Operating the switch moves the windows as follows:

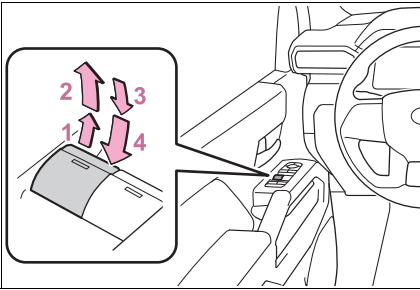

- 1 Closing
- 2 One-touch closing *
- 3 Opening
- 4 One-touch opening *

*: To stop the window partway, operate the switch in the opposite direction.

■ The power windows can be operated when

The engine switch is in ON

■ Operating the power windows after turning the engine off

The power windows can be operated for approximately 45 seconds even after the engine switch is turned to ACC or turned off. They cannot, however, be operated once either front door is opened.

■ Jam protection function

If an object becomes jammed between the window and the win-

dow frame while the window is closing, window movement is stopped and the window is opened slightly.

■ Catch protection function

If an object becomes caught between the door and window while the window is opening, window movement is stopped.

■ When the side window cannot be opened or closed

When the jam protection function or catch protection function operates unusually and the side window cannot be opened and closed, perform the following operations with the power window switch of that door.

- Stop the vehicle. With the engine switch in ON, within 4 seconds of the jam protection function or catch protection function activating, continuously operate the power window switch in the one-touch closing direction or one-touch opening direction so that the side window can be opened and closed.

- If the side window cannot be opened and closed even when performing the above operations, perform the following procedure for function initialization.

- 1 Turn the engine switch to ON.
- 2 Pull and hold the power window switch in the one-touch closing direction and completely close the side window.
- 3 Release the power window switch for a moment, resume pulling the switch in the one-touch closing direction, and hold it there for approximately 6 seconds or more.
- 4 Press and hold the power window switch in the one-touch opening direction. After the side window is completely opened, continue holding the switch for an additional 1 second or more.
- 5 Release the power window switch for a moment, resume

pushing the switch in the one-touch opening direction, and hold it there for approximately 4 seconds or more.

- 6 Pull and hold the power window switch in the one-touch closing direction again. After the side window is completely closed, continue holding the switch for a further 1 second or more.

If you release the switch while the window is moving, start again from the beginning.

If the window reverses and cannot be fully closed or opened, have the vehicle inspected by your Toyota dealer.

■ Door lock linked window operation

- The power windows can be opened and closed using the mechanical key.* (→P.606)
- The power windows can be opened using the wireless remote control.* (→P.119)
- The alarm may be triggered if the alarm is set and a power window is closed using the door lock linked power window operation function. (→P.71)

*: These settings must be customized at your Toyota dealer.

■ Power windows open warning buzzer

A buzzer sounds and a message is shown on the multi-information display in the instrument cluster when the engine switch is turned off and the driver's door is opened with the power windows open.

■ Customization

Some functions can be customized. (→P.637)



WARNING

Observe the following precautions.

Failing to do so may result in death or serious injury.

■ Closing the windows

- The driver is responsible for all the power window operations, including the operation for the passengers. In order to prevent accidental operation, especially by a child, do not let a child operate the power windows. It is possible for children and other passengers to have body parts caught in the power window. Also, when riding with a child, it is recommended to use the window lock switch. (→P.179)
- Check to make sure that all passengers do not have any part of their body in a position where it could be caught when a window is being operated.

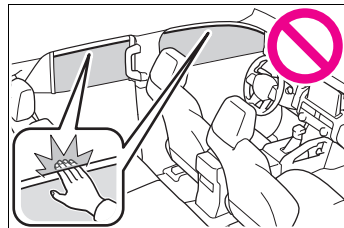

- When using the wireless remote control or mechanical key and operating the power windows, operate the power window after checking to make sure that there is no possibility of any passenger having any of their body parts caught in the window. Also, do not let a child operate window by the wireless remote control or mechanical key. It is possible for children and other passengers to get caught in the power window.

⚠ WARNING

- When exiting the vehicle, turn the engine switch off, carry the key and exit the vehicle along with the child. There may be accidental operation, due to mischief, etc., that may possibly lead to an accident.
- **Jam protection function**
- Never use any part of your body to intentionally activate the jam protection function.
- The jam protection function may not work if something gets jammed just before the window is fully closed. Be careful not to get any part of your body jammed in the window.
- **Catch protection function**
- Never use any part of your body or clothing to intentionally activate the catch protection function.
- The catch protection function may not work if something gets caught just before the window is fully opened. Be careful not to get any part of your body or clothing caught in the window.

Preventing accidental operation (window lock switch)

This function can be used to prevent children from accidentally opening or closing a passenger window.

Press the switch.

The indicator **A** will come on and the passenger windows will be locked.

The passenger windows can still be opened and closed using the driver's switch even if the lock switch is on.

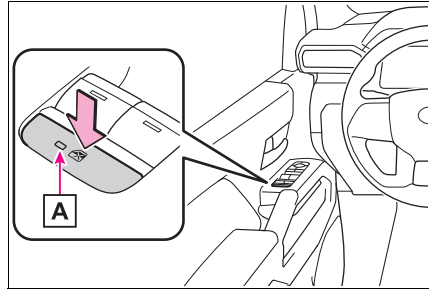
**■ The window lock switch can be operated when**

The engine switch is in ON.

■ When the battery is disconnected

The window lock switch is disabled. If necessary, press the window lock switch after reconnecting the battery.

Power back window

The power back window can be opened and closed using the switch or key.

⚠ WARNING

■ Caution while driving

Keep the back window closed.

This not only keeps personal belongings from being thrown out, but also prevents exhaust gases from entering the vehicle.

Opening and closing procedures

► From inside the vehicle

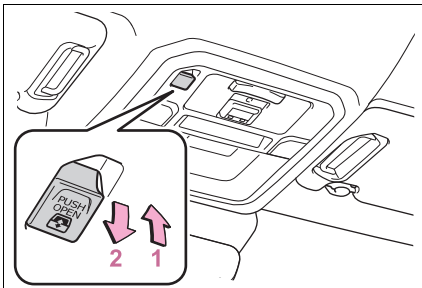

1 Opening (push and hold)

2 Closing (pull and hold)

► From outside the vehicle

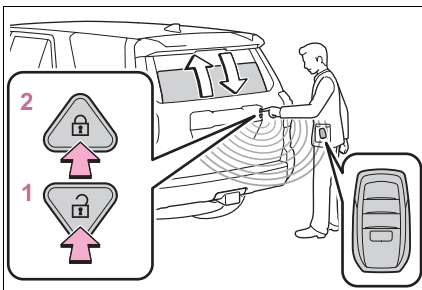

1 Opening (push and hold)

2 Closing (push and hold)

This operation can only be performed when the electronic key is within the detection range.

■ The power back window can be operated from inside the vehicle when

- The engine switch is in ON.
- The power back window can be opened when the rear window wiper is working, but the wiper stops working until the window is closed again. If the power back window is not fully closed, the rear window wiper, washer, and defogger will not work.
- If the back door is not fully closed, the power back window cannot be opened using the switch located in the cabin. (It is still possible to close the window.)
- If the back door is opened while the power back window is opening or closing, window operation will stop.

■ The power back window can be operated from outside the vehicle when

- The engine switch is off.
- The back door is closed.

■ Operating the power back window from inside the vehicle after turning the engine off

The power back window can be operated for approximately 45 seconds even after the engine switch is turned to ACC or turned off. It cannot, however, be operated once either front door is opened.

■ Jam protection function

If an object becomes caught between the window and the window frame, window travel is stopped and the window is opened slightly.

■ When the power back window does not close normally

If the jam protection function is operating abnormally and a window cannot be closed, perform the following operations using the power back window switch.

- After stopping the vehicle, the window can be closed by holding the power back window switch in the one-touch closing position while the engine switch is turned to IGNITION ON.
- If the window still cannot be closed even by carrying out the operation explained above, initialize the function by performing the following procedure.
 - 1 Hold the power back window switch in the one-touch closing position. Continue holding the switch for a further 6 seconds after the window has closed.
 - 2 Hold the power back window switch in the one-touch opening position. Continue holding the switch for a further 2 seconds after the window has opened completely.
 - 3 Hold the power back window switch in the one-touch closing position once again. Continue holding the switch for a further 2 seconds after the window has closed.

If you release the switch while the window is moving, start again from the beginning.

If the window continues to close but then re-open slightly even after performing the above procedure correctly, have the vehicle inspected by your Toyota dealer.

■ Customization

Some functions can be customized. (→P.644)

■ Power back window open warning buzzer

A buzzer sounds and a message is shown on the multi-information display in the instrument cluster when the engine switch is turned off and the driver's door is opened with the power back window open.

⚠ WARNING

Observe the following precautions.

Failure to do so may result in death or serious injury.

■ Caution while driving

Keep the back door and back window closed while driving. If the back door or the back window is left open, the back door may hit nearby objects while driving or luggage may be unexpectedly thrown out, causing an accident. In addition, exhaust gases may enter the vehicle, causing death or a serious health hazard. Make sure to close the back door and back window before driving.

■ Closing the back window

- The driver is responsible for all the power back window operations, including the operation for the passengers. In order to prevent accidental operation, especially by a child, do not let a child operate the power back window. It is possible for children and other passengers to have body parts caught in the power back window.
- Check to make sure that all passengers do not have any part of their body in a position where it could be caught when a window is being operated.

**WARNING**

- When using the key and operating the power back window, operate the power back window after checking to make sure that there is no possibility of any passenger having any of their body parts caught in the power back window. Also, do not let a child operate power back window by the key. It is possible for children and other passengers to get caught in the power back window.
 - When exiting the vehicle, turn the engine switch off, carry the key and exit the vehicle along with the child. There may be accidental operation, due to mischief, etc., that may possibly lead to an accident.
- **Jam protection function**
- Never use any part of your body to intentionally activate the jam protection function.
 - The jam protection function may not work if something gets caught just before the window fully closes.

Moon roof*

*: If equipped

Use the overhead switches to open and close the moon roof and tilt it up and down.

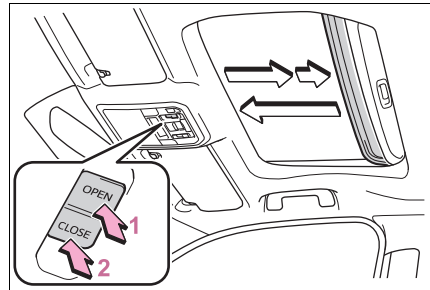
Operating the moon roof■ **Opening and closing****1** Opens the moon roof*

The moon roof tilts up and then opens.

The moon roof stops slightly before the fully open position to reduce wind noise. Press the switch again to fully open the moon roof.

2 Closes the moon roof*

*: Lightly press either side of the moon roof switch to stop the moon roof partway.

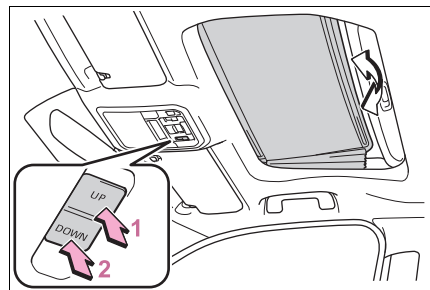
■ **Tilting up and down**

- 1 Tilts the moon roof up*
- 2 Tilts the moon roof down*

*: Lightly press either side of the moon roof switch to stop the moon roof partway.

■ The moon roof can be operated when

The engine switch is in ON.

■ Operating the moon roof after turning the engine off

The moon roof can be operated for approximately 45 seconds after the engine switch is turned to ACC or OFF. It cannot, however, be operated once either front door is opened.

■ Jam protection function

If an object is detected between the moon roof and the frame while the moon roof is closing or tilting down, travel is stopped and the moon roof opens slightly.

■ Sunshade

The sunshade can be opened and closed manually. However, the sunshade will open automatically when the moon roof is opened.

■ Door lock linked moon roof operation

- The moon roof can be opened and closed using the mechanical key.* (→P.606)
- The moon roof can be opened using the wireless remote control.* (→P.116)
- The alarm may be triggered if the alarm is set and the moon roof is closed using the door lock linked moon roof operation function. (→P.71)

*: These settings must be customized at your Toyota dealer.

■ When the moon roof does not close normally

Perform the following procedure:

- If the moon roof closes but then re-opens slightly
 - 1 Stop the vehicle.
 - 2 Press and hold the “CLOSE” switch.*¹

The moon roof will close, reopen and pause for approximately 10 seconds.*² Then it will close again, tilt up and pause for approximately 1 second. Finally, it will tilt down, open and close.

- 3 Check to make sure that the moon roof is completely closed and then release the switch.
- If the moon roof tilts down but then tilts back up
 - 1 Stop the vehicle.
 - 2 Press and hold the “UP” switch*¹ until the moon roof moves into the tilt up position and stops.
 - 3 Release the “UP” switch once and then press and hold the “UP” switch again.*¹

The moon roof will pause for approximately 10 seconds in the tilt up position.*² Then it will adjust slightly and pause for approximately 1 second. Finally, it will tilt down, open and close.

- 4 Check to make sure that the moon roof is completely closed and then release the switch.

*¹: If the switch is released at the incorrect time, the procedure will have to be performed again from the beginning.

*²: If the switch is released after the above mentioned 10 seconds pause, automatic operation will be disabled. In that case, press and hold the “CLOSE” or “UP” switch, and the moon roof will tilt up and pause for approximately 1

3 Before driving

second. Then it will tilt down, open and close. Check to make sure that the moon roof is completely closed and then release the switch.

If the moon roof does not fully close even after performing the above procedure correctly, have the vehicle inspected by your Toyota dealer.

■ **Moon roof open reminder function**

The buzzer sounds and a message is shown on the multi-information display when the engine switch is turned to OFF and the driver's door is opened with the moon roof open.

■ **Customization**

Some functions can be customized. (→P.637)

⚠ WARNING

Observe the following precautions. Failure to do so may cause death or serious injury.

■ **Opening the moon roof**

- Do not allow any passengers to put their hands or head outside the vehicle while it is moving.
- Do not sit on top of the moon roof.

■ **Opening and closing the moon roof**

- The driver is responsible for moon roof opening and closing operations. In order to prevent accidental operation, especially by a child, do not let a child operate the moon roof. It is possible for children and other passengers to have body parts caught in the moon roof.

- Check to make sure that all passengers do not have any part of their body in a position where it could be caught when the moon roof is being operated.

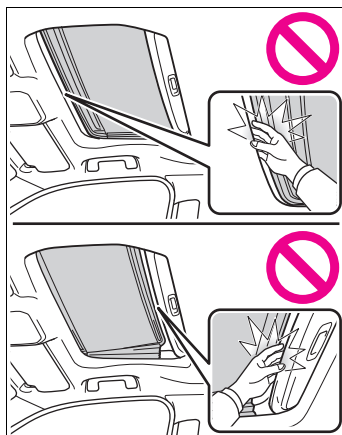

- When using the wireless remote control or mechanical key and operating the moon roof, operate the moon roof after checking to make sure that there is no possibility of any passenger having any of their body parts caught in the moon roof. Also, do not let a child operate moon roof by the wireless remote control or mechanical key. It is possible for children and other passengers to get caught in the moon roof.

⚠ WARNING

- When exiting the vehicle, turn the engine switch off, carry the key and exit the vehicle along with the child. There may be accidental operation, due to mischief, etc., that may possibly lead to an accident.

■ **Jam protection function**

- Never use any part of your body to intentionally activate the jam protection function.

- The jam protection function may not work if something gets caught just before the moon roof is fully closed. Also, the jam protection function is not designed to operate while the switch is being pressed. Take care so that your fingers, etc. do not get caught.

Driving position memory*

*: If equipped

This feature automatically adjusts the positions of the driver's seat, steering wheel (power adjustment type) and outside rear view mirrors to make entering and exiting the vehicle easier or to suit your preferences.

Driving positions can be recorded for 3 drivers that has been registered for My Settings.

When electronic key assignment is registered for My Settings, the driving position for each driver can be recalled (memory recall function).

For details about My Settings, refer to P.189.

Enabling easier driver entry and exit (power easy access system)

When all of the following have been performed, the driver's seat and steering wheel (power adjustment type) are automatically adjusted to a position that allows driver to enter and exit the vehicle easily.

- The shift lever has been shifted to P.

- The engine switch has been turned off.
- The driver's seat belt has been unfastened.

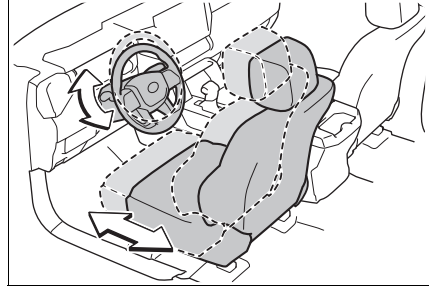

When any of the following has been performed, the driver's seat and steering wheel (power adjustment type) automatically return to their original positions.

- The engine switch has been turned to ACC or ON.
- The driver's seat belt has been fastened.

■ Operation of the power easy access system

- When exiting the vehicle, the power easy access system may not operate if the seat is already close to the rearmost position, etc.
- If the seat position is adjusted during power easy access system operation, the automatic operation will stop. (The seat will change to manual operation.)
- If the seat position is adjusted during or after the power easy access system operation when the driver is exiting the vehicle, the power easy access system will not operate when entering the vehicle.

■ Jam protection function

If a person or object interferes while the seat is moving automatically, the

operation will stop.

■ **Customization**

Some functions can be customized.
(→P.637)

⚠ WARNING

■ **While the power easy access system is operating and the steering wheel and seat is moving**

Be careful not to get body parts or luggage caught. Failure to do so may cause an injury or damage to the luggage.

Recording/recalling a driving position

■ **Recording procedure**

- 1 Check that the shift lever is in P.
- 2 Turn the engine switch to ON.
- 3 Adjust the driver’s seat, steering wheel (power adjustment type) and outside rear view mirrors to the desired positions.
- 4 While pressing the “SET” button, or within 3 seconds after the “SET” button is pressed, press button “1” or “2” until the buzzer sounds.

If the selected button has already been preset, the previously recorded position will be overwrit-

ten.

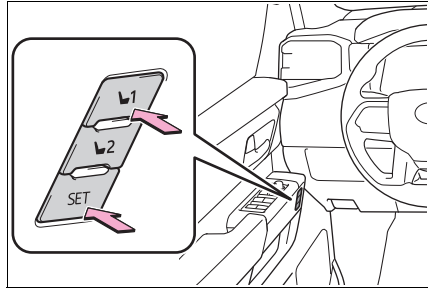

■ **Recall procedure**

- 1 Check that the shift lever is in P.
- 2 Turn the engine switch to ON.
- 3 Press one of the buttons for the driving position you want to recall until the buzzer sounds.

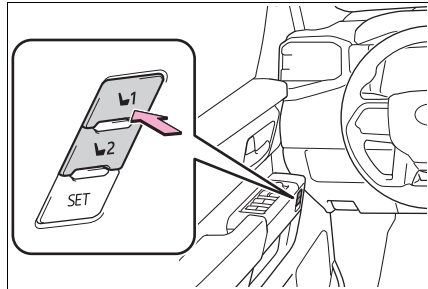

■ **To stop the position recall operation part-way through**

Perform any of the following operations:

- Press the “SET” button.
- Press button “1” or “2”.
- Operate any of the seat adjustment switches (only cancels seat position recall).
- Operate the tilt and telescopic steering control switch (only cancels steering wheel position recall).

3
Before driving

■ **Using the voice control system**

The following operations can be performed using the voice control system:

- Driving position registration
- Recalling the driving position (can be operated only when the shift lever is in P) For details regarding the voice control system, refer to “MULTIMEDIA OWNER’S MANUAL”.

■ **Jam protection function**

If a person or object interferes while the seat is moving automatically, the operation will stop.

■ **Seat positions that can be memorized (→P.151)**

The positions adjusted by the following procedure can be recorded:

- Seat position adjustment
- Seatback angle adjustment
- Seat cushion (front) angle adjustment
- Vertical height adjustment

■ **Operating the driving position memory after turning the engine switch off**

Recorded seat positions can be activated up to 180 seconds after the driver’s door is opened and another 60 seconds after it is closed again.

■ **In order to correctly use the driving position memory function**

If a seat position is already in the furthest possible position and the seat is operated in the same direction, the recorded position may be slightly different when it is recalled.

■ **When recalling the driving position**

Take care when recalling the driving position so that the head restraint does not touch the ceiling.

■ **When the recorded seat position cannot be recalled**

The seat position may not be recalled in some situations when the seat position is recorded in a certain range. For details, contact your Toyota dealer.

 **WARNING**

■ **Seat adjustment caution**

Take care during seat adjustment so that the seat does not strike the rear passenger or squeeze your body against the steering wheel.

Recalling a driving position automatically when getting in the vehicle (memory recall function) (driver’s seat only)

■ **When an individual is identified using My Settings:**

The driving positions can be automatically recalled for each driver registered in My Settings. (→P.189)

- Driving position registration procedure

When the shift lever is shifted to P after driving the vehicle, the current driving position will be recorded.

- Driving position recall procedure

- 1 Carry only the key that has been assigned and registered in My Settings, and then unlock and open the driver’s door using the smart key system with push-button

start or wireless remote control.

The driving position will move to the recorded position. However, the seat will move to a position slightly behind the recorded position in order to make entering the vehicle easier.

If the driving position is in a position that has already been recorded, the driving position will not move.

- 2 Turn the engine switch to ACC or ON.

The seat, steering wheel (if equipped) will move to the recorded position.

- Memory recall function cancellation procedure

How to cancel the memory call function varies depending on the authentication device.

For details, refer to the “MULTIMEDIA OWNER’S MANUAL”.

■ Recalling the driving position using the memory recall function

- The timing of operation may differ depending on the device used to identify an individual.
- As a driving position can be registered to each electronic key, if 2 or more keys are carried, the recall driving position may differ.

My Settings

By recognizing an individual through a device, such as an electronic key and vehicle settings recorded for that driver can be recalled when the vehicle is entered. By assigning an authentication device to a driver in advance, the driver can enter the vehicle with their preferred settings. Settings for up to 3 drivers can be recorded by My Settings. For details on how to assign/delete electronic keys, set driver names, perform initialization, change drivers manually, or delete a driver, refer to the “MULTIMEDIA OWNER’S MANUAL”.

Types of assigned authentication devices

An individual can be identified using the following authentication devices.

- Electronic key

An individual is identified when the smart key system detects their electronic key.

- Digital Key*

An individual is identified when the smart key system detects their Digital Key. (→P.189)

- Bluetooth® devices

An individual can be detected if the same Bluetooth® device that was used as a hands-free phone the last time the vehicle was entered is connected to the audio system.

If an individual is identified by detecting an electronic key, identification by Bluetooth® device will not be performed.

Bluetooth® is a registered trademark of Bluetooth SIG, Inc.

*: If equipped

Recalled functions

When an individual is identified from an authentication device, settings for the following functions are recalled.

- Driving position (memory recall function)^{*1}

After an individual is identified, the driving position that was set when driving was last completed is recalled when the following operation is performed.

- Identification using electronic key:

The driver's doors is unlocked and opened using the smart key system or wireless remote control.

- Identification using Digital Key^{*1}:

The driver's doors is unlocked and opened using the smart key system or wireless remote control.

Refer to P.186 for information on driving position registration and recall.

- Meter display and multimedia information^{*2}

When an individual is identified, the vehicle settings used when the engine switch was last turned off are recalled.

- Vehicle settings that can be set using the multimedia display^{*2}

When an individual is identified, the vehicle settings used when the engine switch was last turned off are recalled.

- Safe driving support function^{*2}

When an individual is identified, the vehicle settings used when the engine switch was last turned off are recalled.

*1: If equipped

*2: Some settings are excluded

4-1. Before driving

Driving the vehicle.....	193
Cargo and luggage	200
Vehicle load limits	204
Trailer towing.....	205
Dinghy towing	217

4-2. Driving procedures

Engine (ignition) switch	218
Automatic transmission	222
Turn signal lever.....	226
Parking brake	227
Brake Hold	231

4-3. Operating the lights and wipers

Headlight switch	234
Fog light switch	237
AHB (Automatic High Beam).....	238
Windshield wipers and washer.....	241
Rear window wiper and washer.....	243

4-4. Refueling

Opening the fuel tank cap	246
---------------------------------	-----

4-5. Using the driving support systems

Toyota Safety Sense 3.0 software update.....	248
Toyota Safety Sense 3.0	250

PCS (Pre-Collision System)	259
LTA (Lane Tracing Assist)	270
LDA (Lane Departure Alert)	275
PDA (Proactive driving assist)	281
RSA (Road Sign Assist)	288
Dynamic radar cruise control	290
Cruise control	301
Emergency Driving Stop System	305
TDA (Trailer Driving Assist)	308
Stop & Start system	309
BSM (Blind Spot Monitor)	316
Intuitive parking assist.	323
RCTA (Rear Cross Traffic Alert) function	330
RCD (Rear Camera Detection)	335
PKSB (Parking Support Brake).....	339
Parking Support Brake function (static objects front and rear of the vehicle)	344

- Parking Support Brake function (moving vehicles rear of the vehicle)..... 347
- Parking Support Brake function (pedestrians rear of the vehicle)..... 348
- Toyota parking assist monitor..... 350
- Panoramic view monitor
..... 363
- Multi-terrain Monitor 399
- Driving mode select switch
..... 412
- Four-wheel drive system
(part-time 4WD models)
..... 414
- Four-wheel drive system
(full-time 4WD models)
..... 417
- AUTO LSD system..... 419
- Rear differential lock system
..... 421
- Crawl Control 422
- Multi-terrain Select 425
- Downhill assist control system 428
- Driving assist systems 431
- SDM (Stabilizer with Disconnection Mechanism) .. 436
- Trailer brake controller 437
- Trailer Backup Guide .. 440
- 4-6. Driving tips**
- Off-road precautions ... 445
- Winter driving tips..... 448

Driving the vehicle

The following procedures should be observed to ensure safe driving:

Driving procedure

■ Starting the engine

→P.218

■ Driving

- 1 With the brake pedal depressed, shift the shift lever to D.
- 2 Release the parking brake. (→P.227)

If the parking brake is in automatic mode, the parking brake will be released automatically. (→P.228)

- 3 Gradually release the brake pedal and gently depress the accelerator pedal to accelerate the vehicle.

■ Stopping

- 1 With the shift lever in D, depress the brake pedal.

Vehicles with a Stop & Start system: If the Stop & Start system is enabled, depressing the brake pedal will stop the engine. (→P.309)

- 2 If necessary, set the parking brake. (→P.227)

If the vehicle is to be stopped for an extended period of time, shift the shift lever to P. (→P.222)

■ Parking the vehicle

- 1 With the shift lever in D, depress the brake pedal to stop the vehicle completely.
- 2 Set the parking brake (→P.227), and shift the shift lever to P. (→P.222)

Make sure the parking brake indicator light is on.

Do not press the shift release button after shifting the shift position to P.

- 3 Turn the engine switch to OFF to stop the engine.
- 4 Lock the door, making sure that you have the electronic key on your person.

If parking on a hill, block the wheels as needed.

■ Starting off on a steep uphill

- 1 With the brake pedal depressed, shift the shift lever to D.

The hill-start assist control will be activated.

- 2 Pull the parking brake switch and parking brake is set manually. (→P.227)
- 3 Release the brake pedal and gently depress the accelerator pedal to accelerate the vehicle.
- 4 Press the parking brake switch and parking brake is released manually. (→P.227)

Parking brake automatic release function. (→P.228)

■ When starting off on an uphill

The hill-start assist control will activate. (→P.431)

■ Driving in the rain

- Drive carefully when it is raining, because visibility will be reduced, the windows may become fogged-up, and the road will be slippery.
- Drive carefully when it starts to rain, because the road surface will be especially slippery.
- Refrain from high speeds when driving on an expressway in the rain, because there may be a layer of water between the tires and the road surface, preventing the steering and brakes from operating properly.

■ Engine speed while driving

In the following conditions, the engine speed may become high while driving.

This is due to automatic up-shifting control or down-shifting implementation to meet driving conditions. It does not indicate sudden acceleration.

- The vehicle is judged to be driving uphill or downhill
- When the accelerator pedal is released
- When the brake pedal is depressed while “TOW HAUL” mode is selected

■ Restraining the engine output (Brake Override System)

- When the accelerator and brake pedals are depressed at the same time, the engine output may be restrained.
- A warning message is displayed on the multi-information display while the system is operating.

■ Breaking in your new Toyota

To extend the life of the vehicle, observing the following precautions

is recommended:

- For the first 200 miles (300 km):
Avoid sudden stops.
- For the first 500 miles (800 km):
Do not tow a trailer.
- For the first 1000 miles (1600 km):
 - Do not drive at extremely high speeds.
 - Avoid sudden acceleration.
 - Do not drive continuously in low gears.
 - Do not drive at a constant speed for extended periods.

■ Operating your vehicle in a foreign country

Comply with the relevant vehicle registration laws and confirm the availability of the correct fuel. (→P.617)

■ Idling time before engine stop

To prevent damage to the turbo-charger, allow the engine to idle immediately after high-speed driving or hill climbing.

Driving condition	Idling time
Normal city driving	Not necessary
High-speed driving (Constant speed of approx. 50 mph [80 km/h])	Not necessary
Steep hill driving or continuous driving at 62 mph (100 km/h) or more (race track driving, etc.)	Approximately 1 minute

⚠ WARNING

Observe the following precautions. Failure to do so may result in death or serious injury.

**WARNING****■ When starting the vehicle**

Always keep your foot on the brake pedal while stopped with the engine running. This prevents the vehicle from creeping.

■ When driving the vehicle

- Do not drive if you are unfamiliar with the location of the brake and accelerator pedals to avoid depressing the wrong pedal.
- Accidentally depressing the accelerator pedal instead of the brake pedal will result in sudden acceleration that may lead to an accident.
- When backing up, you may twist your body around, leading to difficulty in operating the pedals. Make sure to operate the pedals properly.
- Make sure to keep a correct driving posture even when moving the vehicle only slightly. This allows you to depress the brake and accelerator pedals properly.
- Depress the brake pedal using your right foot. Depressing the brake pedal using your left foot may delay response in an emergency, resulting in an accident.
- Do not drive the vehicle over or stop the vehicle near flammable materials. The exhaust system and exhaust gases can be extremely hot. These hot parts may cause a fire if there is any flammable material nearby.

- During normal driving, do not turn off the engine. Turning the engine off while driving will not cause loss of steering or braking control, however, power assist to the steering will be lost. This will make it more difficult to steer smoothly, so you should pull over and stop the vehicle as soon as it is safe to do so. In the event of an emergency, such as if it becomes impossible to stop the vehicle in the normal way: →P.568

- Use engine braking (downshift) to maintain a safe speed when driving down a steep hill. Using the brakes continuously may cause the brakes to overheat and lose effectiveness. (→P.222)

- Do not adjust the positions of the steering wheel, the seat, or the inside or outside rear view mirrors while driving. Doing so may result in a loss of vehicle control.

- Always check that all passengers' arms, heads or other parts of their body are not outside the vehicle.

- Do not drive in excess of the speed limit. Even if the legal speed limit permits it, do not drive over 85 mph (140 km/h) unless your vehicle has high-speed capability tires. Driving over 85 mph (140 km/h) may result in tire failure, loss of control and possible injury. Be sure to consult a tire dealer to determine whether the tires on your vehicle are high-speed capability tires or not before driving at such speeds.

**WARNING**

■ **When driving on slippery road surfaces**

- Sudden braking, acceleration and steering may cause tire slippage and reduce your ability to control the vehicle.
- Sudden acceleration, engine braking due to shifting, or changes in engine speed could cause the vehicle to skid.
- After driving through a puddle, lightly depress the brake pedal to make sure that the brakes are functioning properly. Wet brake pads may prevent the brakes from functioning properly. If the brakes on only one side are wet and not functioning properly, steering control may be affected.

■ **When shifting the shift lever**

- Do not let the vehicle roll backward while a forward driving position is selected, or roll forward while the shift lever is in R. Doing so may result in an accident or damage to the vehicle.
- Do not shift the shift lever to P while the vehicle is moving. Doing so can damage the transmission and may result in a loss of vehicle control.
- Do not shift the shift lever to R while the vehicle is moving forward. Doing so can damage the transmission and may result in a loss of vehicle control.
- Do not shift the shift lever to a driving position while the vehicle is moving backward. Doing so can damage the transmission and may result in a loss of vehicle control.

- Moving the shift lever to N while the vehicle is moving will disengage the engine from the transmission.

Engine braking is not available when N is selected.

- Be careful not to shift the shift lever with the accelerator pedal depressed. Shifting the shift lever to any positions other than P or N may lead to unexpected rapid acceleration of the vehicle that may cause an accident and result in death or serious injury.

■ **If you hear a squealing or scraping noise (brake pad wear indicators)**

Have the brake pads checked and replaced by your Toyota dealer, or any reliable repairer as soon as possible.

Rotor damage may result if the pads are not replaced when needed.

It is dangerous to drive the vehicle when the wear limits of the brake pads and/or those of the brake discs are exceeded.

■ **When the vehicle is stopped**

- Do not race the engine. If the vehicle is in any gear other than P or N, the vehicle may accelerate suddenly and unexpectedly, causing an accident.
- In order to prevent accidents due to the vehicle rolling away, always keep depressing the brake pedal while the engine is running, and apply the parking brake as necessary.
- If the vehicle is stopped on an incline, in order to prevent accidents caused by the vehicle rolling forward or backward, always depress the brake pedal and securely apply the parking brake as needed.

**WARNING**

- Avoid revving or racing the engine. Running the engine at high speed while the vehicle is stopped may cause the exhaust system to overheat, which could result in a fire if combustible material is nearby.
- **When the vehicle is parked**
- Do not leave glasses, cigarette lighters, spray cans, or soft drink cans in the vehicle when it is in the sun. Doing so may result in the following:
 - Gas may leak from a cigarette lighter or spray can, and may lead to a fire.
 - The temperature inside the vehicle may cause the plastic lenses and plastic material of glasses to deform or crack.
 - Soft drink cans may fracture, causing the contents to spray over the interior of the vehicle, and may also cause a short circuit in the vehicle's electrical components.
- Do not leave cigarette lighters in the vehicle. If a cigarette lighter is in a place such as the glove box or on the floor, it may be lit accidentally when luggage is loaded or the seat is adjusted, causing a fire.
- Do not attach adhesive discs to the windshield or windows. Do not place containers such as air fresheners on the instrument panel or dashboard. Adhesive discs or containers may act as lenses, causing a fire in the vehicle.

- Do not leave a door or window open if the curved glass is coated with a metallized film such as a silver-colored one. Reflected sunlight may cause the glass to act as a lens, causing a fire.
- Always apply the parking brake, shift the shift lever to P, stop the engine and lock the vehicle. Do not leave the vehicle unattended while the engine is running. If the vehicle is parked with the shift lever in P but the parking brake is not set, the vehicle may start to move, possibly leading to an accident.
- Do not touch the exhaust pipes while the engine is running or immediately after turning the engine off. Doing so may cause burns.
- 4WD models: If the shift lever is moved before the "4HI" (part-time 4WD models) or "4LO" indicator turns on/off, the transfer mode may not be shifted completely. The transfer mode disengages both the front and rear driveshafts from the powertrain and allows the vehicle to move regardless of the shift position. (At this time, the indicator blinks and the buzzer sounds.) Therefore, the vehicle is free to roll even if the automatic transmission is in P. You or someone else could be seriously injured. You must complete the shifting of the transfer mode. (→P.414, 417)

**WARNING****■ When taking a nap in the vehicle**

Always turn the engine off. Otherwise, if you accidentally move the shift lever or depress the accelerator pedal, this could cause an accident or fire due to engine overheating. Additionally, if the vehicle is parked in a poorly ventilated area, exhaust gases may collect and enter the vehicle, leading to death or a serious health hazard.

■ When braking

- When the brakes are wet, drive more cautiously. Braking distance increases when the brakes are wet, and this may cause one side of the vehicle to brake differently than the other side. Also, the parking brake may not securely hold the vehicle.
- If the brake booster device does not operate, do not follow other vehicles closely and avoid hills or sharp turns that require braking. In this case, braking is still possible, but the brake pedal should be depressed more firmly than usual. Also, the braking distance will increase. Have your brakes fixed immediately.
- Do not pump the brake pedal if the engine stalls. Each push on the brake pedal uses up the reserve for the power-assisted brakes.

- The brake system consists of 2 or more individual hydraulic systems; if one of the systems fails, the other will still operate. In this case, the brake pedal should be depressed more firmly than usual and the braking distance will increase. Have your brakes fixed immediately.

■ If the vehicle becomes stuck

Do not spin the wheels excessively when a driven wheel is up in the air, or the vehicle is stuck in sand, mud, etc. This may damage the driveline components or propel the vehicle forward or backward, causing an accident.

**NOTICE****■ When driving the vehicle**

- Do not depress the accelerator and brake pedals at the same time during driving, as this may restrain the engine output.
- Do not use the accelerator pedal or depress the accelerator and brake pedals at the same time to hold the vehicle on a hill.

■ When parking the vehicle

Always set the parking brake and shift the shift lever to P. Failure to do so may cause the vehicle to move or the vehicle may accelerate suddenly if the accelerator pedal is accidentally depressed.

■ Avoiding damage to vehicle parts

- Do not turn the steering wheel fully in either direction and hold it there for an extended period of time. Doing so may damage the power steering.



NOTICE

- When driving over bumps in the road, drive as slowly as possible to avoid damaging the wheels, underside of the vehicle, etc.
- Make sure to idle the engine immediately after high-load driving. Stop the engine only after the turbocharger has cooled down. Failure to do so may cause damage to the turbocharger
- **If you get a flat tire while driving**

A flat or damaged tire may cause the following situations. Hold the steering wheel firmly and gradually depress the brake pedal to slow down the vehicle.

- It may be difficult to control your vehicle.
- The vehicle will make abnormal sounds or vibrations.
- The vehicle will lean abnormally.

Information on what to do in case of a flat tire (→P.593)

■ **When encountering flooded roads**

Do not drive on a road that has flooded after heavy rain, etc. Doing so may cause the following serious damage to the vehicle:

- Engine stalling
- Short in electrical components
- Engine damage caused by water immersion

In the event that you drive on a flooded road and the vehicle becomes flooded or stuck in mud or sand, be sure to have your Toyota dealer check the following:

- Brake function

- Changes in quantity and quality of oil and fluid used for the engine, transmission, transfer (4WD vehicles), differential, etc.
- Lubricant condition for the propeller shaft, bearings and suspension joints (where possible), and the function of all joints, bearings, etc.

Sudden start restraint control (Drive-Start Control [DSC])

When the following unusual operation is performed with the accelerator pedal depressed, the engine output may be restrained.

- When the shift lever is shifted to R*.
- When the shift lever is shifted from P or R to forward drive shift position such as D*.

When the system operates, a message appears on the multi-information display. Read the message and follow the instruction.

*: Depending on the situation, the shift position may not be changed.

■ **Drive-Start Control (DSC)**

When the TRAC is turned off (→P.432), sudden start restraint control also does not operate. If your vehicle have trouble escaping from the mud or fresh snow due to sudden start restraint operation, deactivate TRAC (→P.432) so that the vehicle may become able to escape from the mud or fresh snow.

Also, sudden start restraint control

will not operate in the following conditions:

- When the AUTO LSD mode is selected (if equipped)
- Vehicles with part-time 4WD: When the front-wheel drive control switch is in “4H” or “4L” position.
- Vehicles with full-time 4WD: When the front-wheel drive control switch is in “H4L” or “L4L” position.
- When the center differential is locked (if equipped)
- When Multi-terrain Select is selected (if equipped)

Cargo and luggage

Take notice of the following information about storage precautions, cargo capacity and load:

Capacity and distribution

Cargo capacity depends on the total weight of the occupants.

(Cargo capacity) = (Total load capacity) — (Total weight of occupants)

Steps for Determining Correct Load Limit —

(1) Locate the statement “The combined weight of occupants and cargo should never exceed XXX kg or XXX lbs.” on your vehicle’s placard.

(2) Determine the combined weight of the driver and passengers that will be riding in your vehicle.

(3) Subtract the combined weight of the driver and passengers from XXX kg or XXX lbs.

(4) The resulting figure equals the available amount of cargo and luggage load capacity.

For example, if the “XXX” amount equals 1400 lbs. and there will be five 150 lb passengers in your vehicle, the amount of available cargo and luggage load capacity is 650 lbs. (1400 –

750 (5 × 150) = 650 lbs.)

(5) Determine the combined weight of luggage and cargo being loaded on the vehicle. That weight may not safely exceed the available cargo and luggage load capacity calculated in Step 4.

(6) If your vehicle will be towing a trailer, load from your trailer will be transferred to your vehicle. Consult this manual to determine how this reduces the available cargo and luggage load capacity of your vehicle. (→P.204)

Calculation formula for your vehicle

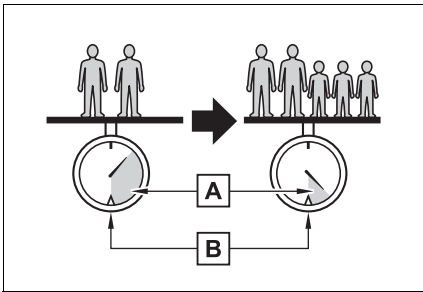

- A** Cargo capacity
- B** Total load capacity (vehicle capacity weight) (→P.616)

When 2 people with the combined weight of A lb. (kg) are riding in your vehicle, which has a total load capacity (vehicle capacity weight) of B lb. (kg), the available amount of cargo and luggage load capacity will

be C lb. (kg) as follows:

$$B^{*2} \text{ lb. (kg)} - A^{*1} \text{ lb. (kg)} = C^{*3} \text{ lb. (kg)}$$

*1: A =Weight of people

*2: B =Total load capacity

*3: C =Available cargo and luggage load

In this condition, if 3 more passengers with the combined weight of D lb. (kg) get on, the available cargo and luggage load will be reduced E lb. (kg) as follows:

$$C \text{ lb. (kg)} - D^{*4} \text{ lb. (kg)} = E^{*5} \text{ lb. (kg)}$$

*4: D =Additional weight of people

*5: E =Available cargo and luggage load

As shown in the example above, if the number of occupants increases, the cargo and luggage load will be reduced by an amount that equals the increased weight due to the additional occupants. In other words, if an increase in the number of occupants causes an excess of the total load capacity (combined weight of occupants plus cargo and luggage load), you must reduce the cargo and luggage on your vehicle.

⚠ WARNING

■ **Things that must not be carried in the luggage compartment**

The following things may cause a fire if loaded in the luggage compartment:

**WARNING**

- Receptacles containing gasoline

- Aerosol cans

- **Storage precautions**

Observe the following precautions.

Failure to do so may prevent the pedals from being depressed properly, may block the driver's vision, or may result in items hitting the driver or passengers, possibly causing an accident.

- Stow cargo and luggage in the luggage compartment whenever possible.

- Do not stack cargo and luggage in the luggage compartment higher than the seatbacks.

- Do not place cargo or luggage in or on the following locations.

- At the feet of the driver
- On the front passenger or rear seats (when stacking items)
- On the instrument panel
- On the dashboard
- On the auxiliary box or tray that has no lid
- Secure all items in the occupant compartment.
- When you fold down the rear seats, long items should not be placed directly behind the front seats.

- Never allow anyone to ride in the rear deck. It is not designed for passengers. They should ride in their seats with their seat belts properly fastened. Otherwise, they are much more likely to suffer death or serious bodily injury, in the event of sudden braking, sudden swerving or an accident.

- **Capacity and distribution**

- Do not exceed the maximum axle weight rating or the total vehicle weight rating.

- Even if the total load of occupant's weight and the cargo load is less than the total load capacity, do not apply the load unevenly. Improper loading may cause deterioration of steering or braking control which may cause death or serious injury.

Roof luggage carrier

■ Roof luggage carrier components

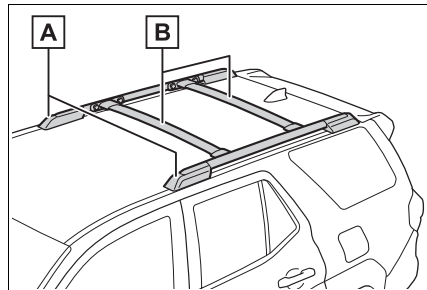

A Roof rails

B Cross rails

**WARNING****■ When loading cargo on the roof luggage carrier**

To use the roof rails as a roof luggage carrier, you must fit the roof rails with two or more genuine Toyota cross rails or their equivalent. When you load cargo on the roof luggage carrier, observe the following:

- Place the cargo so that its weight is distributed evenly between the front and rear axles.
- If loading long or wide cargo, never exceed the vehicle overall length or width. (→P.616)
- Before driving, make sure the cargo is securely fastened on the roof luggage carrier.
- Loading cargo on the roof luggage carrier will make the center of gravity of the vehicle higher. Avoid high speeds, sudden starts, sharp turns, sudden braking or abrupt maneuvers, otherwise it may result in loss of control or vehicle rollover due to failure to operate this vehicle correctly and result in death or serious injury.
- If driving for a long distance, on rough roads, or at high speeds, stop the vehicle now and then during the trip to make sure the cargo remains in its place.

- 2WD models: Do not exceed 125 lb. (57 kg) cargo weight on the roof luggage carrier. Place the cargo so that its weight is distributed evenly between both cross rails.

- 4WD models: Do not exceed 135 lb. (62 kg) cargo weight on the roof luggage carrier. Place the cargo so that its weight is distributed evenly between both cross rails.

**NOTICE****■ When loading cargo (vehicles with moon roof)**

Be careful not to scratch the surface of the moon roof.

Vehicle load limits

Vehicle load limits include total load capacity, seating capacity, TWR (Trailer Weight Rating) and cargo capacity.

- Total load capacity (vehicle capacity weight): →P.616

Total load capacity means the combined weight of occupants, cargo and luggage.

- Seating capacity: →P.616

Seating capacity means the maximum number of occupants whose estimated average weight is 150 lb. (68 kg) per person.

Even if the number of occupants are within the seating capacity, do not exceed the total load capacity.

- TWR (Trailer Weight Rating): →P.209

TWR means the maximum gross trailer weight (trailer weight plus its cargo weight) that your vehicle is able to tow.

- Cargo capacity

Cargo capacity may increase or decrease depending on the weight and the number of occupants.

■ Total load capacity and seating capacity

These details are also described on the tire and loading information label. (→P.622)



WARNING

■ Overloading the vehicle

Do not overload the vehicle. It may not only cause damage to the tires, but also degrade steering and braking ability, resulting in an accident.

Trailer towing

Your vehicle is designed primarily as a passenger-and-load-carrying vehicle. Towing a trailer can have an adverse impact on handling, performance, braking, durability, and fuel consumption. For your safety and the safety of others, you must not overload your vehicle or trailer. You must also ensure that you are using appropriate towing equipment, that the towing equipment has been installed correctly and used properly, and that you employ the requisite driving habits.

Vehicle-trailer stability and braking performance are affected by trailer stability, brake performance and setting, trailer brakes, the hitch and hitch systems.

To tow a trailer safely, use extreme care and drive the vehicle in accordance with your trailer's characteristics and operating conditions.

Toyota warranties do not apply to damage or malfunction caused by towing a trailer for commercial purposes.

Contact your Toyota dealer for further information about additional requirements such as a towing kit, etc.

■ Trailer brake controller

→P.437

■ Before towing

Check that the following conditions are met:

- Ensure that your vehicle's tires are properly inflated. (→P.622)
- Trailer tires are inflated according to the trailer manufacturer's recommendation.
- All trailer lights work as required by law.
- All lights work each time you connect them.
- The trailer ball is set at the proper height for the coupler on the trailer.
- The trailer is level when it is hitched. Do not drive if the trailer is not level, and check for improper tongue weight, overloading, worn suspension, or other possible causes.
- The trailer cargo is securely loaded.
- The rear view mirrors conform to all applicable federal, state/provincial or local regulations. If they do not, install rear view mirrors appropriate for towing purposes.

**WARNING****■ Trailer towing precautions**

To tow a trailer safely, use extreme care and drive the vehicle in accordance with the trailer's characteristics and operating conditions. Failure to do so could cause an accident resulting in death or serious injury. Vehicle stability and braking performance are affected by trailer stability, brake setting and performance, and the hitch. Your vehicle will handle differently when towing a trailer.

■ To avoid accident or injury

- Do not exceed the TWR, unbraked TWR, GCWR, GVWR or GAWR.
- If the gross trailer weight is over 2000 lb. (907 kg), a sway control device with sufficient capacity is required.
- If the gross trailer weight is over 5000 lb. (2268 kg), a weight distributing hitch with sufficient capacity is required.
- Adjust the tongue weight within the appropriate range. Place heavier loads as close to the trailer axle as possible.
- Do not exceed 65 mph (104 km/h), the posted towing speed limit or the speed limit for your trailer as set forth in your trailer owner's manual, whichever is lowest. Slow down sufficiently before making a turn, in cross winds, on wet or slippery surface, etc., to help avoid an accident. If you experience a vehicle-trailer instability from reducing a certain speed, slow down and make sure you keep your vehicle speed under the speed of which you experience the instability.

- Do not make jerky, abrupt or sharp turns.
- Do not apply the brakes suddenly as you may skid, resulting in jackknifing and loss of vehicle control. This is especially true on wet or slippery surfaces.
- Do not exceed the trailer hitch assembly weight, gross vehicle weight, gross axle weight and trailer tongue weight capacities.
- Certain Toyota Safety Sense 3.0 functions will be affected or be unavailable: →P.250, 308
- Slow down and downshift before descending steep or long downhill grades. Do not make sudden downshifts while descending steep or long downhill grades.
- Vehicle-trailer instability is more likely on steep long downhills. Before descending steep or long downhill grades, slow down and downshift. Do not make sudden downshifts when descending steep or long downhill grades. Avoid holding the brake pedal down too long or applying the brakes too frequently. This could cause the brakes to overheat and result in reduced braking efficiency.
- Do not tow a trailer when the temporary spare tire is installed on your vehicle.

■ When towing a trailer

Toyota recommends trailers with brakes that conform to any applicable federal and state/provincial regulations.

⚠ WARNING

- If the gross trailer weight exceeds unbraked TWR, trailer brakes are required. Toyota recommends trailers with brakes that conform to all applicable federal and state/provincial regulations.
- Never tap into your vehicle's hydraulic system, as this will lower the vehicle's braking effectiveness.
- Never tow a trailer without using a safety chain securely attached to both the trailer and the vehicle. If damage occurs to the coupling unit or hitch ball, there is danger of the trailer wandering into another lane.

Towing related terms

■ **GCWR (Gross Combination Weight Rating)**

The maximum allowable gross combination weight. The gross combination weight is the sum of the total vehicle weight (including the occupants, cargo and any optional equipment installed on the vehicle) and the weight of the trailer being towed (including the cargo in the trailer).

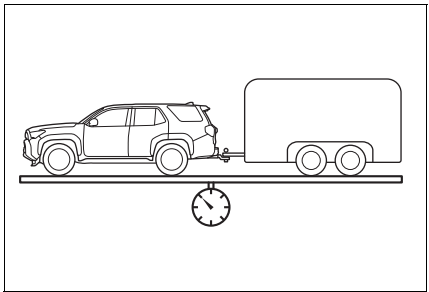

■ **GVWR (Gross Vehicle Weight Rating)**

The maximum allowable gross vehicle weight. The gross vehicle weight is the total weight of the vehicle. When towing a trailer, it is the sum of the vehicle weight (including the occupants, cargo and any optional equipment installed on the vehicle) and the tongue weight.

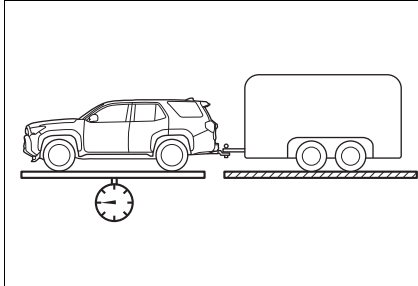

■ **GAWR (Gross Axle Weight Rating)**

The maximum allowable gross axle weight. The gross axle weight is the load placed on each axle (front and rear).

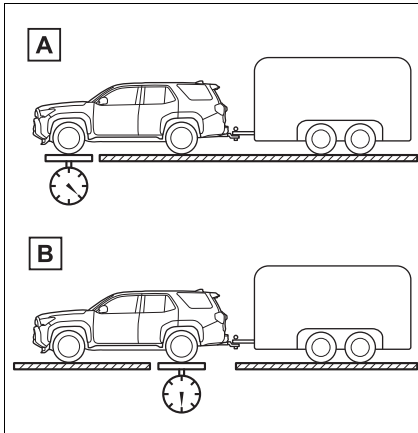

A Front GAWR

B Rear GAWR**■ TWR (Trailer Weight Rating)**

The maximum allowable gross trailer weight. The gross trailer weight is the sum of the trailer weight and the weight of the cargo in the trailer.

TWR is calculated assuming base vehicle with one driver, one front passenger, towing package (if available), hitch and hitch systems (if required).

Additional optional equipment, passengers and cargo in the vehicle will reduce the trailer weight rating so as not to exceed GCWR, GVWR and GAWR.

If the gross trailer weight exceeds 3000 lb. (1360 kg), it is recommended to use a trailer with 2 or more axles.

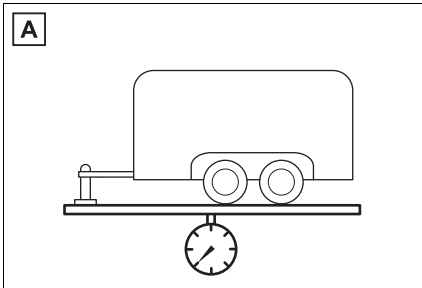
**A** With brakes**■ Unbraked TWR (Unbraked Trailer Weight Rating)**

The trailer weight rating for towing a trailer without a trailer service brake system.

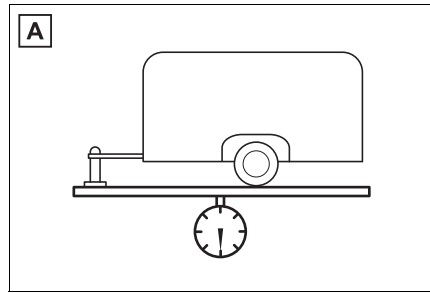
**A** Without brakes**■ Tongue Weight**

The load placed on the trailer hitch ball. (→P.210)

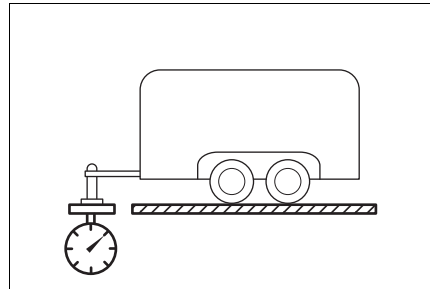
**Weight limits**

- The gross trailer weight must never exceed the TWR described in the table. (→P.209)
- The gross combination weight must never exceed the GCWR described in the table. (→P.209)
- The gross vehicle weight must never exceed the GVWR indicated on the Certification Label. (→P.616)
- The gross axle weight on each axle must never exceed the GAWR indicated on the

- Certification Label. (→P.616)
- If the gross trailer weight is over the unbraked TWR, trailer service brakes are required.
 - If the gross trailer weight is over 2000 lb. (907 kg), a sway control device with sufficient capacity is required.
 - If the gross trailer weight is over 5000 lb. (2268 kg), a weight distributing hitch with sufficient capacity is required.

GCWR, TWR and Unbraked TWR

Confirm that the gross trailer weight, gross combination weight, gross vehicle weight, gross axle weight and tongue weight are all within the limits.

■ **GCWR* and TWR***

Drive	Grade	GCWR	TWR
2WD	SR5	10970 lb. (4975 kg)	6000 lb. (2720 kg)
	TRD Sport	11025 lb. (5000 kg)	
	Limited	11245 lb. (5100 kg)	
4WD	SR5	11235 lb. (5095 kg)	
	TRD Off-Road	11265 lb. (5110 kg)	
	TRD Sport	11285 lb. (5115 kg)	
	Limited	11485 lb. (5210 kg)	

■ **Unbraked TWR***

1655 lb. (750 kg)

*: These models meet the tow-vehicle trailering requirement of SAE International per SAE J2807.

Trailer Tongue Weight

- A recommended tongue weight or kingpin weight varies in accordance with the types of trailers or towing as described below.
- To ensure the recommended values shown below, the trailer must be loaded by referring to the following instructions.
- Conventional Towing

The gross trailer weight should be distributed so that the tongue weight is 9% to 11%. (Tongue Weight/Gross trailer weight x 100 = 9% to 11%)

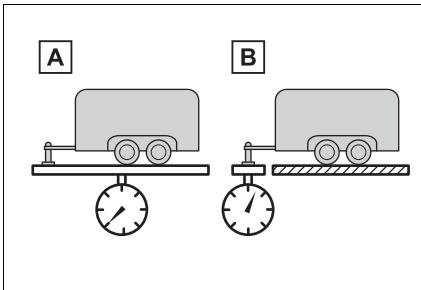

A Gross trailer weight

B Tongue Weight

If using a weight distributing hitch when towing, return the front axle to the same weight as before the trailer connection.

If front axle weight cannot be measured directly, measure the front fender height above the front axle before connection. Adjust weight distributing hitch torque until front fender is returned to the same

height as before connection.

Do not reduce front fender height below original measurement.

The gross trailer weight, gross axle weight and tongue weight can be measured with platform scales found at a highway weighing station, building supply company, trucking company, junk yard, etc.

Hitch

Trailer hitch assemblies have different weight capacities. Toyota recommends the use of Toyota hitch/bracket for your vehicle. For details, contact your Toyota dealer.

- If you wish to install a trailer hitch, contact your Toyota dealer.
- Use only a hitch that conforms to the gross trailer weight requirement of your vehicle.
- Follow the directions supplied by the hitch manufacturer.
- Lubricate the hitch ball and kingpin with a light coating of grease.
- Remove the hitch ball whenever you are not towing a trailer. Remove the trailer hitch if you do not need it. After removing the hitch, seal any mounting holes in the vehicle body to prevent entry of any substances into the vehicle.

⚠ WARNING

■ Hitch

Trailer hitch assemblies have different weight capacities established by the hitch manufacturer. Even though the vehicle may be physically capable of towing a higher weight, the operator must determine the maximum weight rating of the particular hitch assembly and never exceed the maximum weight rating specified for the trailer-hitch. Exceeding the maximum weight rating set by the trailer-hitch manufacturer can cause an accident resulting in death or serious personal injuries.

⚠ NOTICE

■ When installing a trailer hitch

Use only the position recommended by your Toyota dealer. Do not install the trailer hitch on the bumper; this may cause body damage.

Selecting trailer ball

Use the correct trailer ball for your application.

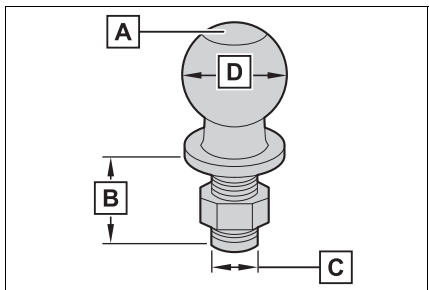

- A** Trailer ball load rating
Matches or exceeds the gross trailer weight rating of the trailer.
- B** Shank length

Protrudes beyond the bottom of the lock washer and nut at least 2 threads.

- C** Shank diameter
Matches the ball mount hole diameter size.
- D** Ball diameter
Matches the size of the trailer coupler. Most couplers are stamped with the required trailer ball size.

Trailer class	Typical trailer ball size
IV	2 5/16 in.
II and III	2 in.
I	1 7/8 in.

Positions for towing hitch receiver and hitch ball

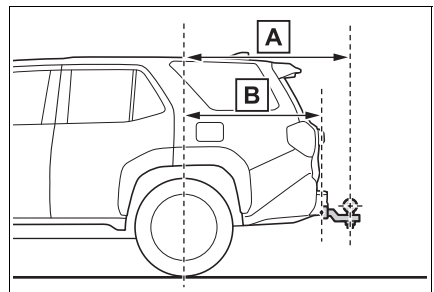

- A** Weight carrying ball position: 52.4 in. (1331.2 mm)
- B** Hitch receiver pin hole position: 45.0 in. (1143.2 mm)

■ Matching trailer ball height to trailer coupler height

No matter which class of tow hitch applies, for a more safer trailer hookup, the trailer ball setup must be the proper height for the coupler

on the trailer.

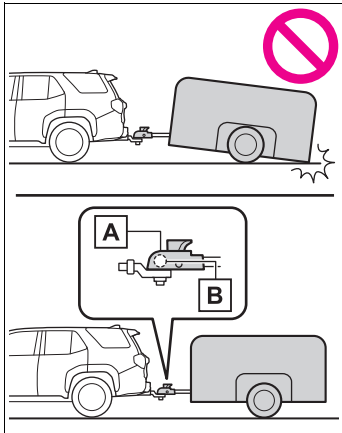

A Coupler

B Trailer ball

Connecting trailer lights

Use the wire harness located in the rear end of the vehicle.

The tow lighting system is designed for 64 watts/5 amps of electrical current per side (right and left) for the trailer brake/turn light functions.

Please contact your Toyota dealer with any questions or concerns.

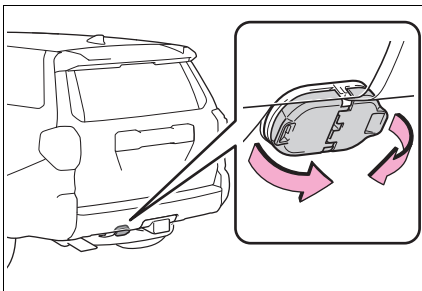

■ Service connector for towing brake controllers (vehicles without trailer brake controller)

Your vehicle is equipped with a service connector for the trailer brake controller as shown.

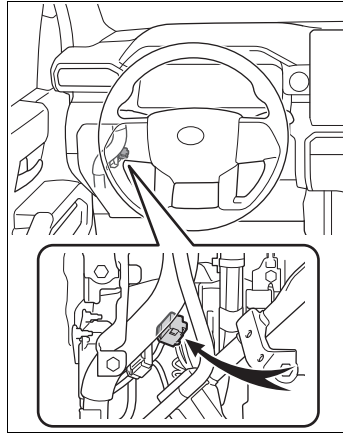

■ Auto current cut-off function

In case of over current, the auto cut-off function stops the power flowing to the trailer lights to prevent damage to the vehicle's electrical system.

This function is activated when the rated current of any of the following trailer light circuit components is exceeded:

- Stop/turn signal light (right): maximum 5 A
- Stop/turn signal light (left): maximum 5 A

■ When the auto current cut function is activated

If a trailer light does not come on due to the activation of the auto current cut function, the light system will need to be reset.

Follow the reset procedure shown below.

- If a tail light does not come on, turn off the headlight switch.
- If the right-side stop/turn signal light does not come on, put the

turn signal in the off position or remove foot from the brake pedal.

- If the left-side stop/turn signal light does not come on, put the turn signal in the off position or remove foot from the brake pedal.

If the emergency flashers do not operate, press the emergency flasher switch to turn them off.

After the light system is reset, operate the light switches again to see if the lights operate normally.

If the lights do not operate normally, have the vehicle inspected by your Toyota dealer.

■ Trailer lights operation check function

Use the meter control switches to start the function. (→P.92, 101)

▶ Vehicles with 7-inch display

- 1 Press \wedge or \vee of the meter control switch to select .
- 2 Press \leftarrow or \rightarrow to select “Vehicle Settings” and then press and hold OK .
- 3 Press \wedge / \vee to select “Trailer Light Check” and then press OK .
- 4 Press OK to start the trailer light check.

▶ Vehicles with 12.3-inch display

- 1 Press and hold OK to display the cursor on the content display area (center) of the multi-information display.
- 2 Press \wedge or \vee of the meter control switches to select  “Settings” and then press OK .

- 3 Press \wedge or \vee to select “Vehicle Settings” and then press and hold OK .

- 4 Press \wedge or \vee to select “Trailer Light Check” and then press OK .

- 5 Press OK to start the trailer light check.

The light check operates in the cycle of Brake lights → Left turn lights → Right turn lights.

■ The trailer light check is operational when

The trailer light check operates when all of the following conditions are met:

- The vehicle is stopped.
- The shift lever is shifted to P.



NOTICE

■ Do not directly splice trailer lights

Do not directly splice trailer lights. Directly splicing trailer lights may damage your vehicle’s electrical system and cause a malfunction.

Removing hitch cover

Pull the lower edge of the hitch cover.

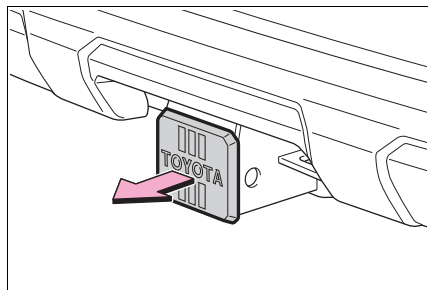

Trailer towing tips

Your vehicle will handle differently when towing a trailer. To help avoid an accident, death or serious injury, keep the following in mind when towing:

- Speed limits for towing a trailer vary by state or province. Do not exceed the posted towing speed limit.
- Toyota recommends that the vehicle-trailer speed limit is 65 mph (104 km/h) on a flat, straight, dry road. Do not exceed this limit, the posted towing speed limit or the speed limit for your trailer as set forth in your trailer owner's manual, whichever is lowest. Instability of the towing vehicle-trailer combination (trailer sway) increases as speed increases. Exceeding speed limits may cause loss of control.
- Before starting out, check the trailer lights, tires and the vehicle-trailer connections. Recheck after driving a short distance.
- Practice turning, stopping and reversing with the trailer attached in an area away from traffic until you become accustomed to the feel of the vehicle-trailer combination.
- Reversing with a trailer attached is difficult and requires practice. Grip the bottom of the steering wheel and move your hand to the left to move the trailer to the left. Move your hand to the right to move the trailer to the right. (This is generally opposite to reversing without a trailer attached.) Avoid sharp or prolonged turning. Have someone guide you when reversing to reduce the risk of an accident.
- As stopping distance is increased when towing a trailer, vehicle-to-vehicle distance should be increased. For each 10 mph (16 km/h) of speed, allow at least one vehicle and trailer length.
- Avoid sudden braking as you may skid, resulting in the trailer jackknifing and a loss of vehicle control. This is especially true on wet or slippery surfaces.
- Avoid jerky starts or sudden acceleration.
- Avoid jerky steering and sharp turns, and slow down before making a turn.
- Note that when making a turn, the trailer wheels will be closer than the vehicle wheels to the inside of the turn. Compensate by making a wider than normal turning radius.
- Slow down before making a

turn, in crosswinds, on wet or slippery surfaces, etc. Increasing vehicle speed can destabilize the trailer.

- Take care when passing other vehicles. Passing requires considerable distance. After passing a vehicle, do not forget the length of your trailer, and be sure you have plenty of room before changing lanes.
- To maintain engine braking efficiency and charging system performance when using engine braking, do not use the transmission in D. If in the S mode, the transmission shift range position must be in 5 or lower.
- Instability happens more frequently when descending steep or long downhill grades. Before descending, slow down and downshift. Do not make sudden downshifts while descending steep or long downhill grades.
- Avoid holding the brake pedal down too long or applying the brakes too frequently. This could cause the brakes to overheat and result in reduced braking efficiency.
- Due to the added load of the trailer, your vehicle's engine may overheat on hot days (at temperatures over 85°F [30°C]) when driving up a long

or steep grade. If the engine coolant temperature gauge indicates overheating, immediately turn off the air conditioning (if in use), pull your vehicle off the road and stop in a safe spot. (→P.612)

- Always place wheel blocks under both the vehicle's and the trailer's wheels when parking. Apply the parking brake firmly, and put the transmission in P. Avoid parking on a slope, but if unavoidable, do so only after performing the following:
 - 1 Apply the brakes and keep them applied.
 - 2 Have someone place wheel blocks under both the vehicle's and trailer's wheels.
 - 3 When the wheel blocks are in place, release the brakes slowly until the blocks absorb the load.
 - 4 Apply the parking brake firmly.
 - 5 Shift into P and turn off the engine.
- When restarting after parking on a slope:
 - 1 With the transmission in P, start the engine. Be sure to keep the brake pedal pressed.
 - 2 Shift into a forward gear. If reversing, shift into R.

- 3 If the parking brake is in manual mode, release the parking brake. (→P.227)
- 4 Release the brake pedal, and slowly pull or back away from the wheel blocks. Stop and apply the brakes.
- 5 Have someone retrieve the blocks.

■ Break-in schedule

If your vehicle is new or equipped with any new power train components (such as an engine, transmission, transfer [4WD models], rear differential or wheel bearing), Toyota recommends that you do not tow a trailer until the vehicle has been driven for over 500 miles (800 km).

After the vehicle has been driven for over 500 miles (800 km), you can start towing. However, for the next 500 miles (800 km), drive the vehicle at a speed of less than 45 mph (72 km/h) when towing a trailer, and avoid full throttle acceleration.

■ Maintenance

- If you tow a trailer, your vehicle will require more frequent maintenance due to the additional load. (See “Owner’s Warranty Information Booklet” or “Scheduled Maintenance Guide” / “Owner’s Manual Supplement”.)
- Retighten the fixing bolts of the towing ball and bracket after approximately 600 miles (1000 km) of trailer towing.

■ If trailer sway occurs

One or more factors (crosswinds, passing vehicles, rough roads, etc.) can adversely affect handling of your vehicle and trailer, causing instability.

- If trailer swaying occurs:
 - Firmly grip the steering wheel.

Steer straight ahead. Do not try to control trailer swaying by turning the steering wheel.

- Begin releasing the accelerator pedal immediately but very gradually to reduce speed. Do not increase speed. Do not apply vehicle brakes.

If you make no extreme correction with the steering or brakes, your vehicle and trailer should stabilize. (if enabled, Trailer Sway Control can also help to stabilize the vehicle and trailer.)

- After the trailer swaying has stopped:
 - Stop in a safe place. Get all occupants out of the vehicle.
 - Check the tires of the vehicle and the trailer.
 - Check the load in the trailer. Make sure the load has not shifted. Make sure the tongue weight is appropriate, if possible.
 - Check the load in the vehicle. Make sure the vehicle is not overloaded after occupants get in.

If you cannot find any problems, the speed at which trailer swaying occurred is beyond the limit of your particular vehicle-trailer combination. Drive at a lower speed to prevent instability. Remember that swaying of the towing vehicle-trailer increases as speed increases.

Dinghy towing

Your vehicle is not designed to be dinghy towed (with 4 wheels on the ground) behind a motor home.

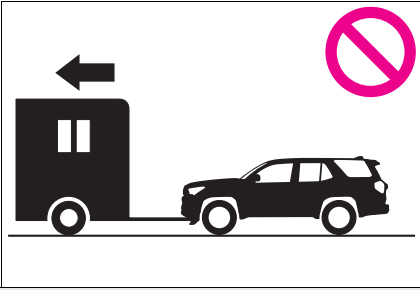
**NOTICE**

■ To avoid serious damage to your vehicle

Do not tow your vehicle with the four wheels on the ground.

Engine (ignition) switch

Performing the following operations when carrying the electronic key on your person starts the engine or changes engine switch modes.

Starting the engine

- 1 Pull the parking brake switch to check that the parking brake is set. (→P.227)
- 2 Check that the shift lever is in P.
- 3 Firmly depress the brake pedal.

 and a message will be displayed on the multi-information display. If it is not displayed, the engine cannot be started.

- 4 Press the engine switch shortly and firmly.

When operating the engine switch, one short, firm press is enough. It is not necessary to press and hold the switch.

The engine will crank until it starts or for up to 30 seconds, whichever is less.

Continue depressing the brake pedal until the engine is completely started.

The engine can be started from any

engine switch mode.

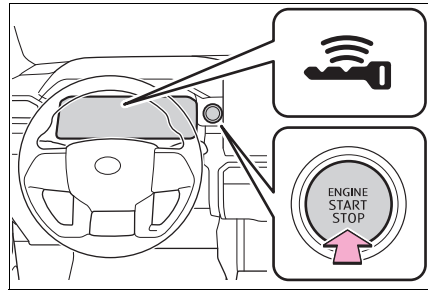

■ Engine switch illumination

According to the situation, the engine switch illumination operates as follows.

- When driver's door or front passenger's door is opened, the engine switch illumination illuminates.
- When the engine switch is in OFF and depressing the brake pedal with carrying the electronic key on your person, the engine switch illumination blinks.
- When the engine switch is in ACC or ON, the engine switch illumination illuminates.
- When the engine switch mode is changed from ACC or ON to OFF, the engine switch illumination illuminates for a certain amount of time. Afterwards, the engine switch illumination turns off.

■ If the engine does not start

- The engine immobilizer system may not have been deactivated. (→P.70)
Contact your Toyota dealer.
- If a message related to start-up is shown on the multi-information display, read the message and follow the instructions.
- If the door is unlocked with the mechanical key, the engine cannot be started using the smart key system. Refer to P.607 to start the engine. However, if the electronic key is carried inside the vehicle

and the doors are locked (→P.122), the engine can be started.

■ If the battery is discharged

The engine cannot be started using the smart key system. Refer to P.608 to restart the engine.

■ Electronic key battery depletion

→P.114

■ Conditions affecting operation

→P.147

■ Notes for the entry function

→P.148

■ If “Smart Key System malfunction See owner’s manual” is displayed on the multi-information display

The system may be malfunctioning. Have the vehicle inspected by your Toyota dealer immediately.

■ When “Check Fuel Cap” is displayed on the multi-information display

→P.247

■ Electronic key battery

→P.558

■ Operation of the engine switch

- If the switch is not pressed shortly and firmly, the engine switch mode may not change or the engine may not start.
- If attempting to restart the engine immediately after turning the engine switch to OFF, the engine may not start in some cases. After turning the engine switch to OFF, please wait a few seconds before restarting the engine.

■ Customization

If the smart key system has been deactivated in a customized setting, refer to P.606.

WARNING

■ When starting the engine

Always start the engine while sitting in the driver’s seat. Do not depress the accelerator pedal while starting the engine under any circumstances.

Doing so may cause an accident resulting in death or serious injury.

NOTICE

■ When starting the engine

- Do not race a cold engine.
- If the engine becomes difficult to start or stalls frequently, have your vehicle checked by your Toyota dealer immediately.

■ Symptoms indicating a malfunction with the engine switch

If the engine switch seems to be operating somewhat differently than usual, such as the switch sticking slightly, there may be a malfunction. Contact your Toyota dealer immediately.

Stopping the engine

- 1 Stop the vehicle completely.
- 2 Set the parking brake (→P.227), and shift the shift lever to P.

Check the parking brake indicator is illuminated.

Do not press the shift release button after shifting the shift lever to P.

- 3 Press the engine switch shortly and firmly.

The engine will stop, and the meter display will be extinguished.

- 4 Release the brake pedal and check that “ACCESSORY” or “IGNITION ON” is not shown on the multi-information display.

■ **When the engine is stopped**

Even if the engine switch is turned off, the cooling fan may continue to operate for a short time.

■ **Automatic engine shut off feature**

- The vehicle is equipped with a feature that automatically shuts off the engine when the shift lever is in P with the engine operating for an extended period.
- The engine will automatically shut off after approximately 1 hour if it has been left running while the shift lever is in P.
- The timer for the automatic engine shut off feature will reset if the brake pedal is depressed or if the shift lever is in a position other than P.
- After the vehicle is parked, if the door is locked with the door lock switch (→P.122) from the inside or the mechanical key (→P.116) from the outside, the automatic engine shut off feature will be disabled. The timer for the automatic engine shut off feature will be re-enabled if the driver’s door is opened.

 **WARNING**

■ **Stopping the engine in an emergency**

- If you want to stop the engine in an emergency while driving the vehicle, press and hold the engine switch for more than 2 seconds, or press it briefly 3 times or more in succession. (→P.568)
However, do not touch the engine switch while driving except in an emergency. Turning the engine off while driving will not cause loss of steering or braking control. However, power assist for these systems may be lost making it difficult to steer or brake before stopping the vehicle depending on the remaining charge in the battery or usage conditions. In this situation, you should pull over and stop the vehicle as soon as it is safe to do so.
- If the engine switch is operated while the vehicle is running, a warning message will be shown on the multi-information display and a buzzer sounds.
- To restart the engine after performing an emergency shut-down, shift the shift lever to N and then press the engine switch.

Changing engine switch modes

Modes can be changed by pressing the engine switch with the brake pedal released. (The mode changes each time the switch is pressed.)

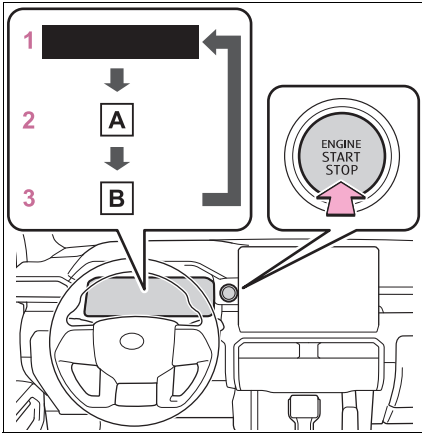

A “ACCESSORY”

B “IGNITION ON”

1 OFF*¹

The emergency flashers can be used.

The multi-information display will not be displayed.

2 ACC*²

Some electrical components such as the audio system can be used. “ACCESSORY” will be displayed on the multi-information display.

3 ON

All electrical components can be used.

“IGNITION ON” will be displayed on the multi-information display.

*¹: If the shift lever is in a position other than P or the shift release button is pressed when turning off the engine, the engine switch will be remained to ON, not to OFF.

*²: ACC mode can be enabled/disabled on the customize menu. (→P.646)

■ **When ACC customization is in off**

With the engine switch turned off, the multimedia system can still be used for a certain time until the battery saving function starts operating.

■ **Auto power off function**

- If the vehicle is left in ACC or ON (the engine is not running) for more than 20 minutes with the shift lever is in P or the shift release button is not pressed, the engine switch will automatically turn to OFF.
- If the battery is low with the shift lever is in P or the shift release button is not pressed, and the engine switch is in ACC or ON (the engine is not running), a buzzer sounds and a message will be displayed on the multi-information display. If this continues, the engine switch is automatically turn to OFF.

However, this function cannot entirely prevent battery discharge. Do not leave the vehicle with the engine switch in ACC or ON for long periods of time when the engine is not running.

 **NOTICE**

■ **To prevent battery discharge**

- Do not leave the engine switch in ACC or ON for long periods of time without the engine running.
- If “ACCESSORY” or “IGNITION ON” is displayed on the multi-information display, the engine switch is not off. Exit the vehicle after turning the engine switch off.

When stopping the engine with the shift lever in a position other than P

If the engine is stopped when the shift lever is in a position other than P or the shift release button is pressed, the engine switch will not be turned to OFF. Perform the following procedure to turn the switch to OFF:

- 1 Check that the parking brake is set.
 - 2 Shift the shift lever to P.
- Do not press the shift release button after shifting the shift lever to P.
- 3 Check that “IGNITION ON” is displayed on the multi-information display and press the engine switch shortly and firmly.
 - 4 Check that “ACCESSORY” or “IGNITION ON” on the multi-information display is off.

 NOTICE

■ To prevent battery discharge

Do not stop the engine with the shift lever in a position other than P or the shift release button pressed. If the engine is stopped with the shift lever in a position other than P or the shift release button pressed, the engine switch will not be turned OFF but instead remain ON. If the vehicle is left in ON, battery discharge may occur.

Automatic transmission

Select the shift position depending on your purpose and situation.

Shift position purpose and functions

Shift position	Objective or function
P	Parking the vehicle/starting the engine
R	Reversing
N	Neutral (Condition in which the power is not transmitted)
D	Normal driving ^{*1}
S	S mode driving ^{*2} (→P.225)

^{*1}: Shifting to the D position allows the system to select a gear suitable for the driving conditions. Setting the shift lever to the D position is recommended for normal driving.

^{*2}: Selecting shift ranges using S mode restricts the upper limit of the possible gear ranges, controls engine braking force, and prevents unnecessary upshifting.

■ Driving on a downhill

On declines, there may be case where the vehicle shifts down automatically to obtain engine braking. As a result of the downshifting, the engine speed may increase.

■ **To protect the automatic transmission**

● If the tires spin continually when the vehicle becomes stuck in mud, dirt or snow, or if the accelerator pedal is depressed and released repeatedly while driving, the automatic transmission temperature may become too high and the automatic transmission may be damaged.

To avoid damaging the automatic transmission, the system may temporarily lock the gear. If the automatic transmission temperature falls, the gear locking is canceled and the automatic transmission is returned to the normal operation.

● If the automatic transmission fluid temperature is high, “Transmission Oil Temp High Stop in a Safe Place and See Owner’s Manual” will be displayed on the multi-information display. Immediately stop the vehicle in a safe place, shift the shift lever to P and wait until the warning message go off. If the warning message go off, you may start the vehicle again. If the warning message do not go off, contact your Toyota dealer.

■ **When driving with the dynamic radar cruise control activated**

Even when switching the driving mode to S mode with the intent of enabling engine braking, engine braking will not occur because dynamic radar cruise control will not be canceled. (→P.225)

● While driving in S mode, downshifting to 6, 5, 4, or 3 is possible based on vehicle speed. (→P.225)

■ **Restraining sudden start (Drive-Start Control)**

→P.199

■ **AI-SHIFT**

The AI-SHIFT automatically selects the suitable gear according to driver operation and driving conditions.

AI-SHIFT automatically operates when the shift lever is in D or S.

⚠ WARNING

■ **When driving on slippery road surfaces**

Do not accelerate or shift gears suddenly. Sudden changes in engine braking may cause the vehicle to spin or skid, resulting in an accident.

Shifting the shift lever

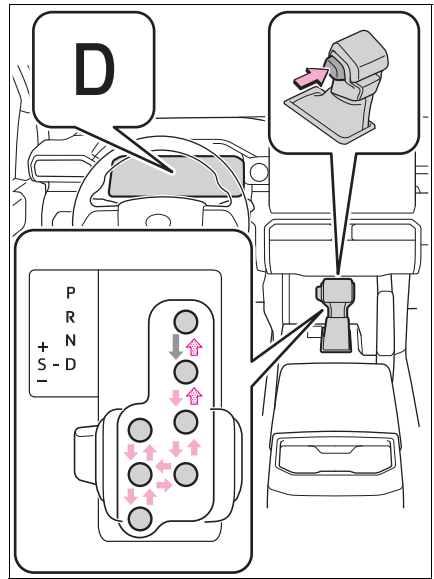

← While the engine switch is in ON and the brake pedal depressed*, shift the shift lever while pushing the shift release button on the shift knob.

← Shift the shift lever while pushing the shift release button on the shift knob.

← SHIFT the shift lever normally.

When shifting the shift lever between P and D, make sure that the vehicle is completely stopped.

*: For the vehicle to be able to be shifted from P, the brake pedal must be depressed before the shift release button is pushed. If the shift release button is pushed first, the shift lock will not be released.

■ **Shift lock system**

The shift lock system is a system to prevent accidental operation of the shift lever in starting. The shift lever can be shifted from P only when the engine switch is in ON, the brake pedal is depressed and the shift release button is pushed.

■ **If the shift lever cannot be shifted from P**

First, check whether the brake pedal is being depressed.

If the shift lever cannot be shifted even though the brake pedal is depressed and the shift release button is pushed, there may be a problem with the shift lock system. Have the vehicle inspected by your Toyota dealer immediately.

The following steps may be used as an emergency measure to ensure that the shift lever can be shifted.

Releasing the shift lock:

- 1 Set the parking brake.
- 2 Turn the engine switch off.
- 3 Depress the brake pedal.
- 4 Pry the cover up with a flathead screwdriver or equivalent tool. To prevent damage to the cover, cover the tip of the screwdriver with a rag.

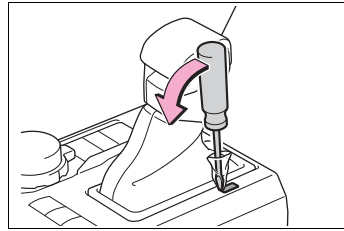

- 5 Press and hold the shift lock override button and then push the button on the shift knob. The shift lever can be shifted while both buttons are pressed.

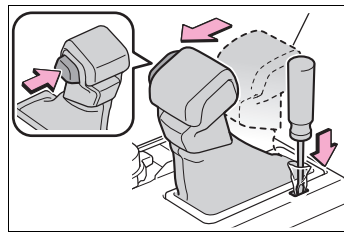

⚠ WARNING

■ **To prevent an accident when releasing the shift lock**

Before pressing the shift lock override button, make sure to set the parking brake and depress the brake pedal.

If the accelerator pedal is accidentally depressed instead of the brake pedal when the shift lock override button is pressed and the shift lever is shifted out of P, the vehicle may suddenly start, possibly leading to an accident resulting in death or serious injury.

Selecting the driving mode

■ **Drive mode**

→P.412

Changing shift ranges in S mode

When the shift lever is in the S position, the shift lever can be operated as follows:

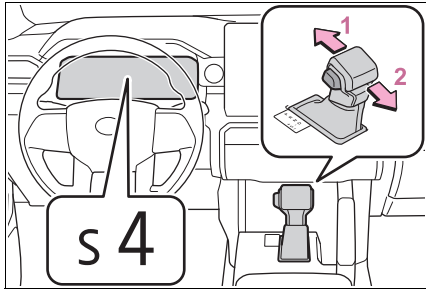

- 1 Upshifting
- 2 Downshifting

The selected shift range, from S1 to S8 will be displayed on the multi-information display.

The initial shift range in S mode is set automatically to 3, 4, 5, 6, or 7 according to vehicle speed.

However, the initial shift range may be set to 4 if AI-SHIFT has operated while the shift lever was in the D position. (→P.223)

S mode

- You can choose from 8 levels of accelerating force and engine braking force.
- A lower shift range will provide greater accelerating force and engine braking force than a higher shift range, and the engine revolutions will also increase.
- To prevent the engine from over revving, upshifting may automatically occur.
- To protect the automatic transmission, a function is adopted that automatically selects a higher shift

- range when the fluid temperature is high.
- When the shift range is 7 or lower, holding the shift lever toward “+” sets the shift range to 8.
- **Downshifting restriction warning buzzer**

To help ensure safety and driving performance, downshifting operation may sometimes be restricted. In some circumstances, downshifting may not be possible even when the shift lever is operated. (A buzzer will sound twice.)

- **If the “S” indicator does not come on even after shifting the shift lever to “S”**

This may indicate a malfunction in the automatic transmission system. Have the vehicle inspected by your Toyota dealer immediately.

“TOW HAUL” switch

Activating “TOW HAUL” mode changes engine, transmission, and steering to be more suitable when pulling a trailer.

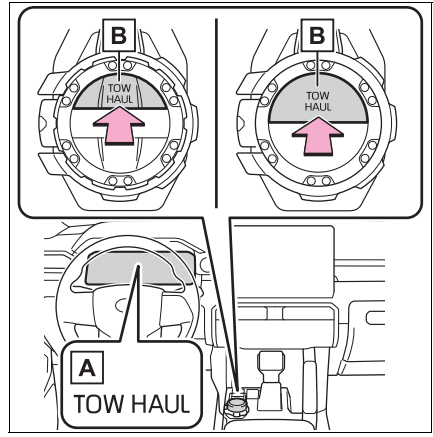

- A “TOW HAUL” indicator
- B “TOW HAUL” switch

Press the “TOW HAUL” switch

The “TOW HAUL” indicator will come on.

Press the switch once more to cancel the mode.

■ **Automatic deactivation of “TOW HAUL” mode**

“TOW HAUL” mode is deactivated the following conditions:

- When the front-wheel drive control switch is in “4L” (part-time 4WD models) or “L4L” (full-time 4WD models)
- When driving mode select or Multi-terrain Select (if equipped) is selected

Turn signal lever

Operating instructions

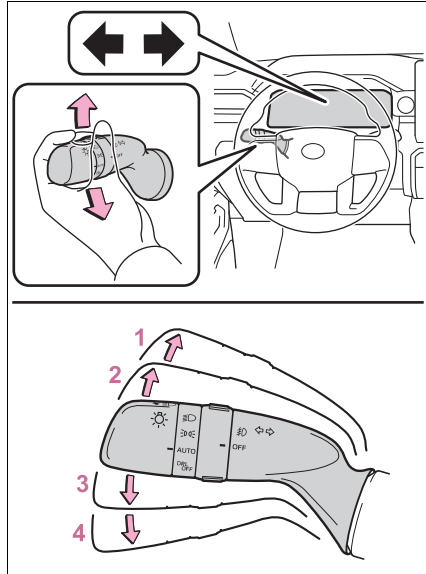

- 1 Right turn
- 2 Lane change to the right (move the lever partway and release it)
The right hand signals will flash 3 times.
- 3 Lane change to the left (move the lever partway and release it)
The left hand signals will flash 3 times.
- 4 Left turn

■ **Turn signals can be operated when**

The engine switch is in ON.

■ **If the indicator flashes faster than usual**

- ▶ Bulb type front turn signal

Check that the front turn signal light bulb has not burned out.

- ▶ LED type turn signal

Have the vehicle inspected by your Toyota dealer.

■ **If the turn signals stop flashing before a lane change has been performed**

Operate the lever again.

Parking brake

The parking brake can be set or released automatically or manually. In automatic mode, the parking brake can be set or released automatically according to shift lever operation.

Also, even in automatic mode, the parking brake can be set or released manually.

Operating instructions

■ **Using the manual mode**

The parking brake can be set and released manually.

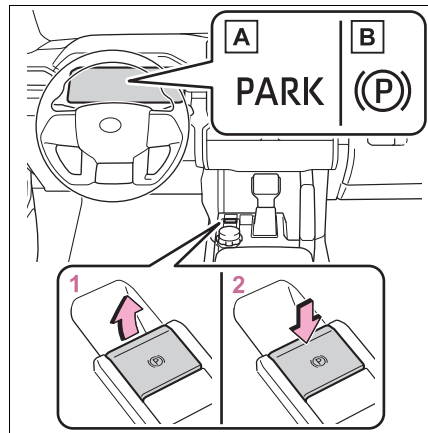

A U.S.A.

B Canada

- 1 Pull the switch to set the parking brake.

The parking brake indicator light will turn on.

Pull and hold the parking brake

switch if an emergency occurs and it is necessary to operate the parking brake while driving.

2 Press the switch to release the parking brake.

- Operate the parking brake switch while depressing the brake pedal.
- Using the parking brake automatic release function, the parking brake can be released by depressing the accelerator pedal. When using this function, slowly depress the accelerator pedal. (→P.228)

Make sure that the parking brake indicator light turn off.

If the parking brake indicator light flash, operate the switch again. (→P.581)

■ Turning the automatic mode on

While the vehicle is stopped, pull and hold the parking brake switch until a buzzer sounds and a message is shown on the multi-information display.

When the automatic mode is turned on, the parking brake operates as follows.

- When the shift lever is shifted from P, the parking brake will be released, and the parking brake indicator light will turn off.
- When the shift lever is shifted to P, the parking brake will be set, and the parking brake indicator light will turn on.

Operate the shift lever with the

vehicle stopped and the brake pedal depressed.

The auto function may not operate if the shift lever is moved extremely quickly or the brake pedal is not firmly depressed. In this situation, apply the parking brake manually.

■ Turning the automatic mode off

While the vehicle is stopped and depressing the brake pedal, press and hold the parking brake switch until a buzzer sounds and a message is shown on the multi-information display.

■ Parking brake operation

- When the engine switch is not in ON, the parking brake cannot be released using the parking brake switch.
- When the engine switch is not in ON, automatic mode (automatic brake setting and releasing) is not available.

■ Parking brake automatic release function

When all of the following conditions are met, the parking brake can be released by depressing the accelerator pedal.

- The driver's door is closed
- The driver is wearing the seat belt
- The shift lever is in a forward driving position or reverse driving position
- The malfunction indicator lamp or brake system warning light is not illuminated

When depressing the accelerator pedal, depress it slowly.

If the parking brake is not released when the accelerator pedal is depressed, release the parking brake manually.

When the shift lever is shifted from P, the parking brake will be released automatically.

■ Parking brake automatic lock function

The parking brake will be set automatically under the following conditions:

- The brake pedal is not depressed
- The driver' door is open
- The driver' seat belt is not fastened
- The shift lever is in a position other than N
- The malfunction indicator lamp and brake system warning light are not illuminated

■ If “Parking Brake Temporarily Unavailable” is displayed on the multi-information display

If the parking brake is operated repeatedly over a short period of time, the system may restrict operation to prevent overheating. If this happens, refrain from operating the parking brake. Normal operation will return after about 1 minute.

■ If “Parking Brake Unavailable” is displayed on the multi-information display

Operate the parking brake switch. If the message does not disappear after operating the switch several times, the system may be malfunctioning. Have the vehicle inspected by your Toyota dealer.

■ Parking brake operation sound

When the parking brake operates, a motor sound (whirring sound) may be heard. This does not indicate a malfunction.

■ Parking brake indicator light

- Depending on the engine switch

mode, the parking brake indicator light will turn on and stay on as described below:

ON: Comes on until the parking brake is released.

Not in ON: Stays on for approximately 15 seconds.

- When the engine switch is turned to OFF with the parking brake set, the parking brake indicator light will stay on for about 15 seconds. This does not indicate a malfunction.

■ When the parking brake switch malfunctions

Automatic mode (automatic brake setting and releasing) will be turned on automatically.

■ Parking the vehicle

→P.193

■ Parking brake engaged warning buzzer

A buzzer will sound if the vehicle is driven with the parking brake engaged. “Parking Brake ON” is displayed on the multi-information display (with the vehicle reaching a speed of 3 mph [5 km/h]).

■ If the brake system warning light comes on

→P.576

■ Usage in winter time

→P.449

WARNING

■ When parking the vehicle

Do not leave a child in the vehicle alone. The parking brake may be released unintentionally by a child and there is the danger of the vehicle moving that may lead to an accident resulting in death or serious injury.

**WARNING****■ Parking brake switch**

Do not set any objects near the parking brake switch. Objects may interfere with the switch and may lead the parking brake to unexpectedly operate.

■ Parking brake automatic lock function

Never use the automatic parking brake engagement function in place of normal parking brake operation. This function is designed to reduce the risk of a collision due to the driver forgetting to engage the parking brake. Over-reliance on this function to park the vehicle safely may lead to an accident resulting in death or serious injury.

■ When the parking brake cannot be released due to a malfunction

Driving the vehicle with the parking brake set will lead to brake components overheating, which may affect braking performance and increase brake wear. Have the vehicle inspected by your Toyota dealer immediately if this occurs.

**NOTICE****■ When parking the vehicle**

Before you leave the vehicle, shift the shift lever to P, set the parking brake and make sure that the vehicle does not move.

■ When the system malfunctions

Stop the vehicle in a safe place and check the warning messages.

■ When the vehicle battery is discharged

The parking brake system cannot be activated. (→P.608)

Brake Hold

The brake hold system keeps the brake applied when the shift lever is in D, S, N or P with the system on and the brake pedal has been depressed to stop the vehicle. The system releases the brake when the accelerator pedal is depressed with the shift lever in D or S to allow smooth start off.

Enabling the system

Turns the brake hold system on

The brake hold standby indicator (green) **A** comes on. While the system is holding the brake, the brake hold operated indicator (yellow) **B** comes on.

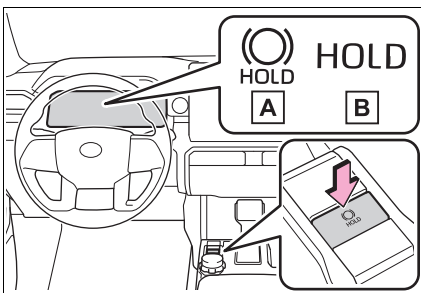

Brake hold system operating conditions

The brake hold system cannot be turned on in the following conditions:

- The driver's door is not closed.
- The driver is not wearing the seat

belt.

If any of the conditions above are detected when the brake hold system is enabled, the system will turn off and the brake hold standby indicator light will go off. In addition, if any of the conditions are detected while the system is holding the brake, a warning buzzer will sound and a message will be shown on the multi-information display. The parking brake will then be set automatically.

Brake hold function

- If the brake pedal is left released for a period of about 3 minutes after the system has started holding the brake, the parking brake will be set automatically. In this case, a warning buzzer sounds and a message is shown on the multi-information display.
- To turn the system off while the system is holding the brake, firmly depress the brake pedal and press the button again.
- The brake hold function may not hold the vehicle when the vehicle is on a steep incline. In this situation, it may be necessary for the driver to apply the brakes. A warning buzzer will sound and the multi-information display will inform the driver of this situation. If a warning message is shown on the multi-information display, read the message and follow the instructions.
- When do not wish for the parking brake to operate automatically, press and hold the brake hold switch until the standby indicator (green) turns off, and then turn the engine switch off.

When the parking brake is set automatically while the system is holding the brakes

Perform any of the following operations to release the parking brake.

- Depress the accelerator pedal.

(The parking brake will not be released automatically if the seat belt is not fastened.)

- Operate the parking brake switch with the brake pedal depressed.

Make sure that the parking brake indicator light goes off. (→P.227)

■ **When an inspection at your Toyota dealer is necessary**

When the brake hold standby indicator (green) does not illuminate even when the brake hold switch is pressed with the brake hold system operating conditions met, the system may be malfunctioning. Have the vehicle inspected at your Toyota dealer.

■ **If “Brake Hold Malfunction Press Brake to Deactivate Visit Your Dealer” or “Brake Hold Malfunction Visit Your Dealer” is displayed on the multi-information display**

The system may be malfunctioning. Have the vehicle inspected by your Toyota dealer.

■ **Warning messages and buzzers**

Warning messages and buzzers are used to indicate a system malfunction or to inform the driver of the need for caution. If a warning message is shown on the multi-information display, read the message and follow the instructions.

■ **When another control activates with the brake hold system**

A message is displayed on the multi-information display in any of the following cases.

- “Brake Hold Unavailable See the Owner’s Manual”
- When the brake hold switch is pressed while the downhill assist control system is activated.
- When the brake hold switch is pressed while the front-wheel drive control switch is turned to “4L” mode (part-time 4WD models) or “L4L” mode (full-time 4WD

models).

- “Brake Hold Unavailable Press Brake to Deactivate”
- When the “DAC/CRAWL” switch is operated while the brake hold system is activated.
- When the four-wheel drive control switch is turned to “4L” mode (part-time 4WD models) or “L4L” mode (full-time 4WD models) while the brake hold system is activated.

The brake hold system and downhill assist control system or transfer “4L” mode (part-time 4WD models) or “L4L” mode (full-time 4WD models) cannot be activated at the same time.

Please press the brake hold switch with the brake pedal depressed to turn off the brake hold system.

■ **If the brake hold operated indicator flashes**

→P.581

 WARNING
<p>■ When the vehicle is on a steep incline</p> <p>Take care when using the brake hold system on a steep incline, exercise caution. The brake hold function may not hold brakes in such situations. Also, the system may not activate depending on the angle of the slope.</p>
<p>■ When stopped on a slippery road</p> <p>The system cannot stop the vehicle when the gripping ability of the tires has been exceeded. Do not use the system when stopped on a slippery road.</p>



NOTICE

■ When parking the vehicle

The brake hold system is not designed for use when parking the vehicle for a long period of time. Turning the engine switch off while the system is holding the brake may release the brake, which would cause the vehicle to move. When operating the engine switch, depress the brake pedal, shift the shift lever to P and set the parking brake.

Headlight switch

The headlights can be operated manually or automatically.

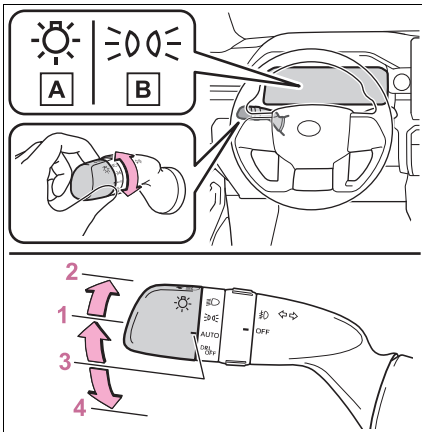

Operating instructions

Operating the  switch turns on the lights as follows:



A U.S.A.

B Canada

- 1  The side marker, parking, tail, license plate, instrument panel lights, and daytime running lights (→P.234) turn on.
- 2  The headlights and all lights listed above (except daytime running lights) turn on.
- 3 AUTO The headlights, day-

time running lights (→P.234) and all the lights listed above turn on and off automatically.

4  (if equipped) Off

■ **AUTO mode can be used when**

The engine switch is in ON.

■ **Daytime running light system**

- Vehicles with bulb type front turn signal lights: The daytime running lights illuminate using the same lights as the low beam headlights and illuminate dimmer than the low beam headlights.
- Vehicles with LED type front turn signal lights: The daytime running lights illuminate using the same lights as the parking lights and illuminate brighter than the parking lights.
- To make your vehicle more visible to other drivers during daytime driving, the daytime running lights turn on automatically when all of the following conditions are met. (The daytime running lights are not designed for use at night.)
 - The engine is started
 - The parking brake is released
 - The headlight switch is in the  or AUTO * position
- *: When the surroundings are bright
- The daytime running lights remain on after they illuminate, even if the parking brake is set again.
- For the U.S.A.: Daytime running lights can be turned off by operating the switch.
- Compared to turning on the headlights, the daytime running light system offers greater durability and consumes less electricity, so it can help improve fuel economy.

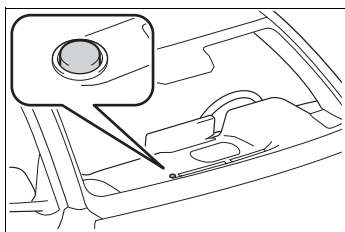

■ **Headlight control sensor**



The sensor may not function properly if an object is placed on the sensor, or anything that blocks the sensor is affixed to the windshield. Doing so interferes with the sensor detecting the level of ambient light and may cause the automatic headlight system to malfunction.

■ **Automatic light off system**

- When the headlights are on: The headlights and tail lights turn off 30 seconds after the driver's door is opened and closed if the engine switch is turned to ACC or OFF. (The lights turn off immediately if  on the key is pressed after all the doors are closed.)
- When only the tail lights are on: The tail lights turn off automatically if the engine switch is turned to ACC or OFF and the driver's door is opened.

To turn the lights on again, turn the engine switch to ON, or turn the light switch AUTO or  once and then back to  or .

■ **Light reminder buzzer**

A buzzer sounds when the engine switch is turned to ACC or OFF and the driver's door is opened while the lights are turned on.

■ **When unlock the doors (welcome lamp) (If equipped)**

When the doors are unlocked using the entry function or wireless remote control, the parking lights turn on

automatically. When the light switch is in the AUTO position and the surrounding area is dark, this function will operate.

■ **Windshield wiper linked headlight illumination**

When driving during daytime with the headlight switch turned to AUTO, if the windshield wipers are used, the headlights will turn on automatically after several seconds to help enhance the visibility of your vehicle.

■ **Battery-saving function**

In order to prevent the battery of the vehicle from discharging, if the headlights and/or tail lights are on when the engine switch is turned to OFF the battery-saving function will operate and automatically turn off all the lights after approximately 20 minutes. When the engine switch is turned to ON, the battery-saving function will be disabled. When any of the following are performed, the battery-saving function is canceled once and then reactivated. All the lights will turn off automatically 20 minutes after the battery-saving function has been reactivated:

- When the headlight switch is operated
- When a door is opened or closed

■ **Customization**

Some functions can be customized. (→P.646)

	NOTICE
■ To prevent battery discharge	
Do not leave the lights on longer than necessary when the engine is not running.	

Turning on the high beam headlights

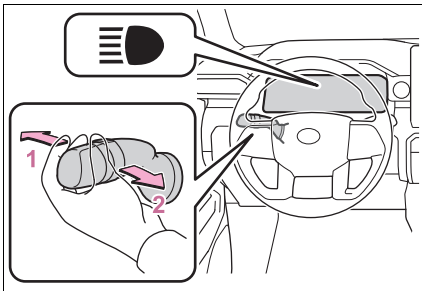

1 With the headlights on, push the lever forward to turn on the high beams.

Pull the lever back to the center position to turn the high beams off.

2 Pull the lever toward you and release it to flash the high beams once.

You can flash the high beams with the headlights on or off.

Manual headlight leveling dial

The vehicle is equipped with manual leveling of the headlamps. The aim of the headlamps can be adjusted by adjusting the dial settings based on your vehicle loading condition.

It is recommended that the headlamps remain adjusted as close to “0” position so not to interfere with other road users.

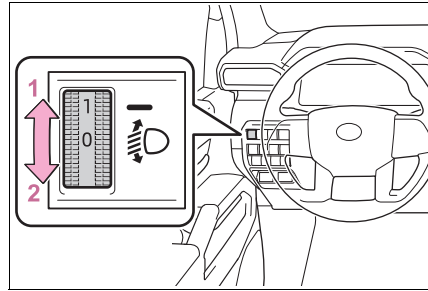

- 1 Raises the level of the headlights
- 2 Lowers the level of the headlights

■ Guide to dial settings

► Single projection lamp

Loading condition		Control switch position
Passengers	Payload	
Driver Only	None	0
Full Occupancy	None	1
Full Occupancy	Maximum Load*	3
Driver Only	Maximum Load*	4

► Dual projection lamp

Loading condition		Control switch position
Passengers	Payload	
Driver Only	None	0
Full Occupancy	None	1

Loading condition		Control switch position
Passengers	Payload	
Full Occupancy	Maximum Load*	2
Driver Only	Maximum Load*	3

*: Maximum load means weight capacity of rear axle or overall vehicle has been reached

Fog light switch

The fog lights secure excellent visibility in difficult driving conditions, such as in rain and fog.

Operating instructions

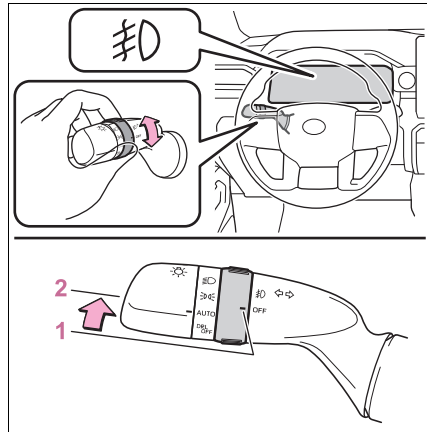

- 1 OFF *1 or ○ *2 Turns the front fog lights off
- 2 ☼ Turns the front fog lights on

*1: U.S.A.

*2: Canada

■ **Fog lights can be used when**
The headlights are on in low beam.

AHB (Automatic High Beam)

The Automatic High Beam uses a front camera located on the upper portion of the windshield to detect the brightness of the lights of vehicles ahead, streetlights, etc., and automatically changes the head lights between the high beams and low beams.

WARNING

■ For safe use

Do not overly rely on the Automatic High Beam. Always drive safely, taking care to observe your surroundings and turning the high beams on or off manually if necessary.

■ To prevent unintentional operation of the Automatic High Beam System

- When it is necessary to disable the system: →P.250

Using the Automatic High Beam System

- 1 Press the Automatic High Beam switch.

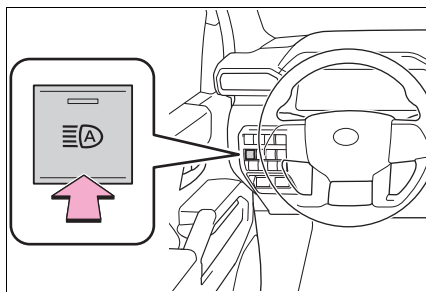

- 2 Turn the headlight switch to the AUTO or  position.

When the headlight switch lever is in the low beam position, the AHB system will be enabled and the AHB indicator will illuminate.

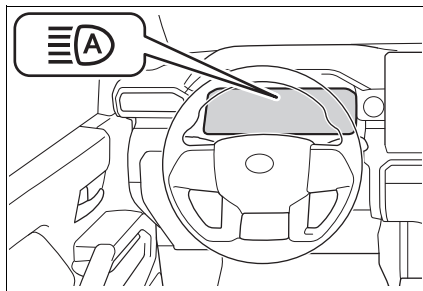

■ Automatic operating conditions of the high beams

- When all of the following conditions are met, the high beams will illuminate automatically:
 - The vehicle speed is approximately 21 mph (34 km/h) or more.
 - The area ahead of the vehicle is dark.
 - There are no vehicles ahead with lights on.
 - There are few streetlights or other lights on the road ahead.
 - If any of the following conditions are met, the headlights will change to the low beams:
 - Vehicle speed drops below approximately 17 mph (27 km/h).
 - The area ahead of the vehicle is not dark.
 - There is a vehicle ahead with lights on.
 - There are many streetlights or other lights on the road ahead.
- ### ■ Front camera detection
- In the following situations, the high beams may not be automatically changed to the low beams:
 - When a vehicle cuts in front of your vehicle
 - When another vehicle crosses in

- front of the vehicle
- When vehicles ahead are repeatedly detected and then hidden due to repeated curves, road dividers or roadside trees
 - When a vehicle ahead approaches from a far lane
 - When a vehicle ahead is far away
 - When a vehicle ahead has no lights
 - When the lights of a vehicle ahead are dim
 - When a vehicle ahead is reflecting strong light, such as own headlights
 - Situations in which the sensors may not operate properly: →P.254
 - The headlights may change to the low beams if a vehicle ahead that is using fog lights without its headlights turned on is detected.
 - House lights, street lights, traffic signals, and illuminated billboards or signs may cause the high beams to change to the low beams, or the low beams to remain on.
 - The following may change the timing at which the headlights change to the low beams:
 - The brightness of lights of vehicles ahead
 - The movement and direction of vehicles ahead
 - The distance between the vehicle and a vehicle ahead
 - When a vehicle ahead only has lights illuminated on one side
 - When a vehicle ahead is a two-wheeled vehicle
 - The condition of the road (gradient, curve, condition of the road surface, etc.)
 - The number of passengers and amount of luggage
 - The headlights may change between the high beams and low beams unexpectedly.
 - Bicycles and other small vehicles may not be detected.
 - In the following situations, the system may not be able to correctly

- detect the brightness of the surroundings. This may cause the low beams to remain on or the high beams to flash or dazzle pedestrians or vehicles ahead. In such a case, it is necessary to manually change between the high beams and low beams.
- When there are lights similar to headlights or tail lights in the surrounding area
- When headlights or tail lights of vehicles ahead are turned off, dirty, changing color, or not aimed properly
- When the headlights are repeatedly changing between the high beams and low beams.
- When use of the high beams is inappropriate or when the high beams may be flashing or dazzling pedestrians or other drivers.
- When the vehicle is used in an area in which vehicles travel on the opposite side of the road of the country for which the vehicle was designed, for example using a vehicle designed for right-hand traffic in a left-hand traffic area, or vice versa
- When it is necessary to disable the system: →P.250
- Situations in which the sensors may not operate properly: →P.254

■ Temporarily reducing front camera sensitivity

The sensitivity of the front camera can be temporarily reduced.

- 1 Turn the engine switch off with the following conditions met.
 - The headlight switch is in the  or AUTO position.
 - The headlight switch lever is in the low beam position.
 - The Automatic High Beam switch is on.
- 2 Turn the engine switch to ON.
- 3 Within 60 seconds after performing step 2, push the headlight

switch lever to the high beam position then pull it to the original position quickly 10 times, then leave the lever in its original position.

- 4 If the sensitivity is changed, the Automatic High Beam indicator will blink 3 times.

Turning the high beams on/off manually

■ Changing to the high beams

Push the lever forward.

The AHB indicator will turn off and the high beam indicator will turn on.

Pull the lever to its original position to enable the Automatic High Beam system again.

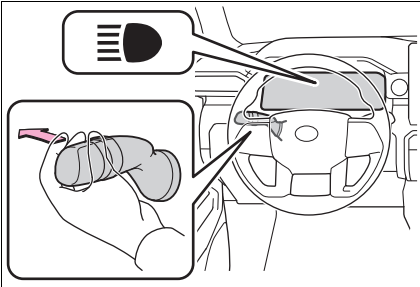

■ Changing to the low beams

Press the Automatic High Beam switch.

The AHB indicator will turn off.

Press the switch to enable the Automatic High Beam system again.

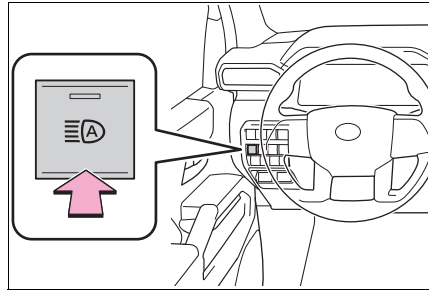

Temporarily changing to the low beams

It is recommended to switch to the low beams when use of the high beams is inappropriate or when the high beams may cause problems or distress to other drivers or pedestrians nearby.

Pull the lever rearward and then return it to its original position.

The high beams will illuminate while the lever is pulled, however, after the lever is returned to its original position, the low beams will remain on for a certain amount of time. After this, the Automatic High Beam system will operate.

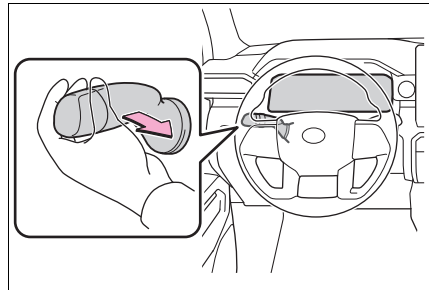

Windshield wipers and washer

Operating the lever can switch between automatic operation and manual operation, or can use the washer.

NOTICE
 ■ **When the windshield is dry**
 Do not use the wipers, as they may damage the windshield.

Operating the wiper lever

Operate the  lever operates the wipers or washer as follows: When intermittent windshield wiper operation is selected, the wiper interval can be also adjusted.

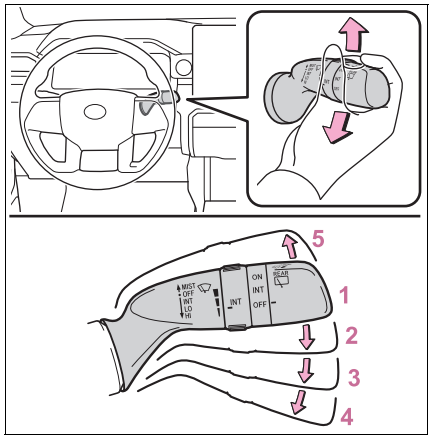

- 1** OFF *1 or ○ *2
Off
- 2** INT *1 or  *2

Intermittent operation

- 3** LO *1 or ▼ *2

Low speed wiper operation

- 4** HI *1 or ▼ *2

High speed wiper operation

- 5** MIST *1 or ▲ *2

Temporary operation

Wiper intervals can be adjusted when intermittent operation is selected.

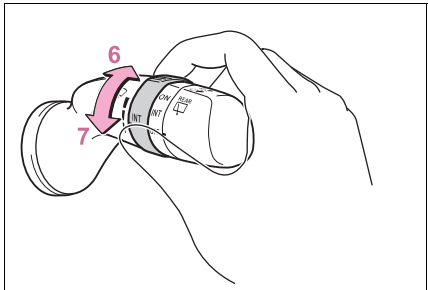

- 6** Increases the intermittent windshield wiper frequency
- 7** Decreases the intermittent windshield wiper frequency

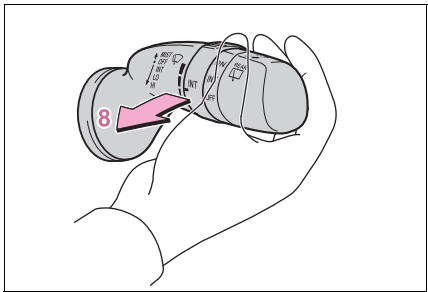

- 8**  Washer/wiper dual operation
 Pulling the lever operates the wipers and washer.
 (After operating several times, the wipers operate once more time)

after a short delay to prevent dripping. However, the dripping prevention does not operate while the vehicle is moving.)

*1: U.S.A.

*2: Canada

■ **The windshield wiper and washer can be operated when**

The engine switch is in ON.

■ **Using the voice control system (if equipped)**

The following operations can be performed using the voice control system:

- Operating the windshield wipers only once
- Operating the windshield washer (it can be performed only when the vehicle is stopped)

For details regarding the voice control system, refer to "MULTIMEDIA OWNER'S MANUAL".

■ **Effects of vehicle speed on wiper operation**

With low speed windshield wiper operation selected, wiper operation will be switched from low speed to intermittent wiper operation when the vehicle is stationary. (However, when the wiper intervals are adjusted to the highest level, the mode will not switch.)

■ **If no windshield washer fluid sprays**

Check that the washer nozzles are not blocked if there is washer fluid in the windshield washer fluid reservoir.

 **WARNING**

■ **Caution regarding the use of washer fluid**

When it is cold, do not use the washer fluid until the windshield becomes warm. The fluid may freeze on the windshield and cause low visibility. This may lead to an accident, resulting in death or serious injury.

 **NOTICE**

■ **When there is no washer fluid spray from the nozzle**

Damage to the washer fluid pump may be caused if the lever is pulled toward you and held continually.

■ **When a nozzle becomes blocked**

In this case, contact your Toyota dealer.
Do not try to clear it with a pin or other object. The nozzle will be damaged.

■ **To prevent battery discharge**

Do not leave the wipers on longer than necessary when the engine is off.

Rear window wiper and washer

The rear window wiper and washer can be used by operating the lever.

 **NOTICE**
■ When the rear window is dry
 Do not use the wiper, as it may damage the rear window.

Operating the wiper lever

Operating the  switch operates the rear wiper as follows.

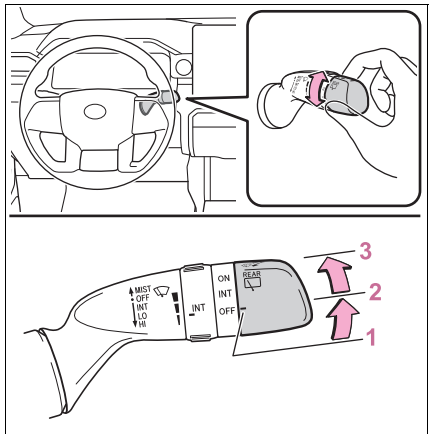

- 1** OFF *1 or ○ *2
Off
- 2** INT *1 or --- *2
Intermittent operation
- 3** ON *1 or — *2
Normal operation

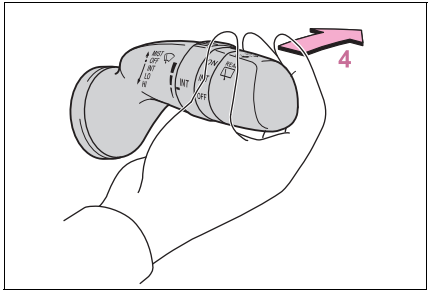

4 Washer/wiper dual operation

Pushing the lever operates the wiper and washer. The wiper will automatically operate a couple of times after the washer squirts. The washer will automatically operate and clean the rear camera.

*1: U.S.A.
 *2: Canada

■ The rear window wiper and washer can be operated when

- The engine switch is in ON.
- The back window is completely closed.

■ Using the voice control system (if equipped)

The following operations can be performed using the voice control system:

- Operating the rear window wiper only once
- Operating the rear window cleaning washer (it can be performed only when the vehicle is stopped)

For details regarding the voice control system, refer to “MULTIMEDIA OWNER’S MANUAL”.

■ If no washer fluid sprays

Check that the washer nozzle is not blocked, if there is washer fluid in

the washer fluid reservoir.

■ **Dripping prevention wiper sweep**

When the washer is operated, the wipers will operate once more time after a short delay to prevent dripping.

■ **Back door opening linked rear window wiper stop function**

When the rear window wiper is operating, if the back door is opened while the vehicle is stopped, operation of the rear window wiper will be stopped to prevent anyone near the vehicle from being sprayed by water from the wiper. When the back door is closed, wiper operation will resume.*

*: The setting must be customized at your Toyota dealer.

■ **Reverse-linked function**

When the shift lever is shifted to R when the front wipers are operating, the rear window wiper will operate once.

■ **Intermittent window wiper operation**

- When intermittent window wiper operation mode is selected, the wiper will operate once and then switch to intermittent operation.
- During intermittent operation, the wiper stops temporarily at the reversing position.

■ **When the rear window wiper and washer switch is turned off**

The rear wiper will stop operation and return to the retracted position after approximately 3 seconds. However, if the engine switch is turned to ACC or turned off while the rear wiper is operating, the rear wiper will stop at that position and will not return to the retracted position.

■ **Customization**

Some functions can be customized.

(→P.647)

 NOTICE

■ **When the washer fluid tank is empty**

Do not operate the switch continually as the washer fluid pump may overheat.

■ **When a nozzle becomes blocked**

In this case, contact your Toyota dealer.

Do not try to clear it with a pin or other object. The nozzle will be damaged.



■ **To prevent battery discharge**

Do not leave the wiper on longer than necessary when the engine is not running.

Changing the rear window wiper rest position

When the rear window wiper is not being used, it retract to rear spoiler. To enable the rear window wiper to be lifted when parking in cold conditions or when replacing a rear window wiper insert, change the rest position of the rear window wiper to the service position using the wiper lever.

■ **Raising the wiper to the service position**

- 1 The back window is completely closed.
- 2 Turn the  switch to the OFF *1 or  *2 position.
- 3 Turn the engine switch off.

- 4 Within approximately 45 seconds of turning the engine switch off, move the wiper lever to the  position and hold it for approximately 2 seconds or more.

The wipers will move to the service position.

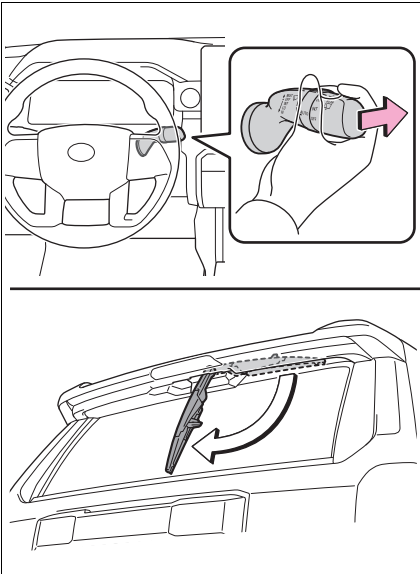

*1: U.S.A.

*2: Canada

■ Lowering the rear window wiper to the retracted position

When the engine switch is ON and one of the following conditions is met, the rear wiper returns to the retracted position.

- When the rear wiper switch is operated
- Vehicle speed is about 4 mph (7 km/h) or more
- When the shift position is set to R

Opening the fuel tank cap

Perform the following steps to open the fuel tank cap:

Before refueling the vehicle

- Turn the engine switch off and ensure that all the doors and windows are closed.
- Confirm the type of fuel.

■ Fuel types

→P.617

■ Fuel tank opening for unleaded gasoline

To help prevent incorrect fueling, your vehicle has a fuel tank opening that only accommodates the special nozzle on unleaded fuel pumps.



WARNING

■ When refueling the vehicle

Observe the following precautions while refueling the vehicle. Failure to do so may result in death or serious injury.

- After exiting the vehicle and before opening the fuel door, touch an unpainted metal surface to discharge any static electricity. It is important to discharge static electricity before refueling because sparks resulting from static electricity can cause fuel vapors to ignite while refueling.

- Always hold the grips on the fuel tank cap and turn it slowly to remove it. A whooshing sound may be heard when the fuel tank cap is loosened. Wait until the sound cannot be heard before fully removing the cap. In hot weather, pressurized fuel may spray out of the filler neck and cause injury.
- Do not allow anyone that has not discharged static electricity from their body to come close to an open fuel tank.
- Do not inhale vaporized fuel. Fuel contains substances that are harmful if inhaled.
- Do not smoke while refueling the vehicle. Doing so may cause the fuel to ignite and cause a fire.
- Do not return to the vehicle or touch any person or object that is statically charged. This may cause static electricity to build up, resulting in a possible ignition hazard.

■ When refueling

Observe the following precautions to prevent fuel overflowing from the fuel tank:

- Securely insert the fuel nozzle into the fuel filler neck.
- Stop filling the tank after the fuel nozzle automatically clicks off.
- Do not top off the fuel tank.

 **NOTICE**

■ Refueling

Do not spill fuel during refueling. Doing so may damage the vehicle, such as causing the emission control system to operate abnormally or damaging fuel system components or the vehicle's painted surface.

Opening the fuel tank cap

1 Press the opener switch.

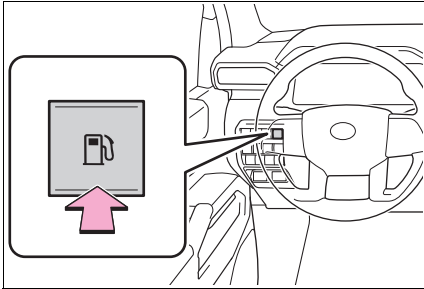

2 Turn the fuel tank cap slowly to open it and put it into the holder on the fuel filler door.

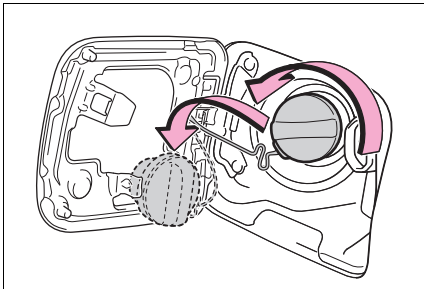

■ If the fuel filler door cannot be opened

Contact your Toyota dealer

Closing the fuel tank cap

After refueling, turn the fuel tank

cap until you hear a click. Once the cap is released, it will turn slightly in the opposite direction.

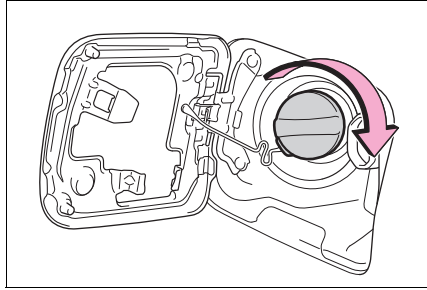

■ When “Check Fuel Cap” is displayed on the multi-information display

The fuel tank cap may be unfastened or loose. Turn the engine switch to OFF, check the cap and tighten it securely. If the message remains, wait a few seconds and then turn the engine switch to OFF once again.

▲ WARNING

■ When replacing the fuel tank cap

Do not use anything but a genuine Toyota fuel tank cap designed for your vehicle. Doing so may cause a fire or other incident which may result in death or serious injury.

■ When Opening the fuel tank cap

Depending on the driving conditions of the vehicle before refueling, it may take some time to reduce the pressure in the tank. Unless there is an actual emergency, do not use the emergency release lever to open the fuel door and then open the fuel tank cap. Doing so may cause fuel to spray out from the fuel filler opening.

Toyota Safety Sense 3.0 software update*

*: If equipped

It is necessary to enter a connected services contract, provided by Toyota, to use these functions. For details, contact your Toyota dealer.

WARNING

■ For safe use

When the Toyota Safety Sense 3.0 software is updated, the operating methods of functions may change. Using this system without knowing the correct operating methods may lead to an accident resulting in death or serious injury.

- Make sure to read the Digital Owner's Manual which corresponds to the software version of the system, available at the Owner's Manual website, before using this system.

Content of the Toyota Safety Sense 3.0 Owner's Manual

This Owner's Manual contains information for Ver. 2. For the latest information about the controls, use, warnings/precautions, etc. of each function of Toyota Safety Sense 3.0, refer to the Digital Owner's Manual at the Owner's Manual website.

Before using this system, be sure to read the Owner's Manual which corresponds to the

software version of the system.

■ Precautions for use

- Be aware that some functions may temporarily be disabled if a legal or safety related issue occurs.
- If a connected services contract has not been entered or has expired, software updates will not be able to be performed wirelessly.

Checking your vehicle's Toyota Safety Sense 3.0 version



To access the appropriate Owner's Manual, it is necessary to check the software version of the system and then visit the Owner's Manual website.

■ Checking the version using Toyota App

The software version of the system can be checked using Toyota App.

■ Selecting your vehicle's Toyota Safety Sense 3.0 version

- 1 Access the following URL using a computer or smartphone:

Country	Language	URL	QR code
U.S.A.	English	https://www.toyota.com/owners/resources/warranty-owners-manuals/manual?om=om35b85u.4runner.2025.2412.cv.vh	
Canada	English	https://www.toyota.ca/toyota/owners/manual?om=om35b85u.4runner.2025.2412.cv.vh	
	French	https://www.toyota.ca/toyota/owners/manual?om=om35b85d.4runner.2025.2412.cv.vh	

- 2 Select the file which includes the previously checked system version.

Updating the software

If a software update is available, a notification will be displayed by Toyota APP. Follow the instructions displayed on the screen.

■ What can be checked using the Toyota APP

The following items can be checked or performed.

- Software version, update details, precautions, use methods, etc.
- Software update

■ Software update precautions

- After a software update has been performed, it will not be possible to revert to a previous version.
- Depending on the communication environment and the content of an update, a software update may take several hours. Although an update will be suspended when the engine switch is turned off, it will resume when the engine switch is changed back to ON.
- Toyota Safety Sense 3.0 can still be used while a software update is being performed.

Toyota Safety Sense 3.0

The Toyota Safety Sense 3.0 consists of the driving assist systems and contributes to a safe and comfortable driving experience:

WARNING

■ Toyota Safety Sense 3.0

The Toyota Safety Sense 3.0 operates under the assumption that the driver will drive safely, and is designed to help reduce the impact to the occupants in a collision and assist the driver under normal driving conditions. As there is a limit to the degree of recognition accuracy and control performance that this system can provide, do not overly rely on this system. The driver is solely responsible for paying attention to the vehicle's surroundings and driving safely.

■ For safe use

- Do not overly rely on this system. The driver is solely responsible for paying attention to the vehicle's surroundings and driving safely. This system may not operate in all situations and provided assistance is limited. Over-reliance on this system to drive the vehicle safely may lead to an accident resulting in death or serious injury.
- Do not attempt to test the operation of the system, as it may not operate properly, possibly leading to an accident.

- If attention is necessary while performing driving operations or a system malfunction occurs, a warning message or warning buzzer will be operated. If a warning message is displayed on the display, follow the instructions displayed.
- Depending on external noise, the volume of the audio system, etc. it may be difficult to hear the warning buzzer. Also, depending on the road conditions, it may be difficult to recognize the operation of the system.

■ When it is necessary to disable the system

In the following situations, make sure to disable the system.

Failure to do so may lead to the system not operating properly, possibly leading to an accident resulting in death or serious injury.

- When the vehicle is tilted due to being overloaded or having a flat tire
- When driving at extremely high speeds
- When towing another vehicle with the TDA (Trailer Driving Assist) (→P.308) deactivated.
- When the vehicle is being transported by a truck, ship, train, etc.
- When the vehicle is raised on a lift and the tires are allowed to rotate freely
- When inspecting the vehicle using a drum tester such as a chassis dynamometer or speedometer tester, or when using an on vehicle wheel balancer
- When the vehicle is driven in a sporty manner or off-road

⚠ WARNING

- When using an automatic car wash
- When a sensor is misaligned or deformed due to a strong impact being applied to the sensor or the area around the sensor
- When accessories which obstruct a sensor or light are temporarily installed to the vehicle
- When a compact spare tire or tire chains are installed to the vehicle or an emergency tire puncture repair kit has been used
- When the tires are excessively worn or the inflation pressure of the tires is low
- When non-genuine Toyota suspension and/or tires other than the manufacturer specified size are installed. (→P.257)
- When the vehicle cannot be driven stably, due to a collision, malfunction, etc.
- When the vehicle is being driven on a slippery surface such as an icy road or a very wet road.

Driving assist systems

- **AHB (Automatic High Beam)**
→P.238
- **PCS (Pre-Collision System)**
→P.259
- **LTA (Lane Tracing Assist)**
→P.270

- **LDA (Lane Departure Alert)**
→P.275
- **PDA (Proactive Driving Assist)**
→P.281
- **RSA (Road Sign Assist) (if equipped)**
→P.288
- **Dynamic radar cruise control**
→P.290
- **Cruise control**
→P.301
- **Emergency Driving Stop System**
→P.305

Sensors used by Toyota Safety Sense 3.0

Various sensors are used to obtain the necessary information for system operation.

- **Sensors which detect the surrounding conditions**

- ▶ Front

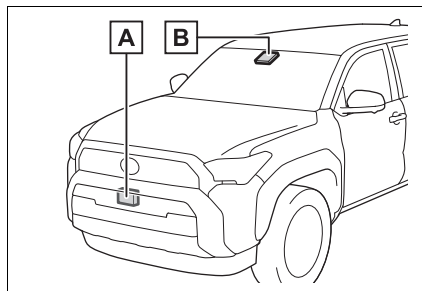

A Front radar sensor

B Front camera

► Rear

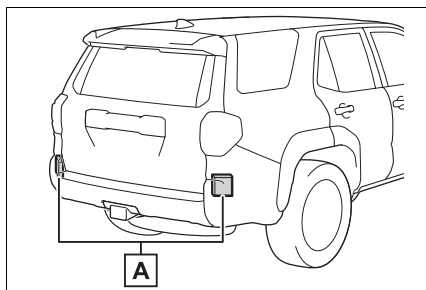

A Rear side radar sensors

⚠ WARNING

■ **To prevent malfunction of the radar sensors**

Observe the following precautions. Failure to do so may lead to a radar sensor not operating properly, possibly leading to an accident resulting in death or serious injury.

- Keep the radar sensors and radar sensor covers clean at all times.

Clean the front of a radar sensor or the front or back of a radar sensor cover if it is dirty or covered with water droplets, snow, etc.

When cleaning the radar sensor and radar sensor cover, use a soft cloth to remove dirt so as to not damage them.

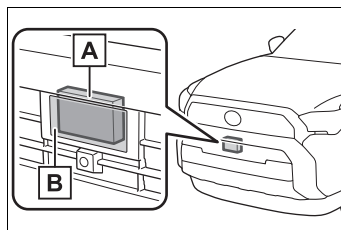

A Radar sensor

B Radar sensor cover

- Do not attach accessories, stickers (including transparent stickers), aluminum tape, etc. to a radar sensor or radar sensor cover and their surrounding area.
- Do not subject a radar sensor or its surrounding area to impact. If a radar sensor, the front grille, or front bumper has been subjected to a impact, have the vehicle inspected by your Toyota dealer.
- Do not disassemble the radar sensors.
- Do not modify or paint the radar sensors or radar sensor cover, or replace them with anything other than Toyota genuine parts.

⚠ WARNING

- In the following situations, recalibration of the radar sensors will be necessary. For details, contact your Toyota dealer.
 - When a radar sensor is removed and installed, or replaced
 - When the front bumper or the front grille has been replaced

■ **To prevent malfunction of the front camera**

Observe the following precautions.

Failure to do so may lead to the front camera not operating properly, possibly leading to an accident resulting in death or serious injury.

- Always keep the windshield clean.
 - If the windshield is dirty or covered with an oily film, water droplets, snow, etc., clean the windshield.
 - Even if a glass coating agent is applied to the windshield, it will still be necessary to use the windshield wipers to remove water droplets, etc. from the area of the windshield in front of the front camera.
 - If the inner side of the windshield where the front camera is installed is dirty, contact your Toyota dealer

- Do not attach stickers (including transparent stickers) or other items to the area of the windshield in front of the front camera (shaded area in the illustration).

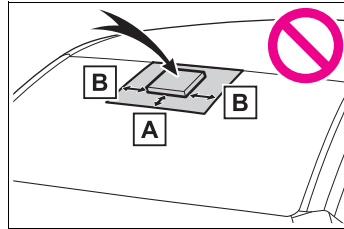

A Approximately 1.6 in. (4 cm)

B Approximately 1.6 in. (4 cm)

- If the part of the windshield in front of the front camera is fogged up or covered with condensation or ice, use the windshield defogger to remove the fog, condensation, or ice.
- If water droplets cannot be properly removed from the area of the windshield in front of the front camera by the windshield wipers, replace the wiper insert or wiper blade.
- Do not attach window tint to the windshield.
- Replace the windshield if it is damaged or cracked.

If the windshield has been replaced, recalibration of the front camera will be necessary. For details, contact your Toyota dealer.

- Do not allow liquids to contact the front camera.
- Do not allow bright lights to shine into the front camera.

**WARNING**

- Do not damage the lens of the front camera or allow it to become dirty.

When cleaning the inside of the windshield, do not allow glass cleaner to contact the lens of the front camera. Do not touch the lens of the front camera.

If the lens of the front camera is dirty or damaged, contact your Toyota dealer.

- Do not subject the front camera to a strong impact.
- Do not change the position or orientation of the front camera or remove it.
- Do not disassemble the front camera.
- Do not modify any parts around the front camera, such as the inside rear view mirror or ceiling.
- Do not attach accessories which may obstruct the front camera to the hood, front grille, or front bumper. For details, contact your Toyota dealer.
- If a surfboard or other long object is to be mounted on the roof, make sure that it will not obstruct the front camera.
- Do not modify or change the headlights and other lights.

Front camera installation area on the windshield

If the system determines that the windshield may be fogged up, it will automatically operate the heater to defog the part of the windshield around the front camera. When cleaning, etc., be careful not to touch the area around the front camera until the windshield has cooled sufficiently, as touching it may cause burns.

Situations in which the sensors and the systems may not operate properly

- When the height or inclination of the vehicle has been changed due to modifications (→P.257)
- When the windshield is dirty, fogged up, cracked or damaged
- When the ambient temperature is high or low
- When mud, water, snow, dead insects, foreign matter, etc., is attached to the front of the sensor
- When in inclement weather such as heavy rain, fog, snow, or a sandstorm
- When water, snow, dust, etc., is thrown up in front of the vehicle, or when driving through mist or smoke
- When the headlights are not illuminated while driving in the dark, such as at night or when in a tunnel
- When the lens of a headlight is dirty and illumination is weak
- When the headlights are misaligned
- When a headlight is malfunctioning
- When the headlights of another vehicle, sunlight, or reflected light shines directly into the front camera

- When the brightness of the surrounding area changes suddenly
- When driving near a TV tower, broadcasting station, electric power plant, radar equipped vehicles, etc., or other location where strong radio waves or electrical noise may be present
- When a wiper blade is blocking the front camera
- When in a location or near objects which strongly reflect radio waves, such as the following:
 - Tunnels
 - Truss bridges
 - Gravel roads
 - Rutted, snow-covered roads
 - Walls
 - Large trucks
 - Manhole covers
 - Guardrail
 - Metal plates
- When near a step or protrusion
- When a detectable vehicle is narrow, such as a small mobility vehicle
- When a detectable vehicle has a small front or rear end, such as an unloaded truck
- When a detectable vehicle has a low front or rear end, such as a low bed trailer

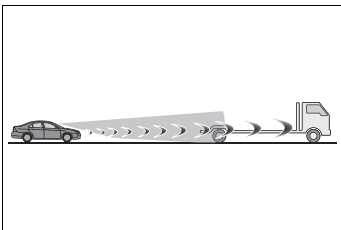

- When a detectable vehicle has extremely high ground clearance

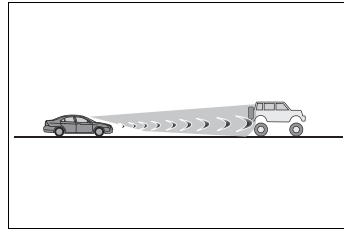

- When a detectable vehicle is carrying a load which protrudes from its cargo area
- When a detectable vehicle has little exposed metal, such as a vehicle which is partially covered with cloth, etc.
- When a detectable vehicle is irregularly shaped, such as a tractor, sidecar, etc.
- When the distance between the vehicle and a detectable vehicle has become extremely short
- When a detectable vehicle is at an angle
- When snow, mud, etc. is attached to a detectable vehicle
- When driving on the following kinds of roads:
 - Roads with sharp curves or winding roads
 - Roads with changes in grade, such as sudden inclines or declines
 - Roads which is sloped to the left or right
 - Roads with deep ruts
 - Roads which are rough and unmaintained
 - Roads which frequently undulate or are bumpy
- When the steering wheel is being operated frequently or suddenly
- When the vehicle is not in a constant position within a lane
- When parts related to this system, the brakes, etc. are cold or extremely hot, wet, etc.
- When the wheels are misaligned
- When driving on slick road sur-

faces, such as when it is covered with ice, snow, gravel, etc.

- When the course of the vehicle differs from the shape of a curve
- When the vehicle speed is excessively high when entering a curve
- When entering/exiting a parking lot, garage, car elevator, etc.
- When driving in a parking lot
- When driving through an area where there are obstructions which may contact your vehicle, such as tall grass, tree branches, a curtain, etc.
- When driving in strong wind

■ **Situations in which the lane may not be detected**

- When the lane is extremely wide or narrow
- Immediately after changing lanes or passing through an intersection
- When driving in a temporary lane or lane regulated by construction
- When there are structures, patterns, shadows which are similar to lane lines in the surrounding
- When there are multiple white lines for a lane line
- When the lane lines are not clear or driving on a wet road surface
- When a lane line is on a curb
- When driving on a bright, reflective road surface, such as concrete

■ **Situations in which some or all of the functions of the system cannot operate**

- When a malfunction is detected in this system or a related system, such as the brakes, steering, etc.
- When the VSC, TRAC, or other safety related system is operating
- When the VSC, TRAC, or other safety related system is off

■ **Changes in brake operation sound and pedal response**

- When the brakes have been operated, brake operation sounds may be heard and the brake pedal response may change, but this does not indicate a malfunction.
- When the system is operating, the brake pedal may feel stiffer than expected or sink. In either situation the brake pedal can be depressed further. Further depress the brake pedal as necessary.

■ **Certification**

→P.686

■ **When the SDM (Stabilizer with Disconnection Mechanism) (if equipped) is operating, (→P.436)**

Each function is limited as follows:

Function	Status
PCS (Pre-Collision System) (→P.259)	○
LTA (Lane Tracing Assist) (→P.270)	—
LDA (Lane Departure Alert) (→P.275)	*1
PDA (Proactive driving assist) (→P.281)	*2
Dynamic radar cruise control (→P.290)	○
Emergency Driving Stop System (→P.305)	—

Definition of symbols:

○= Available,
—= Not available

*1: Alert is available only

*2: Partially unavailable

- When the SDM is operating, the following PDA functions will be disabled:
- PDA-OAA (Obstacle Anticipation Assist) functions

The brake assist function operates, but the steering wheel assist function does not.

- PDA-SA (Steering Assist) function

■ When lift up

When using a lift kit up to 4 in. (101 mm), including tire height.

Toyota recommends the use of a Toyota genuine lift kit as a non-genuine lift kits may degrade system performance.

Details are in the following table.

Suspension variation	Tire variation	Description
Toyota normal suspension	*1	The system will operate normally if the settings comply with Toyota specifications. To verify the settings, visit a Toyota authorized service/repair facility.
Toyota genuine 2.5 inch lift up kit (if equipped)		
Toyota genuine 2.5 inch lift up kit (if equipped)	*2	The system may not operate properly. Please see a Toyota authorized service/repair facility to verify and change the settings.
Toyota normal suspension	*3	This system is not designed to accommodate the configuration. Toyota highly recommends that modifications within this category not be done. Failure to observe this recommendation may cause the system to not operate properly which may lead to an accident. Modifications within this category require an authorized Toyota service/repair facility to disable the Toyota Safety Sense 3.0 functions. However, this may also lead to the possibility of an accident.
Toyota genuine 2.5 inch lift up kit (if equipped)	*4	
Non-genuine lift up kit (if equipped)	Any	

*1: Manufacturer specified tire sizes

*2: Tire sizes up to 3 inches plus the tire size specified by the manufacturer

*3: Any size other than the manufacturer specified tire sizes.

*4: Tire sizes exceeding the range specified in *2.

PCS (Pre-Collision System)

The pre-collision system uses sensors to detect objects (→P.260) in the path of the vehicle. When the system determines that the possibility of a frontal collision with a detectable object is high, a warning operates to urge the driver to take evasive action and the potential brake pressure is increased to help the driver avoid the collision. If the system determines that the possibility of a collision is extremely high, the brakes are automatically applied to help avoid the collision or help reduce the impact of the collision.

The pre-collision system can be disabled/enabled and the warning timing can be changed. (→P.269)

⚠ WARNING**■ For safe use**

● Driving safely is solely the responsibility of the driver. Pay careful attention to the surrounding conditions in order to ensure safe driving. Never use the pre-collision system in place of normal braking operations. This system cannot help avoid or reduce the impact of a collision in every situation. Over-reliance on this system to drive the vehicle safely may lead to an accident resulting in death or serious injury.

● Although the pre-collision system is designed to help avoid or help reduce the impact of a collision, its effectiveness may change according to various conditions. Therefore, it may not always be able to achieve the same level of performance. Read the following items carefully. Do not overly rely on this system and always drive carefully.

• For safe use: →P.250

■ When to disable the pre-collision system

When it is necessary to disable the system: →P.250

■ When towing another vehicle

→P.308

■ When lift up

→P.257

Detectable objects

The system can detect the following as detectable objects. (Detectable objects differ depending on the function.)

- Vehicles
- Bicycles*
- Pedestrians
- Motorcycles*
- Walls

*: Detected as a detectable object only when being ridden.

System functions

■ Pre-collision warning

When the system determines that the possibility of a collision is high, a buzzer will sound and an icon and warning message will be displayed on the multi-information display to urge the driver to take evasive action.

If the detectable object is a vehicle, there may be cases where moderate braking will be performed with the warning.

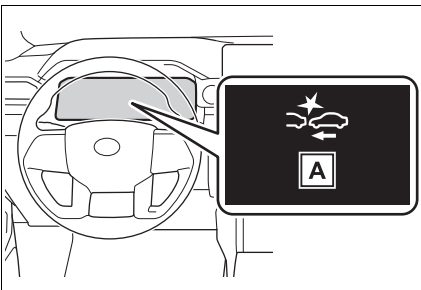

A "Pre-Collision System"

If the system determines that the accelerator pedal is strongly depressed, the following icon and message will be displayed on the multi-information display.

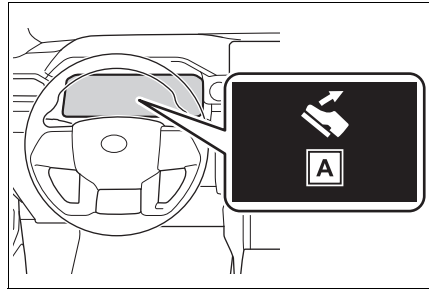

A "Accelerator Pedal is Pressed"

■ Pre-collision brake assist

If the system determines that the possibility of a collision is high and the brake operation by the driver is insufficient, the braking power will be increased.

■ Pre-collision brake control

If the system determines that the possibility of a collision is extremely high, the brakes are automatically applied to help avoid the collision or reduce the impact of the collision.

■ Emergency steering assist

If the system determines that the following conditions are met, assistance will be provided to help enhance vehicle stability and prevent lane departure. During assistance, in addition to the pre-collision warning, the fol-

lowing icon will be displayed on the multi-information display.

- The possibility of a collision is high
- There is sufficient space within the lane to perform evasive steering maneuvers
- The driver is operating the steering wheel

During assistance, the pre-collision warning will operate and a message will be displayed to warn the driver.

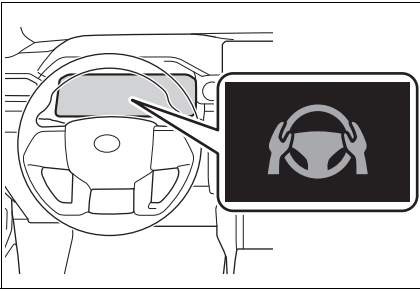

■ Intersection collision avoidance support (left/right turn)

In situations such as the following, if the system determines that the possibility of a collision is high, the pre-collision warning and pre-collision braking will operate.

Depending on the intersection, assistance may not operate correctly.

- When turning left/right at an intersection and crossing the path of an oncoming vehicle

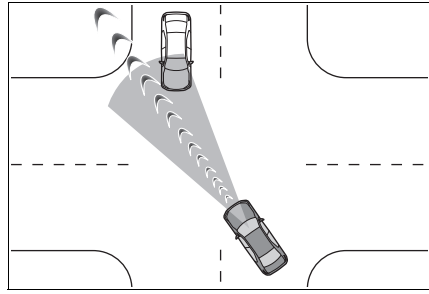

- When turning left/right and a pedestrian or bicycle is detected

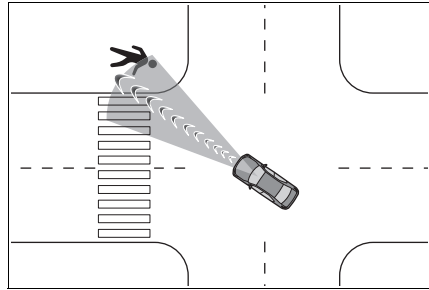

■ Intersection collision avoidance support (crossing vehicles)

At an intersection, etc., if the system determines that the possibility of a collision with an approaching vehicle or motorcycle is high, the pre-collision warning and pre-collision braking will operate.

Depending on the intersection, assistance may not operate correctly.

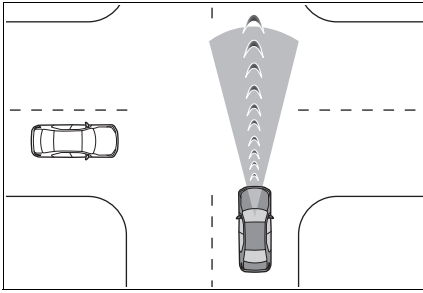

■ Acceleration Suppression at Low Speed

When driving at a low speed, if the accelerator pedal is strongly depressed and the system determines that there is a possibility of a collision, engine output will be restrained or the brakes will be applied weakly to restrict acceleration. During operation, a buzzer will sound and a warning indicator and message will be displayed on the multi-information display.

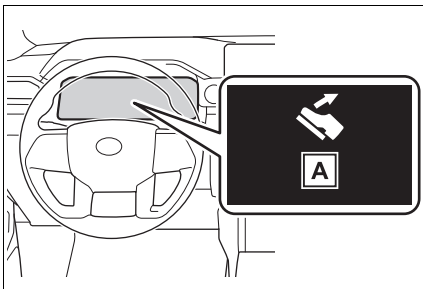

A "Accelerator Pedal is Pressed"

■ Suspension control (vehicles with Adaptive Variable Suspension system)

When the system determines that the possibility of a collision is high, the Adaptive Variable

Suspension system (→P.431) controls the damping force of the shock absorbers to help maintain an appropriate vehicle posture.

⚠ WARNING

■ Pre-collision braking

- When the pre-collision braking function is operating, a large amount of braking force will be applied.
- The pre-collision braking function is not designed to hold the vehicle stopped. If the vehicle is stopped by pre-collision brake control, the driver should operate the brakes immediately as necessary.
- The pre-collision braking function may not operate if certain operations are performed by the driver. If the accelerator pedal is being depressed strongly or the steering wheel is being turned, the system may determine that the driver is taking evasive action and possibly prevent the pre-collision braking function from operating.
- If the brake pedal is being depressed, the system may determine that the driver is taking evasive action and possibly delay the operation timing of the pre-collision brake control.

■ Acceleration Suppression at Low Speed

If the steering wheel is being turned, the system may determine that the driver is taking evasive action and possibly prevent the Acceleration Suppression at Low Speed function from operating or possibly causing its operation to be canceled.

**WARNING****■ Emergency steering assist**

- The emergency steering assist will be canceled when the system determines that lane departure prevention control has completed.
- Depending on operations performed by the driver, emergency steering assist may not operate or operation may be canceled.
- If the accelerator pedal is depressed strongly, the steering wheel is turned heavily, the brake pedal is depressed, or the turn signal lever is operated, the system may determine that the driver is taking evasive action and the emergency steering assist may not operate.
- While the emergency steering assist is operating, if the accelerator pedal is depressed strongly, the steering wheel is turned heavily, or the brake pedal is depressed, the system may determine that the driver is taking evasive action and emergency steering assist operation may be canceled.
- While the emergency steering assist is operating, if the steering wheel is held or turned in the opposite direction of system operation, emergency steering assist operation will be canceled.

■ Operating conditions of each function of the pre-collision system

The pre-collision system is enabled and the system determines that the possibility of a frontal collision with a detected object is high.

However, the system will not operate in the following situations:

- When the vehicle has not been driven a certain amount after a terminal of the battery has been disconnected and reconnected
- When the shift lever is in R

The following are the operational speeds and cancelation conditions of each function:

● Pre-collision warning

Detectable objects	Vehicle speed	Relative speed between your vehicle and object
Preceding vehicles, stopped vehicles	Approximately 3 to 110 mph (5 to 180 km/h)	Approximately 3 to 110 mph (5 to 180 km/h)
Oncoming vehicles	Approximately 20 to 110 mph (30 to 180 km/h)	Approximately 50 to 130 mph (80 to 220 km/h)
Bicycles	Approximately 3 to 50 mph (5 to 80 km/h)	Approximately 3 to 50 mph (5 to 80 km/h)
Pedestrians	Approximately 3 to 50 mph (5 to 80 km/h)	Approximately 3 to 50 mph (5 to 80 km/h)
Preceding motorcycles, stopped motorcycles	Approximately 3 to 110 mph (5 to 180 km/h)	Approximately 3 to 50 mph (5 to 80 km/h)
Oncoming motorcycles	Approximately 20 to 110 mph (30 to 180 km/h)	Approximately 20 to 110 mph (30 to 180 km/h)

While the pre-collision warning is operating, if the steering wheel is operated heavily or suddenly, the pre-collision warning may be canceled.

● Pre-collision brake assist

Detectable objects	Vehicle speed	Relative speed between your vehicle and object
Preceding vehicles, stopped vehicles	Approximately 20 to 110 mph (30 to 180 km/h)	Approximately 7 to 110 mph (10 to 180 km/h)
Bicycles	Approximately 20 to 50 mph (30 to 80 km/h)	Approximately 20 to 50 mph (30 to 80 km/h)
Pedestrians	Approximately 20 to 50 mph (30 to 80 km/h)	Approximately 20 to 50 mph (30 to 80 km/h)
Preceding motorcycles, stopped motorcycles	Approximately 20 to 110 mph (30 to 180 km/h)	Approximately 7 to 50 mph (10 to 80 km/h)

● Pre-collision braking

Detectable objects	Vehicle speed	Relative speed between your vehicle and object
Preceding vehicles, stopped vehicles	Approximately 3 to 110 mph (5 to 180 km/h)	Approximately 3 to 110 mph (5 to 180 km/h)
Oncoming vehicles	Approximately 20 to 110 mph (30 to 180 km/h)	Approximately 50 to 130 mph (80 to 220 km/h)
Bicycles	Approximately 3 to 50 mph (5 to 80 km/h)	Approximately 3 to 50 mph (5 to 80 km/h)
Pedestrians	Approximately 3 to 50 mph (5 to 80 km/h)	Approximately 3 to 50 mph (5 to 80 km/h)
Preceding motorcycles, stopped motorcycles	Approximately 3 to 110 mph (5 to 180 km/h)	Approximately 3 to 50 mph (5 to 80 km/h)
Oncoming motorcycles	Approximately 20 to 110 mph (30 to 180 km/h)	Approximately 20 to 110 mph (30 to 180 km/h)

If either of the following occur while the pre-collision braking function is operating, it will be canceled:

- The accelerator pedal is strongly depressed
- The steering wheel is operated heavily or suddenly
- Emergency steering assist

The emergency steering assist will not operate when the turn signal lights are flashing.

The emergency steering assist will not operate when the VSC OFF indicator is illuminated.

Detectable objects	Vehicle speed	Relative speed between your vehicle and object
Preceding vehicles, stopped vehicles, bicycles, pedestrians, motorcycles	Approximately 25 to 50 mph (40 to 80 km/h)	Approximately 25 to 50 mph (40 to 80 km/h)

While the emergency steering assist is operating, if any of the following are performed, emergency steering assist operation may be canceled:

- The accelerator pedal is strongly depressed
- The steering wheel is operated heavily or suddenly
- The brake pedal is depressed

● Intersection collision avoidance support (left/right turn)

The intersection collision avoidance support (for left/right turning vehicles) will not operate when the turn signal lights are not flashing.

Detectable objects	Vehicle speed	Oncoming vehicle speed	Relative speed between your vehicle and object
Oncoming vehicles	Approximately 3 to 25 mph (5 to 40 km/h)	Approximately 3 to 45 mph (5 to 75 km/h)	Approximately 7 to 70 mph (10 to 115 km/h)
Pedestrians	Approximately 3 to 20 mph (5 to 30 km/h)	-	Approximately 3 to 25 mph (5 to 40 km/h)
Bicycles	Approximately 3 to 20 mph (5 to 30 km/h)	-	Approximately 3 to 30 mph (5 to 50 km/h)
Oncoming motorcycles	Approximately 3 to 25 mph (5 to 40 km/h)	Approximately 3 to 45 mph (5 to 75 km/h)	Approximately 7 to 70 mph (10 to 115 km/h)

● Intersection collision avoidance support (crossing vehicles)

Detectable objects	Vehicle speed	Crossing vehicle speed	Relative speed between your vehicle and object
Vehicles, Motorcycles (side)	Approximately 3 to 38 mph (5 to 60 km/h)	<ul style="list-style-type: none"> ●Your vehicle speed or less ●Approximately 25 mph or less (40 km/h or less) 	Approximately 3 to 38 mph (5 to 60 km/h)

● Acceleration Suppression at Low Speed

The Acceleration Suppression at Low Speed function will not operate when the turn signal lights are flashing.

Detectable objects	Vehicle speed	Relative speed between your vehicle and object
Preceding vehicles, stopped vehicles, Pedestrians, Bicycles, Wall	Approximately 0 to 9 mph (0 to 15 km/h)	Approximately 0 to 9 mph (0 to 15 km/h)

While the Acceleration Suppression at Low Speed function is operating, if

any of the following are performed, the low speed sudden acceleration suppression function operation will be canceled:

- The accelerator pedal is released.
- The steering wheel is operated heavily or suddenly

■ Detection of detectable objects

Objects are detected based on their size, shape, and movement.

Depending on the ambient brightness, movement, posture and direction of a detectable object, it may not be detected and the system may not operate properly.

The system detects shapes, such as the following, as detectable objects.

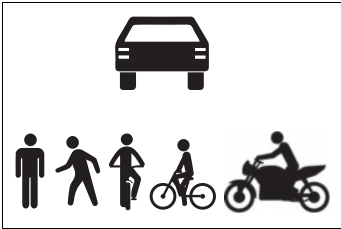

■ Situations in which the system may operate even though the possibility of a collision is not high

- In certain situations, such as the following, the system may determine that the possibility of a collision is high and operate:
 - When passing a detectable object
 - When changing lanes while overtaking a detectable object
 - When suddenly approaching a detectable object
 - When approaching a detectable object or other object on the roadside, such as guardrails, utility poles, trees, walls, etc.
 - When there is a detectable object or other object by the roadside at the entrance of a curve

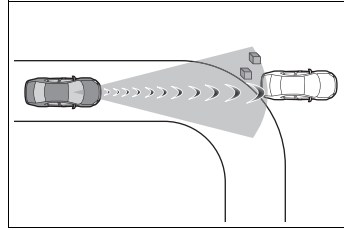

- When there are patterns or a painting ahead of the vehicle that may be mistaken for a detectable object
- When passing a detectable object that is changing lanes or turning left/right

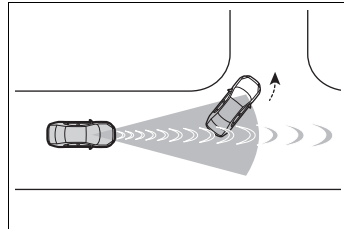

- When passing a detectable object which is stopped to make a left/right turn

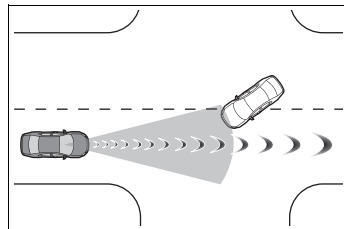

- When a detectable object stops immediately before entering the path of the vehicle
- When passing through a location with a structure above the road (traffic sign, billboard, etc.)

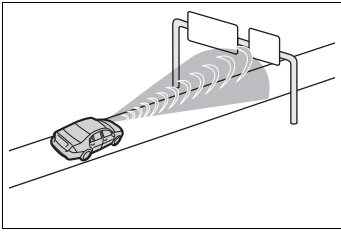

- When approaching an electric toll gate barrier, parking lot barrier, or other barrier that opens and closes
- When turning left/right and an oncoming vehicle, oncoming motorcycle, pedestrian or bicycle crosses in front of the vehicle
- When attempting to turn left/right in front of an oncoming vehicle, oncoming motorcycle, pedestrian or bicycle
- When turning left/right and an oncoming vehicle, oncoming motorcycle, pedestrian or bicycle stops or changes course immediately before entering the path of the vehicle
- When turning left/right and an oncoming vehicle turns left/right in front of the vehicle

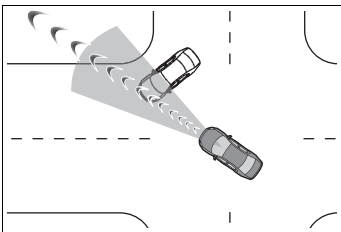

- When the steering wheel is operated toward the path of an oncoming vehicle
- When there is an object moving above or under the road

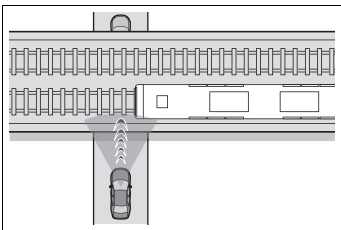

■ Situations in which the system may not operate properly

- In certain situations, such as the following, a detectable object may not be detected by the front sensors, and the system may not operate properly:
 - When a detectable object is approaching your vehicle
 - When your vehicle or a detectable object is wandering
 - When a detectable object makes an abrupt maneuver (such as sudden swerving, acceleration or deceleration)
 - When suddenly approaching a detectable object
 - When the detectable object is near a wall, fence, guardrail, manhole cover, steel plate on the road surface, or another vehicle
 - When there is a structure above a detectable object
 - When part of a detectable object is hidden by another object (large luggage, umbrella, guardrail, etc.)
 - When multiple detectable objects are overlapping
 - When a bright light, such as the sun, is reflecting off of a detectable object
 - When a detectable object is white and looks extremely bright
 - When the color or brightness of a detectable object causes it to blend in with its surroundings
 - When a detectable object cuts in front of or suddenly emerges in front of your vehicle
 - When approaching a vehicle which is diagonal
 - If a bicycle is a child sized bicycle, is carrying a large load, is carrying an extra passenger, is carrying a forward leaning rider, or has an unusual shape (bicycles equipped with a child seat, tandem bicycles, etc.)
 - If a pedestrian or bicycle is shorter than approximately 3.2 ft. (1 m) or taller than approximately 6.5 ft. (2 m).
 - When the silhouette of a pedestrian or bicycle is unclear (such as

when they are wearing a raincoat, long skirt, etc.)

- When a pedestrian is bending forward or squatting
- When a pedestrian or bicycle is moving at high speed
- When a pedestrian is pushing a stroller, wheelchair, bicycle or other vehicle
- When a detectable object blends in with the surrounding area, such as when it is dim (at dawn or dusk) or dark (at night or in a tunnel)
- When the vehicle has not been driven for a certain amount of time after the engine was started
- While turning left/right or a few seconds after turning left/right
- While driving around a curve and a few seconds after driving around a curve
- When turning left/right and an oncoming vehicle is driving in a lane 3 or more lanes from the vehicle
- When turning left/right and the direction of the vehicle differs greatly from the direction traffic flows in the oncoming lane

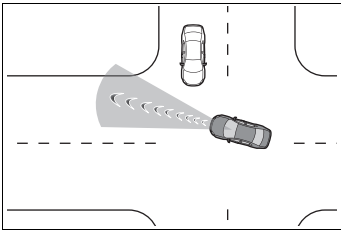

- When turning left/right, a pedestrian or bicycle behind the vehicle comes in front of it as if it overtakes the vehicle

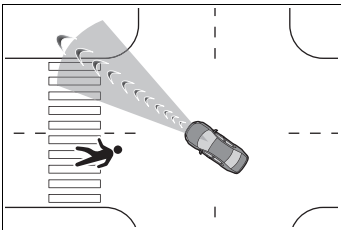

- When at an intersection, the approaching crossing vehicle is

long in overall length, such as a large truck, towing trailer, etc.

- In addition to the preceding, in certain situations, such as the following, the emergency steering assist may not operate properly:
 - When a detectable object is too close to the vehicle
 - When there is insufficient space to perform evasive steering maneuvers or an obstruction exists in the evasion direction
 - When there is an oncoming vehicle
- In addition to the preceding, in certain situations, such as the following, walls may not be detected as a target object and the Acceleration Suppression at Low Speed function may not operate properly:
 - When scenery behind the wall is visible, such as a glass door, grid fence, etc.
 - When the wall is slanted or low
 - When the wall is narrow, such as a pole, etc.
 - When the wall is made of plants, such as a hedge, etc.
 - When the road, etc. is reflected on the wall
 - When the vehicle is approaching the wall at an angle



Changing the pre-collision setting

- The pre-collision system can be enabled/disabled through a customize setting. (→P.637)

The system is enabled each time the engine switch is turned to ON.

- When the system is disabled, the PCS warning light will illuminate and a message will be displayed on the multi-information display.
- The pre-collision setting can

be changed on the customize settings. (→P.637)

- When the pre-collision warning timing is changed, the emergency steering assist timing will also be changed. When “ (later)” is selected, the emergency steering assist will not operate in most cases.
- When the dynamic radar cruise control is operating, the pre-collision warning will operate at the “ (Earlier)” timing, regardless of the user setting.

LTA (Lane Tracing Assist)

LTA functions

- When driving on a road with clear lane lines with the dynamic radar cruise control operating, lane lines and preceding and surrounding vehicles are detected using the front camera and radar sensor, and the steering wheel is operated to maintain the vehicle's lane position.

Use this function only on highways and expressways.

If the dynamic radar cruise control is not operating, the function will not operate.

In situations where the lane lines are difficult to see or are not visible, such as when in a traffic jam, support will be provided using the path of preceding and surrounding vehicles.

If the system determines that the steering wheel has not been operated for a certain amount of time or the steering wheel is not being firmly gripped, the driver will be alerted and this function will be temporarily canceled.

If the steering wheel is firmly gripped, the function will begin operating again.

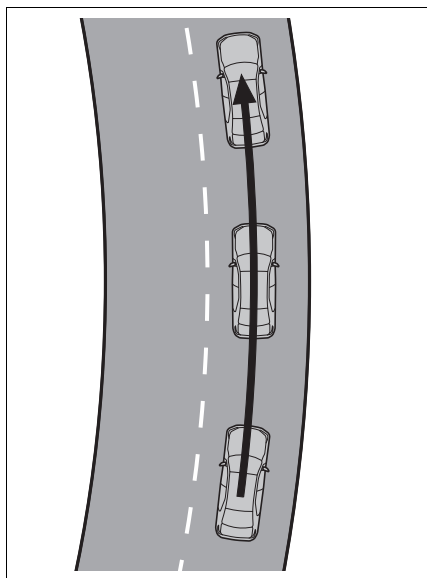

- When the function is operating, if the vehicle is likely to depart from its lane, the driver will be alerted via a display and buzzer.

When the buzzer sounds, check the area around the vehicle and carefully operate the steering wheel to move the vehicle back to the center of the lane.

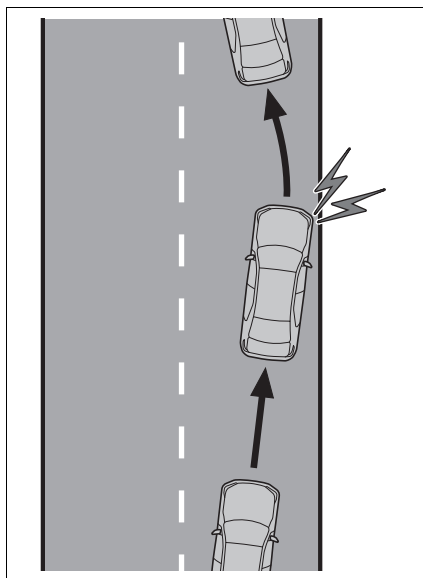

WARNING

■ **Before using the LTA system**

- Do not overly rely on the LTA system. The LTA system is not a system which provides automated assistance in driving and it is not a system which reduces the amount of attention necessary for safe driving. The driver is solely responsible for paying attention to their surroundings and operating the steering wheel as necessary to ensure safety. Also, the driver is responsible for taking adequate breaks when fatigued, such as when driving for a long time.
- Failure to perform appropriate driving operations and pay careful attention may lead to an accident.
- When not using the LTA system, turn it off using the LTA switch.

■ Operating conditions of function

This function is operable when all of the following conditions are met:

- The LTA system detects lane lines or the path of preceding or surrounding vehicles.
- The dynamic radar cruise control is operating.
- The lane width is approximately 10 to 13 ft. (3 to 4 m).
- The turn signal lever is not being operated.
- The vehicle is not being driven around a sharp curve.
- The vehicle is not accelerating or decelerating more than a certain amount.
- The steering wheel is not being turned with a large force.
- The hands off steering wheel warning (→P.272) is not operating.
- The vehicle is being driven in the center of a lane.
- TDA (Trailer Driving Assist) is not operating (→P.308)

■ Temporary cancelation of functions

- When the operating conditions are no longer met, a function may be temporarily canceled. However, when the operation conditions are met again, operation of the function will automatically be restored. (→P.272)
- If the operating conditions of a function are no longer met while the function is operating, a buzzer may sound to indicate that the function has been temporarily canceled.
- The steering assist operation of the function can be overridden by the steering wheel operation of the driver.

■ Lane departure warning function when the LTA is operating

- Even if the LDA warning method is changed to vibration of the steering wheel, if the vehicle deviates from the lane while the LTA is operating, the warning buzzer will sound to alert the driver.
- If steering wheel operation equivalent to that necessary for a lane change is detected, the system will determine the vehicle is not deviating from the lane and the warning will not operate.

■ Hands off steering wheel warning operation

- When the system determines the driver is not holding the steering wheel, a message urging the driver to grip the steering wheel and the icon shown in the illustration will be displayed on the multi-information display to warn the driver. If the system detects that the steering wheel is held, the warning will be canceled. When using the system, make sure to grip the steering wheel firmly, regardless of whether the warning is operating or not.

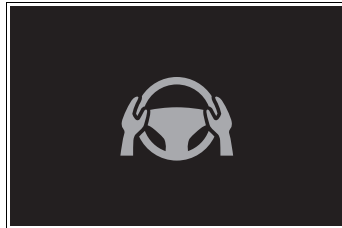

- If no operations are detected for a certain amount of time, the warning will operate, and the function will be temporarily canceled. This warning may also operate if the driver only operates steering wheel a small amount continuously.
- ### ■ Situations in which the hands off steering wheel warning may not operate properly
- Depending on the condition of the

vehicle, handle control condition and road surface, the warning function may not operate.

Enabling/disabling the system

The LTA will change between ON/OFF each time the LTA switch is pressed.

When the LTA is ON, the LTA indicator will illuminate.

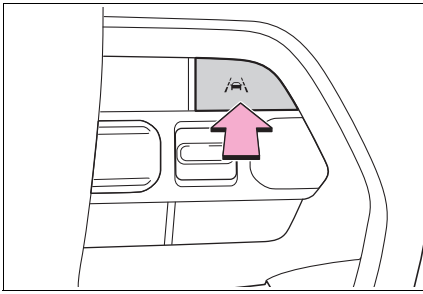

⚠ WARNING

■ **Situations in which the functions may not operate properly**

In the following situations, the functions may not operate properly and the vehicle may depart from its lane. Do not overly rely on these functions. The driver is solely responsible for paying attention to their surroundings and operating the steering wheel as necessary to ensure safety.

- When a preceding or surrounding vehicle changes lanes (Your vehicle may follow the preceding or surrounding vehicle and also change lanes)

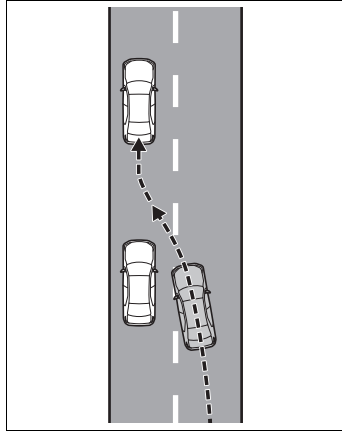









- When a preceding or surrounding vehicle is swaying (Your vehicle may sway accordingly and depart from the lane)
- When a preceding or surrounding vehicle departs from a lane (Your vehicle may follow the preceding or surrounding vehicle and also depart from the lane)
- When a preceding or surrounding vehicle is being driven extremely close to the left/right lane line (Your vehicle may follow the preceding or surrounding vehicle accordingly and depart from the lane)
- When there are moving objects or structures in the surrounding area (Depending on the position of the moving object or structure relative to your vehicle, your vehicle may sway)
- When the vehicle is struck by a crosswind or the turbulence of other nearby vehicles

⚠ WARNING

- Situations in which the sensors may not operate properly: →P.254
- Situations in which the lane may not be detected: →P.256
- When it is necessary to disable the system: →P.250

Operation display of steering wheel operation support

The operating state of the LTA system is indicated.

Indicator	Lane display	Steering icon	Situation
 White	 Gray/White	 Gray	LTA is on standby
 Green	 Green	 Green	LTA is operating
 Yellow Flashing	 Yellow Flashing	 Green	The vehicle is departing the lane toward the side which the lane display is flashing

LDA (Lane Departure Alert)

Basic functions

The LDA system warns the driver if the vehicle may deviate from the current lane or course*, and also can slightly operate the steering wheel to help avoid deviation from the lane or course*.

The front camera is used to detect lane lines or a course*.

*: Boundary between the asphalt and grass, soil, etc., or structures, such as a curb, guardrail, etc.

■ Lane departure alert function

When the system determines that the vehicle might depart from its lane or course*, a warning is displayed on a display, and either a warning buzzer will sound or the steering wheel will vibrate to alert the driver.

Check the area around your vehicle and carefully operate the steering wheel to move the vehicle back to the center of the lane or course*.

If the system determines that the vehicle may collide with a vehicle in an adjacent lane, the lane departure alert will operate even if the turn signals are operating.

*: Boundary between the asphalt and grass, soil, etc., or structures, such as a curb, guardrail, etc.

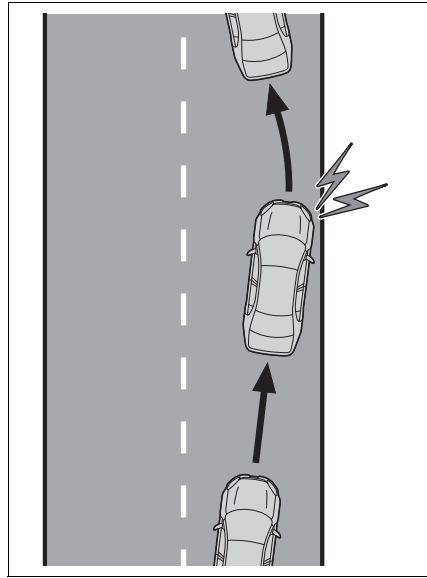

■ Lane departure prevention function

If the system determines that the vehicle is likely to depart from its lane or course*, it provides assistance through steering wheel operations to help avoid deviation from the lane or course.

If the system determines that the steering wheel has not been operated for a certain amount of time or the steering wheel is not being firmly gripped, a warning message may be displayed and a warning buzzer may sound to alert the driver.

If the system determines that the vehicle may collide with a vehicle in an adjacent lane, the lane departure prevention function will operate even if the turn signals are operating.

*: Boundary between the asphalt

and grass, soil, etc., or structures, such as a curb, guardrail, etc.

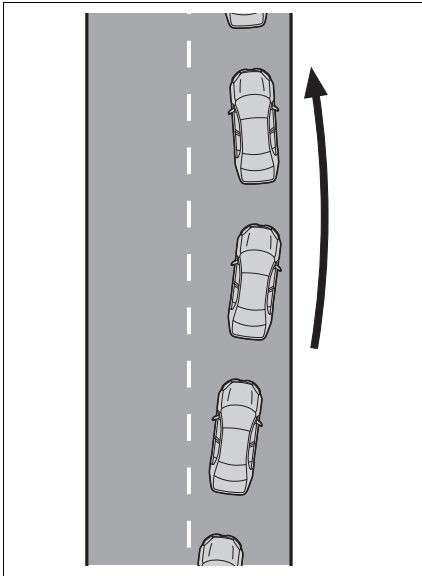

■ Break suggestion function

If the vehicle is swaying, a message will be displayed and a buzzer will sound to urge the driver to take a break.

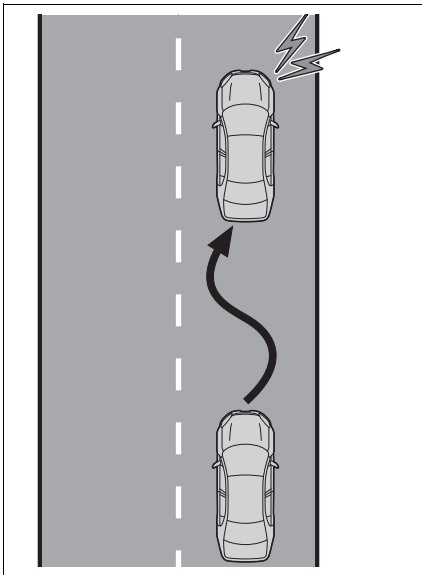

! WARNING

■ Before using the LDA system

- Do not overly rely on the LDA system. The LDA system is not a system which provides automated assistance in driving. However, as it is not a system which reduces the amount of attention necessary for safe driving. The driver is solely responsible for paying attention to their surroundings and operating the steering wheel as necessary to ensure safety. Also, the driver is responsible for taking adequate breaks when fatigued, such as when driving for a long time.
- Failure to perform appropriate driving operations and pay careful attention may lead to an accident.

■ Operating conditions of each function

- Lane departure alert/prevention function

This function is operable when all of the following conditions are met:

- The vehicle speed is approximately 30 mph (50 km/h) or more. Operation may be possible when the vehicle speed is approximately 25 mph (40 km/h) or more if vehicles, motorcycles, bicycles, or pedestrians are detected near the lane.
- The system recognizes a lane or course*. (When recognized on only one side, the system will operate only for the recognized side.)
- The lane width is approximately 9.8 ft. (3 m) or more.
- The turn signal lever is not being operated. (Except when a vehicle is detected in the direction that the turn signal lever is operated.)

- The vehicle is not being driven around a sharp curve.
- The vehicle is not accelerating or decelerating more than a certain amount.
- The steering wheel is not being turned sufficiently to perform a lane change.
- The VSC or TRAC system is not turned off

*: Boundary between the asphalt and grass, soil, etc., or structures, such as a curb, guardrail, etc.

■ Temporary cancellation of functions

When the operating conditions are no longer met, a function may be temporarily canceled. However, when the operation conditions are met again, operation of the function will automatically be restored. (→P.276)

■ Operation of the lane departure alert function/lane departure prevention function

- Depending on the vehicle speed, road conditions, lane departure angle, etc., operation of the lane departure prevention function may not be felt or the function may not operate.
- Depending on the conditions, the warning buzzer may operate even if vibration is selected through a customize setting.
- If a course* is not clear or straight, the lane departure alert function or lane departure prevention function may not operate.
- The lane departure alert function or lane departure prevention function may not operate if the system judges that the vehicle is intentionally being steered to avoid a pedestrian or parked vehicle.
- It may not be possible for the system to judge if there is danger of a collision with a vehicle in an adjacent lane.

- The steering assist operation of the lane departure prevention function can be overridden by the steering wheel operation of the driver.

*: Boundary between the asphalt and grass, soil, etc., or structures, such as a curb, guardrail, etc.

■ When towing another vehicle

→P.308

■ When lift up

→P.257

■ Hands off steering wheel warning operation

In the following situations, a message urging the driver to operate the steering wheel and an icon will be displayed and a buzzer will sound to warn the driver. When using the system, make sure to grip the steering wheel firmly, regardless of whether the warning is operating or not.

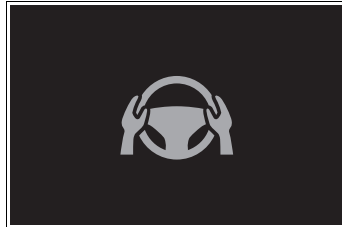

- When the system determines that the driver is not securely holding the steering wheel, or the steering wheel is not being operated when the steering assist operation of the lane departure prevention function is operating

Except for Puerto Rico, A.Samoa: The length of time that the warning buzzer operates will become longer as the frequency of the steering assist operating increases. If the system judges that the steering wheel has been operated, the warning buzzer will stop.

For Puerto Rico, A.Samoa: The length of time that the warning buzzer operates will become longer

as the frequency of the steering assist operating increases. Even if the system judges that the steering wheel has been operated, the warning buzzer will sound for a certain amount of time.

■ Break suggestion function

This function is operable when all of the following conditions are met:

- The vehicle speed is approximately 32 mph (50 km/h) or more.
- The lane width is approximately 9.8 ft. (3 m) or more.

Depending on the condition of the vehicle and road surface, the break suggestion function may not operate.



Changing LDA settings

- The LDA system can be enabled/disabled through a customize setting. (→P.637)
- The settings of the LDA can be changed on the customize settings. (→P.637)

! WARNING

■ Situations in which the system may not operate properly













In the following situations, the system may not operate properly and the vehicle may depart from its lane. Do not overly rely on these functions. The driver is solely responsible for paying attention to their surroundings and operating the steering wheel as necessary to ensure safety.

- When the boundary between the asphalt and grass, soil, etc., or structures, such as a curb, guardrail, etc. is not clear or straight
- When the vehicle is struck by a crosswind or the turbulence of other nearby vehicles
- Situations in which the lane may not be detected: →P.256
- Situations in which the sensors may not operate properly: →P.254
- Situations in which some or all of the functions of the system cannot operate: →P.256
- When it is necessary to disable the system: →P.250











Displays and system operation

The operating state of the lane departure alert function and steering assist operation of the lane departure prevention function are indicated.

► Except for Puerto Rico, A.Samoa

Indicator	Lane display	Steering icon	Situation
Not illuminated	Not illuminated	Not illuminated	System disabled
 White	 Gray	Not illuminated	Lane lines are not detected by the system
 White	 White	Not illuminated	Lane lines are detected by the system
 Yellow Flashing	 Yellow Flashing	Not illuminated	Lane departure alert function is operating for the side which the lane display is flashing
 Green	 Green	 Green	Lane departure prevention function is operating for the side which the lane display is illuminated
 Yellow Flashing	 Yellow Flashing	 Green	Lane departure alert function/lane departure prevention function is operating for the side which the lane display is flashing

► For Puerto Rico, A.Samoa

Indicator	Lane display	Steering icon	Situation
 Yellow Illuminated	Not illuminated	Not illuminated	System disabled
Not illuminated	 Gray	Not illuminated	Lane lines are not detected by the system
Not illuminated	 White	Not illuminated	Lane lines are detected by the system
 Yellow Flashing	 Yellow Flashing	Not illuminated	Lane departure alert function is operating for the side which the lane display is flashing
 Green	 Green	 Green	Lane departure prevention function is operating for the side which the lane display is illuminated
 Yellow Flashing	 Yellow Flashing	 Green	Lane departure alert function/lane departure prevention function is operating for the side which the lane display is flashing

PDA (Proactive driving assist)

When a detectable object (→P.282) is detected, the proactive driving assist operates the brakes and steering wheel to help prevent the vehicle from approaching too close to the object.

 **WARNING**
 **For safe use**

Driving safely is solely the responsibility of the driver.

- The proactive driving assist is designed to provide some assistance for regular braking and steering operations, as well as helping to prevent the vehicle from approaching too close to a detectable object. However, the scope of this assistance is limited.

The driver should perform brake and steering operations as necessary. Read the following items carefully. Do not overly rely on the proactive driving assist and always drive carefully. (→P.284)

- The proactive driving assist is not a system which reduces the amount of attention necessary for safe driving. Even if the system is operating correctly, the surrounding conditions as recognized by the driver and detected by the system may differ. It is necessary for the driver to pay attention, assess risks, and ensure safety. Over-reliance on this system to drive the vehicle safely may lead to an accident resulting in death or serious injury.

- Proactive driving assist is not a system which allows for inattentive driving and is not a system which assists in poor visibility conditions. The driver is solely responsible for paying attention to their surroundings and driving safely.

 **When turning proactive driving assist off**

- Situations in which the sensors may not operate properly:
→P.254
- When it is necessary to disable the system: →P.250

 **When towing another vehicle**
→P.308

 **When lift up**
→P.257

System operating conditions and detectable objects

According to the driving conditions, the operation and detectable objects of the proactive driving assist will change as follows.

Function	Conditions	Operation	Detectable objects
Obstacle Anticipation Assist (OAA)	A detectable object is detected crossing the road	Assistance with some brake operations is provided in order to reduce the possibility of a collision.	<ul style="list-style-type: none"> • Pedestrians • Bicyclists
	A detectable object is detected on the side of the road	Assistance with some brake and steering wheel operations are provided according to the surrounding conditions to help prevent the vehicle from approaching too close to a detected object.	<ul style="list-style-type: none"> • Pedestrians • Bicyclists • Parked vehicles
		Assistance with steering wheel operations is provided within a range that the vehicle will not deviate from its current lane.	

Function	Conditions	Operation	Detectable objects
Deceleration Assist (DA)	A preceding vehicle or an adjacent vehicle cutting in front of the vehicle is detected	The vehicle is gently decelerated so that the vehicle-to-vehicle distance will not be excessively short.	<ul style="list-style-type: none"> • Preceding vehicles • Motorcycles
	A curve is detected ahead of the vehicle	The vehicle is gently decelerated if the vehicle speed is determined to be too high for the curve ahead.	None
Steering Assist (SA)	Lane is detected	The system anticipates the driver's operation and supports the operation of the steering wheel.	None

■ **Vehicle speeds at which the system can operate**

- Detectable object crossing the road assistance

Approximately 20 to 35 mph (30 to 60 km/h)

- Detectable object on the side of the road assistance

Approximately 20 to 35 mph (30 to 60 km/h)

- Preceding vehicle deceleration assistance

Approximately 15 mph (20 km/h) or more

- Curve deceleration assistance

Approximately 15 mph (20 km/h) or more

- Steering assist within a lane

Approximately 5 to 80 mph (10 to 140 km/h)

■ **System operation will be canceled when**

- In the following situations, system operation will be canceled:

- When the dynamic radar cruise control or cruise control is operating
- When the PCS is off
- Situations in which some or all of the functions of the system cannot operate: →P.256
- When the P, R or N shift position is selected
- The driver's seat belt is unfastened

- In the following situations, the brake operation assist will be canceled:

- Approximately 9 mph (15 km/h) or less
- When a certain vehicle speed has

been reached, as judged by the system, according to the surrounding conditions

- In the following situations, system operation may be canceled:
 - When the brake control or output restriction control of a driving support system operates (For example: PCS, drive-start control)
 - When the system determines that a detected object has moved away from the vehicle
 - Vehicles with SDM (Stabilizer with Disconnection Mechanism): When SDM (Stabilizer with Disconnection Mechanism) is operating: →P.436
 - When lane lines can no longer be detected
 - When the brake pedal has been depressed
 - When the accelerator pedal has been depressed
 - When the steering wheel has been operated with more than a certain amount of force
 - When the turn signal lever is operated to the left/right turn position



WARNING

■ **Situations in which the system may not operate properly**

- Situations in which the lane may not be detected: →P.256
- When a detectable object stops immediately before entering the path of the vehicle
- When passing extremely close to a detectable object behind a guardrail, fence, etc.
- When changing lanes while overtaking a detectable object
- When passing a detectable object that is changing lanes or turning left/right

- When there are objects (guardrails, power poles, trees, walls, fences, poles, traffic cones, mailboxes, etc.) in the surrounding area
- When there are patterns or a painting ahead of the vehicle that may be mistaken for a detectable object
- When passing through a place with a low structure above the road (tunnel with a low ceiling, traffic sign, signboard, etc.)
- When driving on snowy, icy, or rutted roads
- When a detectable object is approaching your vehicle
- When your vehicle or a detectable object is wandering
- When the movement of a detectable object changes (change in direction, sudden acceleration or deceleration, etc.)
- When suddenly approaching a detectable object
- When a preceding vehicle or motorcycle is not directly in front of your vehicle
- When there is a structure above a detectable object
- When part of a detectable object is hidden by another object (large luggage, umbrella, guardrail, etc.)
- When multiple detectable objects are overlapping
- When a bright light, such as the sun or headlights of another vehicle, is reflecting off of the detectable object
- When the detectable object is white and looks extremely bright

**WARNING**

- When the color or brightness of the detectable object causes it to blend in with its surroundings
- When a detectable object cuts in front of or emerges from beside a vehicle
- When approaching a vehicle ahead which is perpendicular or at an angle to the vehicle, or is facing the vehicle
- If a parked vehicle is perpendicular or at an angle to the vehicle
- When a bicycle is a child sized bicycle, is carrying a large load, is carrying an extra passenger, or has an unusual shape (bicycles equipped with a child seat, tandem bicycles, etc.)
- When a pedestrian or bicyclist is shorter than approximately 3.2 ft. (1 m) or taller than approximately 6.5 ft. (2 m)
- When the silhouette of a pedestrian or bicyclist is unclear (such as when they are wearing a raincoat, long skirt, etc.)
- When a pedestrian or bicyclist is bending forward or squatting
- When a pedestrian or bicyclist is moving at high speed
- When a pedestrian is pushing a stroller, wheelchair, bicycle or other vehicle
- When a detectable object blends in with the surrounding area, such as when it is dim (at dawn or dusk) or dark (at night, in a tunnel, etc.)
- When the lane width is 13.1 ft. (4 m) or more
- When the lane width is 8.2 ft. (2.5 m) or less

- When the vehicle has not been driven for a certain amount of time after the engine was started
- While turning left or right or a few seconds after turning left or right
- While changing lanes or a few seconds after changing lanes
- When entering a curve, driving around a curve and a few seconds after driving around a curve







Changing proactive driving assist settings

- The proactive driving assist can be enabled/disabled through a customize setting. (→P.637)
- The following settings of the proactive driving assist can be changed through customize settings. (→P.637)

System operation display

Depending on the situation, the following indicators or icons will be displayed.

Some icons cannot be displayed unless the display is changed to the driving safety support function information screen.

Icon	Meaning
	<ul style="list-style-type: none"> • White: Monitoring for detectable objects • Green: Detectable object crossing the road or detectable object on the side of the road assistance operating
	<p>A pedestrian has been detected as crossing the road or on the side of the road and brake or steering assistance is operating</p>
	<p>A vehicle has been detected on the side of the road and brake or steering operation assistance is being performed</p>
	<ul style="list-style-type: none"> • Steering operation assistance is being performed to prevent the vehicle from approaching too close to a detectable object on the side of the road • When the steering assist is operating
	<p>Preceding vehicle deceleration assistance is being performed</p>
	<p>Warning to maintain appropriate vehicle-to-vehicle distance</p>
	<p>Curve deceleration assistance is being performed</p>

■ Hands off steering wheel warning operation

In the following situations, a message urging the driver to grip the steering wheel and the icon shown in the illustration will be displayed on the display to warn the driver. If the system detects that the steering wheel is held, the warning will be canceled. When using the system, make sure to grip the steering wheel firmly, regardless of whether the warning is operating or not.

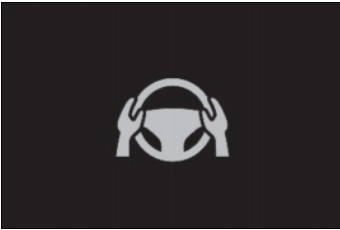

- When assistance to a detectable object crossing the road or assistance to a detectable object on the side of the road is performed and the system determines the driver is not holding the steering wheel

If no operations are detected for a certain amount of time, a buzzer will sound, the warning will operate.

This warning may also operate if the driver only operates steering wheel a small amount continuously.

■ Warning operation after preceding vehicle deceleration assistance has ended

After preceding vehicle deceleration assistance has ended, if the driver does not operate the brake pedal or accelerator pedal and the vehicle approaches the preceding vehicle, the display will flash and a buzzer will sound to urge the driver to decelerate. If the system determines that the driver is operating the brake pedal or accelerator pedal, the warning will be canceled.

RSA (Road Sign Assist)*

*: If equipped

The RSA system detects specific road signs using the front camera and/or navigation system (if equipped) (when speed limit information is available) and warns the driver via displays and buzzers.



WARNING

■ For safe use

- Driving safely is solely the responsibility of the driver. Pay careful attention to the surrounding conditions in order to ensure safe driving.
- Do not rely solely upon the RSA. The RSA assists the driver by providing road sign information, but it is not a replacement for the driver's own vision and awareness. Driving safely is solely the responsibility of the driver. Pay careful attention to the surrounding conditions in order to ensure safe driving.

■ Situations in which the RSA should not be used

When it is necessary to disable the system: →P.250

■ Situations in which the system may not operate properly

Situations in which the sensors may not operate properly: →P.254

Display Function

- When the front camera detects a sign or information of a sign is available from the navigation system (if equipped), the sign will be displayed on the display.
- Multiple signs can be displayed.

Depending on the specifications of the vehicle, the number of displayed signs may be limited.

■ Operating conditions of sign display

Signs will be displayed when the following conditions are met:

- The system has detected a sign

In the following situations, a displayed sign may stop being displayed:

- When a new sign has not been detected for a certain distance
- When the system determines that the road being driven on has changed, such as after a left or right turn

■ Situations in which the display function may not operate properly

In the following situations, the RSA system may not operate properly and may not detect signs or may display the incorrect sign. However, this does not indicate a malfunction.

- When a sign is dirty, faded, tilted or bent
- When the contrast of an electronic sign is low
- When all or part of a sign is hidden by a tree, utility pole, etc.
- When a sign is detected by the front camera for a short amount of

time

- When the driving state (turning, changing lanes, etc.) is judged incorrectly
- When a sign is immediately after a freeway junction or in an adjacent lane just before merging
- When stickers are attached to the rear of a preceding vehicle
- When a sign similar to a system compatible sign is detected as a system compatible sign
- When a speed limit sign for a frontage road is within detection range of the front camera
- When driving around a roundabout
- When a sign intended for trucks, etc. is detected
- When a sign has a supplemental sign (end point, day of week, time of day, etc.)
- When there is a sign within a traffic restricted area, such as a roadworks area
- Vehicles with navigation system: When the navigation system map data is out of date
- Vehicles with navigation system: When the navigation system cannot be used

In this case, the speed limit signs displayed on the multi-information display and navigation system display may differ.

Notification function

In the following situations, the RSA system will output a warning to notify the driver.

- If the vehicle speed exceeds the speed warning threshold of the speed limit sign displayed on the display, the sign

display will be emphasized and a buzzer will sound.

- When the RSA system detects a do not enter sign and determines that the vehicle has entered a no-entry area, the do not enter sign displayed on the display will flash and a buzzer will sound.

Operating conditions of the notification functions

- Excess speed notification function

This function will operate when the following condition is met:

- A speed limit road sign is recognized by the system.

- No entry notification function

This function will operate when all of the following conditions are met:

- More than one no entry road signs are recognized by the system simultaneously.
- The vehicle is passing between no entry road signs recognized by the system.

Types of road signs supported

- The following types of road signs can be displayed.

However, non-standard or recently introduced traffic signs may not be displayed.

	Speed limit
	
	Do Not Enter
	No U-turn
	No Turn On Red
	Stop
	Yield
	Warning

Changing RSA settings

The following settings of the RSA can be changed through customize settings. (→P.637)



Dynamic radar cruise control

This dynamic radar cruise control detects the presence of vehicles ahead, determines the current vehicle-to-vehicle distance, and operates to maintain a suitable distance from the vehicle ahead. The desired vehicle-to-vehicle distance can be set by operating the vehicle-to-vehicle distance switch.

Use the dynamic radar cruise control only on highways and expressways.

WARNING

For safe use

-  Driving safely is solely the responsibility of the driver. Do not overly rely on this system, and pay careful attention to the surrounding conditions in order to ensure safe driving.
-  The dynamic radar cruise control provides driving assistance to reduce the driver's burden. However, there are limitations to the assistance provided. Read the following items carefully. Do not overly rely on this system and always drive carefully.

Conditions under which the system may not operate correctly:
→P.297

**WARNING**

- Set the speed appropriately according to the speed limit, traffic flow, road conditions, weather conditions, etc. The driver is responsible for confirming the set speed.
- Even if the system is operating correctly, the condition of a preceding vehicle as recognized by the driver and detected by the system may differ. Therefore, it is necessary for the driver to pay attention, assess risks, and ensure safety. Over-reliance on this system to drive the vehicle safely may lead to an accident resulting in death or serious injury.

■ Precautions for the driving assist systems

Observe the following precautions, as there are limitations to the assistance provided by the system. Over-reliance on this system may lead to an accident resulting in death or serious injury.

- Details of support provided for the driver's vision
The dynamic radar cruise control is only intended to help the driver in determining the distance between the driver's own vehicle and a designated preceding vehicle. It is not a system which allows for careless or inattentive driving, and is not a system which assists in poor visibility conditions.
The driver must pay attention to their surroundings, even when the vehicle stops.
- Details of support provided for the driver's judgement
The dynamic radar cruise control determines whether the distance between the driver's own vehicle and a designated preceding vehicle is within a set range. It is not capable of making any other type of judgement. Therefore, it is absolutely necessary for the driver to remain vigilant and to determine whether or not there is a possibility of danger.
- Details of support provided for the driver's operation
The dynamic radar cruise control does not include functions which will prevent or avoid collisions with vehicles ahead of your vehicle. Therefore, if there is ever any possibility of danger, the driver must take immediate and direct control of the vehicle and act appropriately in order to ensure safety.

**WARNING****■ Situations in which the dynamic radar cruise control should not be used**

Do not use the dynamic radar cruise control in the following situations. As the system will not be able to provide appropriate control, using it may lead to an accident resulting in death or serious injury.

- Roads where there are pedestrians, cyclists, etc.
- When driving on a highway or expressway entrance or exit
- When the approach warning sounds frequently
- Situations in which the sensors may not operate properly:
→P.254
- When it is necessary to disable the system: →P.250

■ When towing another vehicle

→P.308

■ When lift up

→P.257

Basic functions

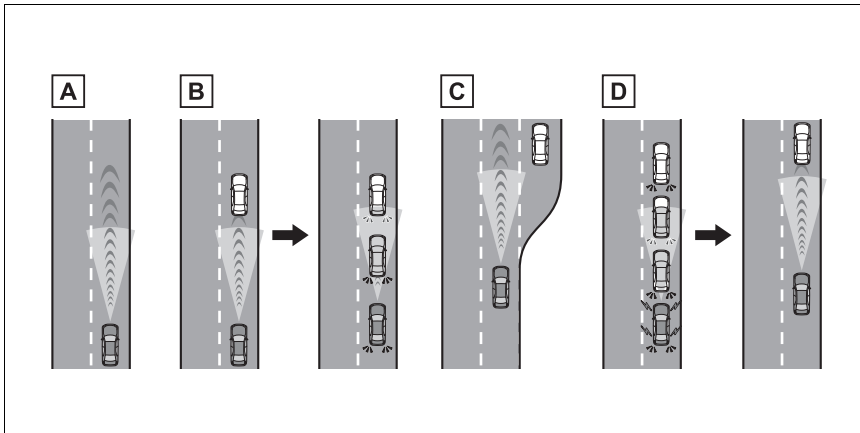

A Constant speed cruising:

When there are no vehicles ahead

The vehicle drives at the speed set by the driver.

If the set vehicle speed is exceeded while driving down a hill, the set vehicle speed display will blink and a buzzer will sound.

B Deceleration and follow-up cruising

When a preceding vehicle driving slower than the set vehicle speed is detected

When a vehicle is detected driving ahead of your vehicle, the vehicle automatically decelerates and if a greater reduction in vehicle speed is necessary, the brakes are applied (the stop lights will come on at this time). The vehicle is controlled to maintain the vehicle-to-vehicle distance set by the driver, in accordance with changes in the speed of the preceding vehicle. If vehicle deceleration is not sufficient and the vehicle approaches the vehicle ahead, the approach warning will sound.

C Acceleration

When there are no longer any preceding vehicles driving slower than the set vehicle speed

The vehicle accelerates until the set vehicle speed is reached and then resumes constant speed cruising.

D Starting off:

If a preceding vehicle stops, the vehicle will also stop (controlled stop). After the preceding vehicle starts off, pressing the "RES" switch or depressing the accelerator pedal will resume follow-up cruising (start off operation). If a start off operation is not per-

formed, the controlled stop will continue.

System components

■ Meter display

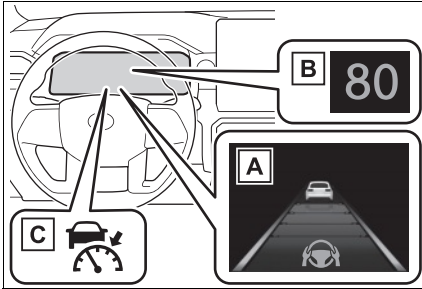

- A** Multi-information display
- B** Set vehicle speed
- C** Indicators

■ Switches

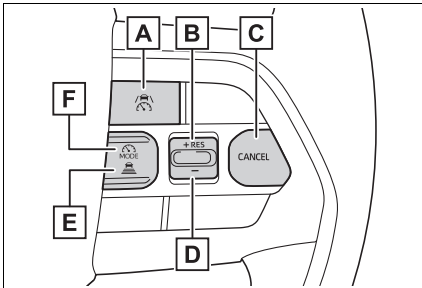

- A** Driving assist switch
- B** "+" switch/"RES" switch
- C** Cancel switch
- D** "-" switch
- E** Vehicle-to-vehicle distance switch
- F** Driving assist mode select switch

Using the dynamic radar cruise control

■ Setting the vehicle speed

- 1 Press the driving assist mode select switch to select Adaptive Cruise Mode.

The dynamic radar cruise control indicator will illuminate.

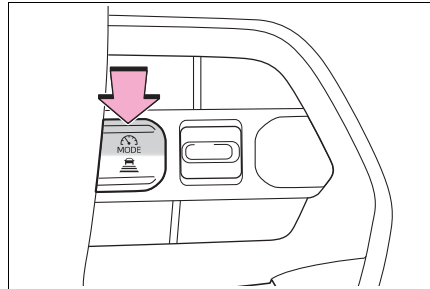

- 2 Using the accelerator pedal, accelerate or decelerate to the desired vehicle speed (approximately 20 mph [30 km/h] or more), and press the driving assist switch to set the set vehicle speed.

The set vehicle speed will be displayed on the multi-information display.

The vehicle speed at the moment the switch is released will be the set vehicle speed.

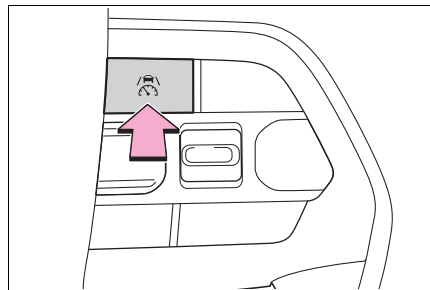

■ **Adjusting the set vehicle speed**

- Adjusting the set vehicle speed using the switches

To change the set vehicle speed, press the “+” switch or “-” switch until the desired speed is displayed.

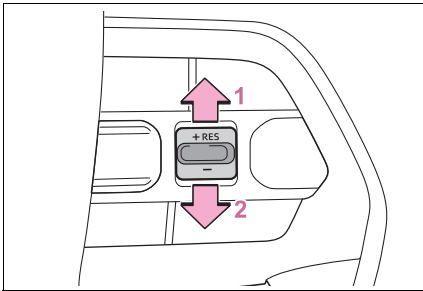

- 1 Increase set vehicle speed
- 2 Decrease set vehicle speed

Short press adjustment: Press the switch

Long press adjustment: Press and hold the switch until the desired set vehicle speed is reached.

The set vehicle speed will increase or decrease as follows:

► **Except for Canada**

Short press adjustment: Increases or decreases by 1 mph (1.6 km/h) each time the switch is pressed

Long press adjustment: Increases or decreases in 1 mph (1.6 km/h) increments continuously while the switch is pressed and held

► **For Canada**

Short press adjustment: By 1 km/h (0.6 mph) or 1 mph (1.6 km/h) each time the switch is pressed

Long press adjustment: Increases

or decreases in 5 km/h (3.1 mph) or 5 mph (8 km/h) increments continuously while the switch is pressed and held

■ **Increasing the set vehicle speed using the accelerator pedal**

- 1 Depress the accelerator pedal to accelerate the vehicle to the desired vehicle speed.
- 2 Press the “+” switch.

■ **Canceling/resuming control**

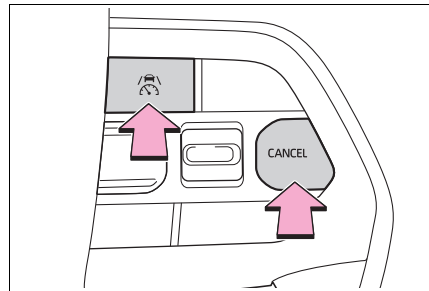

- 1 Press the cancel switch or driving assist switch to cancel control.

Control will also be canceled if the brake pedal is depressed. (If the vehicle has been stopped by system control, depressing the brake pedal will not cancel control.)

- 2 Press the “RES” switch to resume control.

■ **Changing the vehicle-to-vehicle distance**

Each time the switch is pressed, the vehicle-to-vehicle distance setting will change as follows:

If a preceding vehicle is detected, the preceding vehicle mark **A** will

be displayed.

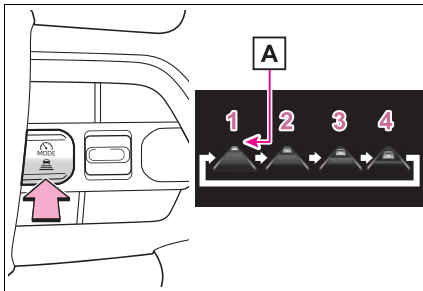

Illustration Number	Vehicle-to-vehicle distance	Approximate Distance (Vehicle Speed: 60 mph [100 km/h])
1	Extra long	Approximately 200 ft. (60 m)
2	Long	Approximately 145 ft. (45 m)
3	Medium	Approximately 100 ft. (30 m)
4	Short	Approximately 85 ft. (25 m)

The actual vehicle-to-vehicle distance varies in accordance with the vehicle speed. Also, when the vehicle is stopped by system control, it will be stopped at a certain distance from the preceding vehicle, depending on the situation, regardless of the setting.

■ Operating conditions

- The D shift position is selected.
- The desired set speed can be set when the vehicle speed is approximately 20 mph (30 km/h) or more.
- If the vehicle speed is set while driving at below approximately 20 mph (30 km/h), the set vehicle speed will be approximately 20 mph (30 km/h).
- If the vehicle speed is set while

driving at a speed that exceeds the system's upper limit, the set vehicle speed will be the system's upper limit.

■ Accelerating after setting the vehicle speed

As with normal driving, acceleration can be performed by depressing the accelerator pedal. After accelerating, the vehicle will return to the set vehicle speed. However, while in vehicle-to-vehicle distance control mode, the vehicle speed may decrease to below the set vehicle speed in order to maintain the distance from the preceding vehicle.

■ When the vehicle is stopped by system control during follow-up cruising

- When the "RES" switch is pressed while the vehicle is stopped by system control, if the preceding vehicle starts off within approximately 3 seconds, follow-up cruising will resume.
- If the preceding vehicle starts off within approximately 3 seconds of the vehicle being stopped by system control, follow-up cruising will resume.

■ Automatic cancelation of vehicle-to-vehicle distance control mode

In the following situations, vehicle-to-vehicle distance control mode will be canceled automatically:

- When the brake control or output restriction control of a driving support system operates (For example: Pre-Collision System, drive-start control)
- When the parking brake has been operated
- When the driver's seat belt is unfastened while driving
- When the Pre-Collision System is disabled
- When the vehicle is stopped by system control on a steep incline

- When any of the following are detected while the vehicle is stopped by system control:
 - The driver's seat belt is unfastened
 - The driver's door is opened
 - Approximately 3 minutes have elapsed since the vehicle was stopped

The parking brake may be activated automatically.

- Situations in which some or all of the functions of the system cannot operate: →P.256

■ Dynamic radar cruise control system warning messages and buzzers

For safe use: →P.250

■ Preceding vehicles that the sensor may not detect correctly

In the following situations, depending on the conditions, if the system cannot provide sufficient deceleration or acceleration is necessary, operate the brake pedal or accelerator pedal.

As the sensor may not be able to correctly detect these types of vehicles, the approach warning (→P.297) may not operate.

- When a vehicle cuts in front of your vehicle or changes lanes away from your vehicle extremely slowly or quickly
- When changing lanes
- When a preceding vehicle is driving at a low speed
- When a vehicle is stopped in the same lane as the vehicle
- When a motorcycle is traveling in the same lane as the vehicle

■ Conditions under which the system may not operate correctly

In the following situations, operate the brake pedal (or accelerator pedal, depending on the situation) as necessary.

As the sensor may not be able to correctly detect a vehicle, the system may not operate properly.

- When a preceding vehicle brakes suddenly
- When changing lanes at low speeds, such as in a traffic jam

Approach warning

In situations where the vehicle approaches a preceding vehicle and the system cannot provide sufficient deceleration, such as if a vehicle cuts in front of the vehicle, a warning display will flash and a buzzer will sound to alert the driver. Depress the brake pedal to ensure appropriate vehicle-to-vehicle distance.

■ Warnings may not occur when

In the following situations, the warning may not operate even though the vehicle-to-vehicle distance is short.

- When the preceding vehicle is traveling at the same speed or faster than your vehicle
- When the preceding vehicle is traveling at an extremely low speed
- Immediately after the vehicle speed has been set
- When the accelerator pedal is depressed

Curve speed reduction function

When a curve is detected, the vehicle speed will begin being reduced. When the curve ends, the vehicle speed reduction will end.

Depending on the situation, the vehicle speed will then return to the set vehicle speed.

In situations where vehicle-to-vehicle distance control needs to operate, such as when a preceding vehicle cuts in front of your vehicle, the curve speed reduction function will be canceled.



Situations in which the curve speed reduction function may not operate

In situations such as the following, the curve speed reduction function may not operate:

- When the vehicle is being driven around a gentle curve
- When the accelerator pedal is being depressed
- When the vehicle is being driven around an extremely short curve

Support for lane change

If your vehicle is being driven at

approximately 50 mph (80 km/h) or more and a lane change to the passing lane is performed, when the turn signal lever is operated and the lane is changed, the vehicle will accelerate up to the set speed to assist in overtaking.

The system's recognition of which lane is the passing lane may be based solely on the location of the steering wheel in the vehicle (left-hand drive/right-hand drive). If the vehicle is driven in a location where the passing lane is on the opposite side of that where the vehicle was originally sold, the vehicle may accelerate when the turn signal lever is operated away from the passing lane. (e.g. The vehicle was manufactured for a right-hand traffic location, but is being driven in a left-hand traffic location. The vehicle may accelerate when the turn signal lever is operated to the right.)







If your vehicle is being driven at approximately 50 mph (80 km/h) or more and the lane is changed to that with a vehicle traveling slower than your vehicle, when the turn signal lever is operated the vehicle will gradually decelerate to assist in changing lanes.



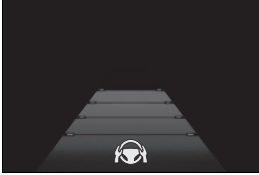

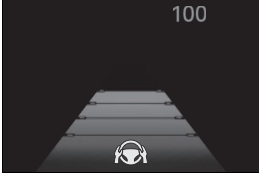
Changing Dynamic radar cruise control settings

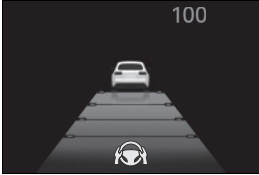
The settings of Dynamic radar cruise control can be changed through customize settings. (→P.637)

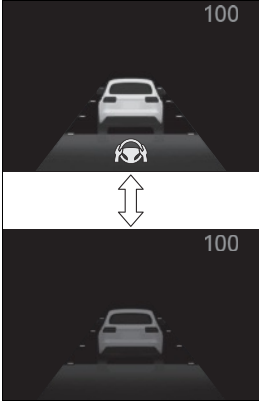
Display and system operation state

The operating state of Dynamic radar cruise control is indicated.

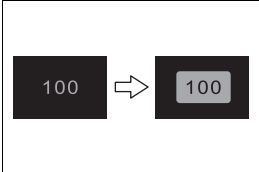
Indicator	Multi-information display		Situation
 White		Vehicle-to-vehicle distance setting: Gray	Dynamic radar cruise control being OFF
 Green		Vehicle-to-vehicle distance setting: Blue Set vehicle speed: Green	Constant speed cruising
 Green		Vehicle-to-vehicle distance setting: Blue Set vehicle speed: Green Preceding vehicle: White	Follow-up cruising
 Green		Vehicle-to-vehicle distance setting: Orange flashing Set vehicle speed: Green Preceding vehicle: Orange flashing	Approach warning

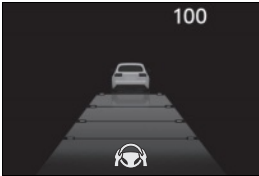
Indicator	Multi-information display		Situation
 <p>Green</p>		<p>Vehicle-to-vehicle distance setting: Gray</p> <p>Set vehicle speed: White</p> <p>Preceding vehicle: Gray</p>	<p>Accelerating with the accelerator pedal</p>
 <p>Green</p>		<p>Set vehicle speed: Green in reverse display</p>	<p>Set vehicle speed being exceeded</p>
 <p>Green</p>		<p>Vehicle-to-vehicle distance setting: Gray</p> <p>Set vehicle speed: White</p> <p>Preceding vehicle: Gray</p>	<p>Vehicle in controlled stop</p>

Cruise control

The vehicle can be driven at a set speed even if the accelerator pedal is not depressed.

Use the cruise control only on highways and expressways.

WARNING

■ For safe use

● Driving safely is solely the responsibility of the driver. Therefore, do not overly rely on this system. The driver is solely responsible for paying attention to the vehicle's surroundings and driving safely.

● Set the speed appropriately according to the speed limit, traffic flow, road conditions, weather conditions, etc. The driver is responsible for confirming the set speed.

■ Situations in which cruise control should not be used

Do not use the cruise control in the following situations. As the system will not be able to provide appropriate control, using it may lead to an accident resulting in death or serious injury.

- On roads with sharp bends
- On winding roads
- On slippery roads, such as those covered with rain, ice or snow

● On steep downhills, or where there are sudden changes between sharp up and down gradients

Vehicle speed may exceed the set speed when driving down a steep hill.

● When it is necessary to disable the system: →P.250

■ When towing another vehicle
→P.308

■ When lift up
→P.257

System components

■ Meter display

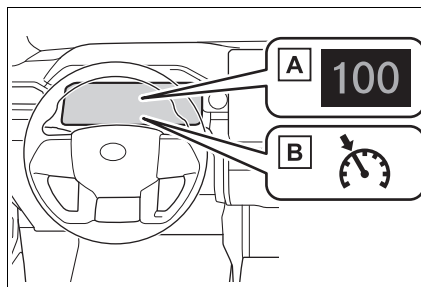

A Set vehicle speed

B Cruise control indicator

■ Switches

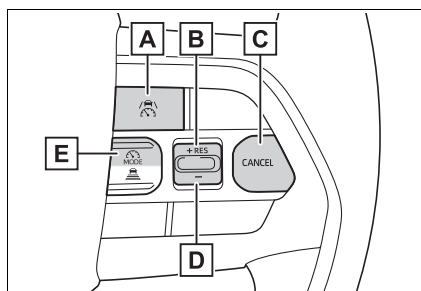

A Driving assist switch

- B** “+” switch/“RES” switch
- C** Cancel switch
- D** “-” switch
- E** Driving assist mode select switch

Using the cruise control

■ Setting the vehicle speed

- 1 Press the driving assist mode select switch to select Cruise Control Mode.

The cruise control indicator will illuminate.

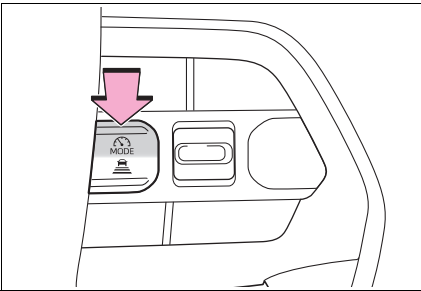

- 2 Using the accelerator pedal, accelerate to the desired vehicle speed (approximately 20 mph [30 km/h] or more), and press the driving assist switch to set the set vehicle speed.

The vehicle speed at the moment the switch is released will be the set

vehicle speed.

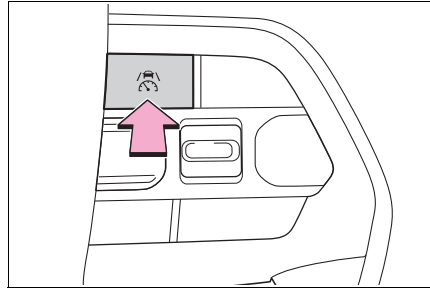

■ Adjusting the set vehicle speed

- Adjusting the set vehicle speed using the switches

To change the set vehicle speed, press the “+” or “-” switch until the desired speed is displayed.

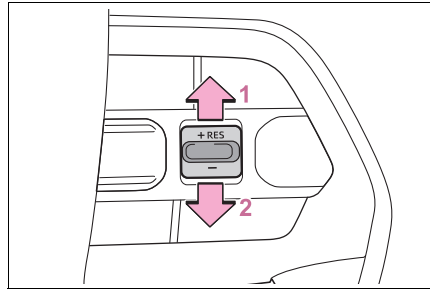

- 1 Increase set vehicle speed
- 2 Decrease set vehicle speed

The set vehicle speed will increase or decrease as follows:

Fine adjustment: By 0.6 mph (1 km/h) or 1.6 km/h (1 mph) each time the switch is pressed

Large adjustment: Increases continuously while the switch is pressed and held

- Increasing the set vehicle speed using the accelerator pedal
- 1 Depress the accelerator pedal to accelerate the vehicle to the desired vehicle speed.
 - 2 Press the “+” switch.

■ Canceling/resuming control

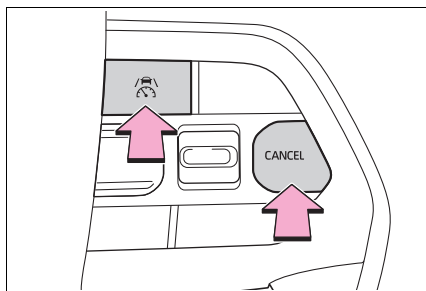

- 1 Press the cancel switch or driving assist switch to cancel control.

Control will also be canceled if the brake pedal is depressed.

- 2 Press the “RES” switch to resume control.





■ Automatic cancelation of the cruise control

In the following situations, the cruise control will be canceled automatically:

- When the vehicle speed drops approximately 10 mph (16 km/h) or more below the set vehicle speed
- When the vehicle speed drops below approximately 20 mph (30 km/h)
- When the brake control or output restriction control of a driving support system operates (For example: PCS, drive-start control)

Display and system operation state

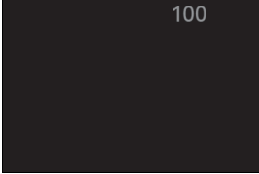
The operating state of cruise control is indicated.

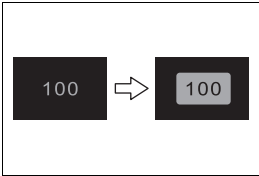
Indicator	Multi-information display		Situation
 White		Blank	Cruise control being OFF
 Green		Set vehicle speed: Green	Constant speed cruising
 Green		Set vehicle speed: Green in reverse display	Set vehicle speed being exceeded

Emergency Driving Stop System

The emergency driving stop system is a system which automatically decelerates and stops the vehicle within its lane if the driver becomes unable to continue driving the vehicle, such as if they have suffered a medical emergency, etc.

During LTA (Lane Tracing Assist) control, if the system does not detect driving operations, such as if the driver is not holding the steering wheel, and determines the driver is not responsive, the vehicle will be decelerated and stopped within its current lane to help avoid a collision or reduce the impact of a collision.

WARNING

■ For safe use

- Driving safely is solely the responsibility of the driver. Pay careful attention to the surrounding conditions in order to ensure safe driving. The emergency driving stop system is designed to provide support in an emergency where it is difficult for the driver to continue driving, such as if they have had a medical emergency. It is not designed to support driving while drowsy or in poor physical health, or inattentive driving.
- Although the emergency driving stop system is designed to decelerate the vehicle within its lane to help avoid or help reduce the impact of a collision if the system determines that it is difficult for the driver to continue driving, its effectiveness may change according to various conditions. Therefore, it may not always be able to achieve the same level of performance. Also, if the operating conditions are not met, this function will not operate.
- After the emergency driving stop system operates, if driving becomes possible again, immediately begin driving again or, if necessary, park the vehicle on the shoulder of the road and set a warning reflector and flare to warn other drivers of your stopped vehicle.
- After this system operates, passengers should attend to the driver as necessary and take appropriate hazard prevention measures, such as moving to a place where safety can be ensured, such as the shoulder of the road or behind a guard-rail.

**WARNING**

- This system detects the condition of the driver through the operation of the steering wheel. This system may operate if the driver is aware but intentionally and continuously does not operate the vehicle. Also, the system may not operate if it cannot determine that the driver is not responsive, such as if they are leaning on the steering wheel.

- **When towing another vehicle**

→P.308

- **When lift up**

→P.257

Summary of the system

Operation of this system is separated into 4 control states. Through control state “warning phase 1” and “warning phase 2”, the system determines if the driver is aware and responsive while outputting a warning and controlling the vehicle speed. If the system determines the driver is not responsive, it will operate in control state “deceleration stop phase” and “stop hold phase” and decelerate and stop the vehicle. It will then operate continuously in “stop hold phase”.

- **Operating conditions**

This system operates when all of the following conditions are met:

- When the LTA is on
- When the vehicle speed is approximately 30 mph (50 km/h)

or more

- **Operation cancelation conditions**

In the following situations, system operation will be canceled:

- When LTA control has been canceled (the LTA switch has been pressed, etc.)
- When the dynamic radar cruise control has been canceled
- When driver operations are detected (the steering wheel is held, the brake pedal, accelerator pedal, parking brake, hazard light switch, or turn signal lever is operated)
- When the driving assist switch is pressed while in the stop and hold phase
- When the engine switch has been turned from ON to OFF
- Situations in which some or all of the functions of the system cannot operate: →P.256

- **LTA control when operation is canceled**

When emergency driving stop system operation is canceled, LTA control may also be canceled.

Warning phase 1

If driving operations are not detected after the hands off steering wheel warning operates, a buzzer will sound intermittently and a message will be displayed to warn the driver, and the system will judge if the driver is responsive or not. If driving operations, such as holding the steering wheel, are not performed within a certain amount of time, the system will enter warning phase 2.

Warning phase 2

After entering warning phase 2, a buzzer will sound in short intervals and a message will be displayed to warn the driver, and the vehicle will slowly decelerate. If driving operations, such as holding the steering wheel, are not performed within a certain amount of time, the system will determine that the driver is not responsive and enter the deceleration stop phase.

When the vehicle is decelerating, the brake lights may illuminate, depending on the road conditions, etc.

Deceleration stop phase

After entering the deceleration stop phase, a buzzer will sound continuously and a message will be displayed to warn the driver, and the vehicle will slowly decelerate and stop. After the vehicle stops, the system will enter the stop and hold phase.

Stop hold phase

After the vehicle is stopped, the parking brake will be applied automatically. After entering the stop and hold phase, the buzzer will continue sounding continuously and the emergency flashers (hazard lights) will flash to warn other drivers of the emer-

gency.

■ Restricted functions after the operation is canceled

After shifting to the deceleration stop phase, the following functions will not be available until the engine is re-started even though the emergency driving stop system is canceled:

- LTA

TDA (Trailer Driving Assist)*

*: If equipped

TDA (Trailer Driving Assist) is a system that adjusts certain driver assist settings to support towing functionality. It is recommended to use a genuine Toyota Trailer Brake Controller (TBC) (→P.437) (if equipped) when towing.

Towing without a genuine Toyota Trailer Brake Controller (TBC) (if equipped) increases the risk of vehicle/trailer instability.

System functions

When the TDA (Trailer Driving Assist) is operating, each function is limited as follows:

Function	Status
AHB (Automatic High Beam) (→P.238)	O
PCS (Pre-Collision System) (→P.259)	*1
LTA (Lane Tracing Assist) (→P.270)	—
LDA (Lane Departure Alert) (→P.275)	O

Function	Status
PDA (Proactive driving assist) (→P.281)	—
RSA (Road Sign Assist)*2 (→P.288)	O
Dynamic radar cruise control (→P.290)	O
Emergency Driving Stop System (→P.305)	—
Intuitive parking assist*2 (→P.323)	*1
PKSB (Parking Support Brake)*2 (→P.339)	—
Parking Support Brake function (static objects)*2 (→P.344)	—
RCD (Rear Camera Detection)*2 (→P.335)	—
RCTA (Rear Cross Traffic Alert) (→P.330)	—

Definition of symbols: O = Available, — = Not available

*1: Partially unavailable

*2: If equipped

Operating conditions

Operates when any of the following conditions are met:

- When towing a trailer connected to a genuine Toyota Trailer Brake Controller (TBC) (→P.437) (if equipped)
- When BSM (Blind Spot Monitor) (→P.316) detects a connected trailer

A message is displayed on the multi-information display when a trailer is detected.

Enable the function according to the instructions on the multi-information display.

■ PCS (Pre-Collision System) function

The following functions are disabled when a trailer is detected.

- Moderate braking for pre-collision warning
- Acceleration suppression at low speed
- Emergency steering assist
- Intersection collision avoidance support (left/right turn)

■ When towing a trailer

- This system has limitations. Do not overly rely on the system. It is the driver's responsibility to always be aware of the surroundings and drive safely.
- Please check P.205 on how to tow a trailer properly.

WARNING

■ For safe use

If the vehicle is being driven on a slippery surface such as an icy road or a very wet road, disable the system, as it may not operate properly, possibly leading to an accident resulting in death or serious injury.

Stop & Start system*

*: If equipped

The Stop & Start system stops and starts the engine according to brake pedal or shift lever operation when the vehicle is stopped, such as at a stoplight, intersection, etc., in order to improve fuel economy and reduce noise pollution caused by the engine idling.

Stop & Start system operation

■ Stopping the engine

While driving with the D shift position selected, depress the brake pedal and stop the vehicle. The engine will stop automatically.

When the engine stops, the Stop & Start indicator will illuminate.

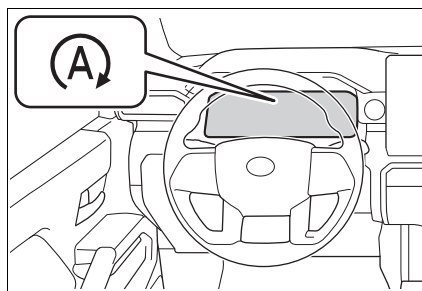

■ Restarting the engine

Release the brake pedal. The engine will start automatically.

When the engine starts, the Stop & Start indicator will turn off.

■ When the brake hold system is operating

- When the engine is stopped by the Stop & Start system, if the brake pedal is released the engine will remain stopped.

However, when a vehicle stops forward or a person walks the front and so on, the engine may be restarted.

- If the accelerator pedal is depressed while the engine is stopped by the Stop & Start system, the engine will restart.
- While the engine is stopped by the Stop & Start system, if the engine is restarted, the brake hold system will continue to apply the brakes, unless the operation conditions of the brake hold system are no longer met. (→P.231)

■ When the dynamic radar cruise control is operating

- When the vehicle is stopped by the dynamic radar cruise control, the engine will stop automatically even though the brake pedal is not depressed.
- When the preceding vehicle starts off, the engine will restart automatically.
- If the engine is restarted by the Stop & Start system while the vehicle is stopped by the dynamic radar cruise control,

the vehicle will remain stopped.

Disabling the Stop & Start system

Press the Stop & Start cancel switch to disable the Stop & Start system.

The Stop & Start cancel indicator will illuminate.

Pressing the switch again will enable the Stop & Start system and the Stop & Start cancel indicator will turn off.

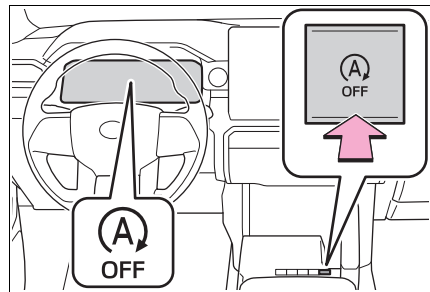

■ Automatic enabling of the Stop & Start system

If the Stop & Start system is disabled using the Stop & Start cancel switch, it will be automatically re-enabled once the engine switch is turned off and then the engine is started.

Hill-start assist control

When the engine is stopped by the Stop & Start system when the vehicle is on an incline, when the brake pedal is released, brake force is temporarily maintained to prevent the vehicle from rolling backwards

before the engine is restarted and drive force is generated. When drive force is generated, the maintained brake force is automatically canceled.

- This function operates on flat surfaces as well as steep inclines.
- Sound may be generated from the brake system, but this does not indicate a malfunction.
- Brake pedal response may change and vibration may occur, but this does not indicate a malfunction.

■ Points for use

- If the engine switch is pressed when the engine is stopped by the Stop & Start system, the engine will not be able to be restarted by the automatic engine start function. In this case, restart the engine using the normal engine starting procedure. (→P.218)
- When the engine is being restarted by the Stop & Start system, the power outlets may be temporarily unusable, but this does not indicate a malfunction.
- Installation and removal of electrical components and wireless devices may affect the Stop & Start system. Contact your Toyota dealer for details.
- When stopping the vehicle for a longer period of time, turn the engine switch off to stop the engine completely.
- When the engine is restarted by the Stop & Start system, the steering wheel may temporarily feel heavy.

■ Operating conditions

- The Stop & Start system is operational when all of the following conditions are met:
 - The vehicle has been driven a certain amount of time.
 - The brake pedal is being depressed firmly. (Except when the vehicle is stopped by the dynamic radar cruise control when in vehicle-to-vehicle distance control mode)
 - The D shift position is selected.
 - The driver's seat belt is fastened.
 - The driver's door is closed.
 - The selected driving mode is not "4H" or "4L" mode. (part-time 4WD models)
 - The selected driving mode is not "H4F" or "L4L" mode. (full-time 4WD models)
 - The Multi-terrain Select is not operated (if equipped)
 - The selected driving mode is not rear differential lock mode. (if equipped)
 - The windshield defogger is off.
 - The accelerator pedal is not being depressed.
 - The engine is adequately warmed up.
 - The hood is closed. (→P.312)
 - "TOW HAUL" mode is not operated (if equipped)
- In the following situations the engine may not be stopped by the Stop & Start system. This is not a malfunction of the Stop & Start system.
 - When the air conditioning system is being used.
 - When the battery is undergoing a periodic recharge.
 - When the battery is not sufficiently charged, such as if the vehicle has been parked for a long time and the battery charge has decreased, the electric load is large, the battery fluid temperature is excessively low or the battery has deteriorated.
 - When the brake booster vacuum is low.

- When the elapsed time since the engine was restarted is short.
 - When the vehicle is stopped frequently, such as when in a traffic jam.
 - When the engine coolant temperature or transmission fluid temperature is extremely low or high.
 - When the vehicle is stopped on a steep incline.
 - When the vehicle is being driven in a high altitude area.
 - When the battery fluid temperature is extremely low or high.
 - For a while after the battery terminals have been disconnected and reconnected.
- When the engine is stopped by the Stop & Start system, the engine will be restarted automatically if any of the following conditions are met:
(To enable the engine to be stopped by the Stop & Start system again, drive the vehicle.)
 - The air conditioning system is being used. (vehicles without a manual air conditioning system)
 - The windshield defogger is turned on. (vehicles without a manual air conditioning system)
 - The shift lever is shifted from D.
 - The driver's seat belt is unfastened.
 - The driver's door is opened.
 - The selected driving mode is "4H" or "4L" mode. (part-time 4WD models)
 - The selected driving mode is "H4F" or "L4L" mode. (full-time 4WD models)
 - The Multi-terrain Select is operated (if equipped)
 - "TOW HAUL" mode is operated (if equipped)
 - The driving mode is changed to rear differential lock mode. (if equipped)
 - The Stop & Start cancel switch is pressed.
 - The accelerator pedal is depressed.
 - The vehicle starts to roll on an incline.
- When the engine is stopped by the Stop & Start system, the engine may restart automatically in the following situations: (To enable the engine to be stopped by the Stop & Start system again, drive the vehicle.)
 - When the brake pedal is pumped or strongly depressed.
 - When the air conditioning system is being used.
 - When a switch of the air conditioning system is operated (windshield defogger switch, etc.).
 - If the battery charge becomes low.
- **When the hood is opened**
- If the hood is opened while the engine is stopped by the Stop & Start system, the engine will stall and will not be able to be restarted by the automatic engine start function. In this case, restart the engine using the normal engine starting procedure. (→P.218)
 - If the hood is closed after the engine is started with the hood open, the Stop & Start system will not operate. Close the hood, turn the engine switch off, wait 30 seconds or more, and then start the engine.
- **Air conditioning system operation while the engine is stopped by the Stop & Start system**
- Vehicles with an automatic air conditioning system: When the air conditioning is in automatic mode and the engine is stopped by the Stop & Start system, the fan may operate at a low speed in order to prevent the temperature in the cabin from increasing or decreasing or may be stopped.
- To prioritize air conditioning system performance when the vehicle is stopped, disable the Stop & Start system by pressing the Stop & Start cancel switch.
- If the windshield is fogged up
Turn the windshield defogger on.

(→P.462)

If the windshield fogs up frequently, press the Stop & Start cancel switch to disable the Stop & Start system.

- If an odor is emitted from the air conditioning system
- Vehicles with a manual air conditioning system

If the idling stop time setting is set to “Extended” change it to “Standard”.

If an odor is emitted when the idling stop time setting is set to “Standard”, press the Stop & Start cancel switch to deactivate the Stop & Start system.

- Vehicles with an automatic air conditioning system

Press the Stop & Start cancel switch to deactivate the Stop & Start system.

■ **Changing the idling stop time with the air conditioning system on**

The length of time the Stop & Start system will operate when the air conditioning system is on can be changed in  of the multi-information display (→P.649). (The length of time the Stop & Start system will operate when the air conditioning system is off cannot be changed.)

■ **Displaying the Stop & Start system status**

→P.310

■ **Multi-information display messages**

If the following situations, 

and a message may be displayed on the multi-information display.

- When the engine cannot be stopped by the Stop & Start system

 “Press Brake More to Activate

- The brake pedal is not sufficiently depressed.

→ If the brake pedal is depressed sufficiently, the system will operate.

 “Non-Dedicated Battery”

- A battery not designed for use with a Stop & Start system may have been installed.

→ Have the vehicle inspected by your Toyota dealer.

 “Battery Charging”

- The battery charge may be low.

→ Stopping of the engine is temporarily prohibited to prioritize charging of the battery. After the engine runs for a certain amount of time, the system will be enabled.

- A refresh charge may be occurring

→After a refresh charge for up to an hour completes, the system can be operated.

- If displayed continuously for a long time (more than an hour)

→ The battery may be deteriorated.

Contact your Toyota dealer for details.

 “Stop & Start System Unavailable”

- The Stop & Start system is temporarily disabled.

→ Allow the engine to run for some time.

- The engine may have been started with the hood open.

→ Close the hood, turn the engine switch off, wait for 30 seconds or more and then start the engine.

 “In Preparation”

- The vehicle is being driven in a high altitude area.
- The brake booster vacuum is low.

→ When the brake booster vacuum reaches a predetermined level, the system will be enabled.



“For Climate Control”

- The air conditioning system is being used when the ambient temperature is high or low.

→ If the difference between the set temperature and cabin temperature becomes small, the system will be enabled.

- The windshield defogger is on.
- When the engine automatically restarts while stopped by the Stop & Start system



“In Preparation”

- The brake pedal has been depressed further or pumped.

→ The system will be enabled after the engine runs and the brake booster vacuum reaches a predetermined level.



“For Climate Control”

- The air conditioning system has been used.
- The windshield defogger has been turned on.



“Battery Charging”

- The battery charge may be low.

→ The system will be enabled after the engine runs to sufficiently charge the battery.

■ When the buzzer sounds

If the driver’s door is opened when the engine is stopped by the Stop & Start system and the shift lever is in D, a buzzer will sound and the Stop & Start system indicator will flash. To stop the buzzer, close the driver’s door.

■ The Stop & Start system protection function

- When the volume of the audio system is excessively high, sound output from the audio system may

suddenly be cut off in order to reduce battery consumption. To prevent the audio system from being cut off, keep the volume of audio system at a moderate level. If the audio system has been cut off, turn the engine switch off, wait for 3 seconds or more and then turn it to ACC or ON to re-enable the audio system.

- The audio system may not be activated if the battery terminals are disconnected and then reconnected. If this occurs, turn the engine switch off and then repeat the following operation twice to activate the audio system normally.
- Turn the engine switch to ON and then to off.

■ Replacing the battery

→ P.610

■ If the Stop & Start cancel indicator flashes continuously

The system may be malfunctioning. Have the vehicle inspected by your Toyota dealer.

■ If “Stop & Start System Malfunction Visit Your Dealer” is displayed on the multi-information display

The system may be malfunctioning. Have the vehicle inspected by your Toyota dealer.



WARNING

■ When the Stop & Start system is operating

Make sure to disable the Stop & Start system while the vehicle is in a poorly ventilated area.

If not disabled, the engine may be automatically restarted unexpectedly, causing exhaust gases to collect and enter the vehicle, possibly resulting in death or a serious health hazard.

- Do not leave the vehicle while the engine is stopped by the Stop & Start system (while the Stop & Start indicator is on). An accident may occur due to the automatic engine start function.
- Depress the brake pedal and apply the parking brake when necessary while the engine is stopped by the Stop & Start system (while the Stop & Start indicator is on).

**NOTICE**

■ **To ensure the system operates correctly**

If any of the following situations occur, the Stop & Start system may not operate correctly. Have your vehicle inspected by your Toyota dealer.

- While the driver's seat belt is fastened, the driver's and front passenger's seat belt reminder light flashes.
- Even though the driver's seat belt is not fastened, the driver's and front passenger's seat belt reminder light does not illuminate.
- Even though the driver's door is closed, the open door warning light is illuminated or the interior light is illuminated when the interior light switch is in the door position.
- Even though the driver's door is open, the open door warning light does not illuminate or the interior light does not illuminate when the interior light switch is in the door position.

BSM (Blind Spot Monitor)

The Blind Spot Monitor is a system that uses rear side radar sensors installed on the inner side of the rear bumper on the left and right side to assist the driver in confirming safety when changing lanes.

**WARNING**

■ **Cautions regarding the use of the system**

- The driver is solely responsible for safe driving. Always drive safely, taking care to observe your surroundings.
- The Blind Spot Monitor is a supplementary function which alerts the driver that a vehicle is in a blind spot of the outside rear view mirrors or is approaching rapidly from behind into a blind spot. Do not overly rely on the Blind Spot Monitor. As the function cannot judge if it is safe to change lanes, over reliance could lead to an accident resulting in death or serious injury. As the system may not function correctly under certain conditions, the driver's own visual confirmation of safety is necessary.

System components

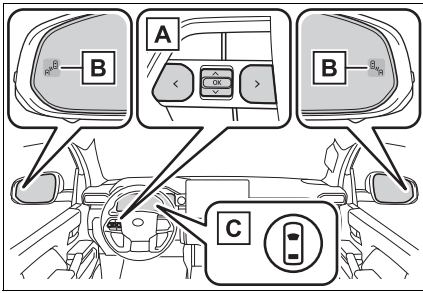

A Meter control switches
Turning the Blind Spot Monitor on/off.

B Outside rear view mirror indicators

When a vehicle is detected in a blind spot of the outside rear view mirrors or approaching rapidly from behind into a blind spot, the outside rear view mirror indicator (→P.78) on the detected side will illuminate. If the turn signal lever is operated toward the detected side, the outside rear view mirror indicator flashes.

C Driving assist information indicator

Illuminates when the Blind Spot Monitor is turned off. At this time, a message will be displayed on the multi-information display.

Outside rear view mirror indicator visibility

In strong sunlight, the outside rear view mirror indicator may be difficult to see.

Customization

Some functions can be customized. (→P.649)

Certification

→P.696

WARNING

To ensure the system can operate properly

Blind Spot Monitor sensors are installed behind the left and right sides of the rear bumper respectively. Observe the following to ensure the Blind Spot Monitor can operate correctly.

- Keep the sensors and the surrounding areas on the rear bumper clean at all times.

If a sensor or its surrounding area on the rear bumper is dirty or covered with snow, the Blind Spot Monitor may not operate and a warning message will be displayed. In this situation, clear off the dirt or snow and drive the vehicle with the operation conditions of the BSM function (→P.321) satisfied for approximately 10 minutes. If the warning message does not disappear, have the vehicle inspected by your Toyota dealer.

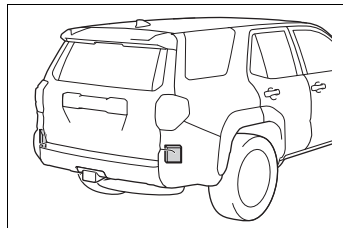

- Do not attach accessories, stickers (including transparent stickers), aluminum tape, etc., to a sensor or its surrounding area on the rear bumper.

- Do not subject a sensor or its surrounding area on the rear bumper to a strong impact. If a sensor is moved even slightly off position, the system may malfunction and vehicles may not be detected correctly. In the following situations, have your vehicle inspected by your Toyota dealer.
- A sensor or its surrounding area is subject to a strong impact.
- If the surrounding area of a sensor is scratched or dented, or part of them has become disconnected.
- Do not disassemble the sensor.
- Do not modify the sensor or surrounding area on the rear bumper.
- If a sensor or the rear bumper needs to be removed/installed or replaced, contact your Toyota dealer.
- Do not paint the rear bumper any color other than an official Toyota color.

Turning the Blind Spot Monitor on/off

The Blind Spot Monitor can be enabled/disabled through a customize setting. (→P.637)

When the Blind Spot Monitor is off, the driving assist information indicator (→P.78) will illuminate and a message will be displayed on the multi-information display.

Each time the engine switch is turned to ON, the Blind Spot Monitor is enabled.

■ Setting the trailer type

Select “Trailer Settings” on the multi-information display and add a trailer according to the display. (→P.96, 105)

■ Auto Trailer Detection (ATD)

Auto Trailer Detection (ATD) detects if a trailer is attached by using the Trailer Brake Controller (TBC) (if equipped) or the Blind Spot Monitor (BSM) sensors.

- Trailers that use TBC can be detected by using the 7-pin trailer connector. (vehicles with the Trailer Brake Controller)
- Other types of trailers can be detected using the BSM sensors.
- When a trailer is detected via the 7-pin trailer connectors (vehicles equipped with the Trailer Brake Controller) or via the BSM, and “Yes” has been selected on the pop-up display on the meter to confirm a trailer is detected, the following modes will change as follows:
 - RCTA, PKSB (if equipped), RCD (if equipped), and the rear sensors of intuitive parking assist will be disabled.
 - The detection area of BSM will be expanded to a maximum length of approximately 50 ft. (15 m) from the vehicle’s rear bumper.

- For trailer auto detection without engagement of 7-pin trailer connector (vehicles with the Trailer Brake Controller), the vehicle should be moving forward at speed of above 6 mph (10 km/h) for at least 10 seconds.
- ATD function is triggered at every engine switch on/off cycle, the vehicle is stopped and the shift lever is in P or N, or the parking brake is set for more than 90 seconds
- When a trailer no longer detected via the BSM, after disconnecting the trailer from the vehicle, and “Yes” has been selected on the pop-up display on the meter to confirm the trailer no longer detected, the previously disabled systems will be enabled and the detection area of the BSM will return to the previous settings.
- Trailer detection via BSM sensors may be delayed if the vehicle is in a crowded environment such as busy parking lot, area surrounded with trees (camping ground) or in an environment with objects in the immediate environment that prevent sensors from sufficiently detecting the trailer.

■ Trailer Length Detection (TLD)

- Once a trailer is detected and if the trailer length in the meter is selected as “Auto”, the TLD function will estimate the trailer length using the Blind Spot Monitor sensors

In order to estimate the trailer length with TLD function and detection area, make at least two 90 degree turns.

If the trailer length is entered manually via multi-information display input, the detection area is also adjusted to exceed the length of the trailer.

■ Trailer Merge Warning (TMW)

- When towing a trailer, the blind spot system uses input from ATD and TLD to modify the detection zone to match the trailer. TMW will alert via the indicators of the outside mirror when a vehicle in an adjacent lane enters the modified detection zone.
- Depending on some combinations of trailer types, trailer dimensions, and bumper types TMW performance may be degraded.

Blind Spot Monitor operation

■ Objects that can be detected while driving

The Blind Spot Monitor uses rear side radar sensors to detect the following vehicles traveling in adjacent lanes and advises the driver of the presence of such vehicles via the indicators on the outside rear view mirrors.

- When not towing a trailer

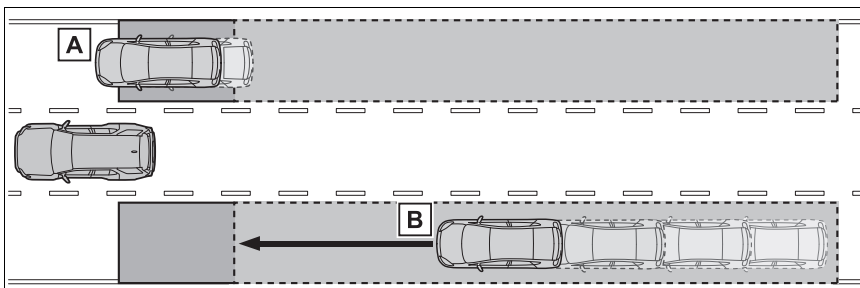

- A** Vehicles that are traveling in areas that are not visible using the outside rear view mirrors (the blind spots)
- B** Vehicles that are approaching rapidly from behind in areas that are not visible using the outside rear view mirrors (the blind spots)

- When towing a trailer

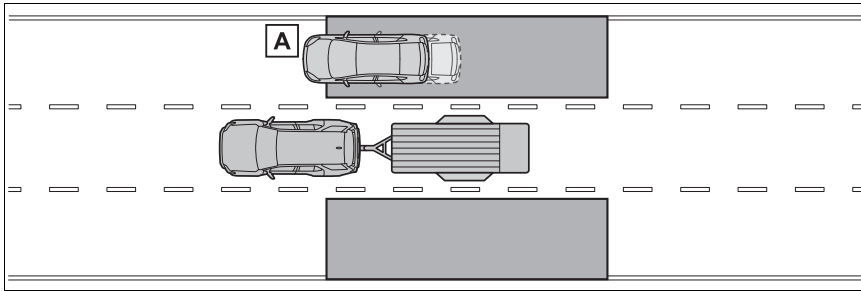

A Vehicles approaching in adjacent lanes that may not be visible using the outside rear view mirrors (the blind spots)

■ **Detection range while driving**

The areas that vehicles can be detected in are outlined below.

- When not towing a trailer

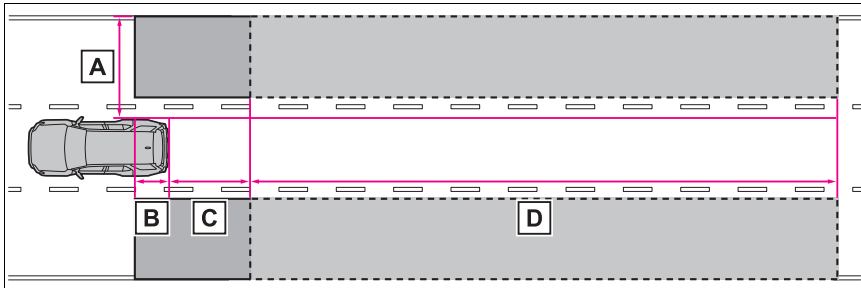

The range of each detection area is:

- A** Approximately 1.6 ft. (0.5 m) to 11.5 ft. (3.5 m) from either side of the vehicle^{*1}
- B** Approximately 3.3 ft. (1 m) forward of the rear bumper
- C** Approximately 9.8 ft. (3 m) from the rear bumper
- D** Approximately 9.8 ft. (3 m) to 197 ft. (60 m) from the rear bumper^{*2}

● When towing a trailer

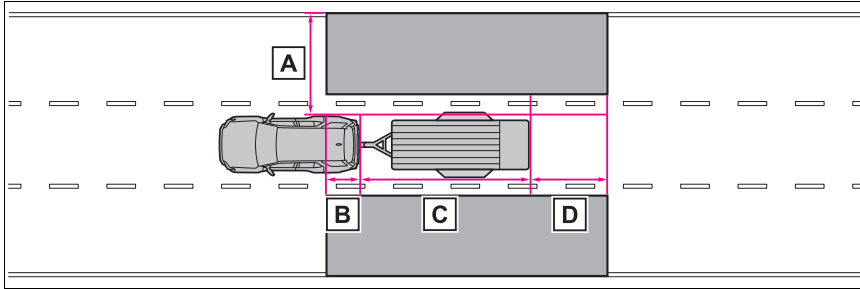

The range of each detection area is:

- A** Approximately 1.6 ft. (0.5 m) to 11.5 ft. (3.5 m) from either side of the vehicle*¹
- B** Approximately 3.3 ft. (1 m) forward of the rear bumper
- C** Trailer overall length*³
- D** Approximately 9.8 ft. (3 m) from the rear end of trailer*³

*¹: The area between the side of the vehicle and 1.6 ft. (0.5 m) from the side of the vehicle cannot be detected.

*²: The greater the difference in speed between your vehicle and the detected vehicle is, the farther away the vehicle will be detected, causing the outside rear view mirror indicator to illuminate or flash.

*³: The system is designed to support utility and boat trailers up to 8.5 ft. (2.59 m) wide, most enclosed type trailer types up to 8 ft. (2.46 m) wide, and trailers no longer than 39 ft. (12.0 m). For wider trailers and/or trailers with shorter tongues lengths the indicator warning in the outer mirror may be delayed.

■ The Blind Spot Monitor linked function

The LDA (Lane Departure Alert) has a function that uses information of detected vehicles driving in an adjacent lane. For details about the function and its operating conditions, P.275.

■ The Blind Spot Monitor is operational when

The Blind Spot Monitor is operational when all of the following conditions are met:

- The engine switch is in ON.
- The Blind Spot Monitor is on.
- The shift lever is in a position

other than R.

- The vehicle speed is approximately 7 mph (10 km/h) or more.

■ The Blind Spot Monitor will detect a vehicle when

The Blind Spot Monitor will detect a vehicle present in the detection area in the following situations:

- A vehicle in an adjacent lane overtakes your vehicle.
- You overtake a vehicle in an adjacent lane slowly.
- Another vehicle enters the detection area when it changes lanes.

■ **Situations in which the Blind Spot Monitor cannot detect vehicles.**

The Blind Spot Monitor cannot detect the following vehicles and other objects:

- Small motorcycles, bicycles, pedestrians, etc.*
- Vehicles traveling in the opposite direction
- Guardrails, walls, signs, parked vehicles and similar stationary objects*
- Following vehicles that are in the same lane*
- Vehicles traveling 2 lanes away from your vehicle*
- Vehicles which are being overtaken rapidly by your vehicle*

*: Depending on the conditions, detection of a vehicle and/or object may occur.

■ **Conditions under which the system may not function correctly**

- The Blind Spot Monitor may not detect vehicles correctly in the following situations:
 - When the sensor is misaligned due to a strong impact to the sensor or its surrounding area
 - When mud, snow, ice, a sticker, etc., is covering the sensor or surrounding area on the rear bumper
 - When driving on a wet road surface, such as in a puddle, while in inclement weather, such as heavy rain, snow, fog, etc.
 - When multiple vehicles are approaching with only a small gap between each vehicle

- When the distance between your vehicle and a following vehicle is short
- When there is a significant difference in speed between your vehicle and the vehicle that enters the detection area
- When the difference in speed between your vehicle and another vehicle is changing
- When a vehicle enters a detection area traveling at about the same speed as your vehicle
- As your vehicle starts from a stop, a vehicle remains in the detection area
- When driving up and down consecutive steep inclines, such as hills, dips in the road, etc.
- When driving on roads with sharp bends, consecutive curves, or uneven surfaces
- When vehicle lanes are wide, or when driving on the edge of a lane, and the vehicle in an adjacent lane is far away from your vehicle
- When an accessory (such as a bicycle carrier) is installed to the rear of the vehicle
- When there is a significant difference in height between your vehicle and the vehicle that enters the detection area
- Immediately after the Blind Spot Monitor is turned on
- Instances of the Blind Spot Monitor unnecessarily detecting a vehicle and/or object may increase in the following situations:
 - When the sensor is misaligned due to a strong impact to the sensor or its surrounding area
 - When the distance between your vehicle and a guardrail, wall, etc., that enters the detection area is short
 - When driving up and down consecutive steep inclines, such as hills, dips in the road, etc.
 - When vehicle lanes are narrow, or when driving on the edge of a lane, and a vehicle traveling in a lane other than the adjacent lanes

- enters the detection area
- When driving on roads with sharp bends, consecutive curves, or uneven surfaces
- When the tires are slipping or spinning
- When the distance between your vehicle and a following vehicle is short
- When an accessory (such as a bicycle carrier) is installed to the rear of the vehicle
- When turning at an intersection with a trailer is being towed and an adjacent vehicle continues traveling straight

Intuitive parking assist*

*: If equipped

The intuitive parking assist function detects the approximate distance from the vehicle and an object such as a wall using ultrasonic sensors and informs the driver with the multimedia display distance display and buzzer.

System components

■ Type of sensors

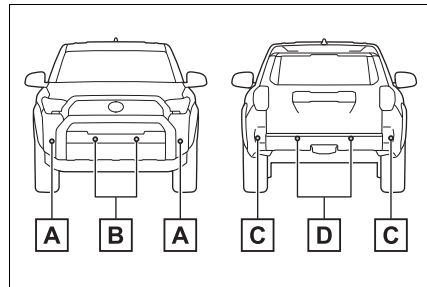

A Front corner sensors

B Front center sensors

C Rear corner sensors

D Rear center sensors

■ Display

When the sensors detect an object, such as a wall, a graphic is shown on the multimedia display depending on the position and distance to the object.

Vehicles without multimedia dis-

play or rear camera: When detecting a stationary object, the intuitive parking assist detection indicator illuminates. (→P.78)

The illustration is an example for explanation and may differ depending on the specifications.

▶ Multimedia display

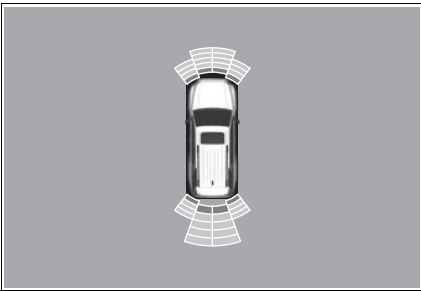

Turning the intuitive parking assist function ON/OFF

The intuitive parking assist function can be enabled/disabled through a customize setting. (→P.637)

When the intuitive parking assist function is disabled, the intuitive parking assist OFF indicator (→P.78) illuminates on the multi-information display.

If the system switches to OFF (disabled) and the intuitive parking assist is stopped, the intuitive parking assist will not be re-enabled until ON (enabled) is selected again from the customize setting (→P.637). (It remains off even if the engine switch is turned to ON again after the

engine switch has been turned off.)

Vehicles without the multimedia display or rear camera: However, the system will automatically turn on (enabled) and the intuitive parking assist OFF indicator will turn off if the shift position is changed to R.

When the shift position is R, the intuitive parking assist cannot be turned on or off.

The setting of intuitive parking assist itself will not change.

■ **When towing a trailer**

- When Auto Trailer Detection (ATD) (→P.318) is activated, rear sensor turns off.
- When the shift position is in R, the intuitive parking assist OFF indicator (→P.78) turns on and a message is displayed in the multi-information display.
- If a camera malfunction occurs while the trailer is connected, There may be cases where the notification message that indicates Intuitive Parking Assist, RCD (if equipped), or PKSB is OFF may not be displayed.

⚠ WARNING

■ **Cautions regarding the use of the system**

There is a limit to the degree of recognition accuracy and control performance that this system can provide, do not overly rely on this system. The driver is always responsible for paying attention to the vehicle's surroundings and driving safely.

**WARNING****■ To ensure the system can operate properly**

Make sure to observe the following precautions. The system may not operate properly and may lead to an unexpected accident. When these precautions cannot be observed, turn the system off.

- Do not damage the sensors, and always keep them clean.
- Do not attach a sticker or install a component, such as a backlit license plate (especially fluorescent type), fog lights, fender pole or wireless antenna near a radar sensor.
- Do not subject the surrounding area of the sensor to a strong impact. If subjected to an impact, have the vehicle inspected by your Toyota dealer. If the front or rear bumper needs to be removed/installed or replaced, contact your Toyota dealer.
- Do not modify, disassemble or paint the sensors.
- Do not attach a license plate cover.
- Keep your tires properly inflated.
- Do not install a suspension other than a genuine suspension.

■ Notes when washing the vehicle

- When using a high pressure washer to wash the vehicle, do not spray the sensors directly, as doing so may cause a sensor to malfunction.

- When using steam to clean the vehicle, do not direct steam too close to the sensors, as doing so may cause a sensor to malfunction.

■ The system can be operated when

- The engine switch is in ON.
- The intuitive parking assist is on.
- The vehicle speed is less than about 6 mph (10 km/h).

● Front corner sensors:

The shift position is in a position other than P.

● Front center sensors:

The shift position is in a position other than P or R.

● Rear corner and rear center sensors:

The shift position is in R.

Vehicles without the multimedia display or rear camera: The system will automatically turn on (enabled) and the intuitive parking assist OFF indicator will turn off if the shift position is changed to R.

The setting of intuitive parking assist itself will not change.

■ Sensor detection information

- The sensor's detection areas are limited to the areas around the vehicle's front and rear bumpers.
- Certain vehicle conditions and the surrounding environment may affect the ability of a sensor to correctly detect an object.
- Objects may not be detected if they are too close to the sensor.
- There will be a short delay between object detection and display.

Even at low speeds, there is a possibility that the object will come

within the sensor's detection areas before the display is shown and the warning beep sounds.

- It might be difficult to hear the buzzer due to the volume of the audio system or air flow noise of the air conditioning system.
- It may be difficult to hear the sound of this system due to the buzzers of other systems.
- If the meter malfunctions, the buzzer may not sound.

■ Objects which the system may not be properly detected

The shape of the object may prevent the sensor from detecting it. Pay particular attention to the following objects:

- Wires, fences, ropes, etc.
- Cotton, snow and other materials that absorb sound waves
- Sharply-angled objects
- Low objects
- Tall objects with upper sections projecting outwards in the direction of your vehicle

People may not be detected if they are wearing certain types of clothing.

■ Situations in which the system may not operate properly

Certain vehicle conditions and the surrounding environment may affect the ability of a sensor to correctly detect objects. Particular instances where this may occur are listed below.

- There is dirt, snow, water drops or ice on a sensor. (Cleaning the sensors will resolve this problem.)
- A sensor is frozen. (Thawing the area will resolve this problem.) In especially cold weather, if a sensor is frozen the sensor display may be displayed abnormally, or objects, such as a wall, may not be detected.

- When a sensor or the area around a sensor is extremely hot or cold.

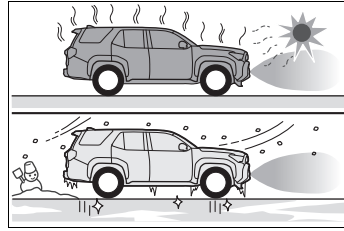

- On an extremely bumpy road, on an incline, on gravel, or on grass.
- When vehicle horns, vehicle detectors, motorcycle engines, air brakes of large vehicles, the clearance sonar of other vehicles or other devices which produce ultrasonic waves are near the vehicle
- A sensor is coated with a sheet of spray or heavy rain.
- If objects draw too close to the sensor.
- When a pedestrian is wearing clothing that does not reflect ultrasonic waves (ex. skirts with gathers or frills).
- When objects that are not perpendicular to the ground, not perpendicular to the vehicle traveling direction, uneven, or waving are in the detection range.
- When strong winds are blowing
- When driving in inclement weather such as fog, snow or a sandstorm
- When an object that cannot be detected is between the vehicle and a detected object
- If an object such as a vehicle, motorcycle, bicycle or pedestrian cuts in front of the vehicle or runs out from the side of the vehicle
- If the orientation of a sensor has been changed due to a collision or other impact
- When equipment such as a towing eyelet, transport hook, bumper protector, bumper trim, bicycle carrier or snow-removal device

(snow plow) is installed near the sensor

- If the front of the vehicle is raised or lowered due to the carried load
- If the vehicle cannot be driven in a stable manner, such as when the vehicle has been in an accident or is malfunctioning
- When tire chains, compact spare tire or an emergency tire puncture repair kit are used
- When towing with the vehicle

■ **Situations in which the system may operate even if there is no possibility of a collision**

In some situations, such as the following, the system may operate even though there is no possibility of a collision.

- When driving on a narrow road

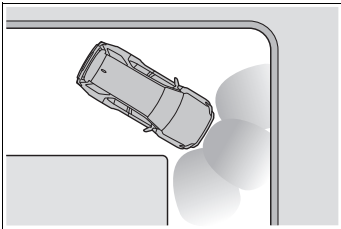

- When driving toward a banner, flag, low-hanging branch or boom barrier (such as those used at railroad crossings, toll gates and parking lots)
- When there is a rut or hole in the surface of the road
- When driving on a metal cover (grating), such as those used for drainage ditches
- When driving up or down a steep slope
- If a sensor is hit by a large amount of water, such as when driving on a flooded road
- There is dirt, snow, water drops or ice on a sensor. (Cleaning the sensors will resolve this problem.)
- A sensor is coated with a sheet of

spray or heavy rain

- When driving in inclement weather such as fog, snow or a sandstorm
- When strong winds are blowing

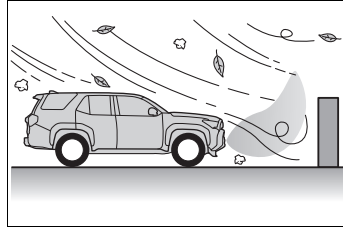

- When vehicle horns, vehicle detectors, motorcycle engines, air brakes of large vehicles, the clearance sonar of other vehicles or other devices which produce ultrasonic waves are near the vehicle
- If the front of the vehicle is raised or lowered due to the carried load
- If the orientation of a sensor has been changed due to a collision or other impact
- The vehicle is approaching a tall or curved curb
- Driving close to columns (H-shaped steel beams, etc.) in multi-story parking garages, construction sites, etc.
- If the vehicle cannot be driven in a stable manner, such as when the vehicle has been in an accident or is malfunctioning
- On an extremely bumpy road, on an incline, on gravel, or on grass



- When tire chains, compact spare tire or an emergency tire puncture repair kit are used
- When towing with the vehicle

■ **When towing a trailer**

Rear sensors turn off when the trailer connection is detected.

When reversing, the rear sensors turn off, but the front corner sensors operate.

■ **Certification**

→P.698

Sensor detection display, object distance

■ **Detection range of the sensors**

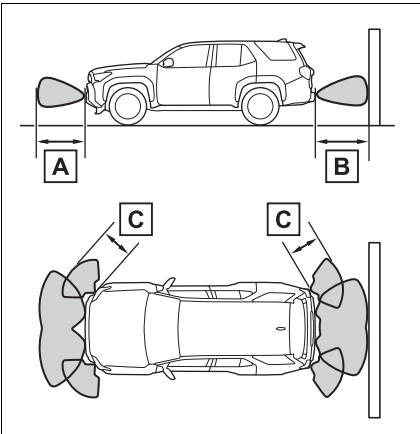

■ **The distance and buzzer**

Approximate distance to obstacle	Buzzer
Front center sensor: Approximately 3.3 ft. (100 cm) to 2.0 ft. (60 cm)* Rear center sensor: Approximately 4.9 ft. (150 cm) to 2.0 ft. (60 cm)*	Slow
Approximately 2.0 ft. (60 cm) to 1.5 ft. (45 cm)*	Medium

A Approximately 3.3 ft. (100 cm)

B Approximately 4.9 ft. (150 cm)

C Approximately 2.0 ft. (60 cm)

The diagram shows the detection range of the sensors.

Note that the sensors cannot detect objects that are extremely close to the vehicle.

The range of the sensors may change depending on the shape of the object, etc.

Approximate distance to obstacle	Buzzer
Approximately 1.5 ft. (45 cm) to 1.0 ft. (30 cm)*	Fast
Approximately less than 1.0 ft. (30 cm)	Continuous

* : Automatic buzzer mute function is enabled. (→P.329)

Intuitive parking assist buzzer

A buzzer sounds when the sensors are operating.

- The buzzer beeps faster as the vehicle approaches a static object. When the vehicle comes within the approximately 1.0 ft. (30 cm) of the object, the buzzer will sound continuously.
- When 2 or more sensors simultaneously detect a static object, the buzzer sounds for the nearest object.
- After an intermittent buzzer begins sounding, if the distance between the vehicle and the detected static object does not become shorter, the buzzer will be muted automatically. (automatic buzzer mute function)

■ Adjusting the buzzer volume

The buzzer volume of the intuitive parking assist, RCTA, and RCD (if equipped) can all be changed at once from the customize settings. (→P.637)

■ Muting a buzzer

When the temporary mute switch is displayed on the multimedia display, this switch can be pressed to temporarily mute the buzzer.

Select the switch to mute a buzzer of the intuitive parking assist, RCTA, and RCD (if equipped) all together.

- Mute will be automatically canceled in the following situations:
 - When the shift position is changed.
 - When the vehicle speed exceeds a certain speed.
 - When there is a malfunction in a sensor or the system is temporarily unavailable.
 - When the operating function is disabled manually.
 - When the engine switch is turned off.

RCTA (Rear Cross Traffic Alert) function

The RCTA function uses the BSM rear side radar sensors installed behind the rear bumper. This function is intended to assist the driver in checking areas that are not easily visible when backing up.

WARNING

■ Cautions regarding the use of the system

The driver is solely responsible for safe driving. Always drive safely, taking care to observe your surroundings.

The RCTA function is only a supplementary function which alerts the driver that a vehicle is approaching from the right or left at the rear of the vehicle.

As the RCTA function may not function correctly under certain conditions, the driver's own visual confirmation of safety is necessary.

Over reliance on this function may lead to an accident resulting death or serious injury.

■ To ensure the system can operate properly

→P.317

System components

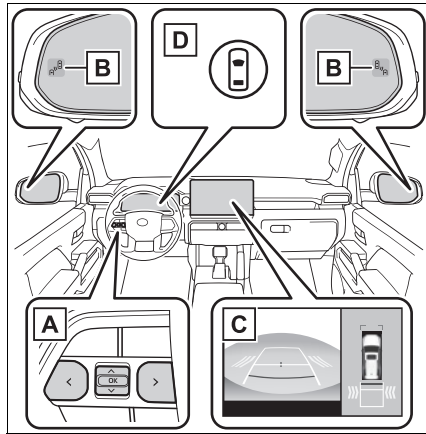

A Meter control switches

Operate the meter control switches to enable/disable the RCTA function on the multi-information display.

B Outside rear view mirror indicators

If a vehicle is detected as approaching from the left or right behind the vehicle, both outside rear view mirror indicators (→P.78) will blink and a buzzer will sound.

C Multimedia display

If a vehicle approaching from the right or left at the rear of the vehicle is detected, the RCTA icon (→P.331) for the detected side will be displayed on the multimedia display. This illustration* shows an example of a vehicle approaching from both sides of the vehicle.

*: Depending on the vehicle grade and equipped options, the actual screen may be different from this illustration.

D Driving assist information indicator

Illuminates when the RCTA is turned off. At this time, a message will be displayed on the multi-information display.

Turning the RCTA function on/off

The RCTA can be enabled/disabled through a customize setting. (→P.637)

When the RCTA function is off, the driving assist information indicator (→P.78) will illuminate and a message will be displayed on the multi-information display. Each time the engine switch is turned to ON, the RCTA function is enabled.

■ When towing a trailer

When Auto Trailer Detection (ATD) (→P.318) is activated, the function turns off.

■ Outside rear view mirror indicator visibility

In strong sunlight, the outside rear view mirror indicator may be difficult to see.

■ Hearing the RCTA buzzer

The RCTA buzzer may be difficult to hear over loud noises, such as if the audio system volume is high.

■ Rear side radar sensors

→P.317

RCTA function

■ Operation of the RCTA function

The RCTA function uses rear side radar sensors to detect vehicles approaching from the right or left at the rear of the vehicle and alerts the driver of the presence of such vehicles by flashing the outside rear view mirror indicators and sounding a buzzer.

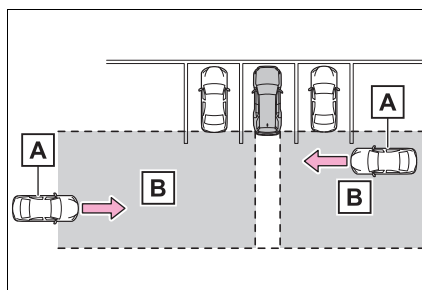

A Approaching vehicles

B Detection areas of approaching vehicles

■ RCTA icon display

When a vehicle approaching from the right or left at the rear of the vehicle is detected, the following will be displayed on the multimedia display.

Example: Vehicles are approaching from both sides of the vehicle

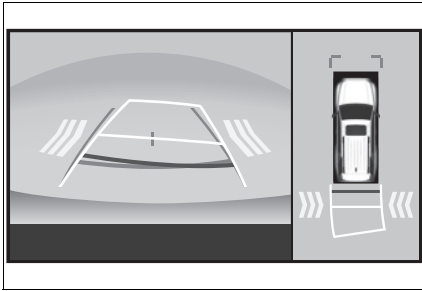

RCTA function detection areas

The areas that vehicles can be detected in are outlined below.

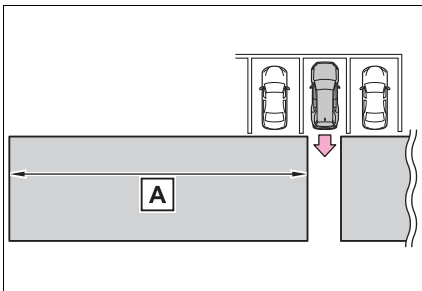

The buzzer can alert the driver of faster vehicles approaching from farther away.

Example:

Approaching vehicle speed	A Approximate alert distance
34 mph (56 km/h) (fast)	98 ft. (30 m)
5 mph (8 km/h) (slow)	13 ft. (4 m)

The RCTA function is operational when

The RCTA function operates when all of the following conditions are met:

- The engine switch is in ON.

- The RCTA function is on.
- The shift position is in R.
- The vehicle speed is less than approximately 9 mph (15 km/h).
- The approaching vehicle speed is between approximately 5 mph (8 km/h) and 34 mph (56 km/h).
- The 7-pin connector for Trailer Brake controller is not engaged (if equipped) or when trailer is not detected using the Blind Spot Monitor (BSM) sensors.

Setting the buzzer volume

The buzzer volume of the RCTA, intuitive parking assist (if equipped), and RCD (if equipped) can be adjusted all together through a customize setting. (→P.637)

Muting a buzzer temporarily

When an object is detected, the temporary mute switch is displayed on the multimedia Display. Select the switch to mute the buzzer of the intuitive parking assist (if equipped), RCTA, and RCD (if equipped) all together.

Mute will be canceled automatically in the following situations:

- When the shift lever is changed.
- When the vehicle speed exceeds a certain speed.
- When there is a malfunction in a sensor or the system is temporarily unavailable.
- When the operating function is disabled manually.
- When the engine switch is turned off

Conditions under which the system will not detect a vehicle

The RCTA function is not designed to detect the following types of vehicles and/or objects:

- Vehicles approaching from directly behind
- Vehicles backing up in a parking

space next to your vehicle

- Vehicles that the sensors cannot detect due to obstructions

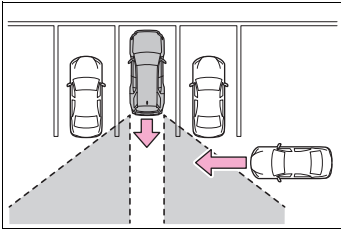

- Guardrails, walls, signs, parked vehicles and similar stationary objects*
- Small motorcycles, bicycles, pedestrians, etc.*
- Vehicles moving away from your vehicle
- Vehicles approaching from the parking spaces next to your vehicle*
- The distance between the sensor and approaching vehicle gets too close

*: Depending on the conditions, detection of a vehicle and/or object may occur.

■ **Situations in which the system may not operate properly**

The RCTA function may not detect vehicles correctly in the following situations:

- When the sensor is misaligned due to a strong impact to the sensor or its surrounding area
- When mud, snow, ice, a sticker, etc., is covering the sensor or surrounding area on the position above the rear bumper
- When driving on a wet road surface, such as in a puddle, while in inclement weather, such as heavy rain, snow, fog, etc.
- When multiple vehicles are approaching with only a small gap between each vehicle

- When a vehicle is approaching at high speed
- When equipment that may obstruct a sensor is installed, such as a towing eyelet, bumper protector (an additional trim strip, etc.), bicycle carrier, or snow plow
- When backing up on a slope with a sharp change in grade

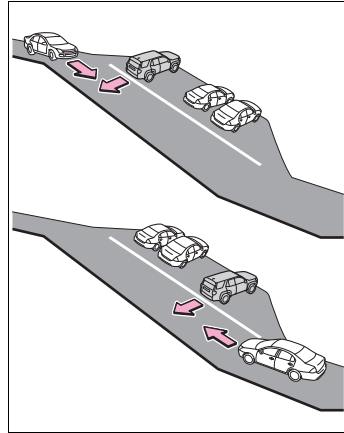

- When backing out of a sharp angle parking spot

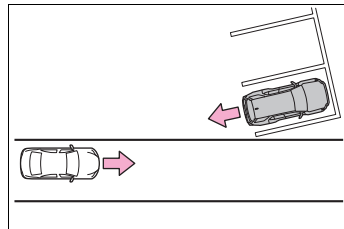

- Immediately after the RCTA function is turned on
- Immediately after the engine is started with the RCTA function on
- When the sensors cannot detect a vehicle due to obstructions
- When there is a significant difference in height between your vehicle and the vehicle that enters the detection area
- When a sensor or the area around a sensor is extremely hot or cold
- If the suspension has been modified

fied or tires of a size other than specified are installed

- If the front of the vehicle is raised or lowered due to the carried load
- When turning while backing up

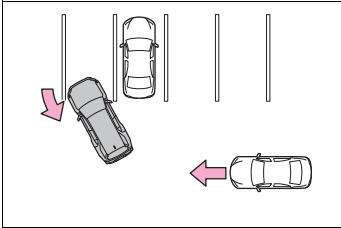

- When a vehicle turns into the detection area

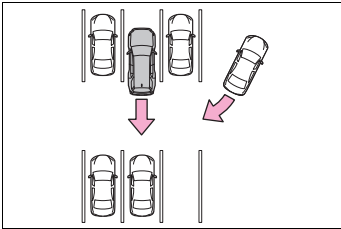

■ Situations in which the system may operate even if there is no possibility of a collision

Instances of the RCTA function unnecessarily detecting a vehicle and/or object may increase in the following situations:

- When the parking space faces a street and vehicles are being driven on the street

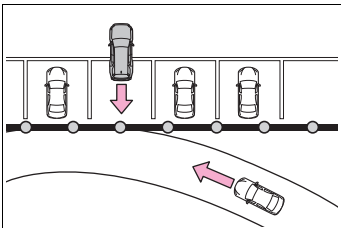

- When the distance between your vehicle and metal objects, such as a guardrail, wall, sign, or parked vehicle, which may reflect electrical waves toward the rear of the vehicle, is short

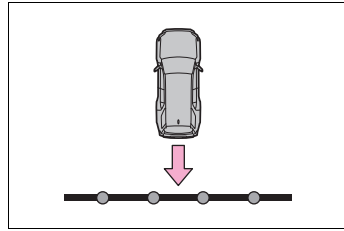

- When equipment that may obstruct a sensor is installed, such as a towing eyelet, bumper protector (an additional trim strip, etc.), bicycle carrier, or snow plow
- When a vehicle passes by the side of your vehicle

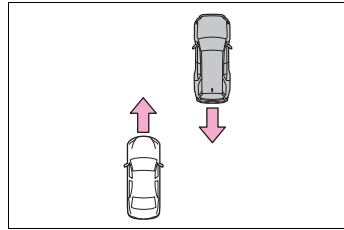

- When a detected vehicle turns while approaching the vehicle

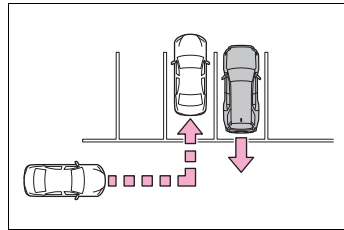

- When there are spinning objects near your vehicle such as the fan of an air conditioning unit
- When water is splashed or sprayed toward the rear bumper, such as from a sprinkler
- Moving objects (flags, exhaust fumes, large rain droplets or snowflakes, rain water on the road surface, etc.)
- When the distance between your vehicle and a guardrail, wall, etc., that enters the detection area is short
- Gratings and gutters

- When a sensor or the area around a sensor is extremely hot or cold
- If the suspension has been modified or tires of a size other than specified are installed
- If the front of the vehicle is raised or lowered due to the carried load

RCD (Rear Camera Detection)*

*: If equipped

When the vehicle is backing up, the rear camera detection function can detect pedestrians in the detection area behind the vehicle. If a pedestrian is detected, a buzzer will sound and an icon will be displayed on the multimedia display to inform the driver of the pedestrian.



WARNING

■ Cautions regarding the use of the system

The recognition and control capabilities for this system are limited.

The driver should always drive safely by always being responsible without over relying on the system and have a understanding of the surrounding situations.

■ To ensure the system can operate properly

Observe the following, otherwise there is the danger that could lead to an accident.

- Always clean the camera without damaging it.
- Do not install market electronic parts (such as illuminated license plate, fog lamps, etc.) in the camera vicinity.

WARNING

- Do not subject the camera vicinity to strong impacts. If the vicinity is subjected to a strong impact, have the vehicle inspected by your Toyota dealer.
- Do not disassemble, remodel or paint the camera.
- Do not attach accessories or stickers to the camera.
- Do not install market protection parts (bumper trim, etc.) to the rear bumper.
- Maintain suitable tire air pressure.
- Make sure the back door is completely closed.
- **When to disable the RCD function**
In the following situations, disable the system. The RCD function may not operate properly, possibly leading to an accident.
 - The contents mentioned above are not observed.
 - Suspensions other than the genuine parts are installed.

System component

Location of the rear camera

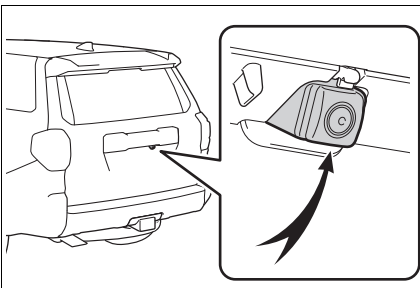

RCD display

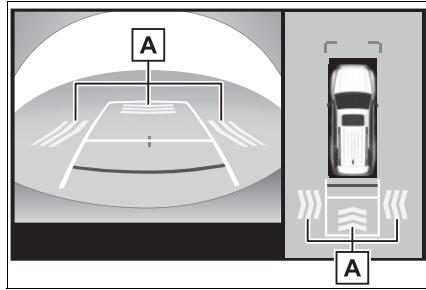

A Pedestrian detection icon

Displayed automatically when a pedestrian is detected behind the vehicle.

Turning the RCD function on/off

The RCD function can be enabled/disabled through a customize setting. (→P.637)

When the RCD function is disabled, the driving assist information indicator (→P.78) illuminates, and a message is displayed on the multi-information display.

Each time the engine switch is turned off then changed to ON, the RCD function will be enabled automatically.

When a pedestrian is detected

If a pedestrian is in the area behind the vehicle or if the rear camera detected that a pedestrian is approaching the vehicle from behind, the system urges caution from the driver by

sounding the buzzer and displaying the detection of a pedestrian on the multimedia display as follows:

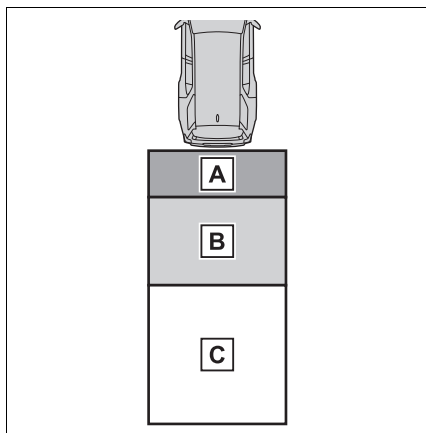

A If a pedestrian is detected in

area **A**

Buzzer: Sounds repeatedly
Pedestrian detection icon:
Blinks

B If a pedestrian is detected in

area **B**

Buzzer (When the vehicle is stationary): Sounds 3 times
Buzzer (When the vehicle is backing up, when a pedestrian approaches the rear of the vehicle): Sounds repeatedly

Pedestrian detection icon:
Blinks

C If the system determines that

your vehicle may collide with a pedestrian in area **C**

Buzzer: Sounds repeatedly
Pedestrian detection icon:

Blinks

■ When towing a trailer

- When Auto Trailer Detection (ATD) (→P.318) is activated, the function turns off.
- When the shift position is in R, the intuitive parking assist OFF indicator (→P.74) turns ON and a message is displayed in the multi-information display.
- If a camera malfunction occurs while the trailer is connected, There may be cases where the notification message that indicate Intuitive Parking Assist, RCD, or PKSB is OFF may not be displayed

■ The rear camera detection function is operational when

- The engine switch is in ON.
- RCD function is on.
- The shift position is in R.

■ Setting the buzzer volume

The buzzer volume of the intuitive parking assist, RCTA, and RCD can all be changed at once from the customize settings. (→P.637)

■ Muting a buzzer temporarily

When an object is detected, the temporary mute switch is displayed on the multimedia display. Select the switch to mute a buzzer of the intuitive parking assist, RCTA, and RCD all together.

Mute will be automatically canceled in the following situations:

- When the shift position is changed.
- When the vehicle speed exceeds a certain speed.
- When there is a malfunction in a sensor or the system is temporarily unavailable.
- When the operating function is disabled manually.

- When the engine switch is turned off.

■ Situations in which the system may not operate properly

- Some pedestrians, such as the following, may not be detected by the rear camera detection function, preventing the function from operating properly:
 - Pedestrians who are bending forward or squatting
 - Pedestrians who are lying down
 - Pedestrians who are running
 - Pedestrians who suddenly appear from the shadow of the vehicle or a building
 - Pedestrians who are riding moving objects such as a bicycle or skateboard
 - Pedestrians wearing oversized clothing such as a rain coat, long skirt, etc., making their silhouette obscure
 - Pedestrians whose body is partially hidden by an object, such as a cart or umbrella
 - Pedestrians which are obscured by darkness, such as at night
- In some situations, such as the following, pedestrians may not be detected by the rear camera detection function, preventing the function from operating properly:
 - When backing up in inclement weather (rain, snow, fog, etc.)
 - The lens is dirty (by dirt or snow-melting agent, etc.) or scratched
 - When a very bright light, such as the sun, or the headlights of another vehicle, shines directly into the rear camera
 - When backing up in a place where the surrounding brightness changes suddenly, such as at the entrance or exit of a garage or underground parking lot
 - When backing up in a dim environment such as during dusk or in an underground parking lot
 - When the camera position and direction are deviated
 - When a towing hook is attached
 - When water droplets are flowing

on the camera lens

- When the vehicle height is extremely changed (nose up, nose down, etc.)
- When tire chains or an emergency tire puncture repair kit are used
- When the suspension has been lowered or tires that have a different size than the genuine tires are installed
- When an aftermarket electronic part (backlit license plate, fog light, etc.) is installed near the rear camera
- If a bumper protector, such as an additional trim strip, is installed to the rear bumper

■ Situations in which the system may operate unexpectedly

- Even though there are no pedestrians in the detection area, some objects, such as the following, may be detected, possibly causing the rear camera detection function to operate.
 - Three dimensional objects, such as a pole, traffic cone, fence, or parked vehicle
 - Moving objects, such as a car or motorcycle
 - Objects moving toward your vehicle when backing up, such as flags or puddles (or airborne matter, such as smoke, steam, rain, or snow)
 - Cobblestone or gravel roads, tram rails, road repairs, white lines, pedestrian crossings or fallen leaves on the road
 - Metal covers (gratings), such as those used for drainage ditches
 - Objects reflected in a puddle or on a wet road surface
 - Shadows on the road
- In some situations, such as the following, the rear camera detection function may operate even though there are no pedestrians in the detection area.
 - When backing up toward the roadside or a bump on the road
 - When backing up toward an incline/decline

- When the vehicle height is extremely changed (nose up, nose down, etc.)
- When an aftermarket electronic part (backlit license plate, fog light, etc.) is installed near the rear camera
- If a bumper protector, such as an additional trim strip, is installed to the rear bumper
- If the orientation of the rear camera has been changed due to a collision or other impact, or removal and installation
- If a towing eyelet is installed to the rear of the vehicle
- When water is flowing over the rear camera lens
- The lens is dirty (by dirt or snow-melting agent, etc.)
- If there is a flashing light in the detection area, such as the emergency flashers of another vehicle
- When tire chains or an emergency tire puncture repair kit are used
- Situations in which the rear camera detection function may be difficult to notice
- The buzzer may be difficult to hear if the surrounding area is noisy or the audio system volume is high.
- If the temperature in the cabin is extremely high or low, the multimedia display may not operate correctly.

PKSB (Parking Support Brake)*

*: If equipped

The PKSB (Parking Support Brake) is a system that issues warnings and automatically performs braking to help reduce collision damage with operation targets that were detected when traveling at a low speed such as when parking.

PKSB (Parking Support Brake) system

The system has detected the following as operation targets. (The operation targets vary depending on the function.)

- Parking Support Brake function (static objects front and rear of the vehicle):
→P.344
- Parking Support Brake function (moving vehicles rear of the vehicle):
→P.347
- Parking Support Brake function (pedestrians rear of the vehicle) (if equipped):
→P.348

**WARNING**

■ **Cautions regarding the use of the system**

Do not overly rely on the system, as doing so may lead to an accident. Always drive while checking the safety of the surroundings of the vehicle.

Depending on the vehicle and road conditions, weather, etc., the system may not operate.

The detection capabilities of sensors and radars are limited. Always drive while checking the safety of the surroundings of the vehicle.

- The driver is solely responsible for safe driving. Always drive carefully, taking care to observe your surroundings. The Parking Support Brake system is designed to provide support to lessen the severity of collisions. However, it may not operate in some situations.
- The Parking Support Brake system is not designed to stop the vehicle completely. Additionally, even if the system has stopped the vehicle, it is necessary to depress the brake pedal immediately as brake control will be canceled after approximately 2 seconds.
- It is extremely dangerous to check the system operations by intentionally driving the vehicle into the direction of a wall, etc. Never attempt such actions.

■ **When to disable the Parking Support Brake**

In the following situations, disable the Parking Support Brake as the system may operate even though there is no possibility of a collision.

- When inspecting the vehicle using a chassis roller, chassis dynamo or free roller
- When loading the vehicle onto a boat, truck or other transport vessel
- If the suspension has been modified or tires of a size other than specified are installed
- If the front of the vehicle is raised or lowered due to the carried load
- When equipment such as a towing hook, transport hook, bumper protector, bumper trim, bicycle carrier or snow-removal device (snow plow) is installed near the sensor
- When using automatic car washing devices
- If the vehicle cannot be driven in a stable manner, such as when the vehicle has been in an accident or is malfunctioning
- When the vehicle is driven in a sporty manner or off-road
- When the tires are not properly inflated
- When the tires are very worn
- When tire chains, a compact spare tire or an emergency tire puncture repair kit are used.

■ **Precautions for the suspension**

Do not modify the suspension of the vehicle. If the height or tilt of the vehicle is changed, the sensors may not be able to detect detectable objects and the system may not operate correctly, possibly leading to an accident.

Enabling/Disabling the Parking Support Brake

The Parking Support Brake function can be enabled/disabled through a customize setting. (→P.637)

When the PKSB (Parking Support Brake) is disabled, the driving assist information indicator (→P.78) illuminates, and a message is displayed on the multi-information display.

If the system switches to OFF (disabled) and the PKSB (Parking Support Brake) is stopped, the PKSB (Parking Support Brake) will not be re-enabled until ON (enabled) is selected again from the customize setting (→P.637).

(It remains off even if the engine switch is turned to ON again after the engine switch has been turned off.)

■ When the four-wheel drive control switch is in “4L” (part-time 4WD models) or “L4L” (full-time 4WD models)

The Parking Support Brake function automatically turns off.

■ When towing a trailer

- When Auto Trailer Detection (ATD) (→P.318) is activated, the function turns off.
- When the shift position is in R, the intuitive parking assist OFF indicator (→P.74) turns on and a message is displayed in the multi-information display.
- If a camera malfunction occurs

while the trailer is connected, There may be cases where the notification message that indicates Intuitive Parking Assist, RCD (if equipped), or PKSB is OFF may not be displayed.

Display and buzzer for engine output restriction control and brake control

If the engine output restriction control or brake control operates, a buzzer will sound and a message that indicates limited acceleration or prompts the driver to brake will be displayed on the multimedia display and multi-information display, to alert the driver.

Depending on the situation, output restriction control operates to either limit acceleration or restrict output as much as possible.

- Engine output restriction control is operating (acceleration restriction)

Acceleration greater than a certain amount is restricted by the system.

Multimedia display: No warning displayed

Message example on the multi-information display: “Object Detected Acceleration Reduced”

Driving assist information indicator: Not illuminated

Buzzer: Does not sound

- Engine output restriction control is operating (output restricted as much as possible)

The system has determined that

stronger-than-normal brake operation is necessary.

Message example on the multimedia display (vehicles with panoramic view monitor* and multi-terrain monitor): "BRAKE!"

Message example on the multi-information display: "BRAKE!"

Driving assist information indicator: Not illuminated

Buzzer: Short beep

- Brake control is operating

The system determined that emergency braking is necessary.

Message example on the multimedia display (vehicles with panoramic view monitor* and multi-terrain monitor): "BRAKE!"

Message example on the multi-information display: "BRAKE!"

Driving assist information indicator: Not illuminated

Buzzer: Short beep

- Vehicle stopped by system operation

The vehicle has been stopped by brake control operation.

Message example on the multimedia display (vehicles with panoramic view monitor* and multi-terrain monitor): "Switch to Brake"

Message example on the multi-information display: "Accelerator Pedal is Pressed Press Brake Pedal", "Press brake Pedal"

Driving assist information indicator: Illuminated

Buzzer: Sounds repeatedly

*: This may not be displayed depending on the specification of the panoramic view monitor.

System overview

If the Parking Support Brake determines that a collision with a detected object or pedestrian is possible, the engine output will be restricted to restrain any increase in the vehicle speed. (Engine output restriction control: See figure 2 below.) Additionally, if the accelerator pedal continues to be depressed, the brakes will be applied automatically to reduce the vehicle speed. (Brake control: See figure 3.)

- Figure 1: When the PKSB (Parking Support Brake) is not operating

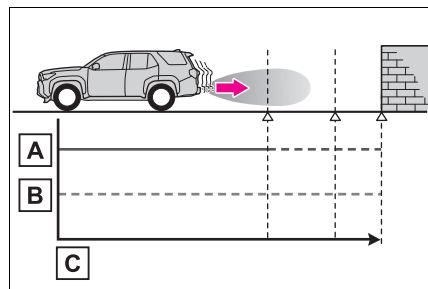

A Engine output

B Braking force

C Time

- Figure 2: When engine output restriction control operates

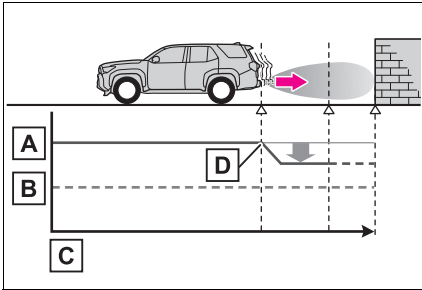

- A** Engine output
- B** Braking force
- C** Time
- D** Engine output restriction control begins operating (System determines that possibility of collision with detected object is high)

- Figure 3: When engine output restriction control and brake control operates

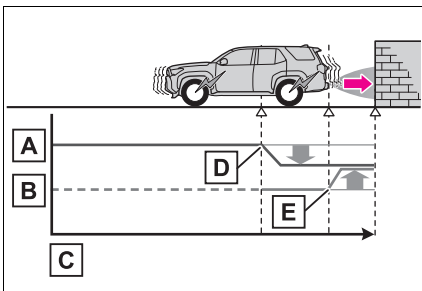

- A** Engine output
- B** Braking force
- C** Time
- D** Engine output restriction control begins operating (System

determines that possibility of collision with detected object is high)

- E** Brake control begins operating (System determines that possibility of collision with detected object is extremely high)

■ **If the Parking Support Brake has operated**

If the vehicle is stopped due to operation of the Parking Support Brake, the Parking Support Brake will be disabled and the driving assist information indicator will illuminate. In addition, even when the PKSB (Parking Support Brake) operates, the brake control is canceled after approximately 2 seconds to start off. Furthermore, the brake control also can be canceled by depressing the brake pedal. Depressing the accelerator pedal again after that allows the vehicle to start off.

■ **Re-enabling the Parking Support Brake**

To re-enable the Parking Support Brake when it is disabled due to operation of the PKSB (Parking Support Brake), either enable the system again, or turn the engine switch off and then back to ON.

Additionally, if any of the following conditions are met, the system will be re-enabled automatically and the driving assist information indicator will turn off (→P.78):

- The P shift position is selected
- Drive with no operation targets in the traveling direction of the vehicle
- Change the traveling direction of the vehicle

■ **Buzzer**

Regardless of whether the intuitive

parking assist sensor is enabled or not (→P.324), if the PKSB (Parking Support Brake) system is enabled (→P.341), the buzzer will sound to notify the driver of the approximate distance to the object when the brake control and the engine output restriction control are operated.

Parking Support Brake function (static objects front and rear of the vehicle)*

*: If equipped

If the sensors detect a static object, such as a wall, in the traveling direction of the vehicle and the system determines that a collision may occur due to the vehicle suddenly moving forward due to an accidental accelerator pedal operation, the vehicle moving the unintended direction due to the wrong shift position being selected, or while parking or traveling at low speeds, the system will operate to lessen the impact with the detected static object and reduce the resulting damage.

Examples of function operation (static objects front and rear of the vehicle)

This function will operate in situations such as the following if an object is detected in the traveling direction of the vehicle.

- When traveling at a low speed and the brake pedal is not depressed, or is depressed late

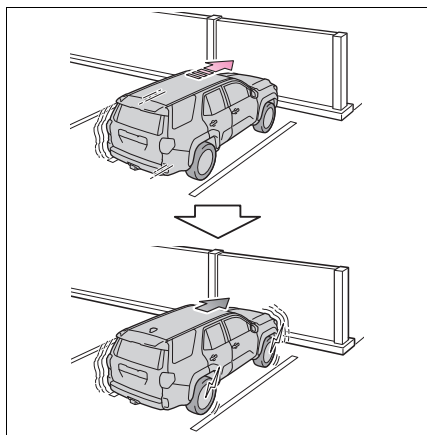

- When the accelerator pedal is depressed excessively

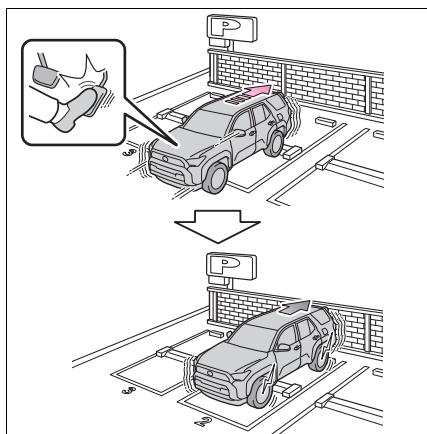

- When the vehicle moves forward due to the incorrect shift position being selected

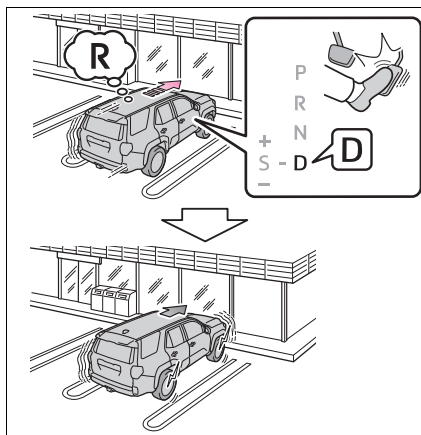

Types of sensors

→P.323

! WARNING

■ To ensure the system can operate properly

→P.324

■ If the Parking Support Brake function operates unnecessarily, such as at a railroad crossing

→P.343

■ Notes when washing the vehicle

→P.325

- The Parking Support Brake function (static objects front and rear of the vehicle) will operate when

The function will operate when the driving assist information indicator is not illuminated (→P.74) and all of the following conditions are met:

- Engine output restriction control
- The Parking Support Brake is enabled.
- The vehicle speed is approximately 9 mph (15 km/h) or less.
- There is a static object in the traveling direction of the vehicle and approximately 6 to 13 ft. (2 to 4 m) away.
- The Parking Support Brake determines that a stronger-than-normal brake operation is necessary to avoid a collision.

- Brake control
- Engine output restriction control is operating.
- The Parking Support Brake determines that an immediate brake operation is necessary to avoid a collision.

■ The Parking Support Brake function (static objects front and rear of the vehicle) will stop operating when

The function will stop operating if any of the following conditions are met:

- Engine output restriction control
- The Parking Support Brake is disabled.
- The system determines that the collision has become avoidable with normal brake operation.
- The static object is no longer approximately 6 to 13 ft. (2 to 4 m) away from the vehicle or in the traveling direction of the vehicle.
- Brake control
- The Parking Support Brake is disabled.
- Approximately 2 seconds have elapsed since the vehicle was stopped by brake control.
- The brake pedal is depressed after the vehicle is stopped by brake control.
- The static object is no longer approximately 6 to 13 ft. (2 to 4 m) away from the vehicle or in the traveling direction of the vehicle.

■ Detection range of the Parking Support Brake function (static objects front and rear of the vehicle)

The detection range of the Parking Support Brake function (static objects front and rear of the vehicle) differs from the detection range of the intuitive parking assist (→P.328). Therefore, even if the intuitive parking assist detects an object and provides a warning, the Parking Support Brake function (static objects front and rear of the vehicle) may not start operating.

■ Situations in which the system may not operate properly

→P.326

■ Situations in which the system may operate even if there is no possibility of a collision

→P.327

Parking Support Brake function (moving vehicles rear of the vehicle)*

*: If equipped

If a rear radar sensor detects a vehicle approaching from the right or left at the rear of the vehicle and the system determines that the possibility of a collision is high, this function will perform brake control to reduce the likelihood of an impact with the approaching vehicle.

Examples of the function operation

This function will operate in situations such as the following if a vehicle is detected in the traveling direction of the vehicle.

- **When reversing, a vehicle is approaching and the brake pedal is not depressed, or is depressed late**

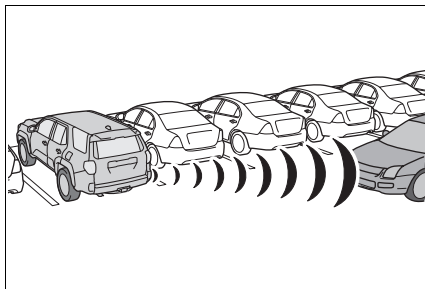

Types of sensors

→P.323

⚠ WARNING

■ **To ensure the system can operate properly**

→P.317

- **The Parking Support Brake function (moving vehicles rear of the vehicle) will operate when**

The function will operate when the driving assist information indicator is not illuminated (→P.74) and all of the following conditions are met:

- Engine output restriction control
- The Parking Support Brake is enabled.
- The vehicle speed is approximately 9 mph (15 km/h) or less.
- Vehicles are approaching from the right or left at the rear of the vehicle at a traveling speed of approximately 5 mph (8 km/h) or more.
- The shift position is in R.
- The Parking Support Brake determines that a stronger than normal brake operation is necessary to avoid a collision with an approaching vehicle.
- Brake control
- Engine output restriction control is operating.
- The Parking Support Brake determines that an emergency brake operation was necessary to avoid a collision with a vehicle approaching from the rear.

- **The Parking Support Brake function (moving vehicles rear of the vehicle) will stop operating when**

The function will stop operating if any of the following conditions are met:

- Engine output restriction control

- The Parking Support Brake is disabled.
 - The collision becomes avoidable with normal brake operation.
 - A vehicle is no longer approaching from the right or left at the rear of the vehicle.
- Brake control
- The Parking Support Brake is disabled.
 - Approximately 2 seconds have elapsed since the vehicle was stopped by brake control.
 - The brake pedal is depressed after the vehicle is stopped by brake control.

■ **Situations in which the system may not operate properly**

→P.333

■ **Situations in which the system may operate even if there is no possibility of a collision**

→P.334

Parking Support Brake function (pedestrians rear of the vehicle)*

*: If equipped

If the rear camera sensor detects a pedestrian behind the vehicle while backing up and the system determines that the possibility of colliding with the detected pedestrian is high, a buzzer will sound. If the system determines that the possibility of colliding with the detected pedestrian is extremely high, the brakes will be applied automatically to help reduce the impact of the collision.

Examples of system operation

The system operates when an approaching pedestrian is detected behind the vehicle while backing up, and when the brake pedal is not depressed or is depressed late.

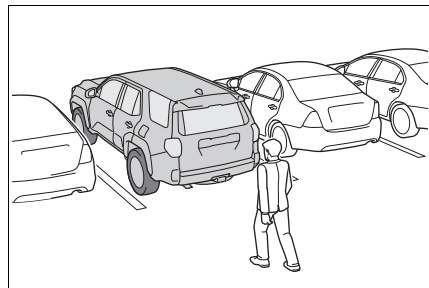

Screen display of pedestrians rear of the vehicle

Displays a message to prompt the driver to brake when a pedestrian is detected in the detection area behind the vehicle.

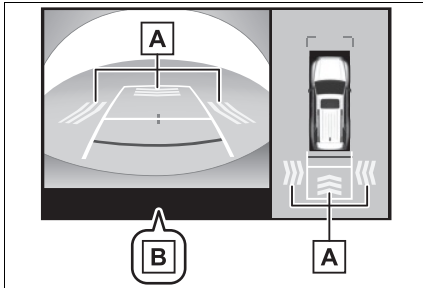

A Pedestrian detection icon

B Example: "BRAKE!"

! WARNING

■ If the Parking Support Brake function (pedestrians rear of the vehicle) operates unnecessarily

Depress the brake pedal immediately after the Parking Support Brake function (pedestrians rear of the vehicle) operates. (Operation of the function is canceled by depressing the brake pedal.)

■ Correct use of the Parking Support Brake function (pedestrians rear of the vehicle)

→P.335

■ The Parking Support Brake function (pedestrians rear of the vehicle) will operate when

The function will operate when the driving assist information indicator is not illuminated (→P.335) and all of

the following conditions are met:

- Engine output restriction control
- The Parking Support Brake is enabled.
- The vehicle speed is 9 mph (15 km/h) or less.
- The shift position is in R.
- When a pedestrian is to the rear of the vehicle
- The PKSB (Parking Support Brake) determines that a stronger-than-normal-brake operation is necessary to avoid a collision.
- Brake control
- Engine output restriction control is operating.
- The Parking Support Brake determines that an emergency brake operation is necessary to avoid a collision with a pedestrian.

■ The Parking Support Brake function (pedestrians rear of the vehicle) will stop operating when

The function will stop operating if any of the following conditions are met:

- Engine output restriction control
- The Parking Support Brake is disabled.
- The collision becomes avoidable with normal brake operation.
- The pedestrian is no longer detected behind your vehicle.
- Brake control
- The Parking Support Brake is disabled.
- Approximately 2 seconds have elapsed since the vehicle was stopped by brake control.
- The brake pedal is depressed after the vehicle is stopped by brake control.

■ Re-enabling the Parking Support Brake function (pedestrians rear of the vehicle)

→P.343

■ **Detection area of the Parking Support Brake function (pedestrians rear of the vehicle)**

The detection area of the Parking Support Brake function (pedestrians rear of the vehicle) differs from the detection area of the RCD function (→P.336). Therefore, even if the RCD function detects a pedestrian and provides an alert, the Parking Support Brake function (pedestrians rear of the vehicle) may not start operating.

■ **Situations in which the system may not operate properly**

→P.338

■ **Situations in which the system may operate unexpectedly**

→P.338

Toyota parking assist monitor*

*: If equipped

The parking assist monitor assists the driver by displaying an image of the view behind the vehicle while backing up, for example while parking.

When the display is changed to the wide rear view mode, a wider lateral view behind the vehicle will be displayed.

- The screen illustrations used in this text are intended as examples, and may differ from the image that is actually displayed on the screen.

Driving precautions

The parking assist monitor is a supplemental device intended to assist the driver when backing up. When backing up, be sure to visually check all around the vehicle both directly and using the mirrors before proceeding. If you do not, you may hit another vehicle, and could possibly cause an accident.

Pay attention to the following precautions when using the parking assist monitor.

⚠ WARNING

- Never depend on the parking assist monitor entirely when backing up. The image and the position of the guide lines displayed on the screen may differ from the actual state. Use caution, just as you would when backing up any vehicle.
- Be sure to back up slowly, depressing the brake pedal to control vehicle speed.
- If you seem likely to hit nearby vehicles, obstacles, people or mount the shoulder, depress the brake pedal to stop the vehicle.
- The instructions given are only guidelines. When and how much to turn the steering wheel will vary according to traffic conditions, road surface conditions, vehicle condition, etc., when parking. It is necessary to be fully aware of this before using the parking assist system.
- When parking, be sure to check that the parking space will accommodate your vehicle before maneuvering into it.
- Do not use the parking assist monitor in the following cases:
 - On icy or slick road surfaces, or in snow
 - When using tire chains or emergency tires
 - When the back door is not closed completely
 - On roads that are not flat or straight, such as curves or slopes
 - If the suspension has been modified or tires of a size other than specified are installed

- In low temperatures, the screen may darken or the image may become faint. The image could distort when the vehicle is moving, or you may become unable to see the image on the screen. Be sure to visually check all around the vehicle both directly and using the mirrors before proceeding.
- If the tire sizes are changed, the position of the guide lines displayed on the screen may change.
- The camera uses a special lens. The distances between objects and pedestrians that appear in the image displayed on the screen will differ from the actual distances. (→P.357)

Screen display

The parking assist monitor screen will be displayed if the shift lever is shifted to R while the engine switch is in ON.

Each time the display mode switching button is selected, the mode will change as follows:

Rear view: Displays the rear view of the vehicle.

Wide rear view: Displays a near 180° image from the rear view camera.

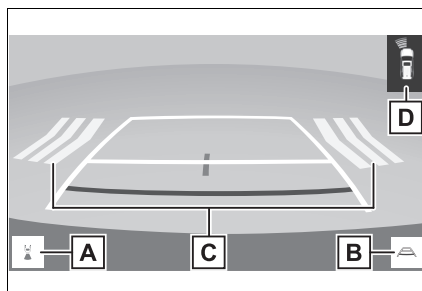

A Display mode switching button

Each time the button is selected, the rear view mode and the wide rear view mode are switched.

B Guide line switching button

Select to switch the guide line mode. (→P.352)

- Each time the button is selected, the display mode changes in the following order:

Estimated course line display mode
 → Parking assist guide line display mode
 → Distance guide line display mode
 → Center guide line display mode.

C Rear Cross Traffic Alert

When a sensor detects a vehicle approaching from the rear, the direction of the vehicle approaching from the rear is displayed and the buzzer sounds.

D Intuitive parking assist*

When a sensor detects a stationary object, the direction of and the approximate distance to the a stationary object are displayed and the buzzer sounds.

*: If equipped

- For details about the Rear Cross Traffic Alert function (→P.330) and intuitive parking assist. (→P.323)

WARNING

- As the Rear Cross Traffic Alert display is displayed over the camera view, it may be difficult to see the Rear Cross Traffic Alert display depending on the color and brightness of the surrounding area.

Canceling Toyota parking assist monitor

The parking assist monitor is canceled when the shift lever is shifted into any position other than R.

Using the system

Use any of the following modes.

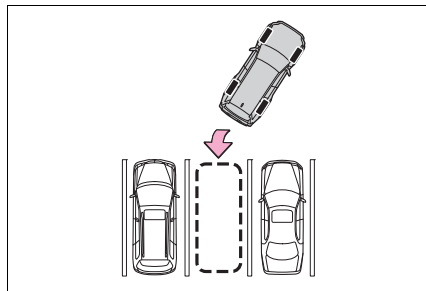

- ▶ Estimated course line display mode (→P.353)

Estimated course lines are displayed which move in accordance with the operation of the steering wheel.

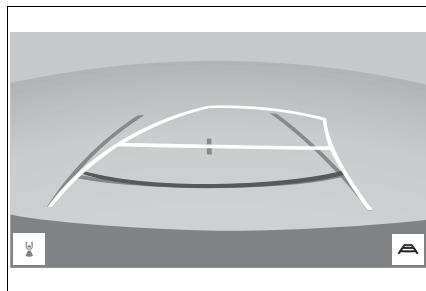

- ▶ Parking assist guide line display mode (→P.354)

The steering wheel return points (parking assist guide lines) are displayed.

This mode is recommended for those who are comfortable with parking the vehicle without the aid of the estimated course lines.

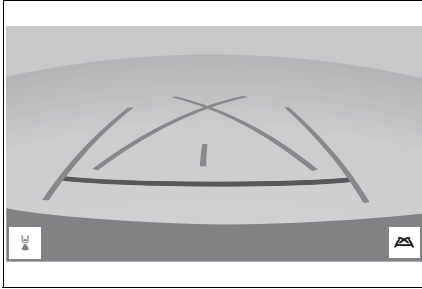

- ▶ Distance guide line display mode (→P.355)

Distance guide lines only are displayed.

This mode is recommended for those who are comfortable with parking the vehicle without the aid of the guide lines.

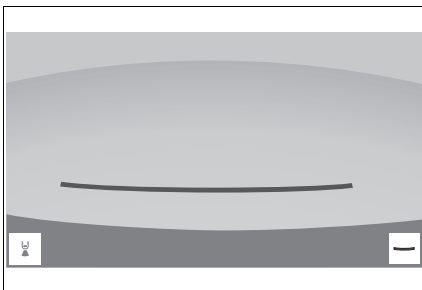

- ▶ Center guide line display mode (→P.355)

Estimated course lines and vehicle center line are displayed which move in accordance with the operation of the steering wheel.

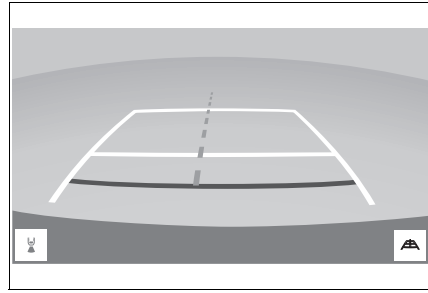

Estimated course line display mode

Screen description

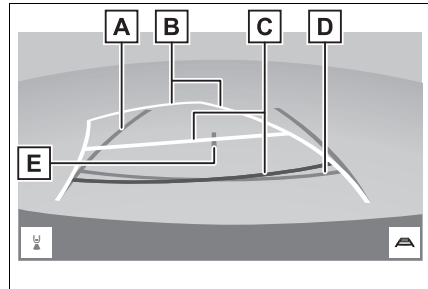

- A** Vehicle width guide line
Displays a guide path when the vehicle is being backed straight up.
- B** Estimated course lines
Show an estimated course when the steering wheel is turned.
- C** Distance guide lines
Show distance behind the vehicle when the steering wheel is turned.
 - The guide lines move in conjunction with the estimated course lines.
 - The guide lines display points approximately 1.5 ft. (0.5 m) (red) and approximately 3 ft. (1 m) (yellow) from the center of the edge of the bumper.

D Distance guide line

Shows distance behind the vehicle.

- Displays a point approximately 1.5 ft. (0.5 m) (blue) from the edge of the bumper.

E Vehicle center guide line

Indicates the estimated vehicle center on the ground.

! WARNING

- If the steering wheel is straight and the vehicle width guide lines and the estimated course lines are not in alignment, have the vehicle inspected by your Toyota dealer.

Parking assist guide line display mode

Screen description

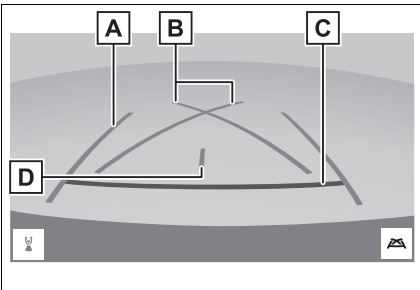

A Vehicle width guide line

Displays a guide path when the vehicle is being backed straight up.

- The displayed width is wider than the actual vehicle width.

B Parking assist guide lines

Show the path of the smallest turn possible behind the vehicle.

C Distance guide line

Shows distance behind the vehicle.

- Displays points approximately 1.5 ft. (0.5 m) (red) from the edge of the bumper.

D Vehicle center guide line

Indicates the estimated vehicle center on the ground.

Distance guide line display mode

Screen description

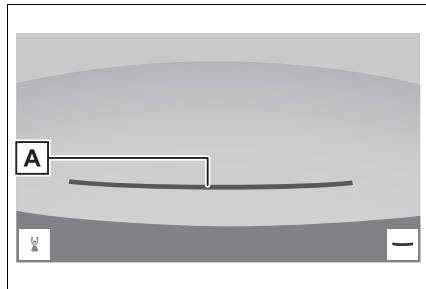

A Distance guide line

Shows distance behind the vehicle.

- Displays points approximately 1.5 ft. (0.5 m) (red) from the edge of the bumper.

Center guide line display mode

Screen description

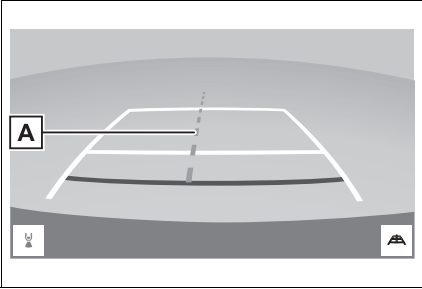

A Center guide line
Indicates the estimated vehicle center.

Toyota parking assist monitor precautions

Area displayed on screen

The parking assist monitor displays an image of the view from the bumper of the rear area of the vehicle.

► Rear view

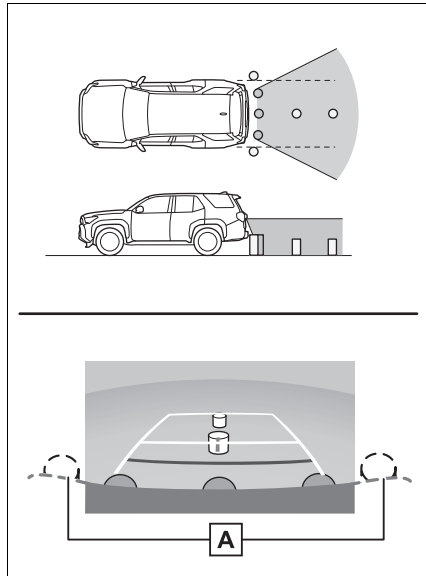

A Corners of bumper
 • The area around both corners of the bumper will not be displayed.

► Wide rear view

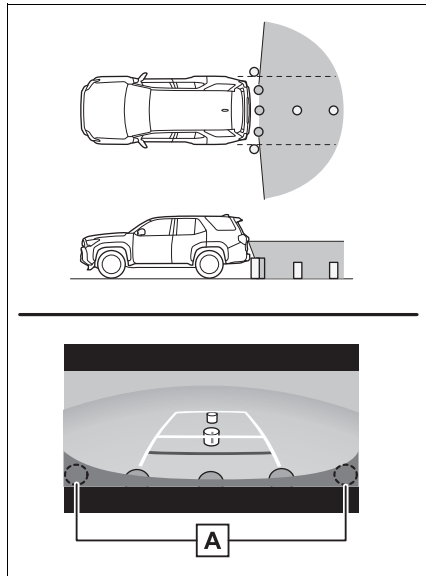

A Corners of bumper

- The area around both corners of the bumper will not be displayed.

- The image adjustment procedure for the parking assist monitor screen is the same as the procedure for adjusting the screen display. (Refer to the “MULTIMEDIA OWNER’S MANUAL”.)
- The area displayed on the screen may vary according to vehicle orientation conditions.
- Objects which are close to either corner of the bumper or under the bumper cannot be displayed.
- The camera uses a special lens. The distance of the image that appears on the screen differs from the actual distance.
- Items which are located higher than the camera may not be displayed on the monitor.

The camera

The camera for the parking assist monitor is located as shown in the illustration.

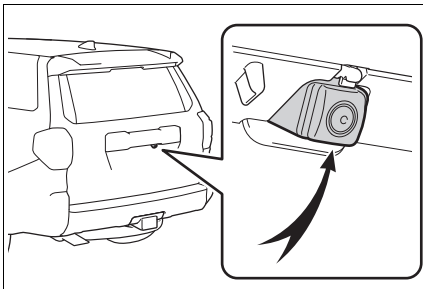

Using the camera

If dirt or foreign matter (such as water droplets, snow, mud, etc.) is adhering to the camera, it cannot transmit a clear image. In this case, flush it with a large quantity of water and wipe the

camera lens clean with a soft and wet cloth.

Dirt on the camera lens can be cleaned by operating the dedicated camera cleaning washer. (→P.243)

Cleaning the camera with washer fluid

- When cleaning the camera, it may be difficult to see the image due to the washer fluid. Therefore, take care in the surrounding area while driving.
- If washer fluid remains on the camera lens surface after cleaning, the image may be difficult to see at night due to the height or inclination of the headlights of the vehicle behind. In this case, change to optical mirror mode.
- Some dirt may not be removed completely after cleaning. In this case, rinse the camera lens with a large quantity of water and then wipe it clean with a soft cloth dampened with water.
- Washer fluid is sprayed onto the camera lens surface. Therefore, the ice, snow, etc. adhering around the camera cannot be removed.

NOTICE

- The parking assist monitor may not operate properly in the following cases.
 - If the back of the vehicle is hit, the position and mounting angle of the camera may change.
 - As the camera has a water proof construction, do not detach, disassemble or modify it. This may cause incorrect operation.

- When cleaning the camera lens, flush the camera with a large quantity of water and wipe it with a soft and wet cloth. Strongly rubbing the camera lens may cause the camera lens to be scratched and unable to transmit a clear image.
- Do not allow organic solvent, car wax, window cleaner or a glass coating to adhere to the camera. If this happens, wipe it off as soon as possible.
- If the temperature changes rapidly, such as when hot water is poured on the vehicle in cold weather, the system may not operate normally.
- When washing the vehicle, do not apply intensive bursts of water to the camera or camera area. Doing so may result in the camera malfunctioning.
- Do not expose the camera to strong impact as this could cause a malfunction. If this happens, have the vehicle inspected by your Toyota dealer as soon as possible.

Differences between the screen and the actual road

- The distance guide lines and the vehicle width guide lines may not actually be parallel with the dividing lines of the parking space, even when they appear to be so. Be sure to check visually.
- The distances between the vehicle width guide lines and the left and right dividing lines of the parking space may not

be equal, even when they appear to be so. Be sure to check visually.

- The distance guide lines give a distance guide for flat road surfaces. In any of the following situations, there is a margin of error between the guide lines on the screen and the actual distance/course on the road.

■ When the ground behind the vehicle slopes up sharply

The distance guidelines are projected on a horizontal surface, distances on an upward sloping surface appear farther from the vehicle than the actual distance. Because of this, objects will appear to be farther away than they actually are. In the same way, there will be a margin of error between the guidelines and the actual distance/course on the road.

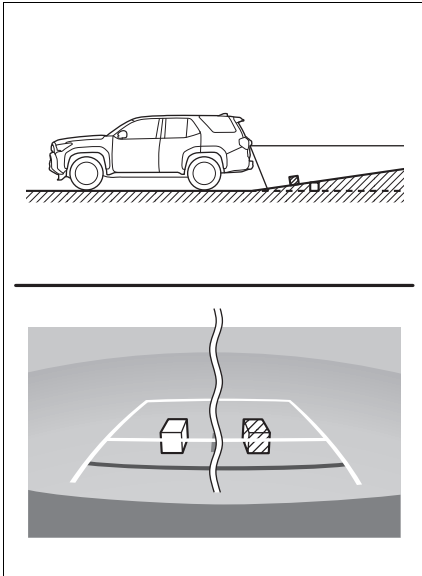

■ **When the ground behind the vehicle slopes down sharply**

The distance guidelines are projected on a horizontal surface, distances on an downward sloping surface appear closer to the vehicle than the actual distance. Because of this, objects will appear to be closer than they actually are. In the same way, there will be a margin of error between the guidelines and the actual distance/course on the road.

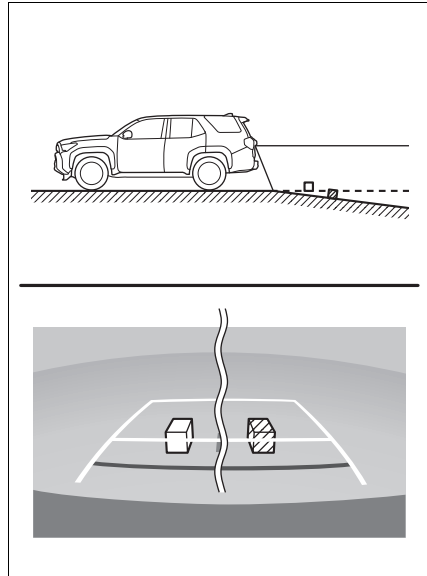

■ **When any part of the vehicle sags**

When the vehicle posture tilts due to the number of passengers or the distribution of the load, there is a margin of error between the guide lines on the screen and the actual distance/course on the road.

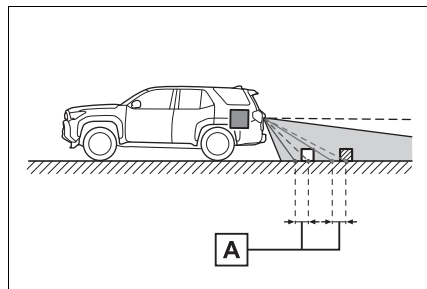

A A margin of error

When approaching three-dimensional objects

The estimated course lines target flat surfaced objects (such as the road). It is not possible to determine the position of three-dimensional objects (such as vehicles) using the estimated course lines and distance guide lines. When approaching a three-dimensional object that extends outward (such as the flatbed of a truck), be careful of the following.

Estimated course lines

Visually check the surroundings and the area behind the vehicle. In the case shown below, the truck appears to be outside of the estimated course lines and the vehicle does not look as if it hits the truck. However, the rear body of the truck may actually cross over the estimated course lines. In reality if you back up as guided by the estimated course lines, the vehicle may hit the truck.

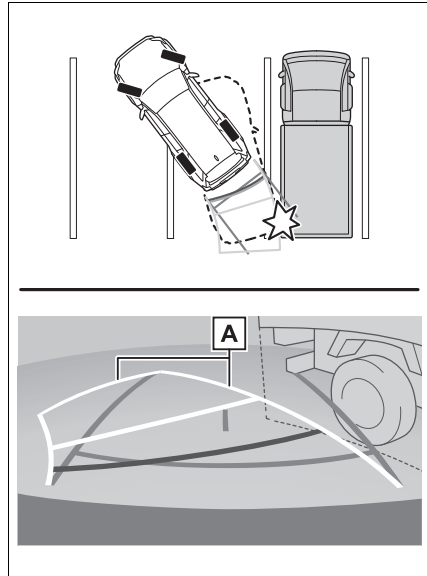

A Estimated course lines

Distance guide lines

Visually check the surroundings and the area behind the vehicle. On the screen, it appears that a truck is parking at point **B**. However, in reality if you back up to point **A**, you will hit the truck. On the screen, it appears that **A** is closest and **C** is farthest away. However, in reality, the distance to **A** and **C** is the same, and **B** is farther than **A** and **C**.

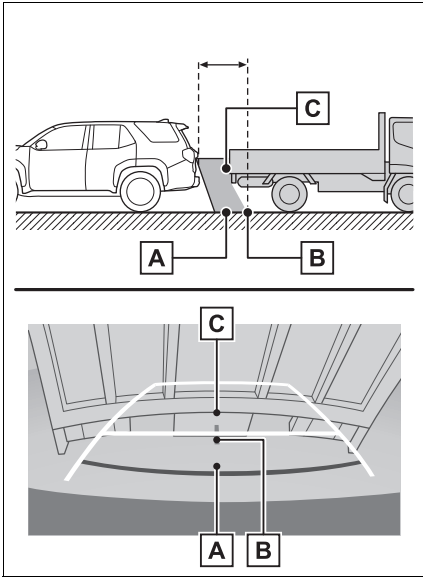

Things you should know

If you notice any symptoms

If you notice any of the following symptoms, refer to the likely cause and the solution, and re-check.

If the symptom is not resolved by the solution, have the vehicle inspected by your Toyota dealer.

Symptom	Likely cause	Solution
The image is difficult to see	<ul style="list-style-type: none"> • The vehicle is in a dark area • The temperature around the lens is either high or low • The outside temperature is low • There are water droplets on the camera • It is raining or humid • Foreign matter (mud, etc.) is adhering to the camera • Sunlight or headlights are shining directly into the camera • The vehicle is under fluorescent lights, sodium lights, mercury lights, etc. 	<p>Back up while visually checking the vehicle's surroundings. (Use the monitor again once conditions have been improved.)</p> <p>The procedure for adjusting the picture quality of the parking assist monitor is the same as the procedure for adjusting the screen display. (Refer to the "MULTIMEDIA OWNER'S MANUAL".)</p>
The image is blurry	Dirt or foreign matter (such as water droplets, snow, mud, etc.) is adhering to the camera.	<p>Flush the camera with a large quantity of water and wipe the camera lens clean with a soft and wet cloth.</p> <p>Operate the dedicated camera cleaning washer and clean the camera lens. (→P.243)</p>

Symptom	Likely cause	Solution
The image is out of alignment	The camera or surrounding area has received a strong impact.	Have the vehicle inspected by your Toyota dealer.
The guide lines are very far out of alignment	The camera position is out of alignment.	Have the vehicle inspected by your Toyota dealer.
	<ul style="list-style-type: none"> • The vehicle is tilted (there is a heavy load on the vehicle, tire pressure is low due to a tire puncture, etc.) • The vehicle is used on an incline. 	<p>If this happens due to these causes, it does not indicate a malfunction.</p> <p>Back up while visually checking the vehicle's surroundings.</p>
The estimated course lines move even though the steering wheel is straight	There is a malfunction in the signals being output by the steering sensor.	Have the vehicle inspected by your Toyota dealer.
Guide lines are not displayed	The back door is open.	<p>Close the back door.</p> <p>If this does not resolve the symptom, have the vehicle inspected by your Toyota dealer.</p>
 is displayed	<ul style="list-style-type: none"> • Battery has been reinstalled. • The steering wheel has been moved while the battery was being reinstalled. • Battery power is low. • The steering sensor has been reinstalled. • There is a malfunction in the signals being output by the steering sensor. 	<p>Stop the vehicle, and turn the steering wheel as far as it will go to the left and right.</p> <p>If this does not resolve the symptom, have the vehicle inspected by your Toyota dealer.</p>

Panoramic view monitor*

*: If equipped

Panoramic view monitor assists the driver in viewing the surroundings, when operating at low speeds, by combining the front, side and rear cameras and displaying a complete vehicle overhead image on the screen.

When you press the camera switch or shift the shift lever to R while the engine switch is in ON, the panoramic view monitor operates.

The monitor displays various views of the position and surroundings of the vehicle.

- The screen illustrations used in this text are intended as examples, and may differ from the image that is actually displayed on the screen.

Driving precautions

The panoramic view monitor is a supplemental device intended to assist the driver when checking around the vehicle. When using, be sure to visually check all around the vehicle both directly and using the mirrors before proceeding. If you do not, you may hit another vehicle or possi-

bly cause an accident.

Pay attention to the following precautions when using the panoramic view monitor.

WARNING

- Never depend on the panoramic view monitor entirely. The image and the position of the guide lines displayed on the screen may differ from the actual state. Use caution just as you would when driving any other vehicle.
- Always make sure to check all around the vehicle with your own eyes when driving.
- Never drive while looking only at the screen as the image on the screen is different from actual conditions. If you are driving while looking only at the screen, you may hit a person or an object, resulting in an accident. When driving, be sure to check the vehicle's surroundings with your own eyes and the vehicle's mirrors.
- Depending on the circumstances of the vehicle (number of passengers, amount of luggage, etc.), the position of the guide lines displayed on the screen may change. Be sure to check visually around the vehicle before proceeding.

**WARNING**

- Do not use the panoramic view monitor system in the following cases:
 - On icy or slick road surfaces, or in snow
 - When using tire chains or emergency tires
 - When the front door or the back door is not closed completely
 - On roads that are not flat or straight, such as curves or slopes
 - If the suspension has been modified or tires of a size other than specified are installed
- In low temperatures, the screen may darken or the image may become faint. The image could distort when the vehicle is moving, or you may become unable to see the image on the screen. Be sure to visually check all around the vehicle both directly and using the mirrors before proceeding.
- If the tire sizes are changed, the position of the guide lines displayed on the screen may change.
- The camera uses a special lens. The distances between objects and pedestrians that appear in the image displayed on the screen will differ from the actual distances. (→P.390)
- When an aftermarket part is installed in the display area of the screen.

**NOTICE**

- In panoramic view/moving view/see-through view, the system combines images taken from the front, back, left and right side cameras into a single image. There are limits to the range and content that can be displayed. Familiarize yourself with the characteristics of the panoramic view monitor system before using it.
- Image clarity may decline at the four corners of the panoramic view/moving view/see-through view. However, this is not a malfunction, as these are the regions along the border of each camera image where the images are combined.
- Depending on lighting conditions near each of the cameras, bright and dark patches may appear on the panoramic view/moving view/see-through view.
- The panoramic view/moving view/see-through view display does not extend higher than the installation position and image capture range of each camera.
- There are blind spots around the vehicle. Accordingly, there are regions not displayed in panoramic view.
- Three-dimensional objects displayed in wide front view, rear view or side view may not be displayed in panoramic view/moving view/see-through view.

**NOTICE**

- People and other three-dimensional obstacles may appear differently when displayed on the panoramic view monitor. (These differences include, among others, cases in which displayed objects appear to have fallen over, disappear near image processing areas, appear from image processing areas, or when the actual distance to an object differs from the displayed position.)
- When the back door, which is equipped with the back camera, or front doors, which are equipped with door mirrors that have built-in side cameras, are open, images will not be displayed properly on the panoramic view monitor.
- The vehicle icon displayed in panoramic view/moving view/see-through view is a computer generated image. Accordingly, properties such as the color, shape and size will differ from the actual vehicle. For this reason, nearby three-dimensional objects may appear to be touching the vehicle, and actual distances to three-dimensional objects may differ from those displayed.

Camera switch

The camera switch is located as shown in the illustration.

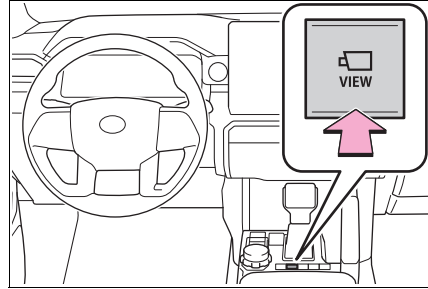

Menu button

The screens which are displayed from the following buttons can be selected. Also, the display can be changed to various screens from button combinations.

The button display changes due to the situation of the vehicle, such as the screen and speed being displayed, shift position, vehicle equipment, etc.

The menu button is displayed when the shift lever is in D, N or R.

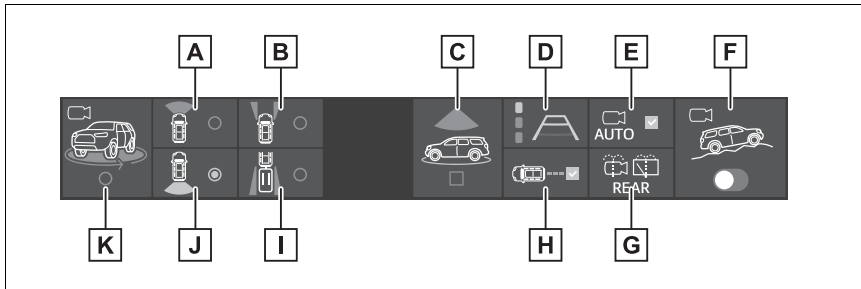

- A** Front view button
- B** Front split view button
- C** Panoramic view on/off button
- D** Guide line select button (→P.372, 377)
- E** Auto mode on/off button (→P.374)
- F** Multi-terrain Monitor on/off button* (→P.399)
- G** Rear camera washer switch
- H** Center guide line on/off button (→P.377)
- I** Rear split view button
- J** Rear view button
- K** 3D view button

*: If equipped

Display

Checking around the vehicle

When the shift lever is in P.

► Moving view

Press .

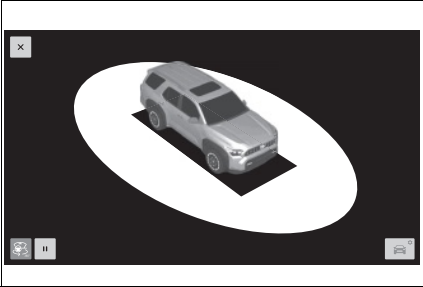

► See-through view

Press .

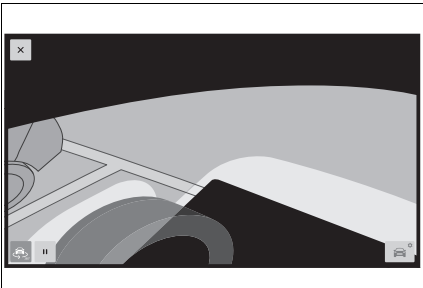

► 3D view

Press .

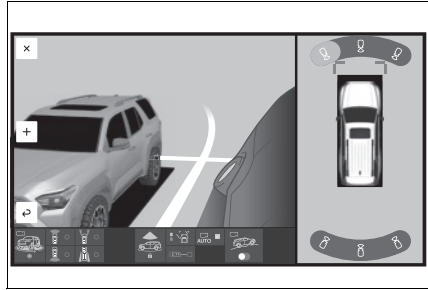

Checking the front and around the vehicle

When the shift lever is in a position other than P.

► Panoramic view & front view

Select the front view button and then turn ON the panoramic view button.

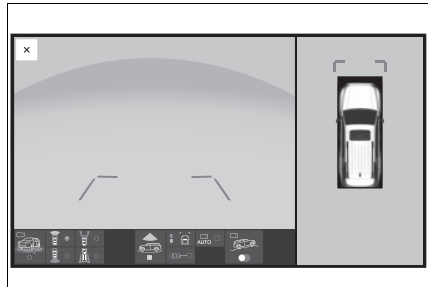

► Wide front view

Select the front view button and then turn OFF the panoramic view button.

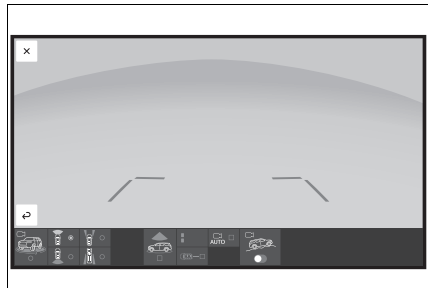

▶ Front split view

Select the front split view button.

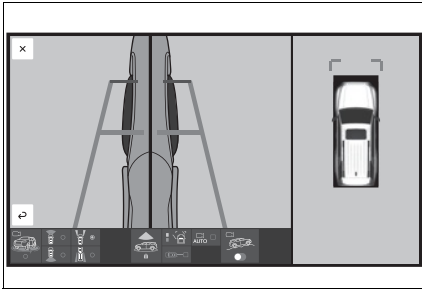

Checking the rear and around the vehicle

When the shift lever is in a position other than P.

▶ Panoramic view & rear view

Select the rear view button and then turn ON the panoramic view button.

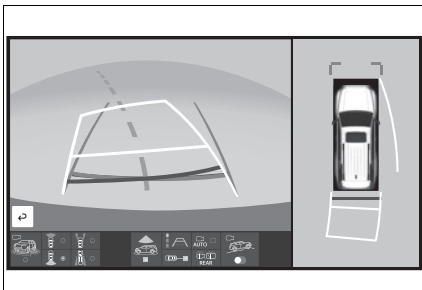

▶ Wide rear view

Select the rear view button and then turn OFF the panoramic view button.

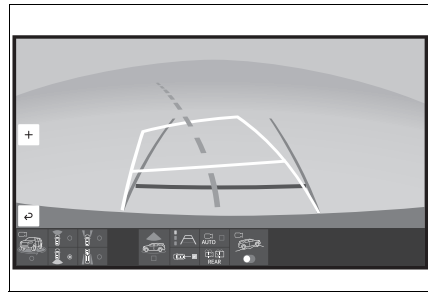

▶ Rear split view

Select the rear split view button.

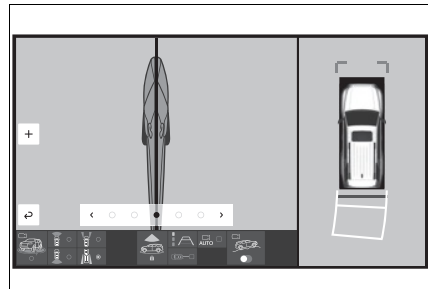

Checking around the vehicle

The moving view screen and the see-through view screen provide support when checking the areas of around the vehicle while parking. These screens display an image of the vicinity of the vehicle combined from the 4 cameras. The screen will display a 360° view around the vehicle from either inside the vehicle or from a birds-eye view at an angle.

To display the moving view/see-through view screen, press  when the shift lever is in P and the intuitive parking assist is

enabled.

Screen display

▶ Moving view

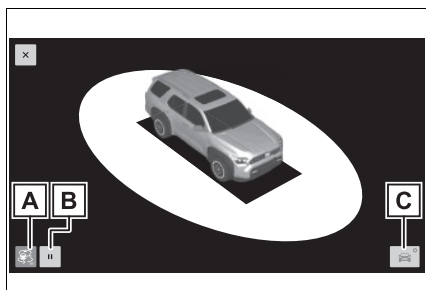

▶ See-through view

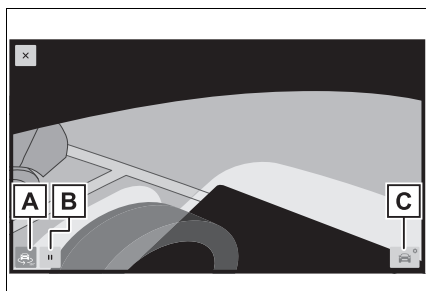

A Display mode switching button

Select to change the display mode between the moving view and the see-through view.

B Rotation pause switch

Select to pause the rotation of the screen.

To resume rotation, select .

C Body color setting switch

Select to display the body color setting screen and change the color of the vehicle displayed on the panoramic view monitor. (→P.383)

▶ 3D view

The 3D view provides support when checking the areas in around the vehicle perimeter in confined areas.

The display position of the 3D view can be changed by pressing the six different camera angle switches.

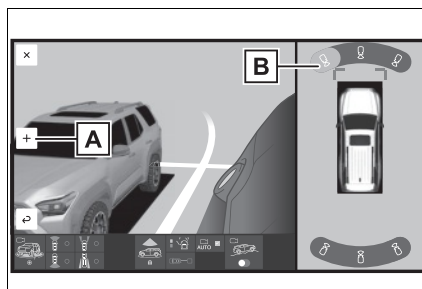

To display the 3D view, select the 3D view button (→P.366) after pressing  except in the P range.



A Zoom button

B Camera angle SW

The display position of the 3D view can be changed

- Pressing  on the screen or  again changes the screen back to the previously displayed screen, such as the navigation screen.

Checking the front and around the vehicle

The panoramic view & front view/wide front view/front split view screen provides support when checking the areas in front of the vehicle and around the vehicle when taking-off at T-intersections or other intersections during poor visibility.

To display the screen, press  when the shift lever is in D or N with the vehicle moving approximately 10 mph (16 km/h) or less.

This screen will be displayed if the intuitive parking assist detects an object in front of your vehicle (intuitive parking assist linked display).

Screen display

Each time the display mode switching button is selected, the mode will change as follows:

► Panoramic view & front view

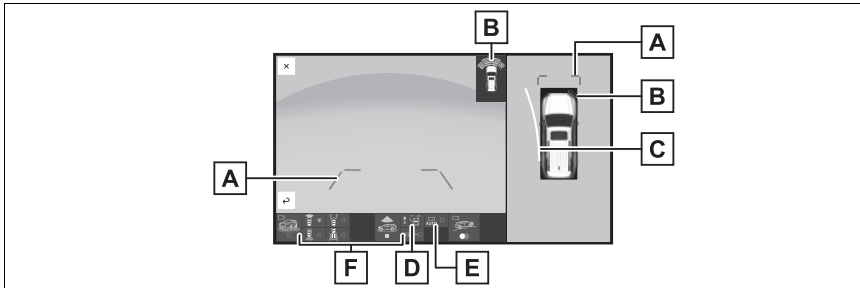

A Distance guide lines

Shows distance in front of the vehicle.

- Display points approximately 3 ft. (1 m) from the edge of the bumper.

B Intuitive parking assist

When a sensor detects an obstacle, the direction of and the approximate distance to the obstacle are displayed and the buzzer sounds.

C Estimated course lines

Shows an estimated course when the steering wheel is turned.

- This line will be displayed when the steering wheel is turned by 90° or more from the center (straight-line) position.

D Guide line switching button

Select to change the guide line mode between the distance guide line mode and the estimated course line mode. (→P.372)

E Automatic display button

Select to turn automatic display mode on/off. (→P.374)

F Display mode switching buttons

The display can be changed to various screens from button combinations.

▶ Wide front view

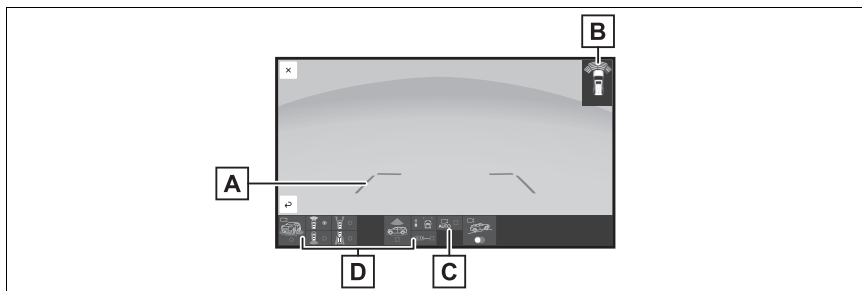

A Distance guide lines

Shows distance in front of the vehicle.

- Display points approximately 3 ft. (1 m) from the edge of the bumper.

B Intuitive parking assist

When a sensor detects an obstacle, the direction of and the approximate distance to the obstacle are displayed and the buzzer sounds.

C Automatic display button

Select to turn automatic display mode on/off. (→P.374)

D Display mode switching buttons

The display can be changed to various screens from button combinations.

▶ Front split view

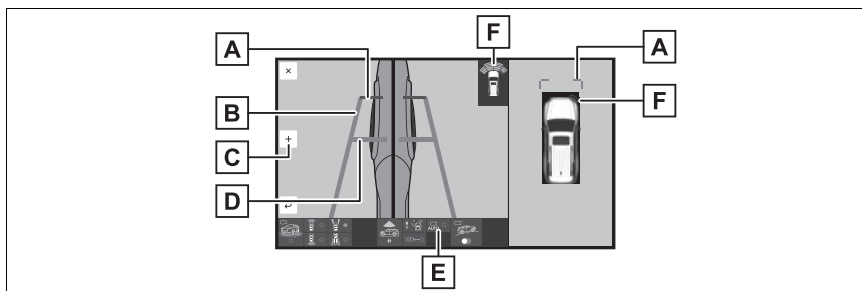

A Distance guide lines

Shows distance in front of the vehicle.

- Split view: Display points approximately 1.5 ft. (0.5 m) from the edge of

the bumper.

- Panoramic view: Display points approximately 3 ft. (1 m) from the edge of the bumper.

B Vehicle width guide lines

Shows guide lines of the vehicle's width including the outside rear view mirrors.

C Zoom button

The front split view, which is currently displayed, can be magnified.

D Front tire guide lines



Shows guide lines of where the front tire touches the ground.

E Automatic display button

Select to turn automatic display mode on/off. (→P.374)

F Intuitive parking assist

When a sensor detects an obstacle, the direction of and the approximate distance to the obstacle are displayed and the buzzer sounds.

-
- Pressing  on the screen or  changes the screen to the previously displayed screen, such as the navigation screen.
 - For details about the intuitive parking assist (→P.323).
 - The display position of the intuitive parking assist and the position of obstacles displayed in the camera image do not match.

 **WARNING**

- When a sensor indicator on the intuitive parking assist display illuminates in red or a buzzer sounds continuously, be sure to check the area around the vehicle immediately and do not proceed any further until safety has been ensured, otherwise an unexpected accident may occur.
- As the intuitive parking assist display is displayed over the camera view, it may be difficult to see the intuitive parking assist display depending on the color and brightness of the surrounding area.

Switching the guide line mode (panoramic view & front view mode)

Each time the guide line switching button is selected, the mode will change as follows:

▶ Distance guide line

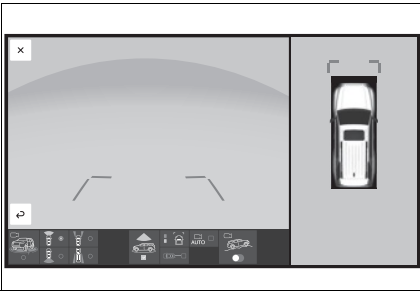

- Only the distance guide lines are displayed.
- ▶ Estimated course line

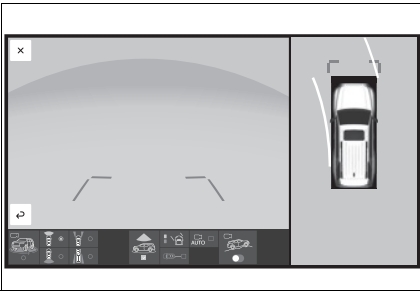

- Estimated course lines will be added to the distance guide lines.

Using the vehicle width guide line (front split view mode)

The front split view screen displays images from the cameras installed on each outside rear view mirror. This screen is designed to support the driver in safe driving in situations such as when driving on a narrow road, by allowing them to check the areas around the sides of the vehicle.

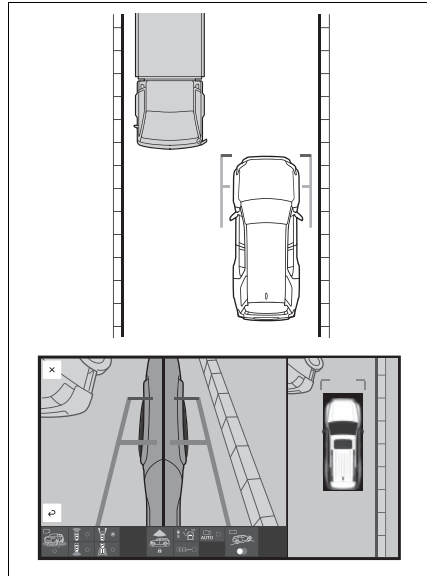

- Check the positions and distance between the vehicle width guide line and a target object such as the obstacle or curb of the road.

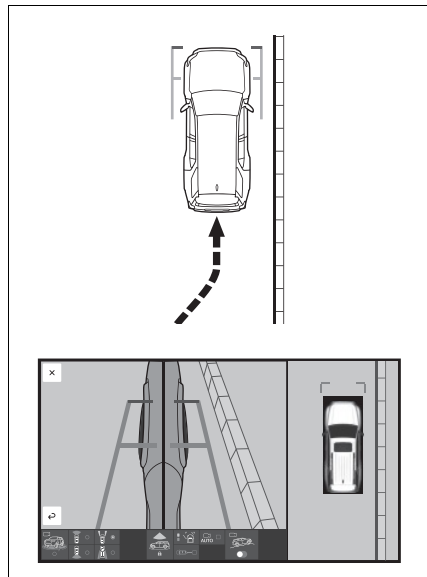

- Pull over to the curb as shown in the illustration above, taking care not to let the vehicle width guide line overlap the target object.
- Ensure that the vehicle width guide line is parallel to the target object.

Automatic display mode

In addition to screen switching by operating , automatic display mode is available. In this mode, the screen is switched

automatically in response to vehicle speed.

Each time  is selected, automatic display mode is enabled/disabled.

In automatic display mode, the monitor will automatically display images in the following situations:

- When the shift lever is shifted to D or N.
- When vehicle speed is reduced to approximately 10 mph (16 km/h) or less.

Checking the rear and around the vehicle

The panoramic view & rear view/wide rear view/rear split view screen provide support when checking the areas of behind the vehicle and around the vehicle while backing up, for example while parking.

The screens will be displayed when the shift lever is in R.

Screen display

Each time the display mode switching button is selected, the mode will change as follows:

- ▶ Panoramic view & rear view

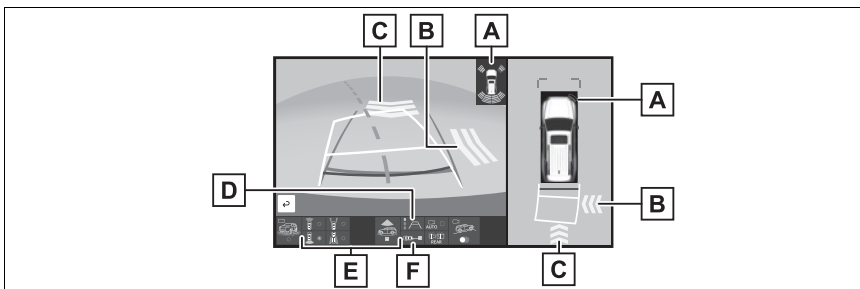

- A** Intuitive parking assist

When a sensor detects an obstacle, the direction of and the approximate distance to the obstacle are displayed and the buzzer sounds.

B Rear Cross Traffic Alert/Rear Camera Detection

When a sensor detects an obstacle or pedestrian, the direction of obstacle or pedestrian is displayed and the buzzer sounds.

C RCD (Rear Camera Detection)

When the rear camera detects a pedestrian to the rear.

D Guide line switching button

Select to switch the guide line mode. (→P.377)

E Display mode switching buttons

The display can be changed to various screens from button combinations.

F Center guide line on/off button

Select to on/off the center guide line. (→P.377)

► Wide rear view

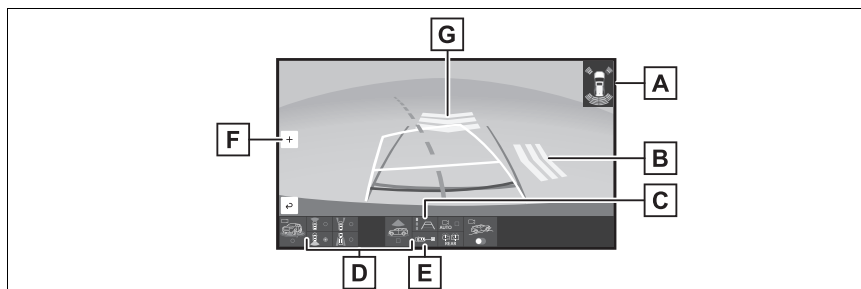

A Intuitive parking assist

When a sensor detects an obstacle, the direction of and the approximate distance to the obstacle are displayed and the buzzer sounds.

B Rear Cross Traffic Alert/Rear Camera Detection

When a sensor detects an obstacle or pedestrian, the direction of obstacle or pedestrian is displayed and the buzzer sounds.

C Guide line switching button

Select to switch the guide line mode. (→P.377)

D Display mode switching buttons

The display can be changed to various screens from button combinations.

E Center guide line on/off button

Select to on/off the center guide line. (→P.377)

F Zoom button

Each time press the button, the mode will change between the wide rear view mode, narrow rear view mode and hitch view mode. (→P.380)

G RCD (Rear Camera Detection)

When the rear camera detects a pedestrian to the rear.

▶ Rear split view

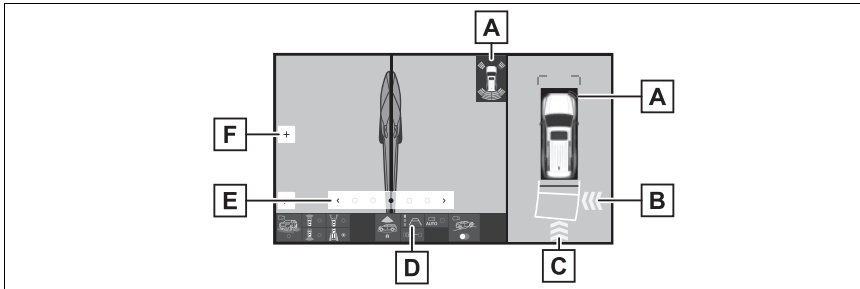

A Intuitive parking assist

When a sensor detects an obstacle, the direction of and the approximate distance to the obstacle are displayed and the buzzer sounds.

B Rear Cross Traffic Alert/Rear Camera Detection

When a sensor detects an obstacle or pedestrian, the direction of obstacle or pedestrian is displayed and the buzzer sounds.

C RCD (Rear Camera Detection)

When the rear camera detects a pedestrian to the rear.

D Guide line switching button

Select to switch the guide line mode. (→P.377)

E Camera angle adjustment (→P.380)

F Zoom button (→P.380)

- The monitor is canceled when the shift lever is shifted into any position other than R.
- For details about the intuitive parking assist (→P.323), Rear Cross Traffic Alert function (→P.330) and rear camera detection. (→P.335)
- The display position of the intuitive parking assist and the position of obstacles displayed in the camera image do not match.

⚠ WARNING

- When a sensor indicator on the intuitive parking assist display illuminates in red or a buzzer sounds continuously, be sure to check the area around the vehicle immediately and do not proceed any further until safety has been ensured, otherwise an unexpected accident may occur.
- As the intuitive parking assist display and Rear Cross Traffic Alert display are displayed over the camera view, it may be difficult to see the intuitive parking assist display and Rear Cross Traffic Alert display depending on the color and brightness of the surrounding area.

Guide lines displayed on the screen

Each time the guide line switching button is selected, the mode will change as follows:

▶ Estimated course line

Estimated course lines are displayed which move in accordance with the operation of the steering wheel.

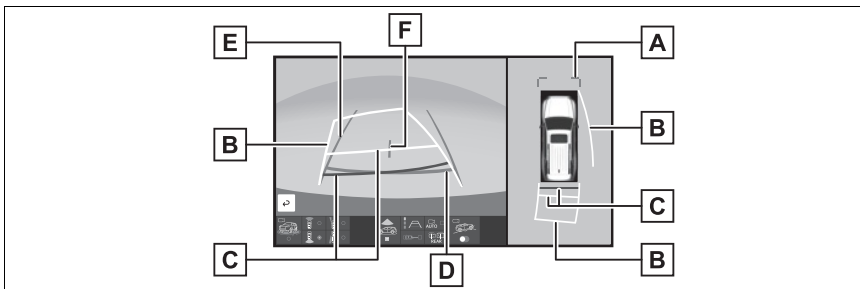
**A** Distance guide lines

Shows distance in front of the vehicle.

- Display points approximately 3 ft. (1 m) from the edge of the bumper.

B Estimated course lines

Shows an estimated course when the steering wheel is turned.

C Distance guide lines

Shows the distance behind the vehicle when the steering wheel is turned.

- The guide lines move in conjunction with the estimated course lines.
- The guide lines display points approximately 1.5 ft. (0.5 m) (red) and approximately 3 ft. (1 m) (yellow) from the center of the edge of the bumper.

D Distance guide line

Shows the distance behind the vehicle.

- Displays a point approximately 1.5 ft. (0.5 m) (blue) from the edge of the bumper.

E Vehicle width guide lines

Displays a guide path when the vehicle is being backed straight up.

F Vehicle center guide line

Indicates the estimated vehicle center on the ground.

► Parking assist guide line

The steering wheel return points (parking assist guide lines) are displayed.

This mode is recommended for those who are comfortable with parking the vehicle without the aid of the estimated course lines.

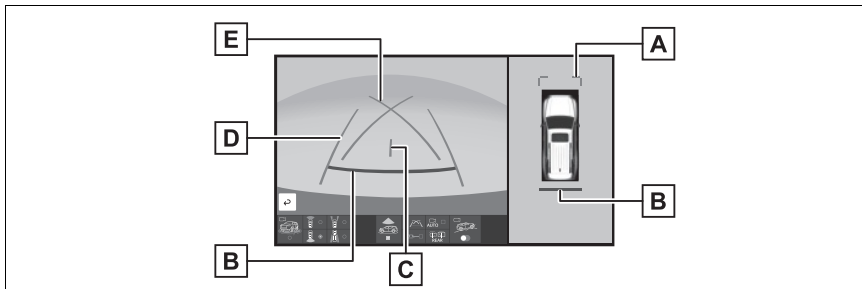

A Distance guide lines

Shows distance in front of the vehicle.

- Display points approximately 3 ft. (1 m) from the edge of the bumper.

B Distance guide line

Shows the distance behind the vehicle.

- Displays a point approximately 1.5 ft. (0.5 m) (red) from the edge of the bumper.

C Vehicle center guide line

Indicates the estimated vehicle center on the ground.

D Vehicle width guide lines

Displays a guide path when the vehicle is being backed straight up.

E Parking assist guide lines

Shows the path of the smallest turn possible behind the vehicle.

► Distance guide line

Only distance guide line is displayed.

This mode is recommended for those who are comfortable with park-

ing the vehicle without the aid of the guide lines.

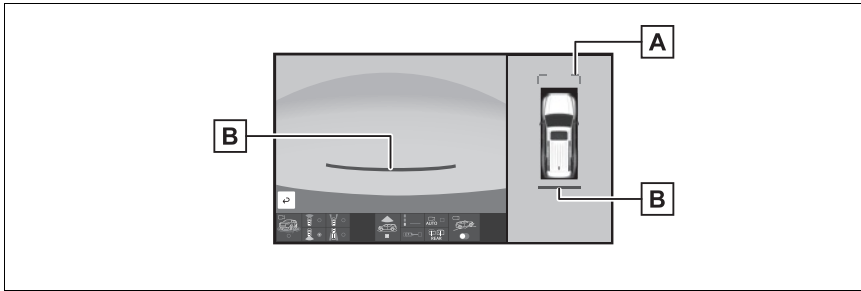

A Distance guide lines

Shows distance in front of the vehicle.

- Display points approximately 3 ft. (1 m) from the edge of the bumper.

B Distance guide line

Shows the distance behind the vehicle.

- Displays a point approximately 1.5 ft. (0.5 m) (red) from the edge of the bumper.

► Center guide line

When the display is turned ON, the center guide line simultaneously displays the each of the guide lines for the estimated course line, parking assist guide line or distance guide line.

Vehicle center line is displayed which move in accordance with the operation of the steering wheel.

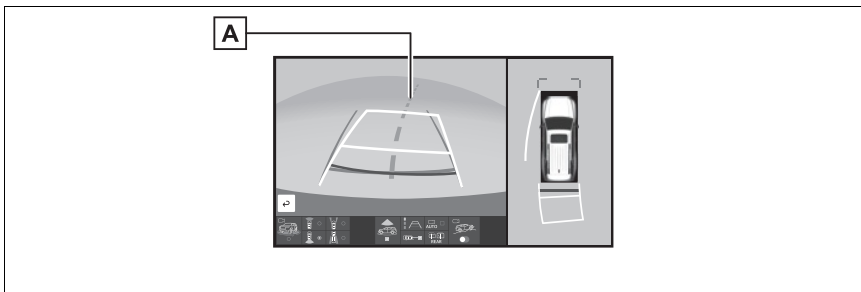

A Vehicle center guide line

Indicates the estimated vehicle center on the ground.

- The display position of the intuitive parking assist and the position of obstacles displayed in the camera image do not match.

WARNING

- Depending on the circumstances of the vehicle (number of passengers, amount of luggage, etc.), the position of the guide lines displayed on the screen may change. Be sure to check visually around the vehicle before proceeding.
- If the steering wheel is straight and the vehicle width guide lines and the estimated course lines are not in alignment, have the vehicle inspected by your Toyota dealer.
- Do not use the system if the display is incorrect due to an uneven (hilly) road or a non-straight (curvy) road.

Changing the rear view mode

Each time press the zoom button, the mode will change as follows:

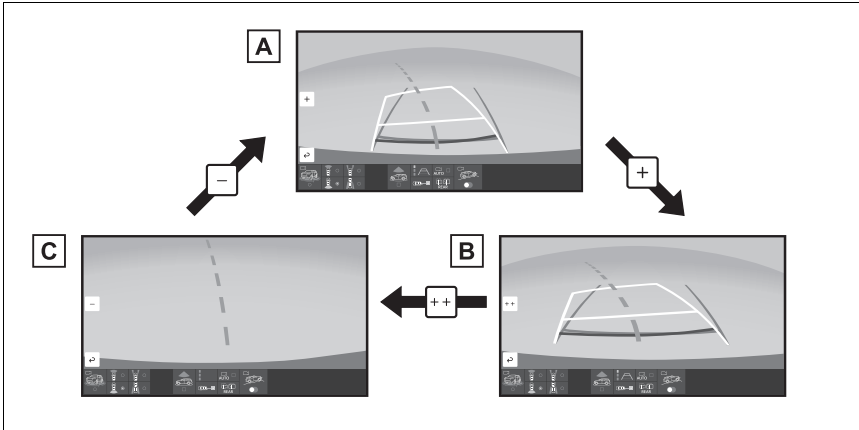

A Wide rear view

B Narrow rear view

C Hitch zoom view

- The hitch zoom view can be displayed for a certain time when  is pressed while the driving at speeds of 10 mph (16 km/h) or more.
- The hitch zoom view can be switched when the switch is pressed while the displaying the screen.

Using the rear split view

If towing a trailer, magnify the difficult to see section of the vehicle rear or change the screen display and use when checking.

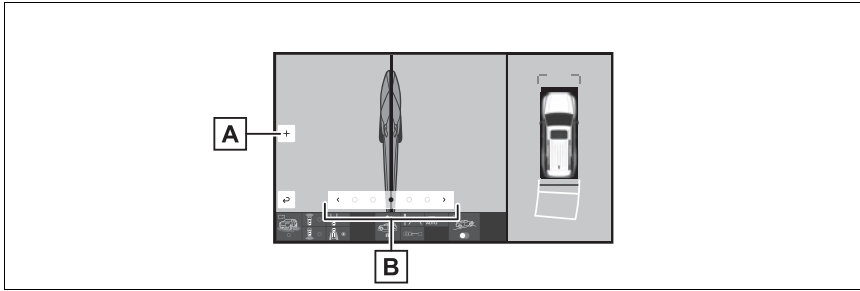

A Zoom button

The rear split view, which is currently displayed, can be magnified.

B Camera angle adjustment button

The direction of the camera can be changed from left to right in 5 stages.

Parking

Using the estimated course line

When parking in a space which is in the reverse direction to the space described in the procedure below, the steering directions will be reversed.

- 1 Shift the shift lever to R.
- 2 Turn the steering wheel so that the estimated course

lines are within the parking space, and back up slowly.

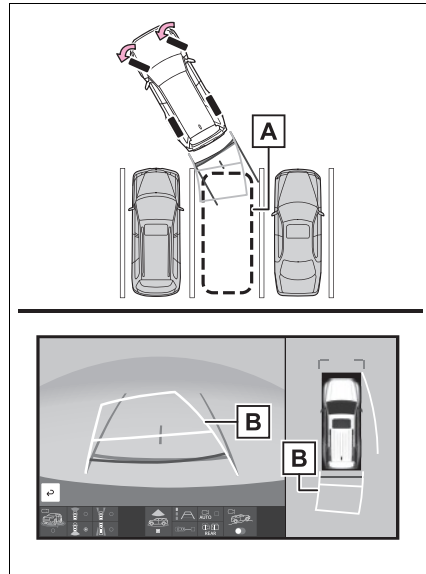

A Parking space

B Estimated course lines

- 3 When the rear position of the vehicle has entered the parking space, turn the steering wheel so that the vehicle

width guide lines are within the left and right dividing lines of the parking space.

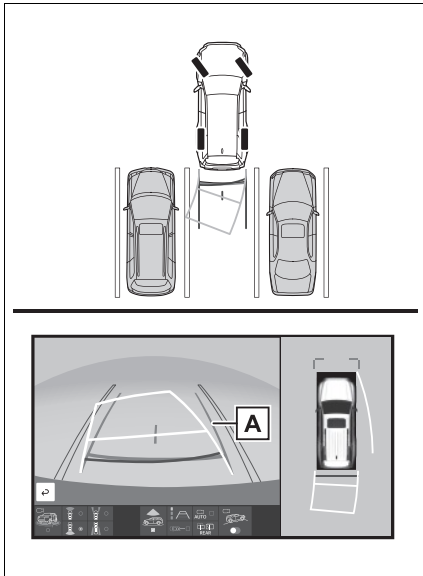

A Vehicle width guide line

- 4 Once the vehicle width guide lines and the parking space lines are parallel, straighten the steering wheel and back up slowly until the vehicle has completely entered the parking space.
- 5 Stop the vehicle in an appropriate place, and finish parking.

Using parking assist guide line

When parking in a space which is in the reverse direction to the space described in the procedure below, the steering directions will be reversed.

- 1 Shift the shift lever to R.
- 2 Back up until the parking assist guide line meets the edge of the dividing line of the parking space.

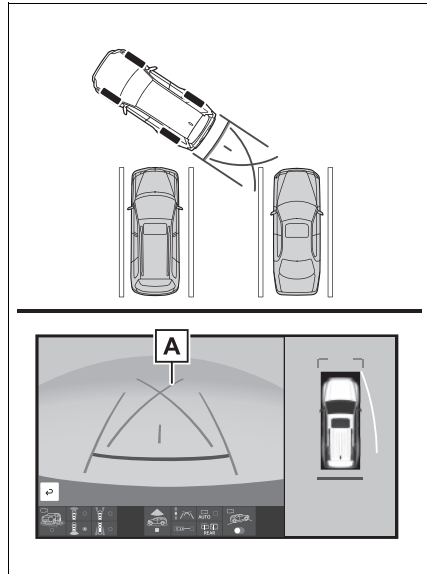

A Parking assist guide line

- 3 Turn the steering wheel all the way to the left, and back up slowly.
- 4 Once the vehicle is parallel with the parking space, straighten the steering wheel and back up slowly until the vehicle has completely entered the parking space.
- 5 Stop the vehicle in an appropriate place, and finish parking.

Magnifying function

If displayed objects are too small to see clearly when the panoramic view is displayed, the area around any of the 4 corners of the vehicle can be magnified.

Magnifying the display

- 1 Turn the intuitive parking assist on.
- 2 Select the area on the panoramic view display you wish to magnify.

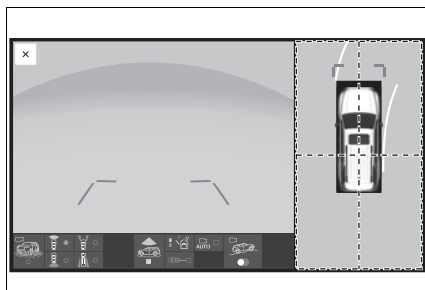

- Touching one of the 4 areas within the dotted lines will magnify that area. (Dotted lines are not displayed on the actual display.)
 - To return to the normal view, touch the panoramic view display again.
-
- The magnifying function is enabled when all of the following conditions are met:
 - The panoramic view & front view or the panoramic view & rear view is displayed.
 - The vehicle speed is below approximately 10 mph (16 km/h).

- The intuitive parking assist is available.
- In the following situations, the magnified display will be canceled automatically:
 - The vehicle speed is approximately 10 mph (16 km/h) or higher.
 - The intuitive parking assist is unavailable.
- When the display is magnified, the guide lines will not be displayed.

Customizing the panoramic view monitor

The color of the vehicle displayed on the panoramic view monitor can be changed.

Changing the body color displayed in the panoramic view monitor

- 1 Display the moving view/see-through view/3D view screen. (→P.368)
- 2 Select .
- 3 Select the desired color.

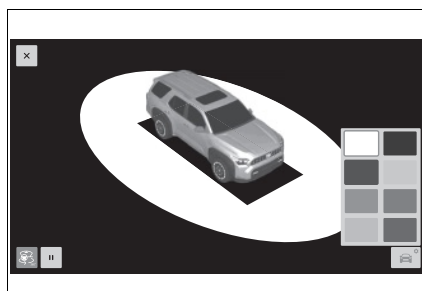

Panoramic view monitor precautions

Area displayed on screen

Area of image of panoramic view

The panoramic view monitor displays an image of the surrounding view of the vehicle.

Since the panoramic view processes and displays images based on flat road surfaces, it cannot depict the position of three-dimension objects (such as vehicle bumpers, etc.) that are in positions higher than the surface of the road. Even if there is room between the bumpers of the vehicles and it seems not likely to collide in the image, in reality, the both vehicles are on a collision course.

Check the safety of the surroundings directly.

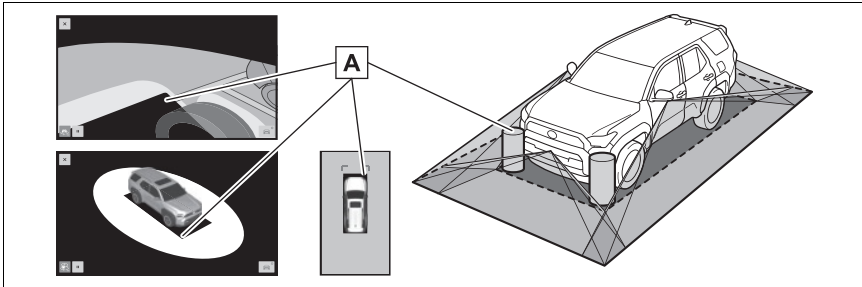

A Objects located in the shaded areas will not be displayed on the screen.

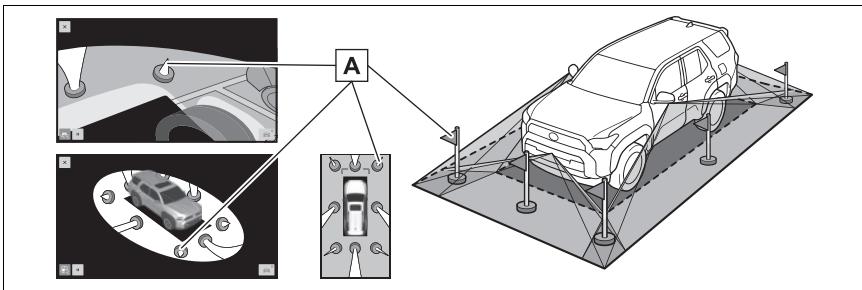

A Parts of objects which extend above a certain height cannot be displayed on the screen.

● As the images obtained from four cameras are processed and displayed

- on the standard of a flat road surface; the panoramic view/moving view/see through view may be displayed as follows.
- Objects may look collapsed; thinner or bigger than usual.
 - An object with a higher position than the road surface may look farther away than it actually is or may not appear at all.
 - Tall objects may appear protruding from the non-displayed areas of the image.
 - Variations in the brightness of the image may appear for every camera.
 - The displayed image may be shifted by inclination of the vehicle body, change in vehicle height, etc., depending on the number of passengers, amount of luggage, fuel quantity, etc.
 - If the front doors or back door are not completely closed; neither the image nor the guide lines are displayed.
 - The position relations of the vehicle icon and the road surface or obstacle may differ from the actual positions.
 - The black areas of the vicinity of the vehicle icon are areas that are not captured by the camera.
 - Images like the following are combined, thus some areas may be difficult to view.

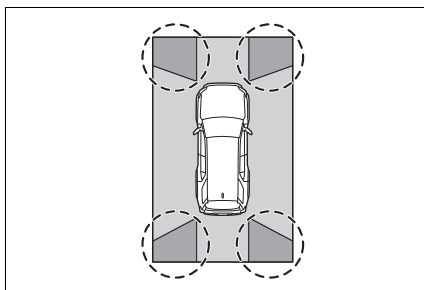
**⚠ WARNING**

When a sensor indicator on the intuitive parking assist display illuminates in red or a buzzer sounds continuously, be sure to check the area around the vehicle immediately and do not proceed any further until safety has been ensured, otherwise an unexpected accident may occur.

Area of the image captured by the camera

▶ Panoramic view & front view

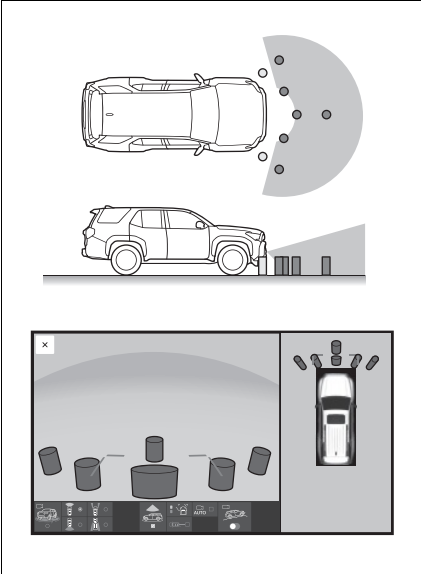

▶ Front split view

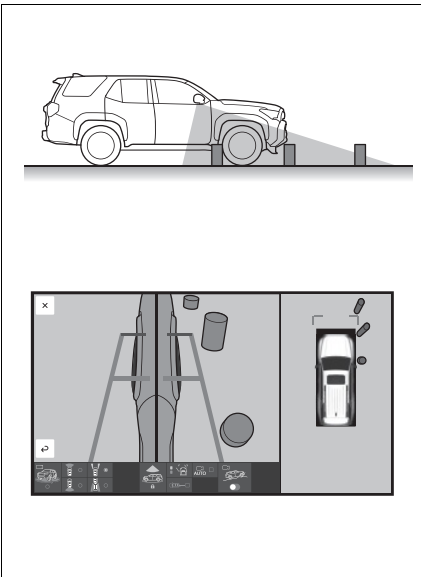

▶ Panoramic view & rear view

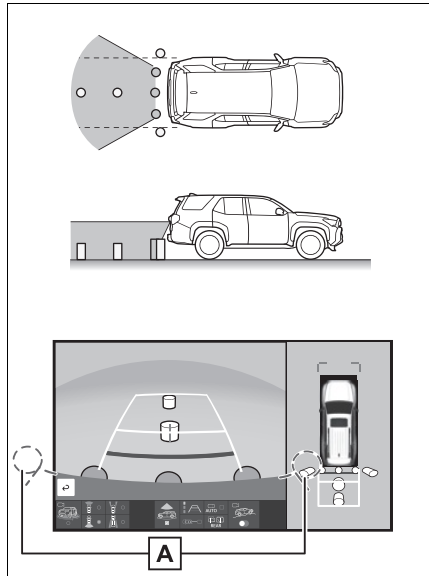

A The area around both corners of the bumper will not be displayed.

▶ Wide rear view

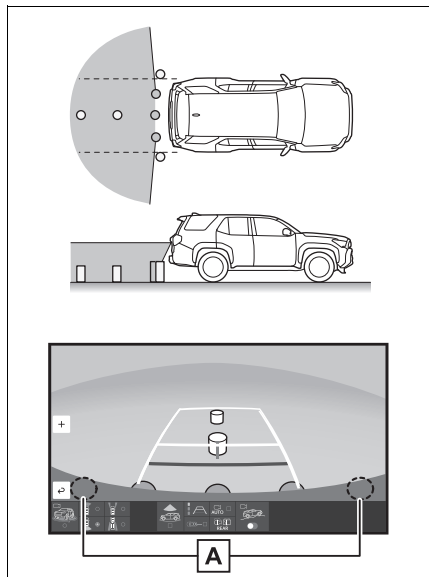

A The area around both cor-

ners of the bumper will not be displayed.

► Rear split view

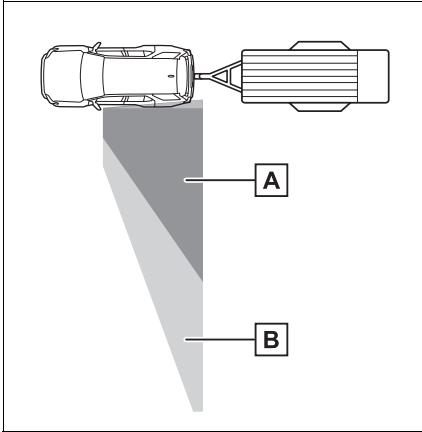

The area able to be seen changes depending on the camera angle adjustments.

- A** When the camera angle is in the middle (Left: 50%/Right: 50%)
- B** When the camera angle is at the MAX on the left side (Left: 100%)

► Hitch zoom view

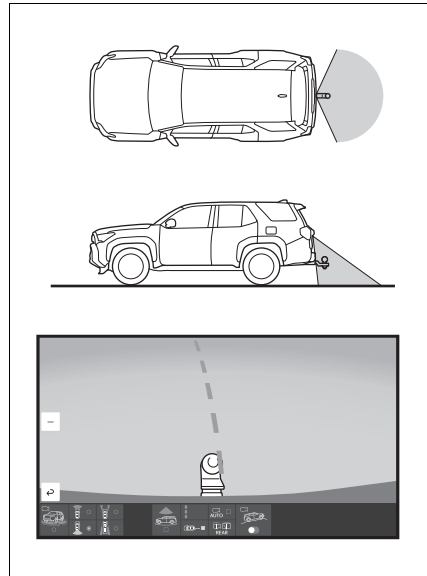

- The area covered by the camera is limited. Objects which are close to either corner of the bumper or under the bumper cannot be seen on the screen.
- The area displayed on the screen may vary depending on vehicle orientation or road conditions.
- The camera uses a special lens. The distance in the image displayed on the screen will differ from the actual distance.
- In the rear split view, there is a blind spot due to the size (length and height) of the trailer.
- In the hitch zoom view, if a backlit license plate is equipped it may be reflected in the screen.

The camera

The cameras for the panoramic view monitor are located as shown in the illustrations.

▶ Front camera

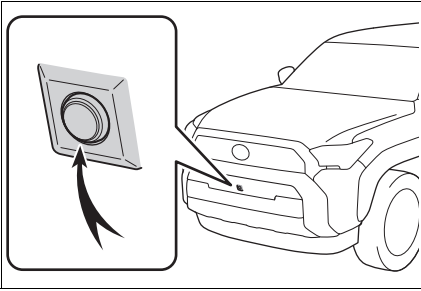

▶ Side cameras

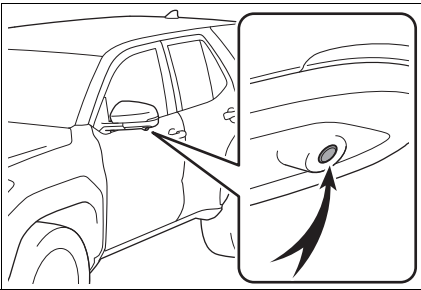

▶ Rear camera

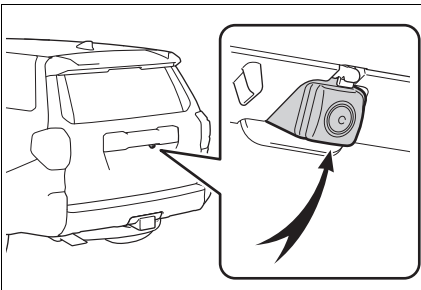
**Using the camera**

If dirt or foreign matter (such as water droplets, snow, mud, etc.) is adhering to the camera, it cannot transmit a clear image. In this case, flush it with a large quantity of water and wipe the camera lens clean with a soft and wet cloth.

Rear camera: Dirt on the camera lens can be cleaned by operating the dedicated camera cleaning washer. (→P.243)

 NOTICE

- The panoramic view monitor may not operate properly in the following cases.
 - If the camera is hit, the position and mounting angle of the camera may change.
 - As the camera has a water proof construction, do not detach, disassemble or modify it. This may cause incorrect operation.
 - When cleaning the camera lens, flush the camera with a large quantity of water and wipe it with a soft and wet cloth. Strongly rubbing the camera lens may cause the camera lens to be scratched and unable to transmit a clear image.
 - Do not allow an organic solvent, car wax, window cleaner or a glass coating to adhere to the camera. If this happens, wipe it off as soon as possible.
 - If the temperature changes rapidly, such as when hot water is poured on the vehicle in cold weather, the system may not operate normally.
 - When washing the vehicle, do not apply intensive bursts of water to the camera or camera area. Doing so may result in the camera malfunctioning.
- Do not expose the camera to strong impacts as this could cause a malfunction. If this happens, have the vehicle inspected by your Toyota dealer as soon as possible.

Cleaning the rear camera with washer fluid

Dirt on the rear camera lens can be cleaned by operating the dedicated camera cleaning washer.

- When cleaning the camera, it may be difficult to see the image due to the washer fluid. When backing up, be sure to visually check all around the vehicle both directly and using the mirrors before proceeding.
- If washer fluid remains on the camera lens surface after cleaning, the image may be difficult to see at night due to the height or inclination of the headlights of the vehicle behind.
- Some dirt may not be removed completely after cleaning. In this case, rinse the camera lens with a large quantity of water and then wipe it clean with a soft cloth dampened with water.
- Washer fluid is sprayed onto the camera lens surface. Therefore, the ice, snow, etc. adhering around the camera cannot be removed.



NOTICE

- If there is a sufficient amount of washer fluid but it does not spray out, check that the washer nozzle is not blocked.

- When the washer fluid reservoir is empty, do not operate the switch continually as the washer fluid pump may overheat.
- When a nozzle becomes blocked, contact your Toyota dealer. Do not try to clear it with a pin or other object. The nozzle would be damaged.
- Some foreign matters may not be removed completely after cleaning. In this case, rinse the rear camera lens with a large quantity of water and then wipe it clean with a soft cloth dampened with water. Do not strongly rub the rear camera lens, as it may be scratched and will not be able to transmit a clear image.
- Washer fluid is sprayed onto the rear camera lens surface. Therefore, the ice, snow, etc. adhering around the rear camera such as the garnish cannot be removed.
- Use fluids that are appropriate to the outside temperatures, in order to prevent the washer fluid from freezing.
- When washing the vehicle, do not let water from the high-pressure washer directly hit the nozzle. Due to the shock from the high pressure water, it is possible that the device may not operate normally. Also, the water may enter the nozzle injection opening and freeze. It causes the washer fluid not to spray properly.
- Do not subject the nozzle to sudden change of temperature such as by pouring hot water into the nozzle under the cold weather.

**NOTICE**

- The washer fluid will need to be replaced more often when the rear camera cleaner system is frequently used. Because the washer reservoir is shared with the windshield washer.
- Do not strike or hit the nozzle or subject it to a strong impact, as the nozzle installation position and angle may be changed.
- When the vehicle got strong vibration, it may be difficult to see the image due to the washer fluid drop from the nozzle.
- The display screen and placement position of the washer switch may differ depending on the type of screen and system.
- When the washer switch is pressed and held, washer fluid is sprayed while the switch is pressed.
- When activate rear camera washer, it also activate rear windows shield washer simultaneously.
- When cleaning the rear camera, it may be difficult to see the image due to the washer fluid. In this case, directly check the surroundings of the vehicle.
- If washer fluid remains on the rear camera lens surface after cleaning. Then the image may be difficult to see at night due to the height or inclination of the headlights of the vehicle behind.

Difference between the screen and the actual road

- The distance guide lines and the vehicle width guide lines

may not actually be parallel with the dividing lines of the parking space, even when they appear to be so. Be sure to check visually.

- The distances between the vehicle width guide lines and the left and right dividing lines of the parking space may not be equal, even when they appear to be so. Be sure to check visually.
- The distance guide lines give a distance guide for flat road surfaces. In any of the following situations, there is a margin of error between the guide lines on the screen and the actual distance/course on the road.

When the ground behind the vehicle slopes up sharply

The distance guidelines are projected on a horizontal surface, distances on an upward sloping surface appear farther from the vehicle than the actual distance. Because of this, objects will appear to be farther away than they actually are. In the same way, there will be a margin of error between the guidelines and the actual distance/course on the road.

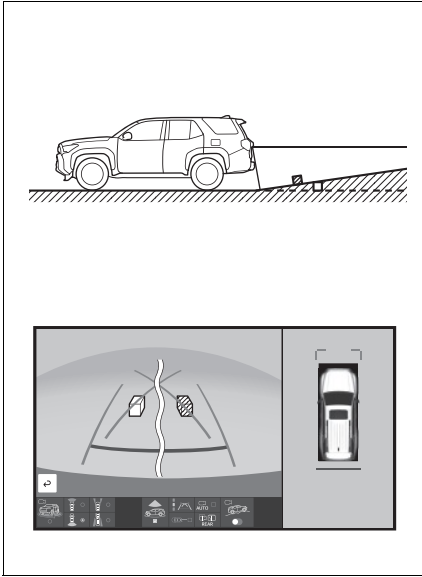

When the ground behind the vehicle slopes down sharply

The distance guidelines are projected on a horizontal surface, distances on an downward sloping surface appear closer to the vehicle than the actual distance. Because of this, objects will appear to be closer than they actually are. In the same way, there will be a margin of error between the guidelines and the actual distance/course on the road.

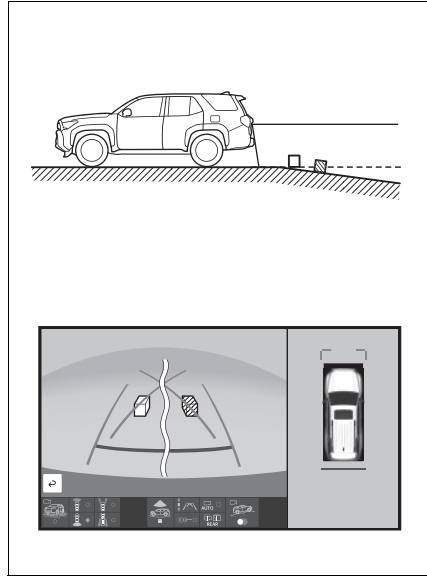

When any part of the vehicle sags

When the vehicle posture tilts due to the number of passengers or the distribution of the load, there is a margin of error between the guide lines on the screen and the actual distance/course on the road.

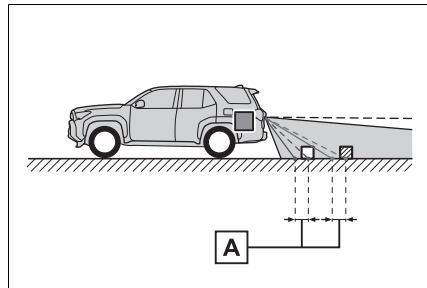

A A margin of error

Distortion of three-dimensional objects on the screen

When there are three-dimensional objects (such as vehicle bumpers, etc.) nearby in positions higher than the surface of the road, take extra care when using the following.

Panoramic view display (including magnified display)

Since the panoramic view processes and displays images based on flat road surfaces, it cannot depict the position of three-dimension objects (such as vehicle bumpers, etc.) that are in positions higher than the surface of the road. For example, even though it appears that there is space between the bumpers of the two vehicles in the illustration below and they are not likely to collide, in reality, a collision is about to occur.

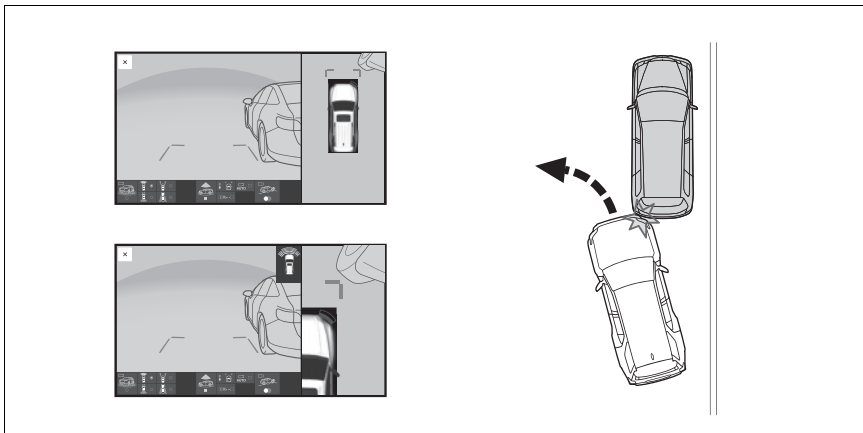

⚠ WARNING
When a sensor indicator on the intuitive parking assist display illuminates in red or a buzzer sounds continuously, be sure to check the area around the vehicle immediately and do not proceed any further until safety has been ensured, otherwise an unexpected accident may occur.

When approaching three-dimensional objects

The estimated course lines target flat surfaced objects (such as the road). It is not possible to determine the position of three-dimensional objects (such as vehicles) using the estimated course lines and distance guide lines. When approaching a three-dimensional object that extends outward (such as the flatbed of a truck), be care-

ful of the following.

⚠ WARNING

When a sensor indicator on the intuitive parking assist display illuminates in red or a buzzer sounds continuously, be sure to check the area around the vehicle immediately and do not proceed any further until safety has been ensured, otherwise an unexpected accident may occur.

Estimated course lines

Since the estimated course line is displayed for a flat road surface, it cannot depict the position of three-dimensional objects (such as vehicle bumpers, etc.) that are in positions higher than the surface of the road. Even if the bumpers of the vehicle is on the outside of the estimated course line in the image, in reality, the vehicles are on a collision course.

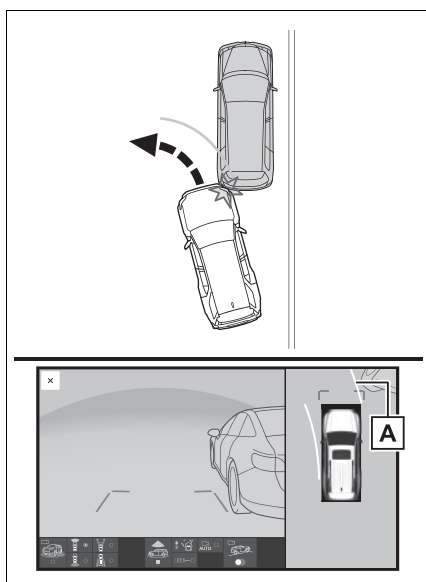

A Estimated course line
Three-dimensional objects

(such as the overhang of a wall or loading platform of a truck) in high positions may not be projected on the screen. Check the safety of the surroundings directly.

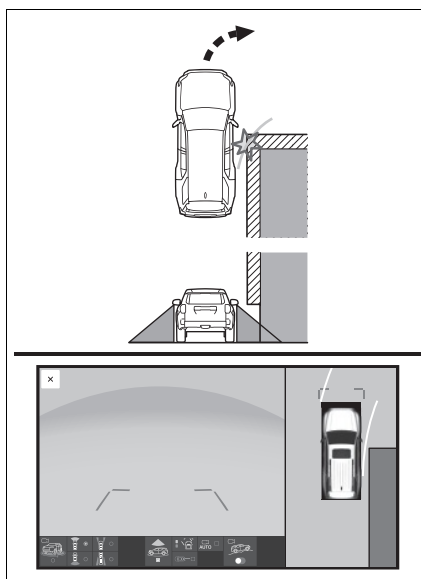

The pillar that is diagonal to the parking spot may be displayed perpendicular on the screen. Even if it seems like there will not be a collision, the pillar is diagonal, so there may be collision with the upper part of the pillar.

Check the safety of the surroundings directly.

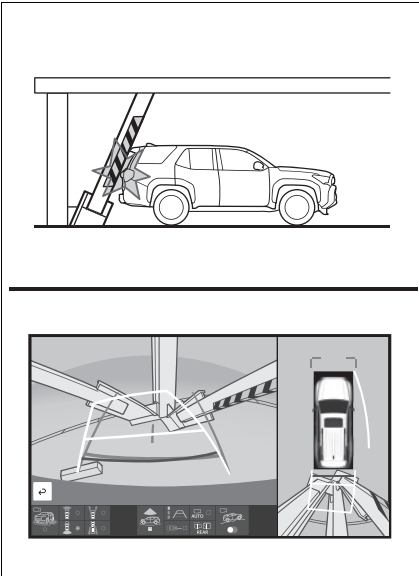

Visually check the surroundings and the area behind the vehicle. In the case shown below, the truck appears to be outside of the estimated course lines and the vehicle does not look as if it hits the truck. However, the rear body of the truck may actually cross over the estimated course lines. In reality if you back up as guided by the estimated course lines, the vehicle may hit the truck.

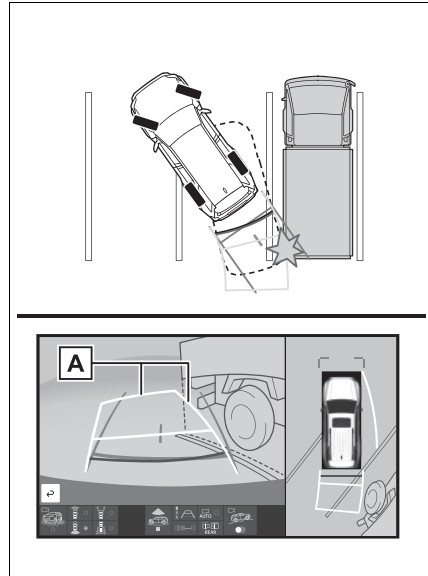

A Estimated course lines

Distance guide lines

Visually check the surroundings and the area behind the vehicle. On the screen, it appears that a truck is parking at point **B**. However, in reality if you back up to point **A**, you will hit the truck. On the screen, it appears that **A** is closest and **C** is farthest away. However, in reality, the distance to **A** and **C** is the same, and **B** is farther than **A** and **C**.

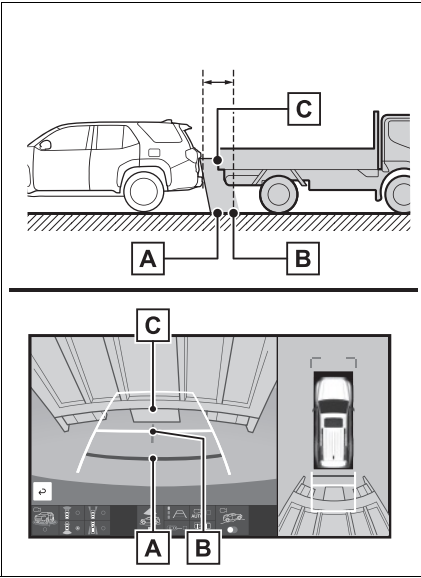

Things you should know

If you notice any symptoms

If you notice any of the following symptoms, refer to the likely cause and the solution, and re-check.

If the symptom is not resolved by the solution, have the vehicle inspected by your Toyota dealer.

Symptom	Likely cause	Solution
The image is difficult to see	<ul style="list-style-type: none"> • The vehicle is in a dark area • The temperature around the lens is either high or low • The outside temperature is low • There are water droplets on the camera • It is raining or humid • Foreign matter (mud, etc.) is adhering to the camera • Sunlight or headlights are shining directly into the camera • The vehicle is under fluorescent lights, sodium lights, mercury lights, etc. 	<p>Back up while visually checking the vehicle's surroundings. (Use the monitor again once conditions have been improved.)</p> <p>The procedure for adjusting the picture quality of the panoramic view monitor system is the same as the procedure for adjusting the screen display. (Refer to the "MULTIMEDIA OWNER'S MANUAL".)</p>
The image is blurry	Dirt or foreign matter (such as water droplets, snow, mud, etc.) is adhering to the camera.	<p>Flush the camera with a large quantity of water and wipe the camera lens clean with a soft and wet cloth.</p> <p>Operate the dedicated camera cleaning washer and clean the camera lens. (→P.243)</p>

Symptom	Likely cause	Solution
The image is out of alignment	The camera or surrounding area has received a strong impact.	Have the vehicle inspected by your Toyota dealer.
The guide lines are very far out of alignment	The camera position is out of alignment.	Have the vehicle inspected by your Toyota dealer.
	<ul style="list-style-type: none"> • The vehicle is tilted. (There is a heavy load on the vehicle, tire pressure is low due to a tire puncture, etc.) • The vehicle is used on an incline. 	<p>If this happens due to these causes, it does not indicate a malfunction.</p> <p>Back up while visually checking the vehicle's surroundings.</p>
The estimated course lines move even though the steering wheel is straight	There is a malfunction in the signals being output by the steering sensor.	Have the vehicle inspected by your Toyota dealer.
Guide lines are not displayed	The back door is open.	Close the back door. If this does not resolve the symptom, have the vehicle inspected by your Toyota dealer.
 is displayed	<ul style="list-style-type: none"> • Battery has been reinstalled. • The steering wheel has been moved while the battery was being reinstalled. • Battery power is low. • The steering sensor has been reinstalled. • There is a malfunction in the signals being output by the steering sensor. 	Have the vehicle inspected by your Toyota dealer.

Symptom	Likely cause	Solution
The panoramic view display cannot be magnified	The intuitive parking assist may be malfunctioning or dirty.	Follow the correction procedures for malfunctions of the intuitive parking assist. (→P.323)
The see-through view/moving view cannot be displayed		
Washer fluid dose not spray out.	When the washer fluid reservoir is empty.	Replenish washer fluid.
	When a nozzle becomes blocked.	Have the vehicle inspected by your Toyota dealer.
	When washer fluid is frozen.	Use washer fluids that are appropriate to the outside temperatures.
	The back door is open.	Close the back door.
	Washer fluid is not filled into the washer path hose due to no operation for an extended period of time.	Operate the rear camera washer several times.
Rear camera image is difficult to see.	Foreign matters (such as water droplets, mud, snow and snow melting agents.) is on the camera lens.	Rinse the camera with a large quantity of water, wipe it clean with a soft cloth dampened with water.
	Foreign matters (such as Ice, snow and mud) is attached to surrounding parts of the camera lens.	Remove foreign matters.
The washer switch does not respond.	The panoramic view monitor is malfunctioning.	Have the vehicle inspected by your Toyota dealer.

Multi-terrain Monitor*

* : If equipped

The Multi-terrain Monitor helps the driver to check the vehicle surroundings. It assists in determining the conditions around the driver in a variety of situations, such as when judging conditions during off-road driving or checking for obstacles when parking.

⚠ WARNING

Observe the following precautions to avoid an accident that could result in death or serious injuries.

■ When using the Multi-terrain Monitor system

- Never rely solely on the Multi-terrain Monitor. As with unequipped vehicles, drive carefully while directly confirming the safety of your surroundings and the area to the rear of the vehicle. Take particular care to avoid parked cars and other obstacles.
- Due to the characteristics of the camera lens, the actual position and distance of people and other obstacles will differ from those shown on the Multi-terrain Monitor screen. Directly confirm the safety of your surroundings before driving. When the outer mirrors are not positioned in normal position, images will not be displayed properly on the panoramic view monitor.

- Do not drive while only looking at the screen. When driving, make sure to directly confirm the safety of your surroundings, such as by visually checking the area and using the vehicle's mirrors.
- In low temperatures, the screen may darken or the images may become faint. Images of moving objects in particular may distort or disappear from the screen. Therefore, make sure to drive carefully while directly visually confirming the safety of your surroundings.

Camera switch

The camera switch is located as shown in the illustration.

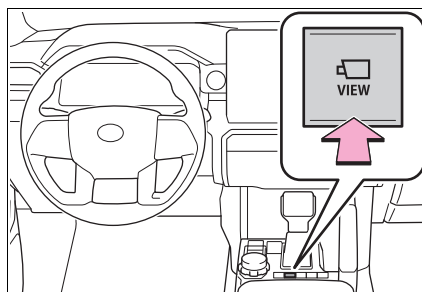

- The Multi-terrain Monitor is displayed by operating  when vehicle speed is approximately 10 mph (16 km/h) or less. If the vehicle speed exceeds approximately 10 mph (16 km/h), the Multi-terrain Monitor display is canceled.

Menu button

The screens that are displayed can be selected by the following buttons.

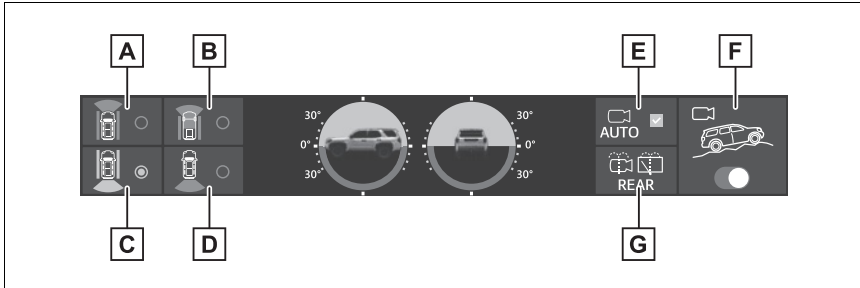

- A** Front view & dual side view
- B** Under vehicle terrain view & dual side view
- C** Rear view & dual side view
- D** Wide rear view
- E** Auto mode on/off button (→P.402)
- F** Multi-terrain Monitor on/off button

Panoramic View Monitor is displayed when the Multi-terrain Monitor is turned OFF. (→P.363)

- G** Rear camera washer switch

Press shortly: The rear camera washer operates for a certain period of time.

Press and hold: The rear camera washer operates while the rear camera washer switch remains pressed.

When the front-wheel drive control switch is in “4L” or “4H” (part-time 4WD), “L4L” or “H4L” (full-time 4WD) and Multi-terrain select is ON

The Multi-terrain Monitor is display a screen suitable for off-road.

- The driver can drive while confirming the following guidelines with a front view
 - Distance with the obstacle in the front
 - Estimated course line
- The driver can drive while confirming the obstacle in the flank of tire neighborhood and the vehicle with a side screen

Checking the area to the front and sides of the vehicle

- ▶ Front view & dual side view
Select the front view & dual side view button.

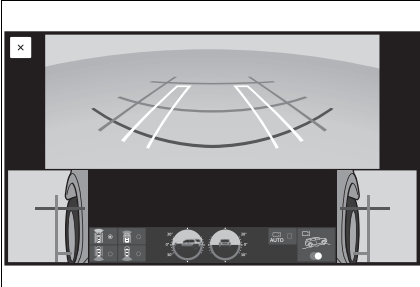

When the front view and side view screens are touched, each of the display sizes can be changed.

Checking the condition of the road surface under the vehicle

- ▶ Under vehicle terrain view & dual side view
Select the under vehicle terrain view & dual side view button.

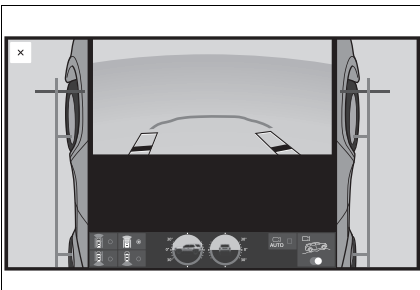

- ▶ Under vehicle terrain view & dual side view (front magnified)

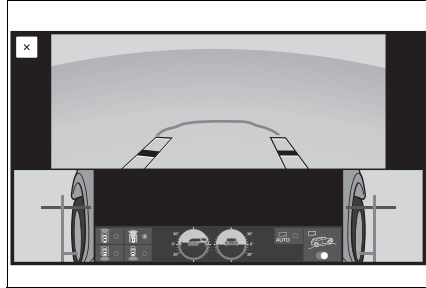

When the under vehicle terrain view and side view screens are touched, each of the display sizes can be changed.

Checking the area to the rear of the vehicle

- ▶ Rear view & dual side view
Select the rear view & dual side view button.

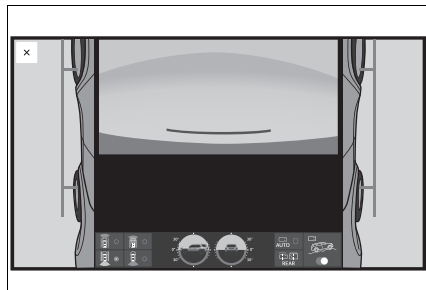

▶ Wide rear view

Select the wide rear view button.

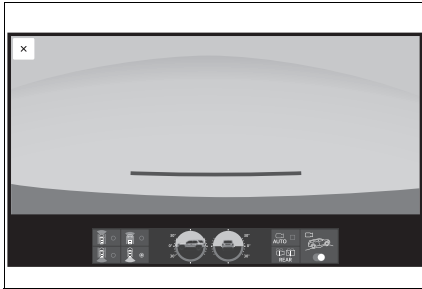

The rear view & dual side view and the wide rear displays can be switched by touching the screen.

When the front-wheel drive control switch is in “2H” or “4H” (part-time 4WD), “H4F” or “H4L” (full-time 4WD) and Multi-terrain select is OFF



The panoramic view monitor is

displayed. (→P.363)

Automatic display mode

When automatic display mode is turned on, the Multi-terrain Monitor screen is displayed in the following conditions, even if  has not been operated.

- When the shift lever is shifted to D or N.
- When vehicle speed is reduced to approximately 10 mph (16 km/h) or less.

- The automatic display mode switches between on and off each time  is selected. When automatic display mode is on, an indicator illuminates on the icon.
- Even when automatic display mode is on, the display can still be switched by pressing .

Screen display and functions

The front-wheel drive control switch in the case of “4L” or “4H” (part-time 4WD), “L4L” or “H4L” (full-time 4WD) and Multi-terrain select is ON, the Multi-terrain Monitor can display a screen suitable for off-road.

Front view & dual side view

Front view & dual side view can be used to check the area around the front of the vehicle.

- In addition to an image of the front of the vehicle, guide lines are displayed in a composite view to provide reference for when deciding a direction to move forward in.
- If the steering wheel is turned 270° or more, guide lines and other

features to support turning are automatically displayed.

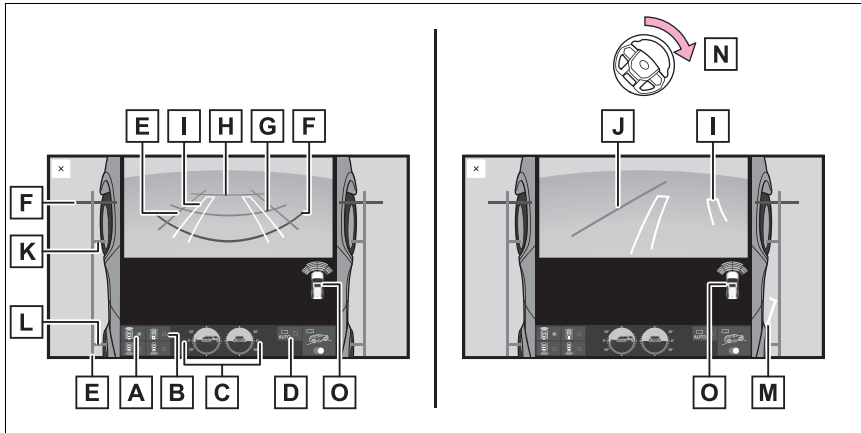

A Front view & dual side view button

B Under vehicle terrain view & dual side view button (→P.405)

C Clinometer

Displays the vehicle's estimated degree of incline. (→P.404)

D Automatic display button

Select to turn automatic display mode on/off. (→P.402)

E Vehicle width lines (blue)

Shows guide lines of the vehicle's width including the outside rear view mirrors.

F 1.5 ft. (0.5 m) distance guide line (red)

Show distance in front of the vehicle.

- Display points approximately 1.5 ft. (0.5 m) from the edge of the bumper.

G 3 ft. (1 m) distance guide line (blue)

H 6 ft. (2 m) distance guide line (blue)

I Front tire course line (yellow)

Shows the estimated course of the front tires according to steering wheel position.

J Forward movement guide line (blue)

Shows the estimated tire course of the tightest possible turn.

K Front tire contact line (blue)

Shows guide lines of where the front tire touches the ground.

L Rear tire contact line (blue)

Shows guide lines of where the rear tire touches the ground.

M Rear tire course line (yellow)

Shows the estimated course of the rear tires.

N When the steering wheel is turned by 270° or more

O Intuitive parking assist/slip display

When a sensor detects an obstacle, the direction of and the approximate distance to the obstacle are displayed and the buzzer sounds or indicates a tire slippage. (→P.405)

- The screen can be displayed when the shift lever is in a position other than P.
- When the intuitive parking assist detects an obstacle or another vehicle, a warning message pops up in the clinometer/slip display area.

Clinometer

Clinometer displays the vehicle inclination to the front, rear, left and right within a range of 0° to approximately 30°.

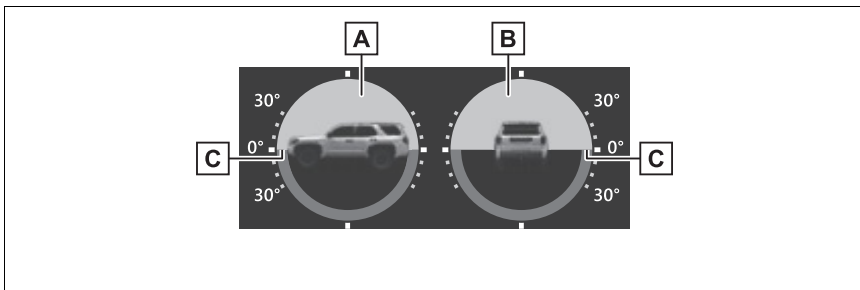

A Degree markers of incline to the front and rear

Indicates the vehicle inclination in degrees in the front and rear directions.

B Degree markers of incline to the left and right

Indicates the vehicle inclination in degrees in the left and right directions.

C Pointer

Indicates the degree of the vehicle inclination in comparison to a parallel line.

- The display indicates the incline of the vehicle in degrees shown by the movement of the pointer and the rotation of the vehicle image.
- The color of the degree markers of incline to the front, rear, left and right

changes according to the current incline of the vehicle.

- After the engine switch is in ON, the degree of incline is not displayed until such information is determined.
- The degree of incline showed on the clinometer is only an approximate indication, and may differ from the degree of incline measured using other equipment.

Slip display

When tire slippage is detected, the clinometer display area is automatically switched to the slip display.

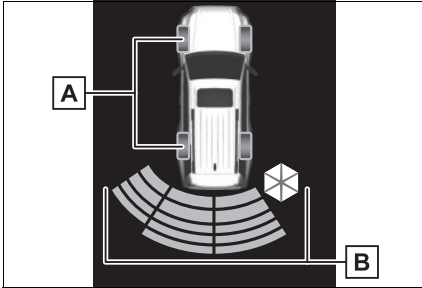

A Tire display

Indicates the position of freely spinning tires in yellow if the tire spins. (During Crawl Control is operating, all of the tires are indicated in yellow.)

B Pop-up display of the intuitive parking assist

Displayed if an obstacle is detected while the intuitive parking assist is turned on.

Under vehicle terrain view & dual side view

Lines indicating current vehicle and tire position are displayed in a composite view on an image taken approximately 32 ft. (10 m) behind the current vehicle position and assists the driver to check conditions underneath the vehicle or determine the position of the front tires.

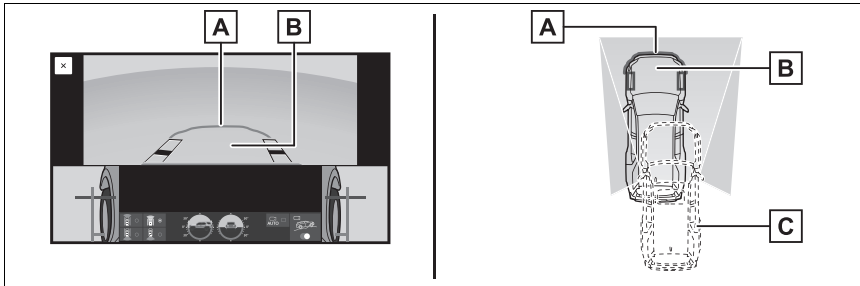

A Current vehicle position

B Image displayed in the under vehicle terrain view (image taken

approximately 32 ft. (10 m) behind the current vehicle position)

- C** Vehicle position at the time the image was taken (approximately 32 ft. (10 m) behind the current vehicle position)

Displaying the under vehicle terrain view

- ▶ Under vehicle terrain view & dual side view

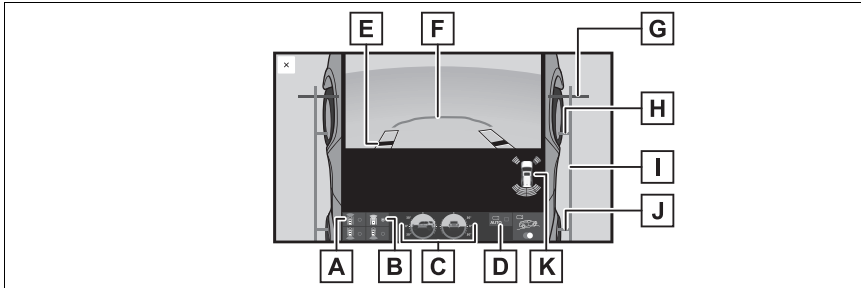

- ▶ Under vehicle terrain view & dual side view (front magnified)

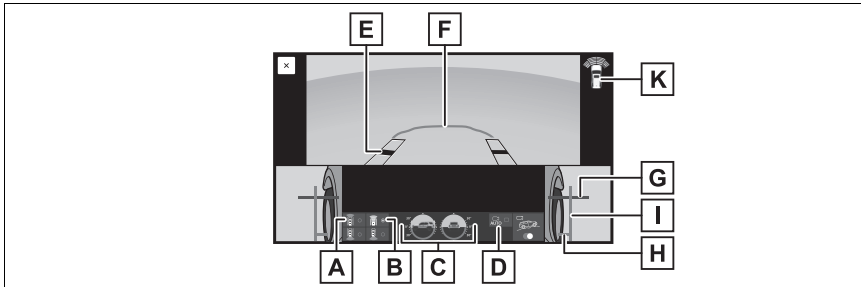

A Front view & dual side view button (→P.402)

B Under vehicle terrain view & dual side view button

C Clinometer

Displays the vehicle's estimated degree of incline. (→P.404)

D Automatic display button

Select to turn automatic display mode on/off. (→P.402)

E Tire position indicator lines (black or white)

Indicates the estimated position of the front tires.

F Vehicle position indicator lines (blue)

Indicates the estimated position of the vehicle.

G 1.5 ft. (0.5 m) distance guide line (red or black)

Show distance in front of the vehicle.

- Display points approximately 1.5 ft. (0.5 m) from the edge of the bumper.

H Front tire contact line (blue)

Shows guide lines of where the front tire touches the ground.

I Vehicle width lines (blue)

Shows guide lines of the vehicle's width including the outside rear view mirrors.

J Rear tire contact line (blue)

Shows guide lines of where the rear tire touches the ground.

K Intuitive parking assist/slip icon

When a sensor detects an obstacle, the direction of and the approximate distance to the obstacle are displayed and the buzzer sounds or indicates a tire slippage. (→P.405)

- The screen can be displayed when the shift lever is in a position other than P.
- In the following situations, the system may not operate normally, or it may not be possible to switch to the under vehicle terrain view.
 - The road is covered with snow
 - It is nighttime and the road has no illumination
 - Dirt or foreign matter is adhering to the camera lens
 - There is water in front of the vehicle (a river, puddle, sea water, etc.)



WARNING

- The tire position indicator lines and vehicle position indicator lines may differ from actual vehicle positions depending on the number of passengers, cargo weight, road grade, road surface conditions, brightness of the surrounding environment, etc. Always drive the vehicle while confirming the safety of your surroundings.
- The image displayed is one that was previously taken at a point approximately 32 ft. (10 m) behind the current vehicle position. In cases such as when objects move after the image is taken, the image displayed on the screen may differ from the actual state.

Rear view & dual side view/wide rear view

The rear view & dual side view/wide rear view screen provide support when checking the areas of behind the vehicle and around the vehicle while backing up, for example while parking.

The screens will be displayed when the shift lever is in R.

► Rear view & dual side view

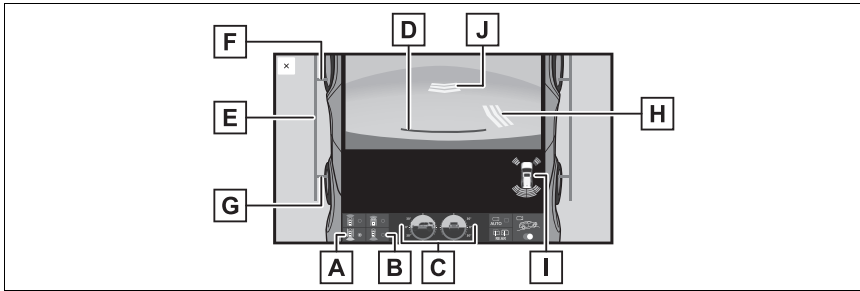

► Wide rear view

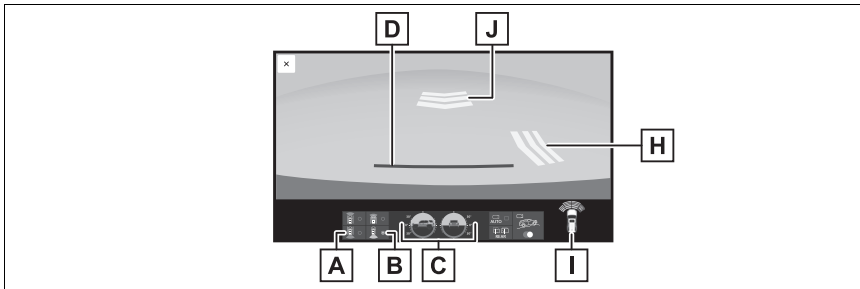

A Rear view & dual side view

B Wide rear view button

C Clinometer/slip display

Displays the vehicle's estimated degree of incline or indicates a tire slip-page. (→P.404, 405)

D 1.5 ft. (0.5 m) distance guide line (red)

Show distance in rear of the vehicle.

- Display points approximately 1.5 ft. (0.5 m) from the edge of the bumper.

E Vehicle width guide lines (blue)

Displays a guide path when the vehicle is being backed straight up.

F Front tire contact line (blue)

Shows guide lines of where the front tire touches the ground.

G Rear tire contact line (blue)

Shows guide lines of where the rear tire touches the ground.

H Rear Cross Traffic Alert/Rear Camera Detection

When a sensor detects a vehicle or pedestrian approaching from the rear, the direction of the vehicle or pedestrian approaching from the rear is dis-

played and the buzzer sounds.

I Intuitive parking assist

When a sensor detects an obstacle, the direction of and the approximate distance to the obstacle are displayed and the buzzer sounds.

J Rear Camera Detection

When the rear camera detects a pedestrian approaching from the rear, the direction of the vehicle approaching from the rear is displayed and the buzzer sounds.

- The screen can be displayed when the shift lever is in P.
- For details about the Rear Cross Traffic Alert function. (→P.330)
- If the back door is not closed, guide lines will not be displayed. If the guide lines do not display even when the back door is closed, have the vehicle inspected at your Toyota dealer.

WARNING

The tire position indicator lines and vehicle position indicator lines may differ from actual vehicle positions depending on the number of passengers, cargo weight, road grade, road surface conditions, brightness of the surrounding environment, etc. Always drive the vehicle while confirming the safety of your surroundings.

Cleaning the camera

If dirt or foreign matter, such as water droplets, snow, or mud, has stuck to the camera, you will not be able to see the image clearly. If that happens, splash the camera with a large amount of water and then wipe the camera lens clean with a soft, damp cloth.

Rear camera: Dirt on the camera lens can be cleaned by operating the dedicated camera cleaning washer. (→P.243)

NOTICE

■ How to use the cameras

- The Multi-terrain Monitor may stop functioning correctly. Take note of the following items:
 - Do not hit or apply a forceful impact on the camera. Doing so may change the position and mounting angle of the camera.
 - The camera is designed to be waterproof. Do not detach, disassemble, or modify it.
 - When washing the camera lens, splash the camera with a large amount of water and then wipe the camera lens clean with a soft, damp cloth. Rubbing the camera lens forcibly may scratch the camera lens and you may no longer be able to see images clearly.

**NOTICE**

- The camera cover is made of resin. Do not allow an organic solvent, car wax, window cleaner, or glass coating to adhere to the camera. If this happens, wipe it off immediately.
- Do not pour hot water on the vehicle in cold weather or apply other rapid changes of temperature.
- If you wash the vehicle with a high pressure car washer, do not point the hose directly at the camera or camera area. Applying strong water pressure may result in the camera malfunctioning.
- If the camera is hit, it may cause a camera malfunction. If this happens, have the vehicle inspected by your Toyota dealer as soon as possible.

Cleaning the rear camera with washer fluid

Dirt on the rear camera lens can be cleaned by operating the dedicated camera cleaning washer.

- When cleaning the camera, it may be difficult to see the image due to the washer fluid. When backing up, be sure to visually check all around the vehicle both directly and using the mirrors before proceeding.
- If washer fluid remains on the camera lens surface after cleaning, the image may be

difficult to see at night due to the height or inclination of the headlights of the vehicle behind.

- Some dirt may not be removed completely after cleaning. In this case, rinse the camera lens with a large quantity of water and then wipe it clean with a soft cloth dampened with water.
- Washer fluid is sprayed onto the camera lens surface. Therefore, the ice, snow, etc. adhering around the camera cannot be removed.

**NOTICE**

- If there is a sufficient amount of washer fluid but it does not spray out, check that the washer nozzle is not blocked.
- When the washer fluid reservoir is empty, do not operate the switch continually as the washer fluid pump may overheat.
- When a nozzle becomes blocked, contact your Toyota dealer. Do not try to clear it with a pin or other object. The nozzle would be damaged.
- Some foreign matters may not be removed completely after cleaning. In this case, rinse the rear camera lens with a large quantity of water and then wipe it clean with a soft cloth dampened with water. Do not strongly rub the rear camera lens, as it may be scratched and will not be able to transmit a clear image.

**NOTICE**

- Washer fluid is sprayed onto the rear camera lens surface. Therefore, the ice, snow, etc. adhering around the rear camera such as the garnish cannot be removed.
- Use fluids that are appropriate to the outside temperatures, in order to prevent the washer fluid from freezing.
- When washing the vehicle, do not let water from the high-pressure washer directly hit the nozzle. Due to the shock from the high pressure water, it is possible that the device may not operate normally. Also, the water may enter the nozzle injection opening and freeze. It causes the washer fluid not to spray properly.
- Do not subject the nozzle to sudden change of temperature such as by pouring hot water into the nozzle under the cold weather.
- The washer fluid will need to be replaced more often when the rear camera cleaner system is frequently used. Because the washer reservoir is shared with the windshield washer.
- Do not strike or hit the nozzle or subject it to a strong impact, as the nozzle installation position and angle may be changed.
- When the vehicle got strong vibration, it may be difficult to see the image due to the washer fluid drop from the nozzle.
- The display screen and placement position of the washer switch may differ depending on the type of screen and system.

- When the washer switch is pressed and held, washer fluid is sprayed while the switch is pressed.
- When activate rear camera washer, it also activate rear windows shield washer simultaneously.
- When cleaning the rear camera, it may be difficult to see the image due to the washer fluid. In this case, directly check the surroundings of the vehicle.
- If washer fluid remains on the rear camera lens surface after cleaning. Then the image may be difficult to see at night due to the height or inclination of the headlights of the vehicle behind.

Multi-terrain Monitor precautions

→P.384

Things you should know

→P.396

Driving mode select switch

The driving modes can be selected to suit driving condition.

System components

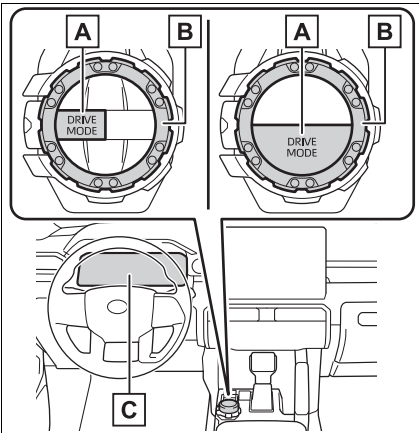

- A** “DRIVE MODE” switch
- B** Mode select switch
- C** Multi-information display
(→P.91, 100)

Selecting the driving mode

- 1 Press the “DRIVE MODE” switch.

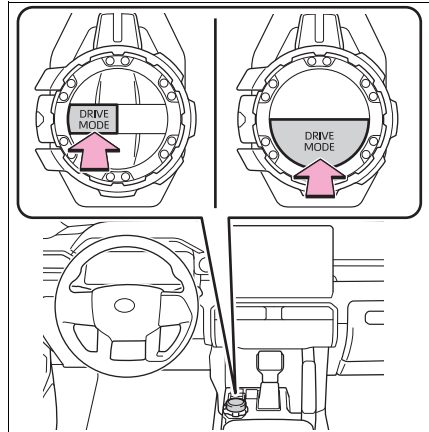

- 2 Select the driving modes on the multi-information display while turning the mode select switch left and right.

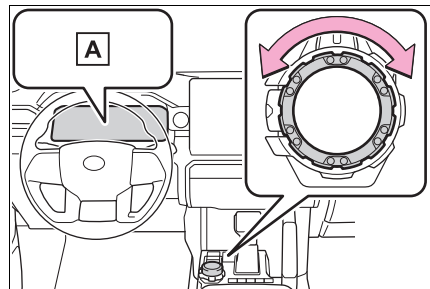

- A** Multi-information display
 - ▶ Vehicles without Adaptive Variable Suspension system
 - “NORMAL” mode

Provides an optimal balance of fuel economy, quietness, and dynamic performance. Suitable for city driving.

- “ECO” mode

Helps the driver accelerate in an eco-friendly manner and improve fuel economy through moderate throttle characteristics and by controlling the operation of the air conditioning system (heating/cooling). The “ECO” indicator comes on.

- “SPORT” mode

Assists acceleration response by controlling the transmission, engine and steering. Suitable for when precise handling is desirable, for example when driving on mountain roads. The “SPORT” indicator comes on.

▶ Vehicles with Adaptive Variable Suspension system

- “NORMAL” mode

Provides an optimal balance of fuel economy, quietness, and dynamic performance. Suitable for city driving.

- “COMFORT” mode

By controlling the suspension, riding comfort is further enhanced. Suitable for city driving. The “COMFORT” indicator comes on.

- “ECO” mode

Helps the driver accelerate in an eco-friendly manner and improve fuel economy through moderate throttle characteristics and by controlling the operation of the air conditioning system (heating/cooling). The “ECO” indicator comes on.

- “SPORT S” mode

Assists acceleration response by controlling the transmission, engine and steering. Suitable for when precise handling is desirable, for

example when driving on mountain roads. The “SPORT S” indicator comes on.

- “SPORT S+” mode

Helps to ensure the controllability and stability of the vehicle by integrally controlling the steering wheel and suspensions as well as the transmission and engine, making it suitable for sporty driving. The “SPORT S+” indicator comes on.

- “CUSTOM” mode

Allows you to drive with the powertrain, chassis and air conditioning system functions set to your preferred settings. Custom mode settings can only be changed on the drive mode customization display of multimedia system. The “CUSTOM” indicator comes on.

■ **The driving mode select switch can be operated when**

▶ Vehicles with part-time 4WD

The front-wheel drive control switch is in “2H” and “4H”.

▶ Vehicles with full-time 4WD

The front-wheel drive control switch is in “H4F” and “H4L”.

■ **Operation of the air conditioning system in Eco mode**

Eco mode controls the heating/cooling operations and fan speed of the air conditioning system to enhance fuel efficiency. To improve air conditioning performance, perform the following operations:

- Adjust the fan speed (→P.454, 461)
- Turn off Eco drive mode (→P.412)

■ **Automatic deactivation of driving modes:**

Driving mode is deactivated or the

driving mode will be changed to normal mode in the following conditions:

- After turning the engine switch off and then turning it to on
- Vehicles with part-time 4WD: When the front-wheel drive control switch is in “4L”
- Vehicles with full-time 4WD: When the front-wheel drive control switch is in “L4L”
- When the Multi-terrain Select is turned on (if equipped)
- When the Downhill assist control system is turned on (if equipped)
- When the “TOW HAUL” mode is turned on

■ Customization

The Custom mode can be changed. (Customizable features: →P.652)

Four-wheel drive system (part-time 4WD models)*

*: If equipped

Use the front-wheel drive control switch to select the following transfer modes:

Front-wheel drive control switch

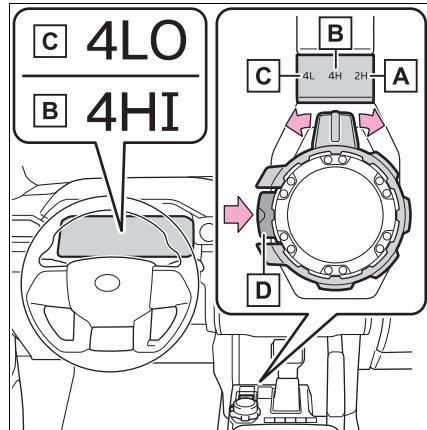

A “2H” (high speed position, two-wheel drive)

Use this for normal driving on dry hard-surfaced roads. This position gives greater economy, quietest ride and least wear.

Hold down **D** and turn the dial to select.

B “4H” (high speed position, four-wheel drive)

Use this for driving only on tracks that permit the tires slide, like off-road, icy or snow-covered roads. This position provides greater trac-

tion than two-wheel drive.

The “4HI” indicator will come on.

Hold down **D** and turn the dial to select.

C “4L” (low speed position, four-wheel drive)

Use this for maximum power and traction. Use “4L” for climbing or descending steep hills, off-road driving, and hard pulling in sand, mud or deep snow.

The “4LO” indicator will come on.

Hold down **D** and turn the dial to select.

Shifting between “2H” and “4H”

■ **Shifting from “2H” to “4H”**

- 1 Reduce vehicle speed to less than 62 mph (100 km/h).
- 2 Push and turn the front-wheel drive control switch to “4H”.

The “4HI” indicator will come on.

■ **Shifting from “4H” to “2H”**

- 1 Reduce vehicle speed to less than 62 mph (100 km/h).
- 2 Push and turn the front-wheel drive control switch to “2H”.

The “4HI” indicator will go off.

Shifting between “4H” and “4L”

■ **Shifting from “4H” to “4L”**

- 1 Stop the vehicle completely and continue to depress the brake pedal.

- 2 Shift the shift lever to N.

- 3 Push and turn the front-wheel drive control switch to “4L”.

The “4LO” indicator will come on and the “4HI” indicator go off.

■ **Shifting from “4L” to “4H”**

- 1 Stop the vehicle completely and continue to depress the brake pedal.
- 2 Shift the shift lever to N.
- 3 Push and turn the front-wheel drive control switch to “4H”.

The “4LO” indicator will go off and the “4HI” indicator come on.

■ **When the front-wheel drive control switch is shifted to “4L”**

VSC is automatically turned off.

■ **If the “4HI” indicator flashes**

The transfer mode may not successfully change. Drive straight ahead while accelerating or decelerating, or drive in reverse.

■ **If the “4HI” indicator is ON and the “4LO” indicator continues to flash**

Shift the shift lever to D or R and drive the vehicle slowly, then stop.

■ **If the “4HI” indicator continues to flash and the “4LO” indicator is ON**

Shift the shift lever to D or R and drive the vehicle slowly, then stop.

■ **If the “4HI” indicator is ON and the “4LO” indicator continues to flash and a buzzer sounds**

The shift lever is not in N and/or the vehicle is moving. Stop the vehicle completely, shift the shift lever to N and make sure that the indicator stops flashing.

■ **If the “4HI” indicator continues to flash and the “4LO” indicator is ON and a buzzer sounds**

The shift lever is not in N and/or the vehicle is moving. Stop the vehicle completely, shift the shift lever to N and make sure that the indicator stops flashing

■ **If the “4HI” and “4LO” indicator flashes rapidly**

There may be a malfunction in the four-wheel drive system. Have the vehicle inspected by your Toyota dealer immediately.

■ **Shift between “4H” and “4L” at low temperature**

Immediately after starting the engine in a low-temperature environment, the shift between “4H” and “4L” may be prohibited because the transmission fluid is cold. At that time, a warning message will be displayed in the multi-information display, so follow the message and operate the front-wheel drive control switch again after warming up.

■ **Four-wheel drive usage frequency**

You should drive in four-wheel drive for at least 10 miles (16 km) each month. This will assure that the front drive components are lubricated.

■ **When the vehicle is parked**

If the shift lever is moved before the “4HI” or “4LO” indicator turns on/off, the transfer mode may not be shifted completely. The transfer mode disengages both the front and rear driveshafts from the powertrain and allows the vehicle to move regardless of the shift position. (At this time, the indicator blinks and the buzzer sounds.) Therefore, the vehicle is free to roll even if the automatic transmission is in P. You or someone else could be seriously injured. You must complete the shifting of the transfer mode before placing transmission in P.



WARNING

■ **Shifting the front-wheel drive control switch from “2H” to “4H” while driving**

Never operate the front-wheel drive control switch if the wheels are slipping. Stop the slipping or spinning before shifting.

Four-wheel drive system (full-time 4WD models)*

*: If equipped

Use the front-wheel drive control switch to select the following transfer modes:

Front-wheel drive control switch

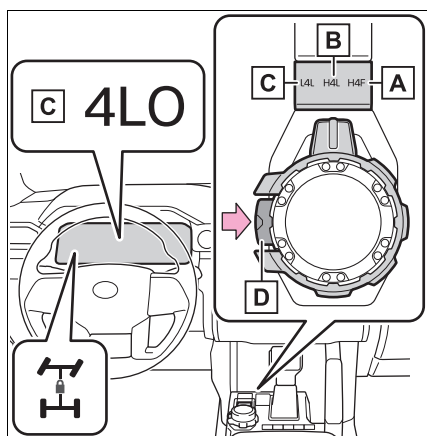

A "H4F" (high speed position)

Use this for normal driving on dry hard-surfaced roads. This position gives greater economy, quietest ride and least wear.

Hold down **D** and turn the dial to select.

B "H4L" (high speed position, center differential locked)

Use this for driving only on tracks that permit the tires slide, like off-road, icy or snow-covered roads. The center differential lock indicator will come on.

Hold down **D** and turn the dial to select.

C "L4L" (low speed position, center differential locked)

Use this for maximum power and traction. Use "L4L" for climbing or descending steep hills, off-road driving, and hard pulling in sand, mud or deep snow.

The "4LO" indicator will come on.

Hold down **D** and turn the dial to select.

Shifting between "H4F" and "H4L"

■ Shifting from "H4F" to "H4L"

- 1 Reduce vehicle speed to less than 62 mph (100 km/h).
- 2 Push and turn the front-wheel drive control switch to "H4L".

The center differential lock indicator will come on.

■ Shifting from "H4L" to "H4F"

- 1 Reduce vehicle speed to less than 62 mph (100 km/h).
- 2 Push and turn the front-wheel drive control switch to "H4F".

The center differential lock indicator will go off.

Shifting between “H4L” and “L4L”

■ Shifting from “H4L” to “L4L”

- 1 Stop the vehicle completely and continue to depress the brake pedal.
- 2 Shift the shift lever to N.
- 3 Push and turn the front-wheel drive control switch to “L4L”.

The “4LO” indicator and center differential lock indicator will come on.

■ Shifting from “L4L” to “H4L”

- 1 Stop the vehicle completely and continue to depress the brake pedal.
- 2 Shift the shift lever to N.
- 3 Push and turn the front-wheel drive control switch to “H4L”.

The “4LO” indicator will go off.

■ When the front-wheel drive control switch is shifted to “L4L”

VSC is automatically turned off.

■ If the “4LO” indicator continues to flash

Shift the shift lever to D or R and drive the vehicle slowly, then stop.

■ If the “4LO” indicator continues to flash and a buzzer sounds

The shift lever is not in N and/or the vehicle is moving. Stop the vehicle completely, shift the shift lever to N and make sure that the indicator stops flashing.

■ If the center differential lock indicator flashes

Locking or unlocking of the center differential is not complete. Drive

straight ahead while accelerating or decelerating, or drive in reverse.

■ If the center differential lock indicator flashes and a buzzer sounds

Locking of the center differential is not complete. Stop the wheels from slipping or spinning and, if the indicator still flashes, operate the four-wheel drive control switch again.

■ If the center differential lock indicator or the “4LO” indicator flashes rapidly

There may be a malfunction in the four-wheel drive system. Have the vehicle inspected by your Toyota dealer immediately.

■ Shift between “H4L” and “L4L” at low temperature

Immediately after starting the engine in a low-temperature environment, the shift between “H4L” and “L4L” may be prohibited because the transmission fluid is cold. At that time, a warning message will be displayed in the multi-information display, so follow the message and operate the front-wheel drive control switch again after warming up.



WARNING

■ Shifting the front-wheel drive control switch from “H4F” to “H4L” while driving

Never operate the front-wheel drive control switch if the wheels are slipping. Stop the slipping or spinning before shifting.

⚠ WARNING

■ **When the vehicle is parked**

If the shift lever is moved before the “4LO” indicator turns on/off, the transfer mode may not be shifted completely. The transfer mode disengages both the front and rear driveshafts from the powertrain and allows the vehicle to move regardless of the shift position. (At this time, the indicator blinks and the buzzer sounds.) Therefore, the vehicle is free to roll even if the automatic transmission is in P. You or someone else could be seriously injured. You must complete the shifting of the transfer mode before placing transmission in P.

AUTO LSD system*

*: If equipped

The AUTO LSD system aids traction by using the traction control system to control engine performance and braking when one of the drive wheels begins to spin. The system should be used only when one of the drive wheels spinning occurs in a ditch or rough surface.

System operation

The system can be used only on 2WD models.

To turn the AUTO LSD system on, quickly press and release



The “AUTO LSD” indicator light and VSC off indicator light will come on.

Press  again to turn the system off.

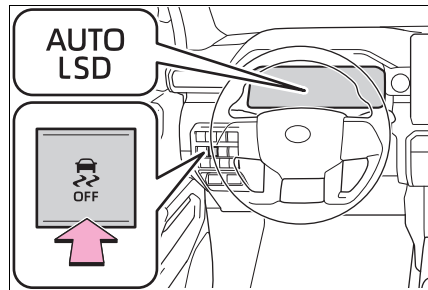

When the AUTO LSD system is operating

If the drive wheels spin, the slip indicator flashes to indicate that the AUTO LSD system has controlled the spinning of the drive wheels.

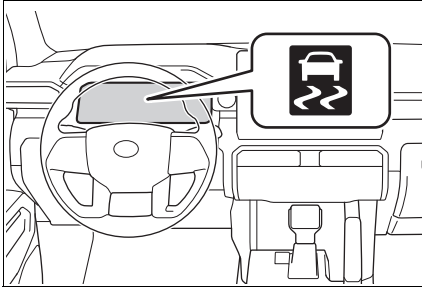

■ If the engine is turned off and restarted

The AUTO LSD system and the indicators are automatically turned off.

■ Reactivation of the VSC system linked to vehicle speed

When the AUTO LSD system is turned on, the VSC and TRAC systems will turn on automatically if vehicle speed increase.

■ If the brake system overheats

The system will cease operation and a buzzer will alert the driver. At this time, the “AUTO LSD” indicator will flash and “Traction Control Turned OFF” will be shown on the multi-information display. Stop the vehicle in a safe place. (There is no problem with continuing normal driving.) The system will be automatically restored after a short time.

⚠ WARNING

■ To avoid an accident

Failure to do so, a much greater steering effort and more careful cornering control will be required.

- Do not use the AUTO LSD system in conditions other than when one of the drive wheels spinning occurs in a ditch or rough surface.
- Do not drive with the AUTO LSD system continuously turned on.

⚠ NOTICE

■ Activating while driving

Do not activate the AUTO LSD system if the wheel is slipping. Stop the slipping or spinning before activating.

Rear differential lock system*

*: If equipped

Use the rear differential lock system only when wheel spinning occurs in a ditch or on a slippery or ragged surface. This system is effective in case one of the rear wheels is spinning.

Rear differential lock switch

Press the switch to turn the system on/off.

At this time, the rear differential lock indicator and indicator in the differential lock/unlock display will blink. Wait a few seconds for the system to complete operation. After the rear differential is locked, the indicators will stop blinking and remain on.

To unlock the rear differential, push the switch again.

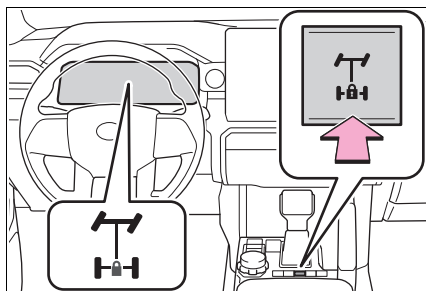

■ Operating tips

- Be sure to stop the wheels before locking the differential.
- Unlock the differential as soon as

the vehicle moves out.

■ Unlocking the rear differential

If the rear differential lock indicator still flashes even after unlocking the rear differential, check the safety of the surrounding area and slightly turn the steering wheel in either direction while the vehicle is in motion.

■ Automatic unlocking feature

The rear differential lock is also unlocked in any of the following situations:

- When the front-wheel drive control switch is turned to “2H” or “4H”
- When the engine switch is turned off

■ After unlocking the rear differential

Check that the indicators go off.

■ The rear differential lock indicator and indicator in the differential lock/unlock display

- The indicators blink while locking/unlocking the rear differential.
- If the indicators continue to blink when you operate the rear differential lock switch, stop the vehicle completely and operate the switch again.

If the indicators continue to blink even if doing so, have the vehicle inspected by your Toyota dealer as soon as possible. There may be a trouble in the four-wheel drive system.

■ Locking the rear differential

The following systems do not operate when the rear differential is locked.

- ABS
- Brake assist system
- VSC
- Downhill assist control system
- TRAC

**WARNING****■ When using the rear differential lock system**

Failure to observe the following precautions may result in an accident.

- Do not lock the rear differential in the conditions other than above.
- Do not lock the rear differential until the wheels have stopped spinning.
- Do not drive over 5 mph (8 km/h) when the differential is locked.
- Do not keep driving with the rear differential lock state

Crawl Control*

*: If equipped

Allows travel on extremely rough off-road surfaces at a fixed low speed without pressing the accelerator or brake pedal. Minimizes loss of traction or vehicle slip when driving on slippery road surfaces, allowing for stable driving.

**WARNING****■ When using Crawl Control function**

Do not rely solely on the Crawl Control function. This function does not extend the vehicle's performance limitations. Always thoroughly check the road conditions, and drive safely.

■ These conditions may cause the system not to operate properly

When driving on the following surfaces, the system may not be able to maintain a fixed low speed, which may result in an accident:

- Extremely steep inclines.
- Extremely uneven surfaces.
- Snow-covered roads, or other slippery surfaces.

System components

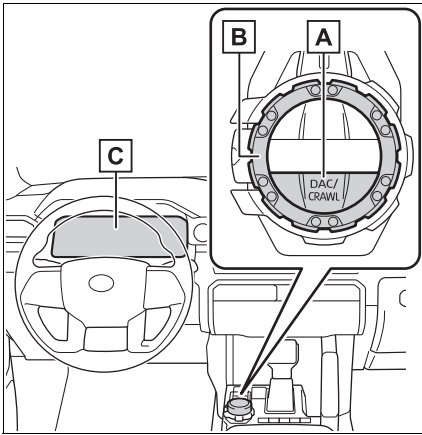

- A** “DAC/CRAWL” switch
- B** Mode select switch
- C** Multi-information display

Turning Crawl Control on

- 1 Press the “DAC/CRAWL” switch.

The Crawl Control indicator on the multi-information display will come on, and the slip indicator will flash.

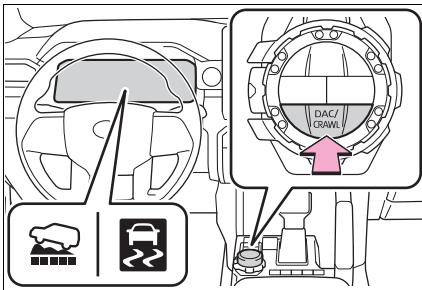

- 2 Turn the mode select switch left or right to select a mode

on the multi-information display.

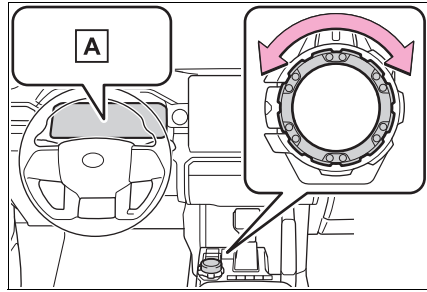

- A** Multi-information display

Selectable modes

A mode which matches the road conditions can be selected from among the following 5 modes.

“LO”

Suitable for driving on rocky roads or decline

“LO-Mid”

Suitable for driving on rocky roads, decline or bumpy incline

“Mid”

Suitable for driving on bumpy inclines

“Mid-HI”

Suitable for driving on bumpy inclines, debris roads, snow-covered roads, muddy roads, gravel roads and grass roads

“HI”

Suitable for driving on bumpy inclines, debris roads, snow-covered roads, muddy roads, gravel roads and grass roads

Turning Crawl Control off

- ▶ When the “DAC/CRAWL” switch indicator illuminates

Press the “DAC/CRAWL” switch again.

- ▶ When the “DAC/CRAWL” switch indicator does not illuminate

Press the “DAC/CRAWL” switch to turn the indicator on. Press the “DAC/CRAWL” switch again with the indicator turned on.

If Crawl Control is turned off, the Crawl Control indicator and the slip indicator will go off and a message, stating that Crawl Control has been turned off will be displayed on the multi-information display for several seconds.

When turning off Crawl Control while driving, drive extremely carefully.

■ Operating tips

Crawl Control can be used with Multi-terrain Select ON or OFF. (→P.425)

■ Operation conditions of the Crawl Control

- The engine is running.
- The shift lever is in any gear other than P or N.
- The front-wheel drive control switch is in “4L”.
- The driver’s door is closed.

■ Automatic system cancelation of Crawl Control

In the following situations, the

buzzer will sound intermittently and the Crawl Control will be canceled automatically. In this event, the Crawl Control indicator will flash and then go off, and a message stating that Crawl Control has been turned off will be displayed on the multi-information display for several seconds.

- When the shift lever is moved to P or N.
- When the front-wheel drive control switch is in “4H”.
- When the driver’s door is opened.

■ Function limitations of Crawl Control

- On vehicles with rear differential lock system, in the following situations, brake control can be used to drive downhill at a constant speed. However, engine control is not available when driving uphill at a constant speed.
 - When the vehicle speed exceeds approximately 6 mph (10 km/h).
- In the following situation, engine control and brake control will stop temporarily. In this event, the Crawl Control indicator will flash.
 - With the rear differential is locked: when the vehicle speed exceeds approximately 6 mph (10 km/h).
 - With the rear differential is unlocked: when the vehicle speed exceeds approximately 15 mph (25 km/h).

■ When the Crawl Control system is operated continuously

- If Crawl Control is used continuously for a long time, the brake system overheats. In this case, a buzzer will sound, a message stating a malfunction will be displayed on the multi-information display, and the Crawl Control indicator will flash and then go off. In this event, as Crawl Control will be temporarily inoperable, stop the vehicle immediately in a safe place, and allow the brake system to cool down sufficiently until the

message goes off. (In the meantime, normal driving is possible.)

- If Crawl Control is used continuously for a long time, the automatic transmission overheats. In this case, a buzzer will sound, the system will be temporarily canceled, and a message stating a malfunction may be displayed on the multi-information display. In this event, stop the vehicle in a safe place until the message goes off.

■ Sounds and vibrations caused by the Crawl Control system

- A sound may be heard from the engine compartment when the engine is started or just after the vehicle begins to move. This sound does not indicate that a malfunction has occurred in Crawl Control system.
- Either of the following conditions may occur when the Crawl Control system is operating. None of these are indicators that a malfunction has occurred.
 - Vibrations may be felt through the vehicle body and steering.
 - A motor sound may be heard after the vehicle comes to a stop.

■ When there is a malfunction in the system

Warning lights and/or warning messages will turn on. (→P.576, 587)

Multi-terrain Select*

*: If equipped

Multi-terrain Select is a system that improves drivability in off-road situations.

Select a mode that most closely matches the type of terrain on which you are driving from several modes.

Brake control, steering feel and drive force control can be optimized in accordance with the selected mode.

WARNING

■ When using the Multi-terrain Select

Observe the following precautions to avoid an accident that could result in death or serious injuries:

- Check that the selected mode indicators are illuminated before driving. Multi-terrain Select will not operate when the indicators are off.
- The road conditions listed (→P.426) are for reference only. There is a chance that the function may not be the most appropriate in terms of road conditions such as pitch, slipperiness, undulation, etc. Thoroughly check the road conditions before driving.
- Multi-terrain Select is not intended to expand the limits of the vehicle. Check the road conditions thoroughly beforehand, and drive safely and carefully.

 **NOTICE**

■ Precaution for use

The Multi-terrain Select is intended for use during off-road driving. Do not use the system at any other time.

System components

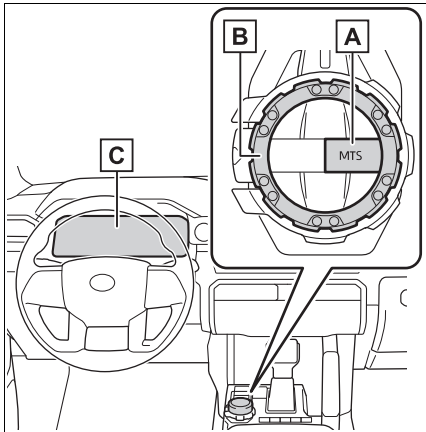

- A** “MTS” switch
- B** Mode select switch
- C** Multi-information display
Selected mode is displayed.

Switching modes

1 Press the “MTS” switch.

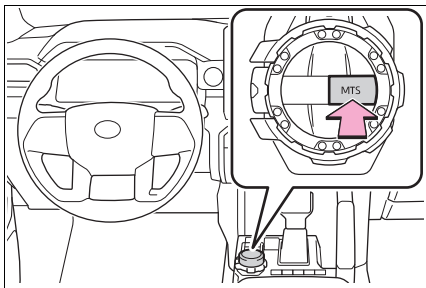



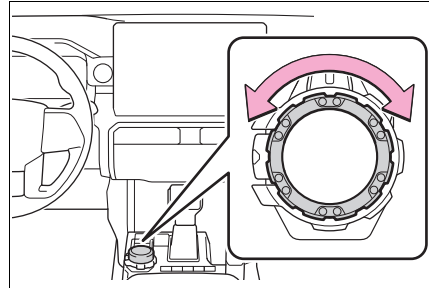

2 Select the Multi-terrain Select modes on the multi-information display while turning the mode select switch left and right.

Depending on the positions of the front-wheel drive control switch, a mode can be selected from among the following modes.







► Front-wheel drive control switch is in “4L”

Mode	Road Conditions
 “AUTO”	Suitable for the road conditions
 “SAND”	Suitable for sandy roads and other slippery conditions
 “MUD”	Suitable for muddy roads and other slippery conditions
 “ROCK”	Suitable for rocky terrain

If the brake control has activated, the slip indicator light will flash.

- ▶ Front-wheel drive control switch is in “4H”

Mode		Road Conditions
	“AUTO”	Suitable for the road conditions
	“DIRT”	Suitable for bumpy road conditions, such as dirt roads
	“SAND”	Suitable for sandy roads and other slippery conditions
	“MUD”	Suitable for muddy roads and other slippery conditions
	“DEEP SNOW”	Suitable for deep snow roads

If the brake control has activated, the slip indicator light will flash.

When the vehicle is in “SAND”, “MUD” or “DEEP SNOW” mode, VSC is automatically turned off. (VSC OFF indicator light come on.)

■ **Multi-terrain Select**

Multi-terrain Select controls the vehicle so that it can maximize the drive force and improve drivability on rough roads. As a result, fuel efficiency may diminish when compared to driving in normal mode.

■ **Automatic system cancelation**

In the following situations, Multi-terrain Select will be canceled automatically.

- When the engine switch is turned

off

- When the front-wheel drive control switch is in “2H”
- When “TOW HAUL” mode is selected while the front-wheel drive control switch is in “4H”
- When drive mode select is selected while the front-wheel drive control switch is in “4H”

■ **Turning off Multi-terrain Select**

Performing the following turns Multi-terrain Select off, and then the display on the multi-information display will disappear.

- ▶ When the “MTS” switch indicator is illuminated

Press the “MTS” switch while the system is in operation.

- ▶ When the “MTS” switch indicator is not illuminated

Press the “MTS” switch to turn the indicator on.

Press the “MTS” switch again with the Multi-terrain Select indicator illuminated.

■ **When the vehicle is stuck**

Switching the transfer and differential

For the operation of the following functions, refer to the following pages.

- Four-wheel drive system (→P.414)
- Rear differential lock system (→P.421)

■ **Driving in Multi-terrain Select**

The following types of situations may occur, but they are not malfunctions.

- Vibrations may be felt throughout the vehicle or steering wheel.
- Operating noise may be heard from the engine compartment.

■ When an inspection at your Toyota dealer is necessary

In the following situations, the system may be malfunctioning. Have the vehicle inspected by your Toyota dealer immediately.

- When the slip indicator light illuminates.
- When the indicator for each mode does not illuminate on the multi-information display even though Multi-terrain Select is selected.

Downhill assist control system*

*: If equipped

The downhill assist control system helps to prevent excessive speed on steep downhill slopes. The system will operate when the vehicle is traveling under 18 mph (30 km/h) and transfer mode is in “4H”.

⚠ WARNING

■ When using downhill assist control system

Do not rely overmuch on the downhill assist control system. This function does not extend the vehicle's performance limitations. Always thoroughly check the road conditions, and drive safely.

System components

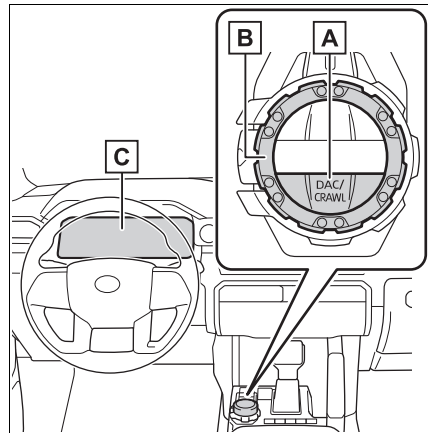

A “DAC/CRAWL” switch

B Mode select switch

C Multi-information display

System operation

Press the “DAC/CRAWL” switch.

The downhill assist control system indicator will come on and the system will operate.

When the system is in operation, the slip indicator will flash, and the stop lights/high mounted stop lights will be lit. A sound may also occur during the operation. This does not indicate a malfunction.

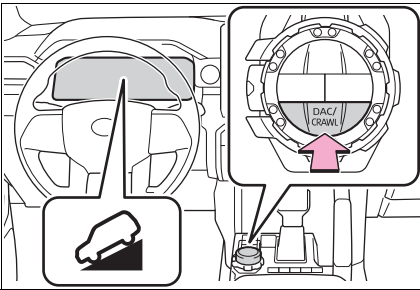

Setting the speed of the downhill assist control system

Turn the mode select switch to set the desired speed (approx. 3 mph [4 km/h] to 18 mph [30 km/h]). The set speed is displayed on the multi-information display.

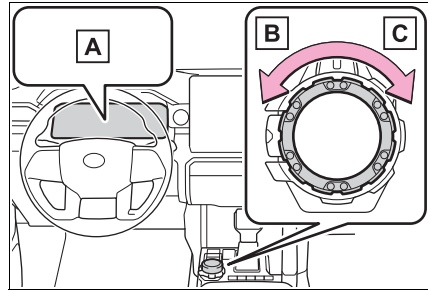

A Multi-information display

B Decreases the speed

C Increases the speed

Turning off the system

- ▶ When the “DAC/CRAWL” switch indicator illuminates

Press the “DAC/CRAWL” switch again.

- ▶ When the “DAC/CRAWL” switch indicator does not illuminate

Press the “DAC/CRAWL” switch to turn the indicator on.

Press the “DAC/CRAWL” switch again with the indicator turned on.

The downhill assist control system indicator will flash as the system gradually ceases operation, and will turn off when the system is fully off.

Press the “DAC/CRAWL” switch while the downhill assist control system indicator is flashing to start the system again.

Operating tips

- Downhill assist control system can be used with “TOW HAUL” mode

and drive mode select, or Multi-terrain Select ON or OFF.

- The system will operate when the shift lever is in a position other than P, however to make effective use of the system it is recommended to select a lower shift range.
- **If the downhill assist control system indicator flashes**
 - In the following situations, the indicator flashes and the system will not operate:
 - The front-wheel drive control switch is changed to a position other than “4H”.
 - The shift lever is in P.
 - The vehicle speed exceeds approximately 18 mph (30 km/h).
 - The brake system overheats.
 - In the following situations, the indicator flashes to alert the driver, but the system will operate:
 - The shift lever is in N.
 - The “DAC/CRAWL” switch is pressed while the “DAC/CRAWL” switch indicator illuminates.

The system will gradually cease operation. The indicator will flash during operation, and then go off when the system is fully off.

■ **When the downhill assist control system is operated continuously**

This may cause the brake actuator to overheat. In this case, the downhill assist control system will stop operating, a buzzer will sound and the downhill assist control system indicator will start flashing, and the “Traction Control Turned OFF” indicator light will come on. Refrain from using the system until the downhill assist control system indicator stays on and “Traction Control Turned OFF” indicator light turns off. (The vehicle can be driven normally during this time.)

■ **Sounds and vibrations caused by the downhill assist control system**

- A sound may be heard from the engine compartment when the engine is started or just after the vehicle begins to move. This sound does not indicate that a malfunction has occurred in downhill assist control system.
- Either of the following conditions may occur when the downhill assist control system is operating. None of these are indicators that a malfunction has occurred.
 - Vibrations may be felt through the vehicle body and steering.
 - A motor sound may be heard after the vehicle comes to a stop.

■ **System malfunction**

In the following cases, have your vehicle checked by your Toyota dealer.

- The downhill assist control system indicator does not come on when the “DAC/CRAWL” switch is pressed.
- The slip indicator light comes on.



WARNING

■ **The system may not operate on the following surfaces, which may lead to an accident causing death or serious injury**

- Slippery surfaces such as wet or muddy roads
- Icy surface
- Unpaved roads

Driving assist systems

To keep driving safety and performance, the following systems operate automatically in response to various driving situations. Be aware, however, that these systems are supplementary and should not be relied upon too heavily when operating the vehicle.

Summary of the driving assist systems

■ ABS (Anti-lock Brake System)

Helps to prevent wheel lock when the brakes are applied suddenly, or if the brakes are applied while driving on a slippery road surface, or in off-road conditions (such as rough roads, sand and mud)

The ABS operates in synchronization with the Multi-terrain Select

■ Brake assist

Generates an increased level of braking force after the brake pedal is depressed when the system detects a panic stop situation

■ VSC (Vehicle Stability Control)

Helps the driver to control skidding when swerving suddenly or

turning on slippery road surfaces.

■ Enhanced VSC (Enhanced Vehicle Stability Control)

Provides cooperative control of the ABS, TRAC, VSC and EPS.

Helps to maintain directional stability when swerving on slippery road surfaces by controlling steering performance.

■ Trailer Sway Control

Helps the driver to control trailer sway by selectively applying brake pressure for individual wheels and reducing driving torque when trailer sway is detected.

■ TRAC (Traction Control)

Helps to maintain drive power and prevent the drive wheels from spinning when starting the vehicle or accelerating on slippery roads

■ Hill-start assist control

Helps to reduce the backward movement of the vehicle when starting on an uphill

■ AVS (Adaptive Variable Suspension System) (if equipped)

The damping force of the shock absorbers are independently controlled for the 4 wheels according to factors including the road surface conditions and driving operation, contributing toward enhancing smooth driv-

ing comfort and superior stability, and helping to maintain vehicle posture.

In addition, the damping force can be changed by selecting the drive mode with the driving mode select (→P.412), and driving comfort can be ensured during off-road driving by setting the front-wheel drive control switch to “L4L”. (→P.417)

■ EPS (Electric Power Steering)

Employs an electric motor to reduce the amount of effort needed to turn the steering wheel.

■ The Secondary Collision Brake

When the SRS airbag sensor detects a collision and the system operates, the brakes and brake lights are automatically controlled to reduce the vehicle speed and help reduce the possibility of further damage due to a secondary collision.

■ When the TRAC/VSC/ABS/Trailer Sway Control systems are operating

The slip indicator light will flash while the TRAC/VSC/ABS/Trailer Sway Control systems are operating.

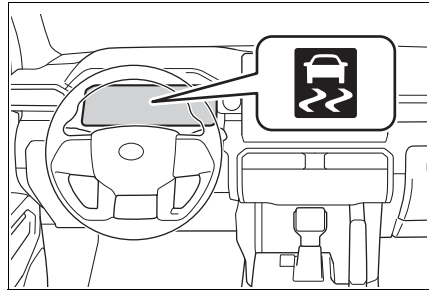

■ Disabling the TRAC system

If the vehicle gets stuck in mud, dirt or snow, the TRAC system may reduce power from the engine to the wheels. Pressing  to turn the system off may make it easier for you to rock the vehicle in order to free it.

To turn the TRAC system off, quickly press and release .

“Traction Control Turned OFF” is displayed in the multi-information display.

Press  again to turn the system back on.

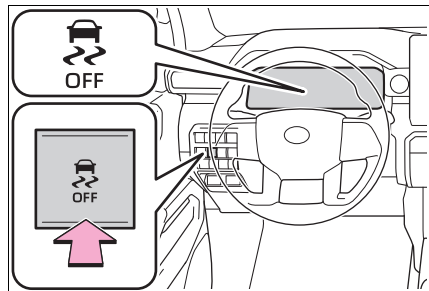

■ Turning off the TRAC/VSC/Trailer Sway Control systems

To turn the TRAC, VSC and Trailer Sway Control systems off, press and hold  for more than 3 seconds while the vehicle is stopped. The “Traction Control Turned OFF”

is displayed in the multi-information display and the VSC OFF indicator light will come on.*

Press  again to turn the system back on.

*: PCS will also be disabled (only Pre-Collision warning is available). The PCS warning light will come on and a message will be displayed on the multi-information display. (→P.578)

■ **When the message is displayed on the multi-information display showing that TRAC has been disabled even if  has not been pressed**

- TRAC is temporary deactivated. If the information continues to show, contact your Toyota dealer.
- When using Multi-terrain Select, the “VSC OFF” indicator will turn on depending on the mode, even if the VSC OFF switch has not been pressed.

■ **Operating conditions of hill-start assist control**

When the following five conditions are met, the hill-start assist control will operate:

- The shift lever is in a position other than P or N (when starting off forward/backward on an upward incline)
- The vehicle is stopped
- The accelerator pedal is not depressed
- The parking brake is not engaged
- The engine switch is turned to ON

■ **Automatic system cancelation of hill-start assist control**

The hill-start assist control will turn off in any of the following situations:

- The shift lever is shifted to P or N

- The accelerator pedal is depressed
- The parking brake is engaged
- A maximum of 2 seconds have elapsed after the brake pedal is released
- The engine switch is turned to OFF

■ **Sounds and vibrations caused by the ABS, brake assist, VSC, Trailer Sway Control, TRAC and hill-start assist control systems**

- A sound may be heard from the engine compartment when the brake pedal is depressed repeatedly, when the engine is started or just after the vehicle begins to move. This sound does not indicate that a malfunction has occurred in any of these systems.
- Any of the following conditions may occur when the above systems are operating. None of these indicates that a malfunction has occurred.
 - Vibrations may be felt through the vehicle body and steering.
 - A motor sound may be heard also after the vehicle comes to a stop.

■ **Automatic reactivation of TRAC, Trailer Sway Control and VSC systems**

After turning the TRAC, Trailer Sway Control and VSC systems off, the systems will be automatically re-enabled in the following situations:

- When the engine switch is turned off
- If only the TRAC system is turned off, the TRAC will turn on when vehicle speed increases
If both the TRAC and VSC systems are turned off, automatic re-enabling will not occur when vehicle speed increases.

■ **Reduced effectiveness of the EPS system**

The effectiveness of the EPS system is reduced to prevent the sys-

tem from overheating when there is frequent steering input over an extended period of time. The steering wheel may feel heavy as a result. Should this occur, refrain from excessive steering input or stop the vehicle and turn the engine off. The EPS system should return to normal within 10 minutes.

■ Secondary Collision Brake operating conditions

The system operates when the SRS airbag sensor detects a collision while the vehicle is in motion. However, the system does not operate when the components are damaged.

■ Secondary Collision Brake automatic cancelation

The system is automatically canceled in any of the following situations.

- The vehicle speed drops to approximately 0 mph (0 km/h).
- A certain amount of time elapses during operation
- The accelerator pedal is depressed a large amount



WARNING

■ The ABS does not operate effectively when

- The limits of tire gripping performance have been exceeded (such as excessively worn tires on a snow covered road).
- The vehicle hydroplanes while driving at high speed on wet or slick roads.

■ Stopping distance when the ABS is operating may exceed that of normal conditions

The ABS is not designed to shorten the vehicle's stopping distance. Always maintain a safe distance from the vehicle in front of you, especially in the following situations:

- When driving on dirt, gravel or snow-covered roads
- When driving with tire chains
- When driving over bumps in the road
- When driving over roads with potholes or uneven surfaces

■ TRAC/VSC may not operate effectively when

Directional control and power may not be achievable while driving on slippery road surfaces, even if the TRAC/VSC system is operating. Drive the vehicle carefully in conditions where stability and power may be lost.

■ Hill-start assist control does not operate effectively when

- Do not overly rely on hill-start assist control. Hill-start assist control may not operate effectively on steep inclines and roads covered with ice.
- Unlike the parking brake, hill-start assist control is not intended to hold the vehicle stationary for an extended period of time. Do not attempt to use hill-start assist control to hold the vehicle on an incline, as doing so may lead to an accident.

⚠ WARNING**■ When the TRAC/VSC/Trailer Sway Control is activated**

The slip indicator light flashes. Always drive carefully. Reckless driving may cause an accident. Exercise particular care when the indicator light flashes.

■ When the TRAC/VSC/Trailer Sway Control systems are turned off

Be especially careful and drive at a speed appropriate to the road conditions. As these are the systems to help ensure vehicle stability and driving force, do not turn the TRAC/VSC/Trailer Sway Control systems off unless necessary.

Trailer Sway Control is part of the VSC system and will not operate if VSC is turned off or experiences a malfunction.

■ Replacing tires

Make sure that all tires are of the specified size, brand, tread pattern and total load capacity. In addition, make sure that the tires are inflated to the recommended tire inflation pressure level.

The ABS, TRAC, Trailer Sway Control and VSC systems will not function correctly if different tires are installed on the vehicle.

Contact your Toyota dealer for further information when replacing tires or wheels.

■ Handling of tires and the suspension

Using tires with any kind of problem or modifying the suspension will affect the driving assist systems, and may cause a system to malfunction.

■ Trailer Sway Control precaution

The Trailer Sway Control system is not able to reduce trailer sway in all situations. Depending on many factors such as the conditions of the vehicle, trailer, road surface and driving environment, the Trailer Sway Control system may not be effective. Refer to your trailer owner's manual for information on how to tow your trailer properly.

■ If trailer sway occurs

Observe the following precautions.

Failing to do so may cause death or serious injury.

- Firmly grip the steering wheel. Steer straight ahead. Do not try to control trailer sway by turning the steering wheel.
- Begin releasing the accelerator pedal immediately but very gradually to reduce speed. Do not increase speed. Do not apply vehicle brakes.

If you make no extreme correction with the steering or brakes, your vehicle and trailer should stabilize. (→P.205)

■ Secondary Collision Brake

Do not rely solely upon the Secondary Collision Brake. This system is designed to help reduce the possibility of further damage due to a secondary collision, however, that effect changes according to various conditions. Overly relying on the system may result in death or serious injury.

SDM (Stabilizer with Disconnection Mechanism)*

*: If equipped

SDM (Stabilizer with Disconnection Mechanism) is a system that switches conditions of the front stabilizer to maintain vehicle stability and drivability on paved road and off-road situations.

How SDM (Stabilizer with Disconnection Mechanism) works

Depending on the switch operation or vehicle speed, the stabilizer is locked/unlocked, which results in the following effects.

■ During driving on paved roads

The stabilizer is locked and the movement of the suspensions is restrained, resulting in stable driving.

■ During off-road driving

- The stabilizer is unlocked and it becomes easier that the suspensions extend and retract, leading to improvement of drivability on rough roads
- The vibration of the vehicle body is reduced, which helps enhance riding comfort.

Turning the system on/off

Press the SDM switch

The stabilizer is unlocked and the SDM indicator will come on.

Press the switch again to lock the stabilizer (the SDM indicator will turn off).

While the stabilizer is being locked or unlocked, the SDM indicator flashes.

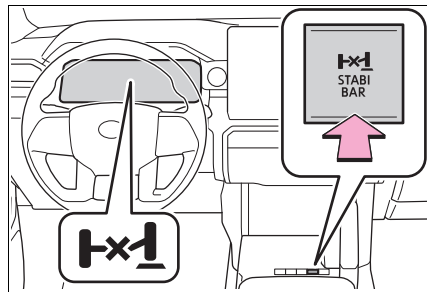

■ Operation conditions by the switch

The engine switch is in ON and the vehicle speed is approximately 18 mph (30 km/h) or less.

■ Automatic control by vehicle speed

The stabilizer will be locked again when the vehicle speed exceeds approximately 18 mph (30 km/h).

■ Operation sounds

When the stabilizer is being locked or unlocked, an operating sound may be heard from the underside of the vehicle. However, it does not indicate a malfunction.

■ When the state of the SDM indicator differs from the stabilizer status

On an uneven surface, the stabilizer status may not be switched and may differ from the state of the SDM indicator. The stabilizer status will be

switched after the vehicle is driven and the suspensions extend or retract.

■ **When the outside temperature is extremely low**

Do not use the system when the outside temperature is below -22°F (-30°C), as the system may not operate properly.

■ **After the engine switch is turned to OFF**

The stabilizer status is hold even when the engine switch is turned to OFF. To switch the status, turn the engine switch to ON again and press the SDM switch.

■ **When the stabilizer is unlocked**

When the stabilizer is unlocked, some of the Toyota Safety Sense 3.0 are not operate. (→P.256)

Trailer brake controller^{*}

*: If equipped

The trailer brakes can be controlled by the Trailer brake controller via the 7-pin connector. By selecting the type of brakes that are being used on the trailer (electric or electric-over-hydraulic) and setting the “gain” for the controller, the manual brake slider is used to slow just the trailer. The vehicle brake pedal will also slow down as well as stop the trailer when applied, also via the same connector. “Gain” values, manual brake outputs, trailer brake types, and the trailer connection status are displayed in the multi-information display.

This vehicle comes equipped with a Toyota Genuine Trailer Brake Controller. Use of a third-party trailer brake controller along with the Toyota Genuine Trailer Brake Controller may have unexpected effects on the system. Toyota does not recommend the use of a third-party brake controller with this vehicle.

**WARNING**

■ **When driving on slippery road surfaces**

When stopping with ABS activated, output to the trailer might be reduced in order to reduce the likelihood of trailer wheels to lock. The trailer is not equipped with ABS. Drive safely on slippery road surfaces.

System operation

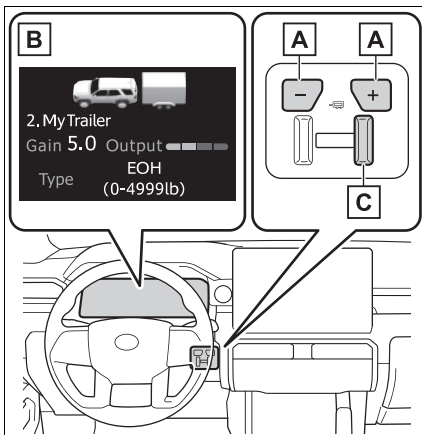

A “GAIN” (+/-) selection button

Pressing the “GAIN” (+/-) buttons will adjust the amount of power that can be outputted to the trailer brakes. The “gain” can be adjusted from 0 (no trailer braking) to 10 (maximum output) in 0.5 increments. Each press of the button will increase or decrease the “gain” setting by one step. The “gain” value will appear in the multi-information display.

B Trailer brake type

Trailer brake type can be selected by using the multi-information. The combination meter will show which

trailer brake type is selected in the multi-information display.

C Manual brake slider

Adjusting this slider position will engage the trailer’s brakes only. If the manual brake slider is used while the vehicle brake is applied, the greater of the two outputs will be sent to the trailer brakes.

Changing settings of the trailer brake type

Select the item desired to be setup and select as follows on the multi-information screen (→P.96, 105):

- 1 Vehicles with 7-inch display:
Press **<** or **>** on the meter control switch and then select .

Vehicles with 12.3-inch display:

Press and hold **OK** to display the cursor on the content display area (center) of the multi-information display.

- 2 Press **^** or **v** on the meter control switch, select “Trailer Settings”, and then press and hold **OK** on the meter control switch.

- 3 According to the display, select the desired setting and then press **OK**.

Changing trailer brake type or trailer ID will cause the current

“gain” setting to reset to zero. Make sure to set the “gain” as described in the following section.

Setting the “Gain”

“Gain” setting on trailer brake controller should be set for a specific towing condition. “Gain” setting should be adjusted each time the vehicle load, trailer load, road conditions, or weather changes. Setting the “gain” value to 0 will disable the trailer brake controller output.

- 1 Make sure the trailer brakes are in good working condition and functioning normally. See trailer dealer if necessary.
- 2 Hook up the trailer and make proper electrical connections.
- 3 Select the correct type of trailer brakes that are equipped on the trailer by using the multi-information display.
- 4 Drive vehicle with trailer attached on a level road surface similar to towing condition and in traffic-free environment. Driving speed should be approximately 20 - 25 mph [35 - 40 km/h].

- 5 Using the “GAIN” (+/-) selection buttons, set a starting “gain” of 5.0.

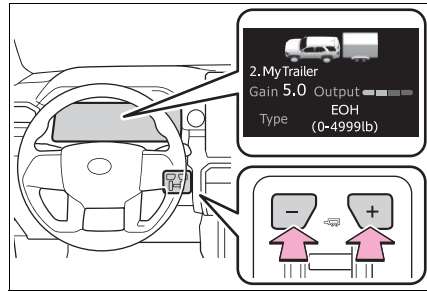

- 6 While driving 20 - 25 mph [35 - 40 km/h], fully apply the manual brake slider.
- 7 Adjust the “gain” setting, using the “GAIN” (+/-) selection buttons, to either increase or decrease to just below the point of trailer wheel lock-up.
- 8 For confirmation, repeat steps 6 and 7 until desired “gain” setting is reached (just below point of trailer wheel lock-up).

■ When setting the “gain”

Wheel lock-up occurs when the trailer wheel squeals or tire smoke occurs. Trailer wheels may not lock-up while driving heavily loaded trailer. During this case, adjust the Trailer “gain” to the highest allowable setting for the towing condition.

■ When disconnecting and reconnecting battery terminals

The “gain” setting data will be reset.

■ Trailer Sway Control Function

Helps suppress trailer sway at an early stage by using the trailer brake control system to operate the trailer

brakes.

■ **If the Trailer brake warning light comes on**

Indicates a malfunction in the Trailer brake control system or Trailer connector circuit.

Have the vehicle inspected by your Toyota dealer immediately.

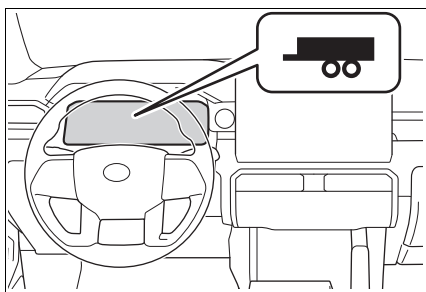

⚠ WARNING

■ **Trailer brake type setting**

It is the responsibility of the driver to make sure the trailer brakes are functioning normally and adjusted appropriately. Failure to check and maintain trailer brakes may result in loss of vehicle control, crash, or serious injury.

Trailer brake control system will work with most electric and electric-overhydraulic trailer braking systems up to 3 axles (24A output to trailer brakes). Please be sure to test compatibility with the system at low speeds and in a safe area. If a warning message appears in the multi-information display (→P.587), have the vehicle inspected by your Toyota dealer immediately. Some electric-over-hydraulic trailer brakes will take some minimum output to activate. Trailer brake control system will not work with trailer hydraulic surge brakes.

Trailer Backup Guide*

*: If equipped

Trailer Backup Guide is a system to assist when backing up a trailer by providing either (1) steering control to assist backing up straight (Straight Path Assist) or (2) guidance for manual steering backup (Guidance mode).

Trailer Backup Guide uses the rear camera to detect the trailer and a trailer hitch light, which allows the driver to use the system at night time.

The system calculates the trailer angle by image processing from the rear camera and calculates trailer length and hitch length during the trailer setup (calibration) maneuver.

Procedure

- 1 Select "Trailer Settings" on the multi-information display and add a trailer according to the display. (→P.96, 105)

- 2 Press the switch to turn the system ON.

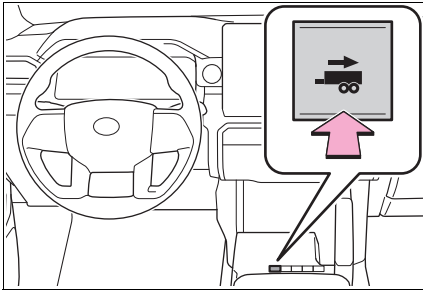

- 3 Continue or reselect the trailer in the message displayed on the multi-information display.

When the selected trailer is being used for the first time, setup (calibration) is necessary (→P.441).

Once calibration is completed, it is retained for future use and the system will automatically detect the trailer.

The driver needs to change the trailer selection when using a different trailer. The system does not automatically recognize the trailer from the saved trailers list.

- 4 Once trailer is detected, shift the shift lever to R to activate Guidance mode.
- 5 Touch the switch at the bottom right on multimedia to activate Straight Path Assist.

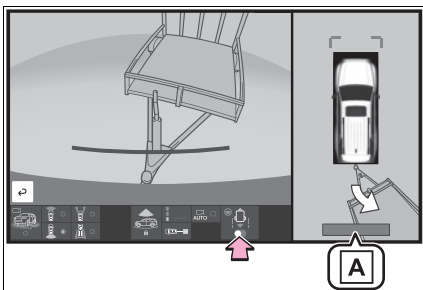

A “Trailer Direction”

When using Straight Path Assist, the driver can override the system using the steering wheel to adjust the trailer direction. Upon release of the steering wheel, Straight Path Assist re-activates with a revised straight back target direction.

■ When adding the trailer

Select “Trailer Settings” on the multi-information display and add a trailer according to the display. (→P.96, 105)

Trailer Settings are not available while Trailer Backup Guide system is active.

The system is designed to support trailers with single or multi-axles using a ball hitch. The system does not support fifth wheel or gooseneck trailers.

Setup (Calibration)

Bring the vehicle and trailer to a large open space like an empty parking lot. Activate Trailer Backup Guide system and follow the instructions displayed on the multi-information display/multimedia.

For best calibration results, do not exceed 5 mph (8 km/h).

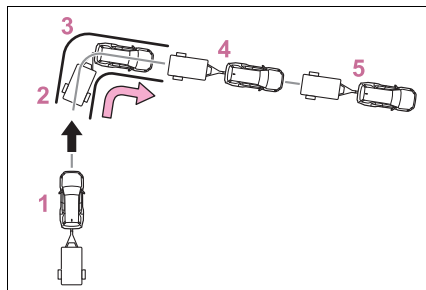

- 1 Drive straight forward slowly

(5 mph [8 km/h] or less) while holding the steering wheel straight.

- 2 Stop vehicle with trailer straight and confirm blue line is aligned with trailer center in Camera view.
- 3 Drive forward slowly making a left or right turn that changes vehicle direction 90 degrees or more.
- 4 After completing the turn, continue straight forward slowly to align trailer.
- 5 Stop vehicle to complete calibration.

■ When calibrating the system

- Please check whether the blue line appropriately aligns with the center of the trailer in the camera view, such as in the following diagram, with regards to procedure 2.

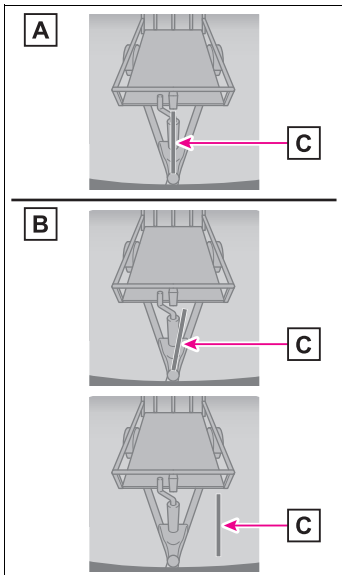

A State where the blue line aligns with the center of the trailer. (Select “Yes” in the multi-information display)

B State where the blue line does not align with the center of the trailer. (Select “No” in the multi-information display)

C Blue line

- The system is designed to support most trailers 6.6 ft. (2 m) to 26.2 ft. (8 m) in length (length is defined from the coupler center point for the ball to the wheel axle [single axle] or center of the wheel axles [2 or more axles]) with ball mount lengths between 4.5 in. (114.3 mm) and 18.5 in. (469.9 mm). Do not attempt to use trailers or ball mounts that have a length outside of this range as the system performance degrades and could cause improper system function.

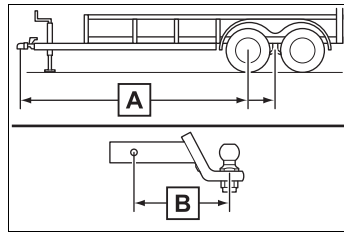

A Trailer length

B Ball mount length

- For best calibration results, calibrate in daytime on a smooth and level road.
- It may be necessary at times to recalibrate the trailer to improve performance.
- The system is designed to be used with the same trailer connection every time. If the ball mount position is changed or reconfigured or items are added to the

trailer tongue after calibration, re-calibration may be required.

Using Guidance mode

Guidance mode provides a “Trailer Direction” arrow that indicates the direction the trailer will swing, based on calculations from the steering wheel angle information. Guidance mode provides a “BRAKE Extreme Trailer Angle” (jackknife) warning with warning buzzer to alert the driver that the trailer angle is near the jackknife condition.

Using Straight Path Assist

Touch the switch at the bottom right on multimedia to activate Straight Path Assist. Straight Path Assist controls steering to back up the trailer in a straight-line. The system can be overridden by using steering wheel to adjust trailer direction.

The driver is always responsible for paying attention to the vehicle’s surroundings and driving safely. This system does not control braking. Driver needs to control vehicle speed, control braking, and stop the vehicle to avoid any collision.

For best results, reverse slowly when using Straight Path Assist.

Canceling the system

- Trailer Backup Guide system is canceled when the trailer cannot be detected (e.g. dirty camera lens, insufficient lighting condition, obstruction of the trailer in the rear camera view, incorrectly selected trailer, etc.)
- Guidance mode is canceled when any of the following occurs:
 - Press the Trailer Backup Guide switch*
 - Press the Camera switch*
 - Vehicle speed is greater than approximately 4.7 mph (7.6 km/h)
 - VSC or ABS is operated*
 - Back door is opened*
 - Trailer tracking is lost
 - Shift the shift lever out of R
 - There is a system malfunction*
- *: Includes Trailer Backup Guide system cancel
- Straight Path Assist is canceled when any of the following occurs:
 - Any of the events, above, that cancel Guidance mode occur
 - Press the Straight Path Assist switch on the multimedia screen
 - The system temperature preservation function operates (to prevent power steering equipment from overheating)

Trailer hitch light

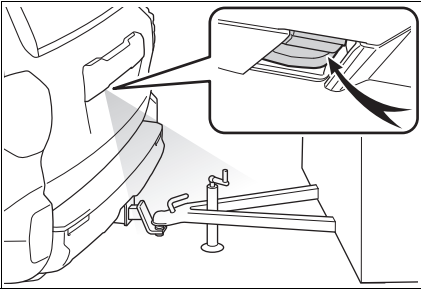

This light's usage for Trailer Backup Guide is controlled by the Trailer Backup Guide system and the driver does not need to activate the light separately.

For other usage: →P.470

⚠ WARNING

■ **Cautions regarding the use of the system**

In order for this system to perform as designed, the vehicle must be driven safely and the driver must control the speed to keep it within operating parameters and to avoid a collision.

As there is a limit to the degree of control performance that this system can provide, do not overly rely on this system. The driver is always responsible for paying attention to the vehicle's surroundings and driving safely. This system does not control braking (or steering when in Guidance mode). Driver needs to control vehicle speed, control braking, (and steering when in Guidance mode,) and stop the vehicle to avoid any collision. Failure to follow this warning could result in property damage, serious injury or death.

■ **When using the Trailer Backup Guide**

For proper system performance, observe the following precautions. Failure to do so may lead to an accident resulting in property damage, serious injury, or death.

- Keep the back door fully latched.
- Keep the rear camera clean at all times.
- Do not change the installation position or direction of the rear camera or remove it.
- Do not modify the trailer hitch light. (→P.444)
- Make sure nothing can obstruct the rear camera view of the trailer.

The system is designed to operate in various weather and lighting conditions and on different ground surfaces (asphalt, grass, gravel, etc.), however performance can still be affected by various environmental factors (e.g. shadow passing over the trailer or diminished contrast between trailer and the ground leading to trailer detection being lost, etc.) so always drive carefully, remain alert and aware of your surroundings, and do not overly rely on the system.

Off-road precautions

This vehicle belongs to the utility vehicle class, which has higher ground clearance and narrower tread in relation to the height of its center of gravity to make it capable of performing in a wide variety of off-road applications.

Off-road vehicle features

- Specific design characteristics give it a higher center of gravity than ordinary passenger cars. This vehicle design feature causes this type of vehicle to be more likely to rollover. And, Utility vehicles have a significantly higher rollover rate than other types of vehicles.
- An advantage of the higher ground clearance is a better view of the road allowing you to anticipate problems.
- It is not designed for cornering at the same speeds as ordinary passenger cars any more than low-slung sports cars are designed to perform satisfactorily under off-road conditions. Therefore, sharp turns at excessive speeds may cause the vehicle to roll over.



WARNING

Off-road vehicle precautions

Always observe the following precautions to minimize the risk of death, serious injury or damage to your vehicle:

- In a rollover crash, an unbelted person is significantly more likely to die than a person wearing a seat belt. Therefore, the driver and all passengers should always fasten their seat belts.
- Avoid sharp turns or abrupt maneuvers, if at all possible. Failure to operate this vehicle correctly may result in loss of control or vehicle rollover causing death or serious injury.
- Loading cargo on the roof luggage carrier (if equipped) will make the center of the vehicle gravity higher. Avoid high speeds, sudden starts, sharp turns, sudden braking or abrupt maneuvers, otherwise it may result in loss of control or vehicle rollover due to failure to operate this vehicle correctly.
- Always slow down in gusty crosswinds. Because of its profile and higher center of gravity, your vehicle is more sensitive to side winds than an ordinary passenger car. Slowing down will allow you to have better control.
- Do not drive horizontally across steep slopes. Driving straight up or straight down is preferred. Your vehicle (or any similar off-road vehicle) can tip over sideways much more easily than forward or backward.

Off-road driving

When driving your vehicle off-road, please observe the following precautions to ensure your driving enjoyment and to help prevent the closure of areas to off-road vehicles:

- Drive your vehicle only in areas where off-road vehicles are permitted to travel.
- Respect private property. Get owner's permission before entering private property.
- Do not enter areas that are closed. Honor gates, barriers and signs that restrict travel.
- Stay on established roads. When conditions are wet, driving techniques should be changed or travel delayed to prevent damage to roads.

■ Additional information for off-road driving

- ▶ For owners in U.S. mainland, Hawaii and Puerto Rico:

To obtain additional information pertaining to driving your vehicle off-road, consult the following organizations.

- State and Local Parks and Recreation Departments
- State Motor Vehicle Bureau
- Recreational Vehicle Clubs
- U.S. Forest Service and Bureau of Land Management

WARNING

■ Off-road driving precautions

Always observe the following precautions to minimize the risk of death, serious injury or damage to your vehicle:

- Drive carefully when off the road. Do not take unnecessary risks by driving in dangerous places.
- Do not grip the steering wheel spokes when driving off-road. A bad bump could jerk the wheel and injure your hands. Keep both hands and especially your thumbs on the outside of the rim.
- Always check your brakes for effectiveness immediately after driving in sand, mud, water or snow.
- After driving through tall grass, mud, rock, sand, rivers, etc., check that there is no grass, bush, paper, rags, stone, sand, etc. adhering or trapped on the underbody. Clear off any such matter from the underbody. If the vehicle is used with these materials trapped or adhering to the underbody, a breakdown or fire could occur.
- In a rollover crash, an unbelted person is significantly more likely to die than a person wearing a seat belt. Therefore, the driver and all passengers should fasten their seat belts whenever the vehicle is moving.

**WARNING**

- When driving off-road or in rugged terrain, do not drive at excessive speeds, jump, make sharp turns, strike objects, etc. This may cause loss of control or vehicle rollover causing death or serious injury. You are also risking expensive damage to your vehicle's suspension and chassis.

**NOTICE****■ To prevent water damage**

Take all necessary safety measures to ensure that water damage to the engine or other components does not occur.

- Water entering the engine air intake will cause severe engine damage.
- Water entering the automatic transmission will cause deterioration in shift quality, locking up of your transmission accompanied by vibration, and ultimately damage.
- Water can wash the grease from wheel bearings, causing rusting and premature failure, and may also enter the differentials, transmission and transfer case, reducing the gear oil's lubricating qualities.

■ When you drive through water

If driving through water, such as when crossing shallow streams, first check the depth of the water and the bottom of the riverbed for firmness. Press the Stop & Start cancel switch to disable the Stop & Start system. (vehicles with Stop & Start system) Drive slowly and avoid deep water.

■ Inspection after off-road driving

- Sand and mud that has accumulated around brake discs may affect braking efficiency and may damage brake system components.
- Always perform a maintenance inspection after each day of off-road driving that has taken you through rough terrain, sand, mud, or water. For scheduled maintenance information, refer to the "Scheduled Maintenance Guide" or "Owner's Manual Supplement".

Winter driving tips

Carry out the necessary preparations and inspections before driving the vehicle in winter. Always drive the vehicle in a manner appropriate to the prevailing weather conditions.

Preparation for winter

- Use fluids that are appropriate to the prevailing outside temperatures.
- Engine oil
- Engine/power control unit coolant
- Washer fluid
- Have a service technician inspect the condition of the battery.
- Have the vehicle fitted with four snow tires or purchase a set of tire chains for the rear tires*.

*: Tire chains cannot be mounted on 265/70R18 tires.

Ensure that all tires are the same size and brand, and that chains match the size of the tires.



WARNING

■ Driving with snow tires

Observe the following precautions to reduce the risk of accidents. Failure to do so may result in a loss of vehicle control and cause death or serious injury.

- Use tires of the specified size.

- Maintain the recommended level of air pressure.
- Do not drive in excess of 75 mph (120 km/h), regardless of the type of snow tires being used.
- Use snow tires on all, not just some wheels.
- 4WD models: Do not mix tires of different makes, models, tread patterns or treadwear.
- **Driving with tire chains (vehicles without 265/70R18 tires)**
Observe the following precautions to reduce the risk of accidents. Failure to do so may result in the vehicle being unable to be driven safely, and may cause death or serious injury.
- Do not drive in excess of the speed limit specified for the tire chains being used, or 30 mph (50 km/h), whichever is lower.
- Avoid driving on bumpy road surfaces or over potholes.
- Avoid sudden acceleration, abrupt steering, sudden braking and shifting operations that cause sudden engine braking.
- Slow down sufficiently before entering a curve to ensure that vehicle control is maintained.
- Do not use LTA (Lane Tracing Assist) system.



NOTICE

■ Repairing or replacing snow tires

Request repairs or replacement of snow tires from Toyota dealers or legitimate tire retailers.

This is because the removal and attachment of snow tires affects the operation of the tire pressure warning valves and transmitters.

Before driving the vehicle

Perform the following according to the driving conditions:

- Do not try to forcibly open a window or move a wiper that is frozen. Pour warm water over the frozen area to melt the ice. Wipe away the water immediately to prevent it from freezing.
- To ensure proper operation of the climate control system fan, remove any snow that has accumulated on the air inlet vents in front of the windshield.
- Check for and remove any excess ice or snow that may have accumulated on the exterior lights, outside rear view mirrors, windows, vehicle's roof, chassis, around the tires or on the brakes.
- Remove any snow or mud from the bottom of your shoes before getting in the vehicle.

When driving the vehicle

Accelerate the vehicle slowly, keep a safe distance between you and the vehicle ahead, and drive at a reduced speed suitable to road conditions.

When parking the vehicle

- Turn automatic mode of the parking brake off. Otherwise, the parking brake may freeze and not be able to be released automatically. Also, avoid using the following as the parking brake may operate automatically, even if automatic mode is off.
 - Brake hold system
- Park the vehicle and move the shift lever to P without setting the parking brake. The parking brake may freeze up, preventing it from being released. If the vehicle is parked without setting the parking brake, make sure to block the wheels. Failure to do so may be dangerous because it may cause the vehicle to move unexpectedly, possibly leading to an accident.
- When the parking brake is in automatic mode, release the parking brake after shifting the shift lever to P. (→P.223)
- If the vehicle is parked without

setting the parking brake, confirm that the shift lever cannot be moved out of P.

- If the vehicle is left parked with the brakes damp in cold temperatures, there is a possibility of the brakes freezing.

⚠ WARNING

■ When parking the vehicle

When parking the vehicle without applying the parking brake, make sure to chock the wheels. If you do not chock the wheels, the vehicle may move unexpectedly, possibly resulting in an accident.

Selecting tire chains

- ▶ Vehicles without 265/70R18 tires

Use the correct tire chain size when mounting the tire chains. Chain size is regulated for each tire size.

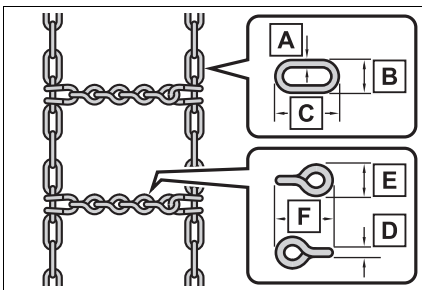

Side chain:

- A** 0.20 in. (5 mm) in diameter
- B** 0.71 in. (18 mm) in width
- C** 1.81 in. (46 mm) in length

Cross chain:

- D** 0.25 in. (6.3 mm) in diameter
- E** 0.89 in. (22.6 mm) in width
- F** 1.50 in. (38.1 mm) in length

▶ Vehicles with 265/70R18 tires
Tire chains cannot be mounted as the space between the tire and body is too narrow.

Snow tires should be used instead.

Regulations on the use of tire chains (vehicles without 265/70R18 tires)

Regulations regarding the use of tire chains vary depending on location and type of road. Always check local regulations before installing chains.

■ Tire chain installation

Observe the following precautions when installing and removing chains:

- Install and remove tire chains in a safe location.
- Install tire chains on the rear tires. Do not install tire chains on the front tires.
- Install tire chains on the rear tires as tightly as possible. Retighten chains after driving 1/4—1/2 mile (0.5—1.0 km).
- Install tire chains following the instructions provided with the tire chains.

**NOTICE****■ Fitting tire chains**

The tire pressure warning valves and transmitters may not function correctly when tire chains are fitted.

5-1. Using the air conditioning system and defogger

Manual air conditioning system 454

Automatic air conditioning system..... 460

Heated steering wheel/seat heaters/seat ventilators 467

5-2. Using the interior lights

Interior lights list 469

5-3. Using the storage features

List of storage features 472

Luggage compartment features 478

5-4. Using the other interior features

Other interior features . 480

Removable speaker 496

Garage door opener.... 504

Manual air conditioning system*

*: If equipped

Air conditioning controls

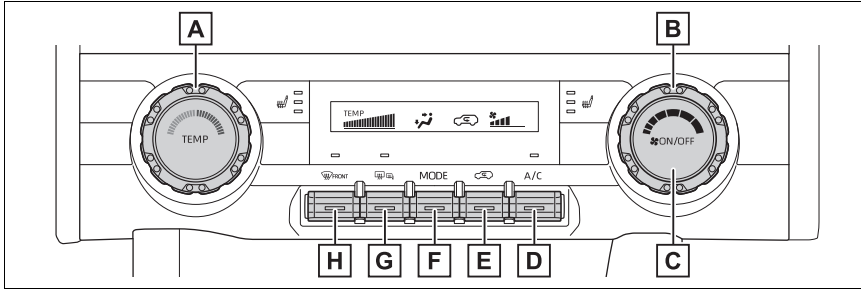

A Temperature control dial

B Fan speed control dial

C “ON/OFF” switch

D “A/C” switch

E Outside/recirculated air mode switch

F Airflow mode control switch

G Rear window defogger and outside rear view mirror defoggers switch

H Windshield defogger switch

■ Adjusting the temperature setting

To adjust the temperature setting, turn the temperature control dial clockwise (warm) or counterclockwise (cool).

If “A/C” switch is not pressed, the system will blow ambient temperature air or heated air.

■ Fan speed setting

To adjust the fan speed, turn the fan speed control dial clockwise

(increase) or counterclockwise (decrease).

Press the “ON/OFF” switch to turn the fan off.

■ Change the airflow mode

Operate the air flow mode control switch

The airflow mode changes as follows each time the switch is operate.

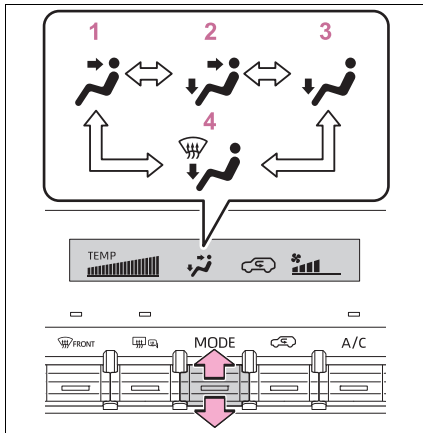

- 1 Upper body
- 2 Upper body and feet
- 3 Feet
- 4 Feet and the windshield defogger operates

■ Switching between outside air and recirculated air modes

Press the outside/recirculated air mode switch.

The mode switches between outside air mode (the indicator is off) and recirculated air mode (the indicator is on) each time the switch is pressed.

■ Set cooling and dehumidification function

Press the "A/C" switch.

When the function is on, the indicator illuminates on the "A/C" switch.

■ Defogging the windshield

Defoggers are used to defog the windshield and front side windows.

Press the windshield defogger

switch.

Set the outside/recirculated air mode switch to outside air mode if the recirculated air mode is used.

To defog the windshield and the side windows quickly, turn the air flow and temperature up.

To return to the previous mode, press the windshield defogger switch again when the windshield is defogged.

When the windshield defogger switch is on, the indicator illuminates on the windshield defogger switch.

■ Defogging the rear window and outside rear view mirrors

Defoggers are used to defog the rear window, and to remove raindrops, dew and frost from the outside rear view mirrors.

Press the rear window and outside rear view mirror defoggers switch.

The defoggers will automatically turn off after 15 minutes. (Depending on the surrounding environment and outside temperature, the defogger may continue to operate after 15 minutes have elapsed.)

When the rear window and outside rear view mirror defoggers switch is on, the indicator illuminates on the rear window and outside rear view mirror defoggers switch.

■ **When the outside temperature exceeds 75°F (24°C) and the air conditioning system is on**

- In order to reduce the air conditioning power consumption, the air conditioning system may switch to recirculated air mode automatically. This may also reduce fuel consumption.
- Recirculated air mode is selected as a default mode when the engine switch is turned to ON. It is possible to switch to outside air mode at any time by pressing the outside/recirculated air mode switch.

■ **Fogging up of the windows**

- The windows will easily fog up when the humidity in the vehicle is high. Turning “A/C” switch is on will dehumidify the air from the outlets and defog the windshield effectively.
- If you turn “A/C” switch is off, the windows may fog up more easily.
- The windows may fog up if the recirculated air mode is used.

■ **When driving on dusty roads**

Close all windows. If dust thrown up by the vehicle is still drawn into the vehicle after closing the windows, it is recommended that the air intake mode be set to outside air mode and the fan speed to any setting except off.

■ **Outside/recirculated air mode**

- Setting to the recirculated air mode temporarily is recommended in preventing dirty air from entering the vehicle interior and helping to cool the vehicle when the outside air temperature is high.
- During cooling operation, setting the recirculated air mode will also cool the vehicle interior effectively.

■ **When the outside temperature falls to nearly 32°F (0°C)**

The dehumidification function may not operate even when “A/C” switch is pressed.

■ **Ventilation and air conditioning odors**

- To let fresh air in, set the air conditioning system to the outside air mode.
- During use, various odors from inside and outside the vehicle may enter into and accumulate in the air conditioning system. This may then cause odor to be emitted from the vents.
- To reduce potential odors from occurring:

It is recommended that the air conditioning system be set to outside air mode prior to turning the vehicle off.

■ **Air conditioning filter**



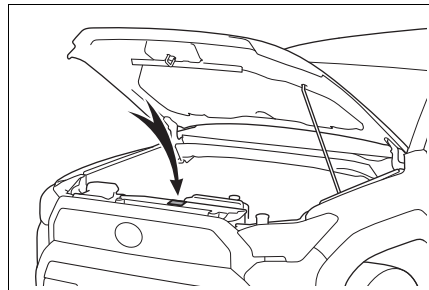

→P.557

■ **Air conditioning system refrigerant**

- A label regarding the refrigerant of the air conditioning system is attached to the hood at the location shown in the following illustration.



- The meaning of each symbol on the label are as follows:

	Caution
	Air conditioning system
	Air conditioning system lubricant type
	Requires registered technician to service air conditioning system
	Flammable refrigerant

⚠ WARNING

■ **To prevent the windshield from fogging up**
 Do not use the windshield defogger switch during cool air operation in extremely humid weather. The difference between the temperature of the outside air and that of the windshield can cause the outer surface of the windshield to fog up, blocking your vision.

■ **When the outside rear view mirror defoggers are operating**
 Do not touch the outside rear view mirror surfaces, as they can become very hot and burn you.

⚠ NOTICE

■ **To prevent battery discharge**
 Do not leave the air conditioning system on longer than necessary when the engine is off.

Windshield wiper de-icer

This feature is used to prevent ice from building up on the windshield and wiper blades.

Press the rear window and outside rear view mirror defoggers switch.

The windshield wiper de-icer will automatically turn off after 15 minutes.

Turning the rear window and outside rear view mirror defoggers on will turn the windshield wiper deicer on.

When the rear window and outside rear view mirror defoggers switch is on, the indicator illuminates on the rear window and outside rear view mirror defoggers switch.

⚠ WARNING

■ **To prevent burns**
 Do not touch the glass at lower part of the windshield or to the side of the front pillars when the windshield wiper deicer is on.

Air outlet layout and operations

■ **Location of air outlets**

The air outlets and air volume changes according to the selected air flow mode.

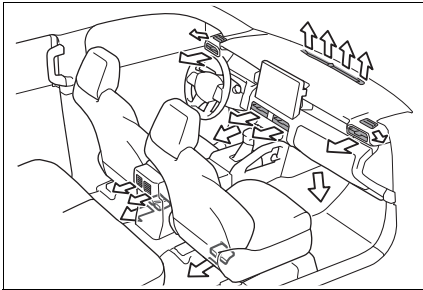

■ **Adjusting the air flow direction**

▶ **Front**

Direct air flow to the left or right, up or down

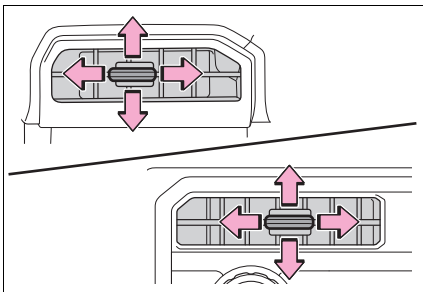

▶ **Rear**

Direct air flow to the left or right, up or down

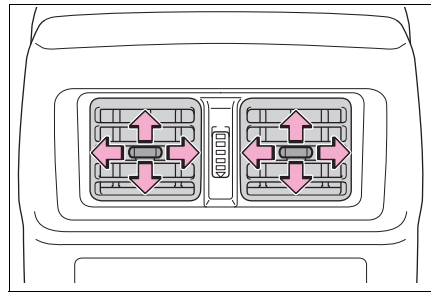

■ **Opening/closing the air outlets**

▶ **Front side**

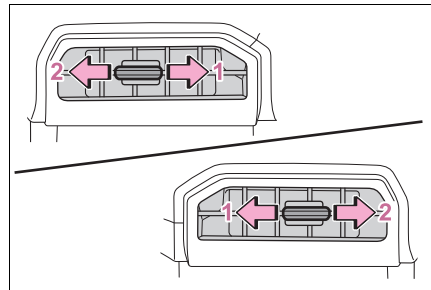

- 1 Open the vent
- 2 Close the vent

▶ **Front center**

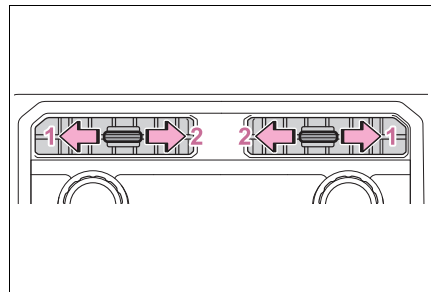

- 1 Open the vent
- 2 Close the vent

► Rear

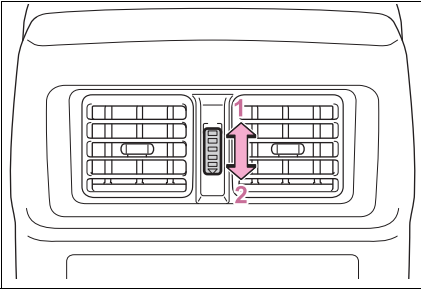

- 1 Open the vent
- 2 Close the vent

⚠ WARNING**■ To not interrupt the windshield defogger from operating**

Do not place anything on the instrument panel which may cover the air outlets. Otherwise, air flow may be obstructed, preventing the windshield defoggers from defogging.

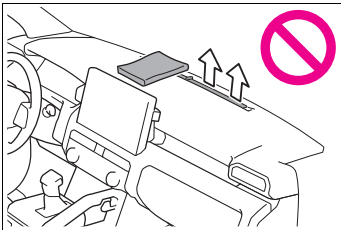

Automatic air conditioning system*

*: If equipped

Air outlets and fan speed are automatically adjusted according to the temperature setting.

Air conditioning controls

▶ Vehicles with the DUAL mode

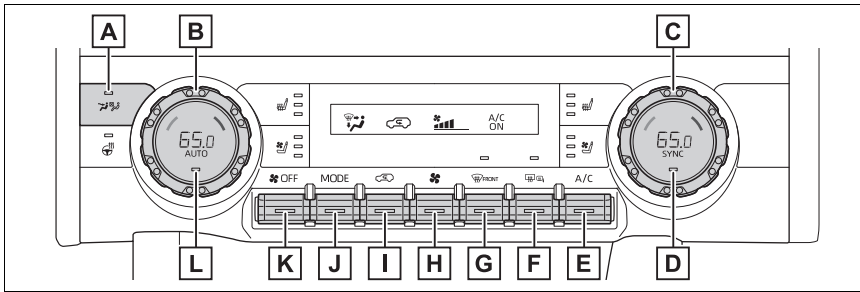

▶ Vehicles without the DUAL mode

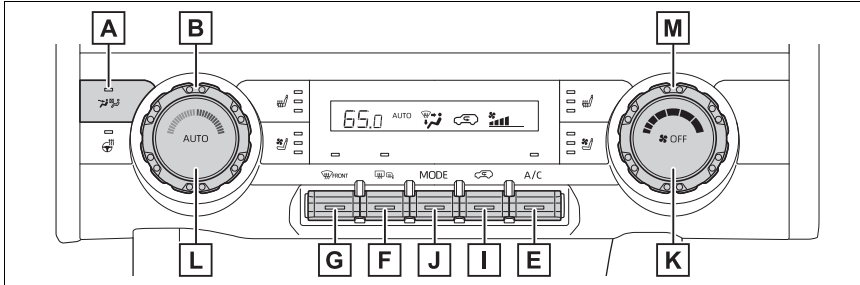

- A** “S-FLOW” switch
- B** Left-hand side temperature control dial
- C** Right-hand side temperature control dial
- D** “SYNC” switch (if equipped)
- E** “A/C” switch
- F** Rear window defogger and outside rear view mirror defoggers switch
- G** Windshield defogger switch

- H** Fan speed control switch
- I** Outside/recirculated air mode switch
- J** Air flow mode control switch
- K** “OFF” switch
- L** “AUTO” switch
- M** Fan speed control dial

■ Adjusting the temperature setting

To adjust the temperature setting, turn the temperature control dial clockwise (warm) or counterclockwise (cool).

If the “A/C” switch is not pressed, the system will blow ambient temperature air or heated air.

■ Setting the fan speed

▶ Vehicles with the DUAL mode

Operate the fan speed control switch upwards to increase the fan speed and downwards to decrease the fan speed.

Press the “OFF” switch to turn the fan off.

▶ Vehicles without the DUAL mode

To adjust the fan speed, turn the fan speed control dial clockwise (increase) or counterclockwise (decrease).

Press the “OFF” switch to turn the fan off.

■ Change the airflow mode

Operate the air flow mode control switch

The airflow mode changes as follows each time the switch is operate.

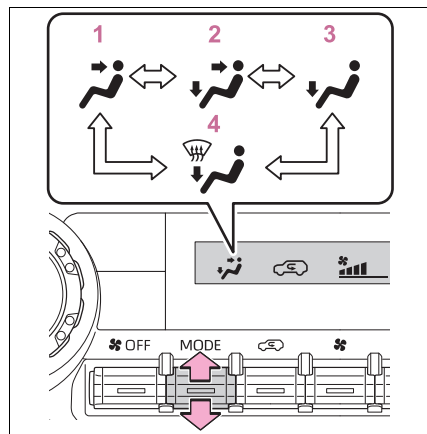

- 1 Air flows to the upper body.
- 2 Air flows to the upper body and feet.
- 3 Air flows to the feet.
- 4 Air flows to the feet and the windshield defogger operates.

■ Switching between outside air and recirculated air modes

Press the outside/recirculated air mode switch.

The mode switches between outside air mode (the indicator is off) and recirculated air mode (the indi-

cator is on) each time the switch is pressed.

■ Set cooling and dehumidification function

Press the “A/C” switch.

Vehicles with the DUAL mode:
When the function is on, “A/C ON” indicator will illuminate. When the function is off, “A/C OFF” indicator will illuminate.

Vehicles without the DUAL mode:
When the function is on, the indicator on the “A/C” switch illuminates.

■ Defogging the windshield

Defoggers are used to defog the windshield and front side windows.

Press the windshield defogger switch.

Press the outside/recirculated air mode switch if the recirculated air mode is used. (It may switch automatically.)

To defog the windshield and the side windows quickly, turn the air flow and temperature up.

To return to the previous mode, press the windshield defogger switch again when the windshield is defogged.

When the windshield defogger switch is on, the indicator illuminates on the windshield defogger switch.

■ Defogging the rear window and outside rear view mirrors

Defoggers are used to defog the rear window and to remove rain-

drops, dew and frost from the outside rear view mirrors.

Press the rear window and outside rear view mirror defoggers switch.

The defoggers will automatically turn off after 15 minutes. (Depending on the surrounding environment and outside temperature, the defogger may continue to operate after 15 minutes have elapsed.)

When the rear window and outside rear view mirror defoggers switch is on, the indicator illuminates on the rear window and outside rear view mirror defoggers switch.

■ When the outside temperature exceeds 75°F (24°C) and the air conditioning system is on

- In order to reduce the air conditioning power consumption, the air conditioning system may switch to recirculated air mode automatically.

This may also reduce fuel consumption.

- Recirculated air mode is selected as a default mode when the engine switch is turned to ON.

It is possible to switch to outside air mode at any time by pressing the outside/recirculated air mode switch.

■ Fogging up of the windows

- The windows will easily fog up when the humidity in the vehicle is high. Turning the cooling and dehumidification function on will dehumidify the air from the outlets and defog the windshield effectively.

- If you turn the cooling and dehumidification function off, the windows may fog up more easily.

- The windows may fog up if the

recirculated air mode is used.

■ When driving on dusty roads

Close all windows. If dust thrown up by the vehicle is still drawn into the vehicle after closing the windows, it is recommended that the air intake mode be set to outside air mode and the fan speed to any setting except off.

■ Outside/recirculated air mode

- Setting to the recirculated air mode temporarily is recommended in preventing dirty air from entering the vehicle interior and helping to cool the vehicle when the outside air temperature is high.
- Outside/recirculated air mode may automatically switch depending on the temperature setting or the inside temperature.

■ When the outside temperature falls to nearly 32°F (0°C)

The dehumidification function may not operate even when "A/C" switch is pressed.

■ Ventilation and air conditioning odors

- To let fresh air in, set the air conditioning system to the outside air mode.
- During use, various odors from inside and outside the vehicle may enter into and accumulate in the air conditioning system. This may then cause odor to be emitted from the vents.
- In order to suppress odors that occur when the air conditioning system starts, the air flow mode may change to blow air to the feet or air may stop blowing for a short period of time immediately after the air conditioning system is started in automatic mode.
- When parking, the system automatically switches to outside air mode to encourage better air circulation throughout the vehicle,

helping to reduce odors that occur when starting the vehicle.

■ Air conditioning filter

→P.557

■ Air conditioning system refrigerant

- A label regarding the refrigerant of the air conditioning system is attached to the hood at the location shown in the following illustration.

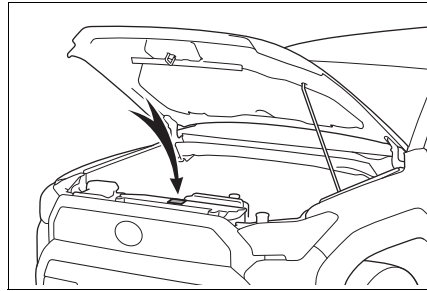

- The meaning of each symbol on the label are as follows:

	Caution
	Air conditioning system
	Air conditioning system lubricant type
	Requires registered technician to service air conditioning system
	Flammable refrigerant

■ Customization

Some functions can be customized. (Customizable features: →P.637)

**WARNING****■ To prevent the windshield from fogging up**

Do not use the windshield defogger switch during cool air operation in extremely humid weather. The difference between the temperature of the outside air and that of the windshield can cause the outer surface of the windshield to fog up, blocking your vision.

■ When the outside rear view mirror defoggers are operating

Do not touch the rear view mirror surfaces when the outside rear view mirror defoggers are on.

**NOTICE****■ To prevent battery discharge**

Do not leave the air conditioning system on longer than necessary when the engine is off.

■ When repairing/replacing parts of the air conditioning system

Have repair/replacement performed by your Toyota dealer. When a part of the air conditioning system, such as the evaporator, is to be replaced, it must be replaced with a new one.

Using automatic mode

- 1 Press the "AUTO" switch.
- 2 Adjust the temperature setting.
- 3 To stop the operation, press the "OFF" switch.

If the fan speed setting or air flow modes are operated, the

automatic mode indicator goes off. However, automatic mode for functions other than that operated is maintained.

■ Using automatic mode

Fan speed is adjusted automatically according to the temperature setting and the ambient conditions.

Therefore, the fan may stop for a while until warm or cool air is ready to flow immediately after the automatic mode switch is pressed.

Adjusting the temperature for driver and front passenger seats simultaneously ("SYNC" mode) (if equipped)

To turn on the "SYNC" mode, operate the "SYNC" switch.

The driver's side temperature control dial can be used to adjust the temperature for the driver's and front passenger's side. To enter individual mode, operate the front passenger's side temperature control dial or press the "SYNC" switch again.

When the "SYNC" mode is on, the "SYNC" indicator is illuminate.

Using front seat concentrated airflow mode (S-FLOW)

Directing airflow to the front seats only and to all seats can be switched via switch operation. Unnecessary air conditioning is suppressed, contributing

to increased fuel efficiency.

Press  on the air conditioning operation panel and switch the airflow.

Indicator illuminated: Airflow to the front seats only

Indicator off: Airflow to all the seats

Even if the function is switched to directing airflow to only the front seats, when a rear seat is occupied, it may automatically direct airflow to all seats.

Windshield wiper de-icer

This feature is used to prevent ice from building up on the windshield and wiper blades.

Press the rear window and outside rear view mirror defoggers switch.

The windshield wiper de-icer will automatically turn off after 15 minutes.

Turning the rear window and outside rear view mirror defoggers on will turn the windshield wiper de-icer on.

When the rear window and outside rear view mirror defoggers switch is on, the indicator illuminates on the rear window and outside rear view mirror defoggers switch.

WARNING

■ To prevent burns

Do not touch the glass at lower part of the windshield or to the side of the front pillars when the windshield wiper deicer is on.

Air outlet layout and operations

■ Location of air outlets

The air outlets and air volume change according to the selected air flow mode.

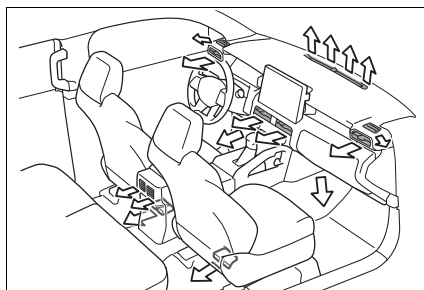

■ Adjusting the air flow direction

► Front

Direct air flow to the left or right, up or down

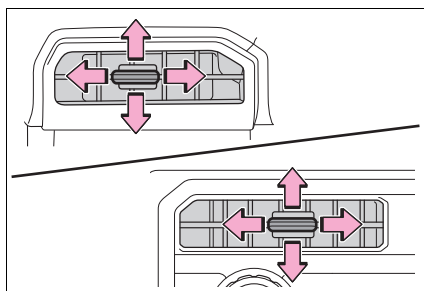

► Rear

Direct air flow to the left or right, up or down

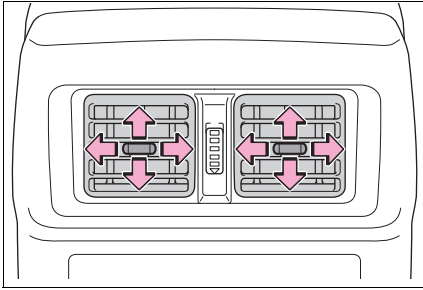

■ Opening/closing the air outlets

► Front side

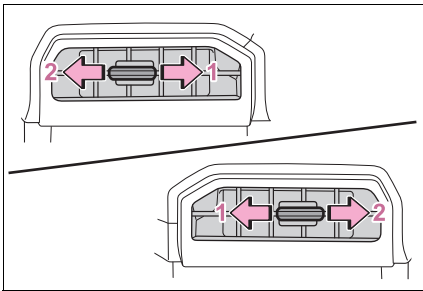

- 1 Open the vent
- 2 Close the vent

► Front center

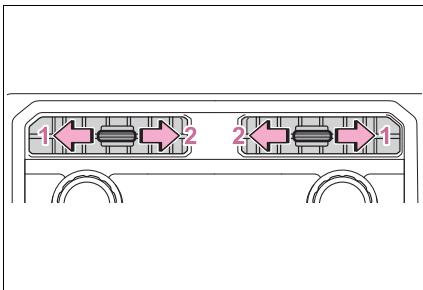

- 1 Open the vent
- 2 Close the vent

► Rear

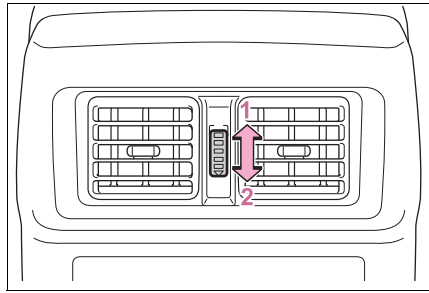

- 1 Open the vent
- 2 Close the vent

⚠ WARNING

■ To not interrupt the windshield defogger from operating

Do not place anything on the instrument panel which may cover the air outlets. Otherwise, air flow may be obstructed, preventing the windshield defoggers from defogging.

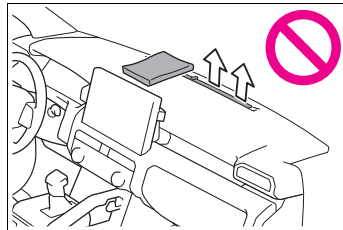

Heated steering wheel^{*} / seat heaters^{*} / seat ventilators^{*}

^{*}: if equipped

- Heated steering wheel

Warms up the grip of the steering wheel

- Front seat heaters

Warm up the seat upholstery

- Front seat ventilators

Maintain good ventilation by pulling air through the seat upholstery

WARNING

- To prevent minor burn injuries

Care should be taken if anyone in the following categories comes in contact with the steering wheel or seats when the heater is on:

- Babies, small children, the elderly, the sick and the physically challenged
- Persons with sensitive skin
- Persons who are fatigued
- Persons who have taken alcohol or drugs that induce sleep (sleeping drugs, cold remedies, etc.)

NOTICE

- To prevent damage to the seat heaters and seat ventilators

Do not put heavy objects that have an uneven surface on the seat and do not stick sharp objects (needles, nails, etc.) into the seat.

- To prevent battery discharge

Do not use the functions when the engine is off.

Operating instructions

- Heated steering wheel (if equipped)

Turns heated steering wheel on/off.

When the heated steering wheel is on, the indicator illuminates on the heated steering wheel switch.

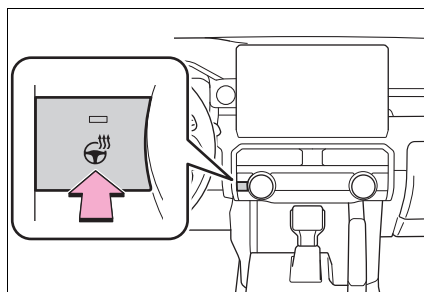

■ **Front seat heaters (if equipped)/seat ventilators (if equipped)**

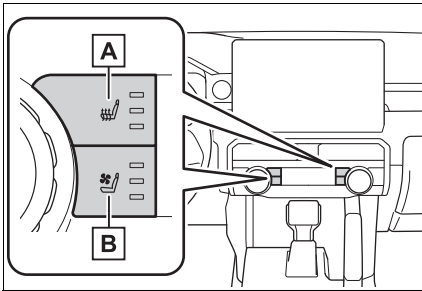

A Adjust the front seat heater temperature level

Each time the switch is pressed, the operation condition changes as follows.

Hi (3 segments lit) → Mid (2 segments lit) → Lo (1 segment lit) → Off

The level indicator (red) light up during operation.

B Adjust the front seat ventilator fan speed level

Each time the switch is pressed, the operation condition changes as follows.

Hi (3 segments lit) → Mid (2 segments lit) → Lo (1 segment lit) → Off

The level indicator (blue) light up during operation.

■ **The heated steering wheel, seat heaters and seat ventilators can be used when**

The engine switch is in ON.

! WARNING

■ **To prevent overheating and minor burn injuries**

Observe the following precautions when using the seat heaters.

- Do not cover the seat with a blanket or cushion when using the seat heater.
- Do not use seat heater more than necessary.

Interior lights list

Location of the interior lights

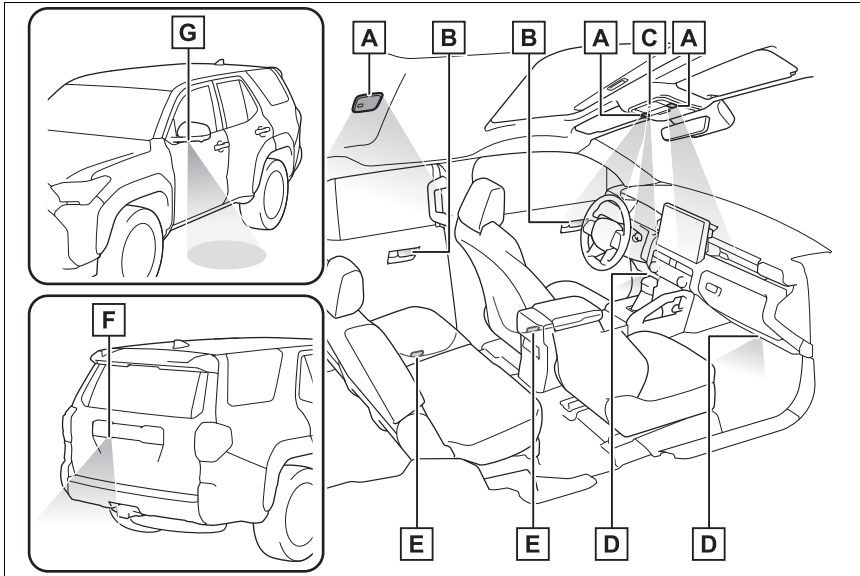

- A** Personal/interior lights (→P.470)
- B** Inside door handle lights (if equipped)
- C** Shift lever light
- D** Footwell lights (if equipped)
- E** Door courtesy lights
- F** Trailer hitch light (if equipped) (→P.470)
- G** Outer foot lights (if equipped)

Personal/interior lights main switch

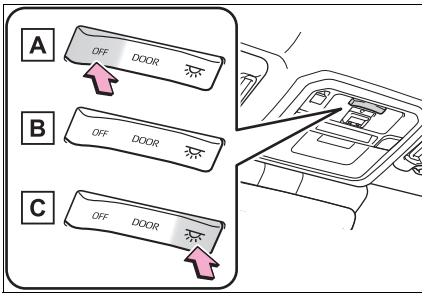

A "OFF"

The personal/interior lights can be individually turned on or off.

B "DOOR"

The personal/interior lights come on when a door is opened. They turn off when the doors are closed.

C On

The personal/interior lights cannot be individually turned off.

Operating the personal/interior lights

■ Front personal/interior lights

Turns the lights on/off

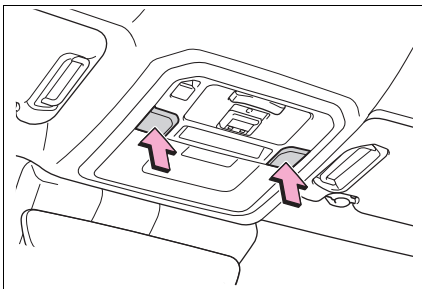

■ Rear interior lights

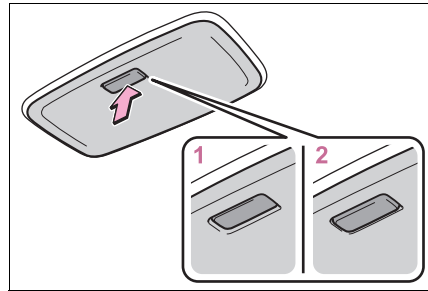

1 Turns the light on

2 Turns the door-linked function on (door position)

The lights turn on/off according to the opening/closing of the doors. The rear interior light turn on/off together the front interior light.

Trailer hitch light switch (if equipped)

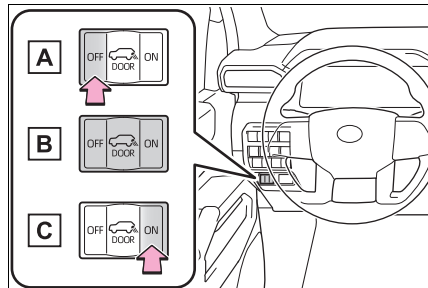

A "OFF"

Turns the light off

B "DOOR"

Turns on when the door is opened or closed while the shift lever is in P or R. Turn off when shift lever in D.

C "ON"

Turns on while the shift lever is in P or R. Turn off when shift lever in D.

■ Illuminated entry system (if equipped)

The lights automatically turn on/off according to the engine switch mode, the presence of the electronic key, whether the doors are locked/unlocked, and whether the doors are open/closed.

■ To prevent the battery from being discharged

If the following lights remain on when the door is not fully closed and the main switch is in the "DOOR" position, the lights will go off automatically after 20 minutes:

- Personal/interior lights
- Trailer hitch light (if equipped)

■ The personal/interior lights may turn on automatically when

If any of the SRS airbags deploy (inflate) or in the event of a strong rear impact, the personal/interior lights will turn on automatically.

The personal/interior lights will turn off automatically after approximately 20 minutes.

The personal/interior lights can be turned off manually. However, in order to help prevent further collisions, it is recommended that they be left on until safety can be ensured.

(The personal/interior lights may not turn on automatically depending on the force of the impact and conditions of the collision.)

■ Customization

Some functions can be customized. (→P.651)

■ Removing light lenses

Never remove the lens for the personal/interior lights. Otherwise, the lights will be damaged. If a lens needs to be removed, contact your Toyota dealer.



NOTICE

■ To prevent battery discharge

Do not leave the lights on longer than necessary when the engine is off.

List of storage features

Location of the storage features

► 5-passenger models

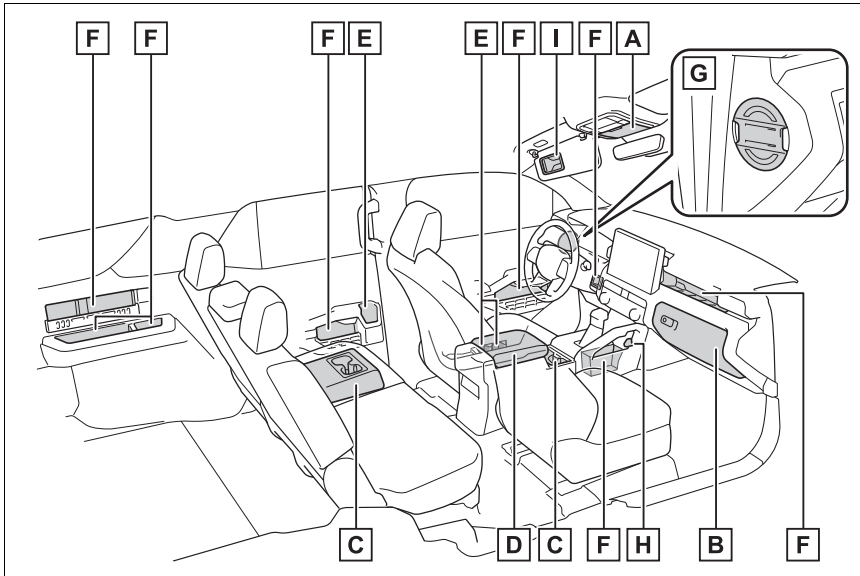

- A** Auxiliary box
- B** Glove box
- C** Cup holders
- D** Console box
- E** Bottle holders
- F** Open tray (if equipped)
- G** Storage box
- H** Storage hook
- I** Ticket holders

► 7-passenger models

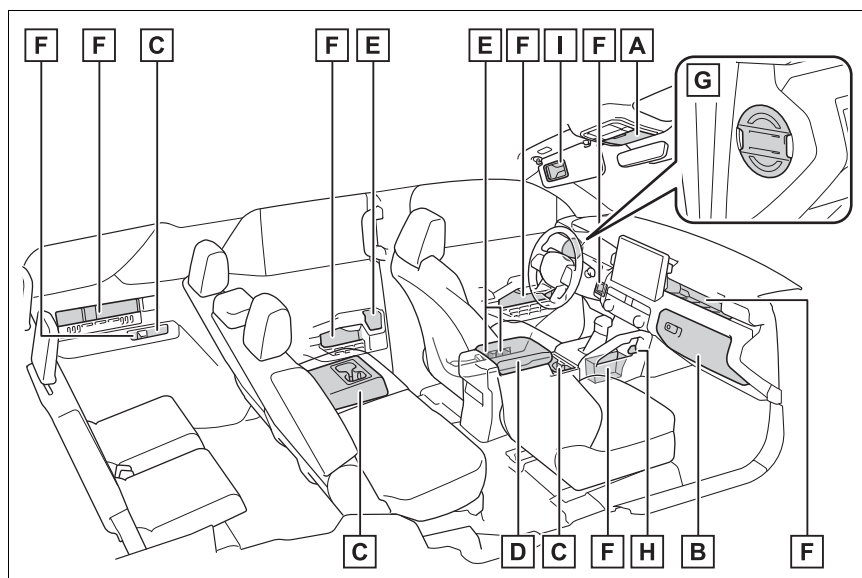

- A** Auxiliary box
- B** Glove box
- C** Cup holders
- D** Console box
- E** Bottle holders
- F** Open tray (if equipped)
- G** Storage box
- H** Storage hook
- I** Ticket holders

⚠ WARNING

■ Items that should not be left in the storage spaces

Do not leave glasses, lighters or spray cans in the storage spaces, as this may cause the following when cabin temperature becomes high:

- Glasses may be deformed by heat or cracked if they come into contact with other stored items.
- Lighters or spray cans may explode. If they come into contact with other stored items, the lighter may catch fire or the spray can may release gas, causing a fire hazard.

Glove box

Pull up the lever to open.

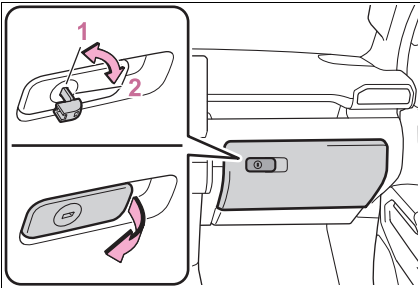

- 1 Lock with the mechanical key
- 2 Unlock with the mechanical key

⚠ WARNING

■ Caution while driving

Keep the glove box closed. In the event of sudden braking or sudden swerving, an accident may occur due to an occupant being struck by the open glove box or the items stored inside.

Cup holders

► Front

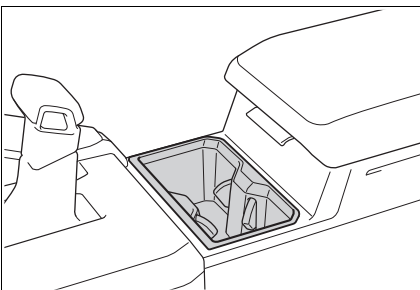

► Rear

Pull the armrest down for use.

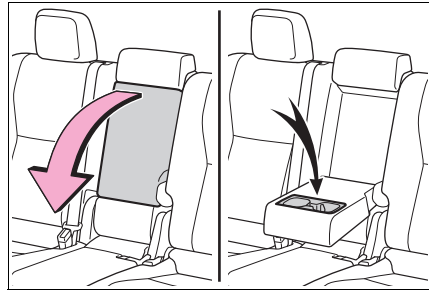

► Rear side trims

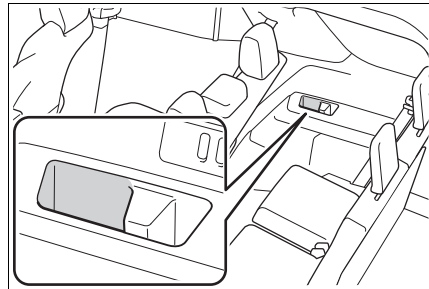

⚠ WARNING

■ Items unsuitable for the cup holder

Do not place anything other than cups or beverage cans in the cup holders.

Other items may be thrown out of the holders in the event of an accident or sudden braking and cause injury. If possible, cover hot drinks to prevent burns.

Bottle holders

► Front

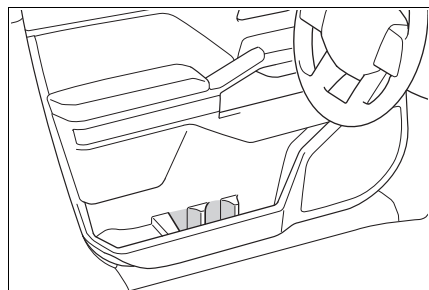

► Rear

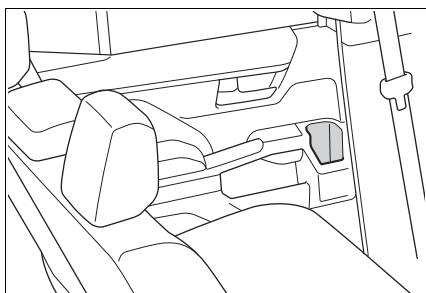

■ **Bottle holders**

- When storing a bottle, close the cap.
- The bottle may not be stored depending on its size or shape.

! WARNING

■ **Items unsuitable for the bottle holders**

Do not place anything other than a bottle in the bottle holders. Other items may be thrown out of the holders in the event of an accident or sudden braking and cause injury.

! NOTICE

■ **Items that should not be stowed in the bottle holders**

Put the cap on before stowing a bottle. Do not place open bottles in the bottle holders, or glasses and paper cups containing liquid. The contents may spill and glasses may break.

Console box

Lift the lid while pulling up the lever.

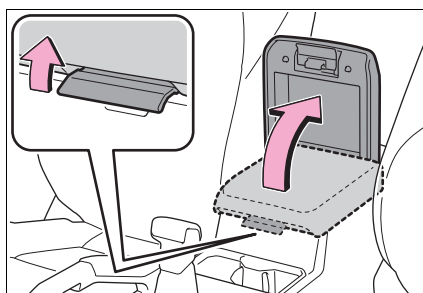

! WARNING

■ **Caution while driving**

Keep the console box closed. Injuries may result in the event of an accident or sudden braking.

Auxiliary box

Push in and release the auxiliary box.

This box is useful for temporarily storing the small items.

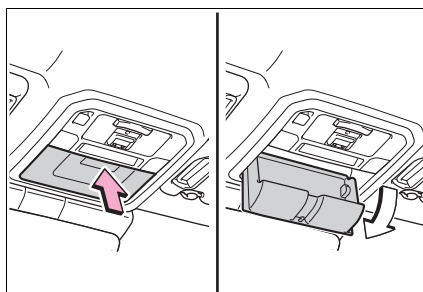

! WARNING

■ **Caution while driving**

Do not leave the auxiliary box open while driving. Items may fall out and cause death or serious injury in case of an accident or sudden stop.

⚠ WARNING

■ Items unsuitable for storing (overhead)

Do not store items heavier than 0.4 lb. (0.2 kg). Doing so may cause the auxiliary box to open and the items inside may fall out, resulting in an accident.

Storage box

Pull out the panel as shown in the figure below.

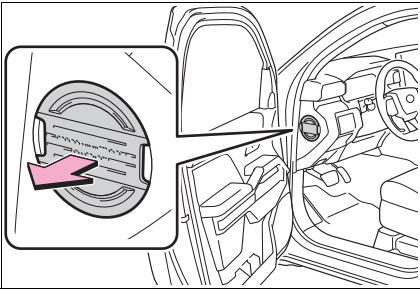

⚠ WARNING

■ Items unsuitable for storing

- Do not store items heavier than 0.6 lb. (0.3 kg). Doing so may cause the auxiliary box to open and the items inside may fall out, resulting in an accident.
- There is an arrow on backside of cover to show correct, upward orientation for re-installation.

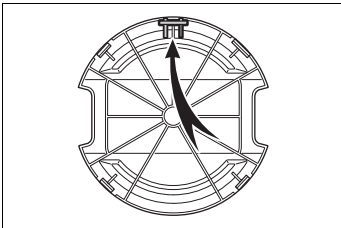

Open tray (if equipped)

► Type A

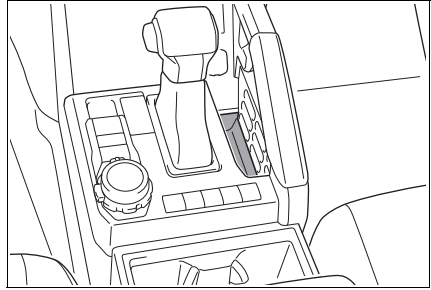

► Type B

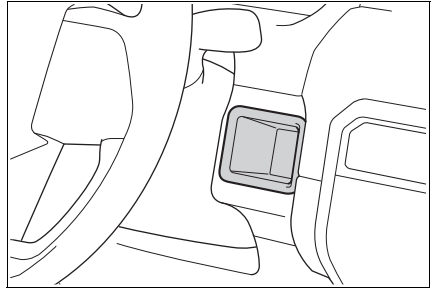

► Type C

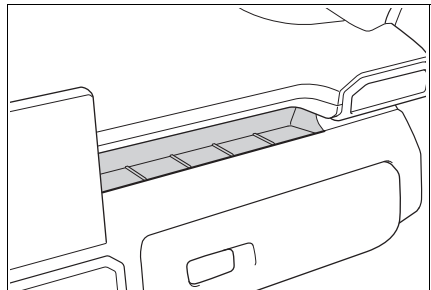

▶ Type D

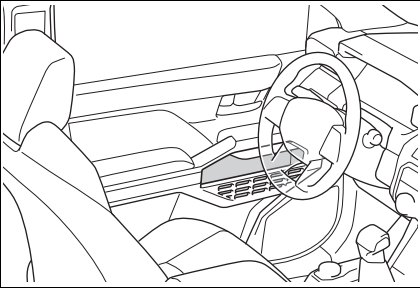

▶ Type H

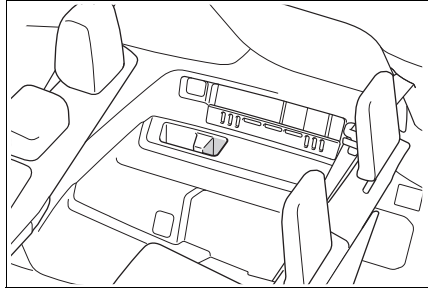

▶ Type E

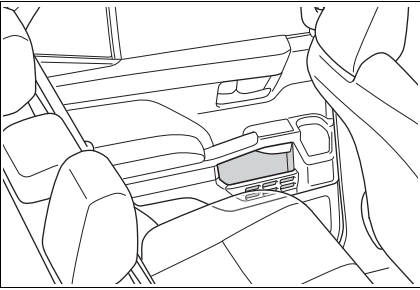

▶ Type F

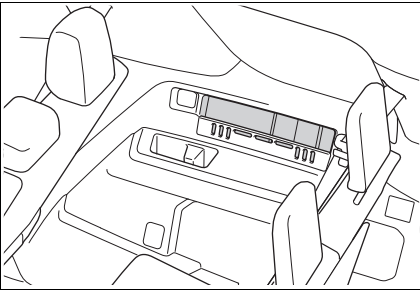

▶ Type G

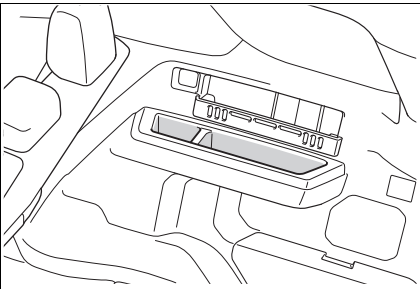

⚠ WARNING

■ Items unsuitable for the open tray

Observe the following precautions when putting items in the open tray.

Failure to do so may cause items to be thrown out of the tray in the event of sudden braking or steering. In these cases, the items may interfere with pedal operation or cause driver distraction, resulting in an accident.

- Do not store items in the tray that can easily shift or roll out.
- Do not stack items in the tray higher than the tray's edge.
- Do not put items in the tray that may protrude over the tray's edge.

Storage hook

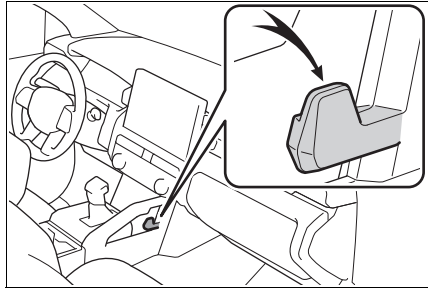

⚠ WARNING

■ **To prevent damage to the storage hook**

Do not hang any object heavier than 6.6 lb. (3 kg) on the storage hook.

Ticket holders

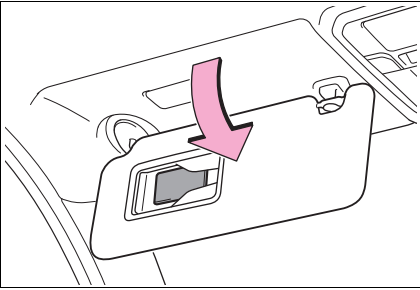

Flip down the visor.

Luggage compartment features

Grocery bag hooks

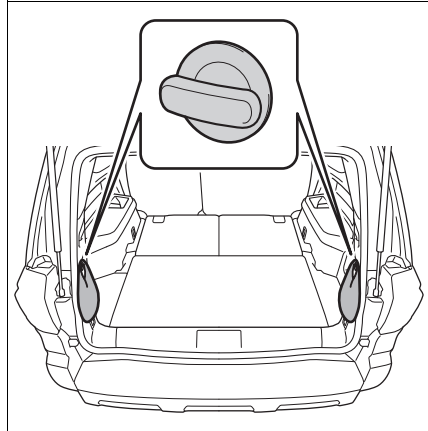

⚠ NOTICE

■ **To prevent damage to the grocery bag hooks**

Do not apply too much load on the grocery bag hooks.

Cargo hooks

Raise the hook to use.

The cargo hooks are provided for securing loose items.

► 5-passenger models

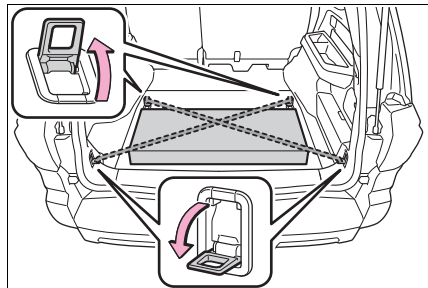

► 7-passenger models

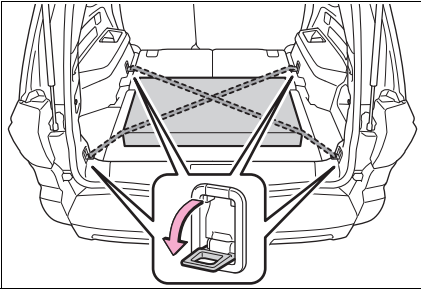

⚠ WARNING

■ When cargo hooks are not in use

To avoid injury, always return the hooks to their stowed positions when not in use.

Storage compartment (if equipped)

► Type A

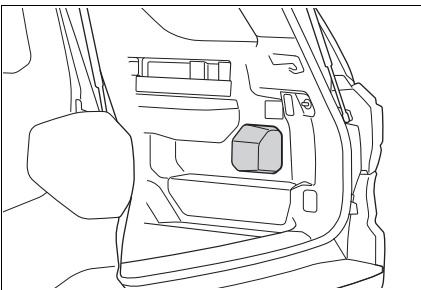

► Type B

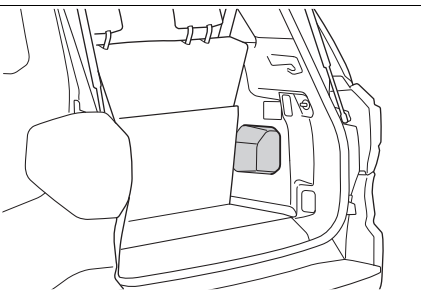

► Type C

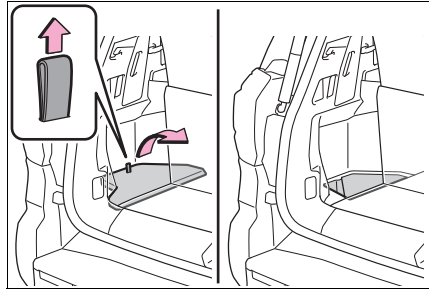

► Type D

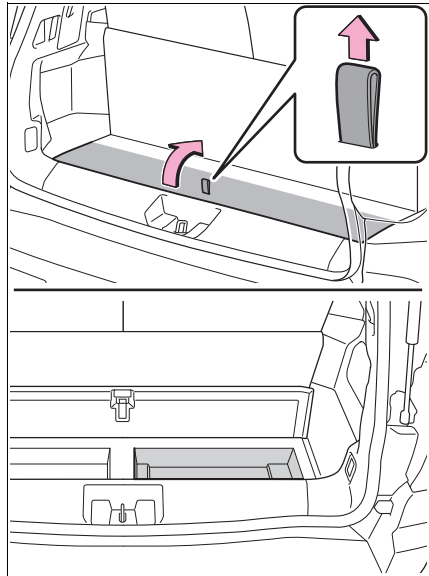

Other interior features

USB Type-C charging ports

The USB Type-C charging ports are used to supply electricity to external devices. Use the appropriate terminal for each charging port type.

The USB Type-C charging ports are for charging only.

They are not designed for data transfer or other purposes.

Depending on the external device, it may not charge properly. Refer to the manual included with the device before using a USB Type-C charging port.

■ Using the USB Type-C charging ports

▶ On the instrument panel

These USB Type-C charging ports are capable of high power output.

An output up to 45 W max on a single port or 52.5 W combined (shared) is possible.

The USB Type-C charging ports operate at multiple voltage and multiple wattage levels.

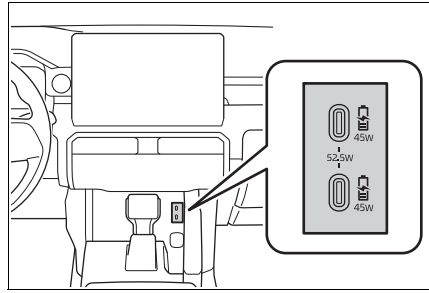

▶ Rear of console box (if equipped)

The USB Type-C charging ports are used to supply 3.0 A of electricity at 5 V to external devices.

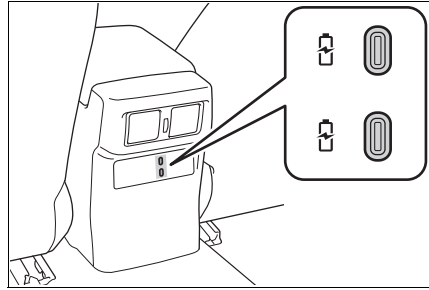

■ The USB Type-C charging ports can be used when

The engine switch is in ACC or ON, or the multimedia system is on.

■ Situations in which the USB Type-C charging ports may not operate correctly

- Rear of console box: If a device which consumes more than 3.0 A at 5 V is connected
- If a device designed to communicate with a personal computer, such as a USB memory device, is connected
- If the connected external device is turned off (depending on device)
- If the temperature inside the vehicle is high, such as after the vehicle has been parked in the sun

■ **About connected external devices**

Depending on the connected external device, charging may occasionally be suspended and then start again. This is not a malfunction.

 **NOTICE**

- **To prevent damage to the USB Type-C charging ports**
 - Do not insert foreign objects into the ports.
 - Do not spill water or other liquids into the ports.
 - Do not apply excessive force to or impact the USB Type-C charging ports.
 - Do not disassemble or modify the USB Type-C charging ports.
- **To prevent damage to external devices**
 - Do not leave external devices in the vehicle. The temperature inside the vehicle may become high, resulting in damage to an external device.
 - Do not push down on or apply unnecessary force to an external device or the cable of an external device while it is connected.
- **To prevent battery discharge**

Do not use the USB Type-C charging ports for a long period of time with the engine stopped.

Wireless charger (if equipped)

A portable device can be charged by just placing Qi standard wireless charge compatible portable devices according to

the Wireless Power Consortium, such as smartphones and mobile batteries, etc., on the charge area.

The compatible portable devices can be found on the following Wireless Power Consortium website.

<https://www.wirelesspowerconsortium.com/>

This function cannot be used with portable devices that are larger than the charging tray. Also, depending on the portable device, it may not operate as normal. Please read the operation manual for portable devices to be used.

■ **The “Qi” logo**

The “Qi” logo is a trademark of the Wireless Power Consortium.



■ **Name for all parts**

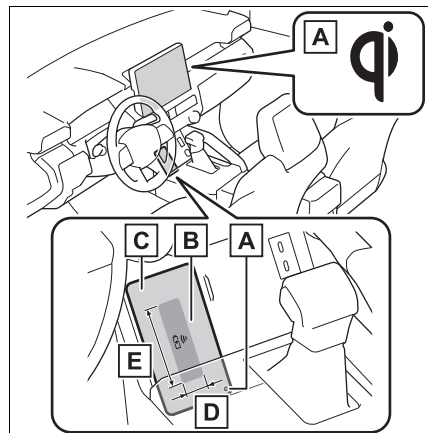

- A** Operation indicator light
- B** Charging area*
- C** Charging tray
- D** Approximately 1.0 in. (2.5 cm)
- E** Approximately 3.9 in. (10 cm)

*: Compatible portable devices and the wireless charger contain charging coils. The charging coil in the wireless charger can be moved within the charge area up to the position of the charging coil inside a portable device. Charging is possible if the center of the coil of the portable device is placed within the charge area. If 2 or more portable devices are placed on the charging tray, their charging coils may not be properly detected and they may not be charged.

■ Using the wireless charger

Place the portable device on the charging tray.

Place the charging side of the portable device down with the center of the device in the center of the charge area.

When charging, the operation indicator light (orange) comes on.

If charging is not occurring, refer to “Situations in which the function may not operate normally” (→P.486).

When charging is complete, the operation indicator light (green) comes on.

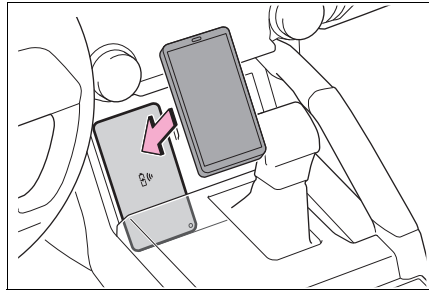

■ Recharging function

- When charging is complete and after a fixed time in the charge suspension state, charging restarts.
- When a portable device is moved significantly in the charge area, the charging coil is disconnected and charging is stopped momentarily. However, if there is a charging coil in the charge area, the charging coil inside the wireless charger will move toward it and then charging restarts.

■ Rapid charging function

- The following portable devices support rapid charging.
 - Portable devices compliant with WPC Ver1.3.2 and compatible with rapid charging
 - iPhone’s with an iOS version that supports 7.5 W charging (iPhone 8 and later models)
 - Portable devices compatible with Galaxy original rapid charging standard.
- When a portable device that supports rapid charging is

charged, charging automatically switches to the rapid charging function.

■ **Lighting conditions of operation indicator light**

Operation indicator light		Conditions
Charging tray side	Multimedia system screen side	
Turning off	Disappear	When the Multimedia power supply is off or engine switch is off
Green (comes on)	Gray	On Standby (charging possible state) ^{*1}
		When charging is complete ^{*2}
Orange (comes on)	Blue	Charging

*1: Charging power will not be output during standby. A metallic object will not be heated, if it is placed on the charging tray in this state.

*2: Depending on the portable device, there are cases where the operation indicator light will continue being lit up orange even after the charging is complete.

■ **The wireless charger is not working properly**

The following are situations in which the wireless charger does not work properly and how to deal with the possible causes.

Operation indicator light	Multimedia system screen	Suspected causes/Handling method
Orange (Flashing repeatedly once every second)	Gray	Vehicle to wireless charger communication failure → If the engine is running, stop and then restart the engine. If the engine switch is in ACC, start the engine. (→P.218)
Green (Flashing repeatedly once every second)	Disappear	Wireless charger and multimedia system communication failure → If the engine is running, stop and then restart the engine. If the engine switch is in ACC, start the engine. (→P.218)

Operation indicator light	Multimedia system screen	Suspected causes/Handling method
Green (comes on)	Blue	<p>AM radio stations are being automatically selected</p> <p>→ Wait until the system has completed the automatic selection of AM radio stations. In the case that automatic selection cannot be completed, stop automatic selection.</p>
		<p>The smart key system is detecting the key</p> <p>→ Wait until the key detection is complete.</p>
Green (comes on)	Gray	<p>Foreign substance detection: A metallic foreign substance is in the charge area, and so the abnormal heating prevention function of the metallic foreign substance operated</p> <p>→ Remove the foreign substance from the charge area.</p>
		<p>Portable device misaligned/distanced from charging surface: The center of charging coil in the portable device moved outside of the charging area, or lens convex is large, or case is thick so the abnormal heating prevention function operated</p> <p>→ Remove the portable device from the wireless charger, after 5 seconds, then place the portable device so that it is near the center of the wireless charger.</p> <p>Also, if a case or cover is installed to the portable device, remove it.</p>

Operation indicator light	Multimedia system screen	Suspected causes/Handling method
Green (comes on)	Gray	<p>Battery protection function of portable device: Before full charging, battery protection function of portable device operated → Confirm the setting of portable device.</p> <p>Continued detection of an electronic key: When a Multimedia function is used through vehicle customization, the electronic key is continually detected without being confirmed. → In this case, turn the engine switch ACC or ON to confirm the key.</p>
Orange (Repeatedly flashes 4 times continuously)	Gray	<p>Safety shutdown resulting when the temperature within the wireless charger exceeded the set value → Stop charging, remove the portable device from the charging tray, wait for the temperature to drop, and then start charging again.</p>

■ **The wireless charger can be operated when**

The engine switch is in ACC or ON, or the multimedia system is on.

■ **Usable portable devices**

- Qi standard wireless charge standard can be used on compatible devices. However, compatibility with portable devices that comply with Qi Ver. 1.0, 1.3.2 and later versions, and Qi2 MPP (Magnet Power Profile) is not guaranteed.
- Starting with mobile phones and smartphones, it is aimed for low

power electrically supplied portable devices of no more than 5 W.

- However, charging exceeding 5 W is supported by the following portable devices.
- Charging at 7.5 W or less is supported by iPhone's that support 7.5 W charging.
- Charging at 10 W or less is supported by Galaxy device that support 10 W charging of original standard.
- Charging at 15 W or less is supported by portable devices compliant with EPP output as defined by WPC standard Ver1.3.2.

■ Using the smart key system

If the smart key system detects the electronic key while a device is being charged, charging will be temporarily stopped. When the electronic key is detected, charging will automatically start again.

■ When covers and accessories are attached to portable devices

Do not charge in situations where cover and accessories not able to handle Qi are attached to the portable device. Depending on the type of cover (including for certain genuine manufacturer parts) and accessory, charging may not be possible.

In addition, Qi2 is not supported. As a result, charging may not be possible when an accessory and cover that comply with Qi2 are installed.

When charging is not performed even with the portable device placed on the charge area, remove the cover and accessories.

■ AM radio cooperation function during charging

- During charging, if noise occurs when listening to the AM radio, the charging frequency is automatically changed to reduce the noise.
- When automatically seeking AM radio stations, charging will be suspended to prevent charging noise from being detected as a radio station. Charging will resume automatically when seek tuning is stopped.

■ Important points of the wireless charger

- If the electronic key cannot be detected within the vehicle interior, charging can not be done. When the door is opened and closed, charging may be temporarily suspended.
- When charging, the wireless charging device and portable device will get warmer, however

this is not a malfunction. When a portable device gets warm while charging, charging may stop due to the protection function on the portable device side. In this case, when the temperature of the portable drops significantly, charge again.

The fan may start operating to lower the temperature inside the wireless charger, however this is not a malfunction.

■ Operation sounds

A buzzing noise may be heard when pressing the engine switch to turn to ACC or ON or when detecting a portable device. However, this is not a malfunction.

■ Cleaning the wireless charger

→P.518

■ Situations in which the function may not operate normally

Devices may not be charged normally in the following situations.

- The portable device is fully charged
- The portable device is being charged with a cable connected
- There is foreign matter between the charge area and portable device
- Charging has caused the portable device to heat up
- The temperature around the charging tray is 95°F (35°C) or higher, such as in extreme heat
- The portable device is placed with its charging surface facing up
- The small portable device such as foldable type is placed in an area misaligned from the charge area
- The portable device is larger than the charging tray
- The camera lens protrudes 0.12 in (3 mm) or more from the surface of the portal device
- The vehicle is in an area where

strong electrical waves or noise are emitted, such as near a television tower, power plant, gasoline station, broadcasting station, large display, airport, etc.

- The electronic key is not inside the vehicle
- Any of the following objects is stuck or installed between the charging side of the portable device and the charge area.
 - Thick cases or covers
 - A case or cover attached with an uneven or tilted surface, so that the charging side is not flat
 - Thick decorations
 - Accessories, such as finger rings, a. straps, etc.
 - Cover to protect camera lens
- When there is a gap between the charging side of the portable device and the charge area due to a protrusion such as a camera on the charging side of the portable device.
- When the portable device is in contact with, or is covered by any of the following metallic objects:
 - A card that has metal on it, such as aluminum foil, etc.
 - A pack of cigarettes that includes aluminum foil
 - A wallet or bag that is made of metal
 - Coins
 - A heating pad
 - CDs, DVDs or other media
 - A metal accessory
 - A case or cover made of metal
 - A flip type case with a magnet on the charging side of the portable device
- Electric wave type wireless remote controls are being used nearby
- 2 or more portable devices are placed on the charging tray at the same time
- If you use a device with a built-in S-Pen (Galaxy Note series, etc.) and the device with the S-Pen

inserted is on the tray.

If charging is abnormal or the operation indicator light continues to flash for any other reason, the wireless charger may be malfunctioning. Contact your Toyota dealer.

■ If the smartphone OS has been updated

If the smartphone OS has been updated to a newer version, its charging specifications may have changed significantly. For details, check the information on the manufacturer's website.

■ Trademark information

- iPhone is a trademark of Apple Inc., registered in the U.S. and other countries.
- "Galaxy" is a trademark or registered trademark of Samsung Electronics Co., Ltd.

■ Certification

→P.698

WARNING

■ Caution while driving

When charging a portable device, for safety reasons, the driver should not operate the main part of the portable device while driving.

■ Caution while in motion

Do not charge lightweight devices such as wireless headphones while in motion. These devices are very light and may be ejected from the charging tray, which may lead to unforeseen accidents.

**WARNING****■ Caution regarding interference with electronic devices**

People with implantable cardiac pacemakers, cardiac resynchronization therapy-pacemakers or implantable cardioverters, as well as any other electrical medical device, should consult their physician about the usage of the wireless charger.

■ To prevent malfunctions or burns

Observe the following precautions. Failure to do so may result in a equipment failure and damage, catch fire, burns due to overheat or electric shock.

- Do not insert any metallic objects between the charge area and the portable device while charging
- Do not attach an aluminum sticker or other metallic object to the charge area
- Do not attach an aluminum sticker or other metallic object to the side of the portable device (or to its case or cover) that touches the charge area
- Do not use the charging tray as a small storage space
- Do not subject to a strong force or impact
- Do not disassemble, modify or remove
- Do not charge devices other than specified portable devices
- Keep away from magnetic items
- Do not perform charging if the charging area is dirty
- Do not cover with a cloth or similar material

**NOTICE****■ To prevent malfunctions and data corruptions**

- When charging, bringing a credit, or other magnetic card, or magnetic storage media close to the charge area may clear any stored data due to magnetic influence. Furthermore, the electronic key may not operate due to magnetic interference if the electronic key for the vehicle is placed on the mobile phone terminal while charging or an open space. Also, do not bring a wristwatch or other precision instrument close to the charge area since doing so may cause it to malfunction.
- Do not charge with a non-contact IC card such as a transportation system IC card inserted between the charging side of a portable device and the charge area. The IC chip may become extremely hot and damage the portable device or IC card. Be especially careful not to charge a portable device inside a case or cover with a non-contact IC card attached.
- Do not leave portable devices inside the vehicle. The inside of the vehicle can become hot in extreme heat, which could cause a malfunction.

■ To prevent battery discharge

Do not use the wireless charger for a long period of time when the engine is stopped.

Armrest

Pull the armrest down for use.

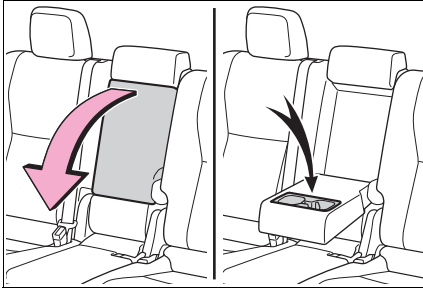

⚠ NOTICE

■ To prevent damage to the armrest

Do not place too much strain on the armrest.

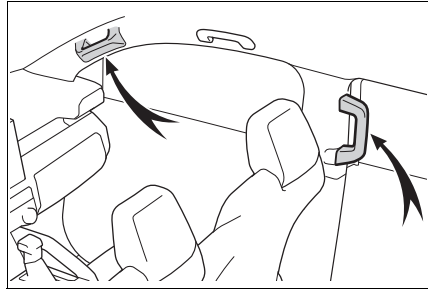

⚠ WARNING

■ Assist grips (type A)

Do not use the assist grip when getting in or out of the vehicle or rising from your seat.

⚠ NOTICE

■ To prevent damage to the assist grip

Do not hang any heavy object or put a heavy load on the assist grip.

Assist grips

► Type A

An assist grip installed on the ceiling can be used to support your body while sitting on the seat.

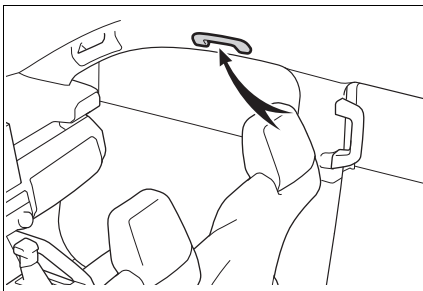

► Type B

An assist grip installed on the pillar can be used when getting in or out of the vehicle and others.

Coat hooks

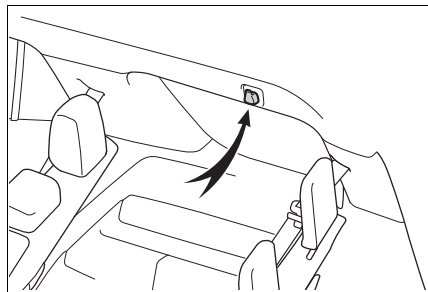

⚠ WARNING

■ Items that must not be hung on the hook

Do not hang a coat hanger or other hard or sharp object on the hook. If the SRS curtain shield airbags deploy, these items may become projectiles that cause death or serious injury.

Power outlet (12 VDC)

The power outlet can be used for 12 V accessories that run on less than 10 A.

► Front

Open the lid.

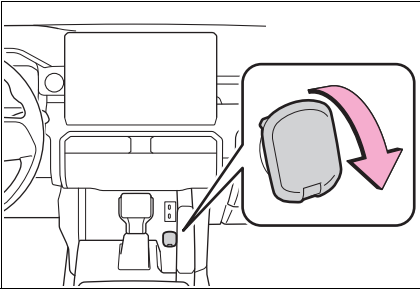

► Luggage compartment (if equipped)

Open the lid.

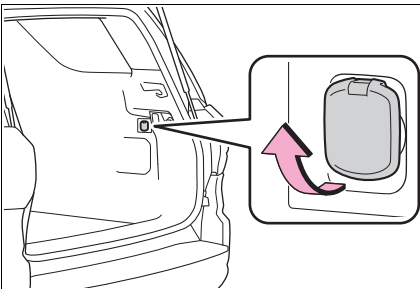

■ **The power outlet can be used when**

The engine switch is in ACC or ON, or the multimedia system is on.

■ **When turning the engine switch off**

Disconnect electrical devices with charging functions, such as mobile battery packs. If such devices are left connected, the engine switch may not be turned off normally.



NOTICE

■ **To avoid damaging the power outlet**

Close the power outlet lid when the power outlet is not in use. Foreign objects or liquids that enter the power outlet may cause a short circuit.

■ **To prevent the fuse from being blown**

Do not use an accessory that uses more than 12 V 10 A.

■ **To prevent battery discharge**

Do not use the power outlet longer than necessary when the engine is not running.

Power outlets (120 VAC) (if equipped)

Please use as a power supply for electronic devices that use less than 120 VAC.

■ **Using the power outlets**

► Rear of the console box

Open the lid.

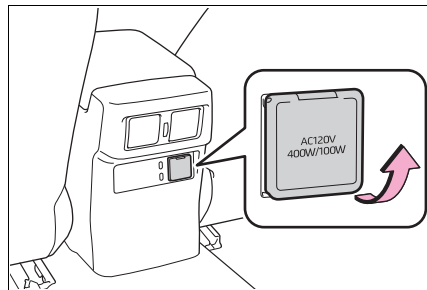

► Luggage compartment

Open the lid.

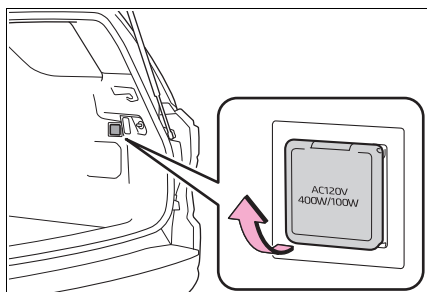

■ When turning the power outlets on

Press the “AC120V” switch.

The power outlets can be used when the indicator on the “AC120V” switch is illuminated.

The power outlets are turned off/on each time the “AC120V” switch is pressed.

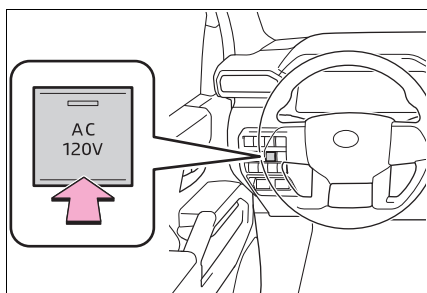

■ Maximum available capacity of the power outlet

- While the vehicle is being driven

The maximum capacity of the power outlet is always 120 V AC/100 W.

- When the vehicle is stationary
- The maximum capacity is restricted to 120 V AC/100 W

when the shift lever is moved to any positions other than P or N.

- The maximum capacity is 120 V AC/400 W when the shift lever is in P or N.

The maximum capacity of 400 W can only be restored by turning the power outlet main switch off and then on again under condition described above.

■ When connecting a device

Open the lid, and fully and securely insert the plug of the device into the power outlet.

► Rear of the console box

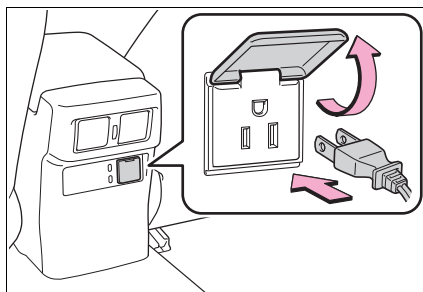

► Luggage compartment

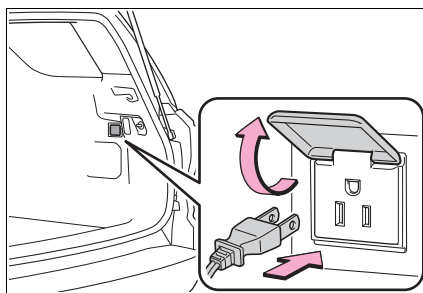

■ When turning the power outlets off

- 1 Turn the connected devices off.

- 2 Press the “AC120V” switch to turn the power outlets off.
- 3 Disconnect each plug from the power outlets.
- 4 Close the lid of each power outlet.

■ **The power outlet can be used when**

The engine is running.

■ **Electronic devices that can be connected to the power outlets**

Use electronic devices that can be connected to the 120 VAC power outlets. Depending on the devices being used, the current flow may become high and the electric power for a moment may exceed the regulated capacity. If the regulated capacity is exceeded by the electronic devices being used, the protection function of the power outlet may operate and power outlet may not be able to be used, but this is not a malfunction. However, observe the following precautions:

- Depending on the devices used, it may cause interference with TV and radio broadcasts.
- Observe the precautions that are stated in the instruction manuals for each of the electronic devices.
- It is assumed that many typical general electronic devices will not be used within the vehicle. The following problems may occur when using electronic devices within the vehicle.
 - Electronic device malfunction due to vibrations while driving.
 - Electronic device malfunction or poor operations due to temperature changes* within the vehicle.
 - The installation is unstable and may not operate normally as the compartment within the vehicle is not flat.

*: Depending on the weather, sea-

son, usage environment, etc., the vehicle compartment may undergo extreme high or low temperatures.

■ **Power outlet**

The power outlet on the console box is a device in order to use electronic devices within the vehicle.

■ **Devices which may not operate correctly**

The following 120 VAC devices may not operate properly:

- Devices with high initial peak wattage
- Measuring devices that process precise data
- Devices that require an extremely stable power supply
- Devices that require a constant power supply from the power outlet, such as a device with a timer.

■ **When the power supply function cannot be used**

If the “AC120V” switch is pressed but the switch indicator does not illuminate, the protection circuit may have operated.

In this case, perform the appropriate procedures as follows.

- Disconnect the plug of each device from the power outlets, check that the total power consumption of all devices to be connected to the power outlets, reconnect the devices and then press the “AC120V” switch again.
- Disconnect the plug of each device from the power outlets, check that the devices are not malfunctioning, reconnect the devices and then press the “AC120V” switch again.
- If the temperature inside the vehicle is high, such as after the vehicle has been parked under the sun, move the vehicle to a shaded area, use the air conditioning sys-

tem to sufficiently cool the interior, and then press the “AC120V” switch again.

If the power outlets cannot be used even after performing the appropriate procedures above, have the vehicle inspected by your Toyota dealer.

- If any electrical device has malfunctioned, park the vehicle in a safe location and turn the “AC120V” switch off.
- If the protection function activates and power is cut, perform the following procedure.
 - 1 Stop the vehicle in a safe place and set the parking brake.
 - 2 Ensure that the shift lever is in P or N.
 - 3 Check that the power consumed by the electrical devices is within 400 W and any device has not malfunctioned.
 - 4 Press the “AC120V” switch.

If the inside of the vehicle is hot, open the windows to lower the temperature and turn the switch back on once the inside of the vehicle reaches a normal temperature. If following the procedure above does not restore power, have the vehicle inspected at your Toyota dealer.



WARNING

■ **For safe use**

Observe the following precautions.

Failure to do so may lead to an accident, resulting in death or serious injury.

- Do not use devices such as the following when driving:
 - Devices which cannot be properly secured within the vehicle.

- Devices which may distract the driver and be a hindrance to safe driving, such as a TV, DVD player, etc.
- Unsecured devices which generate heat, such as a toaster, microwave, electric heater, electric kettle, coffee maker, etc., as they may cause burns or a fire in the case of sudden braking or an accident.
- Devices which may fall under the pedals and prevent the brake pedal from being depressed.
- Do not use devices which produce steam while the windows are closed. Doing so may cause the windows to fog up, reducing visibility and making it difficult to drive safely. Also, the steam may damage or negatively affect other devices. If the device must be used, stop the vehicle and open the windows before use.
- Do not use damaged electronic devices. The power supply function may not be able to be used.
- Do not disconnect the plug of a device while your hands are wet or insert a pin or other object into the power outlet. Also, if a liquid or snow is on the power outlet, dry the outlet before using it.
- Do not attempt to modify, disassemble or repair a power outlet. For information on repairs, contact your Toyota dealer.
- Do not let children touch the power outlets.
- Keep the power outlets free of dust and foreign matter. Also, regularly clean the power outlet.

**WARNING**

- If the plug of a device fits loosely in a power outlet, even though it is fully inserted, replace the power outlet. For information on replacement, contact your Toyota dealer.

■ Using the power outlets while parked or stopped

Observe the following precautions.

Failure to do so may lead to an accident, possibly resulting in death or serious injury.

- Do not leave the vehicle unattended while the engine is running and a device is connected to a power outlet.
- Do not place luggage or get near the vicinity of the tailpipe.
- Make sure that the hood is closed. Do not put your head or hands anywhere inside the engine room, as the cooling fan may operate suddenly. If too close, hands and clothing (especially a tie, scarf, etc.) may get caught in a fan.
- Do not stop the vehicle near objects which burn easily.
- Install and use appropriately related devices to make air supply and exhaust ventilation possible in places where ventilation is bad, such as within garages, and places where the vehicle is surrounded (places where snow accumulates).
- Do not use in places where ventilation is bad, such as within garages where there are no air supply and exhaust ventilation devices, and places where the vehicle is surrounded (places where snow accumulates, etc.).

- Do not use the power outlets if the vehicle has a vehicle cover installed.

- Do not sleep in the vehicle while using devices such as an electric heater.

■ Devices to be connected

- Read the instruction manual included with the electronic device being used and observe the precautions that are stated regarding the product.
- Do not use when the power plug or electronic device are damaged.
- Malfunctions or poor operations may occur when the outside temperatures are particularly high or low.
- Normal operations may not be possible for electronic devices that require level installation.
- Excluding electronic devices with waterproof specifications, do not use in places where it can be covered by rain or water, or places with lots of humidity.
- Do not use medical equipment as the power supply function may temporarily stop depending the conditions of the vehicle.

**NOTICE**

Observe the following precautions.

Failure to do so may lead to the power outlets not operating correctly or damage to the vehicle or a connected device.

 NOTICE

■ **To avoid short circuit or malfunction**

- Do not set a device which generates heat near the interior components or on a seat. Heat may cause these parts to melt or burn.
- Do not use devices which are sensitive to vibration or heat in the vehicle.
These devices may malfunction due to vibration while driving or heat while the vehicle is parked in the sun.
- When not using a power outlet, make sure to close the cover. If foreign matter or a liquid enters the power outlet, it may cause a malfunction or short circuit.
- Do not use a multi-point outlet adapter as doing so may overload the power outlet.
- Immediately stop using if there is an unusual amount of heat being felt from the power outlet.

■ **When the ambient temperature is high**

If the temperature inside the vehicle is high, such as after the vehicle has been parked under the sun, move the vehicle to a shaded area, use the air conditioning system to sufficiently cool the interior, and then press the "AC120V" switch again.

Sun visors

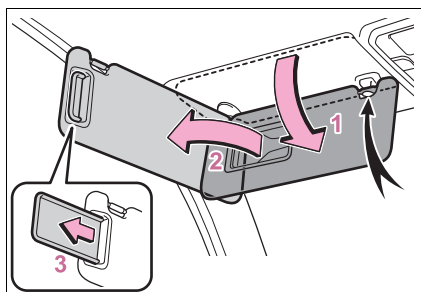

- 1 To set the visor in the forward position, flip it down.
- 2 To set the visor in the side position, flip down, unhook, and swing it to the side.
- 3 To use the side extender, place the visor in the side position, then slide it backward.

Vanity mirrors

Open the cover.

The vanity light turns on.

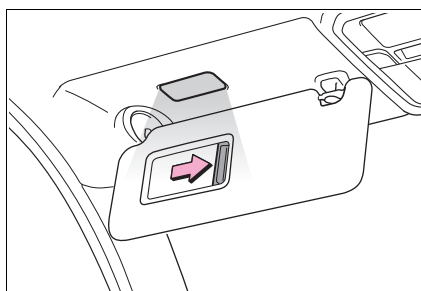

■ **To prevent battery discharge**

If the vanity lights remain on when the engine switch is turned off, the lights will go off automatically after 20 minutes.



NOTICE

■ To prevent the battery from being discharged

Do not leave the vanity lights on for extended periods while the engine is off.

Removable speaker*

*: If equipped

Music can be played by removing the speaker (JBL Flex) installed in the instrument panel and taking it to any desired location, and connecting it with your Bluetooth® compatible device via Bluetooth®.

When attached to the dock of the instrument panel, it functions as a normal car speaker.

**WARNING****■ When driving the vehicle**

Install or properly secure the speaker before driving. Failure to do so could lead to an accident, serious injury or death.

Components

► Front

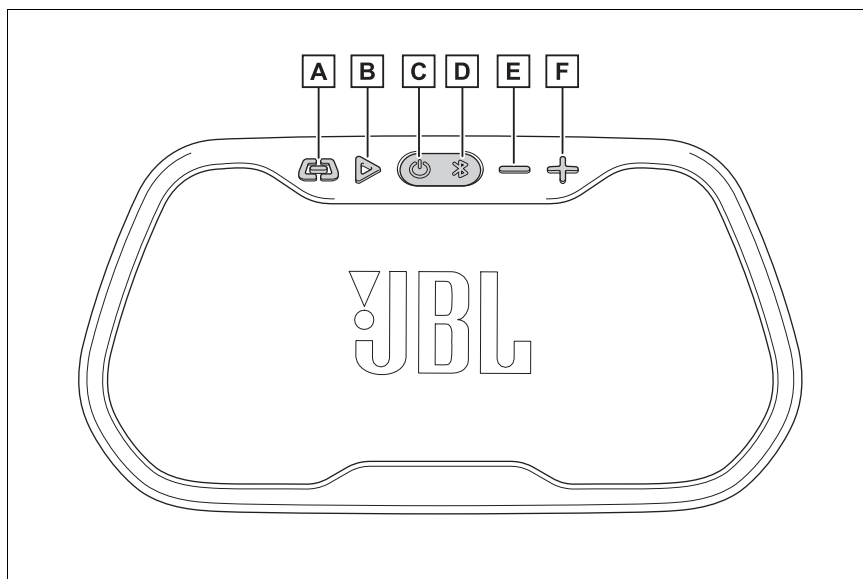

- A** Link button
- B** Play/pause button
- C** Power button
- D** Bluetooth[®] button
- E** Volume down button
- F** Volume up button

► Side

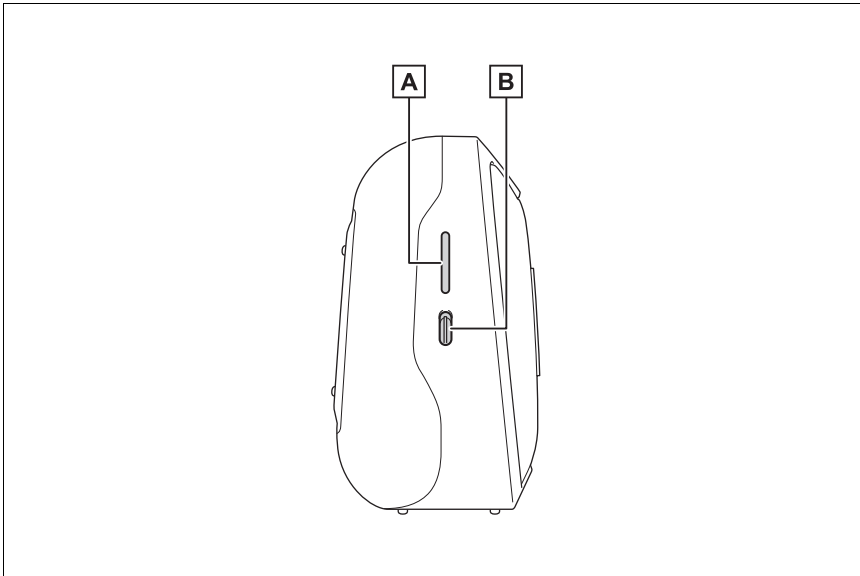

- A** Battery status indicator
- B** Charging port (USB Type-C)

 NOTICE

■ **Waterproof Performance**

The speaker (JBL Flex) has specifications equivalent to the waterproof standard IPX7. Even if it is temporarily (30 minutes) submerged in water up to depths of 3 ft. (1 m), it is a waterproof type that does not allow water to enter inside.

- Do not use the product underwater as it is not completely waterproof.
- If water gets into the product, stop using it and consult your Toyota dealer. Please note that the warranty does not apply to malfunctions caused by water immersion caused by mishandling by the customer.

Attaching and removing the speaker (JBL Flex)

► Removal

Press the eject button and remove the speaker (JBL Flex) from the dock.

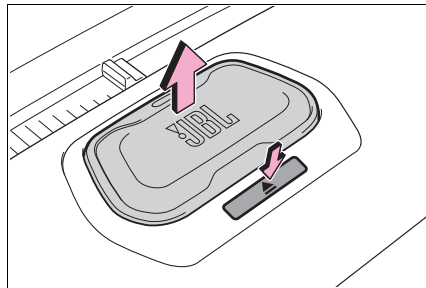

► Install

Push in until a click is heard.

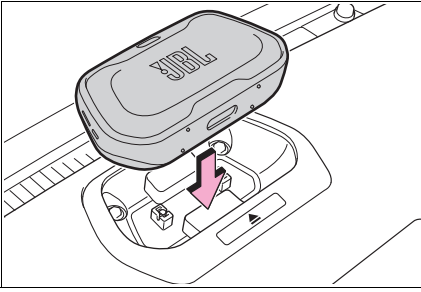

■ Installation

If the orange mark can be seen, the speaker (JBL Flex) is not fully seated.

Push it in firmly until it clicks.

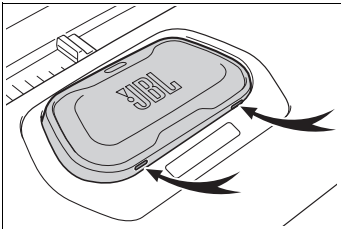

Charging method

- Charge by connecting to the dock on the instrument panel.

Maximum charging time: about 3.5 hours

- Charging with the USB Type-C port on the side of the main unit.

When fully charged, the battery status indicator will turn solid white.

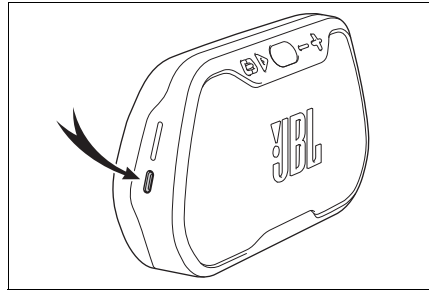

■ Remaining battery power

The remaining amount of battery power can be checked with the indicator on the side of the main unit.

The speaker can be used for up to 6.5 hours at 50% volume from a fully charged state.

When the battery power drops to approximately 15% during playback, the bottom LED will flash red.

The battery life will change over time depending on the usage, battery charge cycles, and usage environment.

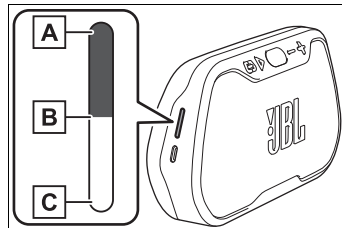

A 100%

B 50%

C 20%

How to use

■ Connect

- 1 Turn on the Bluetooth[®] function of the Bluetooth[®] device to be registered.
- 2 Remove the speaker (JBL Flex) from the instrument panel dock.
- 3 Press the power button to turn on the power.

A startup sound is played and the Power button lights up.

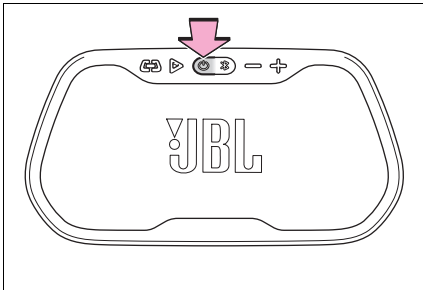

- ▶ For the last connected Bluetooth[®] device

Bluetooth[®] button flashes and automatically connects.

- ▶ For Bluetooth[®] devices connected before last or connecting for the first time

- 4 Press the Bluetooth[®] button to enter pairing mode.

The Bluetooth[®] button on the front of the speaker (JBL Flex) flashes

and a search tone sounds.

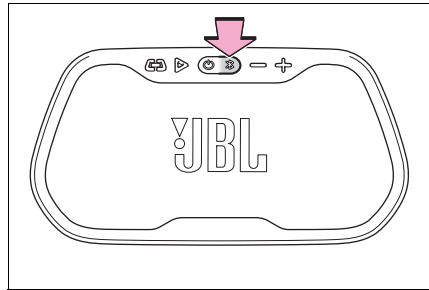

- 5 Search for Bluetooth[®] devices on the device to be connected, and select "TOYOTA JBL Flex".
- 6 When connected, the Bluetooth[®] button lights up and a connection tone is heard.

■ How to play

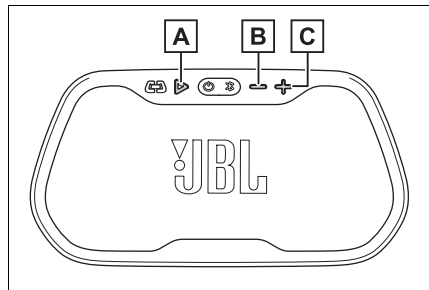

- A**  Once: play/pause
Twice: fast forward

- B**  Volume down

- C**  Volume up

■ Disconnect

Turn off the Bluetooth® function of the connected mobile phone/portable device.

Alternatively, cancel the connection registration on the connected mobile phone/portable device.

■ Turning off the power

Press power button.

A power down sound is played and the power button turns off.

■ Pairing

The speaker (JBL Flex) will stop pairing if no device is connected in pairing mode for 3 minutes.

Press the Bluetooth® button to pair again.

■ Automatic power off

It will automatically power off after 30 minutes of inactivity.

Using multiple speakers (JBL Flex)

JBL Link function allows connection with multiple speakers (JBL Flex)

■ Connect

- 1 Connect a Bluetooth® device to the main speaker (JBL Flex).
- 2 Turn on the power of all speakers (JBL Flex) to be used.
- 3 Press the link button of the main speaker (JBL Flex).

A search sound is played.

- 4 Press the link button on the speaker to be connected (JBL Flex).

The Bluetooth® button on the speaker (JBL Flex) will blink, and when the connection is complete, only the main speaker will turn on, and the connected speaker will turn off.

■ Disconnect

Pressing the power button, Bluetooth® button, link button or attaching the speaker (JBL Flex) to the dock will unpair it.

■ Maximum number of simultaneous connections

You can connect up to 100 speakers (JBL Flex).

■ Products able to be connected

Only JBL Flex can be connected. Other JBL products cannot be connected.

■ Volume during JBL Link

When pairing has succeeded, all paired speakers will have the same volume. If the volume is changed from connected Bluetooth® device or the main JBL Flex speaker, the volume of all speaker will remain in sync. If the volume is changed on a connected speaker, the speaker will lose sync with the main speaker (JBL Flex) or connected Bluetooth® device. To re-sync the speakers, the devices must be paired again.

About the lighting pattern of the light

Button	Pattern	Status
Blue-tooth® button	White (Flashes)	Blue-tooth® pairing mode
	White (Illuminates)	Any Blue-tooth® device connected
	Off	Power off
Power on		
Power button	White (Illuminates)	Power on
	Off	Power off

Troubleshooting

Cause	Solution
The power does not turn on even when the power button is pressed.	Make sure the device is charged.
The power turns on, but there is no sound.	Make sure it is paired.
	Press the volume button (+) on the unit to raise the volume and check.
	Check if playback on the audio device is paused.

Cause	Solution
Sound is distorted.	If the volume is too high, lower the volume on your device.
Pairing cannot be done.	Check if your device is compatible with this unit.
	Check if you are connected to another device. This unit remembers the information of the device with which it has been paired once. If it is desired to play music by reconnecting to the desired device, turn off all nearby paired Bluetooth® devices, and then turn the unit off and on again.

Initializing the speaker (JBL Flex)

Follow the steps below to restore the factory settings.

- 1 Turn on the power of the speaker (JBL Flex).
- 2 Press and hold the volume up button and play button at the same time for 3 seconds or more.
- 3 A power off sound will be heard, and when the power

turns off, initialization is complete.

Specifications

Non-Hazardous Automotive Speaker

Bluetooth® version	5.2
Transmission distance	1181.1 in. (30 m)
Bluetooth® profile	A2DP V1.3.2, AVRCP V1.6.2
Rated output power	Docked mode: 24Wpk Standalone player mode: 2 × 8Wpk
Transducer	0.07 × 1.4 in. (2 × 36 mm)
Frequency response	Docked mode: 180Hz - 19kHz (+/- 1dB) Standalone player mode: 70Hz - 20kHz (+/- 1dB)
Battery type	Lithium Ceramic Solid-State Battery (SSB)
Charge time	3.5 hours
Music play time	Up to 10 hours (Varies by volume level & audio content)

Dimensions (Width × Height × Depth)	7.3 × 3.7 × 2.0 in. (186 × 96 × 53 mm)
Weight	1.3 lb.(590g)
Ingress protection rating	IPX7

Garage door opener*

*: If equipped

The garage door opener can be programmed using the HomeLink® to operate garage doors, gates, entry doors, door locks, home lighting systems, security systems, and other devices.

■ HomeLink® programming procedure

The programming procedures can also be found at the following URL. Website: www.homelink.com/toyota



For support, contact customer support at the following.

Help Line: 1-800-355-3515

System components

The HomeLink® wireless control system in your vehicle has 3 buttons which can be programmed to operate 3 different devices. Refer to the programming methods on the following pages to determine the method which is appropriate for the device.

- ▶ Vehicles with auto anti-glare inside rear view mirror

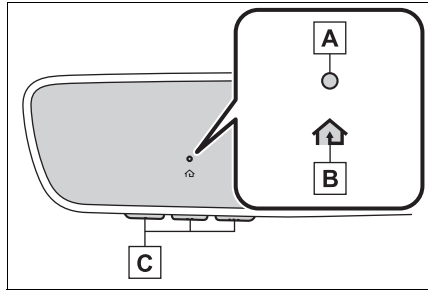

- A HomeLink® indicator light
- B HomeLink® icon
- C Buttons

- ▶ Vehicles with Digital Rear-view Mirror

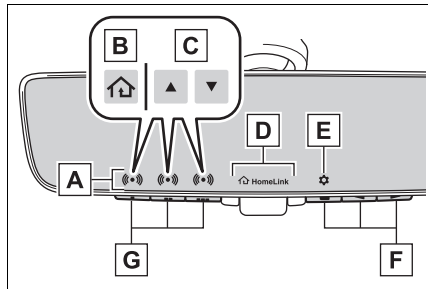

- A HomeLink® indicator light
Illuminates above each button selected.

- B HomeLink® icon
- C Garage door operation indicators

- D HomeLink® logo
Appears while HomeLink® is operating. When the menu button (→P.164) is pressed, the logo disappears even while the HomeLink® is operating.

E Setting icon

Press the menu button to change the setting.

F Menu buttons**G** HomeLink[®] buttons

■ Codes stored in the HomeLink[®] memory

- The registered codes are not erased even if the battery cable is disconnected.
- If learning failed when registering a different code to a HomeLink[®] button that already has a code registered to it, the already registered code will not be erased.

■ Certification

→P.704

WARNING

■ When programming a garage door or other remote control device

The garage door or other device may operate, so ensure people and objects are out of danger to prevent potential harm.

■ Conforming to federal safety standards

Do not use the HomeLink[®] compatible transceiver with any garage door opener or device that lacks safety stop and reverse features as required by federal safety standards.

This includes any garage door that cannot detect an interfering object. A door or device without these features increases the risk of death or serious injury.

■ When operating or programming HomeLink[®]

Never allow a child to operate or play with the HomeLink[®] buttons.

Programming the HomeLink[®]

■ Before programming HomeLink[®]

- During programming, it is possible that garage doors, gates, or other devices may operate. For this reason, make sure that people and objects are clear of the garage door or other devices to prevent injury or other potential harm.

- It is recommended that a new battery be placed in the remote control transmitter for more accurate programming.
- Garage door opener motors manufactured after 1995 may be equipped with rolling code protection. If this is the case, you may need a stepladder or other sturdy, safe device to reach the “Learn” or “Smart” button on the garage door opener motor.

■ Programming HomeLink[®]

Steps **2** through **4** must be performed within 60 seconds, otherwise the indicator light will stop flashing and programming will not be successfully com-

pleted.

- 1 Vehicles with Digital Rear-view Mirror: Press the HomeLink[®] button or menu button
When the HomeLink[®] button is pressed: HomeLink[®] Training Tutorial will be displayed to assist you programming the HomeLink[®].

When the menu button is pressed: Press the menu button  and select the "SET UP". HomeLink[®] Training Tutorial will be displayed to assist you programming the HomeLink[®].

- 2 Press and release the HomeLink[®] button you want to program and check that the HomeLink[®] indicator light flashes (orange).
- 3 Point the remote control transmitter for the device at the rear view mirror, 1 to 3 in. (25 to 75 mm) from the HomeLink[®] buttons.

Keep the HomeLink[®] indicator light in view while programming.

- ▶ Vehicles with auto anti-glare inside rear view mirror

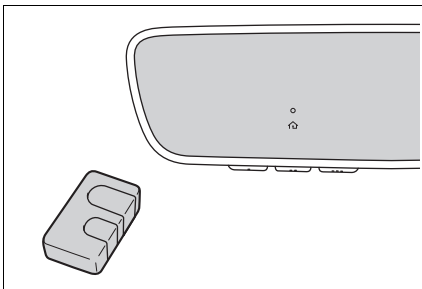

- ▶ Vehicles with Digital Rear-view Mirror

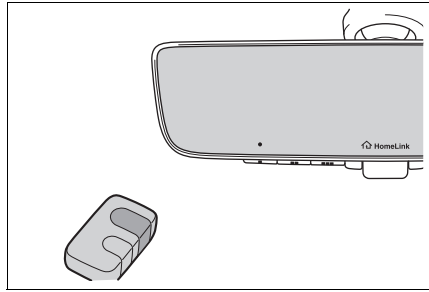

- 4 Program a device.

- ▶ Vehicles with auto anti-glare inside rear view mirror

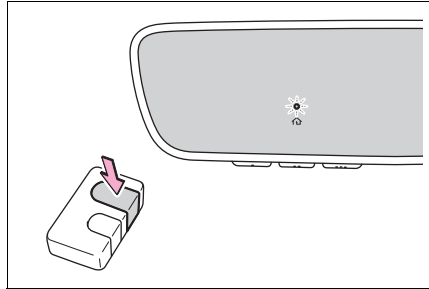

- ▶ Vehicles with Digital Rear-view Mirror

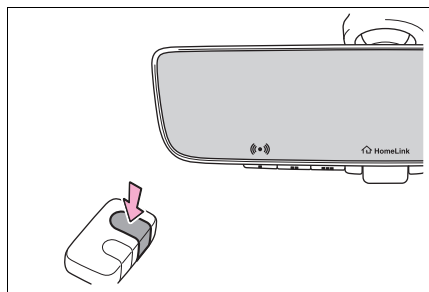

- ▶ Programming a device other than an entry gate (for U.S.A. owners)

Press and hold the remote control transmitter button until the HomeLink[®] indicator light changes from

slowly flashing orange to rapidly flashing green (rolling code) or continuously lit green (fixed code), then release the button.

- ▶ Programming an entry gate (for U.S.A. owners)/Programming a device in the Canadian market

Press and release the remote control transmitter button at 2 second intervals, repeatedly, until the HomeLink® indicator light changes from slowly flashing (orange) to rapidly flashing (green) (rolling code) or continuously lit (green) (fixed code).

- 5 Test the HomeLink® operation by pressing the newly programmed button and observing the indicator light:

- HomeLink® indicator light illuminates: Programming of a fixed code device has completed. The garage door or other device should operate when a HomeLink® button is pressed and released.
- HomeLink® indicator light flashes rapidly: The garage door opener motor or other device is equipped with a rolling code. To complete programming, firmly press and hold the HomeLink® button for 2 seconds then release it.
- If the garage door or other device does not operate, proceed to “Programming a roll-

ing code system”.

- 6 Repeat the steps above to program another device for any of the remaining HomeLink® buttons.

■ Programming a rolling code system

Two or more people may be necessary to complete rolling code programming.

- 1 Locate the “Learn” or “Smart” button on the garage door opener motor in the garage.

This button can usually be found where the hanging antenna wire is attached to the unit. The name and color of the button may vary by manufacturer. Refer to the owner’s manual supplied with the garage door opener motor for details.

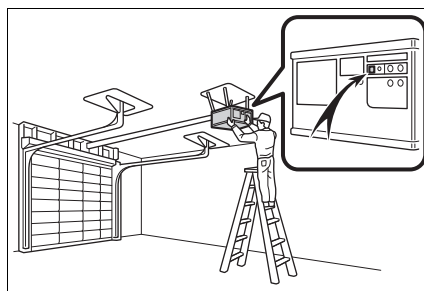

- 2 Press and release the “Learn” or “Smart” button.

Perform 3 within 30 seconds after

performing 2.

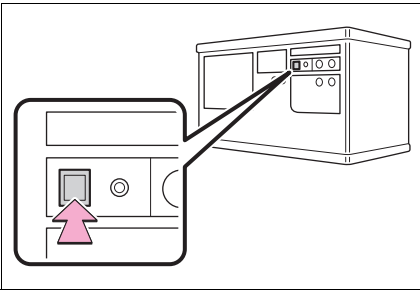

- 3 Press and hold the desired HomeLink[®] button (inside the vehicle) for 2 seconds and release it. Repeat this sequence (press/hold/release) up to 3 times to complete programming.

If the garage door opener motor operates when the HomeLink[®] button is pressed, the garage door opener motor recognizes the HomeLink[®] signal.

- ▶ Vehicles with auto anti-glare inside rear view mirror

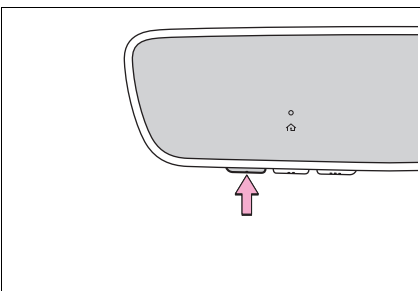

- ▶ Vehicles with Digital Rear-view Mirror

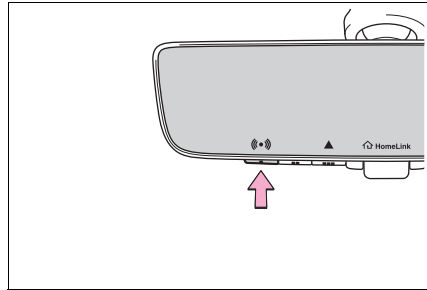

- **Enabling 2-way communication with a garage door (only available for compatible devices)**

When enabled, 2-way communication allows you to check the status of the opening and closing of a garage door through indicators in your vehicle.

2-way communication is only available if the garage door opener motor used is a compatible device. (To check device compatibility, refer to www.homelink.com.)

- 1 Within 5 seconds after programming the garage door opener has been completed, if the garage door opener motor is trained to HomeLink[®], both garage door operation indicators will flash rapidly (green) and the light on the garage door opener motor will blink twice, indicating that 2-way communication is enabled.

If the indicators do not flash, per-

form 2 and 3 within the first 10 presses of the HomeLink[®] button after programming has been completed.

- 2 Press a programmed HomeLink[®] button to operate a garage door.
- 3 Within 1 minute of pressing the HomeLink[®] button, after the garage door operation has stopped, press the “Learn” or “Smart” button on the garage door opener motor. Within 5 seconds of the establishment of 2-way communication with the garage door opener, both garage door operation indicators in the vehicle will flash rapidly (green) and the light on the garage door opener motor will blink twice, indicating that 2-way communication is enabled.

■ Reprogramming a single HomeLink[®] button

When the following procedure is performed, buttons which already have devices registered to them can be overwritten:

- 1 Press and hold the desired HomeLink[®] button.
- 2 When the HomeLink[®] indicator starts flashing orange, release the HomeLink[®] button and perform “Programming HomeLink[®]” 1 (it takes 20 seconds for the Home-

Link[®] indicator to start flashing).

■ Before programming

- Install a new battery in the transmitter.
- The battery side of the transmitter must be pointed away from the HomeLink[®] buttons.

Operating HomeLink[®]

Press the appropriate HomeLink[®] button. The HomeLink[®] indicator light should turn on.

The status of the opening and closing of a garage door is shown by the garage door opener indicators.

- ▶ Vehicles with auto anti-glare inside rear view mirror

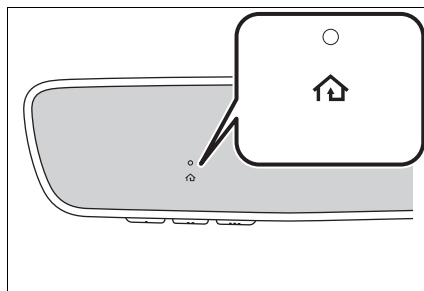

- ▶ Vehicles with Digital Rear-view Mirror

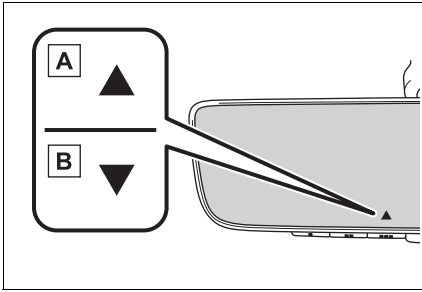

A Opening









B Closing

This function is only available if the garage door opener motor used is a compatible device. (To check device compatibility, refer to www.homelink.com.)

Color	Status
Orange (flashing)	Currently opening/closing
Green	Opening/closing has completed
Red (flashing)	Feedback signals cannot be received

The indicators can operate within approximately 820 ft. (250 m) of the garage door. However, if there are obstructions between the garage door and the vehicle, such as houses and trees, feedback signals from the garage door may not be received.

To recall the previous door operation status, press and release

either HomeLink® buttons  and  or  and  (vehicles with auto anti-glare inside rear view mirror),  and  or  and  (vehicles with Digital Rear-view Mirror), simultaneously. The last recorded status will be displayed for 3 seconds.

Erasing the entire HomeLink® memory (all three codes)

Press and hold the 2 outside buttons for 10 seconds until the HomeLink® indicator light changes from continuously lit (orange) to rapidly flashing (green).

If you sell your vehicle, be sure to erase the programs stored in the HomeLink® memory.

- ▶ Vehicles with auto anti-glare inside rear view mirror

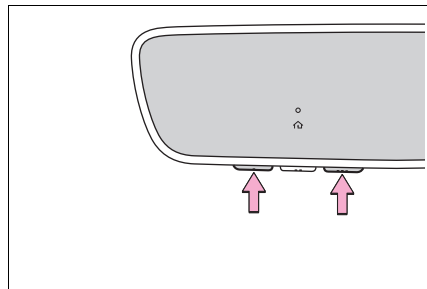

► Vehicles with Digital Rear-view Mirror

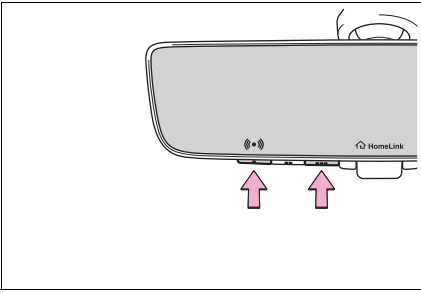

Maintenance and care

6

6-1. Maintenance and care

- Cleaning and protecting the vehicle exterior 514
- Cleaning and protecting the vehicle interior 517

6-2. Maintenance

- Maintenance requirements 520
- General maintenance.. 522
- Emission inspection and maintenance (I/M) programs 525

6-3. Do-it-yourself maintenance

- Do-it-yourself service precautions..... 526
- Hood 528
- Engine compartment... 530
- Tires 539
- Tire inflation pressure.. 553
- Wheels 555
- Air conditioning filter.... 557
- Electronic key battery.. 558
- Checking and replacing fuses..... 560
- Light bulbs..... 563

Cleaning and protecting the vehicle exterior

Perform cleaning in a manner appropriate to each component and its material.

Cleaning instructions

- Working from top to bottom, liberally apply water to the vehicle body, wheel wells and underside of the vehicle to remove any dirt and dust.
- Wash the vehicle body using a sponge or soft cloth, such as a chamois.
- For hard-to-remove marks, use car wash soap and rinse thoroughly with water.
- Wipe away any water.
- Wax the vehicle when the waterproof coating deteriorates.

If water does not bead on a clean surface, apply wax when the vehicle body is cool.

■ Automatic car washes

- Fold the mirrors before washing the vehicle.

Start washing from the front of the vehicle. Extend the mirrors before driving.

- Turn off the power back door (if equipped).
- Brushes used in automatic car washes may scratch the vehicle

surface, parts (wheel, etc.) and harm your vehicle's paint.

- Rear spoiler may not be washable in some automatic car washes. There may also be an increased risk of damage to vehicle.
- Remove the hitch cover before washing the vehicle. Otherwise, it may be lost. (→P.213)

■ High pressure car washes

As water may enter the cabin, do not bring the nozzle tip near the gaps around the doors or perimeter of the windows, or spray these areas continuously.

■ When using a car wash

If the door handle becomes wet while the electronic key is within the effective range, the door may lock and unlock repeatedly. In that case, follow the following correction procedures to wash the vehicle:

- Place the key in a position 6 ft. (2 m) or more separate from the vehicle while the vehicle is being washed. (Take care to ensure that the key is not stolen.)
- Set the electronic key to battery-saving mode to disable the Smart key system. (→P.146)

■ Wheels and wheel ornaments (vehicles without matte painted wheels)

- Remove any dirt immediately by using a neutral detergent.
- Wash detergent off with water immediately after use.
- To protect the paint from damage, make sure to observe the following precautions.
 - Do not use acidic, alkaline or abrasive detergent
 - Do not use hard brushes
 - Do not use detergent on the wheels when they are hot, such as after driving or parking in hot weather

■ **Wheels and wheel ornaments (vehicles with matte painted wheels)**

A different set of care is necessary for matte painted wheels and wheel ornaments. Contact your Toyota dealer for details.

- Remove dirt using water as early as possible. If the wheels are excessively dirty, use diluted neutral detergent.
- When using detergent, make sure to rinse it off with water immediately. Then use a soft cloth to wipe off the water.
- Use a sponge or soft cloth to remove the dirt by hand.
- To prevent the matte paint from being damaged or glossy, make sure to observe the following precautions:
 - Do not apply any coatings or wax.
 - Do not use acidic, alkaline or abrasive detergents.
 - When using tire cleaners or tire wax, do not allow them to be applied to the wheels.
 - Do not scrub or polish the wheels using a brush or dry cloth, etc.
 - Do not use a high pressure washer or steam cleaner.
 - Do not use detergent on the wheels when they are hot, such as after driving or parking in hot weather.

■ **Brake pads and calipers**

Rust may form if the vehicle is parked with wet brake pads or disc rotors, causing them to stick. Before parking the vehicle after it is washed, drive slowly and apply the brakes several times to dry the parts.

■ **Bumpers and wheel arch moldings**

Do not scrub with abrasive cleaners.

■ **Plated portions**

If dirt cannot be removed, clean the parts as follows:

- Use a soft cloth dampened with an approximately 5% solution of neutral detergent and water to clean the dirt off.
- Wipe the surface with a dry, soft cloth to remove any remaining moisture.
- To remove oily deposits, use alcohol wet wipes or a similar product.



WARNING

■ **When washing the vehicle**

Do not apply water to the inside of the engine compartment. Doing so may cause the electrical components, etc. to catch fire.

■ **Precautions regarding the exhaust pipe**

Exhaust gases cause the exhaust pipe to become quite hot. When washing the vehicle, be careful not to touch the pipe until it has cooled sufficiently, as touching hot exhaust pipe can cause burns.

■ **Precaution regarding the front and rear bumpers**

If the paint of the rear bumper is chipped or scratched, the following systems may not function correctly. If this occurs, consult your Toyota dealer.

- BSM
- RCTA
- PKSB (if equipped)
- Secondary Collision Brake
- Intuitive parking assist (if equipped)



NOTICE

■ **To prevent paint deterioration and corrosion on the body and components (aluminum wheels, etc.)**

- Wash the vehicle immediately in the following cases:
 - After driving near the sea coast
 - After driving on salted roads
 - If coal tar or tree sap is present on the paint surface
 - If dead insects, insect droppings or bird droppings are present on the paint surface
 - After driving in an area contaminated with soot, oily smoke, mine dust, iron powder or chemical substances
 - If the vehicle becomes heavily soiled with dust or mud
 - If liquids such as benzene and gasoline are spilled on the paint surface
- If the paint is chipped or scratched, have it repaired immediately.
- To prevent the wheels from corroding, remove any dirt and store in a place with low humidity when storing the wheels.

■ **Cleaning the exterior lights**

- Wash carefully. Do not use organic substances or scrub with a hard brush. This may damage the surfaces of the lights.
- Do not apply wax to the surfaces of the lights. Wax may cause damage to the lenses.

■ **When using a high pressure car wash**

- When washing the vehicle, do not spray the camera or its surrounding area directly with a high pressure washer. Shock applied from high pressure water may cause the device to not operate normally.
- Do not spray water directly on the radar which is equipped behind the grill. Otherwise it may cause the device to be damaged.
- Do not bring the nozzle tip close to boots (rubber or resin manufactured cover), connectors or the following parts. The parts may be damaged if they come into contact with high-pressure water.
 - Traction related parts
 - Steering parts
 - Suspension parts
 - Brake parts
- Keep the cleaning nozzle at least 11.9 in. (30 cm) away from the vehicle body. Otherwise resin section, such as moldings and bumpers, may be deformed and damaged.

Also, do not continuously hold the nozzle in the same place.

- Do not spray the lower part of the windshield continuously.
- If water enters the air conditioning system intake located near the lower part of the windshield, the air conditioning system may not operate correctly.
- Do not wash the underside of the vehicle using a high pressure car washer.

 NOTICE**■ When raising the windshield wiper arms**

Make sure to hold the hook parts of the wiper arms to raise them. Do not hold only the wiper blades when raising them, or it may cause deformation of the wiper blades.

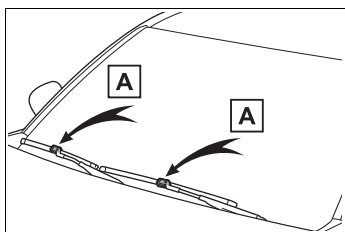

A Hook parts

■ Cleaning the high mounted stoplight

When using high-pressured car washers, the tip of the nozzle should be at least 20 in. (50 cm) from the car body. Water can seep lamp housing or the vehicle cabin if the nozzle is closer to the car body.

Cleaning and protecting the vehicle interior

Perform cleaning in a manner appropriate to each component and its material.

Protecting the vehicle interior

- Remove dirt and dust using a vacuum cleaner. Wipe dirty surfaces with a cloth dampened with lukewarm water.
- If dirt cannot be removed, wipe it off with a soft cloth dampened with neutral detergent diluted to approximately 1%.

Wring out any excess water from the cloth and thoroughly wipe off remaining traces of detergent and water.

■ Shampooing the carpets

There are several commercial foaming-type cleaners available. Use a sponge or brush to apply the foam. Rub in overlapping circles. Do not use water. Wipe dirty surfaces and let them dry. Excellent results are obtained by keeping the carpet as dry as possible.

■ Handling the seat belts

Clean with mild soap and lukewarm water using a cloth or sponge. Also check the belts periodically for excessive wear, fraying or cuts.

**WARNING****■ Water in the vehicle**

Do not get any of the SRS components or wiring in the vehicle interior wet. (→P.36)

An electrical malfunction may cause the airbags to deploy or not function properly, resulting in death or serious injury.

■ Cleaning the interior (especially instrument panel)

Do not use a polish wax or polish cleaner. The instrument panel may reflect off the windshield, obstructing the driver's view and leading to an accident, resulting in death or serious injury.

**NOTICE****■ Cleaning detergents**

- Do not use the following types of detergent, as they may discolor the vehicle interior or cause streaks or damage to painted surfaces:
 - Areas other than the seats and steering wheel: Organic substances such as benzene or gasoline, alkaline or acidic solutions, dye, and bleach
 - Seats: Alkaline or acidic solutions, such as thinner, benzene, and alcohol
 - Steering wheel: Organic substances, such as thinner, and cleaner that contains alcohol
- Do not use a polish wax or polish cleaner. The instrument panel's or other interior part's painted surface may be damaged.

■ Preventing damage to leather surfaces

Observe the following precautions to avoid damage to and deterioration of leather surfaces:

- Remove any dust or dirt from leather surfaces immediately.
- Do not expose the vehicle to direct sunlight for extended periods of time. Park the vehicle in the shade, especially during summer.
- Do not place items made of vinyl, plastic, or containing wax on the upholstery, as they may stick to the leather surface if the vehicle interior heats up significantly.

■ Water on the floor

Do not wash the vehicle floor with water.

Vehicle systems such as the audio system may be damaged if water comes into contact with electrical components such as the audio system above or under the floor of the vehicle. Water may also cause the body to rust.

■ When cleaning the inside of the windshield

Do not allow glass cleaner to contact the lens. Also, do not touch the lens. (→P.251)

■ Cleaning the inside of the rear window

- Do not use a glass cleaner to clean the rear window, as this may cause damage to the rear window defogger heater wires or antenna. Use a cloth dampened with lukewarm water to gently wipe the window clean. Wipe the window in strokes running parallel to the heater wires or antenna.

**NOTICE**

- Be careful not to scratch or damage the heater wires or antenna.

Cleaning the areas with satin-finish metal accents

- Remove dirt using a water-dampened soft cloth or synthetic chamois.
- Wipe the surface with a dry, soft cloth to remove any remaining moisture.

Cleaning the areas with satin-finish metal accents

The metal areas use a layer of real metal for the surface. It is necessary to clean them regularly. If dirty areas are left uncleaned for long periods of time, they may be difficult to clean.

Cleaning the leather areas

- Remove dirt and dust using a vacuum cleaner.
- Wipe off any excess dirt and dust with a soft cloth dampened with diluted detergent.

Use a diluted water solution of approximately 5% neutral wool detergent.

- Wring out any excess water from the cloth and thoroughly wipe off all remaining traces of detergent.
- Wipe the surface with a dry, soft cloth to remove any remaining moisture. Allow the

leather to dry in a shaded and ventilated area.

Caring for leather areas

Toyota recommends cleaning the interior of the vehicle at least twice a year to maintain the quality of the vehicle's interior.

Cleaning the synthetic leather areas

- Remove dirt and dust using a vacuum cleaner.
- Wipe it off with a soft cloth dampened with neutral detergent diluted to approximately 1%.
- Wring out any excess water from the cloth and thoroughly wipe off remaining traces of detergent and water.

Maintenance requirements

To ensure safe and economical driving, day-to-day care and regular maintenance are essential. It is the owner's responsibility to perform regular checks. Toyota recommends the maintenance below.

■ Repair and replacement

It is recommended that genuine Toyota parts be used for repairs to ensure performance of each system. If non-Toyota parts are used in replacement or if a repair shop other than a Toyota dealer performs repairs, confirm the warranty coverage.

■ Allow inspection and repairs to be performed by a Toyota dealer

- Toyota technicians are well-trained specialists and are kept up to date with the latest service information. They are well informed about the operation of all systems on your vehicle.
- Keep a copy of the repair order. It proves that the maintenance that has been performed is under warranty coverage. If any problem should arise while your vehicle is under warranty, your Toyota dealer will promptly take care of it.



WARNING

■ If your vehicle is not properly maintained

Improper maintenance could result in serious damage to the vehicle and possible death or serious injury.

■ Handling of the battery

- Engine exhaust, some of its constituents, and a wide variety of automobile components contain or emit chemicals known to the State of California to cause cancer and birth defects and other reproductive harm. Work in a well ventilated area.
- Oils, fuels and fluids contained in vehicles as well as waste produced by component wear contain or emit chemicals known to the State of California to cause cancer and birth defects or other reproductive harm. Avoid exposure and wash any affected area immediately.
- Battery posts, terminals and related accessories contain lead and lead compounds which are known to cause brain damage. Wash your hands after handling. (→P.535)

General maintenance

General maintenance should be performed on a daily basis. This can be done by yourself or by a Toyota dealer.

Scheduled maintenance

Scheduled maintenance should be performed at specified intervals according to the maintenance schedule.









For details about maintenance items and schedules, refer to the "Scheduled Maintenance Guide" or "Owner's Manual Supplement".

■ Resetting the message indicating maintenance is required







After the required maintenance is performed according to the maintenance schedule, please reset the message.



To reset the message, follow the procedure described below:

► Vehicles with 7-inch display

- 1 Press  or  of the meter control switch to select .
- 2 Press  or  to select “Vehicle Settings” and then press and hold OK .
- 3 Press  /  to select “Scheduled Maintenance” and then press OK .
- 4 Press  /  to select “Yes” and then press OK .

► Vehicles with 12.3-inch display

- 1 Press and hold OK to display the cursor on the content display area (center) of the multi-information display.
- 2 Press  or  of the meter control switches to select  “Settings” and then press OK .
- 3 Press  or  to select “Vehicle Settings” and then press and hold OK .
- 4 Press  or  to select “Scheduled Maintenance” and then press OK .

- 5 Press  or  to select “Yes” and then press OK .

Do-it-yourself maintenance

You can perform some maintenance procedures by yourself. Please be aware that do-it-yourself maintenance may affect warranty coverage.

The use of Toyota repair manuals is recommended.

For details about warranty coverage, refer to the separate “Owner’s Warranty Information Booklet” or “Owner’s Manual Supplement”.

General maintenance

Listed below are the general maintenance items that should be performed at the intervals specified in the “Owner’s Warranty Information Booklet” or “Owner’s Manual Supplement/Scheduled Maintenance Guide”. It is recommended that any problem you notice should be brought to the attention of your Toyota dealer or qualified service shop for advice.



WARNING

■ If the engine is running

Turn the engine off and ensure that there is adequate ventilation before performing maintenance checks.

Engine compartment

Items	Check points
Battery	Check the connections. (→P.535)
Brake fluid	Is the brake fluid at the correct level? (→P.535)
Engine/coolant	Is the engine/inter-cooler/power control unit coolant at the correct level? (→P.533)

Items	Check points
Engine oil	Is the engine oil at the correct level? (→P.531)
Exhaust system	There should not be any fumes or strange sounds.
Radiator/condenser/inter-cooler	The radiator, condenser and inter-cooler should be free from foreign objects. (→P.534)
Washer fluid	Is there sufficient washer fluid? (→P.538)

Vehicle interior

Items	Check points
Accelerator pedal	<ul style="list-style-type: none"> The accelerator pedal should move smoothly (without uneven pedal effort or catching).
Automatic transmission “Park” mechanism	<ul style="list-style-type: none"> When parked on a slope and the shift lever is in P, is the vehicle securely stopped?

Items	Check points
Brake pedal	<ul style="list-style-type: none"> • Does the brake pedal move smoothly? • Does the brake pedal have appropriate clearance from the floor? • Does the brake pedal have the correct amount of free play?
Brakes	<ul style="list-style-type: none"> • The vehicle should not pull to one side when the brakes are applied. • The brakes should work effectively. • The brake pedal should not feel spongy. • The brake pedal should not get too close to the floor when the brakes are applied.
Head restraints	<ul style="list-style-type: none"> • Do the head restraints move smoothly and lock securely?
Indicators/buzzers	<ul style="list-style-type: none"> • Do the indicators and buzzers function properly?

Items	Check points
Parking brake	<ul style="list-style-type: none"> • Does the parking brake operate normally? • When parked on a slope and the parking brake is on, is the vehicle securely stopped?
Seat belts	<ul style="list-style-type: none"> • Do the seat belts operate smoothly? • The seat belts should not be damaged.
Seats	<ul style="list-style-type: none"> • Do the seat controls operate properly?
Steering wheel	<ul style="list-style-type: none"> • Does the steering wheel rotate smoothly? • Does the steering wheel have the correct amount of free play? • There should not be any strange sounds coming from the steering wheel.

Vehicle exterior

Items	Check points
Doors	<ul style="list-style-type: none"> Do the doors operate smoothly?
Engine hood	<ul style="list-style-type: none"> Does the hood lock system work properly?
Fluid leaks	<ul style="list-style-type: none"> There should not be any signs of fluid leakage after the vehicle has been parked.
Lights	<ul style="list-style-type: none"> Do all the lights come on?

Items	Check points
Tires	<ul style="list-style-type: none"> Is the tire inflation pressure correct? The tires should not be damaged or excessively worn. Have the tires been rotated according to the maintenance schedule? The wheel nuts should not be loose.
Windshield wipers	<ul style="list-style-type: none"> The wiper blades should not show any signs of cracking, splitting, wear, contamination or deformation. The wiper blades should clear the windshield without streaking or skipping.

Emission inspection and maintenance (I/M) programs

Some states have vehicle emission inspection programs which include OBD (On Board Diagnostics) checks. The OBD system monitors the operation of the emission control system.

If the malfunction indicator lamp comes on

The OBD system determines that a problem exists somewhere in the emission control system. Your vehicle may not pass the I/M test and may need to be repaired. Contact your Toyota dealer to service the vehicle.

Your vehicle may not pass the I/M test in the following situations:

- When the battery is disconnected or discharged Readiness codes that are set during ordinary driving are erased. Also, depending on your driving habits, the readiness codes may not be completely set.
- When the fuel tank cap is loose

The malfunction indicator lamp comes on indicating a temporary malfunction and your vehicle may not pass the I/M test.

When the malfunction indicator lamp still remains on after several driving trips

The error code in the OBD system will not be cleared unless the vehicle is driven 40 or more times.

If your vehicle does not pass the I/M test

Contact your Toyota dealer to prepare the vehicle for re-testing.

Do-it-yourself service precautions

If you perform maintenance by yourself, be sure to follow the correct procedure as given in these sections.

Maintenance

Items	Parts and tools
Battery condition (→P.535)	<ul style="list-style-type: none"> • Grease • Warm water • Baking soda • Distilled water • Conventional wrench (for terminal clamp bolts)
Brake fluid level (→P.535)	<ul style="list-style-type: none"> • FMVSS No.116 DOT 3 or SAE J1703 brake fluid • FMVSS No.116 DOT 4 or SAE J1704 brake fluid • Rag or paper towel • Funnel (used only for adding brake fluid)

Items	Parts and tools
Engine/coolant level (→P.533)	<ul style="list-style-type: none"> • “Toyota Super Long Life Coolant” or a similar high quality ethylene glycol-based non-silicate, non-amine, non-nitrite and non-borate coolant with longlife hybrid organic acid technology For the U.S.A.: “Toyota Super Long Life Coolant” is pre-mixed with 50% coolant and 50% deionized water. For Canada: “Toyota Super Long Life Coolant” is pre-mixed with 55% coolant and 45% deionized water. • Funnel (used only for adding coolant)
Engine oil level (→P.531)	<ul style="list-style-type: none"> • “Toyota Genuine Motor Oil” or equivalent • Rag or paper towel • Funnel (used only for adding engine oil)
Fuses (→P.560)	<ul style="list-style-type: none"> • Fuse with same amperage rating as original

Items	Parts and tools
Light bulbs (→P.564)	<ul style="list-style-type: none"> • Bulb with same number and wattage rating as original • Phillips-head screwdriver • Wrench
Radiator, condenser and intercooler (→P.534)	Funnel (used only for adding coolant)
Tire inflation pressure (→P.553)	<ul style="list-style-type: none"> • Tire pressure gauge • Compressed air source
Washer fluid (→P.538)	<ul style="list-style-type: none"> • Water or washer fluid containing antifreeze (for winter use) • Funnel (used only for adding water or washer fluid)

⚠ WARNING

The engine compartment contains many mechanisms and fluids that may move suddenly, become hot, or become electrically energized. To avoid death or serious injury, observe the following precautions.

■ **When working on the engine compartment**

- Keep hands, clothing and tools away from the moving fan and engine.
- Be careful not to touch the engine, inverter, radiator, exhaust manifold, etc., right after driving as they may be hot. Oil and other fluids may also be hot.

- Do not leave anything that may burn easily, such as paper and rags, in the engine compartment.
- Do not smoke, cause sparks or expose an open flame to fuel.

■ **When working near the electric cooling fan or radiator grille**

Be sure the engine switch is off. With the engine switch in ON, the electric cooling fan may automatically start to run if the air conditioning is on and/or the coolant temperature is high. (→P.534)

■ **Safety glasses**

Wear safety glasses to prevent flying or falling material, fluid spray, etc., from getting in your eyes.

⚠ NOTICE

■ **If you remove the air cleaner filter**

Driving with the air cleaner filter removed may cause excessive engine wear due to dirt in the air.

Hood

Opening the hood

- 1 Pull the hood lock release lever.

The hood will pop up slightly.

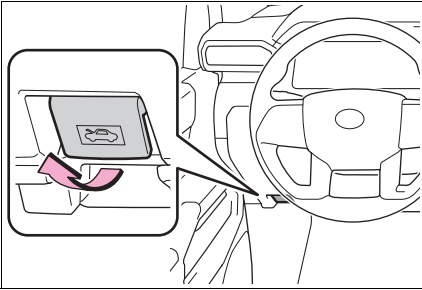

- 2 Pull up the auxiliary catch lever and lift the hood.

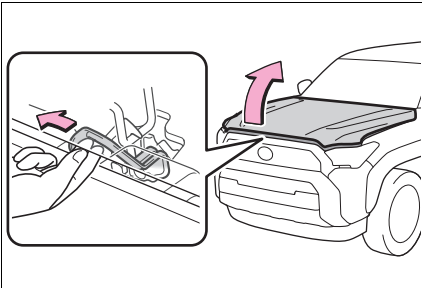

- 3 Hold the hood open by inserting the supporting rod into the slot **A** or **B**.

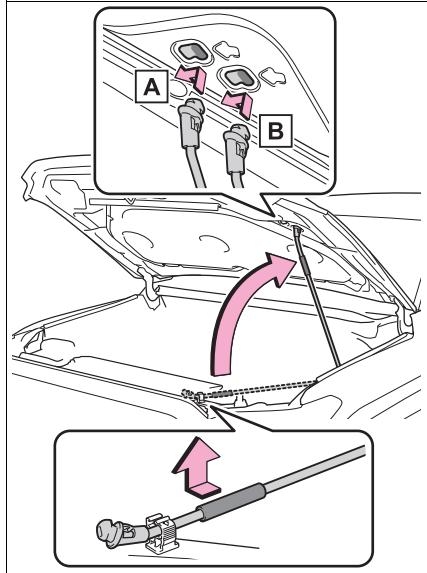

A Standard Opening

B Wider Opening

⚠ WARNING

■ **Pre-driving check**
Check that the hood is fully closed and locked.
If the hood is not locked properly, it may open while the vehicle is in motion and cause an accident, which may result in death or serious injury.

■ **When the hood is open**
Even if the engine switch is turned off, the cooling fan may continue to operate for a short time. When the cooling fan is rotating, do not touch or approach the inside of the engine compartment.

**WARNING****■ After installing the support rod into the slot**

Make sure the rod supports the hood securely from falling down on to your head or body.

**NOTICE****■ When closing the hood**

Be sure to return the support rod to its clip before closing the hood.

Closing the hood with the support rod up could cause the hood to bend.

Engine compartment

Components

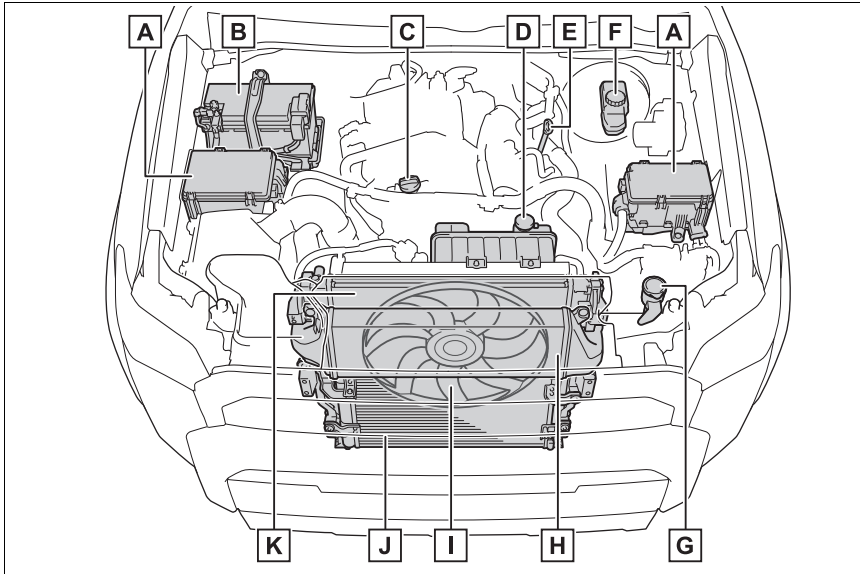

- A** Fuse boxes (→P.560)
- B** Battery (→P.535)
- C** Engine oil filler cap (→P.532)
- D** Engine coolant reservoir (→P.533)
- E** Engine oil level dipstick (→P.531)
- F** Brake fluid reservoir (→P.535)
- G** Washer fluid tank (→P.538)
- H** Intercooler (→P.534)
- I** Cooling fan
- J** Condenser (→P.534)
- K** Radiator (→P.534)

Checking the engine oil

With the engine at operating temperature and turned off, check the oil level on the dipstick.

- 1 Park the vehicle on level ground. After warming up the engine and turning off the engine, wait about 5 minutes for the oil to drain back into the bottom of the engine.
- 2 Holding a rag under the end, pull the dipstick out.

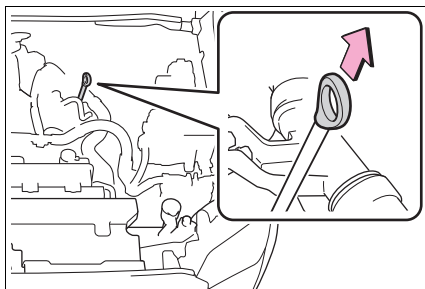

- 3 Wipe the dipstick clean.
- 4 Reinsert the dipstick fully
- 5 Holding a rag under the end, pull the dipstick out and check whether the oil level is above low level mark.

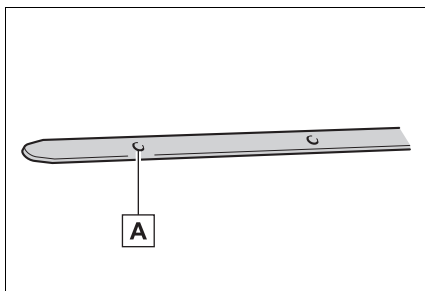

A Low level mark

The shape of the dipstick may differ depending on the type of vehicle or engine.

- 6 Wipe the dipstick and reinsert it fully.



NOTICE

■ To prevent serious engine damage

Check the oil level on a regular basis.

■ Engine oil consumption

A certain amount of engine oil will be consumed while driving. In the following situations, oil consumption may increase, and engine oil may need to be refilled in between oil maintenance intervals.

- When the engine is new, for example directly after purchasing the vehicle or after replacing the engine
- If low quality oil or oil of an inappropriate viscosity is used
- When driving at high engine speeds or with a heavy load, when towing, or when driving while accelerating or decelerating frequently
- When leaving the engine idling for a long time, or when driving frequently through heavy traffic

■ Engine oil level rise

If the vehicle is repeatedly driven without the engine warmed up, moisture caused by dew condensation inside the engine or fuel which did not burn mixes into the engine oil, resulting in a rise in engine oil level.

However, this is not a malfunction.

For example, the engine become difficult to be warmed up in the following situations.

- When driving a short distance

- When driving at a low speed
- When the outside temperature is low

When checking the engine oil, make sure that the engine is warmed up. If the engine oil level exceeds the refill upper limit mark, contact your Toyota dealer.

Adding engine oil

■ Checking the oil type and preparing the items needed

Make sure to check the oil type and prepare the items needed before adding oil.

- Engine oil selection

→P.618

- Oil quantity (Low level mark
→ Refill upper limit mark)

1.5 qt. (1.4 L, 1.2 Imp.qt.)

- Items

Clean funnel

■ Adding engine oil

If the oil level is below or near the low level mark, add engine oil of the same type as that already in the engine.

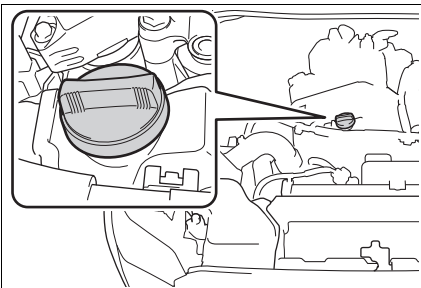

- 1 Remove the oil filler cap by turning it counterclockwise.

- 2 Add engine oil slowly, checking the dipstick.

Make sure that the oil level does not exceed the refill upper limit mark and is between the low level mark and refill upper limit mark.

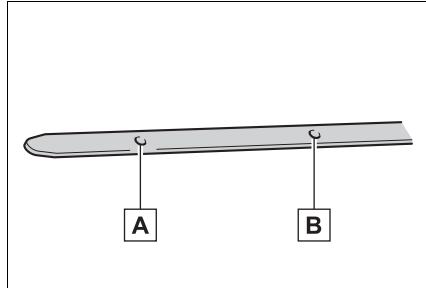

A Low level mark

B Refill upper limit mark

The shape of the dipstick may differ depending on the type of vehicle or engine.

- 3 Install the oil filler cap by turning it clockwise.

■ After changing the engine oil

The engine oil maintenance data should be reset. Perform the following procedures:

▶ Vehicles with 7-inch display

- 1 Press **▲** or **▼** of the meter control switch to select **⚙**.
- 2 Press **◀** or **▶** to select "Vehicle Settings" and then press and hold **OK**.
- 3 Press **▲** / **▼** to select "Oil Maintenance" and then press **OK**.

- 4 Press \wedge / \vee to select “Yes” and then press OK .
- ▶ Vehicles with 12.3-inch display
- 1 Press and hold OK to display the cursor on the content display area (center) of the multi-information display.
- 2 Press \wedge or \vee of the meter control switches to select “ Settings” and then press OK .
- 3 Press \wedge or \vee to select “Vehicle Settings” and then press and hold OK .
- 4 Press \wedge or \vee to select “Oil Maintenance” and then press OK .
- 5 Press \wedge or \vee to select “Yes” and then press OK .

WARNING

■ **Used engine oil**

- Used engine oil contains potentially harmful contaminants which may cause skin disorders such as inflammation and skin cancer, so care should be taken to avoid prolonged and repeated contact. To remove used engine oil from your skin, wash thoroughly with soap and water.

- Dispose of used oil and filters only in a safe and acceptable manner. Do not dispose of used oil and filters in household trash, in sewers or onto the ground. Call your Toyota dealer, service station or auto parts store for information concerning recycling or disposal.

- Do not leave used engine oil within the reach of children.

NOTICE

■ **When replacing the engine oil**

- Be careful not to spill engine oil on the vehicle components.
- Avoid overfilling, or the engine could be damaged.
- Check the oil level on the dipstick every time you refill the vehicle.
- Be sure the engine oil filler cap is properly tightened.

■ **If oil is spilled on the engine cover**

To prevent the engine cover from being damaged, remove any engine oil from the engine cover as soon as possible using a neutral detergent. Do not use an organic solvent such as brake cleaner.

Checking the coolant

The coolant level is satisfactory if it is between the “F” and “L” lines on the reservoir when the engine is cold.

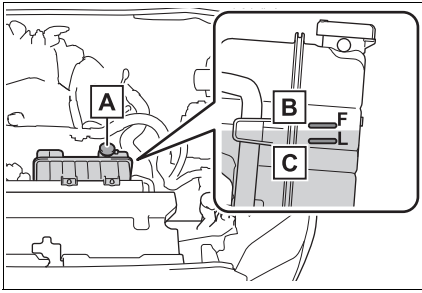

A Engine coolant reservoir cap

B “F” line

C “L” line

If the level is on or below the “L” line, add coolant up to the “F” line. (→P.612)

■ Coolant selection

Only use “Toyota Super Long Life Coolant” or a similar high quality ethylene glycol based non-silicate, non-amine, non-nitrite, and non-borate coolant with long-life hybrid organic acid technology.

U.S.A.: “Toyota Super Long Life Coolant” is a mixture of 50% coolant and 50% deionized water.

(Minimum temperature: -31°F [-35°C])

Canada: “Toyota Super Long Life Coolant” is a mixture of 55% coolant and 45% deionized water.

(Minimum temperature: -44°F [-42°C])

For more details about coolant, contact your Toyota dealer.

■ If the coolant level drops within a short time of replenishing

Visually check the radiator, hoses, engine coolant reservoir cap, inter-coolant reservoir cap, drain cock and water pump.

If you cannot find a leak, have your Toyota dealer test the cap and check for leaks in the cooling sys-

tem.

⚠ WARNING

■ When the engine is hot

Do not remove the coolant reservoir cap. The cooling system may be under pressure and may spray hot coolant if the cap is removed, causing serious injuries, such as burns.

⚠ NOTICE

■ When adding coolant

Coolant is neither plain water nor straight antifreeze. The correct mixture of water and antifreeze must be used to provide proper lubrication, corrosion protection and cooling. Be sure to read the antifreeze or coolant label.

■ If you spill coolant

Be sure to wash it off with water to prevent it from damaging parts or paint.

Checking the radiator, condenser and inter-cooler

Check the radiator, condenser and intercooler and clear away any foreign objects. If either of the above parts is extremely dirty or you are not sure of their condition, have your vehicle inspected by your Toyota dealer.

⚠ WARNING

■ When the engine is hot

Do not touch the radiator or inter-cooler as they may be hot and cause serious injuries, such as burns.

⚠ WARNING**■ When the electric cooling fan is operating**

Do not touch the engine compartment.

With the engine switch in ON, the electric cooling fan may automatically start to run if the air conditioning is on and/or the coolant temperature is high. Be sure the engine switch is off when working near the electric cooling fan or radiator grille.

The electric cooling fan may work for a while even after the engine switch is off.

● Fluid type

FMVSS No.116 DOT 3 or SAE J1703 brake fluid

FMVSS No.116 DOT 4 or SAE J1704 brake fluid

● Item

Clean funnel

■ Brake fluid can absorb moisture from the air

Excess moisture in the brake fluid can cause a dangerous loss of braking efficiency. Use only newly opened brake fluid.

Checking and adding the brake fluid**■ Checking fluid level**

The brake fluid level should be between the “MAX” and “MIN” lines on the tank.

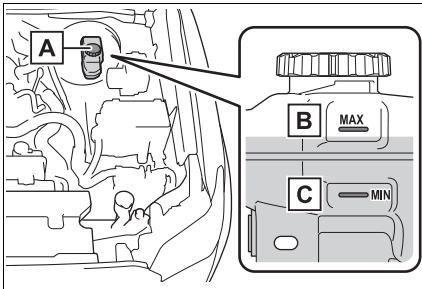

A Brake fluid reservoir cap

B “MAX” line

C “MIN” line

■ Adding fluid

Make sure to check the fluid type and prepare the necessary item.

⚠ WARNING**■ When filling the reservoir**

Take care as brake fluid can harm your hands and eyes and damage painted surfaces.

If fluid gets on your hands or in your eyes, flush the affected area with clean water immediately.

If you still experience discomfort, see a doctor.

⚠ NOTICE**■ If the fluid level is low or high**

It is normal for the brake fluid level to go down slightly as the brake pads wear out or when the fluid level in the accumulator is high. If the reservoir needs frequent refilling, there may be a serious problem.

Checking the battery

Check the battery as follows.

■ Battery exterior

Make sure that the battery terminals are not corroded and that

there are no loose connections, cracks, or loose clamps.

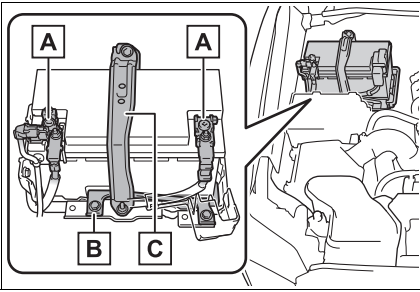

A Terminals

B Hold-down clamp

C Bracket

■ Checking the battery condition

Check the battery condition by indicator color.

▶ Type A

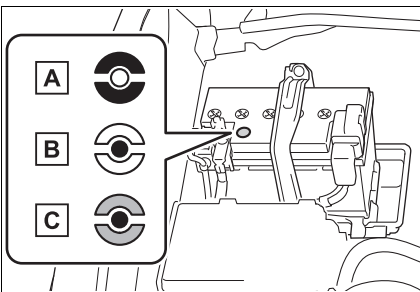

A Red and white: Replacement is necessary.

Have the battery checked by your Toyota dealer.

B White and red: Charging is necessary.

Have the vehicle inspected by your Toyota dealer.

C Blue and red: Good condition

▶ Type B

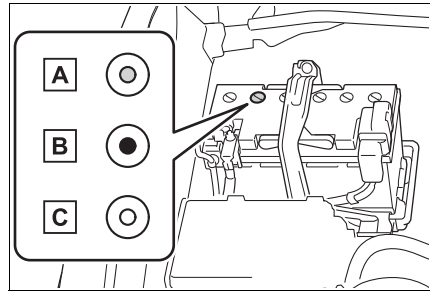

A Blue: Good condition

B Red: Charging is necessary.

Have the vehicle inspected by your Toyota dealer.

C Clear: Replacement is necessary.

Have the battery checked by your Toyota dealer.

▶ Type C

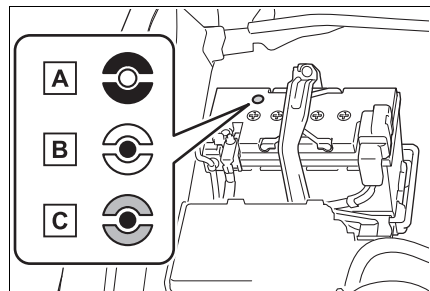

A Red and white: Replacement is necessary.

Have the battery checked by your Toyota dealer.

B White and red: Charging is necessary.

Have the vehicle inspected by your Toyota dealer.

C Blue and red: Good condition

■ Before recharging

When recharging, the battery produces hydrogen gas which is flammable and explosive. Therefore, observe the following precautions before recharging:

- If recharging with the battery installed on the vehicle, be sure to disconnect the ground cable.
- Make sure the power switch on the charger is off when connecting and disconnecting the charger cables to the battery.

■ After recharging/reconnecting the battery

The engine may not start. Follow the procedure below to initialize the system.

- 1 Shift the shift lever to P.
 - 2 Open and close any of the doors.
 - 3 Restart the engine.
- Unlocking the doors using the smart key system may not be possible immediately after reconnecting the battery. If this happens, use the wireless remote control or the mechanical key to lock/unlock the doors.
 - Start the engine with the engine switch in ACC*. The engine may not start with the engine switch turned off. However, the engine will operate normally from the second attempt.
 - The engine switch mode is recorded by the vehicle. If the battery is disconnected and reconnected, the vehicle will return the engine switch mode to the status it was in before the battery was disconnected. Make sure to turn off the engine switch before disconnecting the battery. Take extra care when connecting the battery if the engine switch mode prior to the battery being disconnected is unknown.

If the engine will not start even after

multiple attempts, contact your Toyota dealer.

*: ACC mode can be enabled/disabled on the customize menu. (→P.638)

⚠ WARNING**■ Chemicals in the battery**

A battery contains poisonous and corrosive sulfuric acid and may produce hydrogen gas which is flammable and explosive. To reduce the risk of death or serious injury, take the following precautions while working on or near the battery:

- Do not cause sparks by touching the battery terminals with tools.
- Do not smoke or light a match near the battery.
- Avoid contact with eyes, skin and clothes.
- Never inhale or swallow electrolyte.
- Wear protective safety glasses when working near the battery.
- Keep children away from the battery.

■ Where to safely charge the battery

Always charge the battery in an open area. Do not charge the battery in a garage or closed room where there is not sufficient ventilation.

**WARNING****■ Emergency measures regarding electrolyte**

- If electrolyte gets in your eyes
Flush your eyes with clean water for at least 15 minutes and get immediate medical attention. If possible, continue to apply water with a sponge or cloth while traveling to the nearest medical facility.
- If electrolyte gets on your skin
Wash the affected area thoroughly. If you feel pain or burning, get medical attention immediately.
- If electrolyte gets on your clothes
It can soak through clothing on to your skin. Immediately take off the clothing and follow the procedure above if necessary.
- If you accidentally swallow electrolyte
Drink a large quantity of water or milk. Get emergency medical attention immediately.

■ When disconnecting the battery

Do not disconnect the negative (-) terminal on the body side. The disconnected negative (-) terminal may touch the positive (+) terminal, which may cause a short and result in death or serious injury.

**NOTICE****■ When recharging the battery**

Never recharge the battery while the engine is running. Also, be sure all accessories are turned off.

Adding the washer fluid

If any washer does not work, the washer tank may be empty. Add washer fluid.

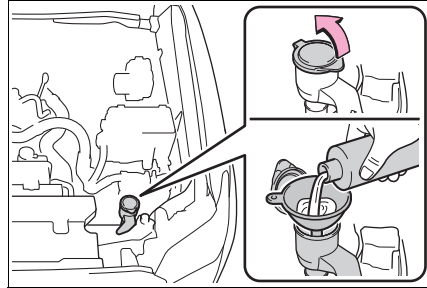
**WARNING****■ When adding washer fluid**

Do not add washer fluid when the engine is hot or operating as washer fluid contains alcohol and may catch fire if spilled on the engine, etc.

**NOTICE****■ Do not use any fluid other than washer fluid**

Do not use soapy water or anti-freeze instead of washer fluid. Doing so may cause streaking on the vehicle's painted surfaces, as well as damaging the pump leading to problems of the washer fluid not spraying.

■ Diluting washer fluid

Dilute washer fluid with water as necessary. Refer to the freezing temperatures listed on the label of the washer fluid bottle.

Tires

Replace or rotate tires in accordance with maintenance schedules and treadwear.

Checking tires

Check if the treadwear indicators are showing on the tires. Also check the tires for uneven wear, such as excessive wear on one side of the tread.

Check the spare tire condition and pressure if not rotated.

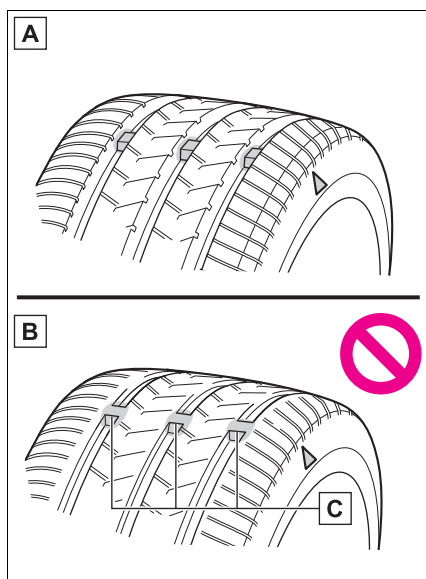

A New tread

B Worn tread

C Treadwear indicator

The location of treadwear indicators

is shown by a “TWI” or “ \triangle ” mark, etc., molded into the sidewall of each tire.

Replace the tires if the treadwear indicators are showing on a tire.

■ When to replace your vehicle's tires

Tires should be replaced if:

- The treadwear indicators are showing on a tire.
- You have tire damage such as cuts, splits, cracks deep enough to expose the fabric, and bulges indicating internal damage
- A tire goes flat repeatedly or cannot be properly repaired due to the size or location of a cut or other damage

If you are not sure, consult with your Toyota dealer.

■ Tire life

Any tire over 6 years old must be checked by a qualified technician even if it has seldom or never been used, or damage is not obvious.

■ Maximum load of tire

Check that the number given by dividing the maximum load by 1.10 of the replacement tire is greater than 1/2 of the Gross Axle Weight Ratings (GAWR) of either the front axle or the rear axle, whichever is greater.

For the GAWR, see the Certification Label.

For the maximum load of the tire, see the load limit at maximum cold tire inflation pressure mentioned on the sidewall of the tire. (→P.626)

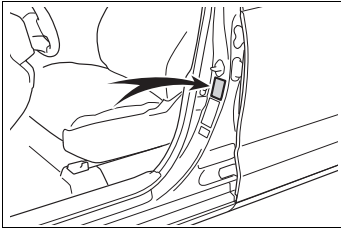

■ Tire types

● Summer tires

Summer tires are high-speed performance tires best suited to highway driving under dry conditions. Since summer tires do not have the same traction performance as snow tires, summer tires are inadequate for driving on snow-covered or icy roads. For driving on snow-covered roads or icy roads, the use of snow tires is recommended. When installing snow tires, be sure to replace all four tires.

● All season tires

All season tires are designed to provide better traction in snow and to be adequate for driving in most winter conditions as well as for use year-round. All season tires, however, do not have adequate traction performance compared with snow tires in heavy or loose snow. Also, all season tires fall short in acceleration and handling performance compared with summer tires in highway driving.

● Snow tires

For driving on snow-covered roads or icy roads, we recommend using snow tires. If you need snow tires, select tires of the same size, construction and load capacity as the originally installed tires. Since your vehicle has radial tires as original equipment, make sure your snow

tires also have radial construction. Do not install studded tires without first checking local regulations for possible restrictions. Snow tires should be installed on all wheels. (→P.448)

■ If the tread on snow tires wears down below 0.16 in. (4 mm)

The effectiveness of the tires as snow tires is lost.

⚠ WARNING

■ When inspecting or replacing tires

Observe the following precautions to prevent accidents.

Failure to do so may cause damage to parts of the drive train as well as dangerous handling characteristics, which may lead to an accident resulting in death or serious injury.

- Do not mix tires of different makes, models or tread patterns. Also, do not mix tires of remarkably different treadwear.
- Do not use tire sizes other than those recommended by Toyota.
- Do not mix differently constructed tires (radial, bias-belted or bias-ply tires).
- Do not mix summer, all season and snow tires.
- Do not use tires that have been used on another vehicle. Do not use tires if you do not know how they were used previously.
- Do not use tires with different load rating and/ or speed symbol than what is specified on tire pressure label or in owner's manual.

 **NOTICE**

■ Driving on rough roads

Take particular care when driving on roads with loose surfaces or potholes. These conditions may cause losses in tire inflation pressure, reducing the cushioning ability of the tires. In addition, driving on rough roads may cause damage to the tires themselves, as well as the vehicle's wheels and body.

Tire rotation

Rotate the tires in the order shown.

To equalize tire wear and extend tire life, Toyota recommends that tire rotation is carried out at the same interval as tire inspection.

Do not fail to initialize the tire pressure warning system after tire rotation.

- ▶ Vehicles with a spare tire of a different wheel type from the installed tires

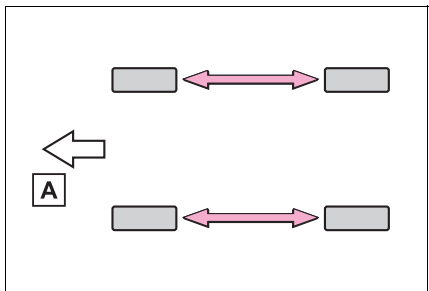

A Front

- ▶ Vehicles with a spare tire of the same wheel type as the installed tires

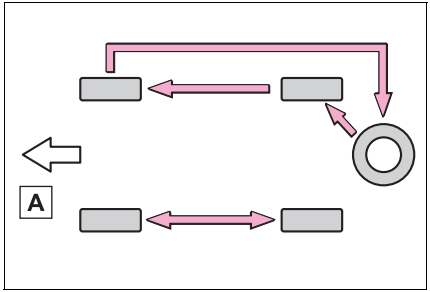

A Front

Tire pressure warning system

Your vehicle is equipped with a tire pressure warning system that uses tire pressure warning valves and transmitters to detect low tire inflation pressure before serious problems arise.

The tire pressure warning system of this vehicle adopts a 2-type warning system

- When “Adjust Pressure” is displayed (Normal Warning)

A warning with the tire pressure warning light and warning buzzer when there is an unknown level of low tire pressure with the appearance of the tire due to natural air leakage as well as the pressure lowering due to changes in the pressure according to the outside temperature.

- When “Immediately Check Tire when Safe” is displayed (Emergency Warning)

A warning with the tire pressure warning light and warning buzzer when there is a known level of low tire pressure with the appearance of the tire due to pressure suddenly lowering.

However, the system may not be able to detect sudden tire ruptures (bursting, etc.).

- The tire pressure detected by the tire pressure warning system can be displayed on the multi-information display.

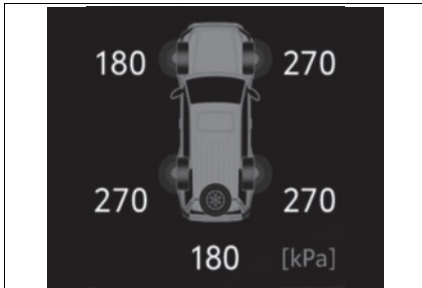

■ How to change the unit (with 7-inch display)

- 1 Park the vehicle in a safe place and turn the engine switch off.

Changing the unit cannot be performed while the vehicle is moving.

- 2 Turn the engine switch to ON.
- 3 Press \wedge / \vee of the meter control switch to select .
- 4 Press \langle / \rangle to select "Vehicle Settings" and then press and hold OK.

- 5 Press \wedge / \vee to select "TPWS" and then press OK.

- 6 Press \wedge / \vee to select "Pressure unit setting" and then press OK.

- 7 Press \wedge / \vee to select the desired unit and then press OK.

■ How to change the unit (with 12.3-inch display)

- 1 Park the vehicle in a safe place and turn the engine switch off.

Changing the unit cannot be performed while the vehicle is moving.

- 2 Turn the engine switch to ON
- 3 Press and hold OK to display the cursor on the content display area (center) of the multi-information display.
- 4 Press \wedge / \vee of the meter control switches to select  "Settings" and then press OK.
- 5 Press \wedge / \vee of the meter control switches, select "Vehicle Settings" and then press and hold OK.
- 6 Press \wedge / \vee of the meter control switches, select

“TPWS setting” and then press OK .

- 7 Press \wedge / \vee of the meter control switches, select the “Pressure unit setting”. Then press and hold OK .

■ Routine tire inflation pressure checks

The tire pressure warning system does not replace routine tire inflation pressure checks. Make sure to check tire inflation pressure as part of your routine of daily vehicle checks.

■ Tire inflation pressure

- It may take a few minutes to display the tire inflation pressure after the engine switch is turned to ON. It may also take a few minutes to display the tire inflation pressure after inflation pressure has been adjusted.
- Tire inflation pressure changes with temperature. The displayed values may also be different from the values measured using a tire pressure gauge.

■ Situations in which the tire pressure warning system may not operate properly

- In the following cases, the tire pressure warning system may not operate properly.
 - If non-genuine Toyota wheels are used.
 - A tire has been replaced with a tire that is not an OE (Original Equipment) tire.
 - A tire has been replaced with a tire that is not of the specified size.
 - Tire chains, etc., are equipped.
 - An auxiliary-supported run-flat tire is equipped.
 - If a window tint that affects the radio wave signals is installed.

- If there is a lot of snow or ice on the vehicle, particularly around the wheels or wheel housings.
- If the tire inflation pressure is extremely higher than the specified level.
- If wheels without tire pressure warning valves and transmitters are used.
- If the ID code on the tire pressure warning valves and transmitters is not registered in the tire pressure warning computer.

- Performance may be affected in the following situations.
 - Near a TV tower, electric power plant, gas station, radio station, large display, airport or other facility that generates strong radio waves or electrical noise
 - When carrying a portable radio, cellular phone, cordless phone or other wireless communication device

If tire position information is not correctly displayed due to the radio wave conditions, the display may be corrected by driving and changing the radio wave conditions may change.

- When the vehicle is parked, the time taken for the warning to start or go off could be extended.
- When tire inflation pressure declines rapidly for example when a tire has burst, the warning may not function.

■ Warning performance of the tire pressure warning system

The warning of the tire pressure warning system will change in accordance with the conditions under which it was initialized. For this reason, the system may give a warning even if the tire pressure does not reach a low enough level, or if the pressure is higher than the pressure that was adjusted to when the system was initialized.

■ Certification

→P.704

Installing tire pressure warning valves and transmitters

When replacing tires or wheels, tire pressure warning valves and transmitters must also be installed.

When new tire pressure warning valves and transmitters are installed, new ID codes must be registered in the tire pressure warning computer and the tire pressure warning system must be initialized. (→P.549)

■ When replacing the tires and wheels

If the ID code of the tire pressure warning valve and transmitter is not registered, the tire pressure warning system will not work properly. After driving for about 20 minutes, the tire pressure warning light blinks for 1 minute and stays on to indicate a system malfunction.



NOTICE

■ Repairing or replacing tires, wheels, tire pressure warning valves, transmitters and tire valve caps

- When removing or fitting the wheels, tires or the tire pressure warning valves and transmitters, contact your Toyota dealer as the tire pressure warning valves and transmitters may be damaged if not handled correctly.

- Make sure to install the tire valve caps. If the tire valve caps are not installed, water could enter the tire pressure warning valves, corrode the valves and the tire pressure warning valves could be bound.
- When replacing tire valve caps, do not use tire valve caps other than those specified. The cap may become stuck.

Registration of the position of each wheel after performing a tire rotation

■ When rotating the tires

It is necessary to register the position of each wheel after performing a tire rotation.

Wheel position registration can be performed by oneself. Wheel position registration is performed by driving forward with moderate left and right turns. However, depending on the driving conditions and driving environment, registration may take some time to complete.

■ Registration of the tire position

- 1 Park the vehicle in a safe place and stop the engine for 15 minutes or more.
- 2 Turn the engine switch to ON.

Registration cannot be performed while the vehicle is moving.

3 12.3-inch display only: Press and hold to OK display the cursor on the content display area (center) of the multi-information display.

4 Press \wedge or \vee of the meter control switches and select .

5 Press \langle / \rangle (7-inch display) or \wedge / \vee (12.3-inch display) of the meter control switches and select "Vehicle Settings", then press and hold the "OK".

6 Press \wedge or \vee of the meter control switches, select "TPWS Setting", and then press "OK".

7 Press \wedge or \vee of the meter control switches, select "Tire Rotation", and then press "OK".

8 Press \wedge or \vee of the meter control switches, select "OK", and then press "OK".

A message is displayed on the multi-information display. Also, "--" is displayed for inflation pressure of each tire on the multi-information display while the tire pressure warning system determines the

position.

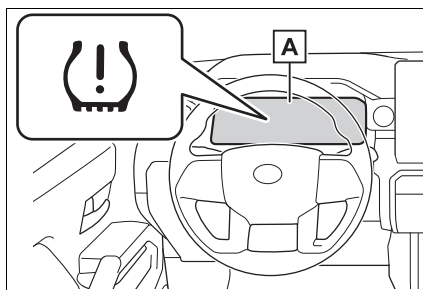

A "Setting Pressure Wait a Moment"

9 Drive at approximately 25 mph (40 km/h) or more for approximately 10 to 30 minutes.

When wheel position registration is complete, the inflation pressure of each tire will be displayed on the multi-information display.

Even if the vehicle is not driven at approximately 25 mph (40 km/h) or more, registration can be completed by driving for a long time. However, if initialization does not complete after driving for 1 hour or more, park the vehicle in a safe place for approximately 15 minutes and then drive the vehicle again.

■ When performing wheel position registration

- Normally, wheel position registration can be completed within approximately 30 minutes.
- Wheel position registration is performed while driving at a vehicle speed of approximately 25 mph (40 km/h) or more.

■ The initialization operation

- If the engine switch is turned off while registering the wheel position, the next time the engine switch is turned to ON, the wheel position registration will resume

and it will not be necessary to restart the procedure.

- While the position of each tire is being determined and the inflation pressures are not being displayed on the multi-information display, if the inflation pressure of a tire drops, the tire pressure warning light will come on.

■ If the tire pressure warning system is not registered properly

- In the following situations, wheel position registration may take longer than usual to be completed or may not be possible.
 - Vehicle is not driven at approximately 25 mph (40 km/h) or more
 - Vehicle is driven on unpaved roads

If initialization does not complete after driving for 1 hour or more, park the vehicle in a safe place for approximately 15 minutes and then drive the vehicle again.

- If the vehicle is reversed during wheel position registration, all data collected until then will be cleared. Perform driving again.

Setting the tire pressure

■ When you need to setting the tire pressure

In the following situations, it will be necessary to perform the tire inflation pressure setting procedure of the tire pressure warning system.

- When the specified tire inflation pressure has changed, such as due to carried load, etc.
- When the tire inflation pressure is changed such as

when the tire size is changed.





If the tire inflation pressure has been adjusted to the specified level, perform the tire inflation setting procedure by selecting specified inflation pressure on the multi-information display.

When the tire inflation pressure is to be other than specified, such as when tires other than the specified size are used, etc., set the tire inflation pressure using the current pressure. Make sure to adjust the tire inflation pressure of each tire to the appropriate level before performing tire pressure setting. The tire pressure warning system operates based on this tire inflation pressure.

■ Setting by selecting a specified tire inflation pressure

- 1 Turn the engine switch to ON.

The tire inflation pressure cannot be set while the vehicle is moving.

- 2 12.3-inch display only: Press and hold to  display the cursor on the content display area (center) of the multi-information display.
- 3 Press  or  of the meter control switches and select .

4 Press \leftarrow / \rightarrow (7-inch display) or \wedge / \vee (12.3-inch display) of the meter control switches and select “Vehicle Settings”, then press and hold the “OK”.

5 Press \wedge or \vee of the meter control switches, select “TPWS Setting”, and then press “OK”.

6 Press \wedge or \vee of the meter control switches, select “Tire Pressure Setting”, and then press “OK”.

7 Press \wedge or \vee of the meter control switches, select “Setting by Specified Pressure”, and then press “OK”.

Select the desired front and rear tire pressures.

8 Press \wedge or \vee of the meter control switches, select “OK”, and then press “OK”.

The tire pressure warning light will slowly blink 3 times and a message indicating that tire inflation pressure is being set will be displayed on the multi-information display.

After setting the tire inflation pressure, a message indicating that setting has been completed will be displayed on the multi-information

display.

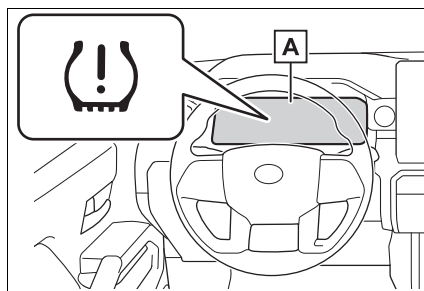

A “Setting Pressure Wait a Moment”

■ Setting using the current tire inflation pressure

1 Adjust the tire inflation pressure to the specified cold tire inflation pressure level.

Make sure to adjust the tire pressure to the specified cold tire inflation pressure level. The tire pressure warning system will operate based on this pressure level.

2 Start the engine (→P.218)

The tire inflation pressure cannot be set while the vehicle is moving.

3 12.3-inch display only: Press and hold to OK display the cursor on the content display area (center) of the multi-information display.

4 Press \wedge or \vee of the meter control switches and select .

5 Press \leftarrow / \rightarrow (7-inch display) or \wedge / \vee (12.3-inch display) of the meter control

switches and select “Vehicle Settings”, then press and hold the “OK”.

- 6 Press \wedge or \vee of the meter control switches, select “TPWS Setting”, and then press “OK”.
- 7 Press \wedge or \vee of the meter control switches, select “Tire Pressure Setting”, and then press “OK”.
- 8 Press \wedge or \vee of the meter control switches, select “Setting by Current Pressure” and then press “OK”.
- 9 Press \wedge or \vee of the meter control switches, select “OK”, and then press “OK”.

The tire pressure warning light will slowly blink 3 times and a message indicating that tire inflation pressure is being set will be displayed on the multi-information display.

After setting the tire inflation pressure, a message indicating that setting has been completed will be displayed on the multi-information display.

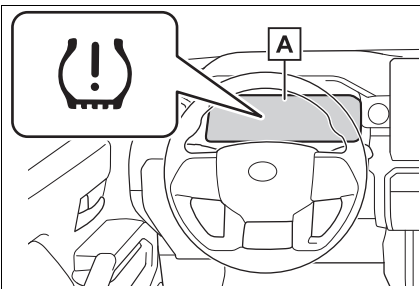

A “Setting Pressure Wait a Moment”

■ Warning performance of the tire pressure warning system (Setting using the current tire inflation pressure)

- When performing the tire pressure setting using the current tire inflation pressure, the warning timing of the tire pressure warning system will vary according to the conditions under which tire pressure setting was performed. Therefore, a warning may be output even if the tire inflation pressure drops slightly or if the tire inflation pressure increases above that when the tire inflation pressure was set.
- Make sure to perform the tire pressure setting procedure after adjusting the tire inflation pressure. Also, make sure the tires are cold before performing the tire pressure setting procedure or adjusting the tire inflation pressure.

■ Tire inflation pressure setting procedure (Setting using the current tire inflation pressure)

- If the engine switch is turned off while setting the tire inflation pressure, the next time the engine switch is turned to ON, the setting procedure will resume and it will not be necessary to restart the procedure.
- If the tire inflation pressure setting procedure is started unnecessarily, adjust the tire inflation pressure to the specified level with the tires cold and then perform setting by selecting a specified tire inflation pressure, or perform the tire inflation pressure setting procedure with the current tire inflation pressure.

■ If the tire inflation pressure cannot be set properly

- Normally, the tire inflation pressure setting procedure can be completed in 2 or 3 minutes.
- If the tire pressure warning light does not blink 3 times when starting the tire inflation pressure setting procedure, the procedure may not have started. Perform the procedure again from the beginning.
- If tire inflation pressure setting procedure cannot be completed after performing the above procedure, contact your Toyota dealer.



WARNING

■ When setting using the current tire inflation pressure

Make sure to adjust the tire inflation pressure of each tire to the appropriate level before performing tire pressure setting. Otherwise, the tire pressure warning light may not illuminate even if the tire inflation pressure drops or may illuminate even though the tire inflation pressure is normal.

Registering ID codes

■ When registering ID codes

The tire pressure warning valve and transmitter is equipped with a unique ID code.

When new tire pressure warning valves and transmitters are installed, new ID codes must be registered in the tire pressure warning computer.

■ How to register ID code

- 1 Park the vehicle in a safe place, wait for approximately 15 minutes.
- 2 Turn the engine switch to ON.

The ID code registration procedure cannot be performed while the vehicle is moving.

- 3 12.3-inch display only: Press and hold to **OK** display the cursor on the content display area (center) of the multi-information display.

- 4 Press **▲** or **▼** of the meter control switches and select .

- 5 Press **< / >** (7-inch display) or **▲ / ▼** (12.3-inch display) of the meter control switches and select “Vehicle Settings”, then press and hold the “OK”.

- 6 Press **▲** or **▼** of the meter control switches, select “TPWS Setting”, and then press “OK”.

- 7 Press **▲** or **▼** of the meter control switches, select “Tire Set Switching”, and then press “OK”.

- 8 Press \wedge or \vee of the meter control switches, select “Register New Valve/ID” and then press “OK”.
- 9 Check if the desired wheel set (“Tire Set 1” or “Tire Set 2”) is displayed.

ID codes will be registered to the displayed wheel set.

To change the wheel set to be registered, press \wedge or \vee of the meter control switches, and then select the wheel set you wish to register.

If ID codes have already been registered for that wheel set, the tire pressure warning light will slowly blink 3 times, and a message indicating that change is occurring will be displayed on the multi-information display.

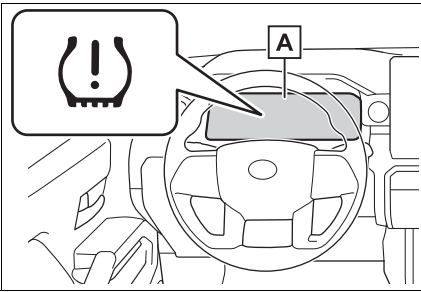

A “Setting Pressure Wait a Moment”

- 10 Press \wedge or \vee of the meter control switches, select “OK” and then press “OK”.

The tire pressure warning light will slowly blink 3 times and a message indicating that ID code registration is being performed will be displayed on the multi-information display. Wheel set changing will be can-

celed and registration will begin.

When registration is being performed, the tire pressure warning light will blink for approximately 1 minute then illuminate and “--” will be displayed for the inflation pressure of each tire on the multi-information display.

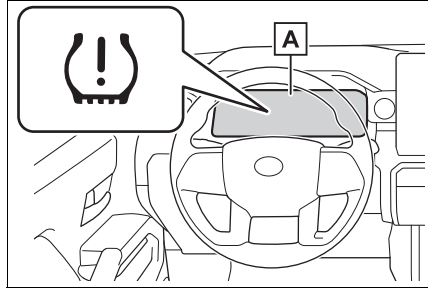

A “Setting Pressure Wait a Moment”

- 11 Drive straight (with occasional left and right turns) at approximately 25 mph (40 km/h) or more for approximately 10 to 30 minutes.

When registration is complete, the tire pressure warning light will turn off and a message indicating that registration has been completed will be displayed on the multi-information display.

Registration may take longer than normal to complete if the vehicle speed cannot be maintained at approximately 25 mph (40 km/h) or more. If registration cannot be completed after driving for 1 hour or more, perform the registration procedure again from the beginning.

■ When registering ID codes

- Normally, wheel position registration can be completed within approximately 30 minutes.
- ID code registration is performed while driving at a vehicle speed of

approximately 25 mph (40 km/h) or more.

- ID codes can be registered by yourself, but depending on the driving conditions and driving environment, registration may take some time to complete.
- When using a wheel set which all of the ID codes have already been registered, the wheel set can be changed in a short amount of time.

■ If ID codes are not registered properly

- In the following situations, ID code registration may take longer than usual to be completed or may not be possible.
 - When the vehicle has not been parked for approximately 15 minutes or more before being driven
 - Vehicle is not driven at approximately 25 mph (40 km/h) or more
 - Vehicle is driven on unpaved roads
 - Vehicle is driven near other vehicles and system cannot recognize tire pressure warning valves and transmitters of your vehicle over those of other vehicles
 - Wheel with tire pressure warning valve and transmitter installed is inside or near the vehicle
- If the vehicle is reversed during registration, all data collected until then will be cleared. Perform driving again.
- If registration does not complete after driving for 1 hour or more, perform the ID code registration procedure again from the beginning.
- If the tire pressure warning light does not blink 3 times when starting ID code registration procedure, the procedure may not have started. Perform the procedure again from the beginning.
- If ID codes cannot be registered even when performing the above procedure, contact your Toyota

dealer.

Canceling ID code registration

To cancel ID code registration after it has been started, select “Register New Valve / ID” again on the multi-information display.

If ID code registration has been canceled, the tire pressure warning light will turn off.

If the warning light does not turn off, ID code registration may not have been canceled correctly.

To cancel registration, select “Register New Valve / ID” again on the multi-information display.

Selecting wheel set

Your vehicle is equipped with a tire pressure warning system with a function to register two sets of ID codes. This allows for registration of a second wheel set, for example a winter set.

- The wheel set can be changed only if a second wheel set has been registered to the system. If a second wheel set has not been registered, message will be displayed and it will not be possible to change to the selected wheel set. ID codes can be registered by yourself.

- Only a change between both registered wheel set is possible, mixing between these wheel sets is not supported.
- While registering ID codes, it may not be possible to change between wheel sets normally. Cancel registration before changing between wheel sets.

■ How to change between wheel sets

- 1 Install the desired wheel set.
- 2 Turn the engine switch to ON.

The ID code selecting procedure cannot be performed while the vehicle is moving.

- 3 12.3-inch display only: Press and hold to OK display the cursor on the content display area (center) of the multi-information display.
- 4 Press \wedge or \vee of the meter control switches and select .
- 5 Press \lt / \gt (7-inch display) or \wedge / \vee (12.3-inch display) of the meter control switches and select "Vehicle Settings", then press and hold the "OK".
- 6 Press \wedge or \vee of the meter control switches, select

"TPWS Setting", and then press "OK".

- 7 Press \wedge or \vee of the meter control switches, select "Tire Set Switching", and then press "OK".
- 8 Press \wedge or \vee of the meter control switches, select "Register Valve/ID" and then press "OK".
- 9 Press \wedge or \vee of the meter control switches and wheel set ("Tire Set 1" or "Tire Set 2") is selected.
- 10 Press \wedge or \vee of the meter control switches, select "OK" and then press "OK". The tire pressure warning light will slowly blink 3 times, a message indicating that change is occurring will be displayed, and the wheel set change will begin.

Wheel set change will begin and the tire pressure warning light will blink for 1 minute and then illuminate. Also, while the change is being performed, "--" will be displayed for the tire inflation pressure of each tire on the multi-information display.

After approximately 2 minutes, the wheel set change will complete, the tire pressure warning light will turn off, and a completion message will be displayed on the multi-information display.

If changing does not complete after

approximately 4 minutes, a message indicating that the change could not be completed will be displayed.

Check which wheel set is installed and perform the change procedure again from the beginning.

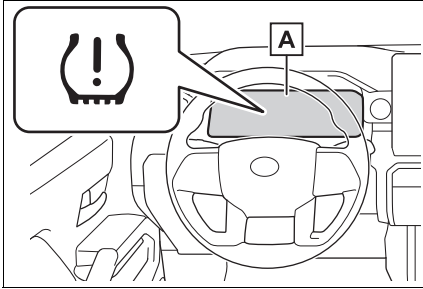

A “Setting Pressure Wait a Moment”

11 If the specified tire inflation pressure of the wheel set installed differs from that of the previous set, it will be necessary to perform the tire inflation pressure setting procedure of the tire pressure warning system.

If the specified tire inflation pressure is the same, it will not be necessary to perform the tire inflation pressure setting procedure.

12 Register the position of each wheel.

Tire inflation pressure

Checking the specified tire inflation pressure

The recommended cold tire inflation pressure and tire size are displayed on the tire and loading information label.

(→P.622)

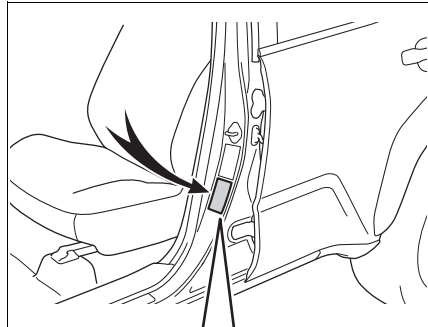

TIRE AND LOADING INFORMATION			RENSEIGNEMENTS SUR LES PNEUS ET LE CHARGEMENT		
SEATING CAPACITY: TOTAL X FROM X, REAR X The combined weight of occupants and cargo should never exceed XXX kg or XXX lbs.			NOMBRE DE PLACES : TOTAL X AVANT X, ARRIERE X Le poids total des occupants et du chargement ne doit jamais dépasser XXX kg ou XXX lb.		
TIRE	SIZE	COLD TIRE PRESSURE	PNEU	DIMENSIONS	PRESION DES PNEUS A FROID
FRONT	XXXXXXX	XXXkPa, XXPSI	AVANT	XXXXXXX	XXXkPa, XXPSI
REAR	XXXXXXX	XXXkPa, XXPSI	ARRIERE	XXXXXXX	XXXkPa, XXPSI
SPARE	XXXXXXX	XXXkPa, XXPSI	DE SECOURS	XXXXXXX	XXXkPa, XXPSI
SEE OWNERS MANUAL FOR ADDITIONAL INFORMATION			VOIR LE MANUEL DE L'USAGER POUR PLUS DE RENSEIGNEMENTS		

Inspection and adjustment procedure

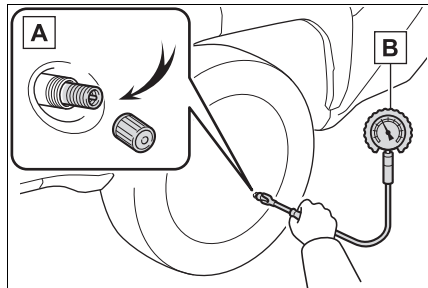

A Tire valve

B Tire pressure gauge

- 1 Remove the tire valve cap.
- 2 Press the tip of the tire pressure gauge onto the tire valve.
- 3 Read the pressure using the gauge gradations.
- 4 If the tire inflation pressure is not at the recommended level, adjust the pressure. If you add too much air, press the center of the valve to deflate.
- 5 After completing the tire inflation pressure measurement and adjustment, apply soapy water to the valve and check for leakage.
- 6 Put the tire valve cap back on.

■ Tire inflation pressure check interval

You should check tire inflation pressure every two weeks, or at least once a month. Do not forget to check the spare.

■ Effects of incorrect tire inflation pressure

Driving with incorrect tire inflation pressure may result in the following:

- Reduced fuel economy
- Reduced driving comfort and poor handling
- Reduced tire life due to wear
- Reduced safety
- Damage to the drive train

If a tire needs frequent inflating, have it checked by your Toyota dealer.

■ Instructions for checking tire inflation pressure

When checking tire inflation pressure, observe the following:

- Check only when the tires are cold.
If your vehicle has been parked for at least 3 hours or has not been driven for more than 1 mile or 1.5 km, you will get an accurate cold tire inflation pressure reading.
- Always use a tire pressure gauge. It is difficult to judge if a tire is properly inflated based only on its appearance.
- It is normal for the tire inflation pressure to be higher after driving as heat is generated in the tire. Do not reduce tire inflation pressure after driving.
- Never exceed the vehicle capacity weight.
Passengers and luggage weight should be placed so that the vehicle is balanced.

⚠ WARNING

■ Proper inflation is critical to save tire performance

Keep your tires properly inflated. If the tires are not properly inflated, the following conditions may occur which could lead to an accident resulting in death or serious injury:

- Excessive wear
- Uneven wear
- Poor handling
- Possibility of blowouts resulting from overheated tires
- Air leaking from between tire and wheel
- Wheel deformation and/or tire damage

⚠ WARNING

- Greater possibility of tire damage while driving (due to road hazards, expansion joints, sharp edges in the road, etc.)

⚠ NOTICE**■ When inspecting and adjusting tire inflation pressure**

Be sure to put the tire valve caps back on.

If a valve cap is not installed, dirt or moisture may get into the valve and cause an air leak, resulting in decreased tire inflation pressure.

Wheels

If a wheel is bent, cracked or heavily corroded, it should be replaced. Otherwise, the tire may separate from the wheel or cause a loss of handling control.

Wheel selection

When replacing wheels, care should be taken to ensure that they are equivalent to those removed in load capacity, diameter, rim width and inset*.

Replacement wheels are available at your Toyota dealer.

*: Conventionally referred to as offset.

Toyota does not recommend using the following:

- Wheels of different sizes or types
- Used wheels
- Bent wheels that have been straightened

■ When replacing wheels

The wheels of your vehicle are equipped with tire pressure warning valves and transmitters that allow the tire pressure warning system to provide advance warning in the event of a loss in tire inflation pressure. Whenever wheels are replaced, the tire pressure warning valves and transmitters must be installed. (→P.544)

**WARNING****■ When replacing wheels**

- Do not use wheels that are a different size from those recommended in the Owner's Manual or certification label, as this may result in a loss of handling control.
- Never use an inner tube in a leaking wheel which is designed for a tubeless tire. Doing so may result in an accident, causing death or serious injury.

■ When installing the wheel nuts

Never use oil or grease on the wheel bolts or wheel nuts. Oil and grease may cause the wheel nuts to be excessively tightened, leading to bolt or disc wheel damage. In addition, the oil or grease can cause the wheel nuts to loosen and the wheel may fall off, causing an accident and resulting in death or serious injury. Remove any oil or grease from the wheel bolts or wheel nuts.

■ Use of defective wheels prohibited

Do not use cracked or deformed wheels. Doing so could cause the tire to leak air during driving, possibly causing an accident.

**NOTICE****■ Replacing tire pressure warning valves and transmitters**

- Because tire repair or replacement may affect the tire pressure warning valves and transmitters, make sure to have tires serviced by your Toyota dealer or other qualified service shop. In addition, make sure to purchase your tire pressure warning valves and transmitters at your Toyota dealer.
- Ensure that only genuine Toyota wheels are used on your vehicle. Tire pressure warning valves and transmitters may not work properly with non-genuine wheels.

Aluminum wheel precautions

- Use only Toyota wheel nuts and wheel nut wrenches designed for use with your aluminum wheels.
- When rotating, repairing or changing your tires, check that the wheel nuts are still tight after driving 1000 miles (1600 km).
- Be careful not to damage the aluminum wheels when using tire chains.
- Use only Toyota genuine balance weights or equivalent and a plastic or rubber hammer when balancing your wheels.

Air conditioning filter

The air conditioning filter must be changed regularly to maintain air conditioning efficiency.

Removing the air conditioning filter

- 1 Turn the engine switch off.
- 2 Open the glove box.

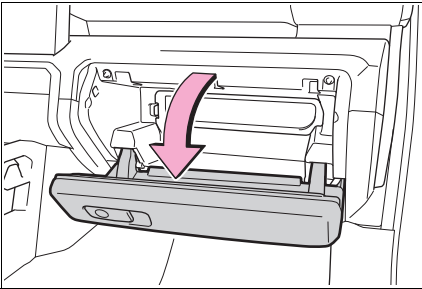

- 3 Remove the panel.

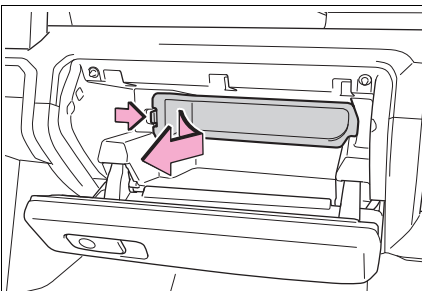

- 4 Unlock the filter cover (A), pull the filter cover out of the

claws (B), and remove the filter cover.

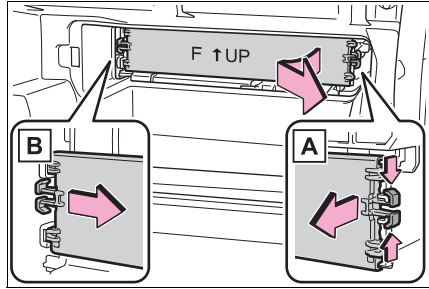

- 5 Remove the filter case.

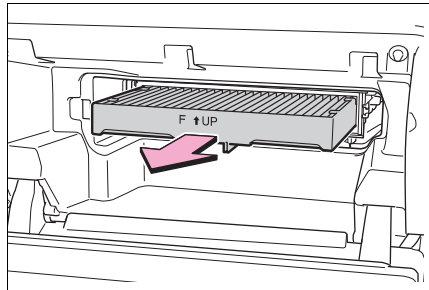

- 6 Remove the air conditioning filter from the filter case and replace it with a new one.

The “↑ UP” marks shown on the filter and the filter case should be pointing up.

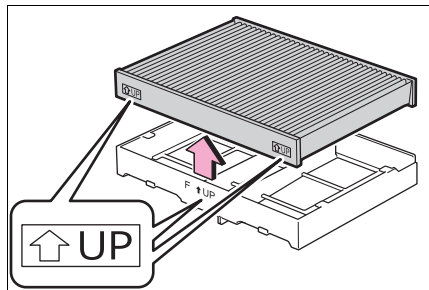

■ Checking interval

Inspect and replace the air conditioning filter according to the maintenance schedule. In dusty areas or

areas with heavy traffic flow, early replacement may be required. (For scheduled maintenance information, please refer to the “Owner’s Manual Supplement” or “Scheduled Maintenance”.)

■ **If air flow from the vents decreases dramatically**

The filter may be clogged. Check the filter and replace if necessary.



NOTICE

■ **When using the air conditioning system**

Make sure that a filter is always installed.

Using the air conditioning system without a filter may cause damage to the system.

■ **To prevent damage to the filter cover**

When moving the filter cover in the direction of arrow to release the fitting, pay attention not to apply excessive force to the claws. Otherwise, the claws may be damaged.

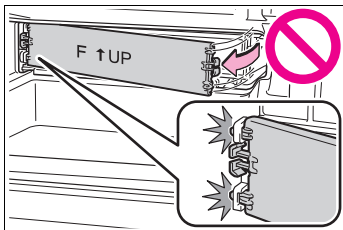

Electronic key battery

Replace the battery with a new one if it is depleted. As the key may be damaged if the following procedure is not performed properly, it is recommended that key battery replacement be performed by your Toyota dealer.

■ **If the electronic key battery is depleted**

The following symptoms may occur:

- The smart key system and wireless remote control will not function properly.
- The operational range will be reduced.

Items to prepare

- Flathead screwdriver
 - Small flathead screwdriver
 - Lithium battery CR2450
- **Use a CR2450 lithium battery**
- Batteries can be purchased at your Toyota dealer, local electrical appliance shops or camera stores.
 - Replace only with the same or equivalent type recommended by the manufacturer.
 - Dispose of used batteries according to local laws.

Replacing the battery

- 1** Take out the mechanical key.

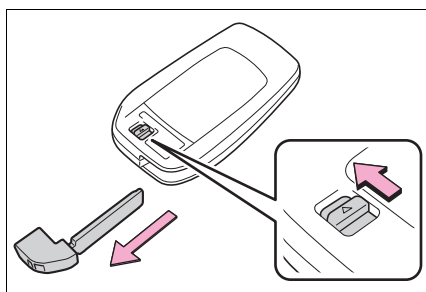

- 2** Remove the cover.

To prevent damage to the key, cover the tip of the flathead screwdriver with a tape.

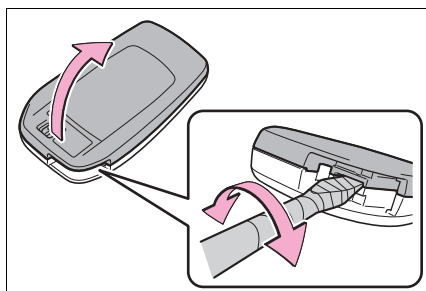

- 3** Remove the depleted battery.

Insert a new battery with the “+” terminal facing up.

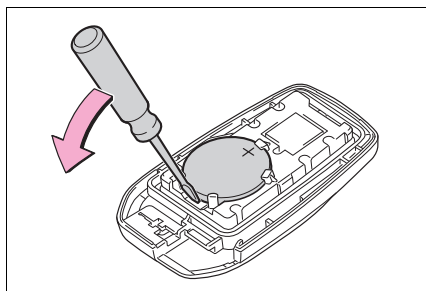
**! WARNING****Removed battery and other parts**

These parts are small and if swallowed by a child, they can cause choking. Keep away from children. Failure to do so could result in death or serious injury.

Battery precautions

Observe the following precautions.

Failure to do so may result in death or serious injury.

- Do not swallow the battery. Doing so may cause chemical burns.
- A coin battery or button battery is used in the electronic key. If a battery is swallowed, it may cause severe chemical burns in as little as 2 hours and may result in death or serious injury.
- Keep away new and removed batteries from children.
- If the cover cannot be firmly closed, stop using the electronic key and stow the key in the place where children cannot reach, and then contact your Toyota dealer.
- If you accidentally swallow a battery or put a battery into a part of your body, get emergency medical attention immediately.
- **To prevent battery explosion or leakage of flammable liquid or gas**
- Replace the battery with a new battery of the same type. If a wrong type of battery is used, it may explode.

**WARNING**

- Do not expose batteries to extremely low pressure due to high altitude or extremely high temperatures.
- Do not burn, break or cut a battery.

**NOTICE****■ When replacing the battery**

Use a flathead screwdriver of appropriate size. Applying excessive force may deform or damage the cover.

■ For normal operation after replacing the battery

Observe the following precautions to prevent accidents:

- Always work with dry hands. Moisture may cause the battery to rust.
- Do not touch or move any other component inside the remote control.
- Do not bend either of the battery terminals.

Checking and replacing fuses

If any of the electrical components do not operate, a fuse may have blown. If this happens, check and replace the fuses as necessary.

Checking and replacing fuses

- 1 Turn the engine switch off.
- 2 Open the fuse box cover.
 - ▶ Engine compartment: type A fuse box

Push the tabs in and lift the lid off.

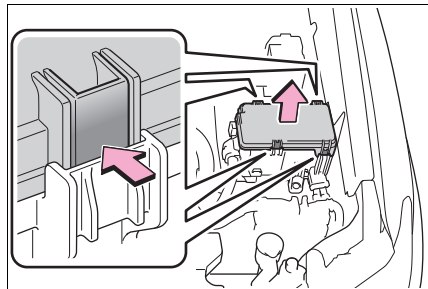

- ▶ Engine compartment: type B fuse box

Push the tabs in and lift the lid off.

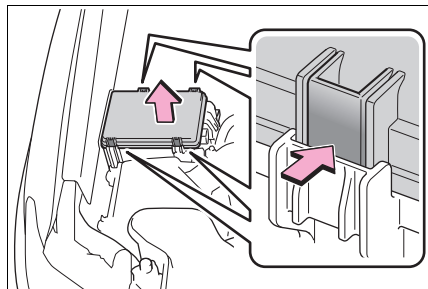

► Passenger' side instrument panel

Remove the cover.

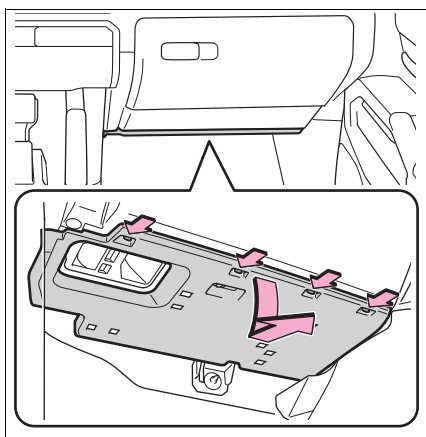

Vehicles with footwell lights:
Remove the footwell lights connector.

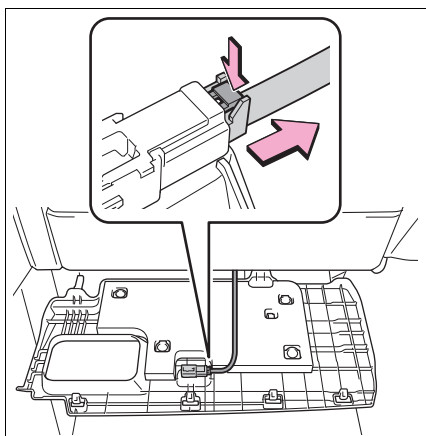

Remove the lid.

Make sure to push the claw when removing/installing the lid.

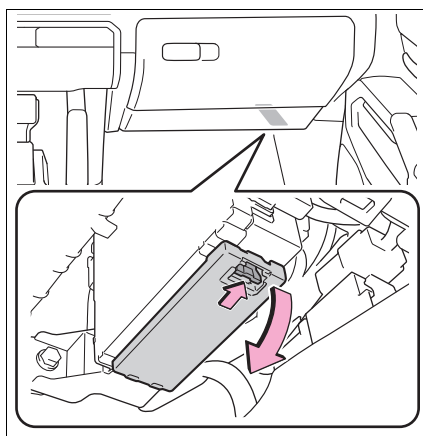

3 Remove the fuse with the pullout tool.
Only type A fuse can be removed using the pullout tool.

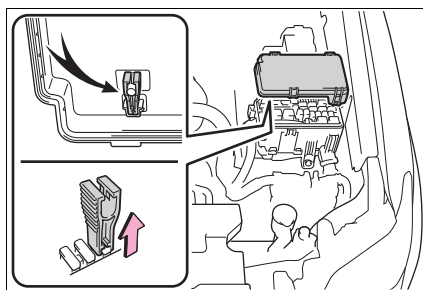

4 Check if the fuse is blown.

Type A and B:
Replace the blown fuse with a new fuse of an appropriate amperage rating. The amperage rating can be found on the fuse box lid.

Type C and D:
Contact your Toyota dealer.

► Type A

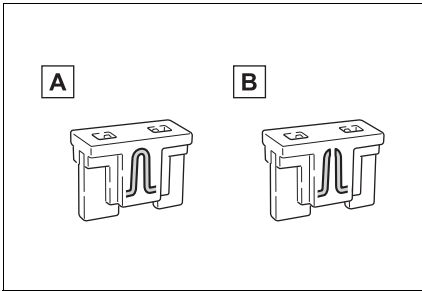

A Normal fuse

B Blown fuse

► Type B

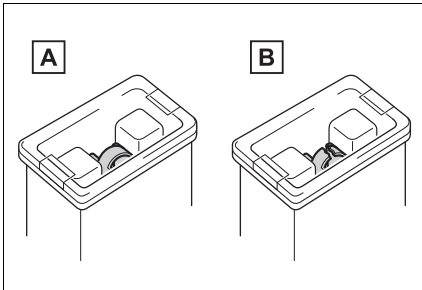

A Normal fuse

B Blown fuse

► Type C

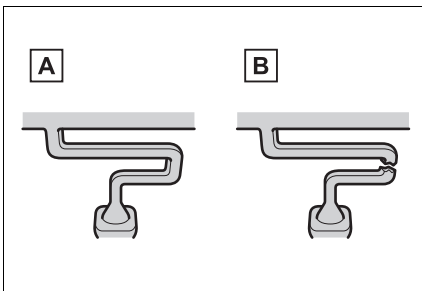

A Normal fuse

B Blown fuse

► Type D

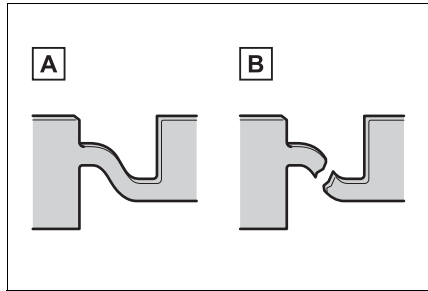

A Normal fuse

B Blown fuse

■ **After a fuse is replaced**

- When installing the lid, make sure that the tab is installed securely.
- If the lights do not turn on even after the fuse has been replaced, a bulb may need replacement.
- If the replaced fuse blows again, have the vehicle inspected by your Toyota dealer.

■ **If there is an overload in a circuit**

The fuses are designed to blow, protecting the wiring harness from damage.

■ **When replacing light bulbs**

Toyota recommends that you use genuine Toyota products designed for this vehicle. Because certain bulbs are connected to circuits designed to prevent overload, non-genuine parts or parts not designed for this vehicle may be unusable.

WARNING

■ To prevent system breakdowns and vehicle fire

Observe the following precautions.

Failure to do so may cause damage to the vehicle, and possibly a fire or injury.

- Never use a fuse of a higher amperage rating than that indicated, or use any other object in place of a fuse.
- Always use a genuine Toyota fuse or equivalent. Never replace a fuse with a wire, even as a temporary fix.
- Do not modify the fuses or fuse boxes.

NOTICE

■ Before replacing fuses

Have the cause of electrical overload determined and repaired by your Toyota dealer as soon as possible.

Light bulbs

You may replace the following bulb by yourself. If necessary bulb replacement seems difficult to perform, contact your Toyota dealer. For more information about replacing other lights, contact your Toyota dealer.

Preparing for light bulb replacement

Check the wattage of the light bulb to be replaced. (→P.623)

Bulb location

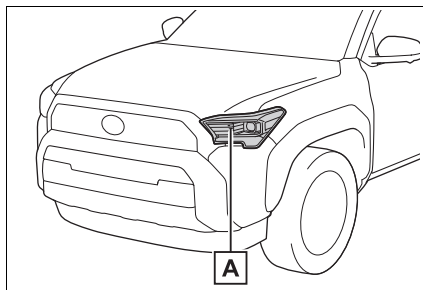

A Front turn signal/parking lights (bulb type)

■ Lights that need to be replaced by your Toyota dealer

- Headlights
- Daytime running lights
- Front turn signal/parking lights (LED type)
- Front fog lights

- Side marker lights
- Side turn signal lights
- Tail lights
- Stop lights
- Back-up light
- Rear turn signal lights
- License plate lights
- High mounted stoplight
- Trailer hitch light

■ When replacing the light bulbs

Confirm that they are properly engaged with the bulb base and that there is no light leakage.

■ LED Lights

The lights other than front turn signal/parking lights (bulb type) consist of a number of LEDs. If any of the LEDs burn out, take your vehicle to your Toyota dealer to have the light replaced.

■ Condensation build-up on the inside of the lens

Temporary condensation build-up on the inside of the headlight lens does not indicate a malfunction. Contact your Toyota dealer for more information in the following situations:

- Large drops of water have built up on the inside of the lens.
- Water has built up inside the headlight.

■ When replacing light bulbs

→P.562

Replacing light bulb

■ Front turn signal/parking lights (bulb type)

- 1 Remove the 5 push clips and air cleaner inlet. (for passenger's side only)

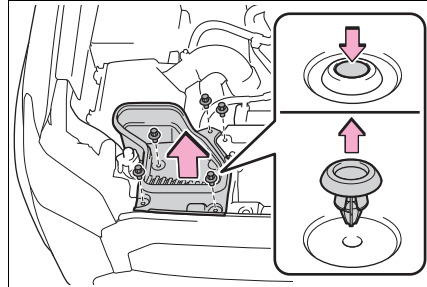

- 2 Turn the bulb base counter-clockwise.

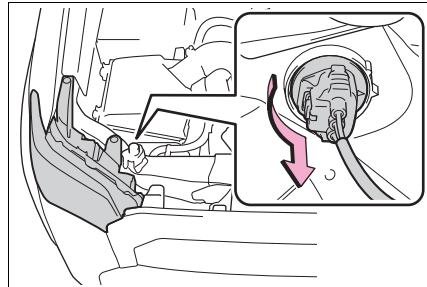

- 3 Remove the light bulb.

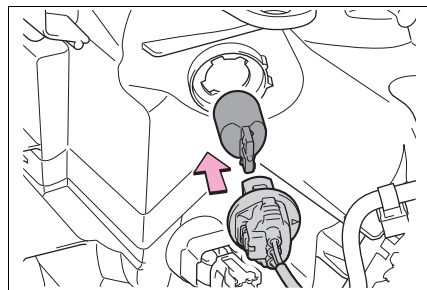

- 4** Install a new light bulb and turn the bulb base clockwise.

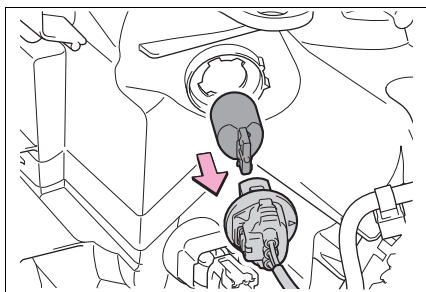

- 5** Install the air cleaner inlet and 4 push clips. (for passenger's side only)

⚠ WARNING

■ Replacing light bulbs

- Turn off the lights. Do not attempt to replace the bulb immediately after turning off the lights. The bulbs become very hot and may cause burns.
- Do not touch the glass portion of the light bulb with bare hands. When it is unavoidable to hold the glass portion, use and hold with a clean dry cloth to avoid getting moisture and oils on the bulb. Also, if the bulb is scratched or dropped, it may blow out or crack.
- Fully install light bulbs and any parts used to secure them. Failure to do so may result in heat damage, fire, or water entering the light unit. This may damage the lights or cause condensation to build up on the lens.

- Do not attempt to repair or disassemble light bulbs, connectors, electric circuits or component parts. Doing so may result in death or serious injury due to electric shock.

■ To prevent damage or fire

- Make sure bulbs are fully seated and locked.

When trouble arises

7

7-1. Essential information

Emergency flashers 568

If your vehicle has to be
stopped in an emergency
..... 568

If the vehicle is submerged
or water on the road is ris-
ing 569

7-2. Steps to take in an emer- gency

If your vehicle needs to be
towed..... 571

If you think something is
wrong 574

Fuel pump shut off system
..... 575

If a warning light turns on or
a warning buzzer sounds
..... 576

If a warning message is dis-
played..... 587

If you have a flat tire.... 593

If the engine will not start
..... 604

If you lose your keys ... 605

If the electronic key does
not operate properly.. 606

If the vehicle battery is dis-
charged 608

If your vehicle overheats
..... 612

If the vehicle becomes stuck
..... 614

Emergency flashers

The emergency flashers are used to warn other drivers when the vehicle has to be stopped on the road due to a breakdown, etc.

Operating instructions

Press the switch to flash all of the turn signal lights.

To turn them off, press the switch once again.

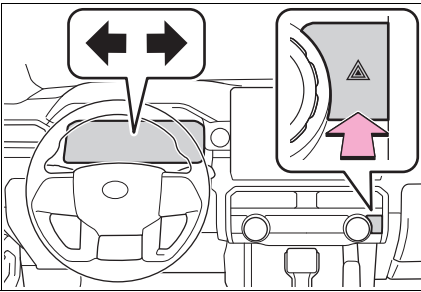

Emergency flashers

- If the emergency flashers are used for a long time while the engine is not running, the battery may discharge.
- If any of the SRS airbags deploy (inflate) or in the event of a strong rear impact, the emergency flashers will turn on automatically. The emergency flashers will turn off automatically after operating for approximately 20 minutes. To manually turn the emergency flashers off, press the switch twice.
(The emergency flashers may not turn on automatically depending on the force of the impact and conditions of the collision.)

If your vehicle has to be stopped in an emergency

Only in an emergency, such as if it becomes impossible to stop the vehicle in the normal way, stop the vehicle using the following procedure:

Stopping the vehicle

- 1 Steadily step on the brake pedal with both feet and firmly depress it.

Do not pump the brake pedal repeatedly as this will increase the effort required to slow the vehicle.

- 2 Shift the shift lever to N.
 - ▶ If the shift lever is shifted to N
- 3 After slowing down, stop the vehicle in a safe place by the road.
- 4 Stop the engine.
 - ▶ If the shift lever cannot be shifted to N
- 3 Keep depressing the brake pedal with both feet to reduce vehicle speed as much as possible.
- 4 To stop the engine, press and hold the engine switch for 2 consecutive seconds or

more, or press it briefly 3 times or more in succession.

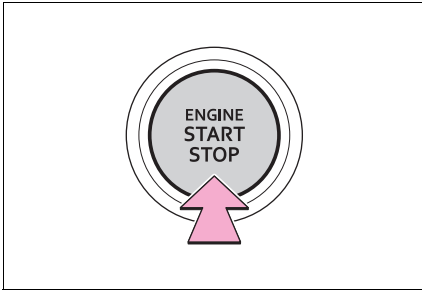

- 5** Stop the vehicle in a safe place by the road.

■ If emergency stopped

The functions of the air conditioning, etc., may be partially limited in order to reduce the power consumption of the battery.

! WARNING

■ If the engine has to be turned off while driving

Power assist for the steering wheel will be lost, making the steering wheel heavier to turn. Decelerate as much as possible before turning off the engine.

If the vehicle is submerged or water on the road is rising

This vehicle is not designed to be able to drive on roads that are deeply flooded with water. Do not drive on roads where the roads may be submerged or the water may be rising. It is dangerous to remain in the vehicle, if it is anticipated that the vehicle will be flooded or set adrift. Remain calm and follow the following.

- If the door can be opened, open the door and exit the vehicle.
- If the door cannot be opened, open the window using the power window switch and ensure an escape route.
- If the window can be opened, exit the vehicle through the window.
- If the door and window cannot be opened due to the rising water, remain calm, wait until the water level inside the vehicle rises to the point that the water pressure inside of the vehicle equals the water pressure outside of the vehicle and then open the door after waiting for the rising water to enter the vehicle, and exit the vehicle.

When the outside water level exceeds half the height of the door, the door cannot be opened from the inside due to water pressure.

■ **Water level exceeds the floor**

When the water level exceeds the floor and time has passed, the electrical equipment will get damaged, the power windows will not operate, the engine stop, and the vehicle may not be able to get moving.

■ **Using an emergency escape hammer*1**

Laminated glass*2 is used in the windshield and the windows on this vehicle.

Laminated glass cannot be shattered with an emergency hammer*1.

*1: Contact your Toyota dealer or aftermarket accessory manufacturer for further information about an emergency hammer.

*2: If equipped

■ **How to distinguish laminated glass**

When looking from the cross-sectional view point, laminated glass is two sheets of glass pasted together.

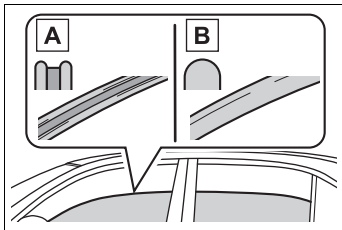

A Laminated glass

B Tempered glass

! WARNING

■ **Caution while driving**

Do not drive on roads where the roads may be submerged or the water may be rising. Otherwise the vehicle may be damaged and cannot move, as well as become flooded and set adrift, which may lead to death.

If your vehicle needs to be towed

If towing is necessary, we recommend having your vehicle towed by your Toyota dealer or commercial towing service, using a wheel-lift type truck or flat-bed truck.

Use a safety chain system for all towing, and abide by all state/provincial and local laws.

Situations when it is necessary to contact dealers before towing

The following may indicate a problem with your transmission. Contact your Toyota dealer or commercial towing service before towing.

- The engine is running but the vehicle does not move.
- The vehicle makes an abnormal sound.

Towing with a wheel-lift type truck

- ▶ From the front

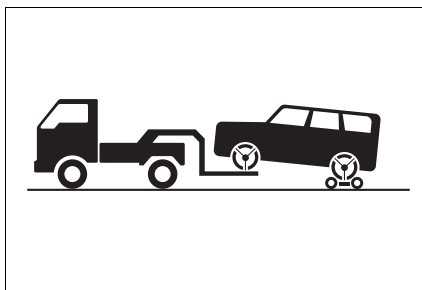

Use a towing dolly under the rear wheels.

- ▶ From the rear

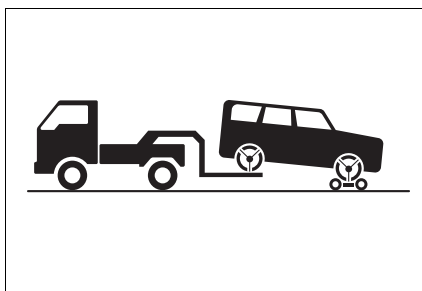

Use a towing dolly under the front wheels.

⚠ WARNING

Observe the following precautions. Failure to do so may result in death or serious injury.

⚠ WARNING

■ **When towing the vehicle**

▶ **2WD models**

Be sure to transport the vehicle with all four wheels raised off the ground. If the vehicle is towed with the tires contacting the ground, the drivetrain and related parts may be damaged or an accident may occur due to a change in direction of the vehicle.

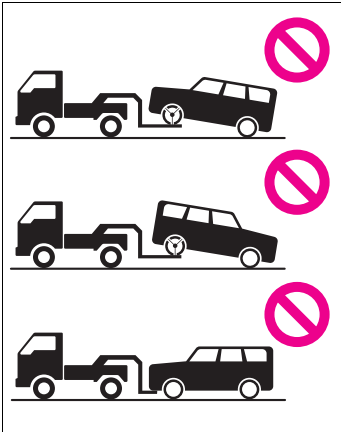

▶ **4WD models**

Be sure to transport the vehicle with all four wheels raised off the ground. If the vehicle is towed with the tires contacting the ground, the drivetrain or related parts may be damaged, the vehicle may fly off the truck.

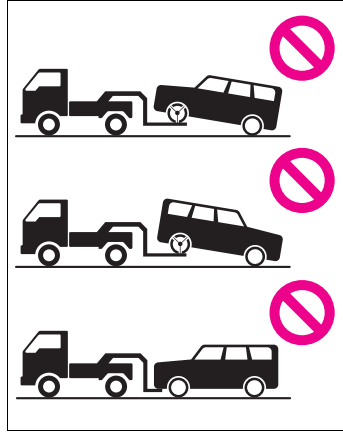

⚠ NOTICE

■ **To prevent damage to the vehicle when towing using a wheel-lift type truck**

- Do not tow the vehicle from the rear when the engine switch is off.
- When raising the vehicle, ensure adequate ground clearance for towing at the opposite end of the raised vehicle. Without adequate clearance, the vehicle could be damaged while being towed.

**NOTICE****■ Towing with a sling-type truck**

Do not tow with a sling-type truck to prevent body damage.

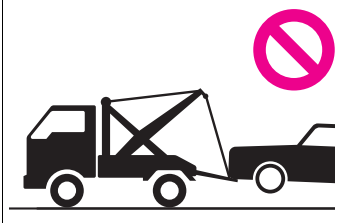
**Using a flatbed truck**

When using a flat-bed truck to transport the vehicle, use tire strapping belts. Refer to the owner's manual of the flat-bed truck for the tire strapping method.

In order to suppress vehicle movement during transportation, set the parking brake and turn the engine switch off.

Emergency towing

If a tow truck is not available in an emergency, your vehicle may be temporarily towed using cables or chains secured to the emergency towing eyelets. This should only be attempted on hard surfaced roads for at most 50 miles (80 km) at under 18 mph (30 km/h).

A driver must be in the vehicle to steer and operate the brakes. The vehicle's wheels, drive train,

axles, steering and brakes must be in good condition.

Emergency towing procedure

- 1 Securely attach cables or chains to the towing hooks.

Take care not to damage the vehicle body.

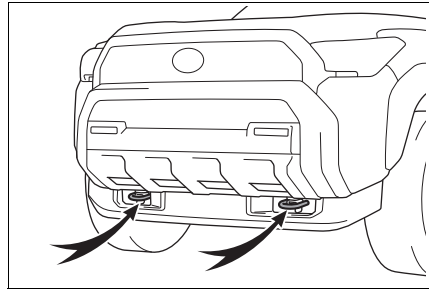

- 2 Enter the vehicle being towed and start the engine.

If the engine does not start, turn the engine switch to ON.

- 3 Vehicles with part-time 4WD: Put the front-wheel drive control switch in "2H".

Vehicles with full-time 4WD: Put the four-wheel drive control switch in "H4F".

- 4 Shift the shift lever to N and release the parking brake.

Turn automatic mode off. (→P.228)

When the shift lever cannot be shifted: →P.224

■ While towing

If the engine is not running, the power assist for the brakes and steering will not function, making steering and braking more difficult.



WARNING

Observe the following precautions. Failure to do so may result in death or serious injury.

■ **While towing**

- When towing using cables or chains, avoid sudden starts, etc. which place excessive stress on the towing eyelets, cables or chains. The towing eyelets, cables or chains may become damaged, broken debris may hit people, and cause serious damage.
- Do not turn the engine switch off. There is a possibility that the steering wheel is locked and cannot be operated.



NOTICE

■ **To prevent damage to the vehicle during emergency towing**

Do not secure cables or chains to the suspension components.

■ **When towing a vehicle equipped with a Stop & Start system**

If it is necessary to tow the vehicle with all 4 wheels on the ground, perform the following procedure before towing the vehicle, in order to protect the system.
Turn the engine switch to OFF and then start the engine or turn the engine switch to ON.

If you think something is wrong

If you notice any of the following symptoms, your vehicle probably needs adjustment or repair. Contact your Toyota dealer as soon as possible.

Visible symptoms

- Fluid leaks under the vehicle. (Water dripping from the air conditioning after use is normal.)
- Flat-looking tires or uneven tire wear
- Engine coolant temperature gauge continually points higher than normal.
- Voltmeter continually points higher or lower than normal.
- Engine oil pressure gauge continually points lower than normal.
- Automatic transmission fluid temperature warning message is displayed

Audible symptoms

- Changes in exhaust sound
- Excessive tire squeal when cornering
- Strange noises related to the suspension system

- Pinging or other noises related to the engine

Operational symptoms

- Engine misses, stumbling or running roughly
- Appreciable loss of power
- Vehicle pulls heavily to one side when braking
- Vehicle pulls heavily to one side when driving on a level road
- Loss of brake effectiveness, spongy feeling, pedal almost touches the floor

Fuel pump shut off system

To minimize the risk of fuel leakage when the engine stalls or when an airbag inflates upon collision, the fuel pump shut off system stops supply of fuel to the engine.

Restarting the engine

Follow the procedure below to restart the engine after the system is activated.

- 1 Turn the engine switch to ACC or OFF.
- 2 Restart the engine.



NOTICE

■ Before starting the engine

Inspect the ground under the vehicle.



If you find that fuel has leaked onto the ground, the fuel system has been damaged and is in need of repair. Do not restart the engine.

If a warning light turns on or a warning buzzer sounds

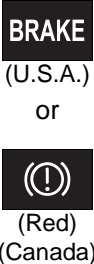

Calmly perform the following actions if any of the warning lights comes on or flashes. If a light comes on or flashes, but then goes off, this does not necessarily indicate a malfunction in the system. However, if this continues to occur, have the vehicle inspected by your Toyota dealer.

Actions to the warning lights or warning buzzers



■ Brake system warning light (warning buzzer)

Warning light	Details/Actions
 <p>BRAKE (U.S.A.) or  (Red) (Canada)</p>	<p>Indicates that:</p> <ul style="list-style-type: none"> ● The brake fluid level is low; or ● The brake system is malfunctioning <p>→ Immediately stop the vehicle in a safe place and contact your Toyota dealer. Continuing to drive the vehicle may be dangerous.</p>

■ Brake system warning light (warning buzzer)

Warning light	Details/Actions
 <p> (Yellow)</p>	<p>Indicates a malfunction in the parking brake system</p> <p>→ Have the vehicle inspected by your Toyota dealer immediately.</p>

■ High coolant temperature warning light* (warning buzzer)

Warning light	Details/Actions
 <p></p>	<p>Indicates that the engine coolant temperature is overheating</p> <p>→ Immediately stop the vehicle in a safe place. Handling method (→P.612)</p>

* : This light illuminates on the multi-information display with a message.

■ Charging system warning light* (warning buzzer)

Warning light	Details/Actions
	Indicates a malfunction in the vehicle's charging system → Immediately stop the vehicle in a safe place and contact your Toyota dealer.



*: This light illuminates on the multi-information display with a message.

■ Low engine oil pressure warning light* (warning buzzer)

Warning light	Details/Actions
	Indicates that the engine oil pressure is excessively low → Immediately stop the vehicle in a safe place and contact your Toyota dealer.

*: This light illuminates on the multi-information display with a message.



■ Malfunction indicator lamp (warning buzzer)

Warning light	Details/Actions
 (U.S.A.) or  (Canada)	Indicates a malfunction in: <ul style="list-style-type: none"> ● The electronic engine control system; ● The electronic throttle control system; or ● The emission control system → Have the vehicle inspected by your Toyota dealer immediately.



■ SRS warning light

Warning light	Details/Actions
	Indicates a malfunction in: <ul style="list-style-type: none"> ● The SRS airbag system; or ● The seat belt pretensioner system → Have the vehicle inspected by your Toyota dealer immediately.

■ **ABS warning light**

Warning light	Details/Actions
 <p>(U.S.A.) or</p>  <p>(Canada)</p>	<p>Indicates a malfunction in:</p> <ul style="list-style-type: none"> ● The ABS; or ● The brake assist system <p>→ Have the vehicle inspected by your Toyota dealer immediately.</p>

■ **Electric power steering system warning light (warning buzzer)**

Warning light	Details/Actions
 <p>(Red) or</p>  <p>(Yellow)</p>	<p>Indicates a malfunction in the EPS (Electric Power Steering) system</p> <p>→ Have the vehicle inspected by your Toyota dealer immediately.</p>

■ **PCS warning light (warning buzzer)**

Warning light	Details/Actions
	<p>Indicates a malfunction in the PCS (Pre-Collision System).</p> <p>→ Follow the instructions displayed on the multi-information display.</p> <p>If the PCS (Pre-Collision System) or VSC (Vehicle Stability Control) system is disabled, the PCS warning light will illuminate.</p>

■ **LDA indicator (warning buzzer)**

Warning light	Details/Actions
 <p>(Yellow)</p>	<p>Indicates a malfunction in the LDA (Lane Departure Alert)</p> <p>→ Follow the instructions displayed on the multi-information display.</p>

■ LTA indicator (warning buzzer)

Warning light	Details/Actions
 (Yellow)	Indicates a malfunction in the LTA (Lane Tracing Assist) → Follow the instructions displayed on the multi-information display.

■ Driving assist information indicator

Warning light	Details/Actions
	<p>The following systems may be malfunctioning.</p> <ul style="list-style-type: none"> ● PCS (Pre-Collision System) ● LDA (Lane Departure Alert) <p>→ Follow the instructions displayed on the multi-information display.</p> <p>Indicates one of the following systems is malfunctioning or disabled.</p> <ul style="list-style-type: none"> ● PKSB (Parking Support Brake) (if equipped) ● RCD (Rear Camera Detection) (if equipped) ● BSM (Blind Spot Monitor) ● RCTA (Rear Cross Traffic Alert) <p>→ Follow the instructions displayed on the multi-information display.</p> <p>When towing another vehicle. → P.308</p>

■ PDA indicator (warning buzzer)

Warning light	Details/Actions
 (Yellow)	Indicates a malfunction in the PDA (Proactive driving assist). → Follow the instructions displayed on the multi-information display.

■ Dynamic radar cruise control indicator (warning buzzer)

Warning light	Details/Actions
 (Yellow)	Indicates a malfunction in the Dynamic radar cruise control. → Follow the instructions displayed on the multi-information display.

■ **Cruise control indicator (warning buzzer)**

Warning light	Details/Actions
 <p>(Yellow)</p>	<p>Indicates a malfunction in the cruise control.</p> <p>→ Follow the instructions displayed on the multi-information display.</p>

■ **Stop & Start cancel indicator**

Warning light	Details/Actions
 <p>(Flashes) (if equipped)</p>	<p>Indicates a malfunction in the Stop & Start system</p> <p>→ Have the vehicle inspected by your Toyota dealer immediately.</p>

■ **Intuitive parking assist OFF indicator (warning buzzer)**

Warning light	Details/Actions
 <p>(if equipped)</p>	<p>When a buzzer sounds:</p> <p>Indicates a malfunction in the intuitive parking assist function</p> <p>→ Have the vehicle inspected by your Toyota dealer immediately.</p> <p>When a buzzer does not sound:</p> <p>Indicates that the system is temporarily unavailable, possibly due to a sensor being dirty or covered with ice, etc.</p> <p>→ Follow the instructions displayed on the multi-information display. (→P.590)</p>

■ **Slip indicator light**

Warning light	Details/Actions
	<p>Indicates a malfunction in:</p> <ul style="list-style-type: none"> ● The VSC/Trailer Sway Control system; ● The TRAC system; ● The hill-start assist control system; ● Multi-terrain Select brake control (if equipped); ● Crawl Control (if equipped); or ● The downhill assist control system (if equipped) <p>→ Have the vehicle inspected by your Toyota dealer immediately.</p>

■ Inappropriate pedal operation warning light* (warning buzzer)

Warning light	Details/Actions
	<p>When a buzzer sounds:</p> <ul style="list-style-type: none"> ● Brake Override System is malfunctioning ● Drive-Start Control is malfunctioning ● Drive-Start Control is operating <p>→ Follow the instructions displayed on the multi-information display.</p> <p>When a buzzer does not sound: Brake Override System is operating. → Release the accelerator pedal and depress the brake pedal.</p>

*: This light illuminates on the multi-information display with a message.

■ Brake hold operated indicator (warning buzzer)

Warning light	Details/Actions
	<p>Indicates a malfunction in the brake hold system</p> <p>→ Have the vehicle inspected by your Toyota dealer immediately.</p>

■ Parking brake indicator

Warning light	Details/Actions
	<p>It is possible that the parking brake is not fully engaged or released</p> <p>→ Operate the parking brake switch once again.</p> <p>This light comes on when the parking brake is not released. If the light turns off after the parking brake is fully released, the system is operating normally.</p>

■ Center differential lock indicator

Warning light	Details/Actions
	<p>Indicates a malfunction in the center differential lock system</p> <p>→ Have the vehicle inspected by your Toyota dealer immediately.</p>

■ Rear differential lock indicator

Warning light	Details/Actions
 <p>(Flashes) (If equipped)</p>	<p>Indicates a malfunction in the rear differential lock system → Have the vehicle inspected by your Toyota dealer immediately.</p>

■ High speed four-wheel drive indicator

Warning light	Details/Actions
 <p>(Yellow) (If equipped)</p>	<p>Indicates a malfunction in the four-wheel drive system → Have the vehicle inspected by your Toyota dealer immediately.</p>

■ Low speed four-wheel drive indicator

Warning light	Details/Actions
 <p>(Flashes) (If equipped)</p>	<p>Indicates a malfunction in the four-wheel drive system → Have the vehicle inspected by your Toyota dealer immediately.</p>

■ Tire pressure warning light

Warning light	Details/Actions
 <p>(Flashes) (If equipped)</p>	<p>When the light comes on after blinking for approximately 1 minute: Malfunction in the tire pressure warning system → Have the system checked by your Toyota dealer.</p> <p>When the light comes on: Low tire inflation pressure such as</p> <ul style="list-style-type: none"> ● Natural causes ● Flat tire <p>→ Immediately stop the vehicle in a safe place. Handling method (→P.584)</p>

■ Low fuel level warning light

Warning light	Details/Actions
	Indicates that remaining fuel is approximately 2.8 gal. (10.8 L, 2.3 Imp. gal.) or less → Refuel the vehicle.

■ Driver's and front passenger's seat belt reminder light (warning buzzer)*

Warning light	Details/Actions
	Warns the driver and/or front passenger to fasten their seat belts → Fasten the seat belt. If the front passenger's seat is occupied, the front passenger's seat belt also needs to be fastened to make the warning light (warning buzzer) turn off.

*: Driver's seat belt warning buzzer:

The driver's seat belt warning buzzer sounds to alert the driver that his or her seat belt is not fastened. Once the engine switch is turned to ON, the buzzer sounds. If the seat belt is still unfastened, the buzzer sounds intermittently for a certain period of time after the vehicle reaches a certain speed.

Front passenger's seat belt warning buzzer:

The front passenger's seat belt warning buzzer sounds to alert the front passenger that his or her seat belt is not fastened. If the seat belt is unfastened, the buzzer sounds intermittently for a certain period of time after the vehicle reaches a certain speed.

■ Rear passengers' seat belt reminder lights (warning buzzer)*

Warning light	Details/Actions
	Warns the rear passengers to fasten their seat belts → Fasten the seat belt.

*: Rear passengers' seat belt warning buzzer:

The rear passengers' seat belt warning buzzer sounds to alert the rear passenger that his or her seat belt is not fastened. If the seat belt is unfastened, the buzzer sounds intermittently for a certain period of time, after the seat belt is fastened and unfastened and the vehicle reaches a certain speed.

■ **Trailer brake warning light**

Warning light	Details/Actions
 <p>(If equipped)</p>	<p>Indicates a malfunction in:</p> <ul style="list-style-type: none"> ● Trailer brake control system; or ● Trailer connector circuit <p>→ Have the vehicle inspected by your Toyota dealer immediately.</p>

■ **Warning buzzer**

In some cases, the buzzer may not be heard due to being in a noisy location or audio sound.

■ **Front passenger detection sensor, seat belt reminder and warning buzzer**

- If luggage is placed on the front passenger seat, the front passenger detection sensor may cause the warning light to flash and the warning buzzer to sound even if a passenger is not sitting in the seat.
- If a cushion is placed on the seat, the sensor may not detect a passenger, and the warning light may not operate properly.

■ **SRS warning light**

This warning light indicates problems with the following:

- Airbag sensor assembly
- Front impact sensors
- Side impact sensors (front door)
- Side impact sensors (rear)
- Front passenger occupant classification sensors
- Driver's seat position sensor
- Driver's seat belt buckle switch
- Front passenger's seat belt buckle switch
- SRS warning light
- "AIR BAG ON" indicator light
- "AIR BAG OFF" indicator light
- Driver's seat belt pretensioner,

front passenger's seat belt pretensioner and force limiter

- SRS airbags
- SRS system related wiring harnesses and power sources

■ **If the malfunction indicator lamp comes on while driving**

First check the following:

- Is the fuel tank empty?
If it is, fill the fuel tank immediately.

- Is the fuel tank cap loose?

If it is, tighten it securely.

The light will go off after several driving trips.

If the light does not go off even after several trips, contact your Toyota dealer as soon as possible.

■ **Electric power steering system warning light (warning buzzer)**

When the battery charge becomes insufficient or the voltage temporarily drops, the electric power steering system warning light may come on and the warning buzzer may sound.

■ **When the tire pressure warning light comes on**

Inspect the tires to check if a tire is punctured.

If a tire is punctured: →P.593

If none of the tires are punctured: Turn the engine switch off then turn it to ON. Check if the tire pressure warning light comes on or blinks.

- ▶ If the tire pressure warning light blinks for approximately 1 minute then stays on

There may be a malfunction in the tire pressure warning system. Have the vehicle inspected by your Toyota dealer immediately.

- ▶ If the tire pressure warning light comes on
 - 1 After the temperature of the tires has lowered sufficiently, check the inflation pressure of each tire and adjust them to the specified level.
 - 2 If the warning light does not turn off even after several minutes have elapsed, check that the inflation pressure of each tire is at the specified level and perform initialization. (→P.544)

■ The tire pressure warning light may come on due to natural causes

The tire pressure warning light may come on due to natural causes such as natural air leaks and tire inflation pressure changes caused by temperature. In this case, adjusting the tire inflation pressure will turn off the warning light (after a few minutes).

■ When a tire is replaced with a spare tire

The temporary spare tire is not equipped with the tire pressure warning valve and transmitter. If a tire goes flat, the tire pressure warning light will not turn off even though the flat tire is replaced with the temporary spare tire.

Replace the temporary spare tire with the repaired tire and adjust the proper tire inflation pressure. The tire pressure warning light will turn off after several minutes.

■ Conditions that the tire pressure warning system may not function properly

→P.543

WARNING

■ If both the ABS and the brake system warning lights remain on

Stop your vehicle in a safe place immediately and contact your Toyota dealer.

The vehicle will become extremely unstable during braking, and the ABS system may fail, which could cause an accident resulting in death or serious injury.

■ When the electric power steering system warning light comes on

When the light comes on yellow, the assist to the power steering is restricted. When the light comes on red, the assist to the power steering is lost and handling operations of the steering wheel become extremely heavy.

When steering wheel operations are heavier than usual, grip the steering wheel firmly and operate it using more force than usual.

■ If the tire pressure warning light comes on

Be sure to observe the following precautions.

Failure to do so could cause a loss of vehicle control and result in death or serious injury.

- Stop your vehicle in a safe place as soon as possible. Adjust the tire inflation pressure immediately.
- If the tire pressure warning light comes on even after tire inflation pressure adjustment, it is probable that you have a flat tire. Check the tires. If a tire is flat, change it with the spare tire and have the flat tire repaired by the nearest Toyota dealer.

**WARNING**

- Avoid abrupt maneuvering and braking.

If the vehicle tires deteriorate, you could lose control of the steering wheel or the brakes.

- **If a blowout or sudden air leakage should occur**

The tire pressure warning system may not activate immediately.

- **Maintenance of the tires**

Each tire, including the spare (if provided), should be checked monthly when cold and inflated to the inflation pressure recommended by the vehicle manufacturer on the vehicle placard or tire inflation pressure label (tire and load information label). (If your vehicle has tires of a different size than the size indicated on the vehicle placard or tire inflation pressure label [tire and load information label], you should determine the proper tire inflation pressure for those tires.)

As an added safety feature, your vehicle has been equipped with a tire pressure monitoring system (TPMS-tire pressure warning system) that illuminates a low tire pressure telltale (tire pressure warning light) when one or more of your tires is significantly under-inflated. Accordingly, when the low tire pressure telltale (tire pressure warning light) illuminates, you should stop and check your tires as soon as possible, and inflate them to the proper pressure. Driving on a significantly under-inflated tire causes the tire to overheat and can lead to tire failure. Under-inflation also reduces fuel efficiency and tire tread life, and may affect the vehicle's handling and stopping ability.

Please note that the TPMS (tire pressure warning system) is not a substitute for proper tire maintenance, and it is the driver's responsibility to maintain correct tire pressure, even if under-inflation has not reached the level to trigger illumination of the TPMS low tire pressure telltale (tire pressure warning light).

Your vehicle has also been equipped with a TPMS (tire pressure warning system) malfunction indicator to indicate when the system is not operating properly. The TPMS (tire pressure warning system) malfunction indicator is combined with the low tire pressure telltale (tire pressure warning light). When the system detects a malfunction, the telltale will flash for approximately one minute and then remain continuously illuminated. This sequence will continue upon subsequent vehicle start-ups as long as the malfunction exists. When the malfunction indicator is illuminated, the system may not be able to detect or signal low tire pressure as intended.

TPMS (tire pressure warning system) malfunctions may occur for a variety of reasons, including the installation of replacement or alternate tires or wheels on the vehicle that prevent the TPMS (tire pressure warning system) from functioning properly. Always check the TPMS (tire pressure warning system) malfunction telltale after replacing one or more tires or wheels on your vehicle to ensure that the replacement or alternate tires and wheels allow the TPMS (tire pressure warning system) to continue to function properly.



NOTICE

■ To ensure the tire pressure warning system operates properly

Do not install tires with different specifications or manufactures as the tire pressure warning system may not operate properly.

If a warning message is displayed

The multi-information display shows warnings of system malfunctions, incorrectly performed operations, and messages that indicate a need for maintenance. When a message is shown, perform the correction procedure appropriate to the message.

Additionally, if a warning light comes on or flashes at the same time that a warning message is displayed, take the appropriate corrective action for the warning light. (→P.576)

If a warning message is displayed again after the appropriate actions have been performed, contact your Toyota dealer.

■ Warning messages

The warning messages explained below may differ from the actual messages according to operation conditions and vehicle specifications.

■ If a message about an operation is displayed

- If a message about an operation of the accelerator pedal or brake pedal is displayed

A warning message about an operation of the brake pedal may be shown while the driving assist sys-

tems such as PCS (Pre-Collision system) or the dynamic radar cruise control is operating. If a warning message is shown, be sure to decelerate the vehicle or follow an instruction shown on the multi-information display.

- A warning message is shown when Brake Override System operates. (→P.194)
- A warning message is shown when Drive-Start Control (→P.199) operates. Follow the instructions on the multi-information display.

- If a message about an operation of the engine switch is displayed

An instruction for operation of the engine switch is shown when the incorrect procedure for starting the engine is performed or the engine switch is operated incorrectly. Follow the instructions shown on the multi-information display to operate the engine switch again.

- If a message about a shift lever operation is displayed

To prevent the shift lever from being operated incorrectly or the vehicle from moving unexpectedly, a message that requires shifting the shift lever may be shown on the multi-information display. In that case, follow the instruction of the message and shift the shift lever.

- If a message or image about an open/close state of a part or replenishment of a consumable is displayed

Confirm the part indicated by the multi-information display or a warning light, and then perform the coping method such as closing the open door or replenishing a consumable.

■ If a message that indicates the need for visiting your Toyota dealer is displayed

The system or part shown on the multi-information display is malfunctioning. Have the vehicle inspected by your Toyota dealer immediately.

■ If a message that indicates the need for referring to Owner's Manual is displayed

- If "Engine Coolant Temp High Stop in a Safe Place See Owner's Manual" is shown, follow the instructions (→P.612).

- If the following messages are shown, there may be a malfunction.

Immediately stop the vehicle in a safe place and contact your Toyota dealer. Continuing to drive the vehicle may be dangerous.

- "Transmission Oil Temp High Stop in a Safe Place and See Owner's Manual"
- "Smart Key System malfunction See owner's manual"

- If the following messages are shown, there may be a malfunction.

Immediately have the vehicle inspected by your Toyota dealer.

- "Oil pressure low Stop in a safe place See owner's manual"
- "Braking Power Low Stop in a Safe Place See Owner's Manual"

■ If "Shift to P Before Exiting Vehicle" is displayed

Message is displayed when the driver's door is opened without turning the engine switch to OFF with the shift lever in any position other than P.

Shift the shift lever to P.

■ If "Auto Power OFF to Conserve Battery" is displayed

Power was turned off due to the automatic power off function.

Next time when starting the engine, increase the engine speed slightly

and maintain that level for approximately 5 minutes to recharge the battery.

■ **If “Headlight System Malfunction Visit Your Dealer” is displayed**

The following systems may be malfunctioning. Have the vehicle inspected by your Toyota dealer immediately.

- The LED headlight system
- AHB (Automatic High Beam)

■ **If “Engine Oil Level Low Add or Replace” is displayed**

The engine oil level may be low. Check the level of the engine oil, and add engine oil if necessary (→P.531). This message may be displayed if the vehicle is stopped on a slope. Move the vehicle to a level surface and check if the message disappears.

■ **If “Engine Stopped Steering Power Low” is displayed**

This message is displayed if the engine is stopped while driving.

When steering wheel operations are heavier than usual, grip the steering wheel firmly and operate it using more force than usual.

■ **If “Maintenance Required Soon” is displayed**

Indicates that all maintenance according to the driven distance on the maintenance schedule* should be performed soon.

Comes on approximately 4500 miles (7200 km) after the message has been reset.

If necessary, perform maintenance. Please reset the message after the maintenance is performed. (→P.521)

*: Refer to the separate “Scheduled Maintenance Guide” or “Owner’s Manual Supplement” for the maintenance interval applicable to your

vehicle.

■ **If “Maintenance Required Visit Your Dealer” is displayed**

Indicates that all maintenance is required to correspond to the driven distance on the maintenance schedule*.

Comes on approximately 5000 miles (8000 km) after the message has been reset. (The indicator will not work properly unless the message has been reset.)

Perform the necessary maintenance. Please reset the message after the maintenance is performed. (→P.521)

*: Refer to the separate “Scheduled Maintenance Guide” or “Owner’s Manual Supplement” for the maintenance interval applicable to your vehicle.

■ **If “Engine Maintenance Required Visit Your Dealer” is displayed**

The engine or an engine component is malfunctioning.

Have the vehicle inspected by your Toyota dealer.

■ **If “Oil Maintenance Required Soon” is displayed**

Indicates that the engine oil should be scheduled to be changed.

Check the engine oil and change it if necessary. After changing the engine oil, make sure to reset the message. (→P.532)

■ **If “Oil Maintenance Required” is displayed**

Indicates that the engine oil should be changed.

Check and change the engine oil, and oil filter by your Toyota dealer. After changing the engine oil, make sure to reset the message. (→P.532)

■ If “**Parking Assist Unavailable Sensor Blocked**” is displayed on the multi-information display (if equipped)

A sensor may be covered with water drops, ice, snow, dirt, etc. Remove the water drops, ice, snow, dirt, etc., from the sensor to return the system to normal.



Also, due to ice forming on a sensor at low temperatures, a warning message may be displayed or the sensor may not be able to detect an object. Once the ice melts, the system will return to normal.

If a sensor is dirty, the position of the dirty sensor will be shown on the display.

If an abnormality is displayed even though there are no water drops, ice, snow or dirt, the sensor may be operating abnormally. Have the vehicle inspected by your Toyota dealer.

■ If “**Parking Assist Unavailable Low Visibility See Owner’s Manual**” is displayed





Indicates one of the following systems is disabled.









-  RCD (Rear Camera Detection) (if equipped)
-  PKSB (Parking Support Brake) (if equipped)

Remove any dirt or foreign matter from the rear camera.

■ If “**System Malfunction Visit Your Dealer**” is displayed

Indicates one of the following systems is disabled.

-  PCS (Pre-Collision System)
-  LDA (Lane Departure Alert)
-  LTA (Lane Tracing Assist)
-  AHB (Automatic High Beam)









-  Dynamic radar cruise control
-  RSA (Road Sign Assist) (if equipped)
-  PDA (Proactive Driving Assist)
-  BSM (Blind Spot Monitor)
-  RCTA (Rear Cross Traffic Alert)
-  Intuitive parking assist (if equipped)
-  PKSB (Parking Support Brake) (if equipped)
-  RCD (Rear Camera Detection) (if equipped)

Have the vehicle inspected by your Toyota dealer immediately.



■ If “**System Stopped See Owner’s Manual**” is displayed

Indicates one of the following systems is disabled.

Check the displayed icon, and follow the following correction methods.

-  PCS (Pre-Collision System)
-  LDA (Lane Departure Alert)
-  LTA (Lane Tracing Assist)
-  AHB (Automatic High Beam)
-  Dynamic radar cruise control
-  RSA (Road Sign Assist) (if equipped)
-  PDA (Proactive Driving Assist)
-  BSM (Blind Spot Monitor)
-  RCTA (Rear Cross Traffic





Alert)



-  Intuitive parking assist (if equipped)
-  PKSB (Parking Support Brake) (if equipped)
-  RCD (Rear Camera Detection) (if equipped)
- Check the sensors that the Toyota Safety Sense 3.0 uses for foreign matter covering them. Remove them if any. (→P.251)
- Vehicles with RCD (Rear Camera Detection): Check if the back door is open.
- Check the situations in which the sensors may not operate properly, and improve the situation if applicable. (→P.254, 322, 326, 333, 346, 348, 350)
- Check the sensors including camera sensors for foreign matter covering them. Remove them if any. (→P.323)
- Check the rear bumper around the sensors (→P.317) used by the BSM or RCTA for foreign matter covering them. Remove them if any.

When problems are solved and the sensors are operational, this indication may disappear by itself.

■ If “System Stopped Front Camera Low Visibility See Owner’s Manual” is displayed

Indicates one of the following systems is disabled.

-  PCS (Pre-Collision System)
-  LDA (Lane Departure Alert)
-  LTA (Lane Tracing Assist)
-  AHB (Automatic High Beam)







-  Dynamic radar cruise control
-  RSA (Road Sign Assist) (if equipped)
-  PDA (Proactive Driving Assist)

Follow the following correction methods.

- Using the windshield wipers, remove the dirt or foreign matter from the windshield.
- Using the air conditioning system, defog the windshield.
- Close the hood, remove any stickers, etc. to clear the obstruction in front of the front camera.

■ If “System Stopped Front Camera Out of Temperature Range Wait until Normal Temperature” is displayed

Indicates one of the following systems is disabled.

-  PCS (Pre-Collision System)
-  LDA (Lane Departure Alert)
-  LTA (Lane Tracing Assist)
-  AHB (Automatic High Beam)
-  Dynamic radar cruise control
-  RSA (Road Sign Assist) (if equipped)
-  PDA (Proactive Driving Assist)

Follow the following correction methods.





- If the front camera is hot, such as after the vehicle is parked in the sun, use the air conditioning system to decrease the temperature around the front camera
- If a sunshade was used when the vehicle was parked, depending on its type, the sunlight reflected from

the surface of the sunshade may cause the temperature of the front camera to become excessively high

- If the front camera is cold, such as after the vehicle is parked in an extremely cold environment, use the air conditioning system to increase the temperature around the front camera

■ **If “System Stopped Front Radar Sensor Blocked Clean Radar Sensor” is displayed**

Indicates one of the following systems is disabled.



-  PCS (Pre-Collision System)
-  LTA (Lane Tracing Assist)
-  Dynamic radar cruise control
-  PDA (Proactive Driving Assist)

Follow the following correction methods.

- Check if there is any foreign matter attached to the radar sensor or radar sensor cover and clean them if necessary (→P.252)
- This message may be displayed when driving in an open area with few nearby vehicles or structures, such as a desert, grasslands, suburbs, etc.
- The message may be cleared by driving the vehicle in an area with structures, vehicles, etc., nearby.

■ **If “System Stopped Front Radar Sensor Out of Temperature Range Wait until Normal Temperature” is displayed**

Indicates one of the following systems is disabled.

-  PCS (Pre-Collision System)
-  LTA (Lane Tracing Assist)
-  Dynamic radar cruise control





-  PDA (Proactive Driving Assist)

Follow the following correction methods.

- The temperature of the radar sensor is outside of the operating range. Wait for the temperature to become appropriate.

■ **If “System Stopped Front Radar In Self Calibration See Owner’s Manual” is displayed**

Indicates one of the following systems is disabled.

-  PCS (Pre-Collision System)
-  LTA (Lane Tracing Assist)
-  Dynamic radar cruise control
-  PDA (Proactive Driving Assist)

Follow the following correction methods.

- Check if there is any foreign matter attached to the radar sensor or radar sensor cover and clean them if necessary (→P.252)
- The radar sensor may be misaligned and will be adjusted automatically while driving. Continue driving for a while.

■ **If “Cruise Control Unavailable See Owner’s Manual” is displayed**

Indicates one of the following systems is disabled.

- Dynamic radar cruise control
- Cruise control

A message is displayed when the driving assist switch is pushed repeatedly.

Press the driving assist switch quickly and firmly.

If you have a flat tire

Your vehicle is equipped with a spare tire. The flat tire can be replaced with the spare tire.

For details about tires: P.539

⚠ WARNING**■ If you have a flat tire**

Do not continue driving with a flat tire.

Driving even a short distance with a flat tire can damage the tire and the wheel beyond repair, which could result in an accident.

Before repairing the tire

- Stop the vehicle in a safe place on a hard, flat surface.
- Set the parking brake.
- Shift the shift lever to P.
- Stop the engine.
- Turn on the emergency flashers. (→P.568)

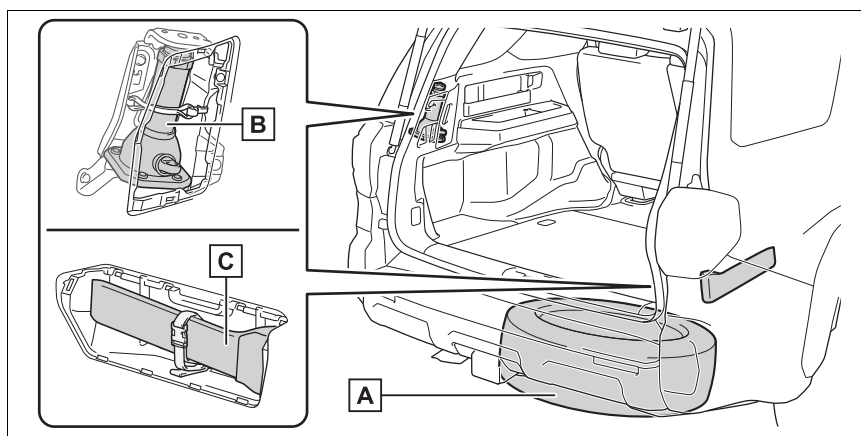
Location of the spare tire, jack and tools**■ Spare tire, jack and tools****▶ Vehicles without third seats**

A Spare tire

B Jack

C Tool bag

► Vehicles with third seats

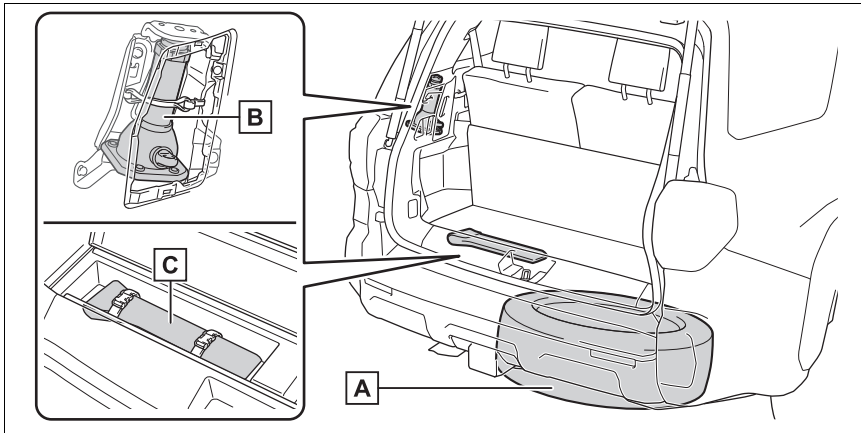

A Spare tire

B Jack

C Tool bag

⚠ WARNING

■ **Using the tire jack**

Observe the following precautions.

Improper use of the tire jack may cause the vehicle to suddenly fall off the jack, leading to death or serious injury.

- Do not use the tire jack for any purpose other than replacing tires or installing and removing tire chains.
- Only use the tire jack that comes with this vehicle for replacing a flat tire. Do not use it on other vehicles, and do not use other tire jacks for replacing tires on this vehicle.
- Put the jack properly in its jack point.
- Do not put any part of your body under the vehicle while it is supported by the jack.

- Do not start the engine or drive the vehicle while the vehicle is supported by the jack.
- Do not raise the vehicle while someone is inside.
- When raising the vehicle, do not put an object on or under the jack.
- Do not raise the vehicle to a height greater than that required to replace the tire.
- Use a jack stand if it is necessary to get under the vehicle.
- When lowering the vehicle, make sure that there is no-one near the vehicle. If there are people nearby, warn them vocally before lowering.

■ **Using the jack handle**

Insert the square head securely until you hear a click to prevent the extension parts from coming apart unexpectedly.

Wheel lock nut (if equipped)

When replacing tires on a vehicle with wheel lock nuts, use the following procedures to remove and install the wheel lock nuts. The wheel lock key is stored in the glove box. Always return the wheel lock key to its original position after use, so that it does not get lost. (→P.593)

■ Removal

For ease of removal, the wheel lock nut should always be the first one loosened.

- 1 Place the wheel lock key on top of the wheel lock nut, turning until the wheel lock key and wheel lock nut patterns engage.
- 2 Place the wheel nut wrench on the wheel lock key, and while applying pressure on the wheel lock key, loosen the wheel lock nut.

■ Installation

For ease of installation, the wheel lock nut should always be the last one tightened.

- 1 By hand, install a wheel lock nut on each wheel.
- 2 Place the wheel lock key on top of the wheel lock nut, turning until the wheel lock key and wheel lock nut patterns engage.

- 3 Place the wheel nut wrench on the wheel lock key, and while applying pressure on the wheel lock key, tighten the wheel lock nut to the recommended torque.

⚠ NOTICE**■ When using a wheel lock key (if equipped)**

Do not use an impact wrench. Using an impact wrench may cause permanent damage to wheel lock nut and wheel lock key. If in doubt about wheel lock application, contact your Toyota dealer.

Taking out the jack

- 1 Remove the cover.

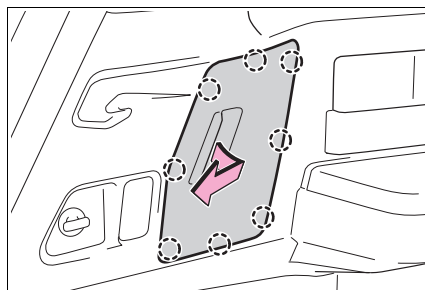

- 2 Unhook the rubber strap, and take out the jack.

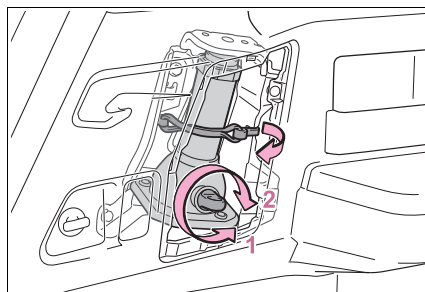

- 1 Loosen

2 Tighten

After using the jack, install the jack in the exact reverse order from which it was removed. Also, the jack should be properly secured using a rubber strap.

Taking out the tool bag

► Vehicles without third seats

1 Remove the cover.

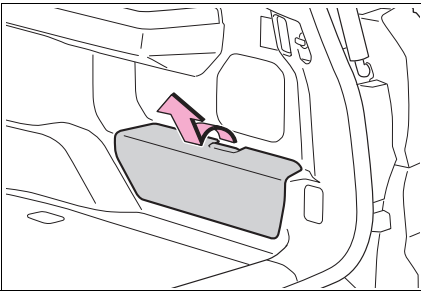

2 Take out the tool bag.

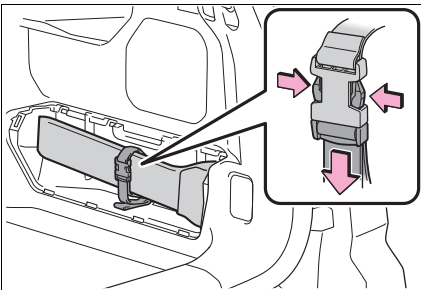

► Vehicles with third seats

1 Lift the deck board.

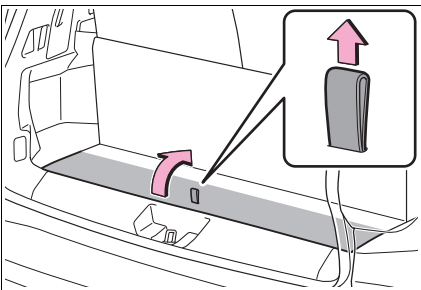

2 Take out the tool bag.

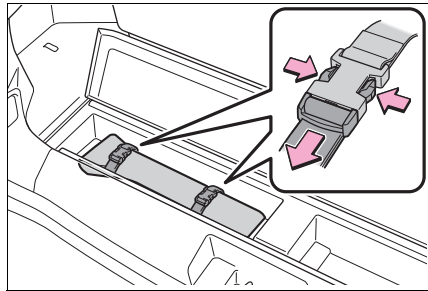

Taking out the spare tire

1 Assemble the jack handle extension as shown.

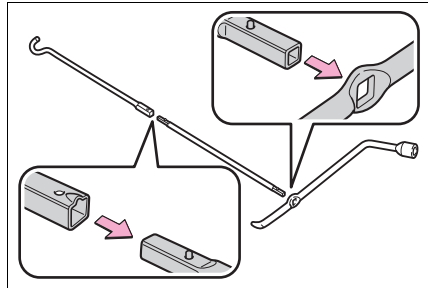

2 Remove the cover.

To protect the bodywork, place a rag between the screwdriver and the vehicle body as shown in the illustration.

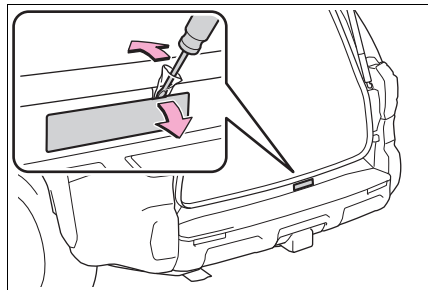

3 Insert the end of the jack handle extension into the

lowering screw and turn it counterclockwise.

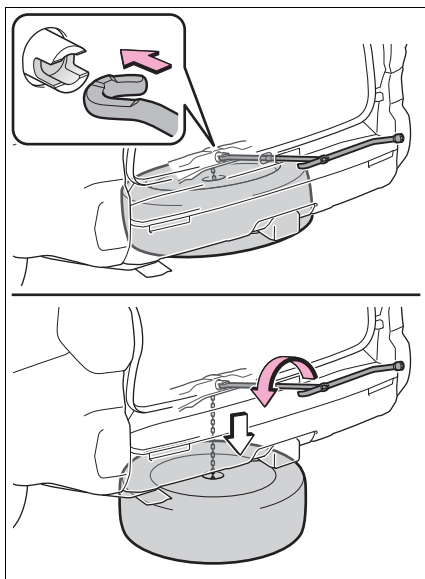

- 4 After the tire is lowered completely to the ground, remove the holding bracket.

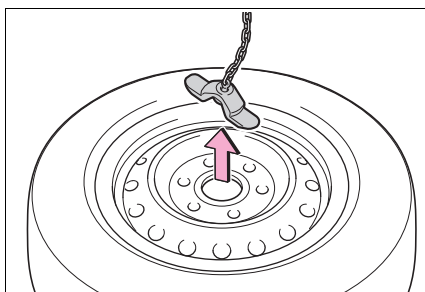

Replacing a flat tire

- 1 Chock the tires.

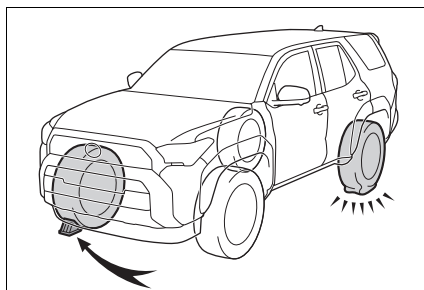

Tire	Wheel chock positions
Front left-hand side	Behind the rear right-hand side tire
Front right-hand side	Behind the rear left-hand side tire
Rear left-hand side	In front of the front right-hand side tire
Rear right-hand side	In front of the front left-hand side tire

- 2 Slightly loosen the wheel nuts (one turn).

Vehicles with wheel locks:
Use the wheel lock key to loosen the wheel lock.

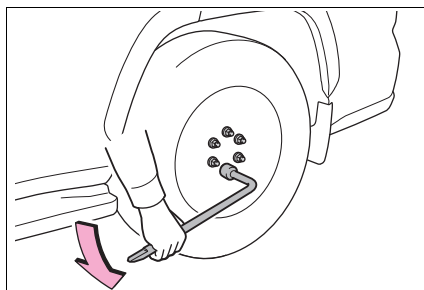

- 3 Assemble the jack handle extension as shown.

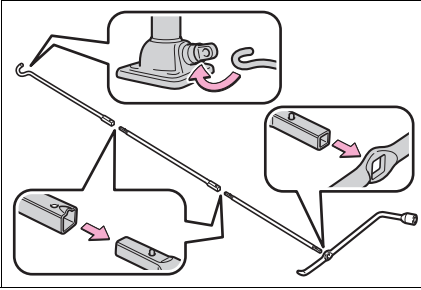

- 4 Position the jack at the correct jack point as shown.

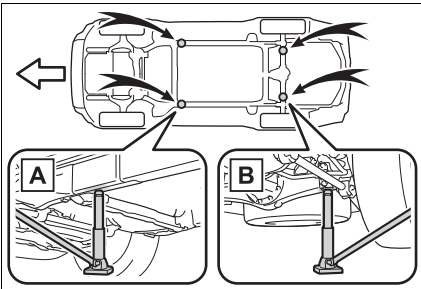

A Front

B Rear

Make sure the jack is positioned on a level and solid place.

- 5 Raise the vehicle until the tire is slightly raised off the ground.

When positioning the jack under the rear axle housing, make sure the groove on the top of the jack fits

with the rear axle housing.

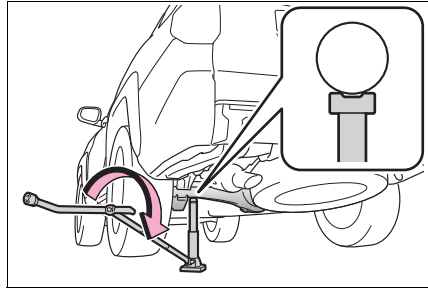

- 6 Remove all the wheel nuts and the tire.

When resting the tire on the ground, place the tire so that the wheel design faces up to avoid scratching the wheel surface.

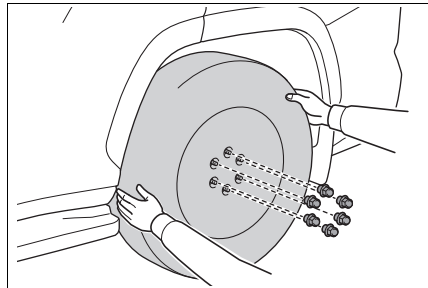

! WARNING

■ Replacing a flat tire

- Observe the following precautions.

Failure to do so may result in serious injury:

- Lower the spare tire completely to the ground before removing it from under the vehicle.
- Do not try to remove the wheel ornament by hand. Take due care in handling the ornament to avoid unexpected personal injury.

⚠ WARNING

- Do not touch the disc wheels or the area around the brakes immediately after the vehicle has been driven. After the vehicle has been driven the disc wheels and the area around the brakes will be extremely hot. Touching these areas with hands, feet or other body parts while changing a tire, etc., may result in burns.

● Failure to follow these precautions could cause the wheel nuts to loosen and the tire to fall off, resulting in death or serious injury.

- Never use oil or grease on the wheel bolts or wheel nuts. Oil and grease may cause the wheel nuts to be excessively tightened, leading to bolt or disc wheel damage. Remove any oil or grease that has adhered when installing the wheel nuts.
- After replacing a tire, check the tightening torque as soon as possible.

Steel wheel: 154 ft•lbf (209 N•m, 21.3 kgf•m)

Aluminum wheel: 97 ft•lbf (131 N•m, 13.4 kgf•m)

- When installing a tire, only use wheel nuts that have been specifically designed for that wheel.
- Retighten the wheel nuts within 100 miles (160 km) of driving.
- If there are any cracks or deformations in the bolt screws, nut threads or bolt holes of the wheel, have the vehicle inspected by your Toyota dealer.

- Do not attach a heavily damaged wheel ornament, as it may fly off the wheel while the vehicle is moving.
- When installing the wheel nuts, be sure to install them with the tapered ends facing inward.

■ Replacing a flat tire for vehicles with power back door

In cases such as when replacing tires, make sure to cancel the power back door system. (→P.144) Failure to do so may cause the back door to operate unintentionally if the power back door switch is accidentally touched, resulting in hands and fingers being caught and injured.

Installing the spare tire

- 1 Remove any dirt or foreign matter from the wheel contact surface.

If foreign matter is on the wheel contact surface, the wheel nuts may loosen while the vehicle is in motion, causing the tire to come off.

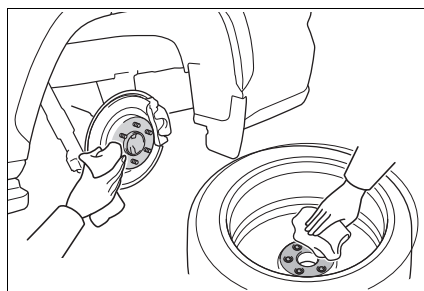

- 2 Install the spare tire and loosely tighten each wheel nut by hand by approximately the same amount.

When replacing an aluminum wheel with a steel wheel (including a compact spare tire), tighten the wheel

nuts until the tapered portion **A** comes into loose contact with the disc wheel seat **B**.

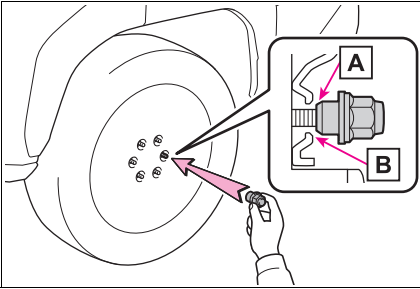

When replacing an aluminum wheel with a spare aluminum wheel, tighten the nuts until the washer of the nut **A** comes into loose contact with the disc wheel **B**.

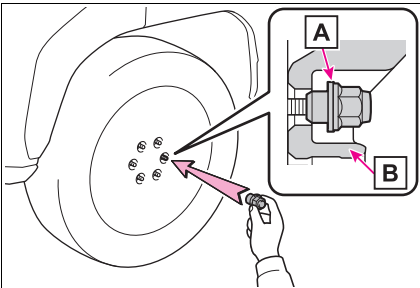

3 Lower the vehicle.

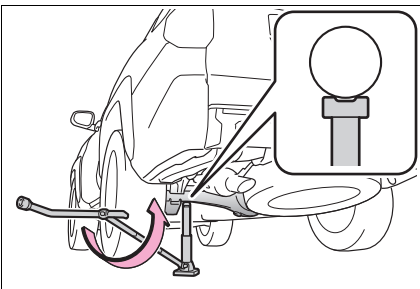

4 Securely tighten the wheel nuts two or three times in the order shown in the illustration using a wheel nut wrench.

Vehicles with wheel locks:

Tighten the wheel lock using the wheel lock key after tightening the other wheel nuts.

Tightening torque:

Steel wheel: 154 ft•lbf (209 N•m, 21.3 kgf•m)

Aluminum wheel: 97 ft•lbf (131 N•m, 13.4 kgf•m)

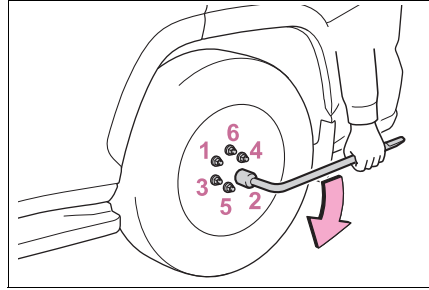

Stowing the flat tire, jack and all tools

- 1 Remove the center wheel ornament by pushing from the reverse side.
- 2 Lay down the tire with the valve stem facing up and install the holding bracket. Turn the jack handle extension clockwise to take up slack in the chain.

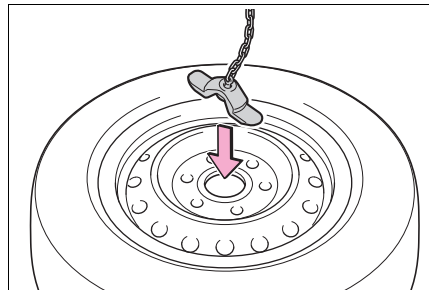

- 3 Check to ensure the holding bracket is centered in the wheel hub.

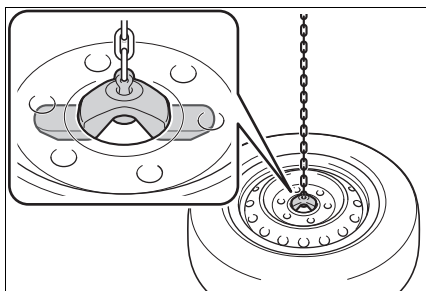

- 4 While raising, secure the tire, taking care that the tire goes straight up without catching on any surrounding parts, to prevent it from flying forward during a collision or sudden braking.

Tightening torque:

34.7 ft•lbf (46.6 N•m, 4.8 kgf•m)

- 5 Confirm it is not loose after tightening:

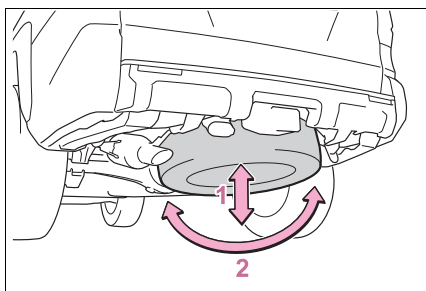

- 1 Push and pull the tire
- 2 Try rotating

Visually check to ensure tire is not hung on surrounding parts.

If looseness or misassembly exists, repeat step 2 and step 4.

- 6 Repeat step 5, any time the tire is lowered or disturbed.

- 7 Stow the tools and jack securely.

■ The compact spare tire (Vehicles with a compact spare tire)

- The compact spare tire is identified by the "TEMPORARY USE ONLY" marking on the disc wheel and/or tire sidewall. Use the compact spare tire temporarily, and only in an emergency.
- Make sure to check the tire inflation pressure of the compact spare tire. (→P.622)

■ When using the compact spare tire (Vehicles with a compact spare tire)

As the compact spare tire is not equipped with the tire pressure warning valve and transmitter, low inflation pressure of the spare tire will not be indicated by the tire pressure warning system. Also, if you replace the compact spare tire after the tire pressure warning light comes on, the light remains on.

■ When the compact spare tire is equipped (Vehicles with a compact spare tire)

When driving with the compact spare tire installed, the vehicle height will be different than when driving with standard tires.

■ If you have a flat rear tire on a road covered with snow or ice (Vehicles with a compact spare tire)

Install the compact spare tire on one of the front wheels of the vehicle. Perform the following steps and fit tire chains to the rear tires:

- 1 Replace a front tire with the compact spare tire.
- 2 Replace the flat rear tire with the tire removed from the front of the vehicle.
- 3 Fit tire chains to the rear tires.



WARNING

■ **When using the compact spare tire (Vehicles with a compact spare tire)**

- Remember that the compact spare tire provided is specifically designed for use with your vehicle. Do not use your compact spare tire on another vehicle.
- Do not use more than one compact spare tires simultaneously.
- Replace the compact spare tire with a standard tire as soon as possible.
- Avoid sudden acceleration, abrupt steering, sudden braking and shifting operations that cause sudden engine braking.

■ **When the compact spare tire is attached (Vehicles with a compact spare tire)**

The vehicle speed may not be correctly detected, and the following systems may not operate correctly:

- ABS & Brake assist
- VSC
- TRAC
- PCS (Pre-Collision System)
- AHB (Automatic High Beam)
- LTA (Lane Tracing Assist)
- LDA (Lane Departure Alert)
- Dynamic radar cruise control
- Cruise control
- EPS
- Trailer Sway Control
- Tire pressure warning system

- Panoramic view monitor (if equipped)
- Multi-terrain Monitor (if equipped)
- Toyota parking assist monitor (if equipped)
- PKSB (Parking Support Brake) (if equipped)
- Navigation system (if equipped)

Also, not only can the following system not be utilized fully, but it may even negatively affect the drive-train components:

- 4WD system (if equipped)

■ **Speed limit when using the compact spare tire (Vehicles with a compact spare tire)**

Do not drive at speeds in excess of 50 mph (80 km/h) when a compact spare tire is installed on the vehicle.

The compact spare tire is not designed for driving at high speeds. Failure to observe this precaution may lead to an accident causing death or serious injury.

■ **Stowing the flat tire**

- Failure to follow steps listed under stowing the tire may result in damage to the spare tire carrier and loss of the tire, which could result in serious injury or death.
- Never use an impact wrench to turn the spare tire clamp bolt. Failure to follow this precaution could cause the tire to fall off while driving, resulting in death or serious injury.

**WARNING****■ After using the tools and jack**

Before driving, make sure all the tools and jack are securely in place in their storage location to reduce the possibility of personal injury during a collision or sudden braking.

**NOTICE****■ Be careful when driving over bumps with the compact spare tire installed on the vehicle (Vehicles with a compact spare tire)**

The vehicle becomes lower when driving with the compact spare tire compared to when driving with standard tires. Be careful when driving over uneven road surfaces.

■ Do not drive the vehicle with a flat tire

Do not continue driving with a flat tire.

Driving even a short distance with a flat tire can damage the tire and the wheel beyond repair.

■ When stowing the flat tire

Ensure that there is no object caught between the tire and the vehicle underbody.

■ When replacing the tires

When removing or fitting the wheels, tires or the tire pressure warning valve and transmitter, contact your Toyota dealer as the tire pressure warning valve and transmitter may be damaged if not handled correctly.

■ To avoid damage to the tire pressure warning valves and transmitters

When a tire is repaired with liquid sealants, the tire pressure warning valve and transmitter may not operate properly. If a liquid sealant is used, contact your Toyota dealer or other qualified service shop as soon as possible. Make sure to replace the tire pressure warning valve and transmitter when replacing the tire. (→P.544)

If the engine will not start

If the engine will not start even though correct starting procedures are being followed (→P.218), consider each of the following points:

The engine will not start even though the starter motor operates normally.

One of the following may be the cause of the problem:

- There may not be sufficient fuel in the vehicle's tank. Refuel the vehicle.
- The engine may be flooded. Try to restart the engine again following correct starting procedures. (→P.218)
- There may be a malfunction in the engine immobilizer system. (→P.70)

The starter motor turns over slowly, the interior lights and headlights are dim, or the horn does not sound or sounds at a low volume.

One of the following may be the cause of the problem:

- The battery may be discharged. (→P.608)

- The battery terminal connections may be loose or corroded. (→P.535)

The starter motor does not turn over

The engine starting system may be malfunctioning due to an electrical problem such as electronic key battery depletion or a blown fuse. However, an interim measure is available to start the engine. (→P.604)

The starter motor does not turn over, the interior lights and headlights do not turn on, or the horn does not sound.

One of the following may be the cause of the problem:

- The battery may be discharged. (→P.608)
- One or both of the battery terminals may be disconnected. (→P.535)

Contact your Toyota dealer if the problem cannot be repaired, or if repair procedures are unknown.

Starting the engine in an emergency

When the engine does not start, the following steps can be used as an interim measure to start the engine if the engine switch is

functioning normally.

Do not use this starting procedure except in cases of emergency.

- 1 Pull the parking brake switch to check that the parking brake is set. (→P.227)

Parking brake indicator will come on.

- 2 Shift the shift lever to P.
- 3 Turn the engine switch to ACC*^{1, 2}.
- 4 Press and hold the engine switch for about 15 seconds while depressing the brake pedal firmly.

Even if the engine can be started using the above steps, the system may be malfunctioning. Have the vehicle inspected by your Toyota dealer.

*1: ACC mode can be enabled/disabled on the customize menu. (→P.646)

*2: When ACC is disabled, turn the engine switch to ON then OFF, and perform the following step within 5 seconds.

If you lose your keys

New genuine keys can be made by your Toyota dealer using other key and the key number stamped on your key number plate.

Keep the plate in a safe place such as your wallet, not in the vehicle.



NOTICE

■ When an electronic key is lost

If the electronic key remains lost, the risk of vehicle theft increases significantly. Visit your Toyota dealer immediately with all remaining electronic keys that were provided with your vehicle.

If the electronic key does not operate properly

If communication between the electronic key and vehicle is interrupted (→P.147) or the electronic key cannot be used because the battery is depleted, the smart key system and wireless remote control cannot be used. In such cases, the doors can be opened and the engine can be started by following the procedure below.

- **When the electronic key does not work properly**
 - Make sure that the smart key system has not been deactivated in the customization setting. If it is off, turn the function on. (Customizable features: →P.637)
 - Check if battery-saving mode is set. If it is set, cancel the function. (→P.147)
 - The electronic key function may be suspended. (→P.147)

 NOTICE

■ **In case of a smart key system malfunction or other key-related problems**

Take your vehicle with all the electronic keys provided with your vehicle to your Toyota dealer.

Locking and unlocking the doors

Use the mechanical key

(→P.116) in order to perform the following operations:

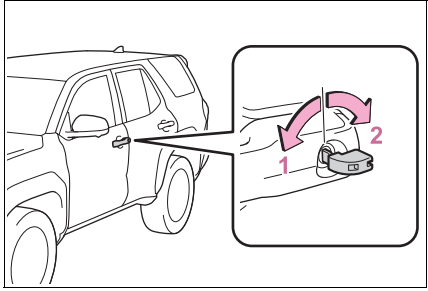

- 1 Locks all the doors
- 2 Unlocks all the doors

Turning the key unlocks the driver's door. Turning the key again unlocks the other doors.

■ **Key linked functions**

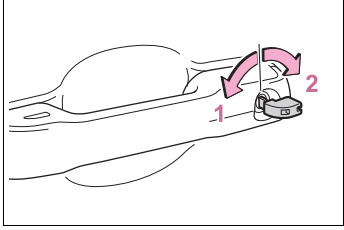

- 1 Closes the windows and the moon roof*1. (turn and hold)*2
- 2 Opens the windows and the moon roof*1. (turn and hold)*2

*1: If equipped
 *2: These settings must be customized at your Toyota dealer.

⚠ WARNING**■ When using the mechanical key and operating the power windows and the moon roof (if equipped)**

Operate the power window or the moon roof after checking to make sure that there is no possibility of any passenger having any of their body parts caught in the window or the moon roof.

Also, do not allow children to operate the mechanical key. It is possible for children and other passengers to get caught in the power window or the moon roof.

Starting the engine

- 1** Ensure that the shift lever is in P and depress the brake pedal.
- 2** Touch the area behind the buttons on of the electronic key to the engine switch.

When the electronic key is detected, a buzzer sounds and the engine switch will turn to ON.

When the smart key system is deactivated in customization setting and ACC customization is in on, the engine switch will turn to ACC.

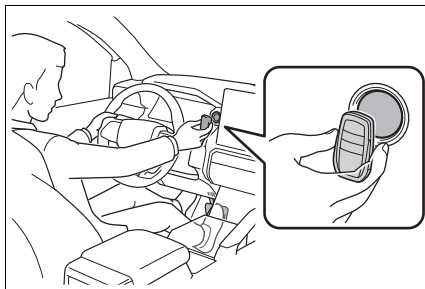

- 3** Firmly depress the brake pedal and check that 

and a message is shown on the multi-information display.

- 4** Press the engine switch shortly and firmly.

In the event that the engine still cannot be started, contact your Toyota dealer.

■ Stopping the engine

Shift the shift lever to P, set the parking brake, shift the shift lever to P and press the engine switch as you normally do when stopping the engine.

■ Electronic key battery

As the above procedure is a temporary measure, it is recommended that the electronic key battery be replaced immediately when the battery is depleted. (→P.558)

■ Alarm

Using the mechanical key to lock the doors will not set the alarm system. If a door is unlocked using the mechanical key when the alarm system is set, the alarm may be triggered. (→P.71)

■ Changing engine switch modes

Release the brake pedal and press the engine switch in step **3** above. The engine does not start and modes will be changed each time the switch is pressed. (→P.220)

If the vehicle battery is discharged

The following procedures may be used to start the engine if the vehicle's battery is discharged. You can also call your Toyota dealer or a qualified repair shop.

Restarting the engine

If you have a set of jumper (or booster) cables and a second vehicle with a battery, you can jump start your vehicle by fol-

lowing the steps below.

- 1 Confirm that the electronic key is being carried.

When connecting the jumper (or booster) cables, depending on the situation, the alarm may activate and doors locked. (→P.72)

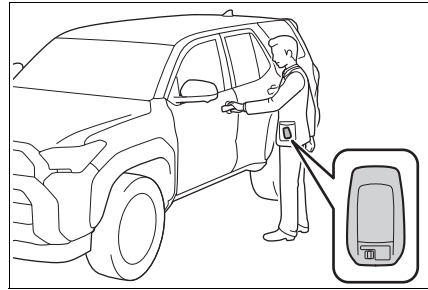

- 2 Open the hood (→P.528)

- 3 Connect a positive jumper cable clamp to **A** on your vehicle and connect the clamp on the other end of the positive cable to **B** on the second vehicle. Then, connect a negative cable clamp to **C** on the second vehicle and connect the clamp at the other end of the negative cable to **D**.

Use jumper cables that can reach the specified terminals and connecting point.

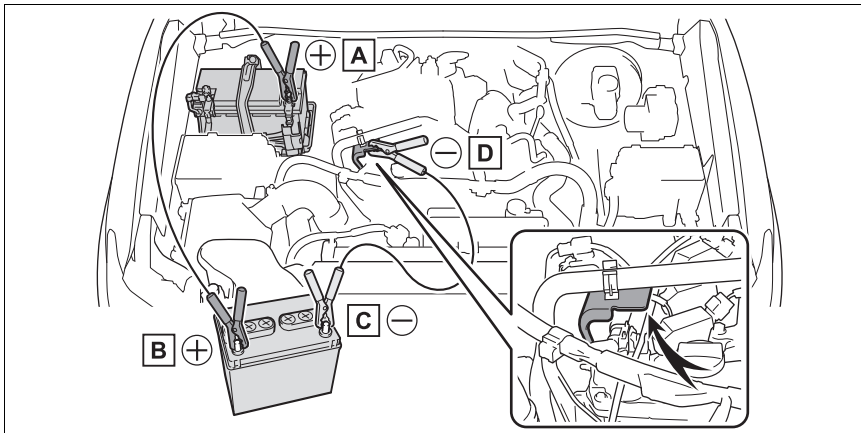

A Positive (+) battery terminal (your vehicle)

- B** Positive (+) battery terminal (second vehicle)
- C** Negative (-) battery terminal (second vehicle)
- D** Metallic point shown in the illustration

- 4 Start the engine of the second vehicle. Increase the engine speed slightly and maintain at that level for approximately 5 minutes to recharge the battery of your vehicle.
- 5 Open and close any of the doors of your vehicle with the engine switch OFF.
- 6 Maintain the engine speed of the second vehicle and start the engine of your vehicle by turning the engine switch to ON.
- 7 Once the vehicle's engine has started, remove the jumper cables in the exact reverse order from which they were connected.

■ Starting the engine when the battery is discharged

The engine cannot be started by push-starting.

■ To prevent battery discharge

- Turn off the headlights and the audio system while the engine is off.
- Turn off any unnecessary electrical components when the vehicle is running at a low speed for an extended period, such as in heavy traffic.
- When ACC customization is in off, power is still provided to the multimedia system even though the

engine switch is off. To turn off the multimedia system, use the multimedia system power switch. For details, refer to the "MULTIMEDIA OWNER'S MANUAL".

■ When the battery is removed or discharged

- Information stored in the ECU is cleared. When the battery is depleted, have the vehicle inspected at your Toyota dealer.
- Some systems may require initialization. (→P.653)

■ When removing the battery terminals

When the battery terminals are removed, the information stored in the ECU is cleared. Before removing the battery terminals, contact your Toyota dealer.

■ Charging the battery

The electricity stored in the battery will discharge gradually even when the vehicle is not in use, due to natural discharge and the draining effects of certain electrical appliances. If the vehicle is left for a long time, the battery may discharge, and the engine may be unable to start. (The battery recharges automatically during driving.)

■ When recharging or replacing the battery

- In some cases, it may not be possible to unlock the doors using the smart key system when the battery is discharged. Use the wireless remote control or the mechanical key to lock or unlock the doors.
- The engine may not start on the first attempt after the battery recharged but will start normally

after the second attempt. This is not a malfunction.

- The engine switch mode is memorized by the vehicle. When the battery is reconnected, the system will return to the mode it was in before the battery was discharged. Before disconnecting the battery, turn the engine switch off. If you are unsure what mode the engine switch was in before the battery discharged, be especially careful when reconnecting the battery.
- Vehicles with a Stop & Start system: The Stop & Start system may not automatically stop the engine for up to an hour.

■ When replacing the battery

- Vehicles with a Stop & Start system: Use a genuine battery specifically designed for use with the Stop & Start system or a battery with equivalent specifications to a genuine battery. If an unsupported battery is used, Stop & Start system functions may be restricted to protect the battery. Also, battery performance may decrease and the engine may not be able to restart. Contact your Toyota dealer for details.
- Use a battery that conforms to European regulations.

Type A: Use a battery that the case size is same as the previous one (LN3), 20 hours rate capacity (20HR) is equivalent (70Ah) or greater, and performance rating (CCA) is equivalent (592A) or greater.

Type B: Use a battery that the case size is same as the previous one (LN4), 20 hours rate capacity (20HR) is equivalent (80Ah) or greater, and performance rating (CCA) is equivalent (685A) or greater.

Type C: Use a battery that the case size is same as the previous one (LN4), 20 hours rate capacity (20HR) is equivalent (75Ah) or greater, and performance rating (CCA) is equivalent (776A) or greater.

- If the sizes differ, the battery cannot be properly secured.
- If the 20 hour rate capacity is low, even if the time period where the vehicle is not used is a short time, the battery may discharge and engine may not be able to start.

For details, consult your Toyota dealer.

WARNING

■ When removing the battery terminals

Always remove the negative (-) terminal first. If the positive (+) terminal contacts any metal in the surrounding area when the positive (+) terminal is removed, a spark may occur, leading to a fire in addition to electrical shocks and death or serious injury.

■ Avoiding battery fires or explosions

Observe the following precautions to prevent accidentally igniting the flammable gas that may be emitted from the battery:

- Make sure each jumper cable is connected to the correct terminal and that it is not unintentionally in contact with any other than the intended terminal.
- Do not allow the other end of the jumper cable connected to the “+” terminal to come into contact with any other parts or metal surfaces in the area, such as brackets or unpainted metal.

 **WARNING**

- Do not allow the + and - clamps of the jumper cables to come into contact with each other.
- Do not smoke, use matches, cigarette lighters or allow open flame near the battery.

■ battery precautions

The battery contains poisonous and corrosive acidic electrolyte, while related parts contain lead and lead compounds. Observe the following precautions when handling the battery:

- When working with the battery, always wear safety glasses and take care not to allow any battery fluids (acid) to come into contact with skin, clothing or the vehicle body.
- Do not lean over the battery.
- In the event that battery fluid comes into contact with the skin or eyes, immediately wash the affected area with water and seek medical attention. Place a wet sponge or cloth over the affected area until medical attention can be received.
- Always wash your hands after handling the battery support, terminals, and other battery-related parts.
- Do not allow children near the battery.

■ When replacing the battery

- When the vent plug and indicator are close to the hold down clamp, the battery fluid (sulfuric acid) may leak.
- For information regarding battery replacement, contact your Toyota dealer.

 **NOTICE****■ When handling jumper cables**

When connecting the jumper cables, ensure that they do not become entangled in the cooling fan.

■ When connecting jumper cables

Make sure to connect jumper cables to the specified terminals and connecting point. Failure to do so may adversely affect the electronic devices or damage to them.

If your vehicle overheats

The following may indicate that your vehicle is overheating.

- The needle of the engine coolant temperature gauge (→P.81, 85) enters the red zone or a loss of engine power is experienced. (For example, the vehicle speed does not increase.)
- “Engine Coolant Temp High Stop in a Safe Place See Owner’s Manual” is shown on the multi-information display.
- Steam comes out from under the hood.

Correction procedures

- 1 Stop the vehicle in a safe place and turn off the air conditioning system, and then stop the engine.
- 2 If you see steam: Carefully lift the hood after the steam subsides. If you do not see steam: Carefully lift the hood.
- 3 After the engine has cooled down sufficiently, inspect the hoses, engine radiator core (radiator) for any leaks.

If a large amount of coolant leaks, immediately contact your Toyota dealer.

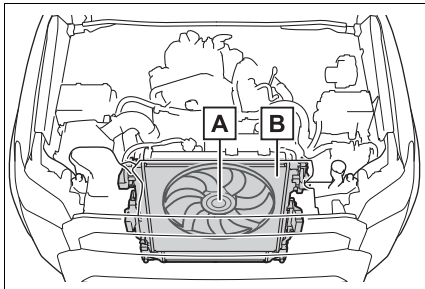

A Cooling fan

B Radiator

- 4 The coolant level is satisfactory if it is between the “F” and “L” lines on the reservoir.

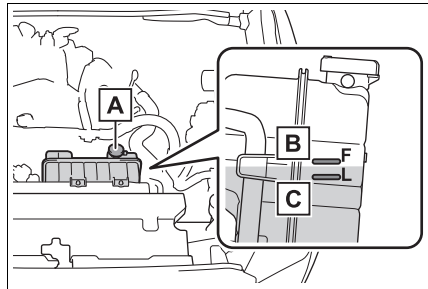

A Reservoir

B “F” line

C “L” line

- 5 Add coolant if necessary.

Water can be used in an emer-

gency if coolant is unavailable.

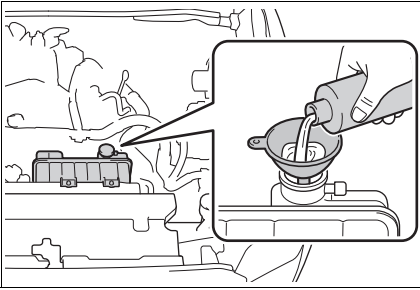

- 6** Start the engine to check that the radiator cooling fan operates and to check for coolant leaks from the radiator or hoses.

The fan operates when the air conditioning system is turned on immediately after a cold start. Confirm that the fan is operating by checking the fan sound and air flow. If it is difficult to check these, turn the air conditioning system on and off repeatedly. (The fan may not operate in freezing temperatures.)

- 7** If the fan is not operating:
Stop the engine immediately and contact your Toyota dealer.
If the fan is operating:
Have the vehicle inspected at the nearest Toyota dealer.
- 8** Check if “Engine Coolant Temp High Stop in a Safe Place See Owner’s Manual” is shown on the multi-information display.

If the message does not disappear:
Stop the engine and contact your Toyota dealer.

If the message is not displayed:
Have the vehicle inspected at the nearest Toyota dealer.

! WARNING

When inspecting under the hood of your vehicle

Observe the following precautions. Failure to do so may result in serious injury such as burns.

- If steam is seen coming from under the hood, do not open the hood until the steam has subsided. The engine compartment may be very hot.
- Keep hands and clothing (especially a tie, a scarf or a muffler) away from the fan and belts. Failure to do so may cause the hands or clothing to be caught, resulting in serious injury.
- Do not loosen the coolant reservoir caps, while the engine and radiator are hot. High temperature steam or coolant could spray out.

! NOTICE

When adding coolant

Add coolant slowly after the engine has cooled down sufficiently. Adding cool coolant to a hot engine too quickly can cause damage to the engine.

To prevent damage to the cooling system

Observe the following precautions:

- Avoid contaminating the coolant with foreign matter (such as sand or dust, etc.).
- Do not use any coolant additive.

If the vehicle becomes stuck

Carry out the following procedures if the tires spin or the vehicle becomes stuck in mud, dirt or snow:

Recovering procedure

- 1 Stop the engine. Set the parking brake and shift the shift lever to P.
- Do not press the shift release button after shifting the shift position to P.
- 2 Remove the mud, snow or sand from around the rear wheels.
 - 3 Place wood, stones or some other material under the rear wheels to help provide traction.
 - 4 Restart the engine.
 - 5 Shift the shift lever to D or R and release the parking brake. Then, while exercising caution, depress the accelerator pedal.

■ When it is difficult to free the vehicle

Try the followings.

- Turn off the TRAC (→P.432)
- Using the rear differential lock* (→P.421)
- Switching the front-wheel drive control switch* (→P.414, 417)

- Using Crawl Control* (→P.422)
 - Using Multi-terrain Select* (→P.425)
- *: If equipped

⚠ WARNING

■ When attempting to free a stuck vehicle

If you choose to push the vehicle back and forth to free it, make sure the surrounding area is clear to avoid striking other vehicles, objects or people. The vehicle may also lunge forward or lunge back suddenly as it becomes free. Use extreme caution.

■ When shifting the shift lever

Be careful not to shift the shift lever with the accelerator pedal depressed. This may lead to unexpected rapid acceleration of the vehicle that may cause an accident resulting in death or serious injury.

⚠ NOTICE

■ To avoid damaging the transmission and other components

- Avoid spinning the rear wheels and depressing the accelerator pedal more than necessary.
- If the vehicle remains stuck even after these procedures are performed, the vehicle may require towing to be freed.

Vehicle specifications

8

8-1. Specifications

Maintenance data (fuel, oil level, etc.)..... 616

Fuel information 624

Tire information 626

8-2. Customization

Customizable features 637

8-3. Initialization

Items to initialize 653

Maintenance data (fuel, oil level, etc.)

Dimensions and weight

Overall length	194.9 in. (4950 mm)
Overall width	77.9 in. (1980 mm)
Overall height* ¹	72.8 in. (1850 mm) ^{*2}
	73.2 in. (1860 mm) ^{*3}
	73.6 in. (1870 mm) ^{*4}
Wheelbase	112.2 in. (2850 mm)
Front and rear tread	65.6 in. (1667 mm)
Vehicle capacity weight (Occupants + luggage)	895 lb. (405 kg) ^{*5}
	1160 lb. (525 kg) ^{*6}

- *1: Unladen vehicles
- *2: 245/70R17 tires
- *3: 265/55R20 tires
- *4: 265/70R18 tires
- *5: Vehicles without third seats
- *6: Vehicles with third seats

Seating capacity

Seating capacity	Vehicle without third seats	Vehicle with third seats
	5 (Front 2, Rear 3)	7 (Front 2, Rear 5)

Vehicle identification

■ **Vehicle identification number**

The vehicle identification number (VIN) is the legal identifier for your vehicle. This is the primary identification number for your Toyota. It is used in regis-

tering the ownership of your vehicle.

This number is stamped on the front right frame.

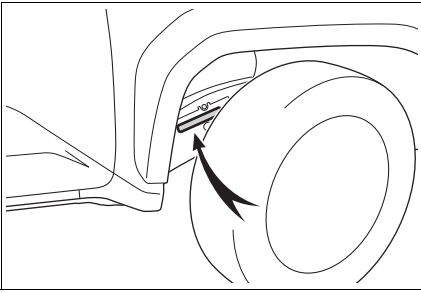

This number is also on the top left of the instrument panel.

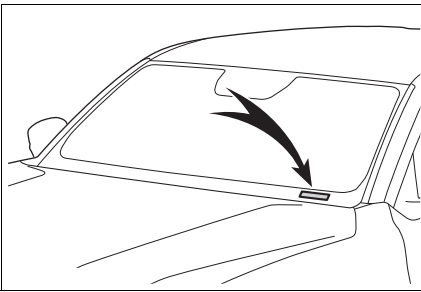

This number is also on the Certi-

fication Label.

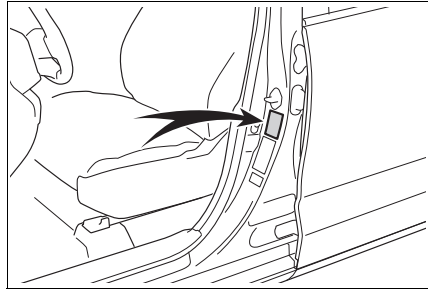

The engine number is stamped on the engine block as shown.

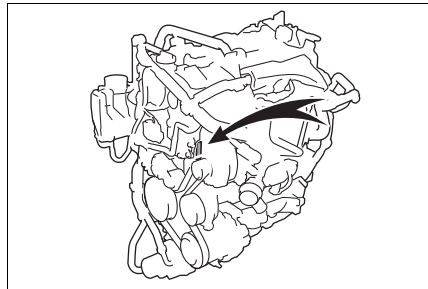

Engine

Model	T24A-FTS
Type	4-cylinder in line, 4-cycle, gasoline (with turbocharger)
Bore and stroke	3.44 × 3.91 in. (87.5 × 99.5 mm)
Displacement	146.0 cu.in. (2393 cm ³)
Valve clearance	Automatic adjustment
Drive belt tension	Automatic adjustment

Fuel

Fuel type	Unleaded gasoline only
-----------	------------------------

Octane rating	87 (Research Octane Number 91) or higher
Fuel tank capacity (Reference)	19.0 gal. (72.0 L, 15.8 Imp.gal.)

Lubrication system

■ **Oil capacity (Drain and refill [Reference*])**

With filter	5.9 qt. (5.6 L, 4.9 Imp. qt.)
Without filter	5.6 qt. (5.3 L, 4.7 Imp. qt.)

*: The engine oil capacity is a reference quantity to be used when changing the engine oil. When actually adding the engine oil, make sure that the oil level is between the low level mark and refill upper limit mark (→P.532). Warm up and turn off the engine, wait about 8 minutes, and check the oil level on the dipstick.

■ **Engine oil selection**

“Toyota Genuine Motor Oil” is used in your Toyota vehicle. Use Toyota approved “Toyota Genuine Motor Oil” or equivalent to satisfy the following grade and viscosity.

Oil grade:

ILSAC GF-6A multigrade engine oil

Recommended viscosity: SAE 0W-20

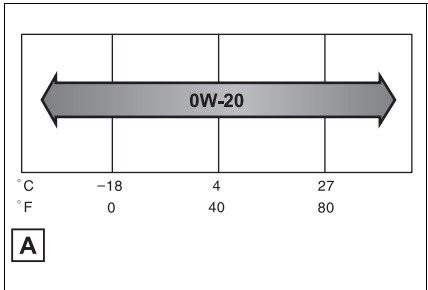

A Outside temperature

SAE 0W-20 is the best choice for good fuel economy and good starting in cold weather.

If SAE 0W-20 is not available, SAE 5W-20 oil may be used.

However, it must be replaced with SAE 0W-20 at the next oil change.

Oil viscosity (0W-20 is explained here as an example):

- The 0W in 0W-20 indicates the characteristic of the oil which allows cold startability. Oils with a lower value before the W allow for easier starting of the engine in cold weather.
- The 20 in 0W-20 indicates the viscosity characteristic of the oil when the oil is at high temperature.

How to read oil container label:

The International Lubricant Specification Advisory Commit-

tee (ILSAC) Certification Mark is added to some oil containers to help you select the oil you should use.



Cooling system

Capacity ^{*1}	12.7 qt. (12.0 L, 10.6 Imp.qt.) ^{*2} 12.8 qt. (12.1 L, 10.6 Imp.qt.) ^{*3}
Coolant type	Use either of the following: <ul style="list-style-type: none"> • “Toyota Super Long Life Coolant” • Similar high-quality ethylene glycol-based non-silicate, non-amine, non-nitrite, and non-borate coolant with long-life hybrid organic acid technology Do not use plain water alone.

^{*1}: The fluid capacity is a reference quantity.
If replacement is necessary, contact your Toyota dealer.

^{*2}: SR Package, SR5 Package and TRD Sport Package

^{*3}: TRD Off-Road Package and Limited Package

Ignition system (spark plug)

Make	NGK DILZKAR8E7H
Gap	0.027 in. (0.7 mm)

 **NOTICE**

 **Iridium-tipped spark plugs**
Use only iridium-tipped spark plugs. Do not adjust the spark plug gap.

Electrical system

Open voltage at 68°F (20°C):	12.3 V or higher (Turn the engine switch off and turn on the high beam headlights for 30 seconds.)
Charging rates Slow charge	5 A max.

Automatic transmission

Fluid capacity*	12.2 qt. (11.5 L, 10.1 Imp.qt.)
Fluid type	Toyota Genuine ATF WS

*: The fluid capacity is a reference quantity.
If replacement is necessary, contact your Toyota dealer.



NOTICE

■ Automatic transmission fluid type

Using transmission fluid other than the above type may cause abnormal noise or vibration, or damage the transmission of your vehicle.

Transfer (4WD models)

Oil capacity	<ul style="list-style-type: none"> ▶ Vehicles with part-time 4WD 1.2 qt. (1.1 L, 1.0 Imp.qt.) ▶ Vehicles with full-time 4WD 1.5 qt. (1.4 L, 1.2 Imp.qt.)
Oil type and viscosity	Toyota Genuine Transfer gear oil LF or equivalent

Your Toyota vehicle is filled with “Toyota Genuine Transfer Gear oil LF” at the factory.

Use Toyota approved “Toyota Genuine Transfer Gear oil LF” or an equivalent of matching quality to satisfy the above specification.

Please contact your Toyota dealer for further details.

Differential

Oil capacity	Front (4WD models)	<ul style="list-style-type: none"> ▶ Vehicles with part-time 4WD 1.4 qt. (1.3 L, 1.1 Imp.qt.) ▶ Vehicles with full-time 4WD 1.3 qt. (1.2 L, 1.1 Imp.qt.)
	Rear	5.9 qt. (5.6 L, 4.9 Imp.qt.)
Oil type and viscosity		Toyota Genuine Differential Gear Oil LT 75W-85 GL-5 or equivalent

Your Toyota vehicle is filled with “Toyota Genuine Differential Gear Oil” at the factory.

Use Toyota approved “Toyota Genuine Differential Gear Oil” or an equivalent oil of matching quality to satisfy the above specification. Please contact your Toyota dealer for further details.

Brakes

Pedal clearance* ¹	3.7 in. (95 mm) Min.
Pedal free play	0.04 — 0.24 in. (1 — 6 mm)
Brake pad wear limit	0.04 in. (1 mm)
Parking brake indicator* ²	When pulling the parking brake switch for 1 to 2 seconds: comes on When pushing the parking brake switch for 1 to 2 seconds: turns off
Fluid type	<ul style="list-style-type: none"> • FMVSS No.116 DOT 3 or SAE J1703 • FMVSS No.116 DOT 4 or SAE J1704

*¹: Minimum pedal clearance when depressed with a force of 67 lbf (300 N, 31 kgf) while the engine is running.

*²: Make sure to confirm that the brake warning light (yellow) does not illuminate. (If the brake warning light illuminates, refer to P.576.)

Steering

Free play	Less than 1.2 in. (30 mm)
-----------	---------------------------

Tires and wheels

► 17-inch tires (type A)

Tire size	245/70R17 110T
Tire inflation pressure (Recommended cold tire inflation pressure)*	33 psi (230 kPa, 2.3 kgf/cm ² or bar)
Wheel size	17 × 7J, 17 × 7J (spare)
Wheel nut torque	97 ft•lbf (131 N•m, 13.4 kgf•m)

*: When vehicle is loaded: Add 4 psi (30 kPa, 0.3 kgf/cm² or bar) with rear tires only for 2WD vehicle to the recommended cold tire pressure.

► 17-inch tires (type B)

Tire size	245/70R17 110T, T175/90D18 111M (spare)
Tire inflation pressure (Recommended cold tire inflation pressure)*	33 psi (230 kPa, 2.3 kgf/cm ² or bar) 60 psi (420 kPa, 4.2 kgf/cm ² or bar) (spare)
Wheel size	17 × 7J, 18 × 4 1/2T (spare)
Wheel nut torque	Aluminum wheels: 97 ft•lbf (131 N•m, 13.4 kgf•m)

*: When vehicle is loaded: Add 4 psi (30 kPa, 0.3 kgf/cm² or bar) with rear tires only for 2WD vehicle to the recommended cold tire pressure.

► 18-inch tires (type A)

Tire size	245/70R18 110H
Tire inflation pressure (Recommended cold tire inflation pressure)	33 psi (230 kPa, 2.3 kgf/cm ² or bar)
Wheel size	18 × 7 1/2 J, 18 × 7 1/2 J (spare)
Wheel nut torque	97 ft•lbf (131 N•m, 13.4 kgf•m)

► 18-inch tires (type B)

Tire size	265/70R18 116T
Tire inflation pressure (Recommended cold tire inflation pressure)	33 psi (230 kPa, 2.3 kgf/cm ² or bar)
Wheel size	18 × 7 1/2 J, 18 × 7 1/2 J (spare)
Wheel nut torque	97 ft•lbf (131 N•m, 13.4 kgf•m)

► 20-inch tires (type A)

Tire size	265/55R20 113V
Tire inflation pressure (Recommended cold tire inflation pressure)	33 psi (230 kPa, 2.3 kgf/cm ² or bar)
Wheel size	20 × 8J, 20 × 8J (spare)
Wheel nut torque	97 ft•lbf (131 N•m, 13.4 kgf•m)

► 20-inch tires (type B)

Tire size	265/55R20 113V, 245/75R17 112S (spare)
Tire inflation pressure (Recommended cold tire inflation pressure)	33 psi (230 kPa, 2.3 kgf/cm ² or bar)
Wheel size	20 × 8J, 17 × 7J (spare)
Wheel nut torque	Steel wheels: 154 ft•lbf (209 N•m, 21.3 kgf•m) Aluminum wheels: 97 ft•lbf (131 N•m, 13.4 kgf•m)

Light bulbs

	Light bulbs	Bulb No.	W	Type
Exterior	Front turn signal/parking lights	7444NA	28/8	A

A: Wedge base bulbs (amber)

Fuel information

You must only use unleaded gasoline.

Select octane rating 87 (Research Octane Number 91) or higher. Use of unleaded gasoline with an octane rating lower than 87 may result in engine knocking. Persistent knocking can lead to engine damage.

At minimum, the gasoline you use should meet the specifications of ASTM D4814 in the U.S.A.

Gasoline quality

In very few cases, driveability problems may be caused by the brand of gasoline you are using. If driveability problems persist, try changing the brand of gasoline. If this does not correct the problem, consult your Toyota dealer.

Recommendation of the use of gasoline containing detergent additives

- Toyota recommends the use of gasoline that contains detergent additives to avoid build-up of engine deposits.
- All gasoline sold in the U.S.A. contains minimum detergent additives to clean and/or keep clean intake systems, per EPA's lowest additives concentration program.
- Toyota strongly recommends the use of Top Tier Detergent Gasoline. For more information on Top Tier Detergent Gasoline and a list of marketers, please go to the official website www.toptiergas.com.

Recommendation of the use of low emissions gasoline

Gasolines containing oxygenates such as ethers and ethanol, as well as reformulated gasolines, are available in some cities. These fuels are typically acceptable for use, providing they meet other fuel requirements.

Toyota recommends these fuels, since the formulations allow for reduced vehicle emissions.

Non-recommendation of the use of blended gasoline

- Use only gasoline containing up to 15% ethanol.
DO NOT use any flex-fuel or gasoline that could contain more than 15% ethanol, including from any pump labeled E30 (30% ethanol **A**), E50 (50% ethanol **B**), E85 (85% ethanol **C**) (which are only some examples of fuel containing more than 15% ethanol).

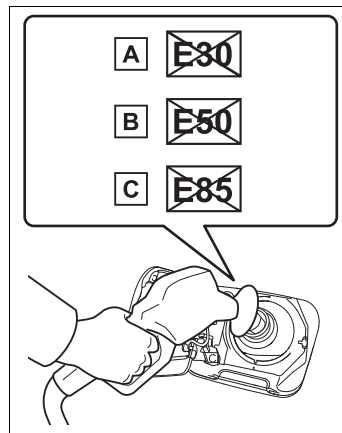

- If you use gasohol in your vehicle, be sure that it has an octane rating no lower than 87.
- Toyota does not recommend the use of gasoline containing methanol.

■ Non-recommendation of the use of gasoline containing MMT

Some gasoline contains an octane enhancing additive called MMT (Methylcyclopentadienyl Manganese Tricarbonyl).

Toyota does not recommend the use of gasoline that contains MMT. If fuel containing MMT is used, your emission control system may be adversely affected.

The malfunction indicator lamp on the instrument cluster may come on. If this happens, contact your Toyota dealer for service.

■ If your engine knocks

- Consult your Toyota dealer.
- You may occasionally notice light knocking for a short time while accelerating or driving uphill. This is normal and there is no need for concern.



NOTICE

■ Notice on fuel quality

- Do not use improper fuels. If improper fuels are used, the engine will be damaged.
- Do not use leaded gasoline. Leaded gasoline can cause damage to your vehicle's three-way catalytic converters causing the emission control system to malfunction.
- Do not use gasohol other than the type previously stated. Other gasohol may cause fuel system damage or vehicle performance problems.
- Using unleaded gasoline with an octane number or rating lower than the level previously stated may cause persistent heavy knocking. At worst, this may lead to engine damage and will void the vehicle warranty.

■ Fuel-related poor driveability

If poor driveability (poor hot starting, vaporization, engine knocking, etc.) is encountered after using a different type of fuel, discontinue the use of that type of fuel.

■ When refueling with gasohol

Take care not to spill gasohol. It can damage your vehicle's paint.

Tire information

Typical tire symbols

► Full-size tire

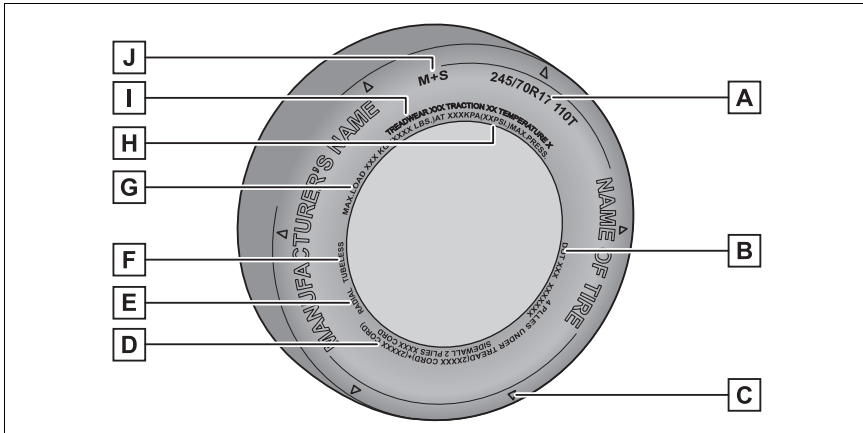

► Compact spare tire

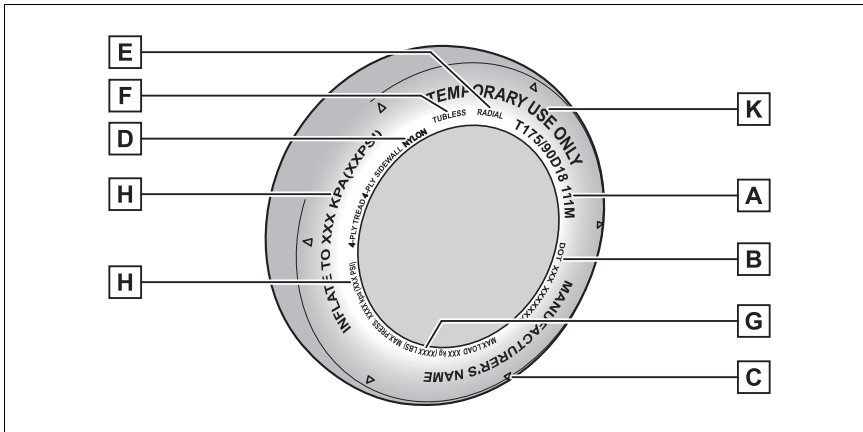

- A** Tire size (→P.628)
- B** DOT and Tire Identification Number (TIN) (→P.627)
- C** Location of treadwear indicators (→P.539)
- D** Tire ply composition and materials

Ply is layers of rubber-coated parallel cords. Cords are the strands which form the plies in a tire.

E Radial tires or bias-ply tires

A radial tire has “RADIAL” on the sidewall. A tire not marked “RADIAL” is a bias-ply tire.

F TUBELESS or TUBE TYPE

A tubeless tire does not have a tube and air is directly put into the tire. A tube type tire has a tube inside the tire and the tube maintains the air pressure.

G Load limit at maximum cold tire inflation pressure (→P.539)

H Maximum cold tire inflation pressure (→P.622)

This means the pressure to which a tire may be inflated.

I Uniform tire quality grading

For details, see “Uniform Tire Quality Grading” that follows.

J Summer tires or all season tires (→P.540)

An all season tire has “M+S” on the sidewall. A tire not marked “M+S” is a summer tire.

K “TEMPORARY USE ONLY”

A compact spare tire is identified by the phrase “TEMPORARY USE ONLY” molded on its sidewall. This tire is designed for temporary emergency use only.

Typical DOT and Tire Identification Number (TIN)

► Type A

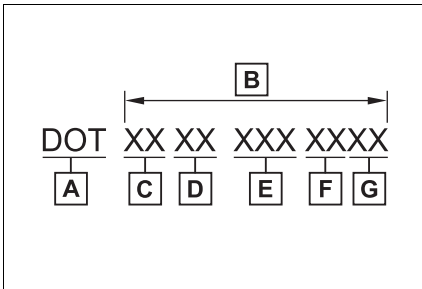

A DOT symbol*

B Tire Identification Number (TIN)

C Tire size code

D Manufacturer’s optional tire type code (3 or 4 letters)

E Tire manufacturer’s identification mark

F Manufacturing week

G Manufacturing year

*: The DOT symbol certifies that the tire conforms to applicable Federal Motor Vehicle Safety Standards.

► Type B

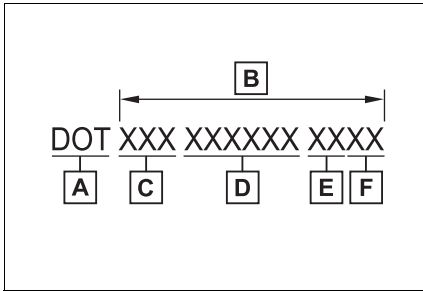

- A** DOT symbol*
- B** Tire Identification Number (TIN)
- C** Tire manufacturer's identification mark
- D** Manufacturer's code
- E** Manufacturing week
- F** Manufacturing year

*: The DOT symbol certifies that the tire conforms to applicable Federal Motor Vehicle Safety Standards.

Tire size

■ Typical tire size information

The illustration indicates typical tire size.

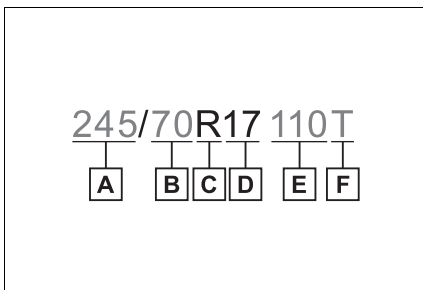

- A** Section width (millimeters)
- B** Aspect ratio (tire height to section width)
- C** Tire construction code (R = Radial, D = Diagonal)
- D** Wheel diameter (inches)
- E** Load index (2 digits or 3 digits)
- F** Speed symbol (alphabet with one letter)

■ Tire dimensions

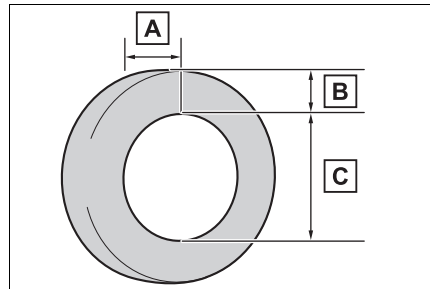

- A** Section width
- B** Tire height
- C** Wheel diameter

Tire section names

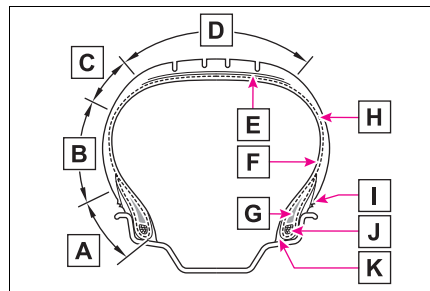

- A** Bead

- B** Sidewall
- C** Shoulder
- D** Tread
- E** Belt
- F** Inner liner
- G** Reinforcing rubber
- H** Carcass
- I** Rim lines
- J** Bead wires
- K** Chafer

Uniform Tire Quality Grading

This information has been prepared in accordance with regulations issued by the National Highway Traffic Safety Administration of the U.S. Department of Transportation.

It provides the purchasers and/or prospective purchasers of Toyota vehicles with information on uniform tire quality grading.

Your Toyota dealer will help answer any questions you may have as you read this information.

■ DOT quality grades

All passenger vehicle tires must conform to Federal Safety Requirements in addition to these grades. Quality grades can be found where applicable on the tire sidewall between

tread shoulder and maximum section width.

For example: Treadwear 200 Traction AA Temperature A

■ Treadwear

The treadwear grade is a comparative rating based on the wear rate of the tire when tested under controlled conditions on a specified government test course.

For example, a tire graded 150 would wear one and a half (1 - 1/2) times as well on the government course as a tire graded 100.

The relative performance of tires depends upon the actual conditions of their use. Performance may differ significantly from the norm due to variations in driving habits, service practices and differences in road characteristics and climate.

■ Traction AA, A, B, C

The traction grades, from highest to lowest, are AA, A, B and C, and they represent the tire's ability to stop on wet pavement as measured under controlled conditions on specified government test surfaces of asphalt and concrete.

A tire marked C may have poor traction performance.

Warning: The traction grade assigned to this tire is based on braking (straight ahead) traction tests and does not include cornering (turning) traction.

■ Temperature A, B, C

The temperature grades are A (the highest), B, and C, representing the tire's resistance to the generation of heat and its ability to dissipate heat when tested under controlled conditions on a specified indoor laboratory test wheel.

Sustained high temperature can cause the material of the tire to degenerate and reduce tire life, and excessive temperature can lead to sudden tire failure.

Grade C corresponds to a level of

performance which all passenger car tires must meet under the Federal Motor Vehicle Safety Standard No. 109.

Grades B and A represent higher levels of performance on the laboratory test wheel than the minimum required by law.

Warning: The temperature grades of a tire assume that it is properly inflated and not overloaded.

Excessive speed, underinflation, or excessive loading, either separately or in combination, can cause heat buildup and possible tire failure.

Glossary of tire terminology

Tire related term	Meaning
Cold tire inflation pressure	Tire pressure when the vehicle has been parked for three hours or more, or has not been driven more than 1 mile or 1.5 km under that condition
Maximum inflation pressure	The maximum cold inflated pressure to which a tire may be inflated, shown on the sidewall of the tire
Recommended inflation pressure	Cold tire inflation pressure recommended by a manufacturer
Accessory weight	The combined weight (in excess of those standard items which may be replaced) of automatic transmission, power steering, power brakes, power windows, power seats, radio and heater, to the extent that these items are available as factory-installed equipment (whether installed or not)

Tire related term	Meaning
Curb weight	The weight of a motor vehicle with standard equipment, including the maximum capacity of fuel, oil and coolant, and if so equipped, air conditioning and additional weight optional engine
Maximum loaded vehicle weight	The sum of: (a) Curb weight (b) Accessory weight (c) Vehicle capacity weight (d) Production options weight
Normal occupant weight	150 lb. (68 kg) times the number of occupants specified in the second column of Table 1* that follows
Occupant distribution	Distribution of occupants in a vehicle as specified in the third column of Table 1* below
Production options weight	The combined weight of installed regular production options weighing over 5 lb. (2.3 kg) in excess of the standard items which they replace, not previously considered in curb weight or accessory weight, including heavy duty brakes, ride levelers, roof rack, heavy duty battery, and special trim
Rim	A metal support for a tire or a tire and tube assembly upon which the tire beads are seated
Rim diameter (Wheel diameter)	Nominal diameter of the bead seat
Rim size designation	Rim diameter and width
Rim type designation	The industry manufacturer's designation for a rim by style or code
Rim width	Nominal distance between rim flanges
Vehicle capacity weight (Total load capacity)	The rated cargo and luggage load plus 150 lb. (68 kg) times the vehicle's designated seating capacity

Tire related term	Meaning
Vehicle maximum load on the tire	The load on an individual tire that is determined by distributing to each axle its share of the maximum loaded vehicle weight, and dividing by two
Vehicle normal load on the tire	The load on an individual tire that is determined by distributing to each axle its share of curb weight, accessory weight, and normal occupant weight (distributed in accordance with Table 1 * below), and dividing by two
Weather side	The surface area of the rim not covered by the inflated tire
Bead	The part of the tire that is made of steel wires, wrapped or reinforced by ply cords and that is shaped to fit the rim
Bead separation	A breakdown of the bond between components in the bead
Bias ply tire	A pneumatic tire in which the ply cords that extend to the beads are laid at alternate angles substantially less than 90 degrees to the centerline of the tread
Carcass	The tire structure, except tread and sidewall rubber which, when inflated, bears the load
Chunking	The breaking away of pieces of the tread or sidewall
Cord	The strands forming the plies in the tire
Cord separation	The parting of cords from adjacent rubber compounds
Cracking	Any parting within the tread, sidewall, or innerliner of the tire extending to cord material

Tire related term	Meaning
CT	A pneumatic tire with an inverted flange tire and rim system in which the rim is designed with rim flanges pointed radially inward and the tire is designed to fit on the underside of the rim in a manner that encloses the rim flanges inside the air cavity of the tire
Extra load tire	A tire designed to operate at higher loads and at higher inflation pressures than the corresponding standard tire
Groove	The space between two adjacent tread ribs
Innerliner	The layer(s) forming the inside surface of a tubeless tire that contains the inflating medium within the tire
Innerliner separation	The parting of the innerliner from cord material in the carcass
Intended outboard sidewall	(a) The sidewall that contains a whitewall, bears white lettering, or bears manufacturer, brand, and/or model name molding that is higher or deeper than the same molding on the other sidewall of the tire, or (b) The outward facing sidewall of an asymmetrical tire that has a particular side that must always face outward when mounted on a vehicle
Light truck (LT) tire	A tire designated by its manufacturer as primarily intended for use on lightweight trucks or multipurpose passenger vehicles
Load rating	The maximum load that a tire is rated to carry for a given inflation pressure
Maximum load rating	The load rating for a tire at the maximum permissible inflation pressure for that tire
Maximum permissible inflation pressure	The maximum cold inflation pressure to which a tire may be inflated
Measuring rim	The rim on which a tire is fitted for physical dimension requirements

Tire related term	Meaning
Open splice	Any parting at any junction of tread, sidewall, or innerliner that extends to cord material
Outer diameter	The overall diameter of an inflated new tire
Overall width	The linear distance between the exteriors of the sidewalls of an inflated tire, including elevations due to labeling, decorations, or protective bands or ribs
Passenger car tire	A tire intended for use on passenger cars, multipurpose passenger vehicles, and trucks, that have a gross vehicle weight rating (GVWR) of 10,000 lb. or less.
Ply	A layer of rubber-coated parallel cords
Ply separation	A parting of rubber compound between adjacent plies
Pneumatic tire	A mechanical device made of rubber, chemicals, fabric and steel or other materials, that, when mounted on an automotive wheel, provides the traction and contains the gas or fluid that sustains the load
Radial ply tire	A pneumatic tire in which the ply cords that extend to the beads are laid at substantially 90 degrees to the centerline of the tread
Reinforced tire	A tire designed to operate at higher loads and at higher inflation pressures than the corresponding standard tire
Section width	The linear distance between the exteriors of the sidewalls of an inflated tire, excluding elevations due to labeling, decoration, or protective bands
Sidewall	That portion of a tire between the tread and bead
Sidewall separation	The parting of the rubber compound from the cord material in the sidewall

Tire related term	Meaning
Snow tire	A tire that attains a traction index equal to or greater than 110, compared to the ASTM E-1136 Standard Reference Test Tire, when using the snow traction test as described in ASTM F-1805-00, Standard Test Method for Single Wheel Driving Traction in a Straight Line on Snow-and Ice-Covered Surfaces, and which is marked with an Alpine Symbol () on at least one sidewall
Test rim	The rim on which a tire is fitted for testing, and may be any rim listed as appropriate for use with that tire
Tread	That portion of a tire that comes into contact with the road
Tread rib	A tread section running circumferentially around a tire
Tread separation	Pulling away of the tread from the tire carcass
Treadwear indicators (TWI)	The projections within the principal grooves designed to give a visual indication of the degrees of wear of the tread
Wheel-holding fixture	The fixture used to hold the wheel and tire assembly securely during testing

*: Table 1 -Occupant loading and distribution for vehicle normal load for various designated seating capacities

Designated seating capacity, Number of occupants	Vehicle normal load, Number of occupants	Occupant distribution in a normally loaded vehicle
2 through 4	2	2 in front
5 through 10	3	2 in front, 1 in second seat
11 through 15	5	2 in front, 1 in second seat, 1 in third seat, 1 in fourth seat
16 through 20	7	2 in front, 2 in second seat, 2 in third seat, 1 in fourth seat

Customizable features

Your vehicle includes a variety of electronic features that can be personalized to your preferences. The settings of these features can be changed by using the multi-information display, the multimedia system or at your Toyota dealer.

Customizing vehicle features

■ Changing by using the meter control switches (with 7-inch display)

- 1 Press \wedge / \vee of the meter control switch to select .
- 2 Press \lt / \gt of the meter control switch to select the desired item to be customized.
- 3 Press or press and hold OK.

The available settings will differ depending on if OK is pressed or pressed and held. Follow the instructions on the display.

■ Changing by using the meter control switches (with 12.3-inch display)

- 1 Press and hold OK to display the cursor on the content dis-

play area (center) of the multi-information display.

- 2 Press \wedge / \vee of the meter control switches to select “ Settings” and press OK.
- 3 Press \wedge / \vee of the meter control switches, select the item.
- 4 To switch the function on and off, press OK to switch to the desired setting.
- 5 To perform detailed setting of functions that support detailed settings, press and hold OK and display the setting screen.

The method of performing detailed setting differs for each screen.

Please refer to the advice sentence displayed on the screen.

■ Changing by using the multimedia system

- 1 Select  on the main menu
- 2 Select “Vehicle customize”.
- 3 According to the display, select the desired setting.

Various setting can be changed. Refer to the list of settings that can be changed for details.

⚠ WARNING

■ **During customization**

As the engine needs to be operating during customization, ensure that the vehicle is parked in a place with adequate ventilation. In a closed area such as a garage, exhaust gases including harmful carbon monoxide (CO) may collect and enter the vehicle. This may lead to death or a serious health hazard.

⚠ NOTICE

■ **During customization**

To prevent battery discharge, ensure that the engine is running while customizing features.

Customizable features

Some function settings are changed simultaneously with other functions being customized. Contact your Toyota dealer for further details.

- A** Settings that can be changed using the multimedia system
- B** Settings that can be changed using the multi-information display
- C** Settings that can be changed by your Toyota dealer

Definition of symbols: O = Available, — = Not available

■ **Gauges, meters and multi-information display (with 7-inch display) (→P.91)**

Function *1	Default setting	Customized setting	A	B	C
Language *2, 3	English	French	O	O	—
		Spanish			
Units *2	miles (MPG US)	km (km/L)	O	O	—
		km (L/100 km)			
		miles (MPG Imperial)			
Meter Style *3	“Tough”	“Casual”	—	O	—
		“Sporty”			
Dial Type *3	Tachometer	Speedometer	—	O	—

Function *1	Default setting	Customized setting	A	B	C
Fuel economy	The average fuel economy after starting	The average fuel economy since the function was reset	—	O	—
Audio system linked display *3	On	Off	—	O	—
Traction monitor display *3, 4	On	Off	—	O	—
Drive and trip information items (First item) *3	Distance	Average vehicle speed	—	O	—
		Elapsed time			
Drive and trip information items (Second item) *3	Average vehicle speed	Distance	—	O	—
		Elapsed time			
Pop-up display *3	On	Off	—	O	—
Suggestion function *3	On	On (When the vehicle is stopped)	O	—	O
		Off			
Stop light indicator	On	Off	—	O	—

*1: For details about each function: →P.97



*2: The default setting varies according to country.

*3: The default setting is changed in conjunction with the settings of My Settings.

*4: If equipped

■ **Gauges, meters and multi-information display (with 12.3-inch display) (→P.100)**

Function *1	Default setting	Customized setting	A	B	C
Language *2, 4	English	French	O	O	—
		Spanish			

Function ^{*1}	Default setting	Customized setting	A	B	C
Units ^{*2}	miles (MPG US)	km (km/L)	○	○	—
		km (L/100 km)			
		miles (MPG Imperial)			
Meter Type ^{*4}		 ^{*3}	—	○	—
		 ^{*3}			
Meter Style ^{*4}	"Tough"	"Casual"	—	○	—
		"Sporty"			
		"Smart"			
Dial Type ^{*4}	Tachometer	Speedometer	—	○	—
Fuel Economy	The average fuel economy after starting	The average fuel economy since the function was reset	—	○	—
Drive and trip information items (first item) ^{*4}	Distance	Average vehicle speed	—	○	—
		Elapsed time			
Drive and trip information items (second item) ^{*4}	Average vehicle speed	Distance	—	○	—
		Elapsed time			
Pop-up display ^{*4}	On	Off	—	○	—
Suggestion function ^{*4}	On	On (when the vehicle is stopped)	○	—	○
		Off			
Stop light indicator	On	Off	—	○	—

*1: For details about each function: →P.108

*2: The default setting varies according to country.

*3: The on/off operation of the widget can be changed.

*4: The default setting is changed in conjunction with the settings of My Settings.

■ Door lock (→P.119, 127, 606)

Function	Default setting	Customized setting	A	B	C
Unlocking using a mechanical key	Driver's door unlocked in one step, all doors unlocked in two step	All doors unlocked in one step	—	—	O
Automatic door locking function	Shift position linked door locking operation	Off			
		Speed linked door locking operation	O	—	O
Automatic door unlocking function	Shift position linked door unlocking operation	Off			
		Driver's door linked door unlocking operation	O	—	O

■ Smart key system and wireless remote control (→P.119, 127, 145)

Function	Default setting	Customized setting	A	B	C
Operating signal (Buzzers)	5	Off	O	—	O
		1 to 7			
Operation signal (Emergency flashers)	On	Off	O	—	O
Time elapsed before automatic door lock function is activated if door is not opened after being unlocked	60 seconds	30 seconds			
		120 seconds	O	—	O
Open door warning buzzer (When locking the vehicle)	On	Off	—	—	O

■ Smart key system (→P.119, 127, 145)

Function	Default setting	Customized setting	A	B	C
Smart key system	On	Off	—	—	O
Smart door unlocking	Driver's door	All the doors	O	—	O
Time elapsed before unlocking all the door when gripping and holding the driver's door handle	2 seconds	Off	—	—	O
		1.5 seconds			
		2.5 seconds			
Number of consecutive door lock operations	2 times	As many as desired	—	—	O
Engine switch illumination	On	Off	—	—	O

■ Wireless remote control (→P.116, 119, 127)

Function	Default setting	Customized setting	A	B	C
Unlocking operation	Driver's door unlocked in one step, all doors unlocked in two step	All doors unlocked in one step	O	—	O
The function that activates the  switch of the wireless remote control when locking the door (→P.130)*	Off	On (Unlocking all the door)	—	—	O
		On (Unlocking back door only)			
Theft deterrent panic mode	On	Off	—	—	O
Locking operation when door opened	On	Off	O	—	O

*: If equipped

■ Rear seat reminder (→P.121)

Function	Default setting	Customized setting	A	B	C
Indication to prevent misplacement in the rear seat	On	Off	—	O	—

■ Driving position memory* (→P.186)

Function	Default setting	Customized setting	A	B	C
Driver's seat slide movement when exiting the vehicle	Full	Off	O	—	O
		Partial			
Steering wheel movement	Tilt only	Off	O	—	O
		Telescopic only			
		Tilt and telescopic			

*: If equipped

■ Outside rear view mirrors* (→P.173)

Function	Default setting	Customized setting	A	B	C
Automatic mirror folding and extending operation	Linked to the locking/unlocking of the doors	Off	—	—	O
		Linked to operation of the engine switch			

*: If equipped

■ Power back door*¹ (→P.130)

Function	Default setting	Customized setting	A	B	C
Power back door operations	On	Off	—	O	—
Power back door switch operations	Press and hold	One short press	—	—	O
 switch of the wireless remote control operation	Press and hold	One short press	—	—	O
		Push twice			
		Off			
Operation buzzer volume	Level 3	Level 1	—	O	—
		Level 2			

Function	Default setting	Customized setting	A	B	C
Operation buzzer while the back door is operating *2	Off	On	—	—	O
Opening angle	5	1 to 4	—	O	—
		User setting *3			
Automatic closing of the back door when lowered	On	Off	—	—	O
Close & lock (Walk-Away) function	Off	On	—	—	O
Hands free power back door	On	Off	—	O	—
Kick sensor sensitivity	+0	+1	—	—	O
		+2			
Buzzer when the kick sensor detects a foot	On	Off	—	—	O
Hands Free close & lock (Walk-Away) function	Off	On	—	—	O

*1: If equipped

*2: The operation buzzer that sounds when the back door begins to operate cannot be turned off.

*3: The open position is set by the power back door switch. (→P.144)

■ **Power windows and moon roof*** (→P.177, 182)

Function	Default setting	Customized setting	A	B	C
Mechanical key linked operation	Off	On	—	—	O
Wireless remote control linked operation	Off	On (open only)	—	—	O
Wireless remote control linked operation signal (buzzer)	On	Off	—	—	O

Function	Default setting	Customized setting	A	B	C
Side windows open warning function	On	Off	—	—	O
Sliding roof open warning function	On	Off	—	—	O

*: If equipped

■ Moon roof* (→P.182)

Function	Default setting	Customized setting	A	B	C
Opening and closing parts during door-linked operation	Slide only	Tilt only	—	—	O
Opening and closing parts during wireless remote control linked operation	Slide only	Tilt only	—	—	O

*: If equipped

■ Power back window (→P.180)

Function	Default setting	Customized setting	A	B	C
Opening and closing the power back windows operation* ¹	On	Off	—	—	O
Time required to press and hold the switch before the window begins to open/close* ¹	0.8 seconds	1 second	—	—	O
		1.2 seconds			
		1.4 seconds			
Power back window up permission control, when a door is not fully closed* ¹	On	Off	—	—	O
Auto opening and auto closing the power back windows operation* ²	On	Off	—	—	O

*¹: Switch that can be operated from outside the vehicle.

*²: Switch that can be operated from inside the vehicle.

■ Engine switch (→P.218)

Function	Customized setting	A	B	C
ACC customization Enabling/Disabling ACC mode	On/Off	O	—	O

■ Automatic light control system (→P.234)

Function	Default setting	Customized setting	A	B	C
Light sensor sensitivity	Normal	Brighter	O	—	O
		Bright			
		Dark			
		Darker			
Time elapsed before headlights automatically turn off after doors are closed	30 seconds	Off	O	—	O
		60 seconds			
		90 seconds			
Windshield wiper linked headlight illumination	On	Off	—	—	O

■ Lights (→P.234)

Function	Default setting	Customized setting	A	B	C
Daytime running lights* ¹	On	Off	O	—	O
Welcome lamp* ²	On	Off	—	—	O

*1: Except for Canada

*2: If equipped

■ Rear window wiper (→P.243)

Function	Default setting	Customized setting	A	B	C
Back door opening linked rear window wiper stop function	On	Off	—	—	O
Washer linked rear window wiper operation	On	Off	—	—	O
Reverse-linked rear window wiper function	Once	Off	—	—	O
		Continuous	—	—	O
Drip prevention function	On	Off	—	—	O
Wiper operation interval	3 seconds	2 seconds	—	—	O
		4 seconds			
		5 seconds			
Time elapsed before the rear wiper storage function activates	3 seconds	4 seconds	—	—	O
		5 seconds			
		6 seconds			

■ Pre-Collision System (→P.259)

Function	Customized setting	A	B	C
Pre-Collision System	ON/OFF	—	O	—
Warning timing*	Later/Default/Earlier	—	O	—

*: This setting changes in accordance with My Settings.

■ Lane Departure Alert system (LDA) (→P.275)

Function	Customized setting	A	B	C
Lane Departure Alert system (LDA)*	ON/OFF	—	O	—
Alert timing*	Default/Earlier	—	O	—
Alert options*	Vibration/Audible	—	O	—

*: This setting changes in accordance with My Settings.

■ **Driver break suggestion (→P.275)**

Function	Customized setting	A	B	C
Driver break suggestion	ON/OFF	—	○	—

■ **Proactive Driving Assist (→P.281)**

Function	Customized setting	A	B	C
Proactive Driving Assist (PDA)*	ON/OFF	—	○	—
Support sensitivity*	Low/Mid/High	—	○	—
Steering Assist (SA)*	ON/OFF	—	○	—
Deceleration Assist (DA)*	ON/OFF	—	○	—
Obstacle Anticipation Assist (OAA)*	ON/OFF	—	○	—

*: This setting changes in accordance with My Settings.

■ **Road Sign Assist*¹ (→P.288)**

Function	Customized setting	A	B	C
Road Sign Assist* ²	ON/OFF	—	○	—
Excess speed notification method* ²	None/Visual/Visual & Audible	—	○	—
Other notifications method* ²	None/Visual/Visual & Audible	—	○	—
Excess speed notification level* ²	5 mph (10 km/h) / 3 mph (5 km/h) / 1 mph (2 km/h)	—	○	—

*¹: If equipped

*²: This setting changes in accordance with My Settings.

■ **Dynamic Radar Cruise Control (DRCC) (→P.290)**

Function	Customized setting	A	B	C
Acceleration setting*	Low/Mid/High	—	○	—
Guide message*	ON/OFF	—	○	—
Curve speed reduction*	OFF/Low/Mid/High	—	○	—

*: This setting changes in accordance with My Settings.

■ Stop & Start system* (→P.309)

Function	Default setting	Customized setting	A	B	C
Change the Stop & Start system duration when the A/C is on	Standard	Extended	—	O	—

*: If equipped

■ BSM (Blind Spot Monitor) (→P.316)

Function	Customized setting	A	B	C
BSM (Blind Spot Monitor)	On/Off	—	O	—
Outside rear view mirror indicator brightness*	Dim/Bright	—	O	—
Alert timing for presence of approaching vehicle (sensitivity)*	Later/Default/Earlier	—	O	—

*: This setting changes in accordance with My Settings

■ Intuitive parking assist*¹ (→P.323)

Function	Customized setting	A	B	C
Intuitive parking assist* ²	On/Off	—	O	—
Buzzer volume of Intuitive parking assist when operating* ^{2, 3}	Level 1/Level 2/Level 3	—	O	—

*¹: If equipped

*²: This setting changes in accordance with My Settings

*³: The sound volume is linked among the intuitive parking assist, RCTA, and RCD*¹.

■ **RCTA (Rear Cross Traffic Alert) function (→P.330)**

Function	Customized setting	A	B	C
RCTA (Rear Cross Traffic Alert)	On/Off	—	O	—
Buzzer volume of RCTA when operating ^{*1, 2}	Level1/Level2/Level3	—	O	—

^{*1}: This setting changes in accordance with My Settings

^{*2}: The sound volume is linked among the intuitive parking assist^{*3}, RCTA, and RCD^{*3}.

^{*3}: If equipped

■ **PKSB (Parking Support Brake)^{*1} (→P.339)**

Function	Customized setting	A	B	C
PKSB (Parking Support Brake) function ^{*2}	On/Off	—	O	—

^{*1}: If equipped

^{*2}: This setting changes in accordance with My Settings

■ **RCD (Rear Camera Detection)^{*} (→P.335)**

Function	Customized setting	A	B	C
RCD (Rear Camera Detection) function	On/Off	—	O	—

^{*}: If equipped

■ **Automatic air conditioning system^{*} (→P.460)**

Function	Default setting	Customized setting	A	B	C
A/C mode with auto	On	Off	O	—	O

^{*}: If equipped

■ Illumination (→P.469)

Function	Default setting	Customized setting	A	B	C
Time elapsed before the interior lights turn off* ¹	15 seconds	Off			
		7.5 seconds	O	—	O
		30 seconds			
Operation of the personal/interior lights after the engine switch is turned off	On	Off	—	—	O
Operation of the personal/interior lights when the doors are unlocked	On	Off	—	—	O
Operation of the personal/interior lights when you approach the vehicle with the electronic key on your person	On	Off	—	—	O
Time elapsed before the outer foot lights* ² turn off* ¹	15 seconds	Off			
		7.5 seconds	O	—	O
		30 seconds			
Operation of the outer foot lights* ² when you approach the vehicle with the electronic key on your person	On	Off	—	—	O
Operation of the outer foot lights* ² when the doors are unlocked	On	Off	—	—	O
Operation of the outer foot lights* ² when a door is opened	On	Off	—	—	O
Brightness control* ^{1, 2}	9	9 to 1	O	—	O
		Off			

*¹: The default setting is changed in conjunction with the settings of My Settings.

*²: If equipped

■ Driving mode select switch (→P.412)

Function	Default setting	Customized setting	A	B	C
Powertrain control in Custom mode *	Normal	Power	O	—	—
		Eco			
Suspension control in Custom mode *	Normal	Sport	O	—	—
		Comfort			
Steering control in Custom mode *	Normal	Sport	O	—	—
Air conditioning operation in custom mode *	Normal	Eco	O	—	—

*: If equipped

■ Vehicle customization

- When the smart key system is off, the entry unlock function cannot be customized.
- When the doors remain closed after unlocking the doors and the timer activated automatic door lock function activates, signals will be generated in accordance with the operation buzzer volume and operational signal (Emergency flashers) function settings.
- Some settings can be changed using a switch or the multimedia system. If a setting is changed using a switch, the changed setting will not be reflected on the multimedia system until the engine switch is turned off and then to ON.

Items to initialize

The following items must be initialized for normal system operation after such cases as the battery being reconnected, or maintenance being performed on the vehicle:

List of items to initialize

Item	When to initialize	Reference
Power back door*	<ul style="list-style-type: none"> • After reconnecting or changing the battery 	P.139
Power window	<ul style="list-style-type: none"> • When functioning abnormally 	P.177
Moon roof*		P.183
Maintenance required reminder message	<ul style="list-style-type: none"> • After the maintenance is performed 	P.521, 532
Tire pressure warning system	<ul style="list-style-type: none"> • When the tire inflation pressure is changed, such as when changing traveling speed or load weight. • When the tire inflation pressure is changed, such as when the tire size is changed. • When rotating the tires. • After performing the transmitter ID code registration procedure. 	P.544
Panoramic view monitor*	<ul style="list-style-type: none"> • Battery has been reinstalled. • The steering wheel has been moved while the battery was being reinstalled. • Battery power is low. 	P.396, 411
Multi-terrain Monitor*		

*: If equipped

9-1. For owners

- Reporting safety defects for
U.S. owners..... 656
- Reporting safety defects for
Canadian owners 656
- Seat belt instructions for
Canadian owners (in
French)..... 657
- SRS airbag instructions for
Canadian owners (in
French)..... 658

Reporting safety defects for U.S. owners

If you believe that your vehicle has a defect which could cause a crash or could cause injury or death, you should immediately inform the National Highway Traffic Safety Administration (NHTSA) in addition to notifying Toyota Motor Sales, U.S.A., Inc. (Toll-free: 1-800-331-4331).

If NHTSA receives similar complaints, it may open an investigation, and if it finds that a safety defect exists in a group of vehicles, it may order a recall and remedy campaign. However, NHTSA cannot become involved in individual problems between you, your dealer, or Toyota Motor Sales, U.S.A., Inc.

To contact NHTSA, you may call the Vehicle Safety Hotline toll-free at 1-888-327-4236 (TTY: 1-800-424-9153); go to <http://www.safercar.gov>, or write to: Administrator, NHTSA, 1200 New Jersey Ave. SE., Washington, DC 20590. You can also obtain other information about motor vehicle safety from <http://www.safercar.gov>.

Reporting safety defects for Canadian owners

Canadian customers who wish to report a safety-related defect to Transport Canada, Defects Investigations and Recalls, may telephone the toll-free hotline 1-800-333-0510, mail Transport Canada - ASFAD, 330 Sparks Street, Ottawa, ON, K1A 0N5, or complete the online form at <https://www.tc.gc.ca/recalls>.

Seat belt instructions for Canadian owners (in French)

The following is a French explanation of seat belt instructions extracted from the seat belt section in this manual.

See the seat belt section for more detailed seat belt instructions in English.

Utilisation correcte des ceintures de sécurité



- Déroulez la sangle diagonale de telle sorte qu'elle passe bien sur l'épaule, sans pour autant être en contact avec le cou ou glisser de l'épaule.
- Placez la sangle abdominale le plus bas possible sur les hanches.
- Réglez la position du dossier de siège. Asseyez-vous le dos le plus droit possible et caliez-vous bien dans le siège.
- Ne pas vriller la ceinture de

sécurité.

Entretien et soin

■ Manipulation des ceintures de sécurité

Avec un chiffon ou une éponge, nettoyez à l'aide d'un savon doux et de l'eau tiède. Vérifiez aussi les ceintures régulièrement pour vous assurer qu'elles ne présentent pas d'usure excessive, d'effilochage ou de coupures.



AVERTISSEMENT

■ État et usure des ceintures de sécurité

Inspectez les ceintures de sécurité périodiquement. Contrôlez qu'elles ne sont pas entaillées, effilochées, et que leurs ancrages ne sont pas desserrés. Ne pas utiliser une ceinture de sécurité défectueuse avant qu'elle ne soit remplacée. Une ceinture de sécurité défectueuse n'apporte aucune garantie de protection de l'occupant contre des blessures graves, voire mortelles.

SRS airbag instructions for Canadian owners (in French)

The following is a French explanation of SRS airbag instructions extracted from the SRS airbag section in this manual.

See the SRS airbag section for more detailed SRS airbag instructions in English.

Système de coussins gonflables SRS

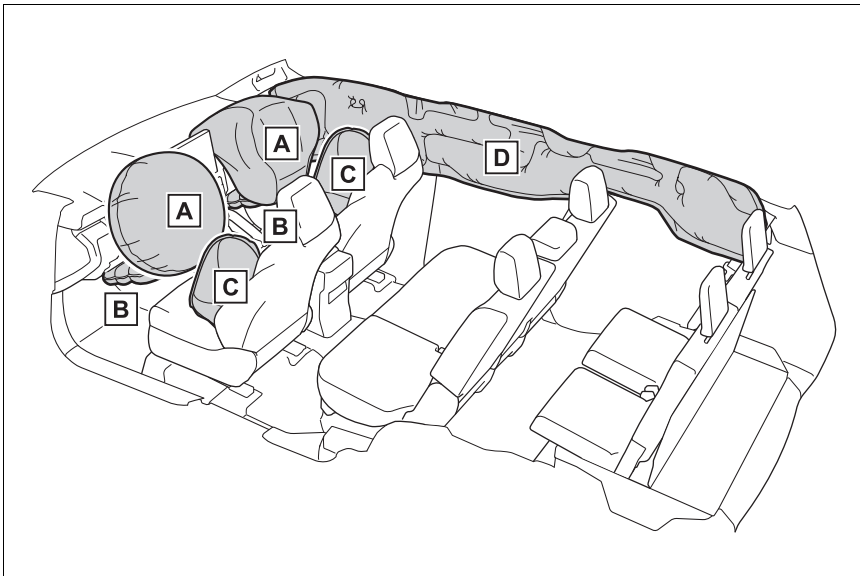

- A** Coussin gonflable SRS conducteur/passager avant
Contribuent à réduire l'impact de la tête et du thorax du conducteur ou de la conductrice et du passager avant
- B** Coussins gonflables SRS de genoux
Contribuent à réduire l'impact sur le conducteur ou la conductrice et le passager avant
- C** Coussins gonflables SRS latéraux
Contribuent à réduire l'impact du thorax des occupants des sièges avant
- D** Coussins gonflables SRS rideau
 - Contribuent à réduire l'impact de la tête des occupants des sièges avant

et des sièges arrière latéraux

- Participent à empêcher les occupants d'être éjectés du véhicule en cas de retournement de celui-ci

Votre véhicule est équipé de COUSSINS GONFLABLES INTELLIGENTS (ADVANCED AIRBAGS) conçus selon les normes de sécurité américaines applicables aux véhicules à moteur (FMVSS208). Le boîtier électronique de coussins gonflables (ECU) utilise les informations reçues des capteurs, etc., détaillés dans le schéma ci-dessus de composition du système pour commander le déploiement des coussins gonflables. Ces informations comprennent des informations sur la gravité de la collision et les occupants. Le déploiement rapide des coussins gonflables est obtenu au moyen d'une réaction chimique dans les dispositifs pyrotechniques, qui produit un gaz inoffensif permettant d'amortir le mouvement des occupants.



AVERTISSEMENT

■ Précautions avec les coussins gonflables SRS

Respectez les précautions suivantes.

À défaut, des blessures graves, voire mortelles, pourraient s'ensuivre.

- La personne au volant et tous les passagers à bord du véhicule doivent porter correctement leur ceinture de sécurité. Les coussins gonflables SRS sont des dispositifs de protection complémentaires aux ceintures de sécurité.

- Le coussin gonflable SRS conducteur se déploie avec une puissance considérable et peut occasionner des blessures graves, voire mortelles, notamment lorsque le conducteur se trouve très près du coussin gonflable. L'autorité fédérale chargée de la sécurité routière aux États-Unis, la NHTSA (National Highway Traffic Safety Administration) conseille:

Sachant que la zone de danger pour le coussin gonflable conducteur se trouve dans les premiers 2 à 3 in. (50 à 75 mm) du déploiement, placez-vous à 10 in. (250 mm) du coussin gonflable conducteur pour garantir une marge de sécurité suffisante. Cette distance est à mesurer entre le moyeu du volant de direction et le sternum. Si votre position de conduite vous place à moins de 10 in. (250 mm) du coussin gonflable conducteur, vous pouvez en changer de différentes façons:



AVERTISSEMENT

- Reculez votre siège au plus loin possible tout en continuant à pouvoir atteindre confortablement les pédales.
- Inclinez légèrement le dossier de siège. Bien que les véhicules soient différents les uns des autres, la plupart des conducteurs et conductrices peuvent s'asseoir à une distance de 10 in. (250 mm), même avec le siège conducteur complètement avancé, en inclinant simplement un peu le dossier du siège. Si vous avez des difficultés à voir la route après avoir incliné le dossier de siège, utilisez un coussin ferme et antidérapant pour vous rehausser ou, si votre véhicule est équipé du réglage en hauteur du siège, remontez-le.
- Si votre volant de direction est réglable, inclinez-le vers le bas. Cela vous permet d'orienter le coussin gonflable vers votre buste plutôt que vers la tête et le cou. Vous devez régler le siège selon les recommandations de la NHTSA, tout en continuant à pouvoir agir sur le volant de direction et les pédales pour maîtriser le véhicule et en conservant votre vue des commandes au tableau de bord.

- Si vous attachez une rallonge de ceinture de sécurité à la boucle de ceinture d'un siège avant, mais pas au pêne de la ceinture de sécurité proprement dite, le système de coussins gonflables SRS détermine que l'occupant porte sa ceinture de sécurité, alors même qu'elle n'est pas attachée. Dans ce cas, les coussins gonflables SRS frontaux risquent de ne pas se déployer correctement en cas de collision, causant des blessures graves, voire mortelles. Veillez à porter correctement la ceinture de sécurité lorsque vous utilisez une rallonge de ceinture de sécurité.

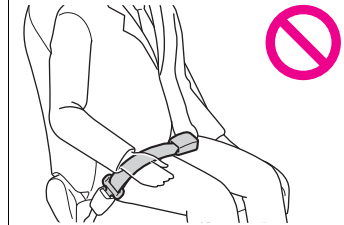

- Le coussin gonflable SRS passager avant se déploie avec une puissance considérable et peut occasionner des blessures graves, voire mortelles, notamment lorsque le passager avant se trouve très près du coussin gonflable. Le siège passager avant doit être reculé le plus loin possible du coussin gonflable, avec le dossier réglé de manière à ce que le passager ou la passagère soit assis(e) bien droit(e).

⚠️ AVERTISSEMENT

- Le déploiement d'un coussin gonflable peut infliger des blessures graves, voire mortelles, aux nourrissons et aux enfants mal assis et/ou mal attachés. Installez dans un siège de sécurité enfant les enfants trop jeunes pour pouvoir utiliser la ceinture de sécurité. Toyota recommande vivement que tous les nourrissons et enfants soient installés dans les sièges arrière du véhicule et convenablement attachés. Les sièges arrière sont plus sûrs pour les nourrissons et les enfants que le siège passager avant.
- Ne jamais installer un siège de sécurité enfant type dos à la route sur le siège passager avant, même si le témoin indicateur "AIR BAG OFF" est allumé. En cas d'accident, la force exercée par le déploiement rapide du coussin gonflable passager avant peut causer des blessures graves, voire mortelles à un enfant, si le siège de sécurité enfant type dos à la route est installé sur le siège passager avant.
- Ne pas s'asseoir sur le bord du siège et ne pas s'appuyer contre la planche de bord.

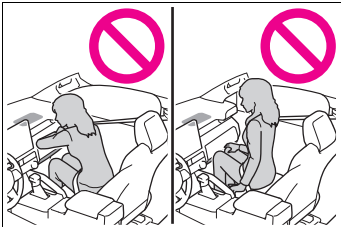

- Ne pas laisser un enfant se tenir debout devant le coussin gonflable SRS passager avant ni assis sur les genoux du passager ou de la passagère avant.

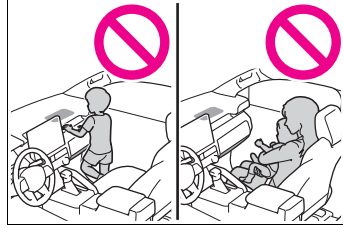

- La personne occupant le siège avant ne doit jamais voyager avec quoi que ce soit sur ses genoux.
- Ne pas s'appuyer contre la porte, contre le rail latéral de toit ou contre le montant avant, latéral ou arrière.



- Interdisez à quiconque de s'agenouiller sur un siège en appui contre la porte ou de sortir la tête ou les mains à l'extérieur du véhicule.

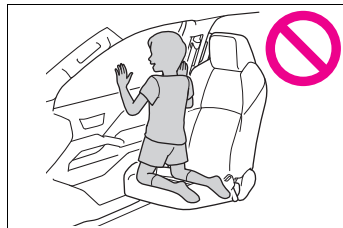



AVERTISSEMENT

- Ne rien fixer ou disposer sur la planche de bord, la garniture centrale du moyeu de volant de direction et la partie inférieure du tableau de bord.

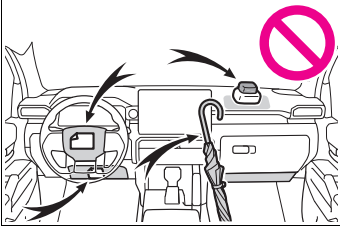

- Ne rien fixer sur les parties telles que les portes, la vitre de pare-brise, les vitres latérales, les montants avant ou arrière, les rails latéraux de toit et les poignées de maintien.

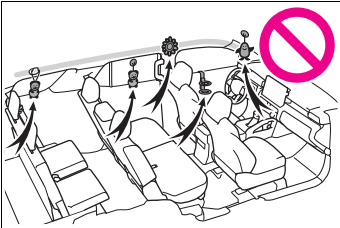

- Ne pas suspendre aux crochets à vêtements un cintre nu ni aucun objet dur ou tranchant. Ces objets peuvent se transformer en projectiles capables de tuer ou de blesser grièvement en cas de déploiement des coussins gonflables SRS rideau.
- Si une housse en vinyle recouvre la partie où le coussin gonflable SRS de genoux se déploie, veillez à l'enlever.

- N'utilisez pour les sièges aucun accessoire venant recouvrir les parties par lesquelles se déploient les coussins gonflables SRS latéraux, car il risquerait d'en gêner le déclenchement. De tels accessoires risquent d'empêcher les coussins gonflables SRS latéraux de se déployer correctement, de neutraliser le système ou de provoquer le déploiement intempestif des coussins gonflables SRS, avec un risque possible de blessures graves, voire mortelles.

- Ne pas faire subir de chocs violents ni des pressions excessives aux éléments constitutifs du système de coussins gonflables SRS, ni aux parties qui les entourent.

En effet, vous risqueriez d'occasionner un mauvais fonctionnement des coussins gonflables SRS.

- Ne touchez aucun élément constitutif des coussins gonflables SRS immédiatement après leur déclenchement (déploiement), car ils sont alors encore très chauds.

- Si vous avez des difficultés à respirer après le déploiement des coussins gonflables SRS, ouvrez une porte ou une vitre pour faire entrer de l'air frais, ou bien descendez du véhicule si cela ne présente pas de danger. Retirez tout résidu dès que possible afin d'éviter d'éventuelles irritations de la peau.

- Si une partie renfermant un coussin gonflable SRS est abîmée ou fendue, faites-la remplacer par votre concessionnaire Toyota.

**AVERTISSEMENT**

● Ne rien poser sur le siège du passager avant, comme un coussin par exemple. Cela a pour conséquence de répartir le poids du passager sur toute la surface du siège, ce qui empêche le capteur de détecter normalement le poids du passager. Il s'ensuit le risque que les coussins gonflables SRS frontaux du siège passager avant ne se déploient pas en cas de collision.

■ **Modification et élimination en fin de vie des éléments du système de coussins gonflables SRS**

Ne mettez pas à la casse votre véhicule et ne lui apportez aucune des modifications suivantes sans consulter votre concessionnaire Toyota. Il pourrait arriver que les coussins gonflables SRS fonctionnent anormalement ou se déploient intempestivement, avec un risque possible de blessures graves, voire mortelles.

- Dépose, repose, démontage ou réparation des coussins gonflables SRS
- Réparation, dépose ou modification des pièces suivantes ou des parties qui les entourent
- Volant de direction
- Tableau de bord
- Planche de bord
- Sièges
- Sellerie de sièges
- Montants avant
- Montants latéraux
- Montants arrière

- Rails latéraux de toit
- Panneaux de portes avant
- Habillage de portes avant
- Haut-parleurs de portes avant
- Modifications des panneaux de portes avant (percer un trou dedans, par exemple)
- Réparation ou modification des pièces suivantes ou des parties qui les entourent
- Aile avant
- Pare-chocs avant
- Côtés de l'intérieur du véhicule
- Montage des pièces ou accessoires suivants
- Pare-buffles ou pare-kangourous
- Chasse-neiges
- Treuils
- Modifications de la suspensions du véhicule
- Installation d'appareils électroniques, tels qu'un système radio émetteur/récepteur mobile (émetteur RF) ou un lecteur de CD
- Aménagements du véhicule visant à permettre sa conduite par une personne atteinte d'un handicap physique

Index

- What to do if... (Troubleshooting) 666
- Alphabetical Index..... 669

What to do if... (Troubleshooting)

If you have a problem, check the following before contacting your Toyota dealer.

The doors cannot be locked, unlocked, opened or closed



You lose your keys

- If you lose your keys, new keys can be made by your Toyota dealer. (→P.605)
- If you lose your electronic keys, the risk of vehicle theft increases significantly. Contact your Toyota dealer immediately. (→P.605)



The electronic key does not operate properly

- Is the electronic key battery weak or depleted? (→P.558)



The doors cannot be locked or unlocked

- Is the engine switch in ON?

When locking the doors, turn the engine switch off. (→P.220)

- Is the electronic key left inside the vehicle?

When locking the doors, make sure that you have the electronic key on

your person.

- The function may not operate properly due to the condition of the radio wave. (→P.147)



The rear door cannot be opened

- Is the child-protector lock set?

The rear door cannot be opened from inside the vehicle when the lock is set. Open the rear door from outside and then unlock the child-protector lock. (→P.123)

If you think something is wrong



The engine does not start

- Did you press the engine switch while firmly depressing the brake pedal? (→P.218)
- Is the shift lever in P? (→P.218)
- Is the electronic key anywhere detectable inside the vehicle? (→P.146)
- Is the electronic key battery weak or depleted?

In this case, the engine can be started in a temporary way. (→P.607)

- Is the battery discharged? (→P.608)



The shift lever cannot be shifted from P even if you depress the brake pedal

- Is the engine switch in ON?

If you cannot release the shift lever by depressing the brake pedal with the engine switch in ON. (→P.224)



The windows do not open or close by operating the power window switches

- Is the window lock switch pressed?

The power window except for the one at the driver's seat cannot be operated if the window lock switch is pressed. (→P.179)



The engine switch is turned off automatically

- The auto power off function will be operated if the vehicle is left in ACC or ON (the engine is not running) for a period of time. (→P.221)



A warning buzzer sounds during driving

- The seat belt reminder light is flashing

Are the driver and the front passenger wearing the seat belts? (→P.583)

- The parking brake indicator is on

Is the parking brake released? (→P.227)

Depending on the situation, other types of warning buzzer may also sound. (→P.576, 587)



An alarm is activated and the horn sounds

- Did anyone inside the vehicle open a door during setting the alarm?

The sensor detects it and the alarm sounds. (→P.71)

Do one of the following to deactivate or stop the alarms:

- Unlock the doors.
- Turn the engine switch to ACC or ON, or start the engine. (The alarm will be deactivated or stopped after a few seconds.)



A warning buzzer sounds when leaving the vehicle

- Is the message displayed on the multi-information display?

Check the message on the multi-information display. (→P.587)



A warning light turns on or a warning message is displayed

- When a warning light turns on or a warning message is displayed, refer to P.576, 587.

When a problem has occurred



If you have a flat tire

- Stop the vehicle in a safe place and replace the flat tire with the spare tire. (→P.593)



The vehicle becomes stuck

- Try the procedure for when the vehicle becomes stuck in mud, dirt, or snow. (→P.614)

Alphabetical Index

A

A/C 460
 Air conditioning filter 557
 Automatic air conditioning system 460
 Manual air conditioning system 454
ABS (Anti-lock Brake System) 431
 Warning light 578
Adaptive Variable Suspension System (AVS) 431
AI-SHIFT 223
Air conditioning filter 557
Air conditioning system 460
 Air conditioning filter 557
 Automatic air conditioning system 460
 Manual air conditioning system 454
Airbags 36
 Airbag operating conditions 37
 Airbag precautions for your child 39
 Correct driving posture 29
 Curtain shield airbag operating conditions 38
 Curtain shield airbag precautions 39
 Front passenger occupant classification system 44
 General airbag precautions 39
 Modification and disposal of airbags 42
 Side airbag operating conditions 38
 Side airbag precautions 39

Side and curtain shield airbags operating conditions 38
 Side and curtain shield airbags precautions 39
 SRS airbags 36
 SRS warning light 577
Alarm 71
 Warning buzzer 576
Anchor brackets 53, 63
Antennas (smart key system) 145
Anti-lock Brake System (ABS) 431
 Warning light 578
Approach warning 297
Armrest 489
Assist grips 489
Audio system-linked display .94, 104
AUTO LSD system 419
Automatic air conditioning system 460
Automatic High Beam (AHB) .238
Automatic light control system 235
Automatic transmission 222
 If the shift lever cannot be shifted from P 224
 S mode 225
 TOW HAUL switch 222
Auxiliary boxes 475
Average fuel economy 92, 103
AVS (Adaptive Variable Suspension System) 431

B

Back door 127
 Hands Free Power Back Door 133

- Power back door 130
- Wireless remote control 130, 131
- Back window**
- Power back window 180
- Back-up lights**
- Replacing light bulbs 564
- Battery**
- Battery checking 535
- If the battery is discharged ... 608
- Preparing and checking before winter 448
- Warning light 577
- Blind Spot Monitor (BSM)..... 316**
- Boost gauge 94, 108**
- Bottle holders 474**
- Brake**
- Brake hold 231
- Fluid 535, 621
- Parking brake 227
- Warning light 576
- Brake assist 431**
- Brake hold..... 231**
- Brake Override System..... 194**
- Break-in tips 194**
- Brightness control**
- Instrument panel light control 84, 90
- BSM (Blind Spot Monitor)..... 316**

C

- Camera**
- Digital Rear-view Mirror 168
- Front camera 251
- Care 514, 517**
- Aluminum wheel ornaments .514
- Aluminum wheels 514
- Exterior 514
- Interior 517
- Seat belts 517
- Cargo and luggage 200**
- Cargo capacity 204**
- Cargo hooks..... 478**
- Chains..... 450**
- Child restraint system..... 51**
- Fixed with a LATCH system ... 60
- Fixed with a seat belt 56
- Front passenger occupant classification system 44
- Points to remember 51
- Riding with children 50
- Types of child restraint system installation method 53
- Using an anchor bracket 63
- Child safety 50**
- Airbag precautions 39
- Back door precautions 127
- Battery precautions 537, 611
- Child restraint system 53
- Heated steering wheel and seat heater precautions 467
- How your child should wear the seat belt 32
- Power back window 181
- Power window lock switch 179
- Power window precautions ... 178
- Rear door child-protectors 123
- Removed electronic key battery precautions 559
- Seat belt extender precautions 33
- Seat belt precautions 50
- Child-protectors..... 123**
- Cleaning 514, 517**
- Aluminum wheel ornaments .514
- Aluminum wheels 514

Digital Rear-view Mirror..... 168
 Exterior..... 514
 Interior 517
 Radar sensor..... 252
 Seat belts 517
Clinometer 94, 106
Clock 81, 84, 85, 90
Coat hooks..... 489
Condenser 534
Console box..... 475
Consumption screen..... 110
Coolant..... 533
 Checking 533
Cooling system 533
 Engine overheating 612
Crawl Control..... 422
Cruise control
 Dynamic radar cruise control
 290, 301
 Warning lights..... 580
Cup holders 474
Current fuel consumption 92, 103
Curtain shield airbags 36
Customizable features 637

D

DAC 428
Daytime running light system 234
Daytime running lights
 Replacing light bulbs 564
Defogger
 Outside rear view mirrors ... 455,
 462
 Rear window 455, 462
 Windshield..... 455, 462
Differential 621
Digital key 117
Digital Rear-view Mirror 164

Dimension 616
Dinghy towing..... 217
Display
 Cruise control 301
 Dynamic radar cruise control 294
 Intuitive parking assist 323
 Multi-information display. 91, 100
 Pedestrians Rear of the Vehicle
 349
 RCD (Rear Camera Detection)
 336
 Rear Camera Detection (RCD)
 336
 Warning messages 587
Do-it-yourself maintenance ... 521
Door courtesy lights..... 469
Door lock
 Back door 127
 Side doors 119
 Smart key system 145
 Wireless remote control..... 116
Doors
 Automatic door locking and
 unlocking system 123
 Back door 127
 Door glasses 177
 Door lock 119
 Open door warning buzzer . 120,
 122
 Outside rear view mirrors 173
 Rear door child-protectors 123
 Side doors 119
Downhill assist control system
 428
Drive information..... 94, 104
Drive-start control 199
Driving 193
 Break-in tips 194

Correct driving posture 29
 Procedures 193
 Winter drive tips 448

Driving assist information
 Warning lights 579

Driving information display **92**

Driving mode select switch ... **412**

Driving position memory **186**
 Memory recall function 188
 Power easy access system .. 186

Driving support system information display **93, 103**

Dynamic radar cruise control
 **290, 301**
 Approach warning 297
 Curve speed reduction function
 298
 Warning lights 579

E

Eco Driving Indicator **93, 103**

EDR (Event data recorder) **10**

Electric Power Steering (EPS)
 **432**
 Warning light 578

Electronic key **114**
 Battery-saving function 146
 If the electronic key does not
 operate properly 606
 Replacing the battery 558

Emergency Driving Stop System
 **305**

Emergency flashers **568**

Emergency tire puncture **593**

Emergency, in case of
 If a warning buzzer sounds .. 576
 If a warning light turns on 576
 If a warning message is displayed..... 587

If the battery is discharged ... 608

If the electronic key does not
 operate properly 606

If the engine will not start..... 604

If the vehicle is submerged or
 water on the road is rising .. 569

If you have a flat tire 593

If you lose your keys 605

If you think something is wrong
 574

If your vehicle becomes stuck
 614

If your vehicle has to be stopped
 in an emergency 568

If your vehicle needs to be towed
 571

If your vehicle overheats 612

Engine **617**
 ACC 220
 Compartment 530
 Engine switch 218
 Fuel pump shut off system ... 575
 If the engine will not start..... 604
 Overheating 612
 Starting the engine 218

Engine coolant **533**
 Capacity 619
 Checking 533
 Preparing and checking before
 winter 448

**Engine coolant temperature
 gauge** **81, 85**

Engine oil
 Capacity 618
 Checking 531
 Warning light 577

Engine oil pressure gauge **94,
 107**

Engine oil temperature gauge94,
107

Engine switch218
 Auto power off function221
 Changing the engine switch
 modes220
 If your vehicle has to be stopped
 in an emergency.....568

Enhanced Vehicle Stability Control (Enhanced VSC)431

Enhanced VSC (Enhanced Vehicle Stability Control)431

EPS (Electric Power Steering)
432
 Warning light578

Event data recorder (EDR)..... 10

F

Flat tire593
 Tire pressure warning system
541

Floor mats.....28

Fluid
 Automatic transmission620
 Brake621
 Washer538

Fog light
 Replacing light bulbs564
 Switch.....237

Footwell lights469

Four-wheel drive system414, 417

Front fog light
 Replacing light bulbs564

Front passenger occupant classification system44

Front seats.....151
 Adjustment151
 Cleaning517

Correct driving posture29

Driving position memory186

Head restraints158

Memory recall function188

Power easy access system ..186

Seat heaters467

Seat position memory186

Seat ventilators.....467

Front turn signal lights226
 Turn signal lever226

Front turn signal/parking lights
 Replacing light bulbs564
 Wattage623

Fuel
 Capacity617
 Fuel gauge81, 85
 Fuel pump shut off system ...575
 Information624
 Opening the fuel tank cap246
 Type.....617
 Warning light.....583

Fuel consumption
 Average fuel economy....92, 103
 Current fuel consumption92, 103

Fuel economy92, 103

Fuel gauge.....81, 85

Fuel pump shut off system....575

Fuses560

G

Garage door opener504

Gauges81, 85

Glove box474

Grocery bag hooks.....478

H

Head restraints158

Headlights

- Automatic High Beam (AHB) 238
- Light switch 234
- Replacing light bulbs 564

Heated steering wheel 467

Heaters

- Automatic air conditioning system 460
- Heated steering wheel 467
- Heater system 454
- Manual air conditioning system 454
- Outside rear view mirrors ... 455, 462
- Seat heaters 467

High mounted spotlight

- Replacing light bulbs 564

Hill-start assist control 431

Hood 528

- Open 528

Hooks

- Retaining hooks (floor mat) ... 28

Horn 162

I

Identification

- Vehicle 616

Ignition switch (engine switch) 218

Illuminated entry system 471

Immobilizer system 70

Indicators 78

Initialization

- Items to initialize 653
- Power back door 139
- Power windows 177

Inside door handle lights 469

Inside rear view mirror 162

Instrument panel light control 84, 90

Intercooler 534

Interior lights 469

Interior lights list 469

Intuitive parking assist 323

- Enabling/disabling the system 324
- Function 323
- Warning lights 580

J

Jam protection function

- Moon roof 183
- Power back door 136
- Power running boards 125
- Power windows 177

K

Keyless entry

- Smart key system 145
- Wireless remote control 116

Keys 114

- Battery-saving function 146
- Digital key 117
- Electronic key 114
- Engine switch 218
- If the electronic key does not operate properly 606
- If you lose your keys 605
- Key number plate 114
- Keyless entry 119, 145
- Mechanical key 114
- Replacing the battery 558
- Warning buzzer 146
- Wireless remote control 116

Knee airbags 36

L

Lane Departure Alert (LDA) ... 275
 Operation 275
 Warning lights..... 578

Lane Tracing Assist (LTA)..... 270
 Operation 270
 Warning lights..... 579

Language (multi-information display)..... 97, 108

LATCH anchors 60

LDA (Lane Departure Alert) ... 275
 Operation 275
 Warning lights..... 578

Lever
 Auxiliary catch lever 528
 Hood lock release lever..... 528
 Shift lever 223
 Turn signal lever..... 226
 Wiper lever 241

License plate lights
 Light switch 234
 Replacing light bulbs 564

Light bulbs
 Replacing 563

Lights
 Automatic High Beam (AHB) 238
 Fog light switch 237
 Headlight switch 234
 Illuminated entry system 471
 Interior lights..... 469, 470
 Luggage compartment light 129, 136
 Personal lights..... 470
 Replacing light bulbs 564
 Turn signal lever..... 226
 Vanity lights 495
 Wattage 623

Welcome lighting 235

LTA (Lane Tracing Assist)..... 270
 Operation..... 270
 Warning lights..... 579

Luggage compartment features 478

Luggage compartment light 129, 136

M

Maintenance
 Do-it-yourself maintenance .. 526
 General maintenance 522
 Maintenance data 616
 Maintenance requirements... 520

Malfunction indicator lamp.... 577

Manual air conditioning system 454

Manual headlight leveling dial 236

Map display 104

Menu icons..... 91

Meter
 Clock 81, 85
 Indicators 78
 Instrument panel light control 84, 90
 Meter control switches.... 92, 101
 Meters 81, 85
 Multi-information display. 91, 100
 Settings 97, 108
 Warning lights..... 76, 576
 Warning messages..... 587

Mirrors
 Digital Rear-view Mirror..... 164
 Inside rear view mirror..... 162
 Outside rear view mirror defoggers 455, 462

Outside rear view mirrors 173
 Vanity mirrors 495

Mode select switch
 TOW HAUL switch 225

Moon roof 182

Multi-information display **91, 100**
 Audio system-linked display .94, 104
 Content display 100
 Cruise control 301
 Driving information display 92
 Driving support system information display 93, 103
 Dynamic radar cruise control 294
 Eco Driving Indicator 93, 103
 Fuel economy 92, 103
 Intuitive parking assist 323
 LDA (Lane Departure Alert) .. 279
 LTA (Lane Tracing Assist) 274
 Map display 104
 Menu icons 91
 Meter control switches ... 92, 101
 Navigation system-linked display 93, 104
 Settings 97, 108
 Stop & Start system information 98, 109
 Suggestion function 99, 109
 Tire pressure 541
 Vehicle information display 94
 Warning messages 587

Multi-terrain Monitor 399
 Automatic display mode 402
 Camera switch 399
 Function 400
 Menu button 400

Multi-terrain Monitor precautions 411
 Screen display and functions 402
 Things you should know 411

Multi-terrain Select 425

N

Navigation system-linked display 93, 104

O

Off-road precautions 445

Oil

Differential oil 621
 Engine oil 618
 Transfer oil 620

Open tray 476

Opener

Back door 129, 131
 Hood 528
 Opening the fuel tank cap 246

Outer foot lights 469

Outside rear view mirrors

Adjustment 173
 BSM (Blind Spot Monitor) 316
 Folding 174
 Mirror position memory 186
 Outside rear view mirror defoggers 455, 462
 RCTA (Rear Cross Traffic Alert) 330

Outside temperature 81, 85

Overheating 612

P

Panic mode 116

Panoramic view monitor.....363

 Camera switch 365

 Checking around the vehicle 368

 Checking the front and around the vehicle 370

 Checking the rear and around the vehicle 374

 Customizing the panoramic view monitor 383

 Display 367

 Driving precautions 363

 Magnifying function 383

 Menu button 366

 Panoramic view monitor precautions.....384

 Things you should know..... 396

Parking assist sensors (intuitive parking assist)..... 323

Parking brake227

 Brake system warning light ..576

 Parking brake engaged warning buzzer 229

 Warning light 581

 Warning message 229

Parking lights

 Light switch 234

Parking Support Brake (PKSB)339

 Enabling/disabling the system 341

PCS (Pre-Collision System)...259

 Enabling/disabling the system 269

 Function 259

 Warning light 578

PDA (Proactive driving assist)281

 Warning lights.....579

Personal lights.....469

PKSB (Parking Support Brake)339

 Enabling/disabling the system 341

 Moving Vehicle Rear of the Vehicle.....347

 Pedestrians Rear of the Vehicle 348

 Static Objects Front and Rear of the Vehicle.....344

Power back door.....130

Power back door switch 131

Power back window 180

Power easy access system ... 186

Power outlet.....490

Power running boards 124

Power steering (Electric power steering system)

 Warning light.....578

Power windows

 Catch protection function..... 177

 Door lock linked window operation..... 178

 Jam protection function 177

 Operation..... 177

 Window lock switch 179

Pre-Collision System (PCS)...259

 Enabling/disabling the system 269

 Function..... 259

 Warning light.....578

Proactive driving assist (PDA)281

R

- Radar cruise control** 301
- Radar cruise control (dynamic radar cruise control)** 290
- Radiator** 534
- RCD (Rear Camera Detection)** 335
 - Enabling/disabling the system 336
- RCTA (Rear Cross Traffic Alert)** 330
 - Enabling/disabling the system 331
- Rear Camera Detection (RCD)** 335
 - Enabling/disabling the system 336
- Rear Cross Traffic Alert (RCTA)** 330
 - Enabling/disabling the system 331
- Rear differential lock system** 421
- Rear seats** 152
 - Cleaning 517
 - Head restraints 158
- Rear turn signal lights** 226
 - Replacing light bulbs 564
 - Turn signal lever 226
- Rear view mirror**
 - Digital Rear-view Mirror 164
 - Inside rear view mirror 162
 - Outside rear view mirrors 173
- Rear window defogger**... 455, 462
- Rear window wiper** 243
- Refueling** 246
 - Capacity 617
 - Fuel types 617
 - Opening the fuel tank cap 246

- Removable speaker** 496
- Replacing**
 - Electronic key battery 558
 - Fuses 560
 - Light bulbs 563
- Road Sign Assist (RSA)** 288
- Roof luggage carrier** 202
- Roof rails** 202
- RSA (Road Sign Assist)** 288

S

- Safety Connect** 65
- SDM (Stabilizer with Disconnection Mechanism)** 436
- Seat belt reminder light**..... 583
- Seat belts**..... 31
 - Adjusting the seat belt shoulder anchor height..... 34
 - Automatic Locking Retractor .. 33
 - Child restraint system installation 53
 - Cleaning and maintaining the seat belt 517
 - Emergency Locking Retractor 33
 - How to wear your seat belt 32
 - How your child should wear the seat belt 32
 - Pregnant women, proper seat belt use 31
 - Reminder light and buzzer ... 583
 - Seat belt extender 32
 - Seat belt pretensioners 34
 - SRS warning light 577
- Seat heaters** 467
- Seat position memory** 186
- Seat ventilators**..... 467
- Seating capacity** 204, 616

Seats..... **151, 152**
 Adjustment 151, 152
 Adjustment precautions..... 152
 Child seats/child restraint system
 installation 51
 Cleaning 517
 Driving position memory 186
 Head restraints 158
 Power easy access system .. 186
 Properly sitting in the seat 29
 Seat heaters 467
 Seat position memory 186
 Seat ventilators 467
Second seats **152**
 Head restraints 158
Sensor
 Automatic headlight system . 235
 Automatic High Beam (AHB) 238
 BSM (Blind Spot Monitor)..... 317
 Digital Rear-view Mirror..... 167
 Dynamic radar cruise control 251
 Inside rear view mirror..... 163
 Intuitive parking assist..... 323
 LDA (Lane Departure Alert) .. 275
 LTA (Lane Tracing Assist)..... 270
 Parking Support Brake function
 (static objects) 323
 PCS (Pre-Collision System) . 251
 Radar sensor..... 251
 RCTA (Rear Cross Traffic Alert)
 317
Shift lever **223**
 Automatic transmission 222
 If the shift lever cannot be shifted
 from P..... 224
Shift lever light **469**
Shift lock system..... **224**
Side airbags..... **36**

Side marker lights
 Light switch..... 234
 Replacing light bulbs 564
Side mirrors
 Adjustment 173
 BSM (Blind Spot Monitor) 316
 Folding 174
 Heaters 462
 Mirror position memory 186
 RCTA (Rear Cross Traffic Alert)
 330
Side turn signal lights **226**
 Replacing light bulbs 564
 Turn signal lever 226
Side windows..... **177**
Smart key system **145**
 Antenna location..... 145
 Entry functions..... 119, 128
 Starting the engine 218
Snow tires **448**
Spare tire
 Inflation pressure 622
 Storage location 593
Spark plug **619**
Specifications **616**
Speedometer **81, 85**
Stabilizer with Disconnection
Mechanism (SDM)..... **436**
Steering wheel
 Adjustment 161
 Heated steering wheel..... 467
 Meter control switches... 92, 101
 Power easy access system .. 186
 Steering wheel position memory
 186
Stop & Start system **309**
 Function..... 309

- System information display ..98, 109
- Warning light 580
- Stop & Start system information display98, 109**
- Stop lights**
 - Replacing light bulbs 564
- Storage box476**
- Storage compartment479**
- Storage features472**
- Storage hook477**
- Stuck**
 - If the vehicle becomes stuck 614
- Suggestion function.....99, 109**
- Sun visors.....495**
- Switches**
 - Automatic High Beam switch 238
 - Brake Hold switch 231
 - Cruise control 301
 - DAC/CRAWL switch 422, 428
 - Door lock switches 122
 - DRIVE MODE switch 412
 - Driving position memory switches 186
 - Dynamic radar cruise control 294
 - Emergency flashers switch ..568
 - Engine switch218
 - Fog light switch237
 - Front-wheel drive control switch414, 417
 - Garage door opener switches504
 - Heated steering wheel switch467
 - Light switches.....234
 - LTA (Lane Tracing Assist) switch273
 - Meter control switches....92, 101
 - Mode select switch412, 422, 425, 426, 428
 - Moon roof switches 182
 - MTS switch425, 426
 - Outside rear view mirror switches.....173
 - Parking brake switch227
 - Personal/interior lights main switch470
 - Power back door switch 131
 - Power door lock switch..... 122
 - Power steps switch..... 126
 - Power window switches 177
 - Rear differential lock system 421
 - Rear window and outside rear view mirror defoggers switch462
 - Rear window wiper and washer switch243
 - SDM switch436
 - Seat heater switches467
 - Seat ventilator switches.....467
 - “SOS” button65
 - Stabilizer with Disconnection Mechanism switch436
 - Stop & Start cancel switch....310
 - Tilt and telescopic steering control switch 161
 - Tire pressure warning reset switch544
 - TOW HAUL switch.....225
 - Trailer brake control switch...437
 - Trailer hitch light switch470
 - Vehicle-to-vehicle distance switch294
 - VSC OFF switch432
 - Window lock switch 179

- Windshield defogger switch . 462
- Windshield wiper and washer switch 241
- Windshield wiper de-icer switch 457, 465

T

Tail lights

- Light switch 234
- Replacing light bulbs 564

TDA (Trailer Driving Assist) ... 308

The Secondary Collision Brake 432

Theft deterrent system

- Alarm 71
- Immobilizer system 70

Third seats 152

- Head restraints 158

Ticket holders 478

Tire inflation pressure..... 94, 105, 553

- Maintenance data 622
- Tire inflation pressure display function..... 541
- Warning light 582

Tire information 626

- Glossary 630
- Size 628
- Tire identification number 627
- Uniform Tire Quality Grading 629

Tire pressure display 541

Tire pressure warning system

- 541
- Function 541
- Installing tire pressure warning valves and transmitters 544
- Registering ID codes 549

- Registration of the position of each wheel 544
- Selecting wheel set 551
- Setting the tire pressure 546
- Warning light 582

Tires 539

- Chains 450
- Checking 539
- If you have a flat tire 593
- Inflation pressure 553
- Information 626
- Replacing 593
- Rotating tires 541
- Size 622
- Snow tires 448
- Tire inflation pressure display function 541
- Tire pressure warning system 541
- Warning light 582

Tools 593

Top tether strap 63

TOW HAUL switch 225

Towing

- Dinghy towing 217
- Emergency towing 571
- Trailer Backup Guide 440
- Trailer towing 205

Toyota parking assist monitor

- 350
- Distance guide line display mode 355
- Driving precautions 350
- Estimated course line display mode 353
- Parking assist guide line display mode 354

Screen display..... 351
 Things you should know..... 361
 Toyota parking assist monitor
 precautions..... 355
 Using the system..... 352
Toyota Safety Sense 3.0250
 Automatic High Beam (AHB) 238
 Dynamic radar cruise control 290
 Emergency Driving Stop System
 305
 LDA (Lane Departure Alert) ..275
 LTA (Lane Tracing Assist).....270
 PCS (Pre-Collision System) .259
 PDA (Proactive driving assist)
 281
 RSA (Road Sign Assist)288
 TDA (Trailer Driving Assist) ..308
 Toyota Safety Sense 3.0 Soft-
 ware update 248
**Toyota Safety Sense 3.0 Software
 update248**
TRAC (Traction Control) 431
Traction Control (TRAC) 431
Traction monitor display..94, 105
Trailer Backup Guide 440
 Canceling the system..... 443
 Precautions 444
 Procedure..... 440
 Setup (Calibration) 441
 Trailer hitch light 444
 Using Guidance mode..... 443
 Using Straight Path Assist.... 443
Trailer brake94, 106, 437
Trailer brake controller437
Trailer Driving Assist 308
Trailer hitch light444, 469
 Replacing light bulbs 564
Trailer Mode BSM94, 106

Trailer Settings screen96, 105
Trailer Sway Control.....431
Trailer towing205
 TDA (Trailer Driving Assist) ..308
 Trailer Backup Guide440
 Trailer Driving Assist.....308
Transfer620
Transmission
 Automatic transmission222
**Transmission oil temperature
 gauge94, 107**
Turn signal lights226
 Replacing light bulbs564
 Turn signal lever226

U

USB Type-C charging port.....480

V

Vanity lights495
Vanity mirrors495
Vehicle data recording7
Vehicle identification number616
Vehicle information display94
Ventilators (seat ventilators) .467
Voltmeter94, 107

W

Warning buzzers

Acceleration Suppression at Low
 Speed262
 Approach warning297
 Brake hold581
 Brake Override System581
 Brake system.....576
 Break suggestion function278

BSM (Blind Spot Monitor).....	579
Charging system	577
Downshifting.....	225
Drive-Start Control	581
Electric power steering.....	578
Engine	577
Hands off steering wheel warn- ing (LDA).....	277
Hands off steering wheel warn- ing (LTA).....	272
Intuitive parking assist.....	580
LDA (Lane Departure Alert) 275, 578, 579	
Low engine oil pressure	577
LTA (Lane Tracing Assist)... 270, 579	
Open door	120, 122
Open window	178
PCS (Pre-Collision System) .	578
PKSB (Parking Support Brake)	579
Pre-collision warning	260
RCD (Rear Camera Detection)	579
RCTA (Rear Cross Traffic Alert)	330, 579
Seat belt.....	583
SRS airbag.....	577
Warning lights	76, 576
ABS	578
Brake hold operated indicator	581
Brake Override System	581
Brake system	576
Charging system	577
Cruise control	580
Drive-Start Control	581
Dynamic radar cruise control	579
Electric power steering.....	578
High coolant temperature	576
High speed four-wheel drive indi- cator	582
Intuitive parking assist OFF indi- cator	580
LDA indicator	578
Low engine oil pressure	577
Low fuel level.....	583
Low speed four-wheel drive indi- cator	582
LTA indicator	579
Malfunction indicator lamp....	577
Parking brake indicator.....	581
PCS (Pre-Collision system) ..	579
PDA (Proactive driving assist)	579
Pre-collision system	578
Rear differential lock indicator	582
Seat belt reminder light	583
Slip indicator.....	580
SRS airbag	577
Stop & Start cancel indicator	580
Tire pressure	582
Trailer brake warning light	584
Warning messages	587
Washer	
Adding	538
Preparing and checking before winter	448
Switch.....	241, 243
Washing and waxing	514
Weight	
Cargo capacity	204
Load limits	204
Wheel lock nut	595
Wheels	555
Replacing	555
Size	622

Wheel lock nut..... 595

Window glasses

 Power windows 177

Window lock switch 179

Windows

 Power back window 180

 Power windows 177

 Rear window defogger . 455, 462

 Washer 241, 243

Windshield defogger..... 462

Windshield wipers..... 241

Winter driving tips..... 448

Wireless charger 481

Wireless remote control 116

 Battery-Saving Function 146

 Locking/Unlocking 116

 Replacing the battery 558

For information regarding the equipment listed below, refer to the "MULTIMEDIA OWNER'S MANUAL".

- Navigation system
- Audio/visual system



Certifications

Safety Connect

FCC ID : BEJTL21BNN

This device complies with part 15 of the FCC Rules and RSS-Gen of IC Rules.

Operation is subject to the following two conditions:

- (1) This device may not cause harmful interference, and
- (2) this device must accept any interference received, including interference that may cause undesired operation.

Changes or modifications not expressly approved by the manufacturer (or party responsible) for compliance could void the user's authority to operate the equipment.

This equipment complies with FCC RF Radiation exposure limits set forth for an uncontrolled environment. This device and its antenna must not be co-located or operating in conjunction with any other antenna or transmitter. This equipment should be installed and operated with a minimum distance of 20 cm between the radiator and your body

IC : 2703H-TL21BNN

IC Radiation Exposure Statement:

This equipment complies with IC radiation exposure limits set forth for an uncontrolled environment.

This equipment should be installed and operated with minimum distance 20 cm between the radiator & your body.

Operation is subject to the following two conditions:

- (1) This device may not cause interference.
- (2) This device must accept any interference, including interference that may cause undesired operation of the device.

NOTE: THE MANUFACTURER IS NOT RESPONSIBLE FOR ANY RADIO OR TV INTERFERENCE CAUSED BY UNAUTHORIZED MODIFICATIONS TO THIS EQUIPMENT. SUCH MODIFICATIONS COULD VOID THE USER'S AUTHORITY TO OPERATE THE EQUIPMENT.

IC : 2703H-TL21BNN

Avis d'Industrie Canada sur l'exposition aux rayonnements

Cet appareil est conforme aux limites d'exposition aux rayonnements d'Industrie Canada pour un environnement non contrôlé.

Il doit être installé de façon à garder une distance minimale de 20 centimètres entre la source de rayonnements et votre corps.

L'exploitation est autorisée aux deux conditions suivantes :

- 1.L'appareil ne doit pas produire de brouillage;
- 2.L'appareil doit accepter tout brouillage radioélectrique subi, même si le brouillage est susceptible d'en compromettre le fonctionnement.

REMARQUE: LE FABRICANT N'EST PAS RESPONSABLE DES INTERFÉRENCES RADIOÉLECTRIQUES CAUSÉES PAR DES MODIFICATIONS NON AUTORISÉES APPORTÉES À CET APPAREIL. DE TELLES MODIFICATIONS POURRAIT ANNULER L'AUTORISATION ACCORDÉE À L'UTILISATEUR DE FAIRE FONCTIONNER L'APPAREIL.

Smart key system and Engine immobilizer system

- For vehicles sold in the U.S.A., Hawaii, Guam, Puerto Rico, A.Samoa and Saipan

FCC ID: NI4TMLF19D-3

US

NOTE

This device complies with part 15 of the FCC Rules. Operation is subject to the following two conditions: (1) This device may not cause harmful interference, and (2) this device must accept any interference received, including interference that may cause undesired operation.

FCC WARNING

Changes or modifications not expressly approved by the party responsible for compliance could void the user's authority to operate the equipment.

93

► For vehicles sold in Canada

NOTE

CA

This device contains licence-exempt transmitter(s)/receiver(s) that comply with Innovation, Science and Economic Development Canada's licence-exempt RSS(s). Operation is subject to the following two conditions:

- (1) This device may not cause interference.
- (2) This device must accept any interference, including interference that may cause undesired operation of the device.

811

NOTE

CA

L'émetteur/récepteur exempt de licence contenu dans le présent appareil est conforme aux CNR d'Innovation, Sciences et Développement économique Canada applicables aux appareils radio exempts de licence. L'exploitation est autorisée aux deux conditions suivantes:

- (1) L'appareil ne doit pas produire de brouillage;
- (2) L'appareil doit accepter tout brouillage radioélectrique subi, même si le brouillage est susceptible d'en compromettre le fonctionnement.

811

Digital key

- ▶ For vehicles sold in the U.S.A., Hawaii and Puerto Rico

US

FCC ID:HYQ17EAD

NOTE

This device complies with part 15 of the FCC Rules. Operation is subject to the following two conditions: (1) This device may not cause harmful interference, and (2) this device must accept any interference received, including interference that may cause undesired operation.

FCC WARNING

Changes or modifications not expressly approved by the party responsible for compliance could void the user's authority to operate the equipment.

CAUTION : Radio Frequency Radiation Exposure

This equipment complies with FCC radiation exposure limits set forth for an uncontrolled environment and meets the FCC radio frequency (RF) Exposure Guidelines. This equipment should be installed and operated keeping the radiator at least 20cm or more away from person's body.

Co-location: This transmitter must not be co-located or operated in conjunction with any other antenna or transmitter.

00

► For vehicles sold in Canada

CA

This device contains licence-exempt transmitter(s)/receiver(s) that comply with Innovation, Science and Economic Development Canada's licence-exempt RSS(s). Operation is subject to the following two conditions:

- (1) This device may not cause interference.
- (2) This device must accept any interference, including interference that may cause undesired operation of the device.

The antenna cannot be removed (and changed) by user.

Co-location: This transmitter must not be co-located or operated in conjunction with any other antenna or transmitter.

CAUTION: Radio Frequency Radiation Exposure

This equipment complies with ISED radiation exposure limits set forth for an uncontrolled environment and meets RSS-102 of the ISED radio frequency (RF) Exposure rules. This equipment should be installed and operated keeping the radiator at least 20 cm or more away from person's body.

02

L'émetteur/récepteur exempt de licence contenu dans le présent appareil est conforme aux CNR d'Innovation, Sciences et Développement économique Canada applicables aux appareils radio exempts de licence. L'exploitation est autorisée aux deux conditions suivantes :

- (1) L'appareil ne doit pas produire de brouillage;
- (2) L'appareil doit accepter tout brouillage radioélectrique subi, même si le brouillage est susceptible d'en compromettre le fonctionnement.

L'utilisateur n'est pas autorisé à retirer (ou modifier) l'antenne.

Emplacement : Cet émetteur ne doit pas être installé ou utilisé conjointement avec d'autres antennes ou émetteurs.

ATTENTION : exposition aux radiofréquences

Cet équipement est conforme aux limites d'exposition aux rayonnements d'ISDE établies pour un environnement non contrôlé ainsi que la norme CNR-102 de la réglementation d'ISDE relative à l'exposition aux radiofréquences (RF). Cet équipement doit être installé et utilisé avec un minimum de 20 cm de distance entre la source de rayonnement et le corps.

Smart key system

- ▶ For vehicles sold in the U.S.A., Hawaii, Guam, Puerto Rico, A.Samoa and Saipan

US

FCC ID:HYQ23ABN
FCC ID:HYQ14FBW
FCC ID:HYQ14FBX

NOTE:

This device complies with part 15 of the FCC Rules. Operation is subject to the following two conditions: (1) This device may not cause harmful interference, and (2) this device must accept any interference received, including interference that may cause undesired operation.

FCC WARNING:

Changes or modifications not expressly approved by the party responsible for compliance could void the user's authority to operate the equipment.

<For 14FBW/14FBX>

The FCC ID is affixed inside the equipment. You can find the ID when replacing the battery.

00

► For vehicles sold in Canada

CA

NOTE:

This device contains licence-exempt transmitter(s)/receiver(s) that comply with Innovation, Science and Economic Development Canada's licence-exempt RSS(s).

Operation is subject to the following two conditions:

- (1) This device may not cause interference.
- (2) This device must accept any interference, including interference that may cause undesired operation of the device.

<For 14FBW/14FBX>

The IC Certification number is affixed inside the equipment. You can find the number when replacing the battery.

02

CA

NOTE:

L'émetteur/récepteur exempt de licence contenu dans le présent appareil est conforme aux CNR d'Innovation, Sciences et Développement économique Canada applicables aux appareils radio exempts de licence.

L'exploitation est autorisée aux deux conditions suivantes :

- (1) L'appareil ne doit pas produire de brouillage;
- (2) L'appareil doit accepter tout brouillage radioélectrique subi, même si le brouillage est susceptible d'en compromettre le fonctionnement.

<Pour 14FBW/14FBX>

Le numéro d'accréditation IC est apposé à l'intérieur de l'appareil. Ce numéro est visible au remplacement de la pile.

03

Smart ECU/antenna

- ▶ For vehicles sold in the U.S.A., Hawaii, Guam, Puerto Rico, A.Samoa and Saipan

FCC ID: NI4TMLF19T-2

This device complies with part 15 of the FCC Rules. Operation is subject to the following two conditions: (1) This device may not cause harmful interference, and (2) this device must accept any interference received, including interference that may cause undesired operation.

This transmitter must not be co-located or operated in conjunction with any other antenna or transmitter.

This equipment complies with FCC radiation exposure limits set forth for an uncontrolled environment and meets the FCC radio frequency (RF) Exposure Guidelines as this equipment has very low levels of RF energy.

Changes or modifications not expressly approved by the party responsible for compliance could void the user's authority to operate the equipment.

- ▶ For vehicles sold in Canada

This device contains licence-exempt transmitter(s)/receiver(s) that comply with Innovation, Science and Economic Development Canada's licence-exempt RSS(s). Operation is subject to the following two conditions:

(1) This device may not cause interference.

(2) This device must accept any interference, including interference that may cause undesired operation of the device.

L'émetteur/récepteur exempt de licence contenu dans le présent appareil est conforme aux CNR d'Innovation, Sciences et Développement économique Canada applicables aux appareils radio exempts de licence. L'exploitation est autorisée aux deux conditions suivantes :

1) L'appareil ne doit pas produire de brouillage;

2) L'appareil doit accepter tout brouillage radioélectrique subi, même si le brouillage est susceptible d'en compromettre le fonctionnement.

Toyota Safety Sense 3.0

- ▶ For vehicles sold in the U.S.A., Hawaii, Guam, Puerto Rico, A.Samoa and Saipan

FCC ID: HYQDNMWR011

D11 US 01

NOTE:

This device complies with part 15 of the FCC Rules. Operation is subject to the following two conditions: (1) This device may not cause harmful interference, and (2) this device must accept any interference received, including interference that may cause undesired operation.

FCC WARNING:

Changes or modifications not expressly approved by the party responsible for compliance could void the user's authority to operate the equipment.

US 01

Radiofrequency radiation exposure Information:

This equipment complies with FCC radiation exposure limits set forth for an uncontrolled environment. This equipment should be installed and operated with minimum distance of 20 cm between the radiator (antenna) and your body. This transmitter must not be co-located or operating in conjunction with any other antenna or transmitter.

US 02

- ▶ For vehicles sold in Canada

NOTE:

This device contains licence-exempt transmitter(s)/receiver(s) that comply with Innovation, Science and Economic Development Canada's licence-exempt RSS(s). Operation is subject to the following two conditions:

- (1) This device may not cause interference.
- (2) This device must accept any interference, including interference that may cause undesired operation of the device.

This equipment complies with ISED radiation exposure limits set forth for an uncontrolled environment and meets RSS-102 of the ISED radio frequency (RF) Exposure rules. This equipment should be installed and operated keeping the radiator at least 20 cm or more away from person's body.

CA 01

NOTE:

L'émetteur/récepteur exempt de licence contenu dans le présent appareil est conforme aux CNR d'Innovation, Sciences et Développement économique Canada applicables aux appareils radio exempts de licence. L'exploitation est autorisée aux deux conditions suivantes :

- (1) L'appareil ne doit pas produire de brouillage;
- (2) L'appareil doit accepter tout brouillage radioélectrique subi, même si le brouillage est susceptible d'en compromettre le fonctionnement.

Cet équipement est conforme aux limites d'exposition aux rayonnements énoncées pour un environnement non contrôlé et respecte les règles d'exposition aux fréquences radioélectriques (RF) CNR-102 de l'ISDE. Cet équipement doit être installé et utilisé en gardant une distance de 20 cm ou plus entre le dispositif rayonnant et le corps.

CA 02

BSM (Blind Spot Monitor)

- For vehicles sold in the U.S.A., Hawaii, Guam, Puerto Rico, A.Samoa and Saipan

FCC ID : OAYSRR3A

This device complies with part 15 of the FCC Rules. Operation is subject to the following two conditions:

- (1) This device may not cause harmful interference, and
- (2) this device must accept any interference received, including interference that may cause undesired operation.

FCC Warning

Changes or modifications not expressly approved by the party responsible for compliance could void the user's authority to operate the equipment.

C3-002

► For vehicles sold in Canada

This device contains licence-exempt transmitter(s)/receiver(s) that comply with Innovation, Science and Economic Development Canada's licence-exempt RSS(s). Operation is subject to the following two conditions:

1. This device may not cause interference.
2. This device must accept any interference, including interference that may cause undesired operation of the device.

Radiofrequency radiation exposure information:

This equipment complies with radiation exposure limits set forth for an uncontrolled environment. This equipment should be installed and operated with minimum distance of 20 cm between the radiator and your body.

C3-005

L'émetteur/récepteur exempt de licence contenu dans le présent appareil est conforme aux CNR d'Innovation, Sciences et Développement économique Canada applicables aux appareils radio exempts de licence. L'exploitation est autorisée aux deux conditions suivantes:

1. L'appareil ne doit pas produire de brouillage;
2. L'appareil doit accepter tout brouillage radioélectrique subi, même si le brouillage est susceptible d'en compromettre le fonctionnement.

Informations sur l'exposition aux rayonnements radiofréquences:

Cet équipement est conforme aux limites d'exposition aux rayonnements définies pour un environnement non contrôlé. Cet équipement doit être installé et utilisé avec un minimum de 20 cm de distance entre la source de rayonnement et votre corps.

C3-006

Intuitive parking assist

- ▶ For vehicles sold in the U.S.A., Hawaii, Guam, Puerto Rico, A.Samoa and Saipan

Product name : Intuitive parking assist

Compliance statement : This device complies with part 18 of the FCC Rules.

Responsible Party : DENSO International America, Inc.

24777 Denso Drive, Southfield Michigan 48033 U.S.A.

<https://www.denso.com/us-ca/en/about-us/company-information/us/diam/>

- ▶ For vehicles sold in Canada

This ISM device complies with Canadian ICES-001.

Cet appareil ISM est conforme à la norme NMB-001 du Canada.

Wireless charger

- ▶ For vehicles sold in the U.S.A., Hawaii, Guam, Puerto Rico, A.Samoa and Saipan

FCC ID : ACJ932AT2301

NOTE:

This device complies with part 15 and part 18 of the FCC Rules. Operation is subject to the following two conditions: (1) This device may not cause harmful interference, and (2) this device must accept any interference received, including interference that may cause undesired operation.

FCC CAUTION

Changes or modifications not expressly approved by the party responsible for compliance could void the user's authority to operate the equipment. This equipment has been tested and found to comply with the limits for a wireless power charger, pursuant to part 18 of the FCC Rules. This equipment generates, uses and can radiate radio frequency energy and,

if not installed and used in accordance with the instructions, may cause harmful interference to radio communications. However, there is no guarantee that interference will not occur in a particular installation. If this equipment does cause harmful interference to radio communications, which can be determined by turning the equipment off and on, the user is encouraged to try to correct the interference by one or more of the following measures:

- Reorient or relocate the receiving antenna.

- Increase the separation between the equipment and receiver.

- Connect the equipment into an outlet on a circuit different from that to which the receiver is connected.

This equipment complies with FCC radiation exposure limits set forth for an uncontrolled environment and meets the FCC radio frequency (RF) Exposure Guidelines. This equipment should be installed and operated keeping the radiator at least 20cm or more away from person's body.

► For vehicles sold in Canada

NOTE:

This device contains licence-exempt transmitter(s)/receiver(s) that comply with Innovation, Science and Economic Development Canada's licence-exempt RSS(s). Operation is subject to the following two conditions: (1) This device may not cause interference. (2) This device must accept any interference, including interference that may cause undesired operation of the device.

L'émetteur/récepteur exempt de licence contenu dans le présent appareil est conforme aux CNR d'Innovation, Sciences et Développement économique Canada applicables aux appareils radio exempts de licence. L'exploitation est autorisée aux deux conditions suivantes :

- 1) L'appareil ne doit pas produire de brouillage;
- 2) L'appareil doit accepter tout brouillage radioélectrique subi, même si le brouillage est susceptible d'en compromettre le fonctionnement.

CAUTION:

This equipment complies with ISED radiation exposure limits set forth for an uncontrolled environment and meets RSS-102 of the ISED radio frequency (RF) Exposure rules. This equipment should be installed and operated keeping the radiator at least 20cm or more away from person's body.

Cet équipement est conforme aux limites d'exposition aux rayonnements énoncées pour un environnement non contrôlé et respecte les règles d'exposition aux fréquences radioélectriques (RF) CNR-102 de l'ISDE. Cet équipement doit être installé et utilisé en gardant une distance de 20 cm ou plus entre le radiateur et le corps humain.

Removable speaker

- ▶ For vehicles sold in the U.S.A., Hawaii, Guam, Puerto Rico, A.Samoa and Saipan

To view the regulatory information for the speaker please remove the rear grille of the speaker.

FCC ID: 2AHPN-FLEX1G

This device complies with part 15 of the FCC Rules. Operation is subject to the following two conditions:

(1) This device may not cause harmful interference, and (2) this device must accept any interference received, including interference that may cause undesired operation.

This device must not be co-located or operating in conjunction with any other antenna or transmitter.

WARNING: Any Changes or modifications to this unit not expressly approved by the party responsible for compliance could void the user's authority to operate the equipment.

Note: This equipment has been tested and found to comply with the limits for a Class B digital device, pursuant to part 15 of the FCC Rules. These limits are designed to provide reasonable protection against harmful interference in a residential installation. This equipment generates, uses and can radiate radio frequency energy and, if not installed and used in accordance with the instructions, may cause harmful interference to radio communications.

However, there is no guarantee that interference will not occur in a particular installation. If this equipment does cause harmful interference to radio or television reception, which can be determined by turning the equipment off and on, the user is encouraged to try to correct the interference by one or more of the following measures:

- Reorient or relocate the receiving antenna.
- Increase the separation between the equipment and receiver.
- Connect the equipment into an outlet on a circuit different from that to which the receiver is connected.
- Consult the dealer or an experienced radio/TV technician for help.

The device has been evaluated to meet general RF exposure requirement.

The device can be used in portable exposure condition without restriction.

This device complies with FCC's radiation exposure limits set forth for an uncontrolled environment.



CSXXXXX
Energy Efficiency
Verified

► For vehicles sold in Canada

To view the regulatory information for the speaker please remove the rear grille of the speaker.

IC: 6434C-FLEX1G

This device contains licence-exempt transmitter(s)/receiver(s) that comply with Innovation, Science and Economic Development Canada's licence-exempt RSS(s). This device complies with Industry Canada license-exempt RSS standard(s). Operation is subject to the following two conditions:

- (1) This device may not cause interference.
- (2) This device must accept any interference, including interference that may cause undesired operation of the device.

Pour consulter les informations réglementaires pour le haut-parleur, veuillez retirer la calandre arrière du haut-parleur.

Le présent appareil est conforme aux CNR d'Industrie Canada applicables aux appareils radio exempts de licence. Le présent appareil est conforme aux CNR d'Industrie Canada applicables aux appareils radio exempts de licence.

L'exploitation est autorisée aux deux conditions suivantes:

- (1) l'appareil ne doit pas produire de brouillage, et
- (2) l'utilisateur de l'appareil doit accepter tout brouillage radioélectrique subi, même si le

brouillage est susceptible d'en compromettre le fonctionnement.

This Class B digital apparatus complies with Canadian ICES-003.

Cet appareil numérique de la classe B est conforme à la norme NMB-003 du Canada. CAN ICES-003 (B)/NMB-003(B)

Radiation Exposure Statement: The product complies with the Canada portable RF exposure limit set forth for an uncontrolled environment and are safe for intended operation as described in this manual.

Déclaration d'exposition aux radiations: Le produit est conforme aux limites d'exposition pour les appareils portables RF pour les Etats-Unis et le Canada établies pour un environnement non contrôlé.

This equipment complies with IC RSS-102 radiation exposure limits set forth for an uncontrolled environment. This equipment should be installed and operated with minimum distance 20cm between the radiator & your body. Cet équipement est conforme aux limites d'IC RSS-102 sur l'exposition aux radiations qui sont déterminées pour un environnement non contrôlé. Cet équipement doit être installé et utilisé en observant une distance minimum de 20 cm entre la source du rayonnement et votre corps.

Exposure of humans to RF fields (RSS-102)

The radiated energy from the antennas connected to the wireless adapters conforms to the IC limit of the RF exposure requirement regarding IC RSS-102, Issue 5 clause 4. SAR tests are conducted using recommended operating positions accepted by the RSS with the device transmitting at its highest certified power level in all tested frequency band without distance attaching away from the body.

Conformité des appareils de radiocommunication aux limites d'exposition humaine aux radiofréquences (CNR-102)

L'énergie émise par les antennes reliées aux cartes sans fil respecte la limite d'exposition aux radiofréquences telle que définie par Industrie Canada dans la clause 4.1 du document CNR-102, version 5. Tests DAS sont effectués en utilisant les positions recommandées par la CNR avec le téléphone émet à la puissance certifiée maximale dans toutes les bandes de fréquences testées sans distance attacher loin du corps.

CAN ICES-3 (B)/NMB-3(B)



► For vehicles sold in the EU

Hereby, Harman International Industries Inc., declares that these TOYOTA JBL FLEX speaker and Flex Dock are in compliance with the essential requirements and other relevant provisions of Directive 2014/53/EU.

SIMPLIFIED EU DECLARATION OF CONFORMITY

2402MHz ~ 2480MHz Max output power: 8.09dBm

We, Harman International Industries Inc., declare under our sole responsibility that the products, to which this declaration relates, are in conformity with EMC Directive 2014/30/EU.

WEEE Notice



The Directive 2012/19/EU on Waste Electrical and Electronic Equipment (WEEE), which entered into force as European law on 14/02/2014, resulted in a major change in the treatment of electrical equipment at end-of-life. The purpose of this Directive is, as a first priority, the prevention of WEEE, and in addition, to promote the reuse, recycling and other forms of recovery of such wastes so as to reduce disposal. The WEEE logo on the product or on its box indicating collection for electrical and electronic equipment consists of the crossed-out wheeled bin, as shown below.

This product must not be disposed of or dumped with your other household waste. You are liable to dispose of all your electronic or electrical waste equipment by relocating over to the specified collection point for recycling of such hazardous waste. Isolated collection and proper recovery of your electronic and electrical waste equipment at the time of disposal will allow us to help conserving natural resources. Moreover, proper recycling of the electronic and electrical waste equipment will ensure safety of human health and environment. For more information about electronics and electrical waste equipment disposal, recovery, and collection points, please contact your local city center, household waste disposal service, shop from where you purchased the equipment, or manufacturer of the equipment.

RoHS Compliance This product is in compliance with Directive 2011/65/EU and (EU) 2015/863 of the European Parliament and of the Council of 31/03/2015 on the restriction of the use of certain hazardous substances in electrical and electronic equipment.

Garage door opener

► For vehicles sold in the U.S.A. and Hawaii

This device complies with FCC rules part 15 and Innovation, Science, and Economic Development Canada RSS-210. Operation is subject to the following two conditions: (1) This device may not cause harmful interference, and (2) This device must accept any interference that may be received including interference that may cause undesired operation. WARNING: The transmitter has been tested and complies with FCC and ISSED rules. Changes or modifications not expressly approved by the party responsible for compliance could void the user's authority to operate the device.

This equipment complies with FCC and ISSED radiation exposure limits set forth for an uncontrolled environment. End Users must follow the specific operating instructions for satisfying RF exposure compliance. This transmitter must be at least 20 cm from the user and must not be co-located or operating in conjunction with any other antenna or transmitter.

► For vehicles sold in Canada

This device complies with FCC rules part 15 and Innovation, Science, and Economic Development Canada RSS-210. Operation is subject to the following two conditions: (1) This device may not cause harmful interference, and (2) This device must accept any interference that may be received including interference that may cause undesired operation. WARNING: The transmitter has been tested and complies with FCC and ISSED rules. Changes or modifications not expressly approved by the party responsible for compliance could void the user's authority to operate the device.

This equipment complies with FCC and ISSED radiation exposure limits set forth for an uncontrolled environment. End Users must follow the specific operating instructions for satisfying RF exposure compliance. This transmitter must be at least 20 cm from the user and must not be co-located or operating in conjunction with any other antenna or transmitter.

Cet appareil est conforme aux règlements de la FCC, section 15, et au CNR-210 d'Innovation, Sciences et Développement économique Canada. Le fonctionnement est assujéti aux deux conditions suivantes : (1) cet appareil ne doit pas causer d'interférences nuisibles et (2) cet appareil doit accepter toute interférence reçue, y compris celle qui pourrait entraîner un dysfonctionnement. MISE EN GARDE : L'émetteur a subi des tests et est conforme aux règlements de la FCC et d'ISDE. Les changements ou modifications non approuvés explicitement par la partie responsable de la conformité pourraient rendre caduque l'autorisation de l'utilisateur de se servir du dispositif.

Cet appareil est conforme aux limites d'exposition aux radiations de la FCC et d'ISDE établies pour un environnement non contrôlé. Les utilisateurs finaux doivent respecter les instructions d'utilisation spécifiques pour satisfaire aux exigences de conformité aux expositions de RF. L'émetteur doit se trouver à 20 cm au minimum de l'utilisateur et ne doit pas être situé au même endroit que tout autre émetteur ou antenne ni fonctionner avec un autre émetteur ou antenne.

Tire pressure warning system

“Perchlorate Material – special handling may apply, See www.dtsc.ca.gov/hazardouswaste/perchlorate.”

-
- ▶ For vehicles sold in the U.S.A., Hawaii, Guam, Puerto Rico and Saipan

FCC ID: PAXPMVG001

NOTE

This device complies with part 15 of the FCC Rules.

Operation is subject to the following two conditions:

- (1) This device may not cause harmful interference, and
- (2) this device must accept any interference received, including interference that may cause undesired operation.

FCC WARNING

Changes or modifications not expressly approved by the party responsible for compliance could void the user's authority to operate the equipment.

FCC ID: PAXPMVG101

NOTE

This device complies with part 15 of the FCC Rules.

Operation is subject to the following two conditions:

- (1) This device may not cause harmful interference, and
- (2) this device must accept any interference received, including interference that may cause undesired operation.

FCC WARNING

Changes or modifications not expressly approved by the party responsible for compliance could void the user's authority to operate the equipment.

► For vehicles sold in Canada

NOTE

This device contains licence-exempt transmitter(s)/ receiver(s) that comply with Innovation, Science and Economic Development Canada's licence-exempt RSS(s).

Operation is subject to the following two conditions:

- (1) This device may not cause interference.
- (2) This device must accept any interference, including interference that may cause undesired operation of the device.

NOTE

L'émetteur/récepteur exempt de licence contenu dans le présent appareil est conforme aux CNR d'Innovation, Sciences et Développement économique Canada applicables aux appareils radio exempts de licence.

L'exploitation est autorisée aux deux conditions suivantes :

- (1) L'appareil ne doit pas produire de brouillage;
- (2) L'appareil doit accepter tout brouillage radioélectrique subi, même si le brouillage est susceptible d'en compromettre le fonctionnement.

GAS STATION INFORMATION

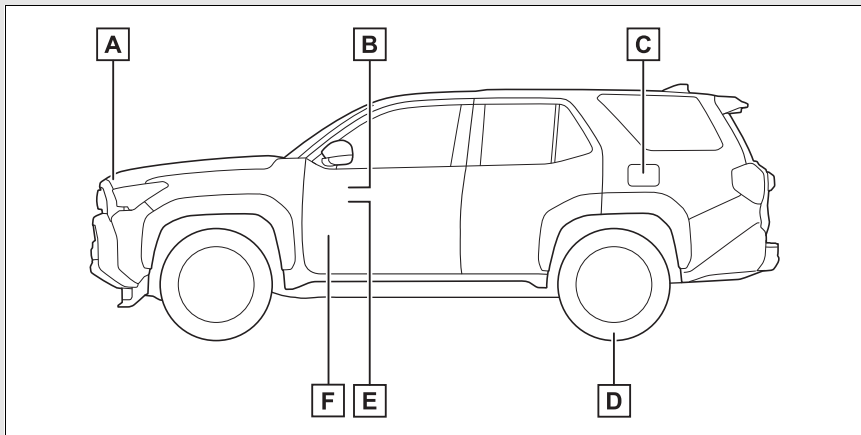

- A** Auxiliary catch lever (→P.528)
- B** Fuel filler door opener (→P.247)
- C** Fuel filler door (→P.247)
- D** Tire inflation pressure (→P.622)
- E** Power back door switch* (→P.130)
- F** Hood lock release lever (→P.528)

*: If equipped

Fuel tank capacity (Reference)	P.617
Fuel type	P.617
Cold tire inflation pressure	P.622
Engine oil capacity (Drain and refill — reference)	P.618
Engine oil type	P.618