

# 2024 LINCOLN NAUTILUS Owner's Manual

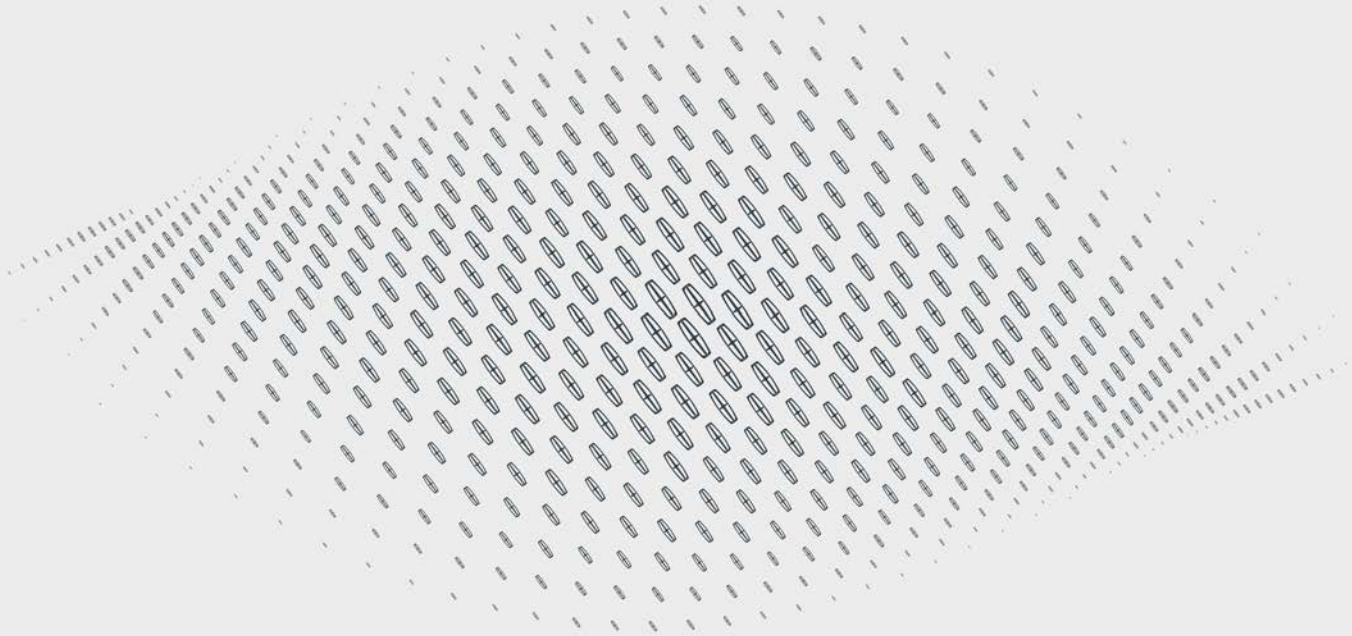



The information contained in this publication was correct at the time of release. In the interest of continuous development, we reserve the right to change specifications, design or equipment at any time without notice or obligation. No part of this publication may be reproduced, transmitted, stored in a retrieval system or translated into any language in any form by any means without our written permission. Errors and omissions excepted.

© Ford Motor Company 2023

All rights reserved.

Part Number: -202310-20231101175525

## California Proposition 65



**WARNING:** Operating, servicing and maintaining a passenger vehicle or off-highway motor vehicle can expose you to chemicals including engine exhaust, carbon monoxide, phthalates, and lead, which are known to the State of California to cause cancer and birth defects or other reproductive harm. To minimize exposure, avoid breathing exhaust, do not idle the engine except as necessary, service your vehicle in a well-ventilated area and wear gloves or wash your hands frequently when servicing your vehicle. For more information go to [www.P65Warnings.ca.gov/passenger-vehicle](http://www.P65Warnings.ca.gov/passenger-vehicle).



**WARNING:** Battery posts, terminals and related accessories contain lead and lead compounds, chemicals known to the State of California to cause cancer and reproductive harm.  
**Wash your hands after handling.**



# Table of Contents

## Contacting Us

Contacting Us .....17

## Introduction

About This Publication .....19

Using This Publication .....20

## Symbols Glossary

Symbols Used on Your Vehicle .....21

## Data Privacy

Data Privacy .....24

Service Data .....25

Event Data .....26

Settings Data .....26

Connected Vehicle Data .....27

Mobile Device Data .....27

Emergency Call System Data .....28

## Environment

Protecting the Environment .....29

## Visual Search

Interior Overview .....30

Exterior Overview .....32

## Child Safety

Child Safety Precautions .....34

Child Restraint Anchor Points .....35

Child Restraints .....36

Installing Child Restraints .....39

Booster Seats .....44

Child Safety Locks .....46

Child Safety Locks – Troubleshooting  
.....47

## Seatbelts

Seatbelt Precautions .....48

Fastening and Unfastening the Seatbelts  
.....49

Sensitive Locking Mode .....50

Automatic Locking Mode .....51

Adjusting the Seatbelts During Pregnancy  
.....51

Adjusting the Seatbelt Height .....52

Seatbelt Reminder .....52

Checking the Seatbelts .....54

Seatbelt Extensions .....55

Seatbelts – Troubleshooting .....56

## Personal Safety System™

What Is the Personal Safety System .....57

How Does the Personal Safety System  
Work .....57

Personal Safety System Components  
.....57

## Airbags

How Do the Front Airbags Work .....58

How Do the Side Airbags Work .....58

How Do the Knee Airbags Work .....59

How Does the Safety Canopy™ Work .....60

Airbag Precautions .....61

Properly Adjusting the Driver and Front  
Passenger Seats .....62

Children and Airbags .....62

Front Passenger Sensing System .....62

Crash Sensors and Airbag Indicator .....66

Disposing of Airbags .....67

# Table of Contents

## **Pedestrian Alert System - Hybrid Electric Vehicle (HEV)**

What Is the Pedestrian Alert System .....68

## **911 Assist**

What Is 911 Assist .....69

How Does 911 Assist Work .....69

Emergency Call Requirements .....69

Emergency Call Limitations .....70

## **Keys and Remote Controls**

Remote Control Limitations .....71

Using the Remote Control .....71

Removing the Key Blade .....72

Sounding the Panic Alarm .....72

Locating Your Vehicle .....72

Changing the Remote Control Battery  
.....73

Replacing a Lost Key or Remote Control  
.....74

Programming the Remote Control .....74

Keys and Remote Controls Audible  
Warnings .....75

Keys and Remote Controls –  
Troubleshooting .....75

## **Phone as a Key**

What Is Phone as a Key .....76

Phone as a Key Limitations .....76

Programming Your Phone .....76

Using the Valet Mode .....76

Using the Backup Start Passcode .....77

Phone as a Key – Troubleshooting .....78

## **Doors and Locks**

Operating the Doors From Outside Your  
Vehicle .....80

Operating the Doors From Inside Your  
Vehicle .....80

Autounlock .....81

Autolock .....81

Mislock .....81

Doors and Locks Audible Warnings .....82

Doors and Locks – Troubleshooting .....82

## **Keyless Entry**

What Is Keyless Entry .....83

Keyless Entry Limitations .....83

Keyless Entry Settings .....83

Using Keyless Entry .....83

Keyless Entry – Troubleshooting .....84

## **Keyless Entry Keypad**

What Is the Keyless Entry Keypad .....85

Keyless Entry Keypad Limitations .....85

Locating the Keyless Entry Keypad .....85

Keyless Entry Keypad Master Access Code  
.....85

Keyless Entry Keypad Personal Access  
Codes .....86

Using the Keyless Entry Keypad .....87

Keyless Entry Keypad – Troubleshooting  
.....88

## **Easy Entry and Exit**

How Does Easy Entry and Exit Work .....89

Switching Easy Entry and Exit On and Off  
.....89

## **Liftgate**

Liftgate Precautions .....90

# Table of Contents

Opening the Liftgate .....	90	Autowipers .....	105	Adaptive Front Lighting .....	119
Setting the Liftgate Opening Height .....	93	Switching the Rear Window Wiper On and Off .....	106	<b>Interior Lighting</b>	
Closing the Liftgate .....	93	Reverse Wipe .....	107	Switching All of the Interior Lamps On and Off .....	122
Stopping the Liftgate Movement .....	96	Checking the Wiper Blades .....	107	Switching the Front Interior Lamps On and Off .....	122
Liftgate Obstacle Detection .....	96	Replacing the Front Wiper Blades - Vehicles Without: Heated Wiper Blades .....	107	Switching the Rear Interior Lamps On and Off .....	122
Liftgate – Troubleshooting .....	96	Replacing the Front Wiper Blades - Vehicles With: Heated Wiper Blades .....	108	Interior Lamp Function .....	122
<b>Security</b>		Replacing the Rear Wiper Blades .....	108	Adjusting the Instrument Panel Lighting Brightness .....	122
Passive Anti-Theft System .....	98	Washers .....	109	Ambient Lighting .....	123
Anti-Theft Alarm System .....	98	Wipers and Washers – Troubleshooting .....	110	Interior Lighting – Troubleshooting .....	123
Anti-Theft Alarm System Settings .....	99	<b>Exterior Lighting</b>		<b>Windows</b>	
Security – Troubleshooting .....	100	Exterior Lighting Control .....	111	Opening and Closing the Windows .....	124
<b>Steering Wheel</b>		Headlamps .....	111	Global Opening and Closing .....	125
Using the Controls on the Steering Wheel .....	102	Headlamps – Troubleshooting .....	112	Window Bounce-Back .....	125
Adjusting the Steering Wheel .....	103	Autolamps .....	112	Locking the Rear Window Controls .....	126
Resetting the Stopping Position .....	103	Exterior Lamps .....	113	<b>Interior Mirror</b>	
Heated Steering Wheel .....	104	Automatic High Beam Control .....	115	Interior Mirror Precautions .....	128
Horn .....	104	Automatic High Beam Control – Troubleshooting .....	118	Auto-Dimming Interior Mirror .....	128
<b>Wipers and Washers</b>					
Wipers .....	105				

# Table of Contents

---

## Exterior Mirrors

Adjusting the Exterior Mirrors .....	129
Folding the Exterior Mirrors .....	129

## Moonroof

Opening and Closing the Sunshade .....	131
Opening and Closing the Moonroof .....	131
Venting the Moonroof .....	132
Moonroof Bounce-Back .....	132

## Instrument Cluster

Instrument Cluster Overview .....	133
Tachometer .....	134
Power Gauge .....	134
Speedometer .....	134
Fuel Gauge .....	134
Engine Coolant Temperature Gauge .....	134
What Are the Instrument Cluster Warning Lamps .....	135
Instrument Cluster Warning Lamps .....	135
What Are the Instrument Cluster Indicators .....	136
Instrument Cluster Indicators .....	137

## Personalized Settings

Changing the Language .....	139
Changing the Measurement Unit .....	139
Changing the Temperature Unit .....	139
Changing the Tire Pressure Unit .....	139

## Trip Computer

Accessing the Trip Computer .....	140
Resetting the Trip Computer .....	140

## Remote Start

What Is Remote Start .....	141
Remote Start Precautions .....	141
Remote Start Limitations .....	141
Enabling Remote Start .....	141
Remotely Starting and Stopping the Vehicle .....	141
Extending the Remote Start Duration .....	142
Remote Start Settings .....	142

## Climate Control

Identifying the Climate Control Unit .....	143
--	-----

Switching Climate Control On and Off .....	143
Switching Recirculated Air On and Off .....	143
Switching Air Conditioning On and Off .....	143
Switching Maximum Defrost On and Off .....	143
Switching Maximum Cooling On and Off .....	144
Switching the Heated Rear Window On and Off .....	144
Setting the Blower Motor Speed .....	144
Switching the Heated Mirrors On and Off .....	144
Setting the Temperature .....	144
Directing the Flow of Air .....	144
Auto Mode .....	145
Climate Control Hints .....	146

## Interior Air Quality

What Is the Cabin Air Filter .....	148
Replacing the Cabin Air Filter .....	148
Auto Air Refresh .....	148
Digital Scent .....	151



# Table of Contents

Interior Air Quality – Troubleshooting .....	153	Rear Occupant Alert System Settings .....	166	Playing Media Using the USB Port .....	175
<b>Front Seats</b>		Rear Occupant Alert System Indicators .....	166	Charging a Device .....	176
Front Seat Precautions .....	154	Rear Occupant Alert System Audible Warnings .....	167	<b>Power Outlet - Vehicles With: 110V Power Outlet</b>	
Sitting in the Correct Position .....	154	<b>Memory Function</b>		What Is the Power Outlet .....	177
Power Seats .....	155	How Does the Memory Function Work .....	168	Power Outlet Precautions .....	177
Massage Seats .....	158	Memory Function Precautions .....	168	Locating the Power Outlets .....	177
Heated Seats .....	159	Locating the Memory Function Buttons .....	168	Power Outlet Indicators .....	177
Cooled Seats .....	159	Saving a Preset Position .....	168	<b>Power Outlet - Vehicles With: 12V Power Outlet</b>	
<b>Rear Seats</b>		Recalling a Preset Position .....	168	What Is the Power Outlet .....	179
Manual Seats .....	161	<b>Garage Door Opener</b>		Power Outlet Precautions .....	179
Heated Seats .....	163	Garage Door Opener Introduction .....	170	Locating the Power Outlets .....	179
<b>Rear Occupant Alert System</b>		Garage Door Opener Precautions and Frequencies .....	170	<b>Wireless Accessory Charger</b>	
What is the Rear Occupant Alert System .....	165	Programming the Garage Door Opener .....	171	What Is the Wireless Accessory Charger .....	180
How Does the Rear Occupant Alert System Work .....	165	<b>USB Ports</b>		Wireless Accessory Charger Precautions .....	180
Rear Occupant Alert System Precautions .....	165	Locating the USB Ports .....	175	Locating the Wireless Accessory Charger .....	180
Rear Occupant Alert System Limitations .....	165			Charging a Wireless Device .....	181

# Table of Contents

---

## **Storage**

Cup Holders .....	182
Glove Compartment .....	183
Center Console .....	183
Under Floor Storage .....	184
Glasses Holder .....	184

## **Starting and Stopping the Engine**

Starting and Stopping the Engine – Precautions .....	185
Push Button Ignition Switch .....	185
Starting the Engine .....	186
Engine Block Heater .....	187
Stopping the Engine .....	188
Automatic Engine Stop .....	189
Accessing the Passive Key Backup Position .....	190
Starting and Stopping the Engine – Troubleshooting .....	190

## **Hybrid Electric Vehicle Information - Hybrid Electric Vehicle (HEV)**

Hybrid Electric Vehicle Information .....	193
Power Flow .....	195

## **Auto-Start-Stop**

What Is Auto-Start-Stop .....	197
Auto-Start-Stop Precautions .....	197
Switching Auto-Start-Stop On and Off .....	197
Stopping the Engine .....	197
Restarting the Engine .....	197
Auto-Start-Stop Indicators .....	197
Auto-Start-Stop – Troubleshooting .....	198

## **Fuel and Refueling**

Fuel and Refueling Precautions .....	200
Fuel Quality .....	201
Locating the Fuel Filler Funnel .....	201
Running Out of Fuel .....	202
Refueling .....	203
Fuel Tank Capacity .....	208

Fuel and Refueling – Troubleshooting .....	208
---	-----

## **Catalytic Converter**

What Is the Catalytic Converter .....	211
Catalytic Converter Precautions .....	211
Catalytic Converter – Troubleshooting .....	212

## **High Voltage Battery - Hybrid Electric Vehicle (HEV)**

What Is the High Voltage Battery .....	213
High Voltage Battery Precautions .....	213
Recycling and Disposing of the High Voltage Battery .....	213

## **Automatic Transmission**

Automatic Transmission Precautions .....	214
Automatic Transmission Positions .....	214
Shifting Your Vehicle Into Gear .....	215
Automatic Transmission Position Indicators .....	215
Shifting Your Immobile Vehicle Out of Park (P) .....	216

# Table of Contents

---

Automatic Transmission Audible Warnings .....	216
Temporary Neutral Mode .....	217
Automatic Return to Park (P) .....	218
Grade Assist .....	218
Automatic Transmission – Troubleshooting .....	219

## All-Wheel Drive

How Does All-Wheel Drive Work .....	220
All-Wheel Drive Precautions .....	220
All-Wheel Drive Limitations .....	220
All-Wheel Drive – Troubleshooting .....	221

## Brakes

Brake Precautions .....	222
Anti-Lock Braking System .....	222
Brake Over Accelerator .....	222
Locating the Brake Fluid Reservoir .....	222
Checking the Brake Fluid .....	222
Brake Fluid Specification .....	223
Brakes – Troubleshooting .....	223

## Electric Parking Brake

What Is the Electric Parking Brake .....	225
Applying the Electric Parking Brake .....	225
Applying the Electric Parking Brake in an Emergency .....	225
Manually Releasing the Electric Parking Brake .....	226
Automatically Releasing the Electric Parking Brake .....	226
Electric Parking Brake Audible Warning .....	226
Releasing the Electric Parking Brake if the Vehicle Battery Has Run Out of Charge .....	226
Electric Parking Brake – Troubleshooting .....	226

## Reverse Brake Assist

What Is Reverse Brake Assist .....	230
How Does Reverse Brake Assist Work .....	230
Reverse Brake Assist Precautions .....	230
Switching Reverse Brake Assist On and Off .....	231
Overriding Reverse Brake Assist .....	231

Reverse Brake Assist Indicators .....	232
Reverse Brake Assist – Troubleshooting .....	232

## Cross Traffic Braking

What Is Cross Traffic Braking .....	234
How Does Cross Traffic Braking Work .....	234
Cross Traffic Braking Precautions .....	234
Switching Cross Traffic Braking On and Off .....	235
Overriding Cross Traffic Braking .....	235
Cross Traffic Braking Indicators .....	235
Cross Traffic Braking – Troubleshooting .....	236

## Hill Start Assist

What Is Hill Start Assist .....	238
How Does Hill Start Assist Work .....	238
Hill Start Assist Precautions .....	238
Hill Start Assist – Troubleshooting .....	238

## Auto Hold

How Does Auto Hold Work .....	239
-------------------------------	-----

# Table of Contents

Switching Auto Hold On and Off - Gasoline .....	239
Switching Auto Hold On and Off - Full Hybrid Electric Vehicle (FHEV) .....	239
Using Auto Hold .....	240
Auto Hold Indicators .....	240

## Traction Control

How Does Traction Control Work .....	241
Switching Traction Control On and Off .....	241
Traction Control Indicator .....	241
Traction Control – Troubleshooting .....	241

## Stability Control

How Does Stability Control Work .....	242
Switching Stability Control On and Off .....	243
Stability Control Indicator .....	243
Stability Control – Troubleshooting .....	244

## Steering

Electric Power Steering .....	245
Steering – Troubleshooting .....	245

## Parking Aids

Parking Aid Precautions .....	248
Switching Parking Aid On and Off .....	249
Rear Parking Aid .....	249
Front Parking Aid .....	250
Side Parking Aid .....	251
Parking Aid Indicators .....	252
Parking Aids – Troubleshooting .....	252

## 360 Degree Camera

What Is the 360 Degree Camera .....	254
How Does the 360 Degree Camera Work .....	254
360 Degree Camera Precautions .....	254
Locating the 360 Degree Cameras .....	255
360 Degree Camera Guide Lines .....	256
360 Degree Camera Settings .....	257

## Active Park Assist

What Is Active Park Assist .....	259
How Does Active Park Assist Work .....	259
Active Park Assist Precautions .....	259

Switching Active Park Assist On and Off .....	259
Entering a Parking Space .....	260
Exiting a Parking Space .....	260
Active Park Assist – Troubleshooting .....	261

## Adaptive Cruise Control

How Does Adaptive Cruise Control With Stop and Go Work .....	264
Adaptive Cruise Control Precautions .....	264
Adaptive Cruise Control Limitations .....	265
Switching Adaptive Cruise Control On and Off .....	267
Adaptive Cruise Control Automatic Cancellation .....	268
Setting the Adaptive Cruise Control Speed .....	268
Setting the Adaptive Cruise Control Gap .....	269
Canceling the Set Speed .....	271
Resuming the Set Speed .....	271
Overriding the Set Speed .....	272
Adaptive Cruise Control Indicators .....	272

# Table of Contents

Switching From Adaptive Cruise Control to Cruise Control .....	272	In-Lane Repositioning .....	290	Lane Keeping System Indicators .....	300
Lane Centering .....	273	BlueCruise – Troubleshooting .....	291	Blind Spot Assist .....	301
Lane Centering – Troubleshooting .....	276	<b>Drive Mode Control</b>		Lane Keeping System – Troubleshooting .....	304
Predictive Speed Assist .....	278	What Is Drive Mode Control .....	293	<b>Blind Spot Information System</b>	
Predictive Speed Assist – Troubleshooting .....	281	How Does Drive Mode Control Work .....	293	What Is Blind Spot Information System .....	307
Adaptive Cruise Control – Troubleshooting .....	281	Selecting a Drive Mode .....	293	How Does Blind Spot Information System Work .....	307
<b>Lincoln BlueCruise</b>		Drive Modes .....	293	Blind Spot Information System Precautions .....	307
What Is BlueCruise .....	283	Drive Mode Control – Troubleshooting .....	294	Blind Spot Information System Limitations .....	307
How Does BlueCruise Work .....	283	<b>Lane Keeping System</b>		Blind Spot Information System Requirements .....	308
BlueCruise Precautions .....	283	What Is the Lane Keeping System .....	297	Switching Blind Spot Information System On and Off .....	308
BlueCruise Requirements .....	284	How Does the Lane Keeping System Work .....	297	Locating the Blind Spot Information System Sensors .....	308
BlueCruise Limitations .....	285	Lane Keeping System Precautions .....	297	Blind Spot Information System Indicators .....	309
BlueCruise Settings .....	285	Lane Keeping System Limitations .....	298	Blind Spot Information System – Troubleshooting .....	309
Switching BlueCruise On and Off .....	286	Switching the Lane Keeping System On and Off .....	298		
BlueCruise Alerts .....	286	Switching the Lane Keeping System Mode .....	298		
BlueCruise Automatic Cancellation .....	287	Alert Mode .....	298		
BlueCruise Indicators .....	287	Aid Mode .....	299		
Lane Change Assist .....	288	Alert and Aid Mode .....	299		
Lane Change Assist – Troubleshooting .....	289				

# Table of Contents

## Cross Traffic Alert

What Is Cross Traffic Alert .....	310
How Does Cross Traffic Alert Work .....	310
Cross Traffic Alert Precautions .....	310
Cross Traffic Alert Limitations .....	311
Switching Cross Traffic Alert On and Off .....	311
Locating the Cross Traffic Alert Sensors .....	311
Cross Traffic Alert Indicators .....	311
Cross Traffic Alert – Troubleshooting .....	312

## Pre-Collision Assist

What Is Pre-Collision Assist .....	313
How Does Pre-Collision Assist Work .....	313
Pre-Collision Assist Precautions .....	313
Pre-Collision Assist Limitations .....	314
Switching Pre-Collision Assist On and Off .....	315
Locating the Pre-Collision Assist Sensors .....	316
Distance Indication .....	316
Distance Alert .....	318

Automatic Emergency Braking .....	319
Evasive Steering Assist .....	319
Pre-Collision Assist – Troubleshooting .....	320

## Speed Sign Recognition

What Is Speed Sign Recognition .....	322
How Does Speed Sign Recognition Work .....	322
Speed Sign Recognition Precautions .....	322
Speed Sign Recognition Limitations .....	322
Speed Sign Recognition Indicators .....	323
Setting the Speed Sign Recognition Speed Warning .....	323
Setting the Speed Sign Recognition Speed Tolerance .....	323
Speed Sign Recognition – Troubleshooting .....	323

## Driver Alert

What Is Driver Alert .....	325
How Does Driver Alert Work .....	325
Driver Alert Precautions .....	326
Driver Alert Limitations .....	326

Switching Driver Alert On and Off .....	326
Driver Alert Indicators .....	326
Driver Alert – Troubleshooting .....	327

## Load Carrying

Load Carrying Precautions .....	328
Locating the Safety Compliance Certification Labels .....	329
What Is the Gross Axle Weight Rating .....	329
What Is the Gross Vehicle Weight Rating .....	329
What Is the Gross Combined Weight Rating .....	329
Calculating Payload .....	330
Calculating the Load Limit .....	330
Roof Rack .....	332

## Luggage Compartment

Luggage Compartment Precautions .....	333
Installing and Removing the Luggage Compartment Cargo Net .....	333
Installing and Removing the Luggage Compartment Cover .....	334

# Table of Contents

---

## Connecting a Trailer

Connecting a Trailer Precautions .....	336
Connecting a Trailer .....	336
Trailer Lighting Check .....	337

## Towing a Trailer

Towing a Trailer Precautions .....	338
Trailer Brake Precautions .....	338
Towing a Trailer Limitations .....	339
Loading Your Trailer .....	339
Trailer Towing Hints .....	339
Launching or Retrieving a Boat or Personal Watercraft .....	340
Towing Weights and Dimensions .....	341

## Trailer Sway Control

How Does Trailer Sway Control Work .....	343
Trailer Sway Control Precautions .....	343
Switching Trailer Sway Control On and Off .....	343

## Driving Hints

Cold Weather Precautions .....	344
Breaking-In .....	344
Driving Economically .....	344
Driving in Special Conditions .....	344
Driving Through Shallow Water .....	346
Floor Mats .....	347

## Crash and Breakdown Information

Roadside Assistance .....	348
High Voltage Battery Vehicle Precautions - Hybrid Electric Vehicle (HEV) .....	349
Switching the Hazard Flashers On and Off .....	351
Jump Starting the Vehicle .....	351
Post-Crash Alert System .....	354
Post-Collision Braking .....	355
Automatic Crash Shutoff .....	355
Transporting the Vehicle .....	356
Fail-Safe Cooling .....	357

## Towing Your Vehicle

Towing Your Vehicle Precautions .....	359
Recreationally Towing Your Vehicle - Gasoline .....	359
Recreationally Towing Your Vehicle - Full Hybrid Electric Vehicle (FHEV) .....	359
Emergency Towing - Gasoline .....	360
Emergency Towing - Full Hybrid Electric Vehicle (FHEV) .....	360

## Fuses

Fuse Precautions .....	361
Under Hood Fuse Box .....	361
Interior Fuse Box .....	367
Identifying Fuse Types .....	372
Fuses – Troubleshooting .....	372

## Maintenance

Maintenance Precautions .....	373
Opening and Closing the Hood .....	373
Under Hood Overview - Gasoline .....	375
Under Hood Overview - Full Hybrid Electric Vehicle (FHEV) .....	377
Engine Oil .....	379

# Table of Contents

Engine Air Filter .....	380
Changing the Engine Air Filter .....	380
Coolant .....	381
Changing the Fuel Filter .....	385
Drive Belt Routing Overview .....	386
12V Battery .....	386
12V Battery – Troubleshooting .....	389
Adjusting the Headlamps .....	391
Exterior Bulbs .....	393
Interior Bulbs .....	394

## Vehicle Care

Cleaning Products .....	395
Cleaning the Exterior .....	396
Cleaning the Interior .....	398
Repairing Minor Paint Damage .....	400
Waxing Your Vehicle .....	401

## Body Styling Kits

Body Styling Kit Precautions .....	402
------------------------------------	-----

## Storing Your Vehicle

Preparing Your Vehicle for Storage .....	403
--	-----

Removing Your Vehicle From Storage .....	404
--	-----

## Wheel and Tire Information

Locating the Tire label .....	405
Department of Transportation Uniform Tire Quality Grades .....	405
Information on the Tire Sidewall .....	406
Glossary of Tire Terminology .....	411
Tire Replacement Requirements .....	411
Using Snow Chains .....	414

## Tire Care

Checking the Tire Pressures .....	416
Inflating the Tires .....	416
Inspecting the Tire for Wear .....	417
Inspecting the Tire for Damage .....	417
Inspecting the Wheel Valve Stems .....	421
Tire Rotation .....	421

## Tire Pressure Monitoring System

What Is the Tire Pressure Monitoring System .....	423
---	-----

Tire Pressure Monitoring System Overview .....	423
Tire Pressure Monitoring System Precautions .....	424
Tire Pressure Monitoring System Limitations .....	425
Viewing the Tire Pressures .....	425
Tire Pressure Monitoring System – Troubleshooting .....	425

## Changing a Road Wheel

Changing a Flat Tire .....	428
Wheel Nuts .....	434

## Capacities and Specifications

Engine Specifications - 2.0L, Gasoline .....	436
Engine Specifications - 2.0L, Full Hybrid Electric Vehicle (FHEV) .....	437
Transmission Specifications - Full Hybrid Electric Vehicle (FHEV) .....	438
Motorcraft Parts - 2.0L, Gasoline .....	439
Motorcraft Parts - 2.0L, Full Hybrid Electric Vehicle (FHEV) .....	440



# Table of Contents

---

Engine Oil Capacity and Specification - 2.0L, Gasoline .....	441
Engine Oil Capacity and Specification - 2.0L, Full Hybrid Electric Vehicle (FHEV) .....	443
Cooling System Capacity and Specification - 2.0L, Gasoline .....	446
Cooling System Capacity and Specification - 2.0L, Full Hybrid Electric Vehicle (FHEV) .....	447
Fuel Tank Capacity .....	448
Air Conditioning System Capacity and Specification - 2.0L, Gasoline .....	449
Air Conditioning System Capacity and Specification - 2.0L, Full Hybrid Electric Vehicle (FHEV) .....	451
Washer Fluid Specification .....	452
Automatic Transmission Fluid Capacity and Specification .....	453
Brake Fluid Specification .....	454

## Vehicle Identification

Vehicle Identification Number .....	455
-------------------------------------	-----

## Connected Vehicle

What Is a Connected Vehicle .....	456
Connected Vehicle Requirements .....	456
Connected Vehicle Limitations .....	456
Connecting the Vehicle to a Mobile Network .....	456
Connecting the Vehicle to a Wi-Fi Network .....	456
Connected Vehicle Settings .....	457
Connected Vehicle – Troubleshooting .....	457

## Vehicle Hotspot

Setting Up a Vehicle Hotspot .....	460
Vehicle Hotspot Settings .....	460
Vehicle Hotspot – Troubleshooting .....	461

## Audio System

Audio System Precautions .....	462
Switching the Audio Unit On and Off ....	462
Selecting the Audio Source .....	462
Playing or Pausing the Audio Source ....	462
Adjusting the Volume .....	462

Switching Shuffle Mode On and Off .....	463
Switching Repeat Mode On and Off .....	463
Setting a Memory Preset .....	463
Adjusting the Sound Settings .....	463
Setting the Clock and Date .....	463
AM/FM Radio .....	463
Digital Radio .....	464
Satellite Radio .....	465

## Center Display

Center Display Overview .....	468
Status Bar .....	468
Apps .....	469
Controls .....	469
Customizing the Instrument Panel Display .....	470
Settings .....	470
Rebooting the Center Display .....	470

## Voice Interaction

What is Voice Interaction .....	471
Setting Your Default Assistant .....	471
Alexa Built-In .....	471

# Table of Contents

---

Google Assistant .....472

## Phone

Phone Precautions .....474

Connecting Your Phone .....474

Phone Menu .....474

Making and Receiving a Phone Call .....476

Sending and Receiving a Text Message  
.....478

Switching Text Message Notification On  
and Off .....479

Switching Apple CarPlay On and Off .....479

Switching Android Auto On and Off .....479

## Bluetooth®

Connecting a Bluetooth® Device .....481

Playing Media Using Bluetooth® .....481

## Personal Profiles

How Do Personal Profiles Work .....482

Enabling or Disabling Personal Profiles  
.....482

Creating a Personal Profile .....482

Linking or Unlinking a Personal Profile to  
a Remote Control .....482

Linking or Unlinking a Personal Profile to  
a Device .....483

## Navigation

Connected Navigation .....484

## Vehicle Software Updates

Vehicle Software Updates .....485

Software Update Settings .....485

Software Update Indicators .....486

## Vehicle System Reset

Performing a System Reset .....487

## Accessories

Accessories .....488

## Lincoln Protect

What Is Lincoln Protect .....490

## Scheduled Maintenance

General Maintenance Information .....493

## Customer Information

Rollover Warning .....498

The Better Business Bureau Auto Line  
Program .....498

The Mediation and Arbitration Program  
.....499

Ordering a Canadian French Owner's  
Manual .....500

Reporting Safety Defects in the United  
States .....500

Reporting Safety Defects in Canada .....501

Third Party Software Copyright  
Acknowledgment .....502

Radio Frequency Certification Labels  
.....502

Perchlorate .....546

Replacement Parts Recommendation  
.....546

Mobile Communications Equipment .....547

Federal Highway Administration  
Regulation .....547

Emission Law .....547

# Table of Contents

---

Export Unique Options .....	549
Warranty Information .....	549

## **Appendices**

Electromagnetic Compatibility .....	552
-------------------------------------	-----



# Contacting Us

---

If you require assistance or clarification on policies or procedures, please contact the customer relationship center.

## United States

Lincoln  
Lincoln Concierge  
P.O. Box 6248  
Dearborn, MI 48126  
1-800-521-4140  
TDD for the hearing impaired:  
7-1-1 (where offered by your telephone  
service provider)  
[www.owner.lincoln.com](http://www.owner.lincoln.com)

## Lincoln Automotive Financial Services - US Only

Lincoln Automotive Financial Services offers a full range of financing and lease plans to help you acquire your vehicle. We are dedicated to providing answers, information and a truly extraordinary experience.

For assistance call 1-888-498-8801, or for more information about Lincoln Automotive Financial Services and access to an account manager, visit [www.lincoln.com/finance](http://www.lincoln.com/finance).

## Canada

Lincoln  
Customer Relationship Centre  
P.O. Box 2000  
Oakville, Ontario L6K 0C8  
1-800-387-9333  
TDD for the hearing impaired:  
7-1-1 (where offered by your telephone  
service provider)  
[www.lincolncanada.com](http://www.lincolncanada.com)

## Australia

Ford Motor Company  
Attention: Customer Relationship Centre  
Private Mail Bag 5  
Fairlane Business Park #3  
Campbellfield, Victoria, 3061  
Telephone: 13 3673 (FORD)  
E-mail: [foacust1@ford.com](mailto:foacust1@ford.com)

## New Zealand

Ford Motor Company  
Attention: Customer Relationship Centre  
Private Bag 76912  
Manukau City 2241  
Telephone: 0800 367 369 (FORDNZ)  
E-mail: [fncust@ford.com](mailto:fncust@ford.com)

## China

Customer Relationship Center  
Telephone: 400-988-6789  
Email: [info12@lincoln.com](mailto:info12@lincoln.com)  
Wechat Account: Lincoln\_in\_China  
Weibo Account: Lincoln China

## Asia Pacific

E-mail: [expcac@ford.com](mailto:expcac@ford.com)

# Contacting Us

---

## **Caribbean, Central America and Israel**

Ford Motor Company  
Ford Export Operations  
Attention: Owner Relations  
1555 Fairlane Drive  
Fairlane Business Park #3  
Allen Park, MI 48101  
Fax: (313) 390-0804  
Telephone: (313) 594-4857  
E-mail: expcac@ford.com

## **U.S. Virgin Islands and Puerto Rico**

Ford Motor Company  
Ford Export Operations  
Attention: Owner Relations  
1555 Fairlane Drive  
Fairlane Business Park #3  
Allen Park, MI 48101  
Telephone: (800) 841-3673  
E-mail: prcac@ford.com

## **Chile**

Ford Customer Service  
Telephone: 800-470-408

## **Argentina**

Telephone: 0800-888-3673

## **Brazil**

www.ford.com.br

## **North Africa**

E-mail: nafcrc@ford.com

## **Sub-Saharan Africa**

E-mail: ssacrc@ford.com

## **Puerto Rico**

Ford International Business Development,  
Inc.  
P.O. Box 11957  
Caparra Heights Station  
San Juan, PR 00922-1957  
1-800-392-3673 (FORD)  
Fax: (313) 390-0804  
E-mail: prcac@ford.com  
www.ford.com.pr

## **Middle East**

Ford Middle East Customer Relationship  
Center  
P.O. Box 21740  
Dubai, United Arab Emirates  
Telephone: 80004441066  
Toll-free number for the Kingdom of Saudi  
Arabia: 8008443673  
Mobily and Zain cell phone users in Saudi  
Arabia: 800850078  
Kuwait: 22280384  
Local telephone number for Kuwait: +965 1  
898900  
Fax: +971 4 3327266  
E-mail: menacac@ford.com  
www.me.ford.com

## **South Korea**

Telephone: +82-02-1600-6003  
E-mail: infokr1@ford.com

# Introduction

## ABOUT THIS PUBLICATION



**WARNING:** Driving while distracted can result in loss of vehicle control, crash and injury. We strongly recommend that you use extreme caution when using any device that may take your focus off the road. Your primary responsibility is the safe operation of your vehicle. We recommend against the use of any hand-held device while driving and encourage the use of voice-operated systems when possible. Make sure you are aware of all applicable local laws that may affect the use of electronic devices while driving.



**WARNING:** You risk death, fire, or serious injury to yourself and others if you do not follow the instruction highlighted by the warning symbol.

Thank you for choosing Lincoln. We recommend that you take some time to get to know your vehicle in order to benefit from greater safety and pleasure from driving it. Use this publication, whether in-vehicle, print, in Lincoln Way app or online, to familiarize yourself with the features on your vehicle.

**Note:** *Use and operate your vehicle in line with all applicable laws and regulations.*

**Note:** *Pass on all printed owner's information when selling this vehicle.*

### Features and Options

This publication describes product features and options available throughout the range of available models, sometimes even before they are generally available. It may describe options that are not available on the vehicle you have bought.

### Providing Feedback

If you would like to provide feedback to the Owner's Manual team, please email us at [OWNERMANUALFEEDBACK@ford.com](mailto:OWNERMANUALFEEDBACK@ford.com).

You will not receive a direct email response. Your submission will be investigated and necessary changes will be made to the Owner's Manual content.

To help investigate your submission, please include the following information:

- Your vehicle model
- The country in which your vehicle was purchased
- The Owner's Manual section needing investigation

### Illustrations

Some of the illustrations in this manual could show features as used in different models, some can appear different to you on your vehicle.

### Location of Components

This manual may qualify the location of a component as left-hand side or right-hand side. The side is determined when facing forward in the seat.

# Introduction

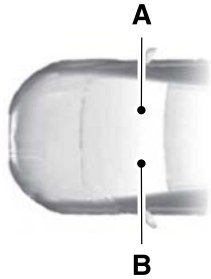

- A Right-hand side.  
B Left-hand side.

## Accessing the Digital Owner's Manual

### Landscape Center Display Screen

Depending on your vehicle, the Owner's Manual application is located in either the Apps list or the Features list.

1. Press Apps or Features on the touchscreen.

**Note:** *Some vehicles have the Apps or Features buttons on the home screen. Not all vehicles have a Features button.*

2. Select the Owner's Manual application.

### Accessing the Online and Printed Owner's Manual

#### Online Owner's Manual

- Through your device's app store, you can download the Lincoln Way app.
- You can visit the local Ford Website.

**Note:** *To find the local Ford website, visit <https://corporate.ford.com/operations/locations/global-links.html>.*

**Note:** *We strongly recommend downloading a copy of the Owner's Manual and having it with you whenever you drive, and to view the information if you are unable to be inside the vehicle.*

#### Printed Owner's Manual

In U.S. and Canada, visit [www.helminc.com](http://www.helminc.com) or see an authorized dealer.

In Europe, visit [www.z-order.de](http://www.z-order.de) or see an authorized dealer.

For all other Countries, see your authorized dealer.

## USING THIS PUBLICATION

To quickly locate information about your vehicle, use the word search within the Owner's Manual application.



# Symbols Glossary

## SYMBOLS USED ON YOUR VEHICLE

These are some of the symbols you may see on your vehicle.



Airbag



Air conditioning system



Air conditioning system lubricant type



Anti-lock braking system



Avoid smoking, flames or sparks



Battery



Battery acid



Blower motor



Brake fluid - non petroleum based



Brake system



Brake system



Cabin air filter



Check fuel cap



Child safety door lock or unlock



Child seat lower anchor



Child seat tether anchor



Cruise control



Do not open when hot



Electric Parking brake



Engine air filter



Engine coolant



Engine coolant temperature



Engine oil



Explosive gas



Fan warning



Fasten seatbelt

































Flammable



Front fog lamps

# Symbols Glossary

	Fuel pump reset		Keep out of reach of children		Passenger airbag activated
	Fuse compartment		Lighting control		Passenger airbag deactivated
	Hazard flashers		Low fuel level		Power steering fluid
	Headlamp high beams		Low tire pressure warning		Power windows front/rear
	Headlamps on		Maintain correct fluid level		Power window lockout
	Heated rear window		Malfunction Indicator Lamp (MIL)		Requires registered technician
	Hill descent control		Note operating instructions		Safety alert
	Horn control		Panic alarm		See Owner's Manual
	Interior luggage compartment release		Parking aid		See Service Manual
	Jack		Parking lamps		Side airbag

# Symbols Glossary

---



Shield the eyes



Stability control



Stability control off



Trail control



Turn Signal



Windshield defrosting system



Windshield wiping system



Windshield wash and wipe

# Data Privacy

---



**WARNING:** Do not connect wireless plug-in devices to the data link connector. Unauthorized third parties could gain access to vehicle data and impair the performance of safety related systems. Only allow repair facilities that follow our service and repair instructions to connect their equipment to the data link connector.

We respect your privacy and are committed to protecting it. The information contained in this publication was correct at the time of release, but as technology rapidly changes, we recommend that you visit the local Lincoln website for the latest information.

Your vehicle has electronic control units that have data recording functionality and the ability to permanently or temporarily store data. This data could include information on the condition and status of your vehicle, vehicle maintenance requirements, events and malfunctions. The types of data that can be recorded are described in this section. Some of the data recorded is stored in event logs or error logs.

**Note:** *Error logs are reset following a service or repair.*

**Note:** *We may provide information in response to requests from law enforcement, other government authorities and third parties acting with lawful authority or through a legal process. Such information could be used by them in legal proceedings.*

Data recorded includes, for example:

- Operating states of system components, for example fuel level, tire pressure and battery charge level.
- Vehicle and component status, for example wheel speed, deceleration, lateral acceleration and seatbelt status.
- Events or errors in essential systems, for example headlamps and brakes.
- System responses to driving situations, for example airbag deployment and stability control.
- Environmental conditions, for example temperature.

Some of this data, when used in combination with other information, for example an accident report, damage to a vehicle or eyewitness statements, could be associated with a specific person.

## Services That We Provide

If you use our services, we collect and use data, for example account information, vehicle location and driving characteristics, that could identify you. We transmit this data through a dedicated, protected connection. We only collect and use data to enable your use of our services to which you have subscribed, with your consent or where permitted by law. For additional information, see the terms and conditions of the services to which you have subscribed.

For additional information about our privacy policy, refer to the local Lincoln website.

# Data Privacy

---

## Services That Third Parties Provide

We recommend that you review the terms and conditions and data privacy information for any services equipped with your vehicle or to which you subscribe. We take no responsibility for services that third parties provide.

Where equipped, SiriusXM with 360L may use the modem. To disable, turn off the SiriusXM with 360L or Vehicle Connectivity setting. See **Enabling and Disabling the Modem** (page 456).

## SERVICE DATA

Service data recorders in your vehicle are capable of collecting and storing diagnostic information about your vehicle. This potentially includes information about the performance or status of various systems and modules in the vehicle, such as engine, throttle, steering or brake systems. In order to properly diagnose and service your vehicle, Ford Motor Company (Ford of Canada in Canada), and service and repair facilities may access or share among them

vehicle diagnostic information received through a direct connection to your vehicle when diagnosing or servicing your vehicle. Additionally, Ford Motor Company (Ford of Canada, in Canada) may, where permitted by law, use vehicle diagnostic information for vehicle improvement or with other information we may have about you, for example, your contact information, to offer you products or services that may interest you. Data may be provided to our service providers such as part suppliers that may help diagnose malfunctions, and who are similarly obligated to protect data. We retain this data only as long as necessary to perform these functions or to comply with law. We may provide information where required in response to official requests to law enforcement or other government authorities or third parties acting with lawful authority or court order, and such information may be used in legal proceedings. For U.S. only (if equipped), if you choose to use connected apps and services, you consent that certain diagnostic information may also be accessed electronically by Ford Motor Company and Ford authorized service facilities, and that the diagnostic information

may be used to provide services to you, personalizing your experience, troubleshoot, and to improve products and services and offer you products and services that may interest you, where permitted by law. For Canada only, for more information, please review the Ford of Canada privacy policy at [www.ford.ca](http://www.ford.ca), including our U.S. data storage and use of service providers in other jurisdictions who may be subject to legal requirements in Canada, the United States and other countries applicable to them, for example, lawful requirements to disclose personal information to governmental authorities in those countries.

# Data Privacy

---

## EVENT DATA

This vehicle is equipped with an event data recorder. The main purpose of an event data recorder is to record, in certain crash or near crash-like situations, such as an airbag deployment or hitting a road obstacle; this data will assist in understanding how a vehicle's systems performed. The event data recorder is designed to record data related to vehicle dynamics and safety systems for a short period of time, typically 30 seconds or less.

The event data recorder in this vehicle is designed to record such data as:

- How various systems in your vehicle were operating.
- Whether or not the driver and passenger seatbelts were buckled/fastened.
- How far (if at all) the driver was depressing the accelerator and/or the brake pedal.
- How fast the vehicle was traveling.
- Where the driver was positioning the steering wheel.

This data can help provide a better understanding of the circumstances in which crashes and injuries occur.

**Note:** *Event data recorder data is recorded by your vehicle only if a non-trivial crash situation occurs; no data is recorded by the event data recorder under normal driving conditions and no personal data or information (for example name, gender, age, and crash location) is recorded. However, parties, such as law enforcement, could combine the event data recorder data with the type of personally identifying data routinely acquired during a crash investigation.*

To read data recorded by an event data recorder, special equipment is required, and access to the vehicle or the event data recorder is needed. In addition to the vehicle manufacturer, other parties, such as law enforcement, that have such special equipment, can read the information if they have access to the vehicle or the event data recorder.

## BlueCruise Data (If Equipped)

If BlueCruise is active in certain crash or near crash-like situations, such as an airbag deployment or hitting a road obstacle, the system may record driver attentiveness, based on the direction of eyes and duration, and photographs of the driver seat area.

**Note:** *No data is recorded under normal driving conditions.*

## SETTINGS DATA

Your vehicle has electronic control units that have the ability to store data based on your personalized settings. The data is stored locally in the vehicle or on devices that you connect to it, for example, a USB drive or digital music player. You can delete some of this data and also choose whether to share it through the services to which you subscribe. See **Settings** (page 470).

# Data Privacy

---

## Comfort and Convenience Data

Data recorded includes, for example:

- Seat and steering wheel position.
- Climate control settings.
- Radio presets.

## Entertainment Data

Data recorded includes, for example:

- Music, videos or album art.
- Contacts and corresponding address book entries.
- Navigation destinations.

## CONNECTED VEHICLE DATA

The modem has a SIM. The modem was enabled when your vehicle was built and periodically sends messages to stay connected to the cell phone network, receive automatic software updates and send vehicle-related information to us, for example diagnostic information. These messages could include information that identifies your vehicle, the SIM and the electronic serial

number of the modem. Cell phone network service providers could have access to additional information, for example cell phone network tower identification. For additional information about our privacy policy, visit [www.ConnectedLincoln.com](http://www.ConnectedLincoln.com) or refer to your local Lincoln website.

**Note:** *The modem may continue to send this information unless you disable the modem or stop the modem from sharing vehicle data by changing the modem settings. See **Connected Vehicle** (page 456).*

**Note:** *The service can be unavailable or interrupted for a number of reasons, for example environmental or topographical conditions and data plan coverage.*

**Note:** *To find out if your vehicle has connectivity technology, visit [www.ConnectedLincoln.com](http://www.ConnectedLincoln.com).*

## MOBILE DEVICE DATA

If you connect a mobile device to your vehicle, you can display data from your device on the touchscreen for example, music and album art. You can grant apps permission to access your connected vehicle information with mobile apps on your device through the system.

The mobile apps function operates by your connected device sending data to us in the United States. The data is encrypted and includes, for example, the vehicle identification number of your vehicle, the operating system module serial number, odometer, enabled apps, usage statistics and debugging information. We retain it only as long as necessary to provide the service, to troubleshoot, for continuous improvement and to offer you products and services that may be of interest to you according to your preferences and where allowed by law.

# Data Privacy

---

If you connect a cell phone to the system, the system creates a profile that links to that cell phone. The cell phone profile enables more mobile features and efficient operation. The profile contains, for example data from your phonebook, read and unread text messages and call history, including history of calls when your cell phone was not connected to the system.

If you connect a media device, the system creates and retains a media device index of supported media content. The system also records a short diagnostic log of approximately 10 minutes of all recent system activity.

The cell phone profile, media device index and diagnostic log remain in your vehicle unless you delete them and are generally accessible only in your vehicle when you connect your cell phone or media device. If you no longer plan to use the system or your vehicle, we recommend you use the system reset function to erase the stored information. See **Performing a System Reset** (page 487).

System data cannot be accessed without special equipment and access to your vehicle's module.

For additional information about our privacy policy, refer to the local Lincoln website.

**Note:** To find out if your vehicle has connectivity technology, visit [www.ConnectedLincoln.com](http://www.ConnectedLincoln.com).

**Note:** You cannot deactivate emergency call systems that are required by law.

## EMERGENCY CALL SYSTEM DATA

When the emergency call system is active, it may disclose to emergency services that your vehicle has been in a crash involving the deployment of an airbag or activation of the fuel pump shut-off. Certain versions or updates to the emergency call system may also be capable of electronically or verbally disclosing to emergency services operators your vehicle location or other details about your vehicle or crash to assist emergency services operators to provide the most appropriate emergency services. If you do not want to disclose this information, do not activate the emergency call system.



# Environment

---

## **PROTECTING THE ENVIRONMENT**

Sustainability is a priority at Ford. We are constantly looking for ways to reduce our impact on the planet while providing customers with great products and delivering a strong business. You should play your part in protecting the environment. Correct vehicle usage and the authorized disposal of waste, cleaning and lubrication materials are significant steps toward this aim.

For additional information about our sustainability progress and initiatives, visit [www.sustainability.ford.com](http://www.sustainability.ford.com).

# Visual Search

## INTERIOR OVERVIEW

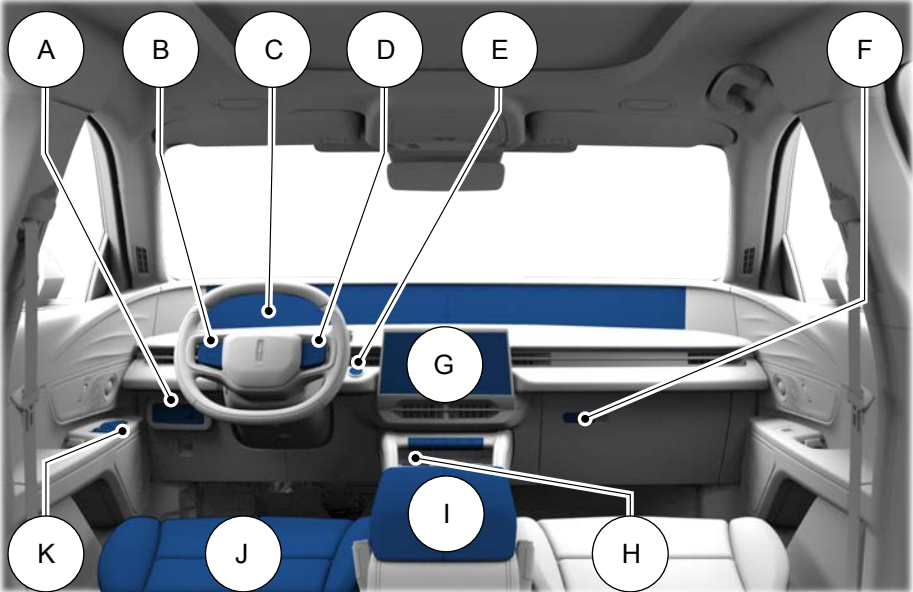

# Visual Search

---

- A See **Exterior Lighting Control** (page 111).
- B See **Switching Adaptive Cruise Control On and Off** (page 267).
- C See **Instrument Cluster Overview** (page 133).
- D See **Using the Controls on the Steering Wheel** (page 102).
- E See **Push Button Ignition Switch** (page 185).
- F See **Opening the Glove Compartment** (page 183).
- G See **Center Display Overview** (page 468).
- H See **Switching the Hazard Flashers On and Off** (page 351).
- I See **Opening the Center Console** (page 183).
- J See **Sitting in the Correct Position** (page 154).
- K See **Adjusting the Exterior Mirrors** (page 129).

# Visual Search

## EXTERIOR OVERVIEW

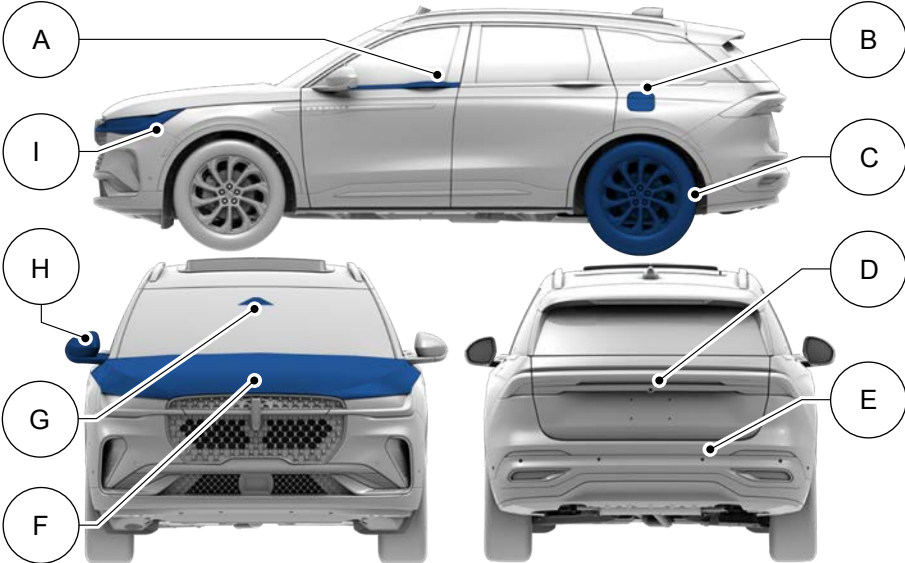

# Visual Search

---

- A See **Unlocking and Locking the Doors Using the Remote Control** (page 80).
- B See **Refueling Your Vehicle** (page 205). See **Refueling Your Vehicle** (page 203).
- C See **Changing a Flat Tire** (page 428).
- D See **Locating the 360 Degree Cameras** (page 255).
- E See **Locating the Rear Parking Aid Sensors** (page 249).
- F See **Opening and Closing the Hood** (page 373).
- G See **Locating the Pre-Collision Assist Sensors** (page 316).
- H See **Folding the Exterior Mirrors** (page 129).
- I See **Using the High Beam Headlamps** (page 111).

# Child Safety

## CHILD SAFETY PRECAUTIONS

 **WARNING:** Always make sure your child is secured properly in a device that is appropriate for their height, age and weight. Child safety restraints must be bought separately from your vehicle. Failure to follow these instructions and guidelines may result in an increased risk of serious injury or death to your child.

 **WARNING:** All children are shaped differently. The National Highway Traffic Safety Administration and other safety organizations, base their recommendations for child restraints on probable child height, age and weight thresholds, or on the minimum requirements of the law. We recommend that you check with a NHTSA Certified Child Passenger Safety Technician (CPST) to make sure that you properly install the child restraint in your vehicle and that you consult your pediatrician to make sure you have a child restraint appropriate for your child. To locate a child restraint fitting station and

CPST, contact NHTSA toll free at 1-888-327-4236 or go to [www.nhtsa.dot.gov](http://www.nhtsa.dot.gov). In Canada, contact Transport Canada toll free at 1-800-333-0371 or go to [www.tc.gc.ca](http://www.tc.gc.ca) to find a Child Car Seat Clinic in your area. Failure to properly restrain children in child restraints made especially for their height, age and weight, may result in an increased risk of serious injury or death to your child.

 **WARNING:** On hot days, the temperature inside the vehicle can rise very quickly. Exposure of people or animals to these high temperatures for even a short time can cause death or serious heat related injuries, including brain damage. Small children are particularly at risk.

 **WARNING:** Do not place a rearward facing child restraint in front of an active airbag. Failure to follow this instruction could result in personal injury or death.

 **WARNING:** Properly secure children 12 years old and under in a rear seating position whenever possible. If you are unable to properly secure all children in a rear seating position, properly secure the largest child on the front seat. If you must use a forward facing child restraint on the front seat, move the seat as far back as possible. Failure to follow these instructions could result in personal injury or death.

 **WARNING:** Always carefully follow the instructions and warnings provided by the manufacturer of any child restraint to determine if the restraint device is appropriate for your child's size, height, weight, or age. Follow the child restraint manufacturer's instructions and warnings provided for installation and use in conjunction with the instructions and warnings provided by your vehicle

# Child Safety

manufacturer. A safety seat that is improperly installed or utilized, is inappropriate for your child's height, age, or weight or does not properly fit the child may increase the risk of serious injury or death.



**WARNING:** Do not allow a passenger to hold a child on their lap when your vehicle is moving. Failure to follow this instruction could result in personal injury or death in the event of a sudden stop or crash.



**WARNING:** Do not use pillows, books or towels to boost your child's height. Failure to follow this instruction could result in personal injury or death.



**WARNING:** Properly secure child restraints or booster seats when they are not in use. They could become projectiles in a sudden stop or crash. Failure to follow this instruction could result in personal injury or death.



**WARNING:** Do not put the shoulder section of the seatbelt or allow the child to put the shoulder section of the seatbelt under their arm or behind their back. Failure to follow this instruction could reduce the effectiveness of the seatbelt and increase the risk of injury or death in a crash.



**WARNING:** Do not leave children or pets unattended in your vehicle. Failure to follow this instruction could result in personal injury or death.

When installing a child restraint with seatbelts:

- Place the vehicle seat in the upright position before you install the child restraint.
- Use the correct seatbelt buckle for that seating position.
- Insert the belt tongue into the buckle. Make sure the tongue is securely fastened in the buckle.

- Keep the buckle release button pointing up and away from the child restraint, with the tongue between the child restraint and the release button, to prevent accidental unbuckling.
- Put the seatbelt in the automatic locking mode.

## CHILD RESTRAINT ANCHOR POINTS

### WHAT ARE THE CHILD RESTRAINT ANCHOR POINTS

Anchor points allow you to quickly and safely install a child restraint.

# Child Safety

## LOCATING THE CHILD RESTRAINT LOWER ANCHOR POINTS



## LOCATING THE CHILD RESTRAINT TOP TETHER ANCHOR POINTS



## CHILD RESTRAINTS

### CHILD RESTRAINT POSITION INFORMATION

Install the child restraint tightly against the vehicle seat. It may be necessary to lift or remove the head restraint.

### Rear Facing Child Restraints

Combined Weight of Child and Child Restraint	LATCH (Lower Anchors Only)	Seatbelt Only
Up to 65 lb (29 kg)	X	X
Over 65 lb (29 kg)		X



# Child Safety

---

## Forward Facing Child Restraints

Combined Weight of Child and Child Restraint	LATCH (Lower Anchors and Top Tether Anchor)	Seatbelt and Top Tether Anchor	Seatbelt and LATCH (Lower Anchors and Top Tether Anchor)
Up to 65 lb (29 kg)	X	X	X
Over 65 lb (29 kg)		X	X

# Child Safety

## CHILD RESTRAINTS RECOMMENDATION

Child Size, Height, Weight, or Age	Recommended Restraint Type
Children weighing 40 lb (18 kg) or less (generally age four or younger).	Use a child restraint (sometimes called an infant carrier, convertible seat, or toddler seat).
Children who have outgrown or no longer properly fit in a child restraint (generally children who are less than 57 in (1.45 m) tall, are greater than age four and less than age 12, and between 40 lb (18 kg) and 80 lb (36 kg) and upward to 100 lb (45 kg) if recommended by your child restraint manufacturer).	Use a belt-positioning booster seat.
Children who have outgrown or no longer properly fit in a belt-positioning booster seat (generally children who are at least 57 in (1.45 m) tall or greater than 80 lb (36 kg) or 100 lb (45 kg) if recommended by child restraint manufacturer).	Use a vehicle seatbelt having the lap belt snug and low across the hips, shoulder belt centered across the shoulder and chest, and seat backrest upright.

You are required by law to properly use child restraints for infants and toddlers in the United States, Canada and Mexico.

Many states and provinces require that small children use approved booster seats until they reach age eight, a height of 57 in (1.45 m) tall, or 80 lb (36 kg). Check your local and state or provincial laws for specific requirements about the safety of children in your vehicle.

When possible, properly restrain children 12 years of age and under in a rear seating position of your vehicle. Accident statistics suggest that children are safer when properly restrained in the rear seating positions than in a front seating position.

When installing a rear facing child restraint, adjust the vehicle seats to avoid interference between the child restraint and the vehicle seat in front of the child restraint.

# Child Safety

## INSTALLING CHILD RESTRAINTS

### USING SEATBELTS



**WARNING:** Depending on where you secure a child restraint, and depending on the child restraint design, you may block access to certain seatbelt buckle assemblies and LATCH lower anchors, rendering those features potentially unusable. To avoid risk of injury, make sure occupants only use seating positions where they are able to be properly restrained.

**Note:** *Although the child restraint illustrated is a forward-facing child restraint, the steps are the same for installing a rear-facing child restraint.*

Perform the following steps when installing the child restraint with seatbelts:

1. Position the child restraint in a seat with a seatbelt.



2. After positioning the child restraint in the proper seating position, pull down on the shoulder belt and then grasp the shoulder belt and lap belt together behind the belt tongue.



3. While holding the shoulder and lap belt portions together, route the tongue through the child restraint according to the child restraint manufacturer's instructions. Make sure that you did not twist the belt webbing.

# Child Safety

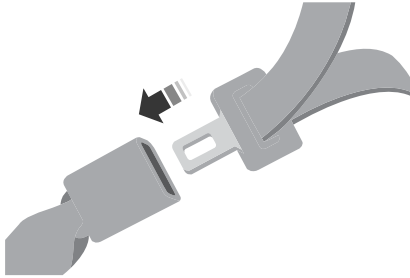

4. Insert the belt tongue into the proper buckle (the buckle closest to the direction the tongue is coming from) for that seating position until you hear a snap and feel the latch engage. Make sure the tongue is latched securely by pulling on it.



5. To put the retractor in the automatic locking mode, grasp the shoulder portion of the belt and pull downward until you pull all of the belt out.

**Note:** *The automatic locking mode is available on the front passenger and rear seats.*

6. Allow the belt to retract to remove slack. The belt clicks as it retracts to indicate it is in the automatic locking mode.

7. Try to pull the belt out of the retractor to make sure the retractor is in the automatic locking mode. You should not be able to pull more belt out. If the retractor did not lock, unbuckle the belt and repeat Steps 5 and 6.



8. Remove remaining slack from the belt. Force the seat down with extra weight, for example, by pressing down or kneeling on the child restraint while pulling up on the shoulder belt in order to force slack from the belt. This is necessary to remove the remaining slack that exists once you add the extra weight

# Child Safety

of the child to the child restraint. It also helps to achieve the proper snugness of the child restraint to your vehicle. Sometimes, a slight lean toward the buckle will provide extra help to remove remaining slack from the belt.

9. If the child restraint has a tether strap, attach it.

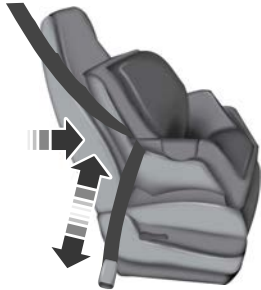

10. Before placing the child in the seat, forcibly move the seat forward and back to make sure the seat is securely held in place. To check this, grab the seat at the belt path and attempt to move it side to side and forward and back. There should be no more than 1 in (2.5 cm) of movement.

We recommend checking with a NHTSA Certified Child Passenger Safety Technician to make certain the child restraint is properly installed. In Canada, check with Transport Canada for referral to a Child Car Seat Clinic.

## USING LOWER ANCHORS AND TETHERS FOR CHILDREN

**WARNING:** Do not attach two child safety restraints to the same anchor. In a crash, one anchor may not be strong enough to hold two child safety restraint attachments and may break, causing serious injury or death.

**WARNING:** Depending on where you secure a child restraint, and depending on the child restraint design, you may block access to certain seatbelt buckle assemblies and LATCH lower anchors, rendering those features potentially unusable. To avoid risk of injury, make sure occupants only use seating positions where they are able to be properly restrained.

The LATCH (Lower Anchors and Tethers for Children) system has three vehicle anchor points.

- Two lower anchors where the seat backrest and seat cushion meet, called the seat bight.
- One top tether anchor behind that seating position.

# Child Safety

LATCH-compatible child restraints have two rigid or webbing mounted attachments that connect to the two lower anchors at the LATCH-equipped seating positions in your vehicle. This type of attachment method eliminates the need to use seatbelts to attach the child restraint.

However, you can still use the seatbelt to attach the child restraint. For forward-facing child restraints, you must also attach the top tether strap to the proper top tether anchor if a top tether strap has been provided with your child restraint.

Follow the instructions on attaching child restraints with tether straps.

## INSTALLING A CHILD RESTRAINT IN A CENTER SEAT



**WARNING:** The standardized spacing for LATCH lower anchors is 11 in (280 mm) center to center. Do not use LATCH lower anchors for the center seating position unless the child restraint manufacturer's instructions permit and specify using anchors spaced at least as far apart as those in this vehicle.

The lower anchors at the center of the second row rear seat are spaced 20 in (51 cm) apart. You cannot install a child restraint with rigid LATCH attachments at the center seating position. You can only use LATCH-compatible child restraints with attachments on belt webbing at this seating position provided that the child restraint manufacturer's instructions permit use with the anchor spacing stated. Do not attach a child restraint to any lower anchor if an adjacent child restraint is attached to that anchor.

Each time you use the child restraint, check that the seat is properly attached to the lower anchors and tether anchor, if applicable. Tug the child restraint from side to side and forward and back where it is secured to your vehicle. The seat should move less than 1 in (2.5 cm).

If you did not properly anchor the child restraint, the risk of a child being injured in a crash greatly increases.

## COMBINING THE SEATBELT AND LOWER ANCHORS FOR ATTACHING CHILD RESTRAINTS

When used in combination, you may attach either the seatbelt or the LATCH lower anchors first, provided a proper installation is achieved. Attach the tether strap afterward, if it is included with the child restraint.

# Child Safety

## USING TETHER STRAPS

Many forward-facing child restraints include a tether strap which extends from the back of the child restraint and hooks to an anchoring point called the top tether anchor. Tether straps are available as an accessory for many older child restraints.

Contact the manufacturer of your child restraint for information about ordering a tether strap, or to obtain a longer tether strap if the tether strap on your child restraint does not reach the appropriate top tether anchor in your vehicle.

Once you install the child restraint using either the seatbelt, the lower anchors of the LATCH system, or both, you can attach the top tether strap.

**Note:** *If you install a child restraint with rigid LATCH attachments, do not tighten the tether strap enough to lift the child restraint off your vehicle seat cushion when the child is seated in it. Keep the tether strap just snug without lifting the front of the child restraint. Keeping the child restraint just touching your vehicle seat gives the best protection in a severe crash.*

Perform the following steps to install a child restraint with tether anchors.

1. Route the tether strap over the back of the seat. For the outermost seating positions, route the tether strap under the head restraint and between the head restraint posts. For the center seating position, route the tether strap over the top of the head restraint.

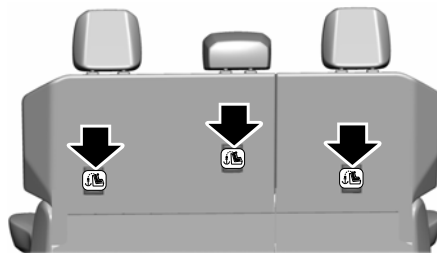

2. Locate the correct anchor for the selected seating position.



3. Clip the tether strap to the anchor as shown.
4. Tighten the child restraint tether strap according to the manufacturer's instructions.

If your child restraint system has a tether strap, and the child restraint manufacturer recommends its use, we also recommend its use.

# Child Safety

## BOOSTER SEATS

Use a belt-positioning booster seat for children who have outgrown or no longer properly fit in a child restraint and meet the following criteria.

- Generally children who are less than 57 in (1.45 m) tall.
- Are greater than age four (4) and less than age twelve (12).
- Are between 40 lb (18 kg) and 80 lb (36 kg) and upward to 100 lb (45 kg).

Many state and provincial laws require that children use approved booster seats until they reach age eight, a height of 57 in (1.45 m) tall, or 80 lb (36 kg).

Booster seats should be used until you can answer yes to all of these questions when seated without a booster seat:

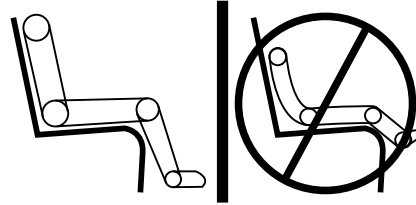

- Can the child sit all the way back against their vehicle seat backrest with knees bent comfortably at the edge of the seat cushion?
- Can the child sit without slouching?
- Does the lap belt rest low across the hips?
- Is the shoulder belt centered on the shoulder and chest?
- Can the child stay seated like this for the whole trip?

Always use booster seats in conjunction with your vehicle lap and shoulder belt.

## Types of Booster Seats



- Backless booster seats

If your backless booster seat has a removable shield, remove the shield.

If a vehicle seating position has a low seat backrest or no head restraint, a backless booster seat may place your child's head, as measured at the tops of the ears, above the top of the seat. In this case, move the backless booster to another seating position with a higher seat backrest or head restraint and lap and shoulder belts, or consider using a high-back booster seat.



# Child Safety



- High-back booster seats

If, with a backless booster seat, you cannot find a seating position that adequately supports your child's head, a high-back booster seat would be a better choice.

Children and booster seats vary in size and shape. Choose a booster that keeps the lap belt low and snug across the hips, never up across the stomach, and lets you adjust the shoulder belt to cross the chest and rest snugly near the center of the shoulder.

The following drawings compare the ideal fit to a shoulder belt uncomfortably close to the neck and a shoulder belt that could slip off the shoulder. The drawings also show how the lap belt should be low and snug across the child's hips.



# Child Safety



If the booster seat slides on the vehicle seat upon which it is being used, placing a rubberized mesh sold as shelf or carpet liner under the booster seat may improve this condition. Do not use any item thicker than this under the booster seat. Check with the booster seat manufacturer's instructions.

## CHILD SAFETY LOCKS



E390729

The control is on the driver door. It enables both the child safety locks and the rear window locks.

Press the control to switch the child safety locks and the rear window locks on. Press the control again to switch them off. A light on the control illuminates when you switch them on.

The child locks and the rear window locks setting remain on when you switch off your vehicle.

**Note:** To make sure the child safety lock is on, pull the inside door handle twice to verify the door does not open.



**WARNING:** You cannot open the rear doors from inside if you have put the child safety locks on.

# Child Safety

---

**Note:** *To open the rear doors from inside the vehicle when the child lock is engaged, roll down the rear window and use the outside door handle. Or have someone outside the vehicle open the door.*

## CHILD SAFETY LOCKS – TROUBLESHOOTING

### CHILD SAFETY LOCKS – INFORMATION MESSAGES

Message	Action
Child Lock fault See manual	Try to switch the child safety locks on again. If the message continues to appear, have your vehicle checked as soon as possible.

# Seatbelts

## SEATBELT PRECAUTIONS

 **WARNING:** Always drive and ride with your seatback upright and the lap belt snug and low across the hips.

 **WARNING:** Children must always be properly restrained.

 **WARNING:** Do not allow a passenger to hold a child on their lap when your vehicle is moving. Failure to follow this instruction could result in personal injury or death in the event of a sudden stop or crash.

 **WARNING:** All occupants of your vehicle, including the driver, should always properly wear their seatbelts, even when an airbag supplemental restraint system is provided. Failure to properly wear your seatbelt could seriously increase the risk of injury or death.

 **WARNING:** It is extremely dangerous to ride in a cargo area, inside or outside of a vehicle. In a crash, people riding in these areas are more likely to be seriously injured or killed. Do not allow people to ride in any area of your vehicle that is not equipped with seats and seatbelts. Make sure everyone in your vehicle is in a seat and properly using a seatbelt. Failure to follow this warning could result in serious personal injury or death.

 **WARNING:** In a rollover crash, an unbelted person is significantly more likely to die than a person wearing a seatbelt.

 **WARNING:** Each seating position in your vehicle has a specific seatbelt assembly made up of one buckle and one tongue designed to be used as a pair. Use the shoulder belt on the outside shoulder only. Never wear the shoulder belt under the arm. Never use a single seatbelt for more than one person.

 **WARNING:** Even with advanced restraints systems, properly restrain children 12 and under in a rear seating position. Failure to follow this could seriously increase the risk of injury or death.

 **WARNING:** Seatbelts and seats may be hot in a vehicle that is in the sunshine. The hot seatbelts or seats may burn a small child. Check seat covers and buckles before you place a child anywhere near them.

 **WARNING:** If your vehicle is involved in a crash, have the seatbelts and associated components inspected as soon as possible. Failure to follow this instruction could result in personal injury or death.

All seating positions in your vehicle have lap and shoulder seatbelts. All occupants of the vehicle should always properly wear their seatbelts, even when an airbag supplemental restraint system is provided.

# Seatbelts

The seatbelt system consists of:

- Lap and shoulder seatbelts.
- Shoulder seatbelt with automatic locking mode, except driver seatbelt.
- Height adjuster at the front outermost seating positions.
- Seatbelt pretensioners at the front outermost and second row outermost seating positions.
- Belt tension sensor at the front outermost passenger seating position.



- Seatbelt warning light and chime.



- Crash sensors and monitoring system with readiness indicator.

The seatbelt pretensioners are designed to tighten the seatbelts when activated. In frontal and near-frontal crashes, the seatbelt pretensioners may be activated alone or, if the crash is of sufficient severity, together with the front airbags. The pretensioners may also activate when a Safety Canopy airbag deploys.

## FASTENING AND UNFASTENING THE SEATBELTS



**WARNING:** Make sure that the seatbelts are securely stowed away when not in use and not outside your vehicle when closing the doors.



**WARNING:** Accessory seat covers not released by Ford Motor Company could prevent the seatbelt from retracting correctly. This could cause the seatbelt to become slack which could increase the risk of injuries in a crash.

All seatbelts in your vehicle are a three-point combination lap and shoulder seatbelt.

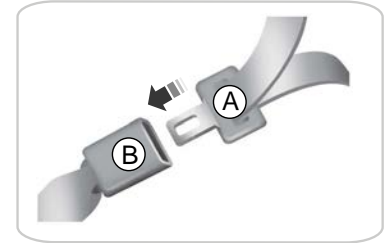
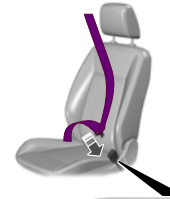

- A Seatbelt tongue.
- B Seatbelt buckle.

1. Pull the seatbelt out steadily.

**Note:** *It may lock if you pull it sharply or if the vehicle is on a slope.*

2. Insert the tongue into the buckle.

# Seatbelts

3. Pull the seatbelt tight to remove any slack.

## Unfastening the Seatbelts

1. Press the red button on the buckle to release the seatbelt.
2. Hold the seatbelt tongue and let it retract completely and smoothly to its stowed position.

## Using a Sliding Clip (If Equipped)

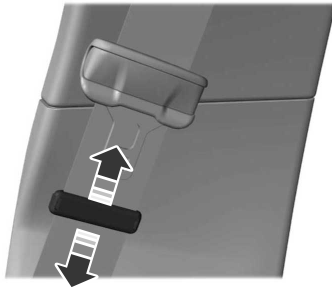

Slide the clip away from the tongue so there is no loose webbing when an occupant or child seat is buckled up. You can also use the sliding clip to raise the tongue and prevent it from rattling or to ease access to the tongue.

## Rear Seats

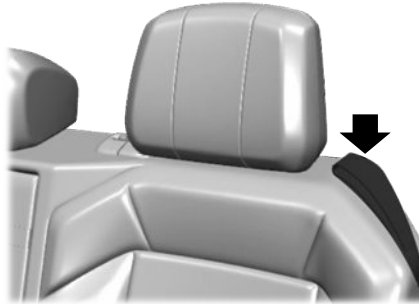

A web guide is included on the outermost side of the rear seats. Depending on occupant size and seating position, you may need to route the belt through the guide for a proper fit. If the seatbelt does not route across the middle of the shoulder, route the belt through the web guide.

## SENSITIVE LOCKING MODE

### WHAT IS SENSITIVE LOCKING MODE

Sensitive locking mode is a seatbelt retractor feature that allows shoulder belt length adjustment according to your movements and locking in response to vehicle movement.

### HOW DOES SENSITIVE LOCKING MODE WORK

If the driver suddenly brakes, turns a corner sharply, or the vehicle receives an impact of about 5 mph (8 km/h) or more, the seatbelts lock to help reduce forward movement of the driver and passengers.

# Seatbelts

In addition, the seatbelt retractor locks if you pull the seatbelt webbing out too quickly. If the retractor locks, slowly lower the height adjuster to allow the seatbelt to retract.

If the retractor does not unlock, pull the seatbelt out slowly then feed a small length of webbing back toward the stowed position.

## AUTOMATIC LOCKING MODE

### WHAT IS AUTOMATIC LOCKING MODE

This is a safety feature built into the seatbelt retractors that keeps the seatbelts pre-locked.

## ENGAGING AUTOMATIC LOCKING MODE



1. Fasten the combination lap and shoulder belt.
2. Grasp the shoulder portion and pull downward until you pull the entire belt out.
3. Allow the belt to retract. As the belt retracts, you will hear a clicking sound. This indicates the seatbelt is now in the automatic locking mode.

## DISENGAGING AUTOMATIC LOCKING MODE

Unbuckle the combination lap and shoulder belt and allow it to retract completely to disengage the automatic locking mode and activate the vehicle sensitive locking mode.

## ADJUSTING THE SEATBELTS DURING PREGNANCY



**WARNING:** Always ride and drive with your seatback upright and properly fasten your seatbelt. Fit the lap portion of the seatbelt snugly and low across the hips. Position the shoulder portion of the seatbelt across your chest. Pregnant women must follow this practice. See the following figure.

# Seatbelts

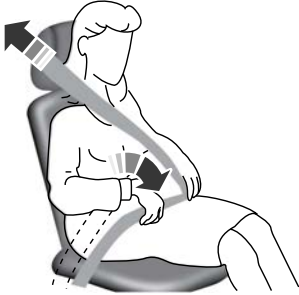

## ADJUSTING THE SEATBELT HEIGHT

 **WARNING:** Position the seatbelt height adjuster so that the seatbelt rests across the middle of your shoulder. Failure to adjust the seatbelt correctly could reduce its effectiveness and increase the risk of injury in a crash.

Pregnant women should always wear their seatbelt. Position the lap belt portion of a combination lap and shoulder belt low across the hips below the belly and worn as tight as comfort allows. Position the shoulder belt to cross the middle of the shoulder and the center of the chest.

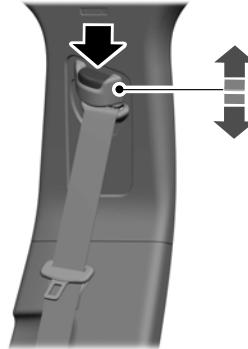

1. Press the button and slide the height adjuster up or down.
2. Release the button and pull down on the height adjuster to make sure it is locked in place.

## SEATBELT REMINDER

### HOW DOES THE SEATBELT REMINDER WORK

 **WARNING:** The system will only provide protection when you use the seatbelt correctly.

This system monitors all seating positions and provides audio and graphic feedback.

## SEATBELT REMINDER INDICATORS



This lamp illuminates if you do not fasten your seatbelt when you switch the power on. The lamp switches off when you fasten your seatbelt.



# Seatbelts

When the initial warning expires for the driver, more warnings are provided. This lamp illuminates if you or any passenger do not fasten the seatbelt buckle.

**Note:** To avoid inadvertent warnings, do not place large objects on the seats.



This image displays when you switch the power on and any seat is unfastened. You can acknowledge this image with the steering wheel button by pressing OK. It also displays when a seating position changes from unfastened to fastened.

## SEATBELT REMINDER AUDIBLE WARNINGS

Depending on your vehicle options, a warning tone sounds if you do not fasten your seatbelt when you switch the power on. The tone switches off when you fasten your seatbelt or a short period of time elapses.

A warning tone sounds and the warning lamp illuminates if you are not wearing your seatbelt when your vehicle exceeds a relatively low speed.

The warning tone sounds for a short period of time or until you fasten your seatbelt.

## SWITCHING THE SEATBELT REMINDER ON AND OFF

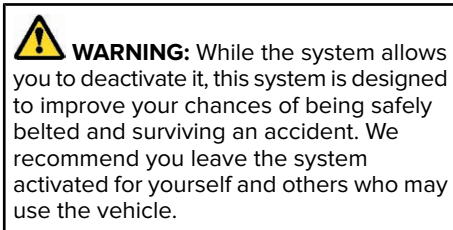

**Note:** An audible warning for each seat switches off independently. When you perform this procedure for one seating position, do not buckle the other position as this cancels the process.

Read Steps 1 - 4 before proceeding with the programming procedure.

Make sure that:

- You set the parking brake.
  - The transmission is in park (P).
  - The ignition is off.
  - You close all vehicle doors.
  - You unfasten the driver and front passenger seatbelts.
1. Switch the ignition on. Do not start the engine.
  2. Wait about one minute until the seatbelt warning light switches off. After Step 2, wait an additional five seconds before proceeding with Step 3. Once you start Step 3, you must complete the procedure within 30 seconds.

# Seatbelts

- For the seating position you are switching off, fasten then unfasten the seatbelt four times at a moderate speed, ending in the unfastened state. After Step 3, the seatbelt warning light switches on.
- When the seatbelt warning light is on, fasten then unfasten the seatbelt. After Step 4, the seatbelt warning light flashes for confirmation.

This switches the seatbelt reminder audible warning off for that seating position if it is currently on.

This switches the seatbelt reminder audible warning on for that seating position if it is currently off.

## CHECKING SEATBELT STATUS (If Equipped)

To view the seatbelt status, use the instrument cluster display controls on the steering wheel.

- Press the menu button on the steering wheel to enter the instrument cluster display main menu.
- Select Status Information.

- Select Seatbelts.



- A Seatbelt fastened.
- B Seatbelt not fastened.
- C Fault.
- D Seatbelt recently unfastened.

## CHECKING THE SEATBELTS

Check the seatbelts and child restraints periodically to make sure they work properly and are not damaged. Make sure there are no nicks, tears or cuts. Replace if necessary.

Check the following seatbelt assemblies after a crash.

- Retractors.
- Buckles.
- Front seatbelt buckle assemblies.
- Shoulder belt height adjusters.
- Shoulder belt guide on seat backrest.
- Child restraint LATCH and tether anchors.
- Attaching hardware.

Read the child restraint manufacturer's instructions for additional inspection and maintenance information specific to the child restraint.

# Seatbelts

We recommend that all seatbelt assemblies in use in vehicles involved in a crash be replaced. However, if the crash was minor and an authorized dealer finds that the belts do not show damage and continue to operate properly, they do not need to be replaced. Seatbelt assemblies not in use during a crash should also be checked and replaced if either damage or improper operation is noted.

Properly care for seatbelts. See **Cleaning Seatbelts** (page 400).

## SEATBELT EXTENSIONS

 **WARNING:** Persons who fit into the vehicle's seatbelt should not use an extension. Unnecessary use could result in serious personal injury in the event of a crash.

 **WARNING:** Only use extensions provided free of charge by our dealers. The dealer will provide an extension designed specifically for this vehicle, model year and seating position. The use of an extension intended for another vehicle, model year or seating position may not offer you the full protection of your vehicle's seatbelt restraint system.

 **WARNING:** Never use seatbelt extensions to install child restraints.

 **WARNING:** Do not use extensions to change the way the seatbelt fits across the torso, over the lap or to make the seatbelt buckle easier to reach.

If, because of body size or driving position, it is not possible to properly fasten the seatbelt over your lap and shoulder, an extension that is compatible with the seatbelts is available free of charge from our dealers. Only use our seatbelt extensions made by the original equipment seatbelt manufacturer with our seatbelts. Ask your authorized dealer if your extension is compatible with your vehicle restraint system.

# Seatbelts

---

## SEATBELTS – TROUBLESHOOTING

## SEATBELTS – INFORMATION MESSAGES

Message	Details
Rear Belt Monitor Fault Service Required	The system has detected a fault that requires service. Have your vehicle checked as soon as possible.

## WHAT IS THE PERSONAL SAFETY SYSTEM

An advanced safety system that protects occupants in frontal crashes.

## HOW DOES THE PERSONAL SAFETY SYSTEM WORK

This system provides an improved level of frontal crash protection to front seat occupants and is designed to reduce the risk of airbag-related injuries. The system analyzes occupant conditions and crash severity before activating the appropriate safety devices. During a crash, the restraints control module may deploy the seatbelt pretensioners, and one or both stages of the dual-stage airbags based on crash severity and occupant conditions.

## PERSONAL SAFETY SYSTEM COMPONENTS

- Driver and passenger dual-stage airbag supplemental restraints.
- Front seat outermost seatbelts with pretensioners, energy management retractors and seatbelt usage sensors.
- Driver seat position sensor.
- Passenger seat position sensor.
- Front passenger sensing system.
- Passenger airbag off and on indicators.
- Front crash severity sensors.
- Restraints control module with impact and safing sensors.
- Restraint system warning light and tone.
- The electrical wiring for the airbags, crash sensors, seatbelt pretensioners, front seatbelt usage sensors, front passenger sensing system and indicator lights.

# Airbags

## HOW DO THE FRONT AIRBAGS WORK

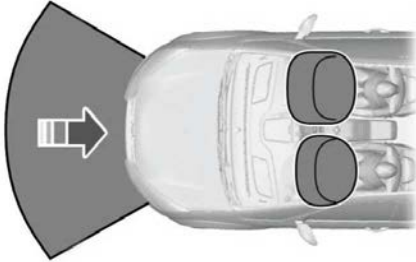

The driver and front passenger airbags deploy during significant frontal and near frontal crashes.

The driver and passenger front airbag system consists of:

- Driver and passenger airbag modules.
- Front passenger sensing system.
- Crash sensors and monitoring system with readiness indicator. See **Crash Sensors and Airbag Indicator** (page 66).

The airbags are a supplemental restraint system and are designed to work with the seatbelts to help protect the driver and right front passenger from certain upper body injuries. Airbags do not inflate slowly; there is a risk of injury from a deploying airbag.

**Note:** *You will hear a loud bang and see a cloud of harmless powdery residue if an airbag deploys. This is normal.*

The airbags inflate and deflate rapidly upon activation. After airbag deployment, it is normal to notice a smoke-like, powdery residue or smell the burnt propellant. This may consist of cornstarch, talcum powder (to lubricate the bag) or sodium compounds (for example, baking soda) that result from the combustion process that inflates the airbag. Small amounts of sodium hydroxide may be present which may irritate the skin and eyes, but none of the residue is toxic.

Contact with a deploying airbag may cause abrasions or swelling. Temporary hearing loss is also a possibility as a result of the noise associated with a deploying airbag.

Because airbags must inflate rapidly and with considerable force, there is the risk of death or serious injuries such as fractures, facial and eye injuries or internal injuries, particularly to occupants who are not properly restrained or are otherwise out of position at the time of airbag deployment. Thus, it is extremely important that occupants be properly restrained as far away from the airbag module as possible.

Routine maintenance of the airbags is not required.

## HOW DO THE SIDE AIRBAGS WORK



**WARNING:** Do not place objects or mount equipment on or near the airbag cover, on the side of the front or rear seatbacks, or in areas that may come into contact with a deploying airbag. Failure to follow these instructions may increase the risk of personal injury in the event of a crash.

# Airbags



**WARNING:** Accessory seat covers not released by Ford Motor Company could prevent the deployment of the airbags and increase the risk of injuries in a crash.



**WARNING:** Do not lean your head on the door. The side airbag could injure you as it deploys from the side of the seatback.

The side airbags are on the outermost side of the front seat backrests. In certain sideways crashes or rollovers, the airbags inflate. The airbag was designed to inflate between the door panel and occupant to further enhance the protection provided occupants in side impact crashes.



The system consists of:

- A label or embossed side panel indicating that there are side airbags in your vehicle.
- Side airbags inside the driver and front passenger seat backrests.
- Crash sensors and monitoring system with readiness indicator. See **Crash Sensors and Airbag Indicator** (page 66).

## HOW DO THE KNEE AIRBAGS WORK



**WARNING:** Close the glove box door when your vehicle is moving. Failure to follow this instruction could reduce the effectiveness of the passenger knee airbag and increase the risk of injury in a crash.

A driver knee airbag is under or within the instrument panel. A passenger knee airbag is within or under the glove compartment. During a crash, the restraints control module may activate the driver and passenger knee airbags based on crash severity and occupant conditions. Under certain crash and occupant conditions, the driver and passenger knee airbag may deploy but the front airbags may not activate. As with front and side airbags, it is important to be properly seated and restrained to reduce the risk of death or serious injury.

# Airbags



Make sure the knee airbags are operating properly. See **Crash Sensors and Airbag Indicator** (page 66).

## HOW DOES THE SAFETY CANOPY™ WORK



**WARNING:** Do not place objects or mount equipment on or near the headliner at the siderail that may come into contact with a deploying curtain airbag. Failure to follow these instructions may increase the risk of personal injury in the event of a crash.



**WARNING:** Do not lean your head on the door. The curtain airbag could injure you as it deploys from the headliner.



**WARNING:** To reduce risk of injury, do not obstruct or place objects in the deployment path of the airbag.

The Safety Canopy deploys during significant side crashes or when a certain likelihood of a rollover event is detected by the rollover sensor. The Safety Canopy is mounted to the roof side-rail sheet metal, behind the headliner, above each row of seats. In certain sideways crashes or rollover events, the Safety Canopy will be activated, regardless of which seats are occupied. The Safety Canopy inflates between the side window area and occupants to further enhance protection provided in side impact crashes and rollover events.

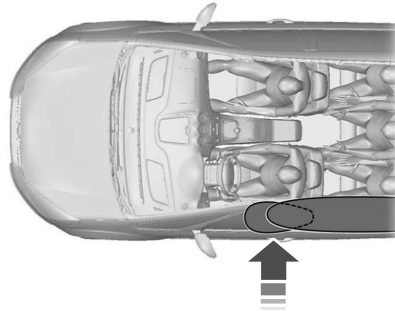

The system consists of the following:

- Safety Canopy curtain airbags above the trim panels over the front and rear side windows identified by a label or wording on the headliner or roof-pillar trim.
- A flexible headliner which opens above the side doors to allow air curtain deployment



• Crash sensors and monitoring system with a readiness indicator. See **Crash Sensors and Airbag Indicator** (page 66).

Properly restrain children 12 years old and under in the rear seats. The Safety Canopy will not interfere with children restrained using a properly installed child or booster seat because it is designed to inflate downward from the headliner above the doors along the side window opening.





# Airbags

## AIRBAG PRECAUTIONS

 **WARNING:** Airbags do not inflate slowly or gently, and the risk of injury from a deploying airbag is the greatest close to the trim covering the airbag module.

 **WARNING:** All occupants of your vehicle, including the driver, should always properly wear their seatbelts, even when an airbag supplemental restraint system is provided. Failure to properly wear your seatbelt could seriously increase the risk of injury or death.

 **WARNING:** Properly secure children 12 years old and under in a rear seating position whenever possible. If you are unable to properly secure all children in a rear seating position, properly secure the largest child on the front seat. If you must use a forward facing child restraint on the front seat, move the seat as far back as possible. Failure to follow these instructions could result in personal injury or death.

 **WARNING:** Do not place your arms on the airbag cover or through the steering wheel. Failure to follow this instruction could result in personal injury.

 **WARNING:** Keep the areas in front of the airbags free from obstruction. Do not affix anything to or over the airbag covers. Objects could become projectiles during airbag deployment. Failure to follow this instruction could result in personal injury or death.

 **WARNING:** To reduce risk of injury, do not obstruct or place objects in the deployment path of the airbag.

 **WARNING:** Do not place a rearward facing child restraint in front of an active airbag. Failure to follow this instruction could result in personal injury or death.

 **WARNING:** Do not attempt to service, repair, or modify the supplementary restraint system or associated components. Failure to follow this instruction could result in personal injury or death.

 **WARNING:** Several airbag system components get hot after inflation. To reduce the risk of injury, do not touch them after inflation.

 **WARNING:** If a supplementary restraint system component has deployed, it will not function again. Have the system and associated components inspected as soon as possible. Failure to follow this instruction could result in personal injury or death.

# Airbags

## PROPERLY ADJUSTING THE DRIVER AND FRONT PASSENGER SEATS

 **WARNING:** National Highway Traffic Safety Administration (NHTSA) recommends a minimum distance of at least 10 in (25 cm) between an occupant's chest and the driver airbag module.

To properly position yourself away from the airbag:

- Move your seat to the rear as far as you can while still reaching the pedals comfortably.
- Recline the seat slightly one or two degrees from the upright position.

After all occupants have adjusted their seats and put on seatbelts, it is very important that they continue to sit properly. Properly seated occupants sit upright, lean against the seat backrest, and center themselves on the seat cushion, with their feet comfortably extended on the floor. Sitting improperly can increase

the chance of injury in a crash event. For example, if an occupant slouches, lies down, turns sideways, sits forward, leans forward or sideways, or puts one or both feet up, the chance of injury during a crash greatly increases.

## CHILDREN AND AIRBAGS

 **WARNING:** Do not place a rearward facing child restraint in front of an active airbag. Failure to follow this instruction could result in personal injury or death.



Children must always be properly restrained. Accident statistics suggest that children are safer when properly restrained in the rear seating positions than in the front seating position. Failure to follow these instructions may increase the risk of injury in a crash.

## FRONT PASSENGER SENSING SYSTEM

### WHAT IS THE FRONT PASSENGER SENSING SYSTEM

This system detects a properly seated occupant and determines if the front passenger airbag should be enabled.

### HOW DOES THE FRONT PASSENGER SENSING SYSTEM WORK

The system uses a passenger airbag status indicator that illuminates indicating that the front passenger frontal airbag is either enabled or disabled.

# Airbags

**Note:** When you first switch the ignition on, the passenger airbag status indicator off and on lamps illuminate for a short period to confirm they are functional.



The indicator lamps are in the overhead console.

The front passenger sensing system is designed to disable the front passenger frontal airbag under these conditions:

- The front passenger seat is unoccupied.
- The system determines an infant is present in a child restraint.
- A passenger takes their weight off of the seat for a period of time.
- If there is a problem with the airbag system or the passenger sensing system.

**Note:** Even with this technology, parents are strongly encouraged to always properly restrain children in the rear seat.

- When the front passenger sensing system disables the front passenger frontal airbag, the passenger airbag status indicator illuminates the off lamp.
- If you have installed the child restraint and the passenger airbag status indicator illuminates the on lamp, switch your vehicle off, remove the child restraint from your vehicle and reinstall the restraint following the child restraint manufacturer's instructions.

The front passenger sensing system works with sensors that are part of the front passenger seat and seatbelt. The sensors are designed to detect the presence of a properly seated occupant and determine if the front passenger frontal airbag should be enabled.

- When the front passenger sensing system enables the front passenger frontal airbag, the passenger airbag status indicator illuminates the on lamp.

If a person of adult size is sitting in the front passenger seat, but the passenger airbag status indicator off lamp is illuminated, it is possible that the person is not sitting properly in the seat. If this happens:

- Switch your vehicle off and ask the person to place the seat backrest in an upright position.
- Have the person sit upright in the seat, centered on the seat cushion, with the person's legs comfortably extended.
- Restart your vehicle and have the person remain in this position for about two minutes. This allows the system to detect that person and enable the passenger frontal airbag.
- If the indicator off lamp remains illuminated even after this, you should advise the person to ride in the rear seat.

After all occupants have adjusted their seats and put on seatbelts, it is very important that they continue to sit upright, leaning against the seat backrest, and centered on the seat cushion, with their feet comfortably extended on the floor.

# Airbags

Sitting improperly can increase the chance of injury in a crash event. For example, if an occupant slouches, lies down, turns sideways, sits forward, leans forward or sideways, or puts one or both feet up, the chance of injury during a crash greatly increases.

If you think that the state of the passenger airbag status indicator lamp is incorrect, check for the following:

- Objects lodged underneath the seat.
- Objects between the seat cushion and the center console.
- Objects placed on the occupant's lap.
- Cargo interference with the seat.
- Other passengers pushing or pulling on the seat.
- Rear passenger feet and knees resting or pushing on the seat.

The listed conditions could cause the weight of a properly seated occupant to be incorrectly interpreted by the front passenger sensing system. The person in the front passenger seat could appear heavier or lighter due to the conditions listed.



Make sure the front passenger sensing system is operating properly. See **Crash Sensors and Airbag Indicator** (page 66).

If the airbag readiness light is on, do the following:

- Pull your vehicle over.
- Switch your vehicle off.
- Check for any objects lodged underneath the front passenger seat or cargo interfering with the seat.
- Remove the obstruction if found.
- Restart your vehicle.
- Wait at least two minutes and verify that the airbag readiness light in the instrument cluster is no longer illuminated.
- If the airbag readiness light in the instrument cluster remains illuminated, there may be a problem due to the front passenger sensing system.

Do not attempt to repair or service the system. Take your vehicle in for service immediately.

If it is necessary to modify an advanced front airbag system to accommodate a person with disabilities, contact your Customer Relationship Center. See **Contacting Us** (page 17).

## FRONT PASSENGER SENSING SYSTEM PRECAUTIONS



**WARNING:** Sitting improperly, out of position or with the seatback reclined too far can take weight off the seat cushion and affect the decision of the passenger sensing system, resulting in serious injury or death in the event of a crash. Always sit upright against your seat back, with your feet on the floor.



**WARNING:** Any alteration or modification to the front passenger seat may affect the performance of the front passenger sensing system. This could seriously increase the risk of injury or death.

# Airbags



**WARNING:** Do not place objects under the front passenger seat or between the seat and the center console. Failure to follow this instruction may interfere with

the front passenger seat sensing system and increase the risk of injury or death in a crash.



**WARNING:** Check the passenger airbag indicator lamp for proper airbag status. Failure to follow this instruction could result in personal injury or death.

## FRONT PASSENGER SENSING SYSTEM INDICATORS

Occupant	Passenger Airbag Status Indicator	Passenger Airbag
Empty	OFF: Illuminated	Disabled
	ON: Not Illuminated	
Child	OFF: Illuminated	Disabled
	ON: Not Illuminated	
Adult	OFF: Not Illuminated	Enabled
	ON: Illuminated	

# Airbags

## CRASH SENSORS AND AIRBAG INDICATOR



**WARNING:** Modifying or adding equipment to the front of your vehicle could affect the performance of the airbag system, increasing the risk of injury. This includes the hood, bumper system, frame, front body structure, tow hooks, hood pins, push bar and snowplows.

Your vehicle has a collection of crash and occupant sensors. These sensors provide information to the restraints control module which activates the following:

- Front and rear seatbelt pretensioners.
- Driver airbag.
- Passenger airbag.
- Knee airbag(s).
- Seat mounted side airbags.
- Safety Canopy.

Based on the type of crash, the restraints control module deploys the appropriate safety devices.

The restraints control module also monitors the readiness of the above safety devices plus the crash and occupant sensors. The readiness of the safety system is indicated by a warning indicator light in the instrument cluster or by a backup tone if the warning light is not working. Routine maintenance of the airbag is not required.

A difficulty with the system is indicated by one or more of the following:



The readiness light will not illuminate immediately after you switch the ignition on.

- The readiness light either flashes or stays on.
- You hear a series of five tones. The tone pattern repeats periodically until the problem, the light or both are repaired.

If any of these things happen, even intermittently, have the supplemental restraint system serviced immediately. Unless serviced, the system may not function properly in the event of a crash.

The fact that the seatbelt pretensioners or front airbags did not activate for both front seat occupants in a crash does not mean that something is wrong with the system. Rather, it means the restraints control module determined the accident conditions (crash severity, seatbelt usage) were not appropriate to activate these safety devices.

- The front airbags activate only in frontal and near-frontal crashes. Front airbags may activate in rollovers, side impacts or rear impacts if the crash causes sufficient frontal deceleration.
- The seatbelt pretensioners activate in frontal, near-frontal and side crashes, and in rollovers.
- The knee airbag(s) deploy based on crash severity and occupant conditions.

# Airbags

---

- The side airbags inflate in certain side impact crashes or rollover events. Side airbags may activate in other types of crashes if the vehicle experiences sufficient sideways motion or deformation.
- The Safety Canopy inflates in certain side impact crashes or rollover events. The Safety Canopy may activate in other types of crashes if the vehicle experiences sufficient sideways motion or deformation, or a certain likelihood of rollover.

## **DISPOSING OF AIRBAGS**

Contact your authorized dealer as soon as possible. Airbags must be disposed of by qualified personnel.

# Pedestrian Alert System - Hybrid Electric Vehicle (HEV)

---

## **WHAT IS THE PEDESTRIAN ALERT SYSTEM**

Due to the quiet operation of hybrid and electric vehicles at low speeds, the system creates a subtle sound to alert pedestrians.

The system is on when your vehicle is running and not in park (P). Some sound may be audible in the passenger compartment.



# 911 Assist

## WHAT IS 911 ASSIST

911 Assist is an operating system feature that can call for help.

For more information, refer to the regional Lincoln website.

## HOW DOES 911 ASSIST WORK

If a crash deploys an airbag, excluding knee airbags and rear inflatable seatbelts, or activates the fuel pump shut-off, your vehicle may be able to contact emergency services by dialing 911 through a paired and connected **Bluetooth**® enabled phone.

Not all crashes deploy an airbag or activate the fuel pump shut-off. If a connected cell phone sustains damage or loses its connection to the operating system during a crash, the system searches for and tries to connect to a previously paired cell phone. The operating system then attempts to call the emergency services.

Before making the call:

- The operating system provides about 10 seconds to cancel the call. If you fail to cancel the call, the system attempts to dial 911.
- The operating system says the following, or a similar message: the system will attempt to call 911, to cancel the call, press Cancel on your screen or press and hold the phone button on your steering wheel.

If you do not cancel the call and the operating system makes a successful call a pre-recorded message plays for the 911 operator. The occupants in your vehicle are able to talk with the operator. Be prepared to provide your name, phone number and location immediately because not all 911 systems are capable of receiving this information electronically.

During an emergency call the system transmits vehicle data to the emergency service.

## EMERGENCY CALL REQUIREMENTS



**WARNING:** Do not wait for 911 Assist to make an emergency call if you can do it yourself. Dial emergency services immediately to avoid delayed response time which could increase the risk of serious injury or death after a crash. If you do not hear 911 Assist within five seconds of the crash, the system or phone may be damaged or non-functional.



**WARNING:** Always place your phone in a secure location in your vehicle so it does not become a projectile or get damaged in a crash. Failure to do so may cause serious injury to someone or damage the phone which could prevent 911 Assist from working properly.



**WARNING:** Unless the 911 Assist setting is set on before a crash, the system will not dial for help which could delay response time, potentially increasing the risk of serious injury or death after a crash.

# 911 Assist

---

- The operating system must be powered and working properly at the time of the incident and throughout feature activation and use.
- The 911 Assist feature must be set on before the incident.
- You must pair and connect a **Bluetooth**® enabled and compatible cell phone to the operating system.
- A connected **Bluetooth**® enabled phone must have the ability to make and maintain an outgoing call at the time of the incident.
- A connected **Bluetooth**® enabled phone must have adequate network coverage, battery power and signal strength.
- The vehicle must have battery power and be located in the U.S., Canada or in a territory in which 911 is the emergency number.

**Note:** *If any user sets 911 Assist to on or off, that setting applies for all paired phones. If 911 Assist is switched off and the phone is connected to the operating system, an icon displays on the status bar.*

**Note:** *Every phone operates differently. While 911 Assist works with most cellular phones, some may have trouble using this feature.*

## EMERGENCY CALL LIMITATIONS

The 911 Assist feature only operates in the U.S., Canada or in a territory in which 911 is the emergency number.

This feature does not operate properly if:

- Your cellular phone or 911 Assist hardware sustains damage in a crash.
- The vehicle's battery or the operating system has no power.
- The phone(s) thrown from your vehicle are the ones paired and connected to the system.

# Keys and Remote Controls

## REMOTE CONTROL LIMITATIONS



**WARNING:** Changes or modifications not expressly approved by the party responsible for compliance could void the user's authority to operate the equipment. The term "IC:" before the radio certification number only signifies that Industry Canada technical specifications were met.

This device complies with Part 15 of the FCC Rules and with Industry Canada license-exempt RSS standard(s). Operation is subject to the following two conditions: (1) This device may not cause harmful interference, and (2) This device must accept any interference received, including interference that may cause undesired operation.

Make sure a valid remote control is within 3 ft (1 m) from the front door handles and rear of vehicle.

The system may not function if:

- The remote control remains stationary for about a minute.
- The vehicle battery has no charge.
- The remote control battery has no charge.
- There is interference causing issues with the remote control frequencies.
- The remote control is too close to metal objects or electronic devices, for example keys or a cell phone.

## USING THE REMOTE CONTROL



**WARNING:** Do not leave a key or remote control unattended in the vehicle. Children or pets could operate the power windows, moonroof or other controls. Failure to follow this instruction could result in personal injury or death.

Use your remote control to access various vehicle systems.

**Note:** *The buttons on your remote may vary depending on the vehicle region or options.*

### Unlock



Press the button to unlock all doors. See **Unlocking and Locking the Doors Using the Remote Control** (page 80).

### Lock



Press the button to lock all doors. See **Unlocking and Locking the Doors Using the Remote Control** (page 80).

### Remote Start (If Equipped)



Press the button twice within three seconds to remote start. See **Remotely Starting and Stopping the Vehicle** (page 141).

# Keys and Remote Controls

## Opening and Closing the Liftgate



Press the button twice within three seconds to open and close the liftgate. See **Opening the Liftgate Using the Remote Control** (page 91).

## Panic Alarm (If Equipped)



Press the button to sound the panic alarm. See **Sounding the Panic Alarm** (page 72).

## REMOVING THE KEY BLADE



Push the release button on your passive key and pull the key blade out.

## SOUNDING THE PANIC ALARM



Press the button to sound the panic alarm. Press the button again or switch the ignition on to turn it off.

**Note:** *The panic alarm only operates when the ignition is off.*

## LOCATING YOUR VEHICLE



Press the lock button twice within three seconds. The turn signal lamps flash. We recommend you use this method to locate your vehicle.

# Keys and Remote Controls

## CHANGING THE REMOTE CONTROL BATTERY

**⚠ WARNING:** Keep batteries away from children to prevent ingestion. Failure to follow this instruction could result in personal injury or death. If ingested, immediately seek medical attention.

**⚠ WARNING:** If the battery compartment does not securely close, stop using the remote control and replace it as soon as possible. In the meantime, keep the remote control away from children. Failure to follow this instruction could result in personal injury or death.

The remote control uses one coin-type 3-volt lithium battery CR2450 or equivalent.



1. Push the release button and pull the key blade out.

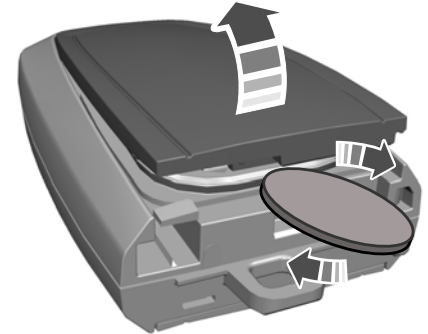
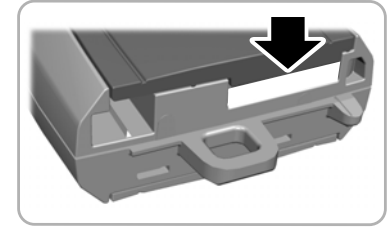

2. Twist a thin coin under the tab hidden behind the key blade head to remove the battery cover.

## Keys and Remote Controls

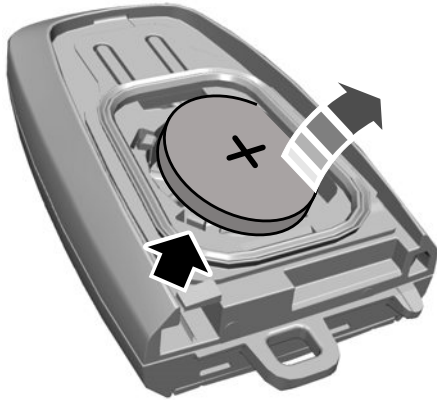

3. Insert a screwdriver, and carefully remove the battery.
4. Install a new battery with the + facing upward.
5. Reinstall the battery housing cover onto the transmitter and install the key blade.



Dispose of old batteries in an environmentally friendly way. Seek advice from your local authority about recycling old batteries.

**Note:** Do not wipe off any grease on the battery terminals or on the back surface of the circuit board.

**Note:** Replacing the battery does not erase the programmed key from your vehicle. The remote control should operate normally.

### REPLACING A LOST KEY OR REMOTE CONTROL

You can purchase replacement keys or remote controls from an authorized dealer. Authorized dealers can program remote controls for your vehicle.

### PROGRAMMING THE REMOTE CONTROL

**Note:** You can program a maximum of four remote controls to your vehicle.

**Note:** If your programmed remote controls are lost or stolen and you do not have an extra coded remote, you need to have your vehicle towed to an authorized dealer. Store an extra programmed remote away from your vehicle in a safe place to help prevent any inconvenience. Contact an authorized dealer to purchase additional spare or replacement remotes.

You must have two previously programmed remote controls inside your vehicle and the new unprogrammed remote controls readily accessible. Contact an authorized dealer to have the spare remote control programmed if two previously programmed remotes are not available. Make sure that your vehicle is off before beginning this procedure. Make sure that you close all the doors before beginning and that they remain closed throughout the procedure. Perform all steps within 30 seconds of starting the sequence. Stop and wait for at least one minute before starting again if you perform any steps out of sequence.

Read and understand the entire procedure before you begin.

# Keys and Remote Controls

1. Place the first programmed remote in the backup slot inside the center console, with your foot off the brake pedal press and release the push button ignition switch. See **Accessing the Passive Key Backup Position** (page 190).
  2. Wait five seconds and then press and release the push button ignition switch again.
  3. Remove the remote control.
  4. Within 10 seconds, place a second programmed remote control in the backup slot. Press and release the push button ignition switch.
  5. Wait five seconds and then press and release the push button ignition switch again. Keep the ignition on for at least three seconds, but no more than 10 seconds.
  6. Remove the remote control.
  7. Place the unprogrammed remote control in the backup slot and press and release the push button ignition switch.
- Programming is now complete. With your foot on the brake pedal, press the push button ignition switch to verify the remote control functions operate and your vehicle starts with the new remote control.

If programming was not successful, wait 10 seconds and repeat Steps 1 through 7. If you are still unsuccessful, take your vehicle to an authorized dealer.

## KEYS AND REMOTE CONTROLS AUDIBLE WARNINGS

### Key In Reminder

Sounds when the following conditions are met:

- Vehicle is out of park (P).
- You switch the vehicle off.
- You open the driver's door.
- You have left the key inside the vehicle.

## KEYS AND REMOTE CONTROLS – TROUBLESHOOTING

### KEYS AND REMOTE CONTROLS – INFORMATION MESSAGES

Message	Action
Key Battery Low Replace Soon	Replace remote control battery.

# Phone as a Key

## WHAT IS PHONE AS A KEY

Phone as a Key allows you to use your phone in place of a passive key.

You can use your phone for the following functions:

- Remote locking and unlocking.
- Passive entry and exit.
- Passive start and drive the vehicle.
- Remote start.
- Memory function recall.

## PHONE AS A KEY LIMITATIONS

Limitations can vary based on the make and model of your phone, phone location and physical obstructions.

The following items could impact Phone as a Key performance or prevent functionality in some cases:

- The typical operating range for Phone as a Key is 131 ft (40 m).

- Your **Bluetooth**<sup>®</sup> connection is not enabled, is disrupted, or out of range.
- Phone as a Key is not active or enabled on at least one phone.
- Your vehicle battery has depleted.
- Your phone battery has depleted.
- Interference from other devices using radio frequencies or physical obstructions.
- Your phone is too close to metal objects or other electronic devices.

**Note:** Do not leave a duplicate coded key in the vehicle. Always take your keys and phone and lock all doors when leaving the vehicle.

## PROGRAMMING YOUR PHONE

To program your device as Phone as a Key:

1. Visit your device's app store to download the Lincoln Way app.
2. Create a new account or sign in to an existing account on the Lincoln Way app.

3. Add the vehicle identification number to your account and follow the prompts in the Lincoln Way app to complete the authorization process.
4. After the authorization is complete, you can set up Phone as a Key following the prompts in the Lincoln Way app.
5. After Phone as a Key is set up, you can set up the backup start passcode by following the prompts on your touchscreen.

**Note:** Keep your new backup start passcode with you in case of an emergency.

## Resetting Phone as a Key

To reset Phone as a Key from your vehicle See **Performing a System Reset** (page 487).

## USING THE VALET MODE

### Classic Valet Mode

### Enabling Valet Mode

Make sure the remote control is in your vehicle.



# Phone as a Key

1. From the controls menu, press Valet Mode. See **Center Display** (page 468).
2. Enter a four digit code to lock the touchscreen.
3. Reenter the same four digit code to complete enabling valet mode.

## Disabling Valet Mode

1. Press Exit Valet Mode.
2. Enter your four digit code to disable valet mode and unlock your touchscreen.

## Enhanced Valet Mode

### Enabling Valet Mode

Have your backup start passcode completely set up before using valet mode. See **Programming Your Phone** (page 76).

**Note:** *If your vehicle detects a remote control, the system defaults to classic valet mode.*

1. From the controls menu, press Valet Mode. See **Center Display** (page 468).
2. Press Valet Mode.

**Note:** *If the system detects a valid Phone as a Key, a valet passcode displays on both the touchscreen and mobile app.*

**Note:** *If the system does not detect a valid Phone as a Key, it prompts you to enter your backup start passcode on the touchscreen. Once validated, a valet passcode displays on the touchscreen.*

3. Provide the valet the first five digits of the valet passcode to enter on the keyless entry keypad to unlock your vehicle.
4. Provide the valet the eight-digit valet passcode to enter on the touchscreen to start and drive your vehicle.

### Disabling Valet Mode

1. Press Exit Valet Mode.

**Note:** *If the system detects a valid Phone as a Key, valet mode disables.*

**Note:** *If the system does not detect a valid Phone as a Key, it prompts you to enter your backup start passcode. Once validated, valet mode disables.*

## USING THE BACKUP START PASSCODE

Make sure you have Phone as a Key active on at least one phone to use the previously created backup start passcode. See **Programming Your Phone** (page 76).

1. Press the brake pedal and the push button ignition switch. If the system does not detect a valid Phone as a Key or remote control, a message appears on the touchscreen and the system prompts you for your backup start passcode.

**Note:** *The touchscreen times out after 30 seconds with no interaction.*

**Note:** *If the backup start passcode screen does not appear, press the brake pedal and push button ignition switch again.*

2. Use the touchscreen to enter your backup start passcode.
3. After entering your backup start passcode, press Enter within 30 seconds.
4. Once the system validates the backup start passcode, a message alerts you to start your vehicle.

# Phone as a Key

---

5. Press the brake pedal and the push button ignition switch within 20 seconds to start the vehicle.
6. If your vehicle does not start, repeat steps 1-5.

## System Lockout

The system locks after five combined incorrect attempts of the following:

- Entering a backup start passcode.
- Resetting a current passcode.
- Entering a valet mode passcode.

**Note:** *The system remains locked for a short period of time. After that the system allows passcodes to be entered again.*

## PHONE AS A KEY – TROUBLESHOOTING

### PHONE AS A KEY – FREQUENTLY ASKED QUESTIONS

#### How can I tell if my vehicle has Phone as a Key?

- The vehicle's touchscreen shows the Phone as a Key reset option.
- Additional control buttons appear on the home screen of the Lincoln Way app if you have already set up Phone as a Key on your vehicle through the Lincoln Way app.

#### What happens if I cannot unlock the vehicle with Phone as a Key?

- Attempt to move your phone closer to the vehicle.
- Check that the Lincoln Way app is still running and that the Phone as a Key control screen shows **Bluetooth®** is connected. If the phone is connected, attempt to press the remote unlock button in the Lincoln Way app. If the phone is not connected or the remote unlock button does not work in the Lincoln Way app, attempt to force close and restart the app.

# Phone as a Key

---

## Why do I get a No Key Detected message in the instrument cluster display when I am using Phone as a Key and my phone is in the car?

- Your phone's **Bluetooth**® connection has been disrupted or is not connected. Try reconnecting your phone's **Bluetooth**® connection.
- Move the phone closer to the center of the vehicle near the cup holder or center console.
- Verify Phone as a Key is still active, enabled and has not been revoked.

## What do I do if my phone is lost, damaged or the battery has depleted?

- Use the backup start passcode that you created. See **Using the Backup Start Passcode** (page 77).

## How many phones can I use for Phone as a Key?

- You can program and activate up to four phones with Phone as a Key to control your vehicle.

## How does a valet drive my car if I only use Phone as a Key?

- Have the valet use the temporary valet passcode that you created. See **Using the Valet Mode** (page 76).

## I uninstalled my Lincoln Way app and reinstalled it. Why am I not able to set up Phone as a Key again?

- Using the key list in the Lincoln Way app remove the key that was previously associated with your phone.
- Reset Phone as a Key from your vehicle, and then set up Phone as a Key again. See **Programming Your Phone** (page 76).

## Why can I not remotely start the vehicle with Phone as a Key?

- Using the Lincoln Way app, verify your Phone as a Key setup is complete and **Bluetooth**® is connected on at least one phone. If Phone as a Key setup is not complete, complete the setup as prompted from the Lincoln Way app. See **Programming Your Phone** (page 76).

# Doors and Locks

## OPERATING THE DOORS FROM OUTSIDE YOUR VEHICLE

### UNLOCKING AND LOCKING THE DOORS USING THE REMOTE CONTROL

You can only use the remote control when your vehicle is stationary.

#### Unlocking the Doors



Press the button to unlock all doors. One long flash of the turn signal lamps confirms that your vehicle has unlocked.

#### Locking the Doors



Press the button to lock all doors. One short flash of the turn signal lamps confirms that your vehicle has locked.

### UNLOCKING AND LOCKING THE DOORS USING THE KEY BLADE

If your vehicle has no power and the backup power system is turned off, you can manually unlock the driver door using a key in the position shown.

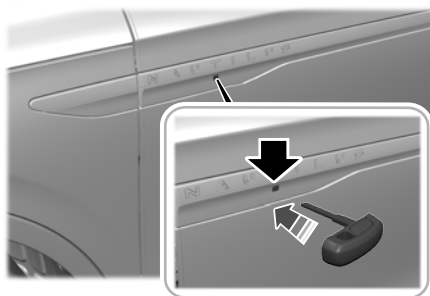

1. Remove the key blade from the transmitter.
2. Insert the key blade into the lock cylinder.
3. Turn the key clockwise to unlock the driver door.

**Note:** All other doors remain locked.

**Note:** You cannot lock the door using the key blade.

### OPERATING THE DOORS FROM INSIDE YOUR VEHICLE

#### UNLOCKING AND LOCKING THE DOORS USING THE CENTRAL LOCKING

The power door lock control is on the front doors.



Press the button to unlock all doors.



Press the button to lock all doors.

**Note:** The central locking only operates if the front doors are fully closed.

#### OPENING THE DOORS FROM INSIDE YOUR VEHICLE

Pull the interior door handle twice to unlock and open a rear door. The first pull unlocks the door and the second pull opens the door.

# Doors and Locks

---

Pull the interior door handle once to directly open a front door.

## AUTOUNLOCK

### WHAT IS AUTOUNLOCK

Autounlock is a feature that centrally unlocks the vehicle doors when your vehicle comes to a stop and you open the driver door.

### AUTOUNLOCK REQUIREMENTS

Autounlock unlocks all the doors after:

1. The vehicle speed exceeds 12 mph (20 km/h).
2. Your vehicle comes to a stop.
3. You open the driver door.

**Note:** *Autounlock operates for only 10 minutes after the ignition is switched off.*

### SWITCHING AUTOUNLOCK ON AND OFF

1. From the settings menu, press Vehicle. See **Center Display** (page 468).
2. Press Locks.
3. Switch Autounlock on or off.

## AUTOLOCK

### WHAT IS AUTOLOCK

Autolock is a locking feature that centrally locks your vehicle doors when driving.

### AUTOLOCK REQUIREMENTS

Autolock locks all the doors after:

1. All doors are closed and the ignition is on.
2. Your vehicle speed exceeds 12 mph (20 km/h).

Autolock repeats if:

1. Your vehicle is stopped.

2. Any door is opened and closed again.
3. Your vehicle speed exceeds 12 mph (20 km/h).

## MISLOCK

### WHAT IS MISLOCK

Mislock is a locking feature that warns you if your vehicle has not locked.

### MISLOCK LIMITATIONS

When you press the lock button once, the direction indicators do not flash if any door or the liftgate or hood is open.

1. If any door or the liftgate is open.
2. The hood is open.

### SWITCHING MISLOCK ON AND OFF

1. From the settings menu, press Vehicle. See **Center Display** (page 468).
2. Press Locks.
3. Switch Mislock chirp on or off.

# Doors and Locks

## DOORS AND LOCKS AUDIBLE WARNINGS

### Door Ajar Audible Warning

Sounds when any front door is not fully closed and your vehicle is moving.

## DOORS AND LOCKS – TROUBLESHOOTING

### DOORS AND LOCKS – WARNING LAMPS

#### Door Ajar Warning Lamp



It illuminates when you switch the ignition on and remains on if any door is open.

## DOORS AND LOCKS – INFORMATION MESSAGES

Message	Details
Driver Door Ajar	Displays if a door is open. Fully close the door.
Passenger Door Ajar	
Rear Left Door Ajar	
Rear Right Door Ajar	
Hood Ajar	Displays if a hood is open. Fully close the hood.

# Keyless Entry

## WHAT IS KEYLESS ENTRY

The system allows you to lock and unlock your vehicle without taking the passive key out of your pocket or purse.

## KEYLESS ENTRY LIMITATIONS

Make sure your remote control is within 3 ft (1 m) from the front door handles and the tailgate.

The system could not function if:

- The remote control remains stationary for about a minute.
- The vehicle battery has no charge.
- The remote control battery has no charge.
- There is interference causing issues with the remote control frequencies.
- The remote control is too close to metal objects or electronic devices, for example keys or a cell phone.

## KEYLESS ENTRY SETTINGS

### Switching Keyless Entry On and Off

1. From the settings menu, press Vehicle. See **Center Display** (page 468).
2. Press Locks.
3. Press KeyFree.

### Reprogramming the Unlocking Function (If Equipped)

You can enable the two-stage unlocking function allowing you to unlock only the driver door when you touch the unlock sensor.

Press and hold both the lock and unlock buttons on the remote control for four seconds to disable or enable two-stage unlocking.

If you program the unlocking function so that only the driver door unlocks, you can unlock all of the other doors from inside your vehicle using the power door lock control. You can unlock individual doors by pulling the interior door handles on those doors.

## Key Detection Alert

Displays a message in the instrument cluster if no valid key is detected, when you exit your vehicle with a key, after the last front door is closed and your keyless vehicle is in run, indicating your vehicle is still on. The horn sounds if you have driven the vehicle and reached a speed of 16 mph (25 km/h) and the above mentioned conditions are met.

You can switch the audible alert on or off.

1. From the settings menu, press Vehicle. See **Center Display** (page 468).
2. Switch Key Detection Alert On or Off.

## USING KEYLESS ENTRY

### Unlocking the Doors

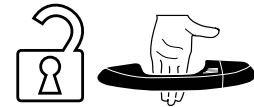

# Keyless Entry

With the remote control within 3 ft (1 m) of your vehicle, grab the unlock switch on the back of the door handle for a brief period and then pull on the door handle to unlock. The system requires a brief delay to authenticate the remote control.

## Locking the Doors

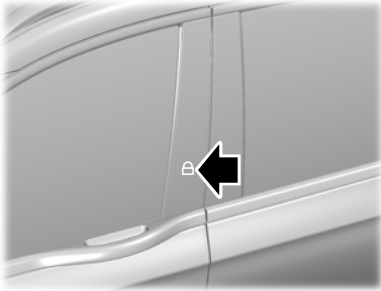

With your remote control or authorized phone within 3 ft (1 m) of your vehicle, touch the lock icon on the door window trim to lock the door. The keyless entry system requires a brief delay to authenticate your device.

## Opening the Liftgate with the Remote Control



Press the exterior liftgate release button inside of the liftgate handle. The liftgate unlocks and opens. See **Opening the Liftgate From Outside Your Vehicle** (page 90).

## KEYLESS ENTRY – TROUBLESHOOTING

### KEYLESS ENTRY – FREQUENTLY ASKED QUESTIONS

#### Why does the keyless entry system not function?

- If the system does not function it may be limited. See **Keyless Entry Limitations** (page 83). If the system still does not function use the remote control or the key blade to lock and unlock your vehicle.

#### Why can I not lock my vehicle?

- If you electronically lock your vehicle with a rear door or the liftgate open, the system searches for a passive key inside your vehicle after you close the last door. If the system detects a key, all doors unlock indicating that a key is inside. Your vehicle locks if another passive key is within the detection range after you close the last door.



# Keyless Entry Keypad

## WHAT IS THE KEYLESS ENTRY KEYPAD

The keyless entry keypad allows you to lock and unlock your vehicle using the keypad on the window trim.

## KEYLESS ENTRY KEYPAD LIMITATIONS

The system may not function if:

- The vehicle battery has no charge.

## LOCATING THE KEYLESS ENTRY KEYPAD

The keypad is near the driver window and illuminates when you touch it.

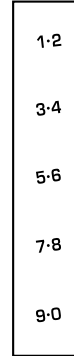

## KEYLESS ENTRY KEYPAD MASTER ACCESS CODE

### What is the Master Access Code

The master access code is a factory-set five-digit entry code. You can operate the keypad with the master access code at any time. The master access code can be displayed in the instrument cluster display and is available from an authorized dealer.

### Displaying the Master Access Code in the Instrument Cluster Display

Read and understand the following before you begin the process.

- You must have two previously programmed intelligent access key inside your vehicle.
- Make sure that your vehicle is off.
- Make sure you do not press the brake pedal during the procedure.
- Make sure that you close all the doors and that they remain closed throughout the procedure.

# Keyless Entry Keypad

Perform all steps within 30 seconds of starting the sequence. If you perform any of the steps out of sequence, stop and wait for at least one minute before starting again.

**Note:** Do not place the device on the wireless accessory charging area during the procedure.

1. Access the backup slot. See **Accessing the Passive Key Backup Position** (page 190).
2. Place the first intelligent access key into the backup slot.
3. Press the push button ignition switch once and wait for a few seconds.
4. Press the push button ignition switch again and remove the intelligent access key from the center console.
5. Insert the second programmed intelligent access key into the backup slot in the center console, then press the push button ignition switch.

The master access code appears in the instrument cluster display for a few seconds.

**Note:** The code may not display until after other warning messages display.

## KEYLESS ENTRY KEYPAD PERSONAL ACCESS CODES

### Programming a Personal Entry Code

1. Enter the five-digit master code.
2. Press **1-2** on the keypad within five seconds.
3. Enter your personal five-digit code. You must do this within five seconds of completing Step 2.
4. Press **1-2** on the keypad to save personal code 1.

The doors lock then unlock to confirm that programming was successful.

To program additional personal entry codes, repeat Steps 1 through 3, then for Step 4:

- Press **3-4** to save personal code 2.
- Press **5-6** to save personal code 3.
- Press **7-8** to save personal code 4.
- Press **9-0** to save personal code 5.

If your vehicle comes with the operating system, you can also program the system with one personal entry code.

**Note:** Programming a code using the operating system overwrites any code that was already saved on the position 9-0 of the Keypad.

Hints:

- Do not set a code that uses five of the same number.
- Do not use five numbers in sequential order.
- The five-digit master code works even if you have set your own personal code.

### Erasing a Personal Code

1. Enter the five-digit master code.
2. Press and release **1-2** on the keypad within five seconds.
3. Press and hold **1-2** for two seconds. You must do this within five seconds of completing Step 2.

All personal codes erase and only the five-digit master code works.

# Keyless Entry Keypad

## Anti-Scan Feature

The keypad goes into an anti-scan mode if you enter the wrong code seven times. This mode turns off the keypad for one minute and the keypad lamp flashes.

The anti-scan feature turns off after:

- One minute of keypad inactivity.
- You press the unlock button on the remote control.
- You switch the ignition on.
- You unlock your vehicle using keyless entry.

## USING THE KEYLESS ENTRY KEYPAD

### Unlocking the Driver Door

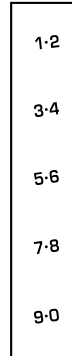

Enter the factory-set five-digit code or your personal code. You must press each number within five seconds of each other.

**Note:** All doors unlock if the two-stage unlocking feature is disabled. See **Keyless Entry Settings** (page 83).

## Unlocking All Doors

Enter the factory-set code or your personal code, then press 3-4 within five seconds.

## Locking the Doors

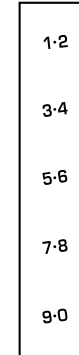

Press and hold **7-8** and **9-0** at the same time with the driver door closed.

**Note:** You do not need to enter the code first.

# Keyless Entry Keypad

---

## **KEYLESS ENTRY KEYPAD – TROUBLESHOOTING**

### **KEYLESS ENTRY KEYPAD – FREQUENTLY ASKED QUESTIONS**

#### **Why does the keypad not accept the access code?**

- If you enter the access code too fast on the keypad, the unlock function may not work. Slowly re-enter the access code.

#### **Why does the keypad not function?**

- The keypad goes into an anti-scan mode if you enter a wrong code seven times. The anti-scan mode disables the keypad for one minute and the red light flashes.

# Easy Entry and Exit

---

## HOW DOES EASY ENTRY AND EXIT WORK

Easy entry and exit moves the driver seat rearward and the steering column up when you switch the ignition off. The driver seat and steering column return to their previous positions when you switch the ignition on.

**Note:** *Depending on your vehicle, the column may move up and in.*

## SWITCHING EASY ENTRY AND EXIT ON AND OFF

1. From the settings menu, press Vehicle.  
See **Center Display** (page 468).
2. Press Easy Entry/Exit.

If you press any adjustment or memory button when in easy exit mode, the system cancels the operation.

# Liftgate

## LIFTGATE PRECAUTIONS

 **WARNING:** Make sure all persons are clear of the power liftgate area before opening or closing the liftgate.

 **WARNING:** It is extremely dangerous to ride in a cargo area, inside or outside of a vehicle. In a crash, people riding in these areas are more likely to be seriously injured or killed. Do not allow people to ride in any area of your vehicle that is not equipped with seats and seatbelts. Make sure everyone in your vehicle is in a seat and properly using a seatbelt. Failure to follow this warning could result in serious personal injury or death.

 **WARNING:** Make sure that you fully close the liftgate to prevent exhaust fumes from entering your vehicle. If you are unable to fully close the liftgate, open the air vents or the windows to allow fresh air to enter your vehicle. Failure to follow this instruction could result in personal injury or death.



**WARNING:** Keep keys out of reach of children. Do not allow children to operate or play near an open or moving power liftgate. You should supervise the operation of the power liftgate at all times.

## OPENING THE LIFTGATE

### OPENING THE LIFTGATE FROM INSIDE YOUR VEHICLE



Press the button on the instrument panel.

**Note:** Make sure that you shift the transmission into park (P) for automatic transmission or completely stop the vehicle for manual transmission.

**Note:** Be careful when opening or closing the liftgate in a garage or other enclosed area to avoid damaging the liftgate.

**Note:** Do not hang anything, for example a bike rack, from the glass or liftgate. This could damage the liftgate and its components.

**Note:** Do not leave the liftgate open when you are driving. This could damage the liftgate and its components.

### OPENING THE LIFTGATE FROM OUTSIDE YOUR VEHICLE

1. Unlock the liftgate with the remote control or power door unlock control. If a passive key is within 3 ft (1 m) of the liftgate, the liftgate unlocks when you press the liftgate release button.

# Liftgate



2. Press and release the liftgate control button.

**Note:** Allow the power system to open the liftgate. Manually pushing or pulling the liftgate could activate the system's obstacle detection feature and stop the power operation or reverse its direction, replicate a strut failure, or damage mechanical components.

**Note:** Be careful when opening or closing the liftgate in a garage or other enclosed area to avoid damaging the liftgate.

**Note:** Do not hang anything, for example a bike rack, from the glass or liftgate. This could damage the liftgate and its components.

**Note:** Do not leave the liftgate open while driving. This could damage the liftgate and its components.

## Switching the Power Liftgate On or Off

You can switch the power liftgate on or off through the vehicle settings on your touchscreen.

**Note:** When switched off, the liftgate only unlatches and will not power open or close.

## OPENING THE LIFTGATE USING THE REMOTE CONTROL



Press the button twice within three seconds.

**Note:** Be careful when opening or closing the liftgate in a garage or other enclosed area to avoid damaging the liftgate.

**Note:** Do not hang anything, for example a bike rack, from the glass or liftgate. This could damage the liftgate and its components.

**Note:** Do not leave the liftgate open while driving. This could damage the liftgate and its components.

## OPENING THE HANDS-FREE LIFTGATE

(If Equipped)

Make sure you have the passive key within 3 ft (1 m) of the liftgate.

1. Stand behind your vehicle and face the liftgate.
2. Move your foot in a single-kick motion, without pausing, under and away from the rear bumper detection area.

# Liftgate

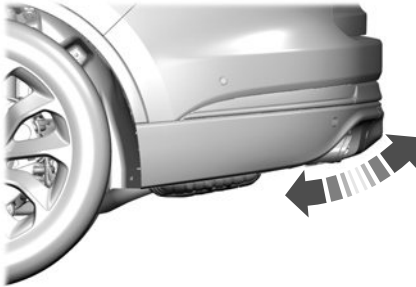

## Detection Zones

### Vehicles Without a Trailer Hitch

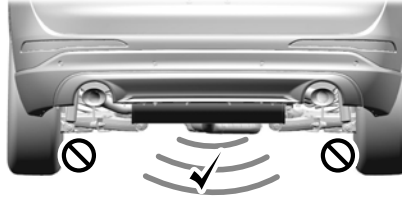

The detection area is in the center of the rear bumper.

### Vehicles With a Trailer Hitch

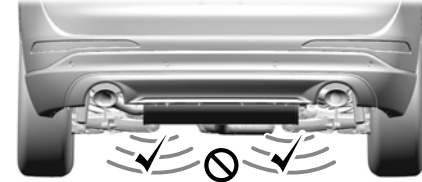

The detection area is on the left-hand and right-hand side of the hitch, between the exhaust and the hitch.

**Note:** Allow the power system to open the liftgate. Manually pushing or pulling the liftgate may activate the system's obstacle detection feature and stop the power operation or reverse its direction, replicate a strut failure, or damage mechanical components.

3. The liftgate opens.

Avoid the following actions when using the hands-free opening feature:

- Making physical contact with the bumper.
- Holding your foot under the bumper.
- Sweeping your foot from side to side, or kicking at an odd angle.



# Liftgate

**Note:** Any physical actions that mimic a kicking motion such as splashing water, trailer chains or vacuum hoses may cause the hands-free liftgate to activate. Switch the power liftgate off through your vehicle settings or keep the passive key away from the rear bumper detection area.

## SETTING THE LIFTGATE OPENING HEIGHT

1. Open the liftgate.
2. Stop the liftgate movement by pressing the control button on the liftgate when it reaches the desired height.

**Note:** Once the liftgate stops moving, you can manually move it to the desired height.

3. Press and hold the control button on the liftgate until a tone sounds, indicating programming is complete.

**Note:** You can only use the liftgate control button to program the height.

**Note:** You cannot program the height if the liftgate position is too low.

4. The power liftgate now opens at the programmed height. To change the programmed height, repeat the steps.

**Note:** You can fully open the liftgate by manually pushing it upward to the maximum open position if it opens in a lower position.

**Note:** The system recalls the new programmed height until you reprogram it, even if you disconnect the battery.

## CLOSING THE LIFTGATE

### CLOSING THE LIFTGATE FROM INSIDE YOUR VEHICLE

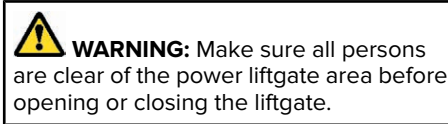

Press the button on the instrument panel.

**Note:** Make sure that you shift the transmission into park (P) for automatic transmission or completely stop the vehicle for manual transmission.

**Note:** Make sure that you close the liftgate before operating or moving your vehicle, especially in an enclosure like a garage or a parking structure. This could damage the liftgate and its components.

**Note:** Make sure the area behind your vehicle is free from obstruction and that there is enough room for you to operate the liftgate. Objects too close to your vehicle, for example a wall, garage door or another vehicle may come into contact with the moving liftgate. This could damage the liftgate and its components.

**Note:** Make sure that you fully close the liftgate to prevent cargo from falling out.

# Liftgate

## CLOSING THE LIFTGATE FROM OUTSIDE YOUR VEHICLE



**WARNING:** Make sure all persons are clear of the power liftgate area before opening or closing the liftgate.



Press the liftgate button.

**Note:** Make sure that you close the liftgate before operating or moving your vehicle, especially in an enclosure like a garage or a parking structure. This could damage the liftgate and its components.

**Note:** Make sure the area behind your vehicle is free from obstruction and that there is enough room for you to operate the liftgate. Objects too close to your vehicle, for example a wall, garage door or another vehicle may come into contact with the moving liftgate. This could damage the liftgate and its components.

**Note:** Make sure that you fully close the liftgate to prevent cargo from falling out.

## CLOSING THE LIFTGATE USING THE REMOTE CONTROL



**WARNING:** Make sure all persons are clear of the power liftgate area before opening or closing the liftgate.



Press the button twice within three seconds. A tone sounds when the liftgate begins to close.

**Note:** Make sure that you close the liftgate before operating or moving your vehicle, especially in an enclosure like a garage or a parking structure. This could damage the liftgate and its components.

**Note:** Make sure the area behind your vehicle is free from obstruction and that there is enough room for you to operate the liftgate. This could damage the liftgate and its components.

**Note:** Make sure that you fully close the liftgate to prevent cargo from falling out.

## CLOSING THE HANDS-FREE LIFTGATE

(If Equipped)

Make sure you have the remote control within 3 ft (1 m) of the liftgate.

1. Stand behind your vehicle, and face the liftgate.
2. Move your foot, in a single-kick motion, without pausing, under and away from the rear bumper detection area.

# Liftgate

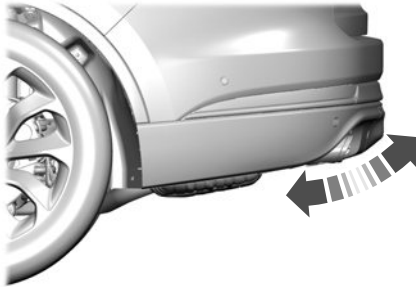

3. The liftgate closes.

Avoid the following actions when using the hands-free opening feature:

- Making physical contact with the bumper.
- Holding your foot under the bumper.
- Sweeping your foot from side to side, or kicking at an odd angle.

## Detection Zones

### Vehicles Without a Trailer Hitch

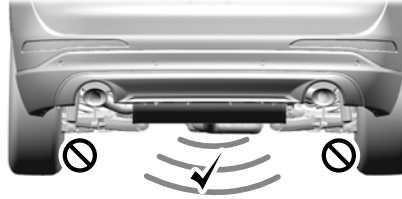

The detection area is in the center of the rear bumper.

### Vehicles With a Trailer Hitch

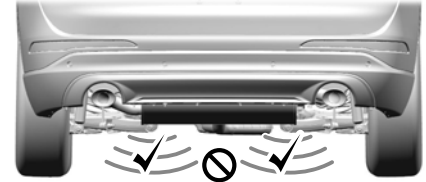

The detection area is on the left-hand side and right-hand side of the hitch, between the exhaust and the hitch.

**Note:** Allow the power system to close the liftgate. Manually pushing the liftgate may activate the system's obstacle detection feature and stop the power operation or reverse its direction, replicate a strut failure, or damage mechanical components.

# Liftgate

## STOPPING THE LIFTGATE MOVEMENT

**Note:** Do not apply sudden excessive force to the liftgate while it is in motion. This could damage the power liftgate and its components.

**Note:** Selections will vary depending on region or options.

You can stop the liftgate movement by doing any of the following:

- Pressing the liftgate control button on the liftgate.
- Pressing the liftgate control button inside the vehicle.
- Pressing the liftgate button on the remote control twice.

## LIFTGATE – INFORMATION MESSAGES

Message	Action
Liftgate Ajar	The liftgate is not completely closed. Close the liftgate.

- Pressing the liftgate button on an authorized device.
- Moving your foot under and away from the center rear bumper in a single-kick motion.
- For vehicles with trailer hitch the detection area is on left and right side of the rear bumper between the exhaust.

## LIFTGATE OBSTACLE DETECTION

### Closing the Liftgate

The system stops when it detects an obstacle. A tone sounds and the system reverses to open. Once you remove the obstacle, you can power close the liftgate.

**Note:** To prevent accidental obstacle detection, let the power liftgate close completely before you enter your vehicle.

## Opening the Liftgate

The system stops when it detects an obstacle and a tone sounds. Once you remove the obstacle, you can continue to operate the liftgate.

## LIFTGATE – TROUBLESHOOTING

### LIFTGATE – WARNING LAMPS



Illuminates when the liftgate is not completely closed.

# Liftgate

---

## **LIFTGATE – FREQUENTLY ASKED QUESTIONS**

### **Why won't my power liftgate function?**

- It can happen in freezing conditions or when parking on downhill slopes.
- Make sure the power liftgate is enabled in the vehicle settings menu.
- Make sure the transmission is in park (P), ensure nothing is obstructing the liftgate path and there is not excessive weight on the liftgate.
- If there are continued issues, the battery voltage may be low or there may be other system issues. See an authorized dealer.

# Security

---

## PASSIVE ANTI-THEFT SYSTEM

### WHAT IS THE PASSIVE ANTI-THEFT SYSTEM

The passive anti-theft system prevents someone from starting your vehicle with an incorrectly coded key.

**Note:** *Do not leave a duplicate coded key in your vehicle. Always take the keys and lock all the doors when leaving your vehicle.*

### HOW DOES THE PASSIVE ANTI-THEFT SYSTEM WORK

The passive anti-theft system arms when you switch your vehicle off.

It disarms when you switch your vehicle on with a correctly coded key.

**Note:** *The system is not compatible with non-Ford aftermarket remote start systems.*

**Note:** *Do not leave a duplicate coded key in your vehicle. Always take the keys and lock all doors when leaving your vehicle.*

## ANTI-THEFT ALARM SYSTEM

### WHAT IS THE ANTI-THEFT ALARM SYSTEM

The anti-theft alarm system warns you of an unauthorized entry to your vehicle.

### HOW DOES THE ANTI-THEFT ALARM SYSTEM WORK

When armed, the anti-theft alarm is triggered in any of the following ways:

- If someone opens a door, the liftgate or the hood without a correctly coded key or remote control.
- If you turn the power on without a correctly coded key.
- If the interior sensors detect movement inside your vehicle.
- If the inclination sensors detect an attempt to raise your vehicle.

If the anti-theft alarm is triggered, the alarm horn sounds for 30 seconds and the direction indicators flash for 5 minutes.

Any further attempts to carry out one of the above sounds the alarm again.

## WHAT IS THE PERIMETER ALARM

The perimeter alarm is designed to detect unauthorized access to your vehicle.

## WHAT ARE THE INTERIOR SENSORS

The interior sensors are designed to detect any movement inside your vehicle.

The interior sensors are in the overhead console.

**Note:** *Do not cover the interior sensors.*

## WHAT ARE THE INCLINATION SENSORS

The inclination sensor is designed to detect an attempt to raise your vehicle, for example to remove a wheel or to tow it away.

# Security

---

## ARMING THE ANTI-THEFT ALARM SYSTEM

The alarm is ready to arm when you switch your vehicle off.

Lock your vehicle with your remote control to arm the alarm.

## DISARMING THE ANTI-THEFT ALARM SYSTEM

Disarm the alarm by performing any of the following actions:

- Unlock the doors or luggage compartment with the remote control.
- Switch your vehicle on or start your vehicle.

## ANTI-THEFT ALARM SYSTEM SETTINGS

### WHAT ARE THE ALARM SECURITY LEVELS

You can select two levels of alarm security, all sensors and perimeter sensing.

#### All Sensors

All sensors is the standard setting.

In all sensors, all equipped sensors are on when you arm the alarm.

**Note:** *Do not arm the alarm with all sensors if passengers, animals or other moving objects are inside your vehicle.*

#### Perimeter Sensing

In perimeter sensing, the interior sensors are off when you arm the alarm.

All the other equipped sensors activate when you arm the alarm in this mode.

## SETTING THE ALARM SECURITY LEVEL

1. From the settings menu, press Vehicle. See **Center Display** (page 468).
2. Press Alarm System.
3. Press Motion Sensors and choose a setting.

### WHAT IS ASK ON EXIT

You can choose which level of security you require after you switch your vehicle off.

**Note:** *If you do not choose a setting, the system defaults to all sensors.*

### SWITCHING ASK ON EXIT ON AND OFF

1. From the settings menu, press Vehicle. See **Center Display** (page 468).
2. Press Alarm System.
3. Switch Ask on Exit on or off.

# Security

---

## SECURITY – TROUBLESHOOTING

## SECURITY – INFORMATION MESSAGES

Message	Details
No Key Detected	The system has not detected a correctly coded key.
Starting System Fault	The system has malfunctioned. Have your vehicle checked as soon as possible.
Vehicle Alarm To Stop Alarm, Start Vehicle.	Displays when the alarm has been triggered due to unauthorized entry.
Alarm	



# Security

---

## **SECURITY – FREQUENTLY ASKED QUESTIONS**

### **What should I do if there is a potential alarm problem with my vehicle?**

- Take all remote controls to an authorized dealer if there is a potential alarm problem with your vehicle.

### **What should I do if my vehicle is unable to start with a correctly coded key?**

- Have your vehicle checked as soon as possible.

# Steering Wheel

## USING THE CONTROLS ON THE STEERING WHEEL

The steering wheel control has nine possible locations. When activated, a control mirror in the instrument cluster display reflects the available controls.

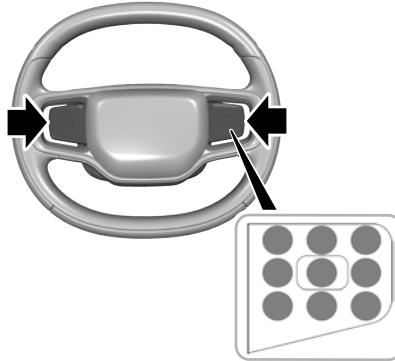

## Instrument Cluster Display Control Mirror



# Steering Wheel

1. Press any area on the control to activate the control mirror in the instrument cluster display. The control mirror highlights the locations you press. Any applicable text of the active location appears below the control mirror in the instrument cluster display.

**Note:** Applicable text displays in the instrument cluster for right-hand controls only.

2. Using the control mirror, press the corresponding location on the steering wheel control to select the option you prefer.

**Note:** The instrument cluster display control mirror times out after a few seconds.

## ADJUSTING THE STEERING WHEEL



**WARNING:** Do not adjust the steering wheel when your vehicle is moving.

**Note:** Make sure that you are sitting in the correct position. See **Sitting in the Correct Position** (page 154).

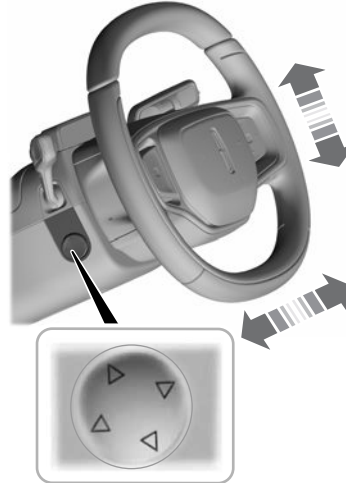

E390750

Use the control on the side of the steering column to adjust the position.

To adjust:

- Tilt: Press the top or bottom of the control.
- Telescope: Press the front or rear of the control.

## RESETTING THE STOPPING POSITION

**Note:** The steering wheel stops when it detects an obstruction. This sets a new stopping position.

To reset the steering column to its normal stopping position:

1. Confirm there is nothing obstructing the motion of the steering column.
2. Press and hold the steering column control until the steering column stops moving.
3. Press the steering column control again.

**Note:** The steering column may start to move again.

# Steering Wheel

---

4. When the steering column stops, continue holding the control for a few seconds.
5. Repeat for each direction, as necessary.

## HEATED STEERING WHEEL (IF

EQUIPPED)



From the Information and Entertainment system climate interface, press the heated steering wheel button to switch it on and off. There is no physical button to control the heated steering wheel.

**Note:** *You can use the heated steering wheel only when the engine is running.*

**Note:** *The system turns the heated steering wheel off and on to maintain the programmed temperature.*

**Note:** *In warm temperatures, the steering wheel quickly reaches its maximum temperature and the system reduces the current to the heating element. This could cause you to think that the system has stopped working but it has not. This is normal.*

## HORN



Press the horn icon to activate the horn.

# Wipers and Washers

## WIPERS

### WIPER PRECAUTIONS

Do not operate the wipers on a dry windshield. This could scratch the glass or damage the wiper blades. Use the windshield washers before wiping a dry windshield.

Fully defrost the windshield before you switch the windshield wipers on.

Switch the windshield wipers off before entering a car wash.

### SWITCHING WINDSHIELD WIPERS ON AND OFF - VEHICLES WITHOUT HEATED WIPER BLADES

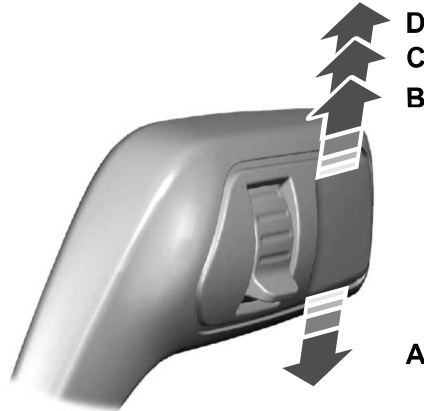

- A Single wipe.
- B Intermittent wipe/Auto wipe.
- C Normal wipe.
- D High-speed wipe.



Push the lever up or down to operate the windshield wipers.

### SWITCHING WINDSHIELD WIPERS ON AND OFF - VEHICLES WITH HEATED WIPER BLADES

#### Heated Windshield Wipers

The heated wiper blades turn on in low temperature when the windshield wipers are active or defrost or max defrost is on. See **Switching Maximum Defrost On and Off** (page 143).

**Note:** In below freezing temperatures, the heated wiper blades turn on when the wipers are inactive.

## AUTOWIPERS

### WHAT ARE AUTOWIPERS

Autowipers turns on and controls the speed and frequency of the windshield wipers.

# Wipers and Washers

**Note:** Keep the outside of the windshield clean. The rain sensor is very sensitive and the wipers may operate if dirt, mist or insects hit the windshield.

## AUTOWIPERS SETTINGS

1. From the settings menu, press Vehicle. See **Center Display** (page 468).
2. Press Wipers.
3. Switch Rain sensing on or off.

**Note:** When you switch the feature off, the wipers do not operate based on the rain sensor. When you switch on the windshield wipers to the intermittent wipe position with the feature off, the wipers use the wipe speed set by the rotary control.

## ADJUSTING THE SENSITIVITY OF THE RAIN SENSOR

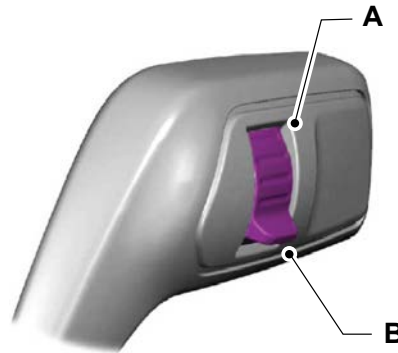

- A High sensitivity.
- B Low sensitivity.

Use the rotary control to set the sensitivity of the rain sensor.

When you select high sensitivity, the wipers operate when the sensor detects a small amount of water on the windshield.

When you select low sensitivity, the wipers operate when the sensor detects a large amount of water on the windshield.

## SWITCHING THE REAR WINDOW WIPER ON AND OFF

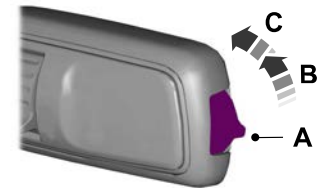

- A Rear window wiper off.
- B Intermittent wipe.
- C Continuous wipe.

# Wipers and Washers

## REVERSE WIPE

### WHAT IS REVERSE WIPE

Reverse wipe turns on the rear window wiper when you shift into reverse (R) and the windshield wipers are on.

### REVERSE WIPE SETTINGS

1. From the settings menu, press Vehicle. See **Center Display** (page 468).
2. Press Wipers.
3. Switch Rear wiper on or off.

### CHECKING THE WIPER BLADES



Run the tip of your fingers over the edge of the blade to check for roughness.

### REPLACING THE FRONT WIPER BLADES - VEHICLES WITHOUT HEATED WIPER BLADES

1. Turn the vehicle off.
2. Manually rotate the wiper upward to a proper position.

**Note:** The position should enable wiper arm lift without clash with engine hood and be easy for user to operate.

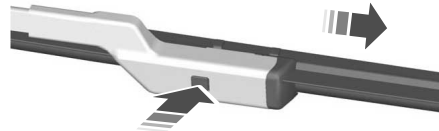

E371204

3. Lift the wiper arm and then press the wiper blade locking button.

**Note:** Do not hold the wiper blade to lift the wiper arm.

4. Remove the wiper blade.

**Note:** Make sure that the wiper arm does not spring back against the glass when the wiper blade is not attached.

5. To install, reverse the removal procedure.

**Note:** Make sure that the wiper blade locks into place.

# Wipers and Washers

## REPLACING THE FRONT WIPER BLADES - VEHICLES WITH: HEATED WIPER BLADES

### Replacing the Rubber Insert

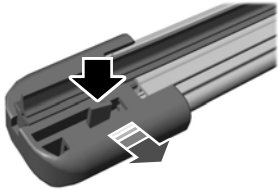

1. Remove the wiper blade.

2. Use a suitable tool, for example a screwdriver, to carefully move the tab on the end cap.
3. Pull the end cap to release the rubber insert
4. To install, reverse the removal procedure.

## REPLACING THE REAR WIPER BLADES

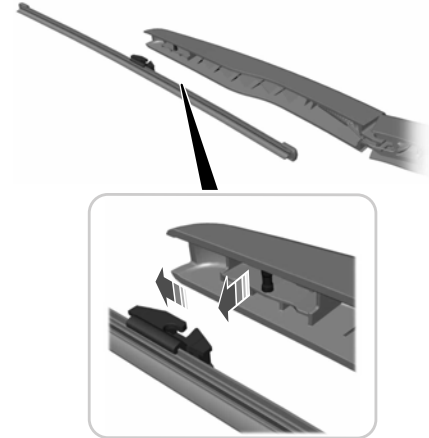

1. Lift the wiper arm.

**Note:** Do not hold the wiper blade to lift the wiper arm.



# Wipers and Washers

**Note:** Do not lift the wiper arm beyond the limited service-up position, as this might cause damage to the wiper arm. The limited service-up position is intended to protect the wiper arm against car washes.

2. Remove the wiper blade.

**Note:** Make sure that the wiper arm does not spring back against the glass when the wiper blade is not attached.

3. To install, reverse the removal procedure.

**Note:** Make sure that the wiper blade locks into place.

## WASHERS

### WASHER PRECAUTIONS



**WARNING:** If you operate your vehicle in temperatures below 41°F (5°C), use washer fluid with antifreeze protection. Failure to use washer fluid with antifreeze protection in cold weather could result in impaired windshield vision and increase the risk of injury or accident.

Do not operate the washers when the washer reservoir is empty. This could cause the washer pump to overheat.

### USING THE WINDSHIELD WASHER



Pull the lever toward you to operate the windshield washer.

**Note:** A courtesy wipe occurs a short time after the wipers stop to clear any remaining washer fluid when switched on.

### SWITCHING THE COURTESY WIPE ON AND OFF

1. From the settings menu, press Vehicle. See **Center Display** (page 468).
2. Press Wipers.
3. Switch Courtesy wipe on or off.

### USING THE REAR WINDOW WASHER

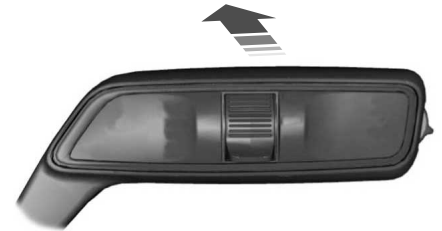

# Wipers and Washers

Push the lever away from you to operate the rear window washer.

## ADDING WASHER FLUID

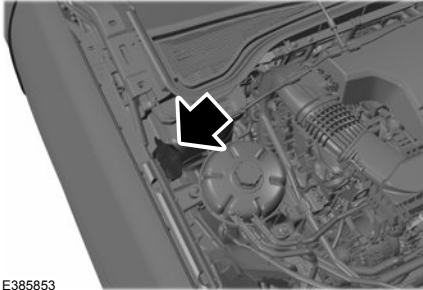

E385853

## WASHER FLUID SPECIFICATION

See **Washer Fluid Specification** (page 452).

## WIPERS AND WASHERS – TROUBLESHOOTING

### WIPERS AND WASHERS – WARNING LAMPS



Illuminates when the windshield washer fluid is low.

### WIPERS AND WASHERS – FREQUENTLY ASKED QUESTIONS

#### Why are there streaks and smears on the windshield?

- The wiper blades could be dirty, worn or damaged. Check the wiper blades. See **Checking the Wiper Blades** (page 107). If the wiper blades are dirty, clean them with washer fluid or water applied with a soft sponge or cloth. If the wiper blades are worn or damaged, install new ones. See **Replacing the Front Wiper Blades** (page 107).

# Exterior Lighting

## EXTERIOR LIGHTING CONTROL

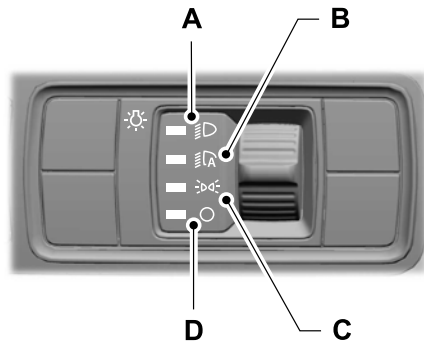

- A Headlamps on.
- B Autolamps on.
- C Parking lamps on.
- D Lamps off.

Press the toggle switch upward or downward to make a selection.

**Note:** The lighting control defaults to autolamps each time you switch your vehicle on.

## HEADLAMPS

### USING THE HIGH BEAM HEADLAMPS

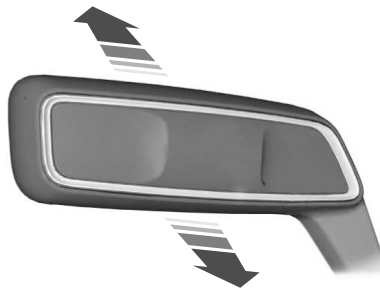

Push the lever away from you to switch the high beam on.

Push the lever forward again or pull the lever toward you to switch the high beams off.

Slightly pull the lever toward you and release it to flash the headlamps.

**Note:** Continuous activation only with headlamps on.

## SWITCHING HEADLAMP EXIT DELAY ON AND OFF

To switch headlamp exit delay on, pull the turn signal lever toward you after switching your vehicle off.

To switch headlamp exit delay off, pull the turn signal lever toward you again or switch your vehicle on.

**Note:** The headlamps turn off after three minutes with any door open or 30 seconds after the last door closes.

## HEADLAMP INDICATORS

### Lamps On



Illuminates when you switch the low beam headlamps or the parking lamps on.

# Exterior Lighting

## Headlamp High Beam



Illuminates when you switch the high beam headlamps on.

## HEADLAMPS – TROUBLESHOOTING

### HEADLAMPS – FREQUENTLY ASKED QUESTIONS

#### Why is there condensation in the headlamps?

- Headlamps have vents to accommodate normal changes in air pressure. Condensation can be a natural by-product of this design. When moist air enters the lamp assembly through the vents, there is a possibility that condensation can occur when the temperature is cold. When normal condensation occurs, a fine mist can form on the interior of the lens. The fine mist eventually clears and exits through the vents during normal operation.

#### How much condensation is acceptable?

- The presence of a fine mist, for example no streaks, drip marks or large droplets. A fine mist covers less than 50% of the lens.

#### How long does it take for the acceptable condensation to clear?

- Clearing time can take as long as 48 hours under dry weather conditions.

#### How much condensation is unacceptable?

- A water puddle inside the lamp. Streaks, drip marks or large droplets present on the interior of the lens.

#### What should I do if unacceptable condensation is present?

- Have your vehicle checked as soon as possible.

#### Why do my headlamps turn off when I have them switched on when I switch my vehicle off?

- The battery saver turns the headlamps off after a short period of time after you switch your vehicle off.

## AUTOLAMPS

### WHAT ARE AUTOLAMPS



**WARNING:** The system does not relieve you of your responsibility to drive with due care and attention. You may need to override the system if it does not turn the headlamps on in low visibility conditions, for example daytime fog.

Autolamps turn the headlamps on in low light situations or when the windshield wipers operate.

# Exterior Lighting

## AUTOLAMP SETTINGS

### Autolamp Exit Delay

You can adjust the amount of time the autolamps remain on after you switch off your vehicle. Use the touchscreen to choose a delay setting.

1. From the settings menu, press Vehicle. See **Center Display** (page 468).
2. Press Lighting.
3. Press Autolamp Delay.
4. Select a setting.

**Note:** *If the setting is off, the external lamps switch off immediately when you shut down your vehicle.*

**Note:** *You can pull the turn signal toward you to manually switch on the delay setting. See **Headlamps** (page 111).*

## EXTERIOR LAMPS

### USING THE TURN SIGNAL LAMPS

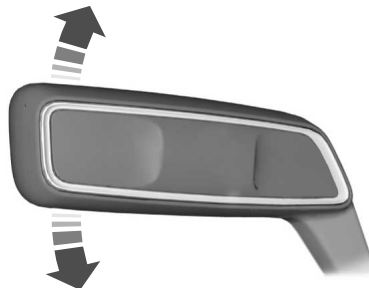

Push the lever up or down to switch the turn signal lamps on.

Set the lever to the middle position to switch the turn signal lamps off.

**Note:** *Tap the lever up or down to make the turn signal lamps flash three times.*

### Turn Signal Lamp Indicator



It flashes when you switch the turn signal lamps on.

**Note:** *An increase in the rate of flashing warns of a failed turn signal lamp.*

### SWITCHING THE DAYTIME RUNNING LAMPS ON AND OFF - VEHICLES WITH: CONFIGURABLE DAYTIME RUNNING LAMPS



**WARNING:** The daytime running lamps system does not activate the rear lamps and may not provide adequate lighting during low visibility driving conditions. Make sure you switch the headlamps on, as appropriate, during all low visibility conditions. Failure to do so may result in a crash.

1. From the settings menu, press Vehicle. See **Center Display** (page 468).
2. Press Lighting.
3. Switch Daytime Running Lights on or off.

# Exterior Lighting

The daytime running lamps turn on when all of the following occur:

- You switch the system on.
- You switch your vehicle on.
- The transmission is not in park (P) for vehicles with automatic transmissions or you release the parking brake for vehicles with manual transmissions.
- The lighting control is in the autolamps position.
- The headlamps are off.

**Note:** *Other lighting control positions do not turn on the daytime running lamps.*

## SWITCHING THE DAYTIME RUNNING LAMPS ON AND OFF - VEHICLES WITH: DAYTIME RUNNING LAMPS (DRL)



**WARNING:** The daytime running lamps system may not activate the rear lamps and may not provide adequate lighting during low visibility driving conditions. Make sure you switch the headlamps on, as appropriate, during all low visibility conditions. Failure to do so may result in a crash.

Daytime running lamps are always on unless you switch on the headlamps or your vehicle is in park (P).

## SWITCHING WELCOME LIGHTING ON AND OFF

### Approach Detection

The system turns on the exterior lamps when you approach your vehicle with an authenticated device.

To switch the system on or off:

1. From the settings menu, press Vehicle. See **Center Display** (page 468).
2. Press Easy entry and exit.
3. Switch Approach detection on or off.

**Note:** *Depending on your vehicle's configuration, you may not have the option to switch the feature on and off.*

To conserve power, the system may not work if:

- The 12-volt battery is low.
- The system was triggered 10 times prior to starting the vehicle.
- The vehicle is left unused for a few days.

## EXTERIOR LAMPS ON AUDIBLE WARNING

Sounds when you open the driver door and the exterior lamps are on.

# Exterior Lighting

---

## **AUTOMATIC HIGH BEAM CONTROL**

### **HOW DOES AUTOMATIC HIGH BEAM CONTROL WORK**

Automatic high beam control turns the high beams on if it is dark enough and no other traffic is present. If it detects an approaching vehicle's headlamps or tail lamps, or street lighting ahead, the system turns the high beams off.

A camera sensor, centrally mounted behind the windshield of your vehicle, continuously monitors conditions to turn the high beams on and off.

# Exterior Lighting

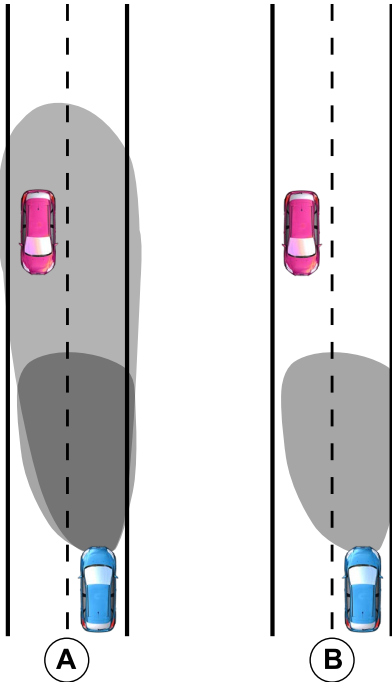

- A Without automatic high beam control.
- B With automatic high beam control.

## AUTOMATIC HIGH BEAM CONTROL PRECAUTIONS

**WARNING:** The system does not relieve you of your responsibility to drive with due care and attention. You may need to override the system if it does not turn the high beams on or off.

**WARNING:** The system may not switch the high beams off if the lights of oncoming vehicles are hidden by obstacles, for example guard rails.

**WARNING:** You may need to override the system when approaching other road users.

**WARNING:** In situations with poor visibility, such as fog, heavy rain or other inclement weather, you may need to override or completely switch off the system.

## AUTOMATIC HIGH BEAM CONTROL REQUIREMENTS

The system turns the high beams on if all of the following occur:

- You switch the system on.
- You set the lighting control to the autolamps position.
- The ambient light level is low enough that you require high beams.
- There is no traffic in front of your vehicle.
- The vehicle speed is greater than approximately 25 mph (40 km/h).



# Exterior Lighting

## AUTOMATIC HIGH BEAM CONTROL LIMITATIONS

The system turns the high beams off if any of the following occur:

- You switch the system off.
- You set the lighting control to any position except autolamps.
- The ambient light level is high enough that you do not require high beams.
- The system detects an approaching vehicle's headlamps or a leading vehicle's tail lamps.
- The system detects severe rain, snow or fog.
- The system detects street lighting.
- The camera has reduced visibility.
- The vehicle speed falls below approximately 19 mph (30 km/h).

**Note:** *The deactivation speed may be lower on curves.*

## SWITCHING AUTOMATIC HIGH BEAM CONTROL ON AND OFF

You can switch the feature on and off using the touchscreen.

## AUTOMATIC HIGH BEAM CONTROL INDICATORS



Illuminates to confirm when the system is ready to assist.

## OVERRIDING AUTOMATIC HIGH BEAM CONTROL



Push the lever away from you to switch the high beam on.

Push the lever away from you again to switch the high beams off.

Push the lever away from you for a third time to switch automatic high beam control back on.

# Exterior Lighting

---

## **AUTOMATIC HIGH BEAM CONTROL – TROUBLESHOOTING**

## **AUTOMATIC HIGH BEAM CONTROL – INFORMATION MESSAGES**

<b>Message</b>	<b>Details</b>
Front Camera Low Visibility Clean Screen	The camera has reduced visibility. Clean the windshield. If the message continues to appear, have your vehicle checked as soon as possible.
Front Camera Temporarily Not Available	The camera has malfunctioned. Wait a short period of time for the camera to cool down. If the message continues to appear, have your vehicle checked as soon as possible.
Front Camera Malfunction Service Required	The camera has malfunctioned. Have your vehicle checked as soon as possible.

# Exterior Lighting

## ADAPTIVE FRONT LIGHTING

### HOW DOES ADAPTIVE FRONT LIGHTING WORK



**WARNING:** Inspect and replace the windshield wiper blades regularly to make sure the camera sensor has a clear view. The windshield wiper blades must be the correct length.

### Speed Dependent Lamps (If Equipped)

Provides additional light on the road depending on your vehicle speed and weather conditions.

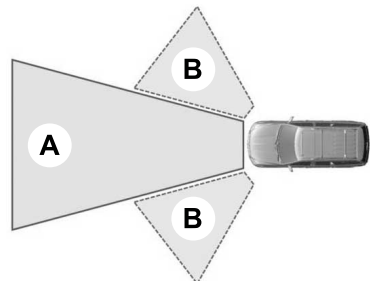

- A Standard low beam.
- B Additional lighting.

### Dynamic Bending Lamps (If Equipped)

Adapts when you are steering around a curve, the front camera detects lane markings indicating a curve or map data indicates a curve.

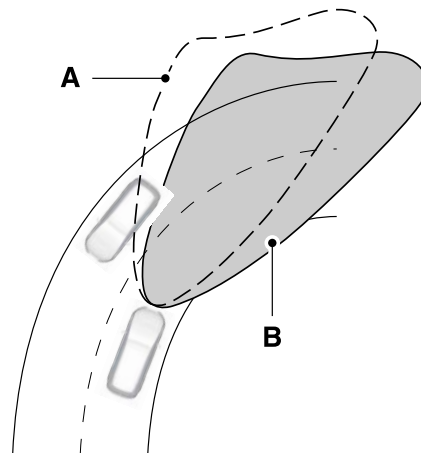

- A Without dynamic bending lamps.
- B With dynamic bending lamps.

# Exterior Lighting

## Static Bending Lamps (If Equipped)

Illuminates the inside of a corner when you are turning the steering wheel or when you switch the turn signal lamps on.

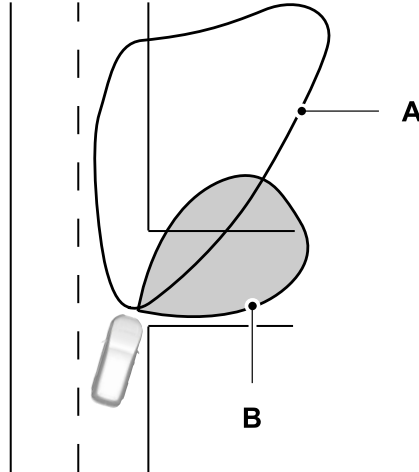

- A Headlamp beam.
- B Static bending lamp beam.

## Sign Based Lamps (If Equipped)

Adapts when the front camera detects certain traffic signs.

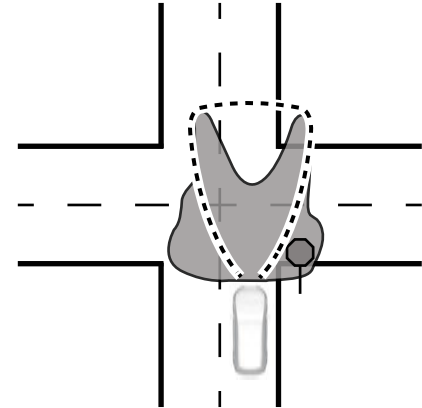

**Note:** The camera only detects traffic signs if your vehicle speed is below 31 mph (50 km/h).

# Exterior Lighting

---

## **SWITCHING ADAPTIVE FRONT LIGHTING ON AND OFF**

Set the lighting control to the autolamps position to use adaptive front lighting.

**Note:** *Other lighting control positions do not turn on adaptive front lighting.*

# Interior Lighting

## SWITCHING ALL OF THE INTERIOR LAMPS ON AND OFF

The lamps turn on under the following conditions:

- You open any door.
- You press a button on the remote control.
- You press the all lamps on button on the overhead console.



Press to switch all interior lamps on or off.

## SWITCHING THE FRONT INTERIOR LAMPS ON AND OFF

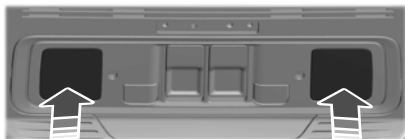

The front interior lamp switches are on the overhead console.

## Individual Map Lamps

Press the lamp lens to switch the lamps on and off.

## SWITCHING THE REAR INTERIOR LAMPS ON AND OFF



The rear interior lamps may be above the rear seat or above the rear windows.



Press to switch the lamps on or off.

**Note:** If you switch the rear lamps on through the overhead console, you cannot switch them off with the rear lamp switch.

## INTERIOR LAMP FUNCTION

### WHAT IS THE INTERIOR LAMP FUNCTION

The interior lamp function switches the courtesy and door lamps on or off.

### SWITCHING THE INTERIOR LAMP FUNCTION ON AND OFF



Press to switch the interior lamp function on and off.

**Note:** The indicator lamp illuminates amber when the door function is off.

## ADJUSTING THE INSTRUMENT PANEL LIGHTING BRIGHTNESS

The instrument lighting dimmer buttons are on the lighting control.

# Interior Lighting



Repeatedly press one of the buttons to adjust the brightness.

## AMBIENT LIGHTING

### SWITCHING AMBIENT LIGHTING ON AND OFF

1. From the controls menu, press Ambient Lighting. See **Center Display** (page 468).
2. Press a color to switch ambient lighting on.
- 3.



Press the power button to switch ambient lighting off.

**Note:** *The power button icon appears in whichever ambient lighting color you select.*

## ADJUSTING AMBIENT LIGHTING



Drag the slider up or down to adjust the ambient lighting intensity.

## INTERIOR LIGHTING – TROUBLESHOOTING

### INTERIOR LIGHTING – FREQUENTLY ASKED QUESTIONS

**Why do my courtesy lamps or interior lamps turn off when I have them switched on when I switch my vehicle off?**

- The battery saver turns the courtesy lamps and interior lamps off after a short period of time after you switch your vehicle off.

# Windows

## OPENING AND CLOSING THE WINDOWS

 **WARNING:** Do not leave children or pets unattended in your vehicle and do not let children play with the power windows. Failure to follow this instruction could result in personal injury or death.

 **WARNING:** When closing the power windows, verify that they are free of obstructions and make sure children and pets are not in the proximity of the window openings. Failure to follow this instruction could result in personal injury or death.

 **WARNING:** If an obstruction is detected, release the switch and reverse the window immediately. Failure to follow this instruction could result in personal injury or death.



**WARNING:** Do not leave a key or remote control unattended in the vehicle. Children or pets could operate the power windows and could become trapped in a closing window. Failure to follow this instruction could result in personal injury or death.



Press the window control switch to open the window. Lift the window control switch to close the window.

**Note:** *The power windows operate with the ignition on, and for several minutes after you switch the ignition off or until you open a front door.*

To reduce wind noise or pulsing noise when one window is open, slightly open the opposite window.

### One-Touch Open

Fully press the window control switch and release it. Press again or lift it to stop the window.

### One-Touch Close

Fully lift the window control switch and release it. Press again or lift it to stop the window.

### Resetting One-Touch Open and Close

If the one-touch open and close feature fails, please reset it according to the following steps:

Carry out all steps within 30 seconds of starting the sequence.

1. Close the window.
2. Press and hold the window control switch until the window is fully open. Keep the window control switch pressed for a few seconds.
3. Lift and hold the window control switch until the window is fully closed. Keep the window control switch held for a few seconds.
4. Press and hold the window control switch until the window is fully open. Keep the window control switch pressed for a few seconds.



# Windows

5. Lift and hold the window control switch until the window is fully closed. Keep the window control switch held for a few seconds.

**Note:** Repeat the procedure if the window does not close when you use one-touch.

## GLOBAL OPENING AND CLOSING

### WHAT IS GLOBAL OPENING AND CLOSING

You can use the remote control to open the windows with the ignition off.

### USING GLOBAL OPENING

1. Press and release the unlock button on the remote control.
2. Press and hold the unlock button on the remote control.
3. Release the button when the windows start to open.

Press the lock or the unlock button on the remote control to stop global opening.

**Note:** You can use global opening for a short period of time when you unlock your vehicle using the remote control.

### SWITCHING GLOBAL OPENING ON AND OFF

1. From the settings menu, press Vehicle. See **Center Display** (page 468).
2. Press Windows.
3. Switch Global open on or off.

### USING GLOBAL CLOSING

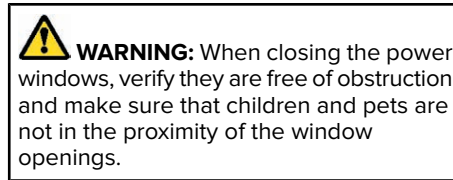

1. Press and release the lock button on the remote control.
2. Press and hold the lock button on the remote control.

3. Release the button when the windows start to close.

Press the lock or the unlock button on the remote control to stop global closing.

**Note:** Bounce-back is on during global closing. See **What Is Window Bounce-Back** (page 125).

### SWITCHING GLOBAL CLOSING ON AND OFF

1. From the settings menu, press Vehicle. See **Center Display** (page 468).
2. Press Windows.
3. Switch Global close on or off.

## WINDOW BOUNCE-BACK

### WHAT IS WINDOW BOUNCE-BACK

The window stops and reverses if it detects an obstruction when closing.

# Windows

## OVERRIDING WINDOW BOUNCE-BACK



**WARNING:** If you override bounce-back, the window does not reverse if it detects an obstacle. Take care when closing the windows to avoid personal injury or damage to your vehicle.

1. Close the window until it reaches the point of resistance and let it reverse.
2. Lift and hold the window control switch within two seconds to override bounce-back and close the window. Bounce-back is now disabled and you can close the window manually.

**Note:** *The window goes past the point of resistance and you can fully close it.*

**Note:** *If the window does not close, have your vehicle checked as soon as possible.*

## RESETTING WINDOW BOUNCE-BACK



**WARNING:** Bounce-back is off until you reset the memory. Take care when closing the windows to avoid personal injury or damage to your vehicle.

If you have disconnected the battery, you must reset the bounce-back memory separately for each window.

Carry out all steps within 30 seconds of starting the sequence.

1. Close the window.
2. Press and hold the switch until the window is fully open. Keep the switch pressed for a few seconds.
3. Lift and hold the switch until the window is fully closed. Keep the switch held for a few seconds.
4. Press and hold the switch until the window is fully open. Keep the switch pressed for a few seconds.

5. Lift and hold the switch until the window is fully closed. Keep the switch held for a few seconds.

**Note:** *Repeat the procedure if the window does not close when you use one-touch.*

## LOCKING THE REAR WINDOW CONTROLS



**WARNING:** When children and pets are in the rear seat, use the power window lockout button to prevent accidental operation of the power windows.

When the rear window lock/child safety lock switch is engaged, the window switches mounted on the rear door panels are deactivated.

# Windows

---



E390729

The control is on the driver door. It enables both the rear window locks and the child safety locks.

Press the control to switch the rear window locks and child safety locks on. Press the control again to switch them off. A light on the control illuminates when you switch them on.

The rear window lock and child lock settings remain active when you switch off your vehicle.

# Interior Mirror

---

## INTERIOR MIRROR PRECAUTIONS



**WARNING:** Do not adjust the mirrors when your vehicle is moving. This could result in the loss of control of your vehicle, serious personal injury or death.

**Note:** Do not clean the mirror housing or glass with harsh abrasives, fuel or other petroleum-based cleaning products.

## AUTO-DIMMING INTERIOR MIRROR

### WHAT IS THE AUTO-DIMMING INTERIOR MIRROR

The mirror dims to reduce the effect of bright light from behind. It returns to normal when the bright light from behind is no longer present or if you shift into reverse (R).

## AUTO-DIMMING INTERIOR MIRROR LIMITATIONS

Do not block the sensors on the front and back of the mirror.

**Note:** A rear center passenger or raised rear center head restraint could prevent light from reaching the sensor.

# Exterior Mirrors

## ADJUSTING THE EXTERIOR MIRRORS

 **WARNING:** Do not adjust the mirrors when your vehicle is moving. This could result in the loss of control of your vehicle, serious personal injury or death.

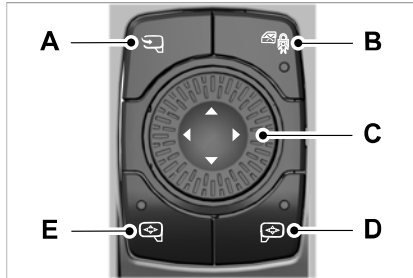

- A Power fold.
- B Rear window and child safety lock.
- C Adjustment control.

- D Right-hand mirror.
- E Left-hand mirror.

To adjust the mirrors, switch your vehicle on and place the ignition in accessory or start.

1. Select the mirror you want to adjust. The control light turns on.
2. Use the adjustment control to adjust the position of the mirror.
3. Press the mirror control again. The control light turns off.

## FOLDING THE EXTERIOR MIRRORS

With the auto-fold feature enabled, the exterior mirrors fold in toward the glass after you place the transmission into park (P), turn off the vehicle, open and close the driver side door and lock the vehicle. The exterior mirrors unfold and return to their driving position after you unlock the vehicle and open and close the driver side door.



For tight parking conditions, press the control to fold the mirrors.

Press the control again to unfold the mirrors.

If you press the control to fold in the mirrors with auto-fold on, the mirrors do not unfold when you unlock your vehicle.

**Note:** *The power folding mirrors operate with the ignition on, and for several minutes after you switch the ignition off.*

**Note:** *If you fold and unfold the mirrors several times within one minute, the power fold function may turn off to protect the motors from overheating.*

## Switching Auto-fold On and Off

1. From the settings menu, press Vehicle. See **Center Display** (page 468).
2. Press Mirrors.
3. Switch Autofold on or off.

# Exterior Mirrors

---

## Loose Mirror

If you manually fold the power-folding mirrors, they may not work properly even after you reposition them. Reset the mirrors if:

- They vibrate when you drive.
- They feel loose.
- They do not stay in the folded or unfolded position.
- One of the mirrors is not in its normal driving position.

To reset the power-fold feature, use the power-folding mirror control to fold and unfold the mirrors. You may hear a loud noise as you reset the power-folding mirrors. This sound is normal. Operate the power-folding mirrors an additional 3 to 4 times to synchronize the mirrors.

If the above process does not help you to fix the loose mirror, perform the following steps.

1. Fold or retract both mirrors manually.
2. Using the power folding control switch, operate the mirrors until you hear an audible click.

3. Operate the power folding an additional 3 to 4 times to synchronize the mirrors.

Repeat this process as needed each time you manually fold the mirrors.

# Moonroof (If Equipped)

## OPENING AND CLOSING THE SUNSHADE



**WARNING:** Do not leave a key or remote control unattended in the vehicle. Children or pets could operate the sunshade and get caught in a closing sunshade. Failure to follow this instruction could result in personal injury.



**WARNING:** Do not leave children or pets unattended in your vehicle and do not let children play with the sunshade. Failure to follow this instruction could result in personal injury.

The controls are on the overhead console.

### Opening the Sunshade



Press and release the switch to activate the one-touch open feature. To stop movement, press the switch a second time. The sunshade also opens when you open the moonroof.

## Closing the Sunshade



**WARNING:** When closing the sunshade, verify that it is free of obstructions and make sure children and pets are not in the proximity of the sunshade. Failure to follow this instruction could result in personal injury.



**WARNING:** If an obstruction is detected, press the switch a second time and reverse the sunshade immediately. Failure to follow this instruction could result in personal injury.



Press and release the switch to activate the one-touch close feature. To stop movement, press the switch a second time.

## OPENING AND CLOSING THE MOONROOF



**WARNING:** Do not leave children or pets unattended in your vehicle and do not let children play with the moonroof. Failure to follow this instruction could result in personal injury or death.



**WARNING:** Do not leave a key or remote control unattended in the vehicle. Children or pets could operate the moonroof and could become trapped in a closing moonroof. Failure to follow this instruction could result in personal injury or death.

The controls are on the overhead console.

### Opening the Moonroof



Press and release the switch to activate the one-touch open feature. To stop movement, press the switch a second time.

# Moonroof (If Equipped)

## Closing the Moonroof



**WARNING:** When closing the moonroof, verify that it is free of obstructions and make sure children and pets are not in the proximity of the moonroof. Failure to follow this instruction could result in personal injury or death.



**WARNING:** If an obstruction is detected, release the switch and reverse the moonroof immediately. Failure to follow this instruction could result in personal injury or death.



Press and release the switch to activate the one-touch close feature, from either the open or vent positions. To stop movement, press the switch a second time.

## VENTING THE MOONROOF



**WARNING:** Do not leave children unattended in your vehicle and do not let them play with the moonroof. Failure to follow this instruction could result in personal injury.

The moonroof controls are on the overhead console.



With the moonroof in the closed position, press and release the switch to vent the moonroof. To close the moonroof from the vent position, press and release the switch again.

## MOONROOF BOUNCE-BACK

### WHAT IS MOONROOF BOUNCE-BACK

The moonroof stops and reverses some distance if it detects an obstacle when closing.

## OVERRIDING MOONROOF BOUNCE-BACK

Press and hold the close switch within two seconds after the moonroof comes to a stop.



# Instrument Cluster

## INSTRUMENT CLUSTER OVERVIEW

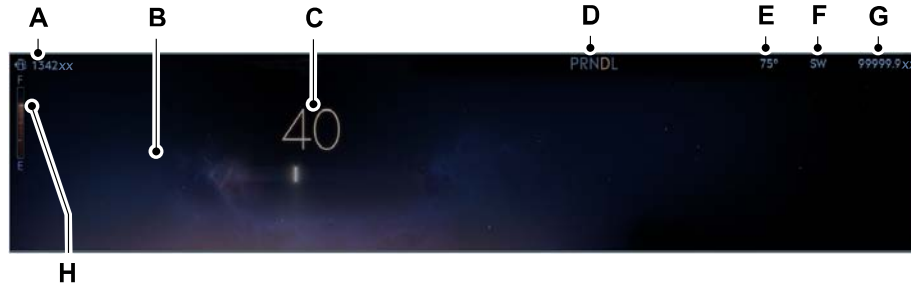

- A Distance to empty.
- B Information on demand areas.
- C Speedometer.
- D Transmission position indicator.
- E Outside air temperature.
- F Compass.
- G Odometer.
- H Fuel gauge.

# Instrument Cluster

---

## TACHOMETER

Indicates the engine speed.

## POWER GAUGE

The power gauge displays the amount of power going to the wheels when accelerating or maintaining speed. When the system limits the available maximum power, the right side of the gauge shows gray lines representing the proportional reduction in available power. When slowing down by lifting your foot off the accelerator pedal or pressing the brake, the gauge displays the amount of power the regenerative system captures and returns to the high voltage battery.

## SPEEDOMETER

Indicates the vehicle speed.

## FUEL GAUGE

### WHAT IS THE FUEL GAUGE

Indicates approximately how much fuel is in the fuel tank.

### FUEL GAUGE LIMITATIONS

The fuel gauge may not provide an accurate reading when your vehicle is on an incline.

### LOCATING THE FUEL FILLER DOOR

The arrow adjacent to the fuel pump symbol indicates on which side of your vehicle the fuel filler door is located.

### WHAT IS THE LOW FUEL REMINDER

A low fuel level reminder displays and sounds when the distance to empty reaches 50 mi (80 km), 25 mi (40 km), 10 mi (20 km) and 0 mi (0 km).

**Note:** *The low fuel reminder can appear at different fuel gauge positions depending on fuel economy conditions. This variation is normal.*

### WHAT IS DISTANCE TO EMPTY

Indicates the approximate distance your vehicle can travel on the fuel remaining in the tank. Changes in driving pattern can cause the value to not only decrease but also increase or stay constant for periods of time.

## ENGINE COOLANT TEMPERATURE GAUGE

Indicates the engine coolant temperature.

# Instrument Cluster

## WHAT ARE THE INSTRUMENT CLUSTER WARNING LAMPS

Warning lamps alert you to a vehicle condition that could become serious. Some lamps illuminate when you start your vehicle to make sure they work. If any lamps remain on after starting your vehicle, refer to the respective system warning lamp for further information.

## INSTRUMENT CLUSTER WARNING LAMPS

### Anti-Lock Brake System



If it illuminates when you are driving, this indicates that the system requires service. Your vehicle continues to have normal braking without the anti-lock brake system function. Have your vehicle checked as soon as possible.

### Battery



It illuminates when you switch the ignition on.

If it illuminates when the engine is running, this indicates your vehicle requires service. Have your vehicle checked as soon as possible.

### Brake System



It illuminates when you apply the parking brake and the ignition is on. If it illuminates when your vehicle is moving, make sure the parking brake is released. If the parking brake is released, this indicates low brake fluid level or the brake system requires service. Have your vehicle checked as soon as possible.

**Note:** *Indicators may vary depending on region.*

### Door Ajar



It illuminates when you switch the ignition on and remains on if any door is open.

### Electric Parking Brake



It illuminates or flashes when the electric parking brake requires service.



**Note:** *Indicators may vary depending on region.*

### Engine Coolant Temperature



If it illuminates, safely stop your vehicle and switch your vehicle off.

### Fasten Seatbelt



It illuminates and a tone sounds until you fasten the seatbelts.

### High Voltage Electric System Failure



It illuminates if your hybrid electric vehicle has an electrical component fault or failure that causes your vehicle to shutdown or enter a limited operating mode. A message can appear in the instrument cluster display.

# Instrument Cluster

## Hood Ajar



It illuminates when the ignition is on and the hood is not completely closed.

## Liftgate Ajar



It illuminates when the ignition is on and the liftgate is not completely closed.

## Low Beam Warning



It illuminates when the low beam headlamp requires service. Have the system checked as soon as possible.

## Low Fuel Level



It illuminates when the fuel level is low.

## Low Tire Pressure



It illuminates when your tire pressure is low. If illuminated, check your tire pressure as soon as possible. If it begins to flash at anytime, have the system checked as soon as possible.

## Low Washer Fluid Level



It illuminates when the washer fluid is low.

## Malfunction Indicator Lamp



If it illuminates when the ignition is on and the engine is off, this is normal operation. If it illuminates when the engine is on this indicates that the emission control system requires service. If it flashes, have your vehicle checked immediately. See **Starting and Stopping the Engine – Warning Lamps** (page 190). See **Emission Law** (page 547).

## Oil Pressure



It illuminates when the engine oil pressure is low.

## Powertrain Fault



It illuminates when the powertrain requires service. Have your vehicle checked as soon as possible.

## Steering System



It illuminates if the system detects a fault during the continuous diagnostic checks.

## WHAT ARE THE INSTRUMENT CLUSTER INDICATORS

Indicators notify you of various features that are active on your vehicle.

# Instrument Cluster

## INSTRUMENT CLUSTER INDICATORS

### Adaptive Cruise Control



See **Adaptive Cruise Control** (page 264).

### Airbag



See **Airbags** (page 58).

### Auto Hold



See **Auto Hold** (page 239).



### Automatic High Beam



See **Automatic High Beam Control** (page 115).

### Auto Start-Stop



See **Auto Start-Stop** (page 197).



### Blind Spot Information System



See **Blind Spot Information System** (page 307).

### Cruise Control



See **Adaptive Cruise Control** (page 264).

### Drive Modes

See **Drive Mode Control** (page 293).

**Note:** Available drive modes could vary depending on your vehicle options and model.



Conserve.



Deep Conditions.



Excite .



Normal.



Slippery.

### Rear Fog Lamp



See **Exterior Lighting** (page 111).

### Headlamp High Beam



See **Exterior Lighting** (page 111).

### Lane Centering



See **Lane Keeping System** (page 297).

# Instrument Cluster

---

## Lane Keeping System



See **Lane Keeping System** (page 297).

## Parking Lamps



See **Exterior Lighting** (page 111).

## Pre-Collision Assist



See **Pre-Collision Assist** (page 313).

## Ready to Drive



Illuminates when you have switched on your hybrid electric vehicle and it is ready to drive. A corresponding message can appear stating ready to drive.

## Speed Limiter



## Stability and Traction Control



See **Stability Control** (page 242).  
See **Traction Control** (page 241).



## Turn Signal



See **Exterior Lighting** (page 111).

# Personalized Settings

---

## CHANGING THE LANGUAGE

1. From the settings menu, press System Settings. See **Center Display** (page 468).
2. Press Language.
3. Select a language.

## CHANGING THE MEASUREMENT UNIT

1. From the settings menu, press System Settings. See **Center Display** (page 468).
2. Press Units.
3. Press Measurement Units.
4. Select a measurement unit.

## CHANGING THE TEMPERATURE UNIT

1. From the settings menu, press System Settings. See **Center Display** (page 468).
2. Press Units.
3. Press Temperature Units.

4. Select a temperature unit.

## CHANGING THE TIRE PRESSURE UNIT

1. From the settings menu, press System Settings. See **Center Display** (page 468).
2. Press Units.
3. Press Tire Pressure Units.
4. Select a pressure unit.

# Trip Computer

---

## ACCESSING THE TRIP COMPUTER

1. Access the instrument panel display screen. See **Customizing the Instrument Panel Display** (page 470).
2. Press and drag a trip tile to the active tile area.

## RESETTING THE TRIP COMPUTER

The trip tile must be in the active tile area to reset it.

1. Access the instrument panel display screen. See **Customizing the Instrument Panel Display** (page 470).
2. Press the trip tile in the active tile area.
3. Press reset.



# Remote Start

## WHAT IS REMOTE START

The system allows you to remotely start your vehicle and to adjust the interior temperature according to the settings that you chose.

## REMOTE START PRECAUTIONS



**WARNING:** Do not start the engine in a closed garage or in other enclosed areas. Exhaust fumes are toxic. Always open the garage door before you start the engine. Failure to follow this instruction could result in personal injury or death.

## REMOTE START LIMITATIONS

Remote start does not work under the following conditions:

- The alarm horn is sounding.
- The hood is open.
- The transmission is not in park (P).

- The ignition is on.
- The battery voltage is below the minimum operating voltage.

**Note:** Do not use remote start if your fuel level is low.

**Note:** To use remote start with Lincoln Way or Phone as a Key, enable the modem. See **Connecting Lincoln Way to the Modem** (page 456).

## ENABLING REMOTE START

1. From the settings menu, press Vehicle. See **Center Display** (page 468).
2. Press Remote Start Setup.
3. Switch Remote Start on or off.

**Note:** To remote start with Lincoln Way, make sure that the modem is enabled. See **Connecting Lincoln Way to the Modem** (page 456).

## REMOTELY STARTING AND STOPPING THE VEHICLE

### Remotely Starting the Vehicle



Press the button on the remote control.



Within three seconds, press the button on the remote control.

Within three seconds, press the button again.

**Note:** You can also use the Lincoln Way app to start the vehicle.

**Note:** The turn signals flash twice.

**Note:** The parking lamps turn on when the vehicle is running.

**Note:** The horn sounds if the system fails to start.

**Note:** All other vehicle systems remain off when you have remotely started the vehicle.

# Remote Start

**Note:** The vehicle remains secured when you have remotely started the vehicle. A valid key must be inside your vehicle to switch your vehicle on and drive your vehicle.

## Remotely Stopping the Vehicle



Press the button on the remote control.

## EXTENDING THE REMOTE START DURATION

To extend the remote start duration during remote start, do the following:



Press the button on the remote control.



Within three seconds, press the button on the remote control.

Within three seconds, press the button again.

If the duration is set to 15 minutes, the duration extends by another 15 minutes. This provides a total of 30 minutes.

**Note:** Remote start can only be extended once.

**Note:** A maximum of two remote starts, or one remote start with an extension, are allowed. To reset the restart procedure switch the vehicle to on, then to off.

## REMOTE START SETTINGS

1. From the settings menu, press Vehicle. See **Center Display** (page 468).
2. Press Remote Start Setup.

## Switching Climate Control Auto Mode On and Off

1. Press Climate Control.
2. Press Auto or Last Setting.

**Note:** If you switch the auto mode on, the system attempts to heat or cool the interior to 72°F (22°C). When you switch the vehicle on, the climate control system returns to the last used settings.

**Note:** If you switch the last settings on, the system remembers the last used settings.

## Heated Seat Settings

1. Press Seats.
2. Press Auto or Off.

**Note:** If you switch the heated seat settings on, the heated seats turn on during cold weather.

**Note:** You cannot adjust the heated seat settings when you remotely start your vehicle.

## Heated Steering Wheel Settings

1. Press Seats and Steering Wheel.
2. Press Auto or Off.

**Note:** If you switch the heated steering wheel settings on, the heated steering wheel turns on during cold weather.

**Note:** You cannot adjust the heated steering wheel settings when you remotely start your vehicle.

## Remote Start Duration

1. Press Duration.
2. Press the duration you prefer.

# Climate Control

## IDENTIFYING THE CLIMATE CONTROL UNIT



Depending on your vehicle options, the controls could look different than what you see here.

## SWITCHING CLIMATE CONTROL ON AND OFF



Press the button.

## SWITCHING RECIRCULATED AIR ON AND OFF



Press the button to recirculate air currently in the passenger compartment.

**Note:** Recirculated air may turn off automatically, or prevent you from switching on in all air flow modes except MAX A/C to reduce the risk of fogging. Recirculation may also turn on and off automatically in various air distribution control combinations to improve heating or cooling efficiency.

## SWITCHING AIR CONDITIONING ON AND OFF



Press the button.

**Note:** Under certain conditions, the air conditioning compressor could continue to operate after you switch air conditioning off.

**Note:** To keep the system and its components fully functional, switch air conditioning on and let your vehicle idle at least once per month for a minimum of two minutes.

## SWITCHING MAXIMUM DEFROST ON AND OFF



Press the button.

Air flows through the windshield air vents, and the blower motor adjusts to the highest speed.

You can also use this setting to defog and clear the windshield of a thin covering of ice.

**Note:** To prevent window fogging, you cannot select recirculated air when maximum defrost is on.

**Note:** The heated rear window also turns on when you select maximum defrost.

# Climate Control

## SWITCHING MAXIMUM COOLING ON AND OFF



Press the button.

**Note:** When you switch maximum cooling off, air conditioning remains on.

## SWITCHING THE HEATED REAR WINDOW ON AND OFF



Press the button to clear the rear window of thin ice and fog. The heated rear window turns off after a short period of time.

**Note:** Do not use harsh chemicals, razor blades or other sharp objects to clean or remove decals from the inside of the heated rear window as this could damage the heated rear window gridlines not covered by the vehicle warranty.

**Note:** Make sure the engine is on before operating the heated rear windows.

## SETTING THE BLOWER MOTOR SPEED



Press the arrows to adjust the blower motor speed.

## SWITCHING THE HEATED MIRRORS ON AND OFF

When you switch the heated rear window on, the heated exterior mirrors turn on.

**Note:** Do not remove ice from the mirrors with a scraper or adjust the mirror glass when it is frozen in place.

**Note:** Do not clean the mirror housing or glass with harsh abrasives, fuel or other petroleum-based cleaning products. The vehicle warranty may not cover damage caused to the mirror housing or glass.

## SETTING THE TEMPERATURE



Adjusting the arrows on either side of the climate control sets the temperature for the respective sides.

< Press the arrow to decrease the temperature.

> Press the arrow to increase the temperature.

**Note:** The blue arrow decreases and the red arrow increases the temperature. Pressing the temperature value allows you to control it using the slider.



Press the button to switch dual mode on.

## DIRECTING THE FLOW OF AIR

### Electromechanical registers

Electromechanical registers allow airflow direction to be controlled through the touchscreen.

# Climate Control



## Directing the flow of air on driver and passenger side:



Drag the airflow line to change the airflow direction.



Press this button to direct the airflow direction onto the body.



Press this button to direct the airflow direction away from the body.



Press this button to allow the airflow to sweep.



Drag the airflow line down to close area or use close button to shut down registers, touch related area opens the register.

When in free adjustment mode, you can change the direction from any of the air vents by dragging the relevant register areas in the touchscreen.

## To cancel the airflow function, do one of the following:

- Touch/adjust the register manually.
- Select the different motion options.
- Press the close icon on the menu.

**Note:** Do not block the air vents when they are moving. Once blocked, drag the airflow direction and clear out the obstacle.

**Note:** Electromechanical registers may continue to work for a certain time after the vehicle is powered off. This is normal.

## Directing Air to the Windshield Air Vents



Press the button on the touchscreen to access the climate controls.

## Directing Air to the Instrument Panel Air Vents



Press the button on the touchscreen to access the climate controls.

## Directing Air to the Footwell Air Vents



Press the button on the touchscreen to access the climate controls.

## AUTO MODE

## SWITCHING AUTO MODE ON AND OFF



Press the button to switch auto mode on. Repeatedly press the button to adjust auto mode.

**Note:** When you switch auto mode on, lights on the blower motor control do not illuminate to indicate the blower motor speed.

Adjust the blower motor control or air distribution control to switch auto mode off.

# Climate Control

---

## CLIMATE CONTROL HINTS

### General Hints

- Prolonged use of recirculated air may cause the windows to fog up.
- You may feel a small amount of air from the footwell air vents regardless of the air distribution setting.
- To reduce humidity build-up inside your vehicle, do not drive with the system switched off or with recirculated air always switched on.
- Do not place objects under the front seats as this may interfere with the airflow to the rear seats.
- Remove any snow, ice or leaves from the air intake area at the base of the windshield.
- To improve the time to reach a comfortable temperature in hot weather, drive with the windows open until you feel cold air through the air vents.

### Automatic Climate Control

- Adjusting the settings when your vehicle interior is extremely hot or cold is not necessary. Automatic mode is best recommended to maintain set temperature.
- The system adjusts to heat or cool the interior to the temperature you select as quickly as possible.
- For the system to function efficiently, the instrument panel and side air vents should be fully open.
- If you press **AUTO** during cold outside temperatures, the system directs air flow to the windshield and side window air vents. In addition, the blower motor may run at a slower speed until the engine warms up.
- If you press **AUTO** during hot temperatures and the inside of the vehicle is hot, the system uses recirculated air to maximize interior cooling. Blower motor speed may also reduce until the air cools.

### Quickly Heating the Interior

1. Press **AUTO**.
2. Adjust the temperature function to the setting you prefer.

### Recommended Settings for Heating

1. Press **AUTO**.
2. Adjust the temperature function to the setting you prefer. Use 72°F (22°C) as a starting point, then adjust the setting as necessary.

### Quickly Cooling the Interior

1. Press **MAX A/C**.
2. Drive with the windows open for a short period of time.

### Recommended Settings for Cooling

1. Press **AUTO**.
2. Adjust the temperature function to the setting you prefer. Use 72°F (22°C) as a starting point, then adjust the setting as necessary.

# Climate Control

---

## **Defogging the Side Windows in Cold Weather**

1. Press and release defrost or maximum defrost.
2. Adjust the temperature control to the setting you prefer. Use 72°F (22°C) as a starting point, then adjust the setting as necessary.

# Interior Air Quality

## WHAT IS THE CABIN AIR FILTER

The cabin air filter improves the quality of air in your vehicle by trapping dust, pollen and other particles.

## REPLACING THE CABIN AIR FILTER

Replace the filter at regular intervals. See **Scheduled Maintenance** (page 493).

The cabin air filter is behind the glove compartment.

To remove the lower glove compartment and access the filter:

1. Open the glove compartment.

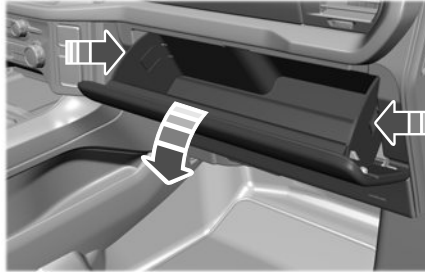

2. Press the tab on each side.
3. Fully lower the glove compartment.
4. Pull the glove compartment toward you.

## AUTO AIR REFRESH (IF EQUIPPED)

## WHAT IS AUTO AIR REFRESH

Auto air refresh helps improve or maintain the quality of air within your vehicle cabin.

## HOW DOES AUTO AIR REFRESH WORK

Auto air refresh uses an air quality sensor to automatically adjust the climate control system to change from outside air to recirculated air to help reduce the entry of outside odors into the cabin. It uses a particulate matter sensor in the cabin to estimate and provide information about particulate matter pollution in the cabin. It also allows you to refresh the cabin air with outside air on-demand or automatically.

## CHECKING THE INTERIOR AIR QUALITY



Press the button on the touchscreen.



Press Auto Air Refresh.



# Interior Air Quality

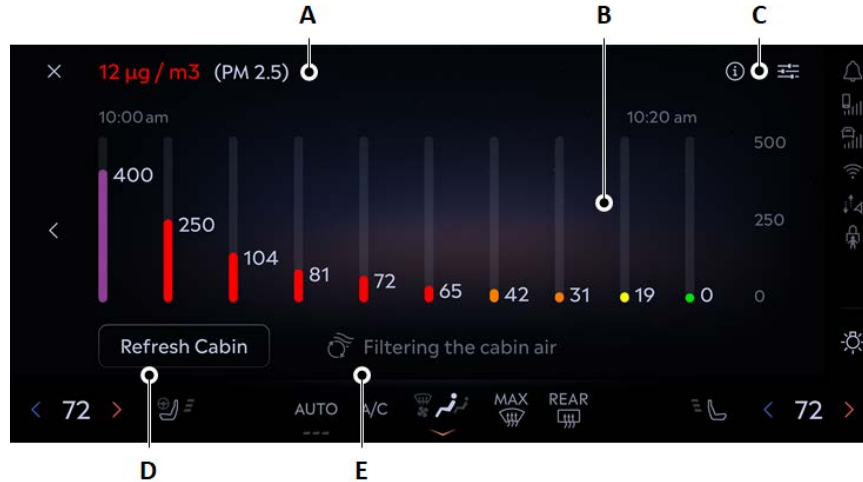

- A Cabin air quality.
- B Cabin air history.
- C Info book.

# Interior Air Quality

- D Refresh cabin
- E Auto air refresh indicators

## Particulate Matter Pollution Information

Press Help for more information about particulate matter pollution.

The numbers provided by the cabin's PM2.5 sensor are estimates of the concentration of particles in the cabin air. The measurement unit is  $\mu\text{g}/\text{m}^3$ , representing mass (micrograms of particulates) per unit of air volume (cubic meter of air).

The colors around the PM2.5 numbers provide visual cues about the concentration levels.

**Note:** *PM2.5 is only one pollution type contributing to an Air Quality Index and by itself does not represent the Air Quality Index.*

## CHECKING THE EXTERIOR AIR QUALITY

You can see net PM2.5 information by selecting the oval showing the net PM2.5 number or text on the touchscreen.

**Note:** *The colors around the PM2.5 numbers provide visual cues about PM2.5 concentration.*

## AUTO AIR REFRESH INDICATORS

The indicator area is on the touchscreen feature bar and displays one of the following:



Indicates the blower motor is on for filtering and PM2.5 is low.



Indicates the blower motor is on for filtering.



Indicates the blower motor is off.



Indicates the status is not available.

## MANUALLY REFRESHING THE INTERIOR AIR



Press the button on the touchscreen.

1. Press Auto Air Refresh.
2. Press Cabin Refresh.

**Note:** *Climate control settings could change for about 90 seconds to help flow outside air into the cabin. You can change the blower motor speed to the settings you prefer.*

**Note:** *The climate control must be on to manually refresh the interior air.*

# Interior Air Quality

---

## AUTOMATICALLY REFRESHING THE INTERIOR AIR

If the cabin air recirculates continuously for longer than 35 minutes, climate control settings could change automatically for about 90 seconds to help flow outside air into the cabin.

## Refreshing the Interior Air Upon Cabin Start

If the cabin is above 75°F (24°C) and the engine has been off for over 30 minutes, when you start the engine the climate control system settings could change for approximately 75 seconds to help flow outside air into the cabin.

**Note:** *Refreshing may also occur if the climate control and blower motor were previously on.*

## Refreshing the Interior Air Upon Remote Start

If the cabin is above 75°F (24°C) while parked for over 30 minutes, when you remote start the engine the climate control system settings could change for approximately 75 seconds to help flow outside air into the cabin.

## AUTO AIR REFRESH HINTS

To further improve the air quality in the cabin:

- Adjust the windows and other cabin openings such as the moonroof.
- Switch recirculated air on or off.
- Manually refresh the interior air.
- Adjust the blower motor speed.
- Replace the cabin air filter at regular intervals.

## DIGITAL SCENT (IF EQUIPPED)

Digital scent provides a certain type and intensity of scent in the cabin. There are three different scents in your vehicle.

## How Digital Scent Works

The three scent cartridges are stored inside the front armrest and can be activated through the center display.

Digital scent works under the following conditions:

- The ignition is on.
- The scent cartridge is not empty.
- The scent cartridge is Lincoln authorized.
- The temperature of the scent cartridge is below 139.9°F (60°C) and above 14.0°F (-10°C).

## Using Digital Scent

1. Open the Digital Scent screen on your touchscreen. See **Center Display Overview** (page 468).

**Note:** *This screen displays the scent names, scent intensity and remaining life of each scent cartridge.*

2. Select the scent you prefer to turn it on.

# Interior Air Quality

3.  Press the power button next to the scent name to turn it off.

**Note:** The power button is not visible unless Digital Scent is on.

4. Press the indicators next to the scent name to adjust the intensity.

**Note:** The scent and level selections are stored for the currently active driver profile.



Press the button for more information on purchasing additional scents.

## Digital Scent Settings

1. Open the Digital Scent screen on your touchscreen. See **Center Display Overview** (page 468).
2. Press the settings icon.

From this menu you can do the following:

- Select a frequency type.
- Switch Diffuse at vehicle start on or off.

**Note:** These settings are stored for the currently active driver profile.

## Replacing a Digital Scent Cartridge

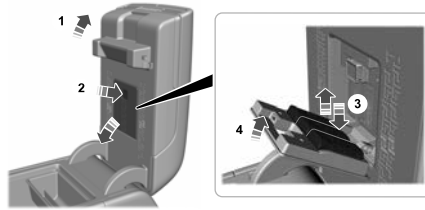

1. Open the center console.
2. Press the cartridge replace button on the scent cartridge unit inside the front armrest to open the tray.
3. Remove the empty cartridge and insert the new cartridge.
4. Close the tray.

# Interior Air Quality

## Digital Scent - Information Messages

Message	Details
Low	Displays below the scent name when the scent level in a cartridge becomes lower than 25%.
Empty	Displays below the scent name when the scent level in a cartridge reaches 0%.
Scent Limited By	The system reactiv-

Message	Details
Temperature	ates once the temperature reaches the operable limit.
No Cartridge Detected	Displays as scent name when there is no cartridge installed.
Cartridge Not Recognized	Displays as scent name when the installed cartridge is not an authorized product.

## INTERIOR AIR QUALITY – TROUBLESHOOTING

## INTERIOR AIR QUALITY – INFORMATION MESSAGES

**Note:** *Depending on your vehicle options, not all messages display or are available. Certain messages may be abbreviated or shortened depending upon which cluster type you have.*

Message	Action
Environmental Limit	Allow time for the cabin PM2.5 sensor to cool down, warm up, or dry out.

# Front Seats

## FRONT SEAT PRECAUTIONS

 **WARNING:** Sitting improperly, out of position or with the seatback reclined too far can take weight off the seat cushion and affect the decision of the passenger sensing system, resulting in serious injury or death in the event of a crash. Always sit upright against your seat back, with your feet on the floor.

 **WARNING:** Do not recline the seat backrest too far as this can cause the occupant to slide under the seatbelt, resulting in personal injury in the event of a crash.

 **WARNING:** Do not place objects higher than the top of the seat backrest. Failure to follow this instruction could result in personal injury or death in the event of a sudden stop or crash.

 **WARNING:** Do not adjust the driver seat or seat backrest when your vehicle is moving. This may result in sudden seat movement, causing the loss of control of your vehicle.

## SITTING IN THE CORRECT POSITION

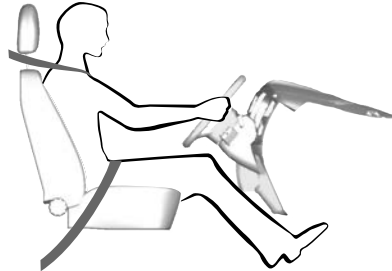

When you use them properly, the seat, head restraint, seatbelt and airbags will provide optimum protection in the event of a crash.

We recommend that you follow these guidelines:

- Sit in an upright position with the base of your spine as far back as possible.
- Do not recline the seat backrest so that your torso is more than 30 degrees from the upright position.
- Adjust the head restraint so that the top of it is level with the top of your head and as far forward as possible. Make sure that you remain comfortable.
- Keep sufficient distance between yourself and the steering wheel. We recommend a minimum of 10 in (25 cm) between your breastbone and the airbag cover.
- Hold the steering wheel with your arms slightly bent.

# Front Seats

- Bend your legs slightly so that you can press the pedals fully.
- Position the shoulder strap of the seatbelt over the center of your shoulder and position the lap strap tightly across your hips.

Make sure that your driving position is comfortable and that you can maintain full control of your vehicle.

## POWER SEATS

### HEAD RESTRAINT COMPONENTS

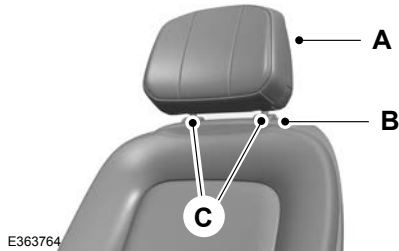



E363764

The head restraints consist of:

- A An energy absorbing head restraint.
- B Guide sleeve adjust and unlock button.
- C Two steel stems.

### ADJUSTING THE HEAD RESTRAINT

 **WARNING:** Fully adjust the head restraint before you sit in or operate your vehicle. This will help minimize the risk of neck injury in the event of a crash. Do not adjust the head restraint when your vehicle is moving.

 **WARNING:** The head restraint is a safety device. Whenever possible it should be installed and properly adjusted when the seat is occupied. Failure to adjust the head restraint properly could reduce its effectiveness during certain impacts.



**WARNING:** Adjust the head restraints for all passengers before you drive your vehicle. This will help minimize the risk of neck injury in the event of a crash. Do not adjust the head restraints when your vehicle is moving.

**Note:** *Adjust the seat backrest to an upright driving position before adjusting the head restraint. Adjust the head restraint so that the top of it is level with the top of your head and as far forward as possible. Make sure that you remain comfortable. If you are extremely tall, adjust the head restraint to its highest position.*

Pull the head restraint up to raise it.

To lower the head restraint:

1. Press and hold the adjust and unlock button.
2. Push the head restraint down.

To tilt the head restraint (if equipped):

# Front Seats



E363765

1. Adjust the seat backrest to an upright driving or riding position.
2. Pivot the head restraint forward toward your head to the preferred position.

After the head restraint reaches the forward-most tilt position, pivot it forward again to release it to the rearward, untilted position.

**Note:** Do not attempt to force the head restraint backward after it is tilted. Instead, continue tilting it forward until the head restraint releases to the upright position.

## Adjusting the Head Restraint Wing (if Equipped)

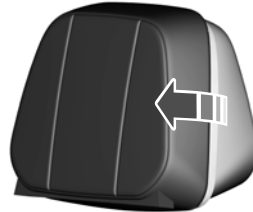

E370253

Pull forward the front portion of the Head restraint.

## Recovering the Head Restraint Wing

Push the wing backward.

## REMOVING THE HEAD RESTRAINT

1. Pull up the head restraint until it reaches its highest position.
2. Press and hold the adjust and unlock button.
3. Pull up the head restraint.

## INSTALLING THE HEAD RESTRAINT

Align the steel stems into the guide sleeves and push the head restraint down until it locks.



# Front Seats

## MOVING THE SEAT BACKWARD AND FORWARD

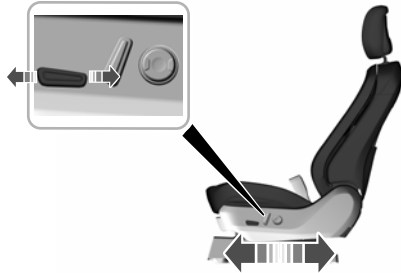

E390736

## ADJUSTING THE SEAT CUSHION

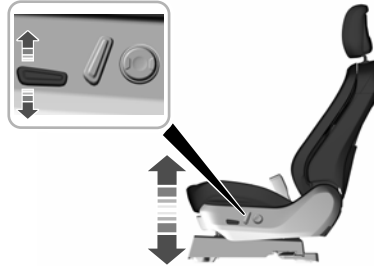

E390738

## Adjusting the Length of the Seat Cushion -If Equipped



E390740

## ADJUSTING THE SEAT BACKREST

 **WARNING:** Do not place cargo or any objects behind the seatback before returning it to the original position.

 **WARNING:** Do not adjust the driver seat or seat backrest when your vehicle is moving. This may result in sudden seat movement, causing the loss of control of your vehicle.



E390741

# Front Seats

## ADJUSTING THE SEAT HEIGHT

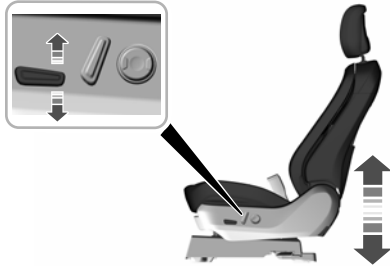

E390743

## ADJUSTING THE LUMBAR SUPPORT

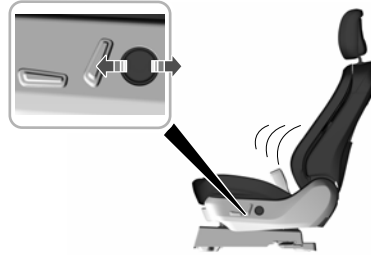

E390745

## MESSAGE SEATS (IF EQUIPPED)

### MESSAGE SEAT LIMITATIONS

The engine must be running or the vehicle must be in ON mode to activate the seats.

The passenger side massage is available if the occupant meets the seat sensor weight requirements.

Allow a few seconds for any selection to activate. Selecting a different adjustment cancels the current one in progress. When the seat backrest and cushion are both active, the massage alternates between zones.

## ADJUSTING THE MESSAGE SEAT SETTINGS

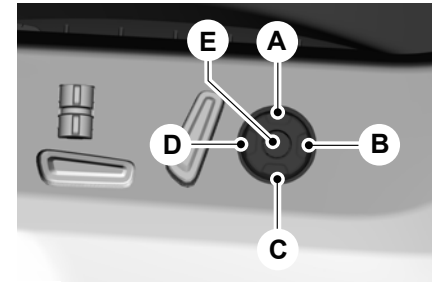

E390746

- A Select the previous message pattern or lumbar area.
- B Decrease the massage or lumbar intensity.
- C Increase the massage or lumbar intensity.
- D Select the previous massage pattern or lumbar area.
- E Increase the massage or lumbar intensity.

# Front Seats

- C Select the next massage pattern or lumbar area.
- D Increase the massage or lumbar Intensity.
- E Select the massage or lumbar mode.

You can also adjust this feature through the touchscreen.

## HEATED SEATS

### HEATED SEAT PRECAUTIONS



**WARNING:** Use caution when using the heated seat if you are unable to feel pain to your skin because of advanced age, chronic illness, diabetes, spinal cord injury, medication, alcohol use, exhaustion or other physical conditions. The heated seat could cause burns even at low temperatures, especially if used for long periods of time. Failure to follow this instruction could result in personal injury.



**WARNING:** Do not poke sharp objects into the seat cushion or seat backrest. This could damage the heated seat element and cause it to overheat. Failure to follow this instruction could result in personal injury.



**WARNING:** Do not place anything on the seat that blocks the heat, for example a seat cover or a cushion. This could cause the seat to overheat. Failure to follow this instruction could result in personal injury.

Do not:

- Place heavy objects on the seat.
- Operate the heated seat if water or any other liquid spills on the seat. Allow the seat to dry before do it.

### SWITCHING THE HEATED SEATS ON AND OFF

The vehicle must be running to use this feature.



Press the heated seat symbol on the touchscreen to switch on the heated seats.

Then, slide the menu bar up or down to control the heat intensity. The more indicators that display, the warmer the temperature of the seat.

**Note:** *The heated seats may remain on after you remote start your vehicle, based on your remote start settings. The heated seats may also turn on when you start your vehicle if they were on when you switched your vehicle off.*

## COOLED SEATS

### SWITCHING THE COOLED SEATS ON AND OFF

The cooled seats only function when the engine is running.



Press the cooled seat symbol on the touchscreen to switch on the cooled seats.

## Front Seats

---

Then, slide the menu bar to control the fan speed. More indicator lights indicate cooler settings.

**Note:** *The cooled seats may remain on after you remote start your vehicle, based on your remote start settings. The cooled seats may also switch on when you start your vehicle if they were on when you switched your vehicle off.*

# Rear Seats

## MANUAL SEATS

### HEAD RESTRAINT COMPONENTS

#### Rear Seat Outermost Head Restraints

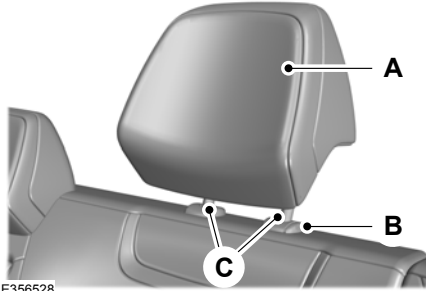

E356528

#### Rear Seat Center Head Restraint

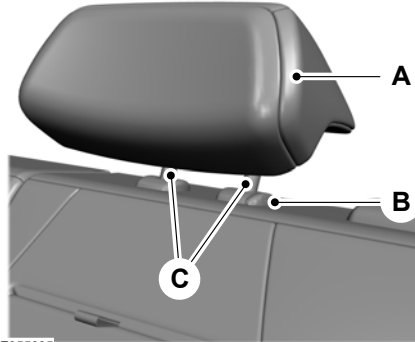

E356695

The head restraints consists of:

- A An energy absorbing head restraint.
- B Guide sleeve adjust and unlock button.
- C Two steel stems.

## ADJUSTING THE HEAD RESTRAINT

### Raising the Head Restraint

Pull the head restraint up to raise it.

### Lowering the Head Restraint

1. Press and hold the adjust and unlock button.
2. Push the head restraint down.

## REMOVING THE HEAD RESTRAINT

1. Pull the head restraint up until it reaches its highest position.
2. Press and hold the unlock button.
3. Pull the head restraint up.

## INSTALLING THE HEAD RESTRAINT

Align the steel stems into the guide sleeves and push the head restraint down until it locks.

## Rear Seats

### MOVING THE SEAT BACKWARD AND FORWARD

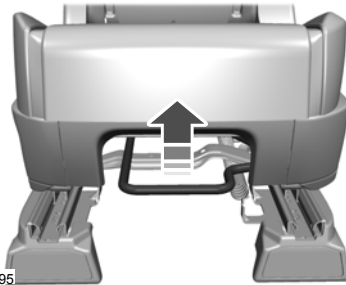

Lift the handle to move the second row seat forward or backward.

### ADJUSTING THE SEAT BACKREST

 **WARNING:** Reclining the seatback can cause an occupant to slide under the seat's seatbelt, resulting in severe personal injuries in the event of a crash.

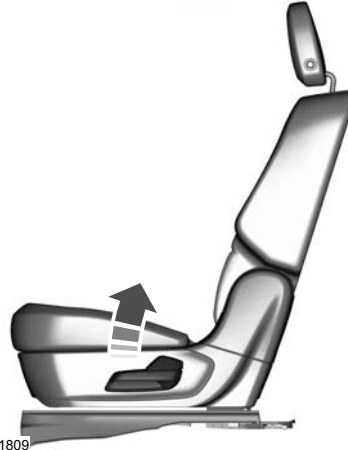

For the second row seats, the release handle is on the outermost side of the seat cushion. Lift it to adjust the seat backrest to your preferred position.

### FOLDING THE SEAT BACKREST

 **WARNING:** To prevent possible damage to the seat or seatbelts, make sure that the seatbelts are not fastened before folding the seatback.

 **WARNING:** When folding or unfolding the seats, take care not to get your fingers caught between the seat backrest and seat frame. Failure to follow this warning could result in serious personal injury.

The control buttons are inside the liftgate area.

# Rear Seats

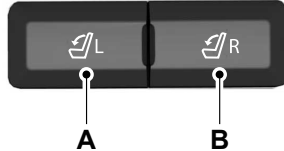

E392491

- A Press to fold the left-hand second row seat.
- B Press to fold the right-hand second row seat.

## UNFOLDING THE SEAT BACKREST

 **WARNING:** When unfolding the seat backrests, make sure that the seatbelts are not trapped behind the seat.

 **WARNING:** Make sure that the seats and the seat backrests are secure and fully locked in their catches.

Lift the seat backrest up to unfold it. Make sure the seat latch engages.

## HEATED SEATS (IF EQUIPPED)

### HEATED SEAT PRECAUTIONS (If Equipped)

 **WARNING:** Use caution when using the heated seat if you are unable to feel pain to your skin because of advanced age, chronic illness, diabetes, spinal cord injury, medication, alcohol use, exhaustion or other physical conditions. The heated seat could cause burns even at low temperatures, especially if used for long periods of time. Failure to follow this instruction could result in personal injury.

 **WARNING:** Do not poke sharp objects into the seat cushion or seat backrest. This could damage the heated seat element and cause it to overheat. Failure to follow this instruction could result in personal injury.

 **WARNING:** Do not place anything on the seat that blocks the heat, for example a seat cover or a cushion. This could cause the seat to overheat. Failure to follow this instruction could result in personal injury.

Do not:

- Place heavy objects on the seat.
- Operate the heated seat if water or any other liquid spills on the seat. Allow the seat to dry.

## SWITCHING THE HEATED SEATS ON AND OFF

The vehicle must be running to use this feature.

The rear seat heat controls are on the rear of the center console.

## Rear Seats

---



Press the heated seat symbol to cycle through the various heat settings and off. More indicator lights indicate warmer settings.

The heated seats turn off when you switch off the vehicle.



# Rear Occupant Alert System

## WHAT IS THE REAR OCCUPANT ALERT SYSTEM

The rear occupant alert system monitors vehicle conditions and notifies you to check for rear seat occupants when you switch the ignition off. The notifications can be in the form of warnings inside the vehicle and sounding of the horn if activated for a short period of time.

## HOW DOES THE REAR OCCUPANT ALERT SYSTEM WORK

The system monitors the activity of the buckle on the rear seatbelt and the opening and closing of the rear doors to indicate the potential presence of an occupant in the rear seat.

When **Child Seat Installed** is selected, the system monitors only the opening and closing of the rear doors to indicate the potential presence of an occupant in the rear seat.

When **Child Seat Installed** is not selected, the system monitors the rear seatbelt buckle activity and the opening and closing of the rear doors to indicate the potential presence of an occupant in the rear seat.

A message displays in the touchscreen and an audible warning sounds when you switch the ignition off after any of the following conditions have been met:

- A rear door is opened or closed while the ignition is on.
- You switch the ignition on within 15 minutes of a rear door opening and closing.
- You switch the ignition on within 15 minutes of the alert having displayed or sounded.

If you do not open a rear door within a short period of time of the message appearing in the center display, the first audible warning sounding and driver door open to close, the horn sounds for a short period of time.

**Note:** *Horn sounds only when the **Rear Occupant Alert** is set to **Alert & Horn**. If you change the setting, then there is no horn sound.*

## REAR OCCUPANT ALERT SYSTEM PRECAUTIONS



**WARNING:** On hot days, the temperature inside the vehicle can rise very quickly. Exposure of people or animals to these high temperatures for even a short time can cause death or serious heat related injuries, including brain damage. Small children are particularly at risk.



**WARNING:** Do not leave children or pets unattended in your vehicle. Failure to follow this instruction could result in personal injury or death.

## REAR OCCUPANT ALERT SYSTEM LIMITATIONS

The system does not detect the presence of objects or passengers in the rear seat. It monitors the activity of the buckle on the rear seatbelt and the opening and closing of the rear doors.

# Rear Occupant Alert System

**Note:** It is possible to receive an alert when there is no rear seat occupant, but alert conditions are met.

**Note:** It is possible to receive no alert when there is an occupant in the rear seat, if alert conditions are not met. For example, if a rear seat occupant does not enter the vehicle through a rear door.

## REAR OCCUPANT ALERT SYSTEM SETTINGS

1. From the settings menu, press Vehicle. See **Center Display** (page 468).
2. Press Rear Occupant Alert.
3. Select Alert & Horn or Alert Only or Off.

**Note:** The default setting is Alert Only.

**Note:** If you choose Alert only, the horn does not sound even when the alert conditions are met.

**Note:** Performing a system reset causes the system to switch on again.

## Switching Child Seat Installed On and Off

When the system is switched on, it monitors the opening and closing of the rear doors to indicate the potential presence of an occupant in the rear seat.

1. From the settings menu, press Vehicle. See **Center Display** (page 468).
2. Press Rear Occupant Alert.
3. Switch Child Seat Installed on or off.

**Note:** The default setting is on.

Switch the system on when the child restraint is mounted on any of the following:

- Forward facing seat.
- Rear facing seat.
- Toddler in a LATCH system child seat.

Switch the system off when the child is using any of the following:

- Seatbelt.
- Booster seat.

## Semiannual Reminder

When you switch the system off, a message appears every six months as a reminder that the system is off. You can switch the system back on or leave it off.

## REAR OCCUPANT ALERT SYSTEM INDICATORS

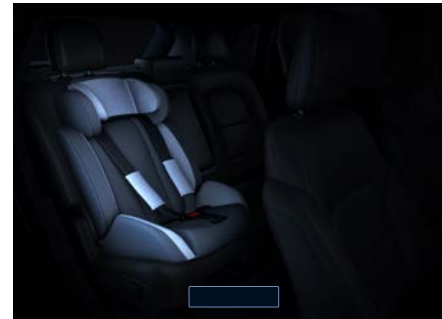

# Rear Occupant Alert System

---

Message
Check rear seats for occupants.

Displays when you switch the power off after the alert conditions are met.

The message displays for a short period of time. Press **Close** to acknowledge and remove the message.

**Note:** *Depending on your center display system version, the graphic may look different from what you see here.*

## REAR OCCUPANT ALERT SYSTEM AUDIBLE WARNINGS

The first audible warning is an alert tone within the vehicle, which sounds when you switch your vehicle off after the alert conditions are met. The warning sounds for a short period of time.

The second audible warning is from the horn. It sounds when you do not open a rear door within a short period of time of the message appearing in the center display, the first audible warning sounding, and driver door open to close. The warning sounds for a short period of time.

# Memory Function

## HOW DOES THE MEMORY FUNCTION WORK

The memory function recalls the position of these features:

- Driver seat.
- Power mirrors.
- Optional power steering column.

## MEMORY FUNCTION PRECAUTIONS



**WARNING:** Before activating the memory seat, make sure that the area immediately surrounding the seat is clear of obstructions and that all occupants are clear of moving parts.



**WARNING:** Do not use the memory function when your vehicle is moving.

## LOCATING THE MEMORY FUNCTION BUTTONS



The memory function buttons are on the driver door.

## SAVING A PRESET POSITION

1. Switch the ignition on.
2. Adjust the memory features to your preferred position.
3. Press and hold the preferred preset button until you hear a single tone.

A confirmation message appears in the information cluster display.

You can save up to three preset memory positions at any time.

## RECALLING A PRESET POSITION

Press and release a preset button.

**Note:** You can only recall a preset memory position when the ignition is off, or when you place the transmission in park (P) or neutral (N) if the ignition is on and the vehicle is not moving.

**Note:** Pressing any of the memory feature controls during a memory recall cancels the operation.

You can also recall a preset memory position by:

- Pressing the unlock button on your remote control if you linked it to a preset position.
- Unlocking the intelligent driver door handle if a linked remote control is present.

# Memory Function

---

**Note:** *Using a linked remote control to recall your memory position when the ignition is off moves the seat and steering column to the easy entry position.*

# Garage Door Opener

## GARAGE DOOR OPENER INTRODUCTION

### HomeLink Wireless Control System

The universal garage door opener replaces the common handheld garage door opener with a three-button transmitter integrated into the driver-side sun visor.



### How Does The Garage Door Opener Work

The system includes two primary features, a garage door opener and a platform for remote activation of devices within the home. You can program garage doors as well as entry gate operators, security systems, entry door locks and home or office lighting.

### Garage Door Opener Limitations

Canadian radio-frequency laws require transmitter signals to time out, or quit, after several seconds – which may not be long enough for HomeLink to pick up the signal. U.S. gate operators time-out in the same manner.

## GARAGE DOOR OPENER PRECAUTIONS AND FREQUENCIES

### Garage Door Opener Precautions



**WARNING:** Do not use the system with any garage door opener that does not have the safety stop and reverse feature as required by U.S. Federal Safety Standards (this includes any garage door opener manufactured before April 1, 1982). A garage door opener which cannot detect an object, signaling the door to stop and reverse, does not meet current federal safety standards. Using a garage door opener without these features increases the risk of serious injury or death.

# Garage Door Opener

## FCC and RSS-210 Industry Canada Compliance



**WARNING:** Changes or modifications not expressly approved by the party responsible for compliance could void the user's authority to operate the equipment. The term "IC:" before the radio certification number only signifies that Industry Canada technical specifications were met.

This device complies with Part 15 of the FCC Rules and with RSS-210 of Industry Canada. Operation is subject to the following two conditions: (1) this device may not cause harmful interference, and (2) this device must accept any interference received, including interference that may cause undesired operation.

This equipment complies with FCC radiation exposure limits set forth for an uncontrolled environment. End Users must follow the specific operating instructions for satisfying RF exposure compliance. This transmitter must be at least 8 in (20 cm) from the user and must not be co-located or operating in conjunction with any other antenna or transmitter.

## PROGRAMMING THE GARAGE DOOR OPENER

To clear all stored codes in the garage door opener in your vehicle, use the **clear** function. To override one button, use the **reprogram** function.

**Note:** *Make sure that the garage door and security device are free from obstruction when you are programming. Do not program the system with the vehicle in the garage.*

## Clearing the Garage Door Opener

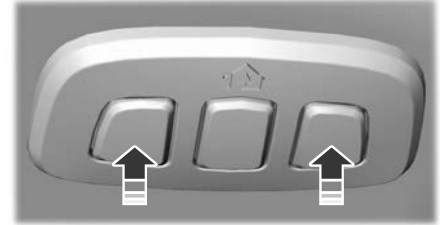

To clear all stored codes in the garage door opener in the vehicle:

1. Press and hold the outer two function buttons simultaneously for approximately 10 seconds until the indicator above the buttons flashes rapidly.
2. When the indicator flashes, release the buttons.

**Note:** *This clears all stored codes. You cannot erase individual buttons.*

# Garage Door Opener

**Note:** You can program a maximum of three devices. To change or replace any of the three devices after they have been initially programmed, you must either clear all codes, or reprogram each individual button.

**Note:** We recommend that upon the sale or lease termination of your vehicle, you erase the programmed function buttons for security reasons.

## Reprogramming the Garage Door Opener

If a button on your garage door opener has already been programmed, you can override it. To program a device to a previously trained button:

1. Press and hold the desired button for approximately 20 seconds until the indicator begins to flash.
2. Without releasing the button, proceed to Step 3 of **Programming the Garage Door Opener to your Handheld Transmitter**.

## Programming the Garage Door Opener to your Handheld Transmitter

**Note:** The programming steps below assume you are programming a HomeLink that was not previously programmed. If your HomeLink was previously programmed, you may need to **clear** or **reprogram** your HomeLink buttons.

**Note:** Put a new battery in the handheld transmitter. This allows for quicker training and accurate transmission of the radio-frequency signal.

**Note:** Make sure that the garage door and security device are free from obstruction when you are programming. Do not program the system with the vehicle in the garage.

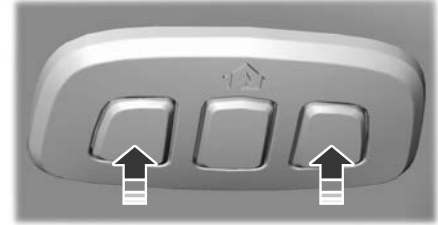

To program your in-vehicle HomeLink function button with your handheld transmitter:

1. With your vehicle parked outside of the garage, switch your vehicle on, but do not start your vehicle.
2. Press and release one of the three HomeLink function buttons that you would like to program.

**Note:** The indicator should begin to flash. If the indicator does not flash, press and hold the function button for 20 seconds until the indicator begins to flash.



# Garage Door Opener

3. Hold your handheld garage door transmitter 1–3 in (2–8 cm) away from the HomeLink button you want to program.
4. Press and hold the handheld transmitter button you want to program while watching the indicator on HomeLink. Continue to hold the handheld button until the HomeLink indicator flashes rapidly or is continuously on.

**Note:** You may need to use a different method if you live in Canada or have difficulties programming your gate operator or garage door opener.

5. Press and hold the HomeLink button you programmed for two seconds, then release. You may need to do this twice to activate the door.

**Note:** If the indicator stays on, the programming is complete.

**Note:** If the HomeLink indicator flashes rapidly, repeat Step 5.

**Note:** If your device still does not operate, you must program your garage door.

6. To program additional buttons, repeat Steps 1–4.

**Note:** Make sure you keep the original remote control transmitter for use in other vehicles as well as for future system programming.

## Programming the Garage Door Opener to your Garage Door Opener Motor

**Note:** Make sure that the garage door and security device are free from obstruction when you are programming. Do not program the system with the vehicle in the garage.



1. Press the learn button on the garage door opener motor and then you have 30 seconds to complete the next two steps.
2. Return to your vehicle.

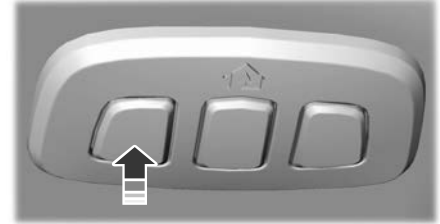

3. Press and hold one of the three HomeLink function buttons you want to program for two seconds, then release.
4. Repeat Step 3. Depending on your brand of garage door opener, you may need to repeat this sequence a third time.

# Garage Door Opener

---

## Programming the Garage Door Opener to your Gate Opener Motor

### Gate Operator / Canadian Programming

Canadian radio-frequency laws require transmitter signals to time-out (or quit) after several seconds of transmission – which may not be long enough for HomeLink to pick up the signal during programming. Similar to this Canadian law, some U.S. gate operators are designed to time-out in the same manner.

**Note:** *If programming a garage door opener or gate operator, it is advised that you unplug the device during the **cycling** process to prevent possible overheating.*

1. Press and release your handheld transmitter, **every two seconds**, until the HomeLink indicator flashes rapidly or is continuously on.
2. Release the handheld transmitter button.
3. Press and hold the HomeLink function button you want to program for two seconds, then release. You may need to do this twice to activate the door.

**Note:** *If the indicator stays on, the programming is complete.*

**Note:** *If the HomeLink indicator flashes rapidly, repeat Step 3.*

4. To program additional buttons, repeat Steps 1–4.

# USB Ports

## LOCATING THE USB PORTS

### Data Transfer USB Ports



The USB ports could be in the following locations:

- On the lower instrument panel.
- Inside the center console.

**Note:** *These USB ports can also charge devices.*

**Note:** *Not all USB ports in your vehicle have data transfer capabilities.*

**Note:** *We recommend using only USB-IF certified cables and adapters. Non-certified cables and adapters may not work.*

### Charge Only USB Ports



The USB ports could be in the following locations:

- On the lower instrument panel.
- On the upper instrument panel.
- Inside the media bin.
- Inside the center console.
- On the rear of the center console.
- Behind the first row seats.
- In the cargo area.

## PLAYING MEDIA USING THE USB PORT



**WARNING:** Driving while distracted can result in loss of vehicle control, crash and injury. We strongly recommend that you use extreme caution when using any device that may take your focus off the road. Your primary responsibility is the safe operation of your vehicle. We recommend

against the use of any hand-held device while driving and encourage the use of voice-operated systems when possible. Make sure you are aware of all applicable local laws that may affect the use of electronic devices while driving.

Connect your device to a data transfer USB port.



Press the audio button on the feature bar.

Select **Sources**.



Select the USB option.



Press to play a track. Press again to pause the track.



Press to skip to the next track.



Press and hold to fast forward through the track.



Press once to return to the beginning of a track. Repeatedly press to return to previous tracks.

# USB Ports

---

Press and hold to fast rewind.

## CHARGING A DEVICE

Connect your device to the USB port.

### Data Transfer USB Ports



You can charge your device through the data transfer USB port when the touchscreen is on.

### Charge Only USB Ports



You can charge your device through the charge only USB port when the vehicle is in accessory mode or when the vehicle is running.

# Power Outlet - Vehicles With: 110V Power Outlet

## WHAT IS THE POWER OUTLET

The power outlet is a socket that connects an electrical device to your vehicle's power supply.

## POWER OUTLET PRECAUTIONS



**WARNING:** Do not keep electrical devices plugged in the power point whenever the device is not in use. Do not use any extension cord with the 110 volt AC power point, since it will defeat the safety protection design. Doing so may cause the power point to overload due to powering multiple devices that can reach beyond the 150 watt load limit and could result in fire or serious injury.

**Note:** *The power point turns off when you switch off the ignition, when the vehicle is not in accessory mode, or when the battery voltage drops below 11 volts.*

## LOCATING THE POWER OUTLETS

The power outlet is on the rear of the center console.



## POWER OUTLET INDICATORS

The power outlet indicator illuminates to let you know the status of the system.

Indicator Status	Description
On	When the indicator light is on, the outlet is providing power.
Off	When the indicator light is off, there is no power to the outlet.
Flashing	When the indicator light is flashing, the outlet is in a fault mode.

## Fault mode

The power outlet temporarily turns off power if the device exceeds the watt limit.

1. Unplug your device.
2. Switch your vehicle off to let the system cool and reset the fault mode.
3. Switch your vehicle back on, but do not plug your device back in.

## Power Outlet - Vehicles With: 110V Power Outlet

---

4. With your vehicle on, make sure the indicator light remains on.
5. Make sure your device does not exceed the power limits and then plug in your device.

**Note:** *If a fault occurs again, your device may exceed the capacity available from the power outlet.*

# Power Outlet - Vehicles With: 12V Power Outlet

---

## WHAT IS THE POWER OUTLET

The power outlet can power devices using a 12 V outlet adapter.

## POWER OUTLET PRECAUTIONS



**WARNING:** Do not plug optional electrical accessories into the cigar lighter socket. Incorrect use of the cigar lighter can cause damage not covered by the vehicle warranty, and can result in fire or serious injury.

When you switch the vehicle on, you can use the socket to power 12 V appliances with a maximum current rating of 15 A. Do not use the power point over the vehicle capacity of 12 V DC 180 W or a fuse could blow. Do not plug in any device that supplies power to the vehicle through the power points. This could result in damage to vehicle systems. Do not hang any accessory from the accessory plug. Always keep the power point caps closed when not in use. Do not insert objects other than an accessory plug into the power point.

To prevent the battery from running out of charge:

- Do not use the power point longer than necessary when the vehicle is off.
- Do not leave devices plugged in overnight or when you park your vehicle for extended periods.

## LOCATING THE POWER OUTLETS

The power outlets are inside the center console bin and in the cargo area.

# Wireless Accessory Charger

## WHAT IS THE WIRELESS ACCESSORY CHARGER

The wireless accessory charger allows you to charge one compatible Qi wireless charging device on the charging area.

## WIRELESS ACCESSORY CHARGER PRECAUTIONS



**WARNING:** Wireless charging devices can affect the operation of implanted medical devices, including cardiac pacemakers. If you have any implanted medical devices, we recommend that you consult with your physician.



**WARNING:** Remove all metal objects like coins and keys from the charging surface and remove any metal objects attached to your mobile phone before placing the device on the charging surface. Some mobile devices or cases may attract metal objects. Metal objects on the

charging surface or attached to the phone may become hot while charging is active. If an object is left on or near the charging surface or attached to the phone while the device is charging, let the objects cool before removing to prevent personal injury.

Keep the charging area clean and remove foreign objects prior to charging a device.

Do not place items with a magnetic strip or radio-frequency identification chip, for example passports, parking tickets, transportation passes or credit cards, near the charging area when charging a device. Damage could occur to the magnetic strip or radio-frequency identification chip.

Do not place metal objects, for example remote controls, coins and candy wrappers, on or near the charging area when charging a device. Metal objects may heat up and degrade the charging performance, in addition to causing interruptions in charging.

Charging could be interrupted, degraded, or could stop if any of the following occur:

- The system detects a foreign object.
- The device is misaligned on the charging area.
- The device moves on the active charging area when the vehicle is in motion.
- The vehicle ambient temperature is too high.
- You attempt to charge a non-Qi compatible device on the wireless charger.

**Note:** *During charging, the device and the charger could heat up, this is normal. If the battery gets hotter than usual, the device may stop charging.*

## LOCATING THE WIRELESS ACCESSORY CHARGER



The charging area is on the center console or in the media bin below the instrument panel.



# Wireless Accessory Charger

---

## CHARGING A WIRELESS DEVICE

Place the device on the center of the charging surface with the charging side down. The charging stops after your device reaches a full charge.

You can use the charger when the vehicle is in accessory mode, when the vehicle is running or when the touchscreen is on.



Displays on the status bar when wireless charging is in progress.

**Note:** *The charging performance may be affected if your device is in a case. It may be necessary to remove the case to wirelessly charge your device.*

**Note:** *Software and firmware updates may affect device compatibility, including the use of unofficial software or firmware. You should verify charging functionality with your specific devices in-vehicle.*

# Storage

## CUP HOLDERS

### CUP HOLDER PRECAUTIONS

 **WARNING:** Use caution when stowing items or hot drinks in the cup holders. Items could become loose or spill during hard braking, acceleration or crashes. Failure to follow this instruction could result in personal injury.

### LOCATING THE CUP HOLDERS

 **WARNING:** Use caution when stowing items or hot drinks in the cup holders. Items could become loose or spill during hard braking, acceleration or crashes. Failure to follow this instruction could result in personal injury.

### Rear Seat Armrest



Fold the armrest down to use the cup holder and armrest storage.

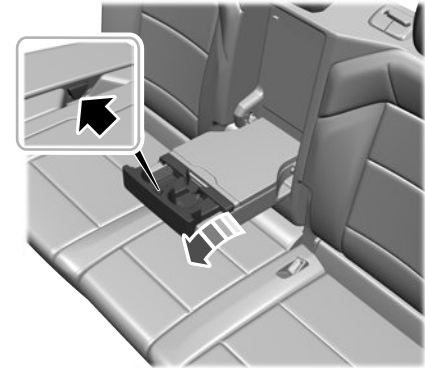

The cup holders are located inside the rear seat armrest. To open the cup holders, press the button on the armrest firmly. The cup holders open.

Push the panel again to close the cup holders.

# Storage

---

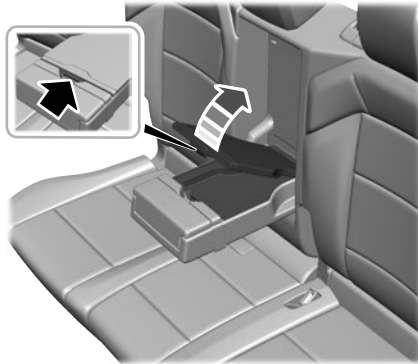

Press the button firmly and pull up to access the armrest storage.

## GLOVE COMPARTMENT

### OPENING THE GLOVE COMPARTMENT



Pull the latch to open the glove compartment.

## CENTER CONSOLE

### OPENING THE CENTER CONSOLE

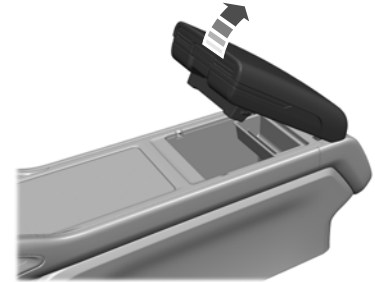

Pull the latch to open the center console.

# Storage

---

## UNDER FLOOR STORAGE

### LOCATING THE REAR UNDER FLOOR STORAGE

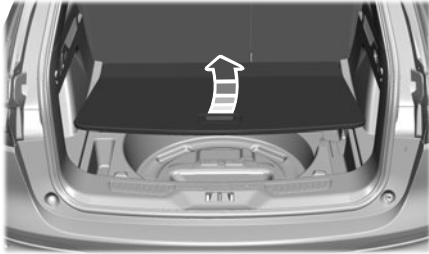

The spare tire or tire mobility kit are located in the floor of the cargo area. Lift the handle to open and access these items.

## GLASSES HOLDER

### LOCATING THE GLASSES HOLDER

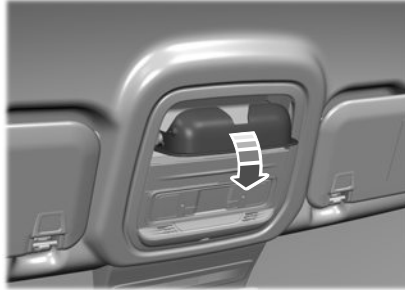



The glasses holder is in the overhead console. Press near the rear edge of the door to open.

# Starting and Stopping the Engine

## STARTING AND STOPPING THE ENGINE – PRECAUTIONS

 **WARNING:** Extended idling at high engine speeds can produce very high temperatures in the engine and exhaust system, creating the risk of fire or other damage.

 **WARNING:** Do not park, idle or drive your vehicle on dry grass or other dry ground cover. The emission system heats up the engine compartment and exhaust system, creating the risk of fire.

 **WARNING:** Do not start the engine in a closed garage or in other enclosed areas. Exhaust fumes are toxic. Always open the garage door before you start the engine. Failure to follow this instruction could result in personal injury or death.

 **WARNING:** Do not use starting fluid, for example ether, in the air intake system. Such fluid could cause immediate explosive damage to the engine and possible personal injury.

 **WARNING:** Exhaust leaks may result in entry of harmful and potentially lethal fumes into the passenger compartment. If you smell exhaust fumes inside your vehicle, have your vehicle inspected immediately. Do not drive if you smell exhaust fumes.

The powertrain control system meets all Canadian interference-causing equipment standard requirements regulating the impulse electrical field or radio noise.

**Note:** *If you use your vehicle regularly above the altitude of 5,000 ft (1,524 m) and under the temperature of -4.0°F (-20°C), it is recommended to use the alternative engine oil. See **Capacities and Specifications** (page 436).*

If you stop your vehicle and leave the engine idling for long periods, we recommend that you do one of the following:

- Open the windows at least 1 in (2.5 cm).
- Set your climate control to outside air.

## PUSH BUTTON IGNITION SWITCH



### Switching the Ignition Off

When the ignition is on or in accessory mode, press the push button ignition switch once without your foot on the brake pedal.

### Switching the Ignition to Accessory Mode

When the ignition is off, press the push button ignition switch once without your foot on the brake pedal.

# Starting and Stopping the Engine

All electrical circuits and accessories are operational and the warning lamps and indicators illuminate.

**Note:** *Your vehicle has a battery saver feature that shuts your vehicle off when it detects a certain amount of battery drain, or after approximately 30 minutes of inactivity in accessory mode.*

**Note:** *The system may not function if the remote control is close to metal objects or electronic devices, for example keys or a cell phone.*

**Note:** *You need a valid key inside your vehicle to switch the ignition on and start the engine.*

## STARTING THE ENGINE

### STARTING A GASOLINE ENGINE

Before starting your vehicle, check the following:

- Make sure that the headlamps and electrical accessories are off.
  - Make sure that the parking brake is on.
  - Make sure that the transmission is in park (P).
1. Fully press the brake pedal.

**Note:** *Do not touch the accelerator pedal.*



2. Press the push button ignition switch.

**Note:** *The engine may continue cranking for up to 15 seconds or until it starts.*

**Note:** *The engine takes longer to start at lower temperatures. It may crank for several seconds when very cold.*

## STARTING A HYBRID ELECTRIC VEHICLE SYSTEM

Before starting your vehicle, check the following:

- Make sure the headlamps and electrical accessories are off.
- Make sure the parking brake is on.
- Make sure the transmission is in park (P).

**Note:** *Do not touch the accelerator pedal.*

1. Fully press the brake pedal.



2. Press the push button ignition switch.

**READY** When you start your vehicle, a green indicator light appears in the instrument cluster letting you know that your vehicle is ready for driving. Since your vehicle is equipped with a silent key start, the engine may not start when your vehicle starts.

# Starting and Stopping the Engine

When the engine starts for the first time on your drive, the idle speed increases, this helps to warm up the engine. If the engine idle speed does not slow down, have your vehicle checked by an authorized dealer.

The system does not function if:

- The passive key frequencies are jammed.
- The key battery has no charge.

## RESTARTING THE ENGINE AFTER STOPPING IT

The system allows you to start the engine within 10 seconds of switching it off, even if it does not detect a valid passive key.

Within 10 seconds of switching the engine off, fully press the brake pedal and press the push button ignition switch. After 10 seconds, you can no longer start the engine if the system does not detect a valid passive key.

When you start the engine, it remains running until you press the push button ignition switch, even if your vehicle does not detect a valid passive key. If you open and close a door when the engine is running, the system searches for a valid passive key.

## ENGINE BLOCK HEATER (IF EQUIPPED)

### ENGINE BLOCK HEATER PRECAUTIONS

 **WARNING:** Failure to follow engine block heater instructions could result in property damage or serious personal injury.

 **WARNING:** Do not use your heater with ungrounded electrical systems or two-pronged adapters. There is a risk of electrical shock.

 **WARNING:** Do not fully close the hood, or allow it to drop under its own weight when using the engine block heater. This could damage the power cable and may cause an electrical short resulting in fire, injury and property damage.

We recommend that you do the following for a safe and correct operation:

- Use a 16-gauge outdoor extension cord that is product certified by Underwriter's Laboratory (UL) or Canadian Standards Association (CSA). This extension cord must be suitable for use outdoors, in cold temperatures, and be clearly marked Suitable for Use with Outdoor Appliances. Do not use an indoor extension cord outdoors. This could result in an electric shock or become a fire hazard.
- Use as short an extension cord as possible.
- Do not use multiple extension cords.
- Make sure that when in operation, the extension cord plug and engine block heater cord plug connections are free and clear of water. This could cause an electric shock or fire.
- If the engine block heater cord is under the hood, do not remove the wiring from its original location. Do not close the hood on the extension wiring.

# Starting and Stopping the Engine

- Park your vehicle in a clean area, clear of combustible materials.
- Firmly connect the engine block heater cord and the extension cord.
- Check the extension cord for heat anywhere when the system has been operating for approximately 30 minutes.
- Unplug and properly stow the system before starting and driving your vehicle. The protective cover seals the terminals of the engine block heater cord plug when not in use.
- Check the engine block heater system for proper operation before winter.

## HOW DOES THE ENGINE BLOCK HEATER WORK

The engine block heater warms the engine coolant. This allows the climate control system to quickly respond. The equipment includes a heater element installed in the engine block and a wire harness. You can connect the system to a grounded 110 volt AC electrical source.

**Note:** *The engine block heater is most effective when outdoor temperatures are below 0°F (-18°C). We recommend the use of engine block heater to improve engine cold start performance.*

## USING THE ENGINE BLOCK HEATER

Make sure the receptacle terminals are clean and dry prior to use. Clean them with a dry cloth if necessary.

The heater uses 0.4 to 1.0 kilowatt-hours of energy per hour of use. The system does not have a thermostat. It achieves maximum temperature after approximately three hours of operation. Using the engine block heater longer than three hours does not improve system performance and unnecessarily uses electricity.

## STOPPING THE ENGINE

### STOPPING THE ENGINE WHEN YOUR VEHICLE IS STATIONARY

1. Shift into park (P).

2. Apply the parking brake.
3. Wait until the engine reaches idle speed.



4. Press the push button ignition switch.

### STOPPING THE ENGINE WHEN YOUR VEHICLE IS MOVING



**WARNING:** Switching off the engine when your vehicle is still moving results in a significant decrease in braking assistance. Higher effort is required to apply the brakes and to stop your vehicle. A significant decrease in steering assistance could also occur. The steering does not lock, but higher effort could be



# Starting and Stopping the Engine

required to steer your vehicle. When you switch the ignition off, some electrical circuits, for example airbags, also turn off. If you unintentionally switch the ignition off, shift into neutral (N) and restart the engine.



1. Press and hold the push button ignition switch until the engine stops, or press it three times within two seconds.
2. Shift into neutral and use the brakes to bring your vehicle to a safe stop.
3. Shift into park (P).
4. Apply the parking brake.

## AUTOMATIC ENGINE STOP

### WHAT IS AUTOMATIC ENGINE STOP

Automatic engine stop is a feature that switches the engine off if it has been idling for an extended period to help you save fuel.

### HOW DOES AUTOMATIC ENGINE STOP WORK

Automatic engine stop turns the engine off. The ignition also turns off in order to save battery power. Before the engine shuts down, a message appears in the information display showing a timer counting down. If you do not intervene within 30 seconds, the engine shuts down. Another message appears in the information display to inform you that the engine has shut down in order to save fuel. Start your vehicle as you normally do.

## SWITCHING AUTOMATIC ENGINE STOP ON AND OFF

1. From the settings menu, press Vehicle. See **Center Display** (page 468).
2. Switch 30min Max Idle on or off.

**Note:** *You cannot permanently switch off the automatic shutdown. If you switch it off, it turns on each time you switch the ignition on.*

## OVERRIDING AUTOMATIC ENGINE STOP

You can stop the engine shutdown, or reset the timer, at any point before the 30-second countdown has expired by doing any of the following:

- Pressing the brake pedal or accelerator pedal.
- Pressing the **OK** or **RESET** button during the countdown.

**Note:** *You cannot permanently switch off the automatic engine shutdown feature. When you switch it off temporarily, it turns on at the next ignition cycle.*

# Starting and Stopping the Engine

## ACCESSING THE PASSIVE KEY BACKUP POSITION

If you are unable to start the engine, do the following:



E391070

1. Open the floor console storage compartment lid.
2. Place the passive key into the backup slot.

3. With the key in this position, press the brake pedal then press the push button ignition switch to switch the ignition on and start your vehicle.

## STARTING AND STOPPING THE ENGINE – TROUBLESHOOTING

### STARTING AND STOPPING THE ENGINE – WARNING LAMPS

#### Malfunction Indicator Lamp



If it illuminates when the engine is running, the on-board diagnostics system is detecting a malfunction of the vehicle emission control system.

If it flashes, engine misfire could be occurring. Increased exhaust gas temperatures could damage the catalytic converter or other vehicle components. Avoid heavy acceleration and deceleration, and have your vehicle checked as soon as possible.

#### Powertrain Warning Lamp



If it illuminates when the engine is running, this indicates a powertrain or four-wheel drive fault. If it flashes when you are driving, immediately reduce the vehicle speed. Avoid heavy acceleration and deceleration, and have your vehicle checked as soon as possible.

If both lamps illuminate when the engine is running, stop your vehicle as soon as it is safe to do so. Continuing to drive your vehicle could cause reduced power or the engine to stop. Switch the ignition off and attempt to restart the engine. Have your vehicle checked as soon as possible.

# Starting and Stopping the Engine

---

## STARTING AND STOPPING THE ENGINE – INFORMATION MESSAGES

Message	Action
Cranking Time Exceeded	Displays if you exceed the starting time limit. You cannot attempt to start the engine for 15 minutes. If you cannot start the engine after 15 minutes passes, have your vehicle immediately checked.
Starting System Fault	Displays if you are unable to start your vehicle with a correctly coded key. The system has detected a fault that requires service. Have your vehicle checked as soon as possible.
No Key Detected	Displays if the system does not detect a valid passive key.

# Starting and Stopping the Engine

## STARTING AND STOPPING THE ENGINE – FREQUENTLY ASKED QUESTIONS

### Why is the engine speed high when I am starting the engine?

- The speed at which the engine idles immediately after starting is optimized to minimize vehicle emissions and maximize cabin comfort and fuel economy.

### Why does the engine not crank?

- You can only attempt to start the engine for a limited amount of time before the starting system temporarily disables. If you exceed the starting time limit, a message may appear and you cannot attempt to start the engine for at least 15 minutes.

### Why do I experience different driving characteristics?

- If you disconnect the battery, your vehicle may exhibit some unusual driving characteristics for approximately 5.0 mi (8 km) after you reconnect it. This is because the engine management system must realign itself with the engine. You can disregard any unusual driving characteristics during this period.

### Why can I not start the engine?

If you cannot start the engine after 3 attempts, wait 10 seconds and do the following:

1. Fully press the brake pedal.

**Note:** Make sure that the parking brake is applied.

**Note:** Make sure that the transmission is in park (P) or neutral (N).

2. Fully press the accelerator pedal and hold it there.
3. Press the push button ignition switch.

**Note:** The engine cranks for a short period of time and then it stops.

4. Release the accelerator pedal.



5. Press the push button ignition switch.

### Why does the system not detect a passive key?

- If the system does not detect a passive key and you are unable to start the engine, insert the passive key into the backup position and press the push button ignition switch to start the engine. See **Accessing the Passive Key Backup Position** (page 190).

# Hybrid Electric Vehicle Information - Hybrid Electric Vehicle (HEV)

## HYBRID ELECTRIC VEHICLE INFORMATION

A hybrid vehicle has an electric motor and a high voltage battery combined with a gasoline engine. The hybrid vehicle combines electric and gasoline propulsion to provide optimal performance and improved efficiency.

### Hybrid Electric Vehicle Driving Characteristics

The gasoline engine starts and stops to provide power when required and to save fuel when not needed. When coasting at low speeds, coming to a stop or standing, the gas engine normally shuts down and your vehicle operates in electric-only mode.

Conditions that may cause the gasoline engine to start or remain running include:

- Considerable vehicle acceleration.
- Driving uphill.

- The high voltage battery charge level is low.
- Heating or cooling the vehicle interior in high or low outside temperatures.
- The gasoline engine is below normal operating temperature.
- Towing a trailer.
- Certain selectable drive modes could cause the engine to run. See **Selecting a Drive Mode** (page 293).

Your hybrid vehicle also comes with standard hydraulic braking and regenerative braking. Regenerative braking is performed by your transmission and captures brake energy and stores it in the high voltage battery.

You could also notice that your engine continues to run instead of shutting off during extended downhill driving. The engine stays on during this engine braking but is not using any fuel.

You could also hear a slight whine or whistle when operating your vehicle. This is the normal operation of the electric motor in the hybrid system.

**Note:** *Having your engine running is not always an indication of inefficiency. In some cases, it is actually more efficient than driving in electric mode.*

### Hybrid Electric Vehicle Indicators

**READY** When you start your vehicle, a green READY indicator light appears in the instrument cluster letting you know that your vehicle is ready for driving.

The engine may not start because your vehicle has a silent key start feature. This fuel saving feature allows your vehicle to be ready to drive without requiring the gas engine to be running.

The indicator remains on when your vehicle is on, whether the engine is running or not, to indicate your vehicle is capable of movement using the electric motor, gas engine or both.

Typically, the engine does not start unless the vehicle is cold, a climate control change is requested or you press the accelerator pedal.

# Hybrid Electric Vehicle Information - Hybrid Electric Vehicle (HEV)

## Hybrid Electric Vehicle Information – Warning Lamps



Illuminates if your vehicle has an electrical component fault or failure that causes your vehicle to shut down or enter a limited operating mode. A message may appear in the instrument cluster display.

## Hybrid Electric Vehicle Information – Information Messages

Message	Details
Stop Safely Now	Displays when a malfunction occurs in the high voltage electric system. Stop your vehicle as soon as it is safe to do so. Have your vehicle checked as soon as possible.

## Hybrid Electric Vehicle Information – Frequently Asked Questions

### What should I do if the vehicle runs out of fuel and the high voltage battery is out of charge?

- Refuel and start your vehicle normally. The engine will recharge the high voltage battery.

## Why does the engine sometimes start at key-on?

- The vehicle's computer determines if an engine start is required at key-on. It starts the engine when necessary for cabin heating, windshield defrost, if the high voltage battery is low, or if the outside temperature is low.

## Can I put E15 or E85 in my vehicle, and how will it affect my fuel economy?

- Your hybrid vehicle can use E15 (15% ethanol, 85% gasoline) fuel, but you may notice slightly reduced fuel economy because ethanol contains less energy per gallon than gasoline. Your hybrid vehicle is not designed to use E85 (85% ethanol).

# Hybrid Electric Vehicle Information - Hybrid Electric Vehicle (HEV)

## Why does it take a long time before the engine shuts down?

- There are several reasons the engine stays on for an extended amount of time when you first start it. One common reason is to make sure that the emissions components are warm enough to minimize tailpipe emission. As the climate gets cooler, the engine-on time is extended.

## Why does my engine stay on when it is extremely cold outside?

- In order to make sure that the climate control system can begin heating the cabin or defrosting the windshield as soon as a driver requests it, the engine coolant temperature has to be kept sufficiently hot. Keeping the engine on is required to maintain the correct coolant temperature.

## POWER FLOW

The power flow shows how power is being used in the vehicle and also displays reasons for engine operation.



The power flow information for your hybrid vehicle is available through the home screen or under

Apps.

## Vehicle Operational States

Power flows to or from the front and rear wheels depending on operational state and driving conditions.

- Idling: The vehicle is running and in park (P). The engine and/or the high voltage battery are on.
- Electric driving: The vehicle is running and in drive (D) or neutral (N). The high voltage battery provides power to the wheels.

- Hybrid driving: The vehicle is running and in drive (D) or neutral (N). The engine and the high voltage battery provide power to the wheels.
- Regenerative braking: The vehicle is running in drive (D) and is slowing down. Power captured by the regenerative braking system is sent back to the high voltage battery.

## Engine On Due To

The following conditions help explain why the engine is on, and what you can do to allow all electric operation.

- Drive power: The engine is on due to accelerator pedal pressure or speed control activation. Reduce pressure on the accelerator pedal or switch off the speed control to return to full electric mode.
- High speed: The engine is on because the vehicle speed exceeds the level for full electric operation. Reduce the speed to return to electric operation.

# Hybrid Electric Vehicle Information - Hybrid Electric Vehicle (HEV)

---

- **Heater setting:** The engine is on because of the heater setting. Reduce or turn off the heater setting to return to electric operation.
- **Neutral gear:** The engine is on because the vehicle is in neutral (N). Shift out of neutral (N) to return to electric operation.
- **Engine cold:** The engine is on because it is cold. The vehicle returns to electric operation once the engine is sufficiently warm.
- **Battery charging:** The engine is on to charge the high voltage battery. The vehicle returns to electric operation once the battery is charged.
- **Low gear:** The engine is on because the vehicle is in low (L). Shift out of low (L) to return to electric operation.
- **Normal operation:** The engine is on to optimize vehicle operation. The vehicle returns to electric operation when possible.
- **Engine braking active:** The engine is on to provide increased powertrain braking. This can occur when you turn on the grade assist feature, when speed control is on or when driving with your foot off the accelerator pedal. Turning off grade assist or speed control may allow the vehicle to return to electric operation.
- **Battery temperature:** The engine is on due to high or low high voltage battery temperature. This is a normal operating condition. The vehicle returns to electric operation when possible.
- **Drive mode:** The engine is on due to the drive mode selection. Select an appropriate drive mode for electric only operation.



# Auto-Start-Stop

## WHAT IS AUTO-START-STOP

The system is designed to help reduce fuel consumption and CO<sub>2</sub> emissions by stopping the engine when it is idling, for example at traffic lights.

## AUTO-START-STOP PRECAUTIONS



**WARNING:** Apply the parking brake, shift into park (P), switch the ignition off and remove the key before you leave your vehicle. Failure to follow this instruction could result in personal injury or death.



**WARNING:** Apply the parking brake, shift into park (P), switch the ignition off and remove the key before you open the hood or have any service or repair work completed. If you do not switch the ignition off, the engine could restart at any time. Failure to follow this instruction could result in personal injury or death.

## SWITCHING AUTO-START-STOP ON AND OFF

The system turns on when you switch the ignition on.



Press the button to switch the system off.

**Note:** *Deactivating the system using the button lasts only one key cycle.*

Press the button again to switch the system back on.

**Note:** *The system turns off if it detects a malfunction. If the system malfunctions, have your vehicle checked as soon as possible.*

## STOPPING THE ENGINE

Stop your vehicle, keep your foot on the brake pedal and the transmission in drive (D).

## RESTARTING THE ENGINE

Release the brake pedal or press the accelerator pedal.

A message appears in the instrument cluster display if the system requires you to take action.

## AUTO-START-STOP INDICATORS



**WARNING:** The system may require the engine to automatically restart when the auto-start-stop indicator illuminates green or flashes amber. Failure to follow this instruction could result in personal injury.



The Auto-Start-Stop indicator illuminates green when the engine stops. It flashes amber and a message appears when you need to take action.

# Auto-Start-Stop



The Auto-Start-Stop indicator illuminates gray with a strikethrough when the system is not available.

**Note:** *You can display the reason why the system is not available in the information display.*

## **AUTO-START-STOP – TROUBLESHOOTING**

### **AUTO-START-STOP – INFORMATION MESSAGES**

A message appears in the instrument cluster display if the system requires you to take action.

<b>Message</b>	<b>Condition</b>	<b>Action</b>
Auto StartStop Press Brake to Start Engine	The system needs to restart the engine but requires your confirmation.	Press the brake pedal to restart the engine.
Auto StartStop Press a Pedal to Start Engine	The system needs to restart the engine but requires your confirmation.	Press the brake pedal or the accelerator pedal to restart the engine.

# Auto-Start-Stop

---

## **AUTO-START-STOP – FREQUENTLY ASKED QUESTIONS**

### **Why does the engine not always stop when I expect it to?**

The system is designed to work in a way that complements other vehicle systems, allowing them to operate at optimum performance.

The system does not stop the engine if:

- The driver door is open.
- Your vehicle is at high altitude.
- The heated windshield is on.
- The engine is warming up.
- The outside temperature is too low or too high.
- The battery charge is low.
- The battery temperature is outside the optimal operating range.
- The engine is required to run to maintain interior climate and reduce fogging.

### **Why does the engine sometimes restart when I do not expect it to?**

The system is designed to work in a way that complements other vehicle systems, allowing them to operate at optimum performance.

The system restarts the engine if:

- You switch the heated windshield on.
- You switch maximum defrost on.
- Your vehicle starts to roll downhill in neutral.
- The engine is required to run to maintain adequate brake system assistance.
- The engine is required to run to maintain interior climate and reduce fogging.

### **Can I permanently switch the system off?**





No. The system plays an important role in reducing the fuel consumption and the CO<sub>2</sub> emissions.

### **Will the frequent engine starts cause parts to wear out?**

Your vehicle has an enhanced battery and starter motor that are designed for the increased number of engine starts.

# Fuel and Refueling

## FUEL AND REFUELING PRECAUTIONS

-  **WARNING:** Fuels can cause serious injury or death if misused or mishandled.
-  **WARNING:** Fuel may contain benzene, which is a cancer-causing agent.
-  **WARNING:** Read and follow all the instructions on the pump island.
-  **WARNING:** When refueling always shut the engine off and never allow sparks or open flames near the fuel tank filler valve. Never smoke or use a cell phone while refueling. Fuel vapor is extremely hazardous under certain conditions. Avoid inhaling excess fumes.

Follow these guidelines when refueling:

- Extinguish all smoking materials and any open flames before refueling your vehicle.
- Switch the engine off before refueling.

- Automotive fuels can be harmful or fatal if swallowed. Fuel is highly toxic and if swallowed can cause death or permanent injury. If fuel is swallowed immediately call a physician, even if no symptoms are immediately apparent. The toxic effects of fuel may not be apparent for hours.
- Avoid inhaling fuel vapors. Inhaling fuel vapor can lead to eye and respiratory tract irritation. In severe cases, excessive or prolonged breathing of fuel vapor can cause serious illness and permanent injury.
- Avoid getting fuel in your eyes. If you splash fuel in your eyes, immediately remove contact lenses, if worn, flush with water for 15 minutes and seek medical attention. Failure to seek proper medical attention could lead to permanent injury.
- Fuels can be harmful if absorbed through the skin. If you splash fuel on your skin, clothing or both, promptly remove contaminated clothing and thoroughly wash your skin with soap and water. Repeated or prolonged skin contact causes skin irritation.
- Be particularly careful if you are taking Antabuse or other forms of Disulfiram for the treatment of alcoholism. Breathing fuel vapors could cause an adverse reaction, serious personal injury or sickness. Immediately call a physician if you experience any adverse reactions.

# Fuel and Refueling

## FUEL QUALITY

### SELECTING THE CORRECT FUEL

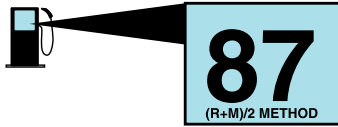

Your vehicle operates on regular unleaded gasoline with a minimum pump (R+M)/2 octane rating of 87.

Some fuel stations, particularly those in high altitude areas, offer fuels posted as regular unleaded gasoline with an octane rating below 87. The use of these fuels could result in engine damage that will not be covered by the vehicle Warranty.

For best overall vehicle and engine performance, premium fuel with an octane rating of 91 or higher is recommended. The performance gained by using premium fuel is most noticeable in hot weather as well as other conditions, for example when towing a trailer. See **Towing a Trailer** (page 338).

Do not be concerned if the engine sometimes knocks lightly. However, if the engine knocks heavily while using fuel with the recommended octane rating, contact an authorized dealer to prevent any engine damage.

We recommend Top Tier detergent gasolines, where available to help minimize engine deposits and maintain optimal vehicle and engine performance.

For additional information, visit [www.toptiergas.com](http://www.toptiergas.com).

**Note:** *Use of any fuel for which the vehicle was not designed can impair the emission control system, cause loss of vehicle performance, and cause damage to the engine which may not be covered by the vehicle Warranty.*

Do not use:

- Diesel fuel.
- Fuels containing kerosene or paraffin.
- Fuel containing more than 15% ethanol or E85 fuel.
- Fuels containing methanol.
- Fuels containing metallic-based additives, including manganese-based compounds.
- Fuels containing the octane booster additive, methylcyclopentadienyl manganese tricarbonyl (MMT).
- Leaded fuel, using leaded fuel is prohibited by law.

The use of fuels with metallic compounds such as methylcyclopentadienyl manganese tricarbonyl, which is a manganese-based fuel additive, will impair engine performance and affect the emission control system.

## LOCATING THE FUEL FILLER FUNNEL

The fuel filler funnel is under the luggage compartment floor covering.

# Fuel and Refueling

## RUNNING OUT OF FUEL

### FILLING A PORTABLE FUEL CONTAINER

 **WARNING:** Flow of fuel through a fuel pump nozzle can produce static electricity. This can cause a fire if you are filling an ungrounded fuel container.

Use the following guidelines to avoid electrostatic charge build-up, which can produce a spark, when filling an ungrounded fuel container:

- Only use an approved fuel container to transfer fuel to your vehicle. Place the container on the ground when filling it.
- Do not fill a fuel container when it is inside your vehicle (including the cargo area).
- Keep the fuel pump nozzle in contact with the fuel container when filling it.
- Do not use a device that holds the fuel pump nozzle lever in the fill position.

### ADDING FUEL FROM A PORTABLE FUEL CONTAINER

 **WARNING:** Do not insert the nozzle of a fuel container or an aftermarket funnel into the fuel filler neck. This may damage the fuel system filler neck or its seal and cause fuel to run onto the ground.

 **WARNING:** Do not pry open the fuel tank filler valve. This could damage the fuel system. Failure to follow this instruction could result in fire, personal injury or death.

 **WARNING:** Do not dispose of fuel in the household refuse or the public sewage system. Use an authorized waste disposal facility.

When refueling the vehicle fuel tank from a fuel container, use the fuel filler funnel included with your vehicle. See **Locating the Fuel Filler Funnel** (page 201).

**Note:** Do not use aftermarket funnels as they may not work with the capless fuel system and can damage it.

When refueling the vehicle fuel tank from a fuel container, do the following:

1. Fully open the fuel filler door.



2. Fully insert the fuel filler funnel into the fuel filler inlet.
3. Add fuel to your vehicle from the fuel container.
4. Remove the fuel filler funnel.
5. Fully close the fuel filler door.

# Fuel and Refueling

- Clean the fuel filler funnel and place it back in your vehicle or correctly dispose of it.

**Note:** If your vehicle runs out of fuel add a minimum of 1.3 gal (5 L) of fuel to restart the engine.

**Note:** You may need to switch the ignition from off to on several times after refueling to allow the fuel system to pump the fuel from the tank to the engine. When restarting, cranking time takes a few seconds longer than normal.

**Note:** Extra funnels can be purchased from an authorized dealer if you choose to dispose of the funnel.

## REFUELING

### REFUELING SYSTEM OVERVIEW

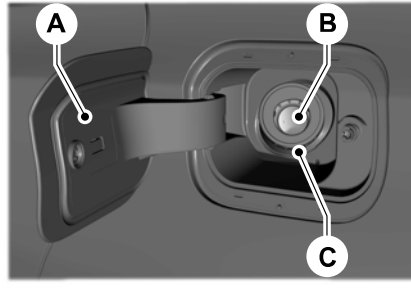

- A Fuel filler door.
- B Fuel tank filler valve.
- C Fuel tank filler pipe.

## REFUELING YOUR VEHICLE - HYBRID ELECTRIC VEHICLE (HEV)



**WARNING:** When refueling always shut the engine off and never allow sparks or open flames near the fuel tank filler valve. Never smoke or use a cell phone while refueling. Fuel vapor is extremely hazardous under certain conditions. Avoid inhaling excess fumes.



**WARNING:** The fuel system may be under pressure. If you hear a hissing sound near the fuel filler inlet, do not refuel until the sound stops. Otherwise, fuel may spray out, which could cause serious personal injury.





**WARNING:** Fuel vapor burns violently and a fuel fire can cause severe injuries.





**WARNING:** Keep children away from the fuel pump. Never let children pump fuel.

# Fuel and Refueling

 **WARNING:** Stay outside your vehicle and do not leave the fuel pump unattended when refueling your vehicle.

 **WARNING:** Do not pry open the fuel tank filler valve. This could damage the fuel system. Failure to follow this instruction could result in fire, personal injury or death.

 **WARNING:** Do not remove the fuel pump nozzle from its fully inserted position when refueling.

 **WARNING:** Stop refueling when the fuel pump nozzle automatically shuts off for the first time. Failure to follow this will fill the expansion space in the fuel tank and could lead to fuel overflowing.

 **WARNING:** Do not overfill the fuel tank. The pressure in an overfilled tank may cause leakage and lead to fuel spray and fire.

 **WARNING:** Wait at least five seconds before removing the fuel pump nozzle to allow any residual fuel to drain into the fuel tank.

1. When you stop your vehicle, shift into park (P) and switch the ignition off.



2. Press the button on the instrument panel next to the headlamp switch to open the fuel filler door. The fuel filler door can take up to 15 seconds to open before you can insert a fuel filler nozzle.

**Note:** Avoid pressing the button and blocking the fuel filler door at the same time. If an issue occurs, press the fuel filler door open button again to reset the fuel filler door lock mechanism.

3. Select the correct fuel pump nozzle for your vehicle.

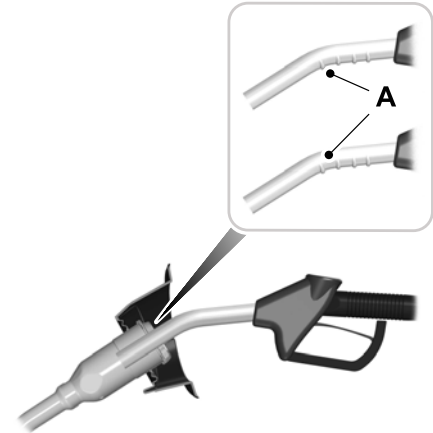



# Fuel and Refueling

- Insert the fuel pump nozzle up to the first notch. Keep the fuel pump nozzle resting on the fuel tank filler pipe.

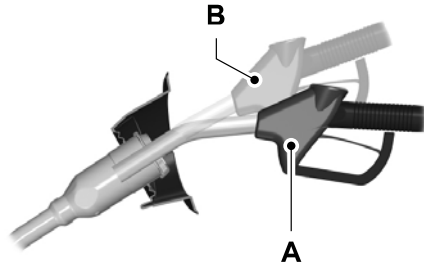

- Hold the fuel pump nozzle in position A when refueling. Holding the fuel pump nozzle in position B can affect the flow of fuel and shut off the fuel pump nozzle before the fuel tank is full.

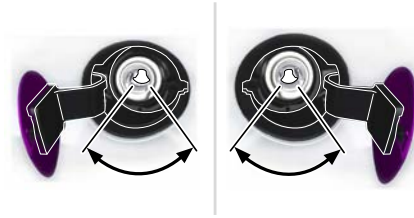

- Operate the fuel pump nozzle within the area shown.

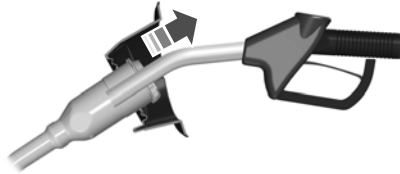

- When the pump shuts off, wait 5 seconds, then raise the fuel pump nozzle and slowly remove it.
- Close the fuel filler door.

**Note:** To close the fuel filler door, press and release the center rear edge of the fuel filler door.

Complete the refueling process within 20 minutes. If 20 minutes elapses, press the button on the instrument panel again. Fuel pump nozzle automatic shut off could occur if you do not press the button on instrument panel.

**Note:** Do not attempt to start the engine if you have filled the fuel tank with incorrect fuel. Incorrect fuel use could cause damage not covered by the vehicle warranty. Have your vehicle immediately checked.

## REFUELING YOUR VEHICLE - EXCLUDING: HYBRID ELECTRIC VEHICLE (HEV)





**WARNING:** When refueling always shut the engine off and never allow sparks or open flames near the fuel tank filler valve. Never smoke or use a cell phone while refueling. Fuel vapor is extremely hazardous under certain conditions. Avoid inhaling excess fumes.

## Fuel and Refueling

 **WARNING:** Fuel vapor burns violently and a fuel fire can cause severe injuries.

 **WARNING:** The fuel system may be under pressure. If you hear a hissing sound near the fuel filler inlet, do not refuel until the sound stops. Otherwise, fuel may spray out, which could cause serious personal injury.

 **WARNING:** Keep children away from the fuel pump. Never let children pump fuel.

 **WARNING:** Do not pry open the fuel tank filler valve. This could damage the fuel system. Failure to follow this instruction could result in fire, personal injury or death.

 **WARNING:** Stay outside your vehicle and do not leave the fuel pump unattended when refueling your vehicle.

 **WARNING:** Do not remove the fuel pump nozzle from its fully inserted position when refueling.

 **WARNING:** Stop refueling when the fuel pump nozzle automatically shuts off for the first time. Failure to follow this will fill the expansion space in the fuel tank and could lead to fuel overflowing.

 **WARNING:** Do not overfill the fuel tank. The pressure in an overfilled tank may cause leakage and lead to fuel spray and fire.

 **WARNING:** Wait at least five seconds before removing the fuel pump nozzle to allow any residual fuel to drain into the fuel tank.

1. Fully open the fuel filler door.
2. Select the correct fuel pump nozzle for your vehicle.

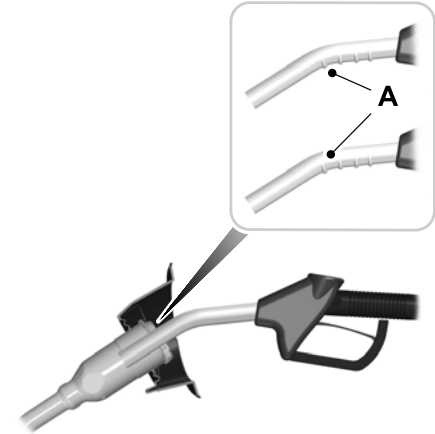

3. Insert the fuel pump nozzle up to the first notch. Keep the fuel pump nozzle resting on the fuel tank filler pipe.

# Fuel and Refueling

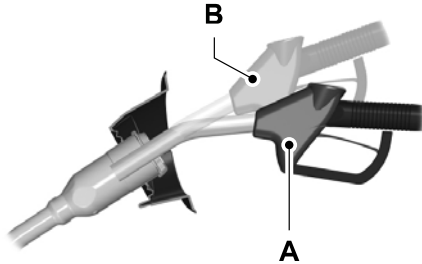

4. Hold the fuel pump nozzle in position A when refueling. Holding the fuel pump nozzle in position B can affect the flow of fuel and shut off the fuel pump nozzle before the fuel tank is full.

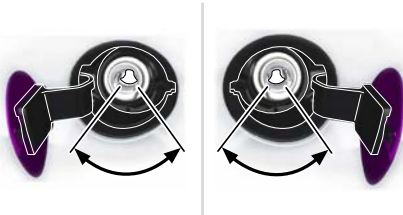

5. Operate the fuel pump nozzle within the area shown.

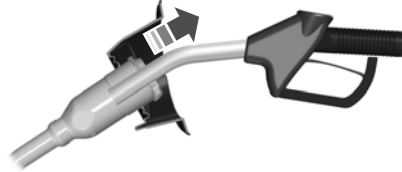

6. When the pump shuts off, wait five seconds, then raise the fuel pump nozzle and slowly remove it.
7. Fully close the fuel filler door.

**Note:** Do not attempt to start the engine if you have filled the fuel tank with incorrect fuel. Incorrect fuel use could cause damage not covered by the vehicle Warranty. Have your vehicle immediately checked.

## MANUALLY OPENING THE FUEL FILLER DOOR - HYBRID ELECTRIC VEHICLE (HEV)



**WARNING:** The fuel system may be under pressure. If you hear a hissing sound near the fuel filler inlet, do not refuel until the sound stops. Otherwise, fuel may spray out, which could cause serious personal injury.

**Note:** The transmission must be in park (P) or neutral (N).

When using the manual override cable do the following:

1. Switch the ignition on.

# Fuel and Refueling

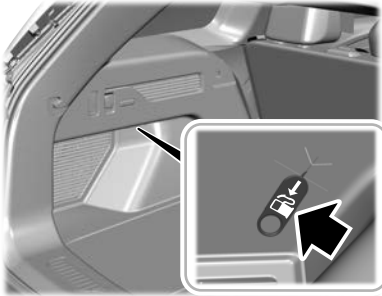

**Note:** The manual override cable is in the trunk side trim area.

2. Pull the manual override cable.
3. Switch the ignition off.

4. Complete the refueling process within 20 minutes.

**Note:** Only follow this procedure if the fuel filler door fails to open. If the problem remains, have your vehicle checked as soon as possible.

## FUEL TANK CAPACITY

### Advertised Capacity

The advertised capacity is the maximum amount of fuel that you can add to the fuel tank when the fuel gauge indicates empty.

In addition, the fuel tank contains an empty reserve. The empty reserve is an unspecified amount of fuel that remains in the fuel tank when the fuel gauge indicates empty.

**Note:** The amount of fuel in the empty reserve varies and should not be relied upon to increase driving range.

## FUEL AND REFUELING – TROUBLESHOOTING

## FUEL AND REFUELING – WARNING LAMPS



If it illuminates when you are driving, refuel as soon as possible.

# Fuel and Refueling

## FUEL AND REFUELING – INFORMATION MESSAGES - HYBRID ELECTRIC VEHICLE (HEV)

Message	Action
Fuel Level Low	An early reminder of a low fuel condition.
Check Fuel Fill Inlet	The fuel fill inlet may not be properly closed.
Please wait for fuel door to open	Appears while the fuel system is depressurizing with the fuel filler door closed. Wait for the fuel system to depressurize and for the fuel filler door to unlatch.
Fuel Door Open	Appears when the fuel system has depressurized and opened the fuel filler door. Open the fuel filler door to refuel and close the fuel filler door when refueling is complete.
Fuel door ajar Close fully to avoid Check engine light	Your vehicle is equipped with a sealed fuel system that requires the fuel filler door to be closed after refueling. This warning message appears when the fuel filler door is ajar. Close the fuel filler door to avoid the Check Engine light. If you see this message and the Check Engine light illuminates, close the fuel filler door. The Check Engine light should clear within five seconds. If the Check Engine light persists, see your dealer.
Refuel Error See Manual	Appears when the fuel system fails to depressurize, or the fuel filler door fails to open. You have to use the fuel filler door manual override lever when opening the fuel door.

# Fuel and Refueling

---

## FUEL AND REFUELING – INFORMATION MESSAGES - EXCLUDING: HYBRID ELECTRIC VEHICLE (HEV)

Message	Action
Fuel Level Low	An early reminder of a low fuel condition. Refill your vehicle.
Check Fuel Fill Inlet	Check to make sure the fuel fill inlet is fully closed.

# Catalytic Converter

## WHAT IS THE CATALYTIC CONVERTER

The catalytic converter is part of your vehicle's emissions system and filters harmful pollutants from the exhaust gas.

## CATALYTIC CONVERTER PRECAUTIONS



**WARNING:** Do not park, idle or drive your vehicle on dry grass or other dry ground cover. The emission system heats up the engine compartment and exhaust system, creating the risk of fire.



**WARNING:** The normal operating temperature of the exhaust system is very high. Never work around or attempt to repair any part of the exhaust system until it has cooled. Use special care when working around the catalytic converter. The catalytic converter heats up to a very high temperature after only a short period of engine operation and stays hot after the engine is switched off.



**WARNING:** Exhaust leaks may result in entry of harmful and potentially lethal fumes into the passenger compartment. If you smell exhaust fumes inside your vehicle, have your vehicle inspected immediately. Do not drive if you smell exhaust fumes.

To avoid damaging the catalytic converter:

- Do not crank the engine for more than 10 seconds at a time.
- Do not run the engine with a spark plug lead disconnected.

- Do not push-start or tow-start your vehicle. Use booster cables. See **Jump Starting the Vehicle** (page 352).
- Use the correct fuel. See **Fuel and Refueling** (page 200).
- Do not switch the ignition off when your vehicle is moving.
- Avoid running out of fuel.
- Have the items listed in scheduled maintenance information performed according to the specified schedule.

**Note:** Do not make any unauthorized changes to your vehicle or engine. By law, vehicle owners and anyone who manufactures, repairs, or services a fleet of vehicles are not permitted to intentionally remove an emission control device or prevent it from working.

# Catalytic Converter

---

## CATALYTIC CONVERTER – TROUBLESHOOTING

### CATALYTIC CONVERTER – WARNING LAMPS

Your vehicle has an on-board diagnostics system that monitors the emission control system. If any of the following warning lamps illuminate, this may indicate that the on-board diagnostics system has detected an emission control system malfunction.



Continuing to drive your vehicle may cause reduced power or the engine to stop. Failure to respond to a warning lamp may cause damage that your vehicle Warranty may not cover. Have your vehicle checked as soon as possible.



# High Voltage Battery - Hybrid Electric Vehicle (HEV)

## WHAT IS THE HIGH VOLTAGE BATTERY

The high voltage battery is a highly sophisticated lithium ion battery system, used to store electrified energy to power your vehicle.

## HIGH VOLTAGE BATTERY PRECAUTIONS



**WARNING:** This battery pack should only be serviced by an authorized electric vehicle technician. Improper handling can result in personal injury or death.



**WARNING:** Keep your hands and clothing clear of the cooling fan.



**WARNING:** Apply the parking brake, shift into park (P), switch the ignition off and remove the key before you open the hood or have any service or repair work completed. If you do not switch the ignition off, the engine could restart at any time. Failure to follow this instruction could result in personal injury or death.



**WARNING:** Do not touch the electronic ignition system parts after you have switched the ignition on or when the engine is running. The system operates at high voltage. Failure to adhere to this warning could result in serious personal injury or death.

Your vehicle consists of various high-voltage components and wiring. All of the high-voltage power flows through specific wiring assemblies labeled as such or covered with a solid orange convolute, or orange striped tape, or both. Do not come in contact with these components.

## RECYCLING AND DISPOSING OF THE HIGH VOLTAGE BATTERY

Please recycle in accordance with local regulations.

# Automatic Transmission

## AUTOMATIC TRANSMISSION PRECAUTIONS



**WARNING:** Apply the parking brake, shift into park (P), switch the vehicle off and remove the key or remote control before you leave your vehicle. Failure to follow this instruction could result in personal injury or death.



**WARNING:** When your vehicle is stationary, keep the brake pedal fully pressed when shifting gears. Failure to follow this instruction could result in personal injury, death or property damage.



**WARNING:** Do not apply the brake pedal and accelerator pedal simultaneously. Applying both pedals simultaneously for more than a few seconds limits vehicle performance, which may result in difficulty maintaining speed in traffic and could lead to serious injury.

## AUTOMATIC TRANSMISSION POSITIONS

### PARK (P)



**WARNING:** Shift into park (P) only when your vehicle is stationary.

In park (P) power is not transmitted to the driven wheels.

**Note:** A tone sounds if you attempt to exit your vehicle without the vehicle in park (P).

**Note:** Your vehicle may not shift out of park (P) if the 12V battery has run out of charge.

**Note:** Your vehicle may not shift out of park (P) if a fuse is blown.

**Note:** Your vehicle may not shift out of park (P) unless the key or remote control is inside your vehicle.

**Note:** The electronic parking brake could apply when you power your vehicle on with the selector in park (P).

**Note:** The electronic parking brake could apply if you shift to park (P) without fully pressing the brake pedal.

**Note:** The electronic parking brake could apply if you shift to park (P) on a slope.

**Note:** Do not manually release the parking brake when the selector is in park (P). See **Automatically Releasing the Electric Parking Brake** (page 226).

**Note:** Your vehicle could shift into park (P) if you attempt to exit your vehicle without the transmission in park (P). See **How Does Automatic Return to Park (P) Work** (page 218).

**Note:** A tone could sound when you select park (P).

### REVERSE (R)



**WARNING:** Shift into reverse (R) only when your vehicle is stationary.

In reverse (R) power is transmitted to the driven wheels.

# Automatic Transmission

## NEUTRAL (N)



**WARNING:** In neutral (N) your vehicle is free to roll.

In neutral (N) power is not transmitted to the driven wheels.

## DRIVE (D)

In drive (D) power is transmitted to the driven wheels.

## LOW (L) - HYBRID ELECTRIC VEHICLE (HEV)

In low (L) your vehicle decelerates more noticeably than in drive (D) when the accelerator pedal is released.

**Note:** We recommend using this mode for driving on hilly or mountainous roads or when towing a trailer. See **Towing a Trailer** (page 338).

## LOW (L)

In low (L) your vehicle holds low gears.

**Note:** We recommend using this mode for driving on hilly or mountainous roads or when towing a trailer. See **Towing a Trailer** (page 338).

## SHIFTING YOUR VEHICLE INTO GEAR

The selector is on the center stack.

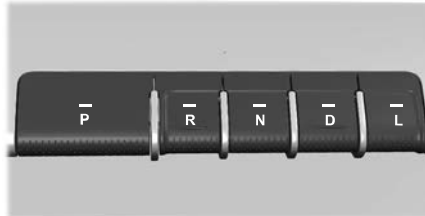

1. Press and hold the brake pedal.
2. Press a button to select a position.

**Note:** The position illuminates on the selector.

## AUTOMATIC TRANSMISSION POSITION INDICATORS

The instrument cluster displays the current position.



**Note:** The position could illuminate on the transmission selector.

# Automatic Transmission

## SHIFTING YOUR IMMOBILE VEHICLE OUT OF PARK (P)



**WARNING:** When doing this procedure, you need to take the transmission out of park (P) which means your vehicle can roll freely. To avoid unwanted vehicle movement, apply the parking brake prior to doing this procedure. Use wheel chocks if appropriate.

Use this procedure to shift your vehicle out of park (P) if you cannot start the engine.

**Note:** *Your vehicle could shift to park (P) after 30 minutes, or when the vehicle battery charge level is low. Prolonged use of this mode can cause the 12 V battery to run out of charge.*

**Note:** *If the battery has run out of charge, use an external power source.*

**Note:** *Do not tow your vehicle in this mode. Failure to follow these instructions could result in vehicle damage not covered by the vehicle warranty.*

## Shifting Your Vehicle Out of Park (P)

1. Apply the parking brake.
2. Power your vehicle on without your foot on the brake pedal.
3. Fully press and hold the brake pedal.
4. Fully press and hold the accelerator pedal.
5. Shift into neutral (N).
6. Shift into neutral (N) again.
7. Attempt to start your vehicle.

**Note:** *A confirmation message appears when your vehicle enters the mode.*

**Note:** *You must complete this procedure within 20 seconds. If your vehicle shifts into park (P) attempt the procedure again.*

8. Release accelerator and brake pedals.
9. Release the parking brake.

**Note:** *Your vehicle is free to roll.*

10. Switch your vehicle off.

**Note:** *Do not tow your vehicle in this mode.*

## Returning Your Vehicle to Normal Mode

1. Press the brake pedal.
2. Shift into park (P).

## AUTOMATIC TRANSMISSION AUDIBLE WARNINGS

### Transmission Not In Park (P) Audible Warning

Sounds if you open the driver door before shifting into park (P).

### Park Selection Audible Warning

Sounds when you shift into park (P).

# Automatic Transmission

---

## TEMPORARY NEUTRAL MODE

### HOW DOES TEMPORARY NEUTRAL MODE WORK

Use this mode to keep your vehicle in neutral (N), for a limited time, when you exit your vehicle or switch your vehicle off. For example, if you exit your vehicle before an automatic car wash.

**Note:** *You do not need to use this mode at an automatic car wash if you shift into neutral (N) and stay in your vehicle with power on.*

**Note:** *Do not tow your vehicle in this mode.*

**Note:** *Automatic return to park (P) is delayed when your vehicle is in this mode. See **How Does Automatic Return to Park (P) Work** (page 218).*

### TEMPORARY NEUTRAL MODE LIMITATIONS

This mode could be unavailable if your 12 V battery charge level is low. Connect an external power source and attempt the procedure again.

Your vehicle could shift to park (P) after 30 minutes, or when the vehicle battery charge level is low. Prolonged use of this mode can cause the 12 V battery to run out of charge.

This mode could be unavailable if your vehicle is below operating temperature. Warm up your vehicle and attempt the procedure again.

Do not tow your vehicle in this mode. Failure to follow these instructions could result in vehicle damage not covered by the vehicle warranty.

### ENTERING TEMPORARY NEUTRAL MODE

1. Bring your vehicle to a complete stop.
2. Press and hold the brake pedal.
3. Power your vehicle on.

4. Shift into neutral (N).

**Note:** *An instructional message appears.*

5. Shift into neutral (N) again.

**Note:** *A confirmation message appears when your vehicle enters the mode.*

6. Release the brake pedal.

**Note:** *Your vehicle is free to roll.*

7. Switch your vehicle off.

**Note:** *Do not tow your vehicle in this mode.*

**Note:** *The neutral (N) indicator on the selector may flash in this mode.*

### EXITING TEMPORARY NEUTRAL MODE

1. Press the brake pedal.
2. Shift into park (P), or power your vehicle on and shift into drive (D) or reverse (R).

# Automatic Transmission

---

## AUTOMATIC RETURN TO PARK (P)

### HOW DOES AUTOMATIC RETURN TO PARK (P) WORK

Your vehicle shifts into park (P) when your vehicle is stationary and any of the following occur:

- You switch the vehicle off.
- You open the driver door with your seatbelt unfastened.
- You unfasten the driver seatbelt when the driver door is open.

**Note:** Do not use automatic return to park (P) when your vehicle is moving, except in an emergency. See **Stopping the Engine When Your Vehicle is Moving** (page 188).

### AUTOMATIC RETURN TO PARK (P) LIMITATIONS

Automatic return to park (P) may not work if any of the following occur:

- The driver door ajar sensor is malfunctioning.
- The driver seatbelt sensor is malfunctioning.

See an authorized dealer if any of the following occur:

- Seatbelt indicator illuminates or tone sounds with the driver seatbelt fastened.
- Door ajar indicator does not illuminate with the driver door open.
- Door ajar indicator illuminates with the driver door closed.
- Transmission not in park message appears, with the driver door closed, after you shift out of park (P).

## GRADE ASSIST

### HOW DOES GRADE ASSIST WORK

This feature helps maintain vehicle speed when driving down a slope. The system uses a combination of engine motoring and regenerative braking to maintain vehicle speed.

**Note:** You could hear engine speed increasing and decreasing. This is normal operation.

The system activates when all the following occur:

- Your vehicle is on a downhill slope.
- The selector is in drive (D).
- You release the accelerator pedal.

# Automatic Transmission

## AUTOMATIC TRANSMISSION – TROUBLESHOOTING

## AUTOMATIC TRANSMISSION – INFORMATION MESSAGES

Message	Description
Park Brake Not Applied	The electric parking brake is not fully applied.
Transmission Not in Park	A reminder to shift into park. In addition, this message is typically after reconnecting or recharging the battery until you cycle the ignition to the on mode.
SHIFT SYS FAULT Apply Park Brake Before Exiting the Vehicle	Displays when there is a system fault and the park brake needs to be pressed before exiting the vehicle. See your authorized dealer.

Message	Description
Transmission Malfunction Service Now	The system has detected a fault that requires service. Have your vehicle checked as soon as possible.
Select N To Confirm Stay In Neutral Mode	Displays when you shift into neutral (N).
Stay in Neutral Mode Engaged	Displays to confirm that your vehicle has entered Stay in Neutral Mode.

# All-Wheel Drive

---

## HOW DOES ALL-WHEEL DRIVE WORK

The all-wheel drive system is designed to continuously monitor and adjust power delivery to the front and rear wheels to optimize both traction and handling. The AWD system turns on when needed and does not require input from you.

Your all-wheel drive vehicle is not intended for off-road use. The AWD feature gives your vehicle some limited off-road capabilities in which driving surfaces are relatively level, obstruction-free and otherwise similar to normal on-road driving conditions. Operating your vehicle in conditions other than those, could subject the vehicle to excess stress which might result in damage which is not covered under your warranty.

## ALL-WHEEL DRIVE PRECAUTIONS



**WARNING:** Do not become overconfident in the ability of all-wheel drive vehicles. Although an all-wheel drive vehicle may accelerate better than a two-wheel drive vehicle in low traction situations, it won't stop any faster than two-wheel drive vehicles. Always drive at a safe speed.

## ALL-WHEEL DRIVE LIMITATIONS

Using different size tires other than the provided spare could cause system damage or disable the all-wheel drive system.



# All-Wheel Drive

---

## ALL-WHEEL DRIVE – TROUBLESHOOTING

### ALL-WHEEL DRIVE – INFORMATION MESSAGES

Message	Details
AWD Temporarily Disabled	The all-wheel drive system temporarily turns off to protect itself from overheating or if something (mechanical interference or de-synchronization) prevents all-wheel drive operation.
AWD Restored	The all-wheel drive system has resumed normal function due to the system cooling or mechanical synchronization.
AWD OFF	The all-wheel drive system may turn off to protect itself if you are using a temporary spare tire or if another vehicle system prevents all-wheel drive operation.
AWD Fault Service Required	The all-wheel drive system is not operating properly. If the warning stays on or continues to come on, contact an authorized dealer.

# Brakes

## BRAKE PRECAUTIONS

Wet brakes result in reduced braking efficiency. Gently press the brake pedal a few times when leaving a car wash or driving from standing water to dry the brakes.

**Note:** *Depending on applicable laws and regulations in the country for which your vehicle was originally built, your brake lamps may flash during heavy braking. Following this, your hazard lights may also flash when your vehicle comes to a stop.*

## ANTI-LOCK BRAKING SYSTEM

### ANTI-LOCK BRAKING SYSTEM LIMITATIONS

The anti-lock braking system does not eliminate the risk of crash when:

- You drive too closely to the vehicle in front of you.
- Your vehicle is hydroplaning.
- You take corners too fast.
- The road surface is poor.

**Note:** *If the system activates, the brake pedal could pulse and travel further. Maintain pressure on the brake pedal.*

## BRAKE OVER ACCELERATOR

In the event the accelerator pedal becomes stuck or entrapped, apply steady and firm pressure to the brake pedal to slow the vehicle and reduce engine power. If you experience this condition, apply the brakes and bring your vehicle to a safe stop. Move the transmission to park (P), switch the engine off and apply the parking brake. Inspect the accelerator pedal for any interference. If none are found and the condition persists, have your vehicle towed to the nearest authorized dealer.

## LOCATING THE BRAKE FLUID RESERVOIR

See **Under Hood Overview** (page 375).

## CHECKING THE BRAKE FLUID



**WARNING:** Do not use any fluid other than the recommended brake fluid as this will reduce brake efficiency. Use of incorrect fluid could result in the loss of vehicle control, serious personal injury or death.



**WARNING:** Only use brake fluid from a sealed container. Contamination with dirt, water, petroleum products or other materials may result in brake system damage or failure. Failure to adhere to this warning could result in the loss of vehicle control, serious personal injury or death.



**WARNING:** Do not allow the fluid to touch your skin or eyes. If this happens, rinse the affected areas immediately with plenty of water and contact your physician.



**WARNING:** The brake system could be affected if the brake fluid level is below the **MIN** mark or above the **MAX** mark on the brake fluid reservoir.

# Brakes

1. Park your vehicle on a level surface.



2. Look at the brake fluid reservoir to see where the brake fluid level is relative to the **MIN** and the **MAX** marks on the reservoir.

**Note:** To avoid fluid contamination, the reservoir cap must remain in place and fully tight, unless you are adding fluid.

Only use fluid that meets our specifications. See **Capacities and Specifications** (page 436).

## BRAKE FLUID SPECIFICATION

See **Brake Fluid Specification** (page 454).

## BRAKES – TROUBLESHOOTING

## BRAKES – WARNING LAMPS



**WARNING:** Driving your vehicle with the warning lamp on is dangerous. A significant decrease in braking performance may occur. It may take you longer to stop your vehicle. Have your vehicle checked as soon as possible. Driving extended distances with the parking brake engaged can cause brake failure and the risk of personal injury.



If the ABS indicator illuminates when you are driving, this indicates a malfunction. Your vehicle continues to have normal braking without the anti-lock braking system function. See an authorized dealer.

It also momentarily illuminates when you switch the ignition on to confirm the lamp is functional. If it does not illuminate when you switch the ignition on, or begins to flash at any time, have the system checked by an authorized dealer.

## BRAKE



The brake indicator momentarily illuminates when you switch the ignition on to confirm the lamp is functional. It may also illuminate when you apply the parking brake and the ignition is on. If it illuminates when your vehicle is moving, make sure the parking brake is disengaged. If the parking brake is disengaged, this indicates low brake fluid level or a brake system fault. See an authorized dealer.

**Note:** Lamps may vary depending on region.

# Brakes

## BRAKES – INFORMATION MESSAGES

Brake Fluid Level Low	The brake fluid level is low and the brake system should be inspected immediately. See <b>Checking the Brake Fluid</b> (page 222).
Check Brake System	The brake system needs servicing. Stop the vehicle in a safe place. Contact an authorized dealer.

## BRAKES – FREQUENTLY ASKED QUESTIONS

### Is brake dust on the wheels normal?

Brake dust could accumulate on the wheels, even under normal driving conditions. Some dust is inevitable as the brakes wear and does not contribute to brake noise. See **Cleaning Wheels** (page 397).

### Will wet driving conditions effect my braking abilities?

Wet brakes result in reduced braking efficiency. Gently press the brake pedal a few times when driving from a car wash or standing water to dry the brakes.

### Is brake noise considered normal?

Occasional brake noise is normal. If a metal-to-metal, continuous grinding or continuous squeal sound is present, the brake linings may be worn-out and an authorized dealer should check them. If the vehicle has continuous vibration or shudder in the steering wheel while braking, an authorized dealer should check your vehicle.

### When should you replace the brake fluid?

Brake fluid absorbs water over time which degrades the effectiveness of the brake fluid. Change the brake fluid at the specified intervals to prevent degraded braking performance. See **General Maintenance Information** (page 493).

# Electric Parking Brake

## WHAT IS THE ELECTRIC PARKING BRAKE

The electric parking brake is used to hold your vehicle on slopes and flat roads.

## APPLYING THE ELECTRIC PARKING BRAKE



**WARNING:** Apply the parking brake, shift into park (P), switch the ignition off and remove the key before you leave your vehicle. Failure to follow this instruction could result in personal injury or death.



**WARNING:** If you drive extended distances with the parking brake applied, you could cause damage to the brake system.



**WARNING:** The electric parking brake does not operate if the vehicle battery has run out of charge.



**WARNING:** If the parking brake is fully released, but the brake warning lamp remains illuminated, the brakes may not be working properly. Have your vehicle checked as soon as possible.



The switch is on the lower part of the instrument panel.

Pull the switch up to apply the electric parking brake. The red warning lamp flashes, then steadily illuminates when the parking brake is applied.

**Note:** *You can apply the electric parking brake when the ignition is off.*

**Note:** *The electric parking brake could automatically apply when park (P) is selected. See **Park (P)** (page 214).*

## APPLYING THE ELECTRIC PARKING BRAKE IN AN EMERGENCY

You can use the electric parking brake to slow or stop your vehicle in an emergency.

Pull the switch up and hold it.

The red warning lamp illuminates, a tone sounds and the stoplamps turn on when you use the electric parking brake in an emergency.

The electric parking brake continues to slow your vehicle down unless you release the switch.

**Note:** *Do not apply the electric parking brake when your vehicle is moving, except in an emergency. If you repeatedly use the electric parking brake to slow or stop your vehicle, you could cause damage to the brake system.*

# Electric Parking Brake

## MANUALLY RELEASING THE ELECTRIC PARKING BRAKE

1. Switch the ignition on.
2. Press and hold the brake pedal.
3. Push the switch down.

The red warning lamp turns off.

### Pulling Away When Towing a Trailer Uphill

1. Press and hold the brake pedal.
2. Pull the switch upward and hold it.
3. Shift into gear.
4. Press the accelerator pedal until engine has developed sufficient torque to prevent your vehicle from rolling down the hill.
5. Release the switch and pull away in a normal manner.

## AUTOMATICALLY RELEASING THE ELECTRIC PARKING BRAKE

1. Close the driver door.

2. Shift into gear.
3. Press the accelerator pedal and pull away in a normal manner.

## ELECTRIC PARKING BRAKE AUDIBLE WARNING

Sounds when the parking brake is on and your vehicle is moving. If the warning tone continues after you have released the parking brake, this indicates a malfunction. Have your vehicle checked as soon as possible.

## RELEASING THE ELECTRIC PARKING BRAKE IF THE VEHICLE BATTERY HAS RUN OUT OF CHARGE



**WARNING:** The electric parking brake does not operate if the vehicle battery has run out of charge.

Connect a booster battery to the vehicle battery to release the electric parking brake if the vehicle battery has run out of charge. See **Jump Starting the Vehicle** (page 352).

## ELECTRIC PARKING BRAKE – TROUBLESHOOTING

### ELECTRIC PARKING BRAKE – WARNING LAMPS

#### Brake System



It illuminates red when you apply the parking brake and your vehicle is on. If the lamp flashes when the parking brake has been released, this indicates the parking brake system requires service. Have your vehicle checked as soon as possible.

**Note:** *Lamps may vary depending on region.*



# Electric Parking Brake

---

## Electric Parking Brake



When the lamp illuminates yellow, it indicates a malfunction in the electric parking brake. Have your vehicle checked as soon as possible.

**Note:** *Lamps may vary depending on region.*

# Electric Parking Brake

## ELECTRIC PARKING BRAKE – INFORMATION MESSAGES

### Park Brake

Message	Action
Park Brake Engaged	The electric parking brake is set, the engine is running and you drive your vehicle more than 3 mph (5 km/h). If the warning stays on after the electric parking brake is released, have the system checked as soon as possible.
To Release: Press Brake and Switch	The electric parking brake is set and a manual release is attempted without the brake pedal being pressed.
Park Brake Use Switch to Release	The electric parking brake is set and an automatic release is attempted but cannot be performed. Perform a manual release.
Release Park Brake	The electric parking brake is set and your vehicle speed exceeds 3 mph (5 km/h). Release the electric parking brake before continuing to drive.
Park Brake Not Applied	The electric parking brake is not fully applied.
Park Brake Not Released	The electric parking brake is not fully released.
Brake maintenance mode	The electric parking brake system has been put into a special mode to allow brake service. Have the system checked as soon as possible.
Park Brake Limited Function Service Required	The electric parking brake system has detected a condition that requires service. Some functionality may still be available. Have the system checked as soon as possible.
Park Brake Malfunction Service Now	The electric parking brake system has detected a condition that requires service. Have the system checked as soon as possible.



# Electric Parking Brake

---

<b>Message</b>	<b>Action</b>
Park Brake System Overheated	Numerous electric parking brake applies have overheated the system. Wait 2 minutes before attempting to apply again.

# Reverse Brake Assist

## WHAT IS REVERSE BRAKE ASSIST

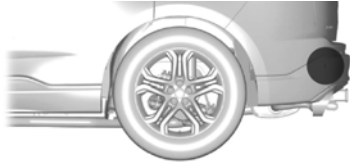

Reverse brake assist is designed to reduce impact damage or assist in avoiding a collision while in reverse (R). Using sensors on the rear of the vehicle, it can detect a possible collision and apply the brakes. If full braking occurs, the system attempts to stop the vehicle a safe distance from the obstacle.

## HOW DOES REVERSE BRAKE ASSIST WORK

Reverse brake assist functions when in reverse (R) and traveling at a speed of 1–7 mph (2–12 km/h).

If the system detects an obstacle behind your vehicle, it provides a warning through the rear parking aid or cross traffic alert system.

## REVERSE BRAKE ASSIST PRECAUTIONS

 **WARNING:** You are responsible for controlling your vehicle at all times. The system is designed to be an aid and does not relieve you of your responsibility to drive with due care and attention. Failure to follow this instruction could result in the loss of control of your vehicle, personal injury or death.

 **WARNING:** To help avoid personal injury, always use caution when in reverse (R) and when using the sensing system.

 **WARNING:** The system may not operate properly during severe weather conditions, for example snow, ice, heavy rain and spray. Always drive with due care and attention. Failure to take care may result in a crash.

 **WARNING:** Traffic control systems, fluorescent lamps, inclement weather, air brakes, external motors and fans may affect the correct operation of the sensing system. This may cause reduced performance or false alerts.

 **WARNING:** Some situations and objects prevent hazard detection. For example low or direct sunlight, inclement weather, unconventional vehicle types, and pedestrians. Apply the brakes when necessary. Failure to follow this instruction could result in the loss of control of your vehicle, personal injury or death.

# Reverse Brake Assist



**WARNING:** Do not use the system with accessories that extend beyond the front or rear of your vehicle, for example a trailer hitch or bike rack. The system is not able to make corrections for the additional length of the accessories.

The system only applies the brakes for a short period of time when an event occurs. Act as soon as you notice the brakes apply to remain in control of the vehicle. If you do not intervene the vehicle may start to move again.

**Note:** Certain add-on devices around the bumper or fascia may create false alerts. For example, large trailer hitches, bicycle or surfboard racks, license plate brackets, bumper covers or any other device that may block the normal detection zone of the system. Remove the add-on device to prevent false alerts.

**Note:** The system does not react to small or moving objects, particularly those close to the ground.

**Note:** The system does not operate during hard acceleration or steering.

**Note:** If your vehicle sustains damage to the bumper or fascia leaving it misaligned or bent, it could alter the sensing zone causing inaccurate measurement of obstacles or false alerts.

**Note:** Vehicle loading and suspension changes can impact the angle of the sensors and may change the normal detection zone of the system resulting in inaccurate measurement of obstacles or false alerts.

**Note:** When you connect a trailer, the system may detect the trailer and provide an alert, or the system turns off. If the system does not turn off, manually switch the system off after you connect the trailer.

**Note:** You may experience reduced system performance on road surfaces that limit deceleration. For example, roads with ice, loose gravel, mud or sand.

## SWITCHING REVERSE BRAKE ASSIST ON AND OFF

1. From the settings menu, press Driver Assistance. See **Center Display** (page 468).
2. Switch Reverse Brake Assist on or off.

**Note:** The system is unavailable when rear parking aid or cross traffic alert is off.

The default setting is on in some regions.

## OVERRIDING REVERSE BRAKE ASSIST

There could be instances when unexpected or unwanted braking occurs. Firmly pressing the accelerator pedal or switching the feature off overrides the system.

# Reverse Brake Assist

## REVERSE BRAKE ASSIST INDICATORS

If the system determines that a collision with an obstacle may occur, full braking may apply.



A message and warning indicator appear when the system applies the brakes.

## REVERSE BRAKE ASSIST – TROUBLESHOOTING

## REVERSE BRAKE ASSIST – INFORMATION MESSAGES

Message	Details
Reverse Brake Assist	Displays when the system applies the brakes and remains on for a few seconds.
Reverse Brake Assist Not Available See Manual	Displays when a related subsystem or feature error has occurred. Make sure the rear view camera and side cameras are clean and not obstructed. Drive the vehicle on a straight road for a short period. If the message remains on, have the system checked as soon as possible.
Reverse Brake Assist Fault	Displays when a system error has occurred. Have your vehicle checked as soon as possible.
Reverse Brake Assist Off	Displays when reverse brake assist is off.

# Reverse Brake Assist

---

## REVERSE BRAKE ASSIST – FREQUENTLY ASKED QUESTIONS

### Why is reverse brake assist unavailable?

- Make sure the reverse brake assist is on. See **Switching Reverse Brake Assist On and Off** (page 231).
  - Make sure that all doors, liftgate or tailgate and hood are closed. Drive the vehicle on a straight road for a short period. If the message remains, have the system checked.
  - If your vehicle has the cross traffic alert system, make sure it is on. See **Switching Cross Traffic Alert On and Off** (page 311).
  - Make sure the rear parking aid system is on. See **Rear Parking Aid** (page 249).
  - Your vehicle may have sustained a rear end impact. Have the sensors checked for proper coverage and operation.
- Make sure the rear view camera and side cameras are not dirty or obstructed. If dirty, clean the cameras. If the message remains after cleaning the cameras, wait a short time for the message to clear. If the message does not clear, drive the vehicle on a straight road for a short period. If the message still appears, have your system checked.
  - Make sure the cross traffic alert, rear parking aid and side parking aid sensors are not blocked or faulty. See **Locating the Cross Traffic Alert Sensors** (page 311). See **Locating the Rear Parking Aid Sensors** (page 249). See **Locating the Side Parking Aid Sensors** (page 252).
  - You recently had your vehicle serviced, or the battery disconnected. Drive your vehicle a short distance to resume system operation.
  - Reverse brake assist does not function when you connect a trailer. Operation resumes when you disconnect the trailer.

**Note:** *If the answers to why the system is unavailable do not assist in returning reverse brake assist to available, have the system checked as soon as possible.*

# Cross Traffic Braking

## WHAT IS CROSS TRAFFIC BRAKING

The system is designed to reduce impact damage or assist in avoiding a collision by using the sensors on the rear of your vehicle to detect a possible collision and applying the brakes.

## HOW DOES CROSS TRAFFIC BRAKING WORK

The system only reacts for vehicles approaching from the sides when you shift into reverse (R).

If the system detects a vehicle approaching your vehicle, it provides a warning through the cross traffic alert system. See **What Is Cross Traffic Alert** (page 310).

The system only applies the brakes for a short period of time when an event occurs. Take action as soon as you notice the system applying the brakes in order to remain in control of your vehicle, the system does not do this for you.

**Note:** *You need to enable cross traffic alert for the system to function.*

## CROSS TRAFFIC BRAKING PRECAUTIONS



**WARNING:** You are responsible for controlling your vehicle at all times. The system is designed to be an aid and does not relieve you of your responsibility to drive with due care and attention. Failure to follow this instruction could result in the loss of control of your vehicle, personal injury or death.



**WARNING:** To help avoid personal injury, always use caution when in reverse (R) and when using the sensing system.



**WARNING:** The system may not operate properly during severe weather conditions, for example snow, ice, heavy rain and spray. Always drive with due care and attention. Failure to take care may result in a crash.



**WARNING:** Do not use the system with accessories that extend beyond the front or rear of your vehicle, for example a trailer hitch or bike rack. The system is not able to make corrections for the additional length of the accessories.



**WARNING:** Some situations and objects prevent hazard detection, for example, inclement weather, unconventional vehicle types and pedestrians. Apply the brakes when necessary. Failure to follow this instruction could result in the loss of control of your vehicle, personal injury or death.

**Note:** *If your vehicle sustains damage to the bumper or fascia leaving it misaligned or bent, it could alter the sensing zone causing inaccurate measurement of obstacles or false alerts.*

**Note:** *Vehicle loading and suspension changes can impact the angle of the sensors and may change the normal detection zone of the system resulting in inaccurate measurement of obstacles or false alerts.*

# Cross Traffic Braking

---

**Note:** When you connect a trailer, the system may detect the trailer and provide an alert, or the system turns off. If the system does not turn off, switch the system off manually after you connect the trailer.

**Note:** You may experience reduced system performance on road surfaces that limit deceleration. For example, roads with ice, loose gravel, mud or sand.

## SWITCHING CROSS TRAFFIC BRAKING ON AND OFF

1. From the settings menu, press Driver Assistance. See **Center Display** (page 468).

2. Press Cross Traffic Alert.
3. Switch the feature on or off.

## OVERRIDING CROSS TRAFFIC BRAKING

There could be instances when unexpected or unwanted braking occurs. Firmly pressing the accelerator pedal or switching the feature off overrides the system.

## CROSS TRAFFIC BRAKING INDICATORS

If the system determines that a collision with an obstacle may occur, full braking may apply. Bring your vehicle to a stop a safe distance away from the obstacle.



A message and warning indicator appear when the system applies the brakes.

# Cross Traffic Braking

---

## CROSS TRAFFIC BRAKING – TROUBLESHOOTING

### CROSS TRAFFIC BRAKING – INFORMATION MESSAGES

<b>Message</b>	<b>Action</b>
Reverse Brake Assist Not Available See Manual	Drive the vehicle on a straight road for a short period. Make sure the parking aids and cross traffic alert systems are on. If the message remains on, have the system checked as soon as possible.
Reverse Brake Assist Fault	Displays when a system error has occurred. Have your vehicle checked as soon as possible.
Reverse Brake Assist Off	Displays when cross traffic braking is off.



# Cross Traffic Braking

---

## CROSS TRAFFIC BRAKING – FREQUENTLY ASKED QUESTIONS

Why is cross traffic braking unavailable?

- Make sure the cross traffic alert system is on. See **Cross Traffic Alert** (page 310).
- The vehicle has sustained a rear end impact. Contact an authorized dealer to have the sensors checked for proper coverage and operation.
- An ABS, traction control or stability control event may have occurred. Cross traffic braking resumes operation when the event is complete.
- Make sure there are no blocked or faulted sensors. See **Cross Traffic Alert** (page 310).
- You recently had your vehicle serviced, or the battery disconnected. Drive your vehicle a short distance to resume system operation.

**Note:** *If the answers to why the system is unavailable do not assist in returning cross traffic braking to available, have the system checked as soon as possible.*

# Hill Start Assist

## WHAT IS HILL START ASSIST



Hill Start Assist applies the brakes to hold your vehicle after you bring it to a stop on a slope. This makes it easier for you to pull away without using the parking brake.

## HOW DOES HILL START ASSIST WORK

When the system activates, your vehicle remains stationary for a few seconds after you release the brake pedal. This gives you time to move your foot from the brake pedal to the accelerator pedal. The brakes release when you apply the accelerator pedal and the vehicle begins to move forward, or the system exceeds the time allowed for automatically applying the brakes.

The system activates when your vehicle is in any forward gear and facing uphill, or when your vehicle is in reverse (R) and facing downhill.

## HILL START ASSIST PRECAUTIONS

 <b>WARNING:</b> The system does not replace the parking brake. When you leave your vehicle, always apply the parking brake.
 <b>WARNING:</b> You must remain in your vehicle when the system turns on. At all times you are responsible for controlling your vehicle, supervising the system, and intervening if required. Failure to follow this instruction could result in the loss of control of your vehicle, personal injury or death.
 <b>WARNING:</b> The system turns off if there is a malfunction.

## HILL START ASSIST – TROUBLESHOOTING

## HILL START ASSIST – INFORMATION MESSAGES

Message	Details
Hill Start Assist Not Available	Displays when system is not available. Have your vehicle checked as soon as possible.

# Auto Hold

## HOW DOES AUTO HOLD WORK

Auto hold applies the brakes to hold your vehicle after you bring the vehicle to a stop. This can help when waiting on a hill or in traffic.

## SWITCHING AUTO HOLD ON AND OFF - GASOLINE



**WARNING:** The system does not replace the parking brake. When you leave your vehicle, always apply the parking brake.



**WARNING:** You must remain in your vehicle when the system turns on. At all times you are responsible for controlling your vehicle, supervising the system, and intervening if required. Failure to follow this instruction could result in the loss of control of your vehicle, personal injury or death.



**WARNING:** The system will turn off if a malfunction is apparent. Failure to take care may result in the loss of control of your vehicle, serious personal injury or death.

1. From the controls menu, switch Auto hold on or off. See **Center Display** (page 468).

**Note:** *You can only switch the system on after you close the driver door and start the engine.*

**Note:** *The system remembers the last setting when you start your vehicle.*

Make sure you switch the system off before towing with your vehicle or before using an automatic car wash.

## SWITCHING AUTO HOLD ON AND OFF - FULL HYBRID ELECTRIC VEHICLE (FHEV)



**WARNING:** The system does not replace the parking brake. When you leave your vehicle, always apply the parking brake.



**WARNING:** You must remain in your vehicle when the system turns on. At all times you are responsible for controlling your vehicle, supervising the system, and intervening if required. Failure to follow this instruction could result in the loss of control of your vehicle, personal injury or death.



**WARNING:** The system will turn off if a malfunction is apparent. Failure to take care may result in the loss of control of your vehicle, serious personal injury or death.

# Auto Hold



Press the button on the center console. The button illuminates when you switch the system on and press again to switch the system off.

**Note:** You can only switch the system on after you close the driver door and start the engine.

**Note:** The system remembers the last setting when you start your vehicle.

Make sure you switch the system off before towing with your vehicle or before using an automatic car wash.

## USING AUTO HOLD

1. Bring your vehicle to a complete stop. The auto hold active indicator illuminates in the information display.
2. Release the brake pedal. The system holds your vehicle at a standstill. The auto hold active indicator remains illuminated in the information display.

3. Apply the accelerator and drive off in a normal manner. The system releases the brakes and the auto hold active indicator switches off.

**Note:** The system only activates if you apply enough brake pressure on the brake pedal to bring the vehicle to a standstill.

**Note:** Under certain conditions, the system could apply the electric parking brake. The brake system warning lamp illuminates. The electric parking brake releases when you press the accelerator pedal. See **Automatically Releasing the Electric Parking Brake** (page 226).

**Note:** The system switches off if you shift into reverse (R) or neutral (N) while pressing the brake pedal.

There could be actions that can cause the auto hold system not to work when the following occur:

- When you use active park assist.
- Your vehicle is in stay in neutral mode.
- The driver door is open.
- You shift into reverse (R) or neutral (N) before the system is active.

## AUTO HOLD INDICATORS



Illuminates when the system is active.



Illuminates when the system is on but cannot hold your vehicle at a standstill at this particular time.

# Traction Control

## HOW DOES TRACTION CONTROL WORK

If your vehicle begins to slide, the system applies the brakes to individual wheels and, when needed, reduces power at the same time. If the wheels spin when accelerating on slippery or loose surfaces, the system reduces power in order to increase traction.

## SWITCHING TRACTION CONTROL ON AND OFF



**WARNING:** Operating your vehicle with the traction control disabled could lead to an increased risk of loss of vehicle control, vehicle rollover, personal injury and death.

**Note:** *You can only switch the system on after you close the driver door and start the engine.*

1. From the controls menu, press Traction Control. See **Center Display** (page 468).

2. Switch Traction Control on or off.

## TRACTION CONTROL INDICATOR



## TRACTION CONTROL – TROUBLESHOOTING

## TRACTION CONTROL – WARNING LAMPS

### System Messages



The traction control light temporarily illuminates on start-up and flashes when activated by a driving condition. The light stays on if a problem occurs in the system.



The traction control off light temporarily illuminates on start-up and stays on:

- When you switch the traction control system off.
- When you select an alternative stability control mode.

# Stability Control

## HOW DOES STABILITY CONTROL WORK



**WARNING:** Vehicle modifications involving braking system, aftermarket roof racks, suspension, steering system, tire construction and wheel and tire size may change the handling characteristics of your vehicle and may adversely affect the performance of the electronic stability control system. In addition, installing any stereo loudspeakers may interfere with and adversely affect the electronic stability control system. Install any aftermarket stereo loudspeaker as far as possible from the front center console, the tunnel, and the front seats in order to minimize the risk of interfering with the electronic stability control sensors. Reducing the effectiveness of the electronic stability control system could lead to an increased risk of loss of vehicle control, vehicle rollover, personal injury and death.



**WARNING:** Remember that even advanced technology cannot defy the laws of physics. It's always possible to lose control of a vehicle due to inappropriate driver input for the conditions. Aggressive driving on any road condition can cause you to lose control of your vehicle increasing the risk of personal injury or property damage. Activation of the electronic stability control system is an indication that at least some of the tires have exceeded their ability to grip the road; this could reduce the operator's ability to control the vehicle potentially resulting in a loss of vehicle control, vehicle rollover, personal injury and death. If your electronic stability control system activates, **SLOW DOWN**.

If a driving condition activates either the stability control or the traction control system you may experience the following conditions:

- The stability and traction control light flashes.
- Your vehicle slows down.
- Reduced engine power.

The stability control system has several features built into it to help you maintain control of your vehicle:

### Electronic Stability Control

Electronic stability control enhances your vehicle's ability to prevent skids or lateral slides by applying brakes to one or more of the wheels individually and, if necessary, reducing engine power.

### Roll Stability Control

Roll stability control enhances your vehicle's ability to prevent rollovers by detecting your vehicle's roll motion and the rate at which it changes by applying the brakes to one or more wheels individually.

# Stability Control

## Curve Control

Curve control enhances your vehicle's ability to follow the road when cornering severely or avoiding objects in the roadway. Curve control operates by reducing engine power and, if necessary, applying brakes to one or more of the wheels individually.

## Traction Control

Traction control enhances your vehicle's ability to maintain traction of the wheels by detecting and controlling wheel spin. See **How Does Traction Control Work** (page 241).

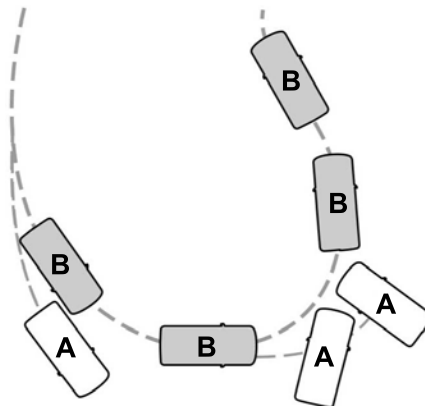

- A Vehicle without stability control skidding off its intended route.
- B Vehicle with stability control maintaining control on a slippery surface.

## SWITCHING STABILITY CONTROL ON AND OFF

The system turns on each time you switch the power on.

You cannot switch the electronic stability control system off.

Shifting into reverse (R) will disable the system.

You can switch the traction control system off or on independently. See **Switching Traction Control On and Off** (page 241).

## STABILITY CONTROL INDICATOR



If it does not illuminate when you switch the power on, or remains on, this indicates a malfunction.

Have your vehicle checked by an authorized dealer as soon as possible.

# Stability Control

---

## STABILITY CONTROL – TROUBLESHOOTING

### STABILITY CONTROL – INFORMATION MESSAGES

Service AdvanceTrac	Displayed when the system has detected a condition that requires service. Contact your authorized dealer as soon as possible.
---------------------	---



# Steering

## ELECTRIC POWER STEERING

### HOW DOES ELECTRIC POWER STEERING WORK

The electric power steering system assists the brake system to help operate advanced stability control and accident avoidance systems.

If your vehicle loses electrical power or detects a concern when you are driving, the system switches to reduced steering assist or manual steering. Additionally, whenever disconnecting the battery or installing a new one, you must drive your vehicle a short distance before the system relearns the strategy and reactivates all systems.

### ELECTRIC POWER STEERING PRECAUTIONS



**WARNING:** The electric power steering system has diagnostic checks that continuously monitor the system. If a fault is detected, a message displays in the information display. Stop your vehicle as soon as it is safe to do so. Switch the vehicle off. After at least 10 seconds, switch the vehicle on and watch the information display for a steering system warning message. If a steering system warning message returns, have the system checked as soon as possible.



**WARNING:** If the system detects an error, you may not feel a difference in the steering, however a serious condition may exist. Have your vehicle checked as soon as possible. Failure to do so may result in loss of steering control.

Adapt your speed and driving behavior according to reduced steering assist.

Extreme continuous steering may increase the effort to steer. This occurs to prevent internal overheating and damage to the steering system. If this occurs, you will not lose the ability to steer your vehicle manually nor will it cause damage to the system. Normal steering and driving allows the system to cool down and steering assist returns to normal.

**Note:** *There is no fluid reservoir to check or fill.*

## STEERING – TROUBLESHOOTING

### STEERING – WARNING LAMPS



The electric power steering system indicator illuminates if the system detects a fault during the continuous diagnostic checks.

**Note:** *If a red warning message displays, stop your vehicle as soon as it is safe to do so.*

# Steering

---

## STEERING – INFORMATION MESSAGES

Message	Action
Steering Fault Service Now	The power steering system has detected a condition that requires service. Have your vehicle checked as soon as possible.
Steering Loss Stop Safely	The power steering system is not working. Stop your vehicle in a safe place. Have your vehicle checked as soon as possible.
Steering assist fault Service required	The power steering system has detected a condition that requires service. Have your vehicle checked as soon as possible.

# Steering

---

## **STEERING – FREQUENTLY ASKED QUESTIONS**

### **Why does it seem that the steering is wandering or pulling?**

- Check your vehicle for an improperly inflated or uneven tire, loose or worn suspension or steering components, or improper vehicle alignment.

### **The system is functioning properly and the components have been checked, why is the steering system continuing to pull or wander?**

- A high crown in the road or crosswinds could make the steering system feel like it is wandering or pulling.

# Parking Aids

## PARKING AID PRECAUTIONS

 **WARNING:** To help avoid personal injury, always use caution when in reverse (R) and when using the sensing system.

 **WARNING:** The system may not detect objects with surfaces that absorb reflection. Always drive with due care and attention. Failure to take care may result in a crash.

 **WARNING:** Traffic control systems, fluorescent lamps, inclement weather, air brakes, external motors and fans may affect the correct operation of the sensing system. This may cause reduced performance or false alerts.

 **WARNING:** The system may not detect small or moving objects, particularly those close to the ground.

 **WARNING:** The parking aid system can only assist you to detect objects when your vehicle is moving at parking speeds. To help avoid personal injury you must take care when using the parking aid system.

 **WARNING:** The system may not function if the sensor is blocked.

 **WARNING:** In cold and severe weather conditions the system may not function. Rain, snow and spray can all limit sensor performance.

 **WARNING:** If damage occurs in the immediate area surrounding the sensor, have your vehicle checked as soon as possible.

**Note:** *If your vehicle sustains damage leaving the sensors misaligned, this will cause inaccurate measurements or false alerts.*

When you connect a trailer to your vehicle, the rear parking aid detects the trailer and provides an alert. Disable the parking aid when you connect a trailer to prevent the alert.

**Note:** *Connected trailers might be detected by the vehicle and parking aid turns off automatically in those instances.*

**Note:** *Certain add-on devices installed around the bumper or fascia may create false alerts. For example, large trailer hitches, bike or surfboard racks, license plate brackets, bumper covers or any other device could block the normal detection zone of the parking aid system. Aftermarket spare tires or spare tire covers mounted to the rear tailgate could cause false alerts from the park aid system. Remove the add-on device to prevent false alerts.*

**Note:** *Keep the sensors free from snow, ice and large accumulations of dirt. If the sensors are covered, the system's accuracy can be affected.*

Do not clean the sensors with sharp objects.

# Parking Aids

## SWITCHING PARKING AID ON AND OFF



Press the parking aid button and use the menu to switch the system on and off.

## REAR PARKING AID

### WHAT IS THE REAR PARKING AID

Rear parking sensors detect objects behind your vehicle when in reverse (R).

### REAR PARKING AID LIMITATIONS

There is a decreased coverage area at the outer corners.

The rear parking aid sensors are active when your vehicle is in reverse (R) and the vehicle speed is less than 5 mph (8 km/h).

The sensor coverage area is up to 71 in (180 cm) from the rear bumper.

The rear parking aid detects large objects when you shift into reverse (R) and any of the following occur:

- Your vehicle is moving backward at a low speed.
- Your vehicle is stationary but an object is approaching the rear of your vehicle at a low speed.
- Your vehicle is moving backward at a low speed and an object is moving towards your vehicle, for example another vehicle at a low speed.

The system shall provide no audible warning for the object behind the vehicle when in neutral (N) gear.

## LOCATING THE REAR PARKING AID SENSORS



The rear parking aid sensors are in the rear bumper.

# Parking Aids

## REAR PARKING AID AUDIBLE WARNINGS

A warning tone sounds when your vehicle approaches an object. As your vehicle moves closer to an object, the rate of the tone increases. The warning tone continuously sounds when an object is 12 in (30 cm) or less from the rear bumper.

If your vehicle remains stationary for a few seconds, the audible warning turns off. If your vehicle moves backward the tone sounds again.

**Note:** *When the parking aid system sounds a tone, the audio system could reduce the set volume.*

## FRONT PARKING AID

### WHAT IS THE FRONT PARKING AID

Front parking sensors detect objects in front of your vehicle.

## FRONT PARKING AID LIMITATIONS

The front parking aid sensors are active when your vehicle is in any position other than park (P) and the vehicle speed is less than 5 mph (8 km/h).

The sensor coverage area is up to 28 in (70 cm) from the front bumper.

If your vehicle is in reverse (R), the front parking aid detects objects and provides an audible warning when your vehicle is moving at a low speed and when an object is moving toward your vehicle, for example, another vehicle at a low speed. If your vehicle remains stationary for a few seconds, the audible warning turns off. Visual indication is always active in reverse (R).

If your vehicle is in any forward gear, the front parking aid provides audible warnings and a visual indication when your vehicle is moving at a speed of 5 mph (8 km/h) or below and the system detects an object within the detection zone. If your vehicle remains stationary for a few seconds, the visual indication and audible warning turns off.

If your vehicle is in neutral (N), the front and rear sensors provide a visual indication only when your vehicle is moving below a speed of 5 mph (8 km/h) and the system detects obstacles inside the detection areas. Once your vehicle stops, the visual indication and audible warning stops after a few seconds.

## LOCATING THE FRONT PARKING AID SENSORS



The front parking aid sensors are in the front bumper.

# Parking Aids

---

## FRONT PARKING AID AUDIBLE WARNINGS

A warning tone sounds when there is an object within 28 in (70 cm) from the front bumper. As your vehicle moves closer to an object, the rate of the tone increases.

The warning tone continuously sounds when an object is 12 in (30 cm) or less from the front bumper.

**Note:** *If the detected object is 12 in (30 cm) or less from your vehicle, visual indication remains on.*

## SIDE PARKING AID

### WHAT IS THE SIDE PARKING AID

The front and rear outermost parking aid sensors map objects that are near to the sides of your vehicle.

### SIDE PARKING AID LIMITATIONS

The sensor coverage is up to 24 in (60 cm) from the sides of your vehicle.

The side parking aid may not function if:

- Your vehicle remains stationary for over two minutes.
- The anti-lock brake system activates.
- The traction control system activates.
- Your vehicle is in park (P).
- The steering wheel angle information is not available. To reset the steering wheel angle information, drive straight for at least 492 ft (150 m) above 19 mph (30 km/h).

**Note:** *If you switch traction control off, the side sensing system also turns off.*

To reinitialize the system, drive the length of your vehicle.

The side parking aid does not detect an object that is moving toward the side of your vehicle, for example another vehicle moving at a low speed, if it does not pass a front or rear parking aid sensor.

If the transmission is in reverse (R), the side sensing system provides audible warnings. When your vehicle is moving slowly, the system detects obstacles within 24 in (60 cm) and are inside the driving path of your vehicle. If your vehicle remains stationary for a few seconds, the audible warning turns off. Visual indication is always present in reverse (R).

If your vehicle is in neutral (N), the side sensing system provides visual indication only when your vehicle is moving slowly and there is a front or rear parking aid obstacle detected, and the side obstacle is within 24 in (60 cm) from the side of your vehicle. If your vehicle remains stationary for a few seconds, the visual indication turns off.

If the transmission is in drive (D) or any other forward gear, the side sensing system provides audible and visual warnings. When your vehicle is moving slowly, the system detects obstacles within 24 in (60 cm) and are inside the driving path of your vehicle. If your vehicle remains stationary for a few seconds, the visual indication and audible warning turns off.

# Parking Aids

## LOCATING THE SIDE PARKING AID SENSORS



The side parking sensors are located in the sides of the front and rear bumpers.

## SIDE PARKING AID AUDIBLE WARNINGS

When the side parking aid detects an object within the coverage area and the driving path of your vehicle, an audible warning sounds. As your vehicle moves closer to the object, the rate of the tone increases.

## PARKING AID INDICATORS



The system provides object distance indication through the information and entertainment display.

- As the distance to the object decreases, the indicator waves and the lines move toward the vehicle icon.
- If there is no object detected, the distance indicator lines are grey.

Visual indication remains on when your vehicle is in reverse (R). In any other gear, when you stop your vehicle, visual indication turns off after four seconds.

If the parking aids are not available, the side distance indicator lines do not display.

## PARKING AIDS – TROUBLESHOOTING

### PARKING AIDS – INFORMATION MESSAGES

If a fault is present in the parking aids, a warning message appears in the instrument cluster or the touchscreen.

**Note:** *When the front or rear park aid presents a fault message, the side parking aid also disables.*



# Parking Aids

---

<b>Message</b>	<b>Action</b>
Check Front Park Aid	The system detects a condition that requires service. Have your vehicle checked as soon as possible.
Check Rear Park Aid	The system detects a condition that requires service. Have your vehicle checked as soon as possible.
Front Park Aid On Off	Displays the park aid status.
Rear Park Aid On Off	Displays the park aid status.

# 360 Degree Camera

## WHAT IS THE 360 DEGREE CAMERA

The 360 degree camera system provides visibility around your vehicle in parking maneuvers such as:

- Centering in a parking space.
- Obstacles near your vehicle.
- Parallel parking.

The 360 degree camera system consists of front, side and rear cameras.

## HOW DOES THE 360 DEGREE CAMERA WORK

The 360 degree camera system consists of front, side and rear cameras.

The 360 Degree Camera system:

- Allows you to see what is directly in front of or behind your vehicle.
- Provides a cross traffic view in front of and behind your vehicle.
- Allows you to see a top-down view of the area outside your vehicle, including the blind spots and obstacles near your vehicle.

## 360 DEGREE CAMERA PRECAUTIONS



**WARNING:** The 360 degree camera system still requires the driver to use it in conjunction with looking out of the windows, and checking the interior and exterior mirrors for maximum coverage.



**WARNING:** Objects that are close to either corner of the bumper or under the bumper, might not be seen on the screen due to the limited coverage of the camera system.



**WARNING:** Use caution when turning camera features on or off when the transmission is not in park (P). Make sure your vehicle is not moving.



**WARNING:** You are responsible for controlling your vehicle at all times. The system is designed to be an aid and does not relieve you of your responsibility to drive with due care and attention. Failure to follow this instruction could result in the loss of control of your vehicle, personal injury or death.



**WARNING:** Use caution when the liftgate is ajar. If the liftgate is ajar, the camera is out of position and the video image could be incorrect. All guide lines disappear when the liftgate is ajar. Failure to follow this instruction could result in personal injury.



**WARNING:** When manual zoom is on, the full area behind your vehicle may not show. Be aware of your surroundings when using the manual zoom feature.

# 360 Degree Camera

---

## **LOCATING THE 360 DEGREE CAMERAS**

### **Rear View Camera**

The rear view camera is on the liftgate. It provides a video image of the area behind your vehicle.

### **Front View Camera**

The front view camera is in the grille. It provides a video image of the area in front of your vehicle.

### **Side View Camera**

The side view camera is on the outside mirror. It provides a video image of the area on the sides of your vehicle to aid you when parking.

# 360 Degree Camera

## 360 DEGREE CAMERA GUIDE LINES

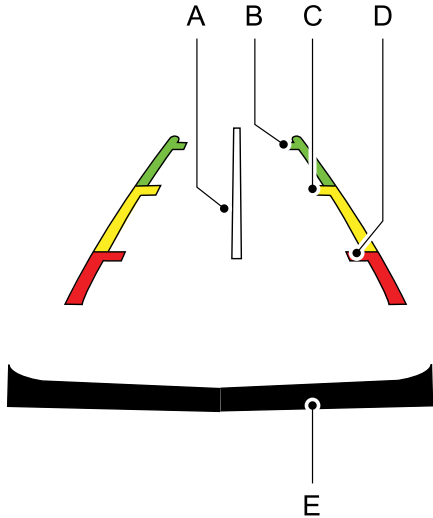

A	Centerline.
B	Fixed guide line: Green zone.
C	Fixed guide line: Yellow zone.
D	Fixed guide line: Red zone.
E	Rear bumper.

Objects in the red zone are closest to your vehicle and objects in the green zone are farther away. Objects get closer to your vehicle as they move from the green zone to the yellow or red zones. Use the side view mirrors and rear view mirror to get better coverage on both sides and rear of your vehicle.

## Keep Out Zone

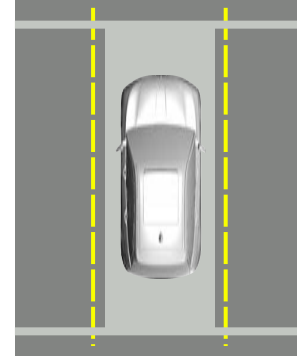

The keep out zone is represented by the yellow dotted lines running parallel to your vehicle.

E361787

# 360 Degree Camera

## 360 DEGREE CAMERA SETTINGS

### SWITCHING THE 360 DEGREE CAMERA ON AND OFF



Press the button on the center console to bring up full screen notifications.

**Note:** When the button is pressed, the **normal + 360 degree view** is shown as default and other front views are accessed from the screen.

**Note:** The rear view camera activates when you switch into reverse (R).

The following camera views can be changed on the touchscreen:

- Normal view.
- Normal view with 360 degree.
- Split view.

When in park (P), neutral (N) or drive (D), only the front images display when the button is pressed.

**Note:** The 360 degree camera system turns off when your vehicle speed is greater than 18.6 mph (30 km/h), except when in reverse (R).

### Object Detected Camera Views

The object detected camera views triggers the front 360 degree view activates automatically when the following conditions are met:

- Parking aid is active.
- An object is close to the front of the vehicle.
- The vehicle is in Drive (D) or Neutral (N).

When the object distance indicator is green or yellow, the front 360 degree view displays and remains active for 4 seconds before closed.

When the object distance indicator is red, the front 360 degree view displays and remains active continuously.

**Note:** When a view is already displayed, the object detected camera view will not replace the current active view.

## SWITCHING THE 360 DEGREE CAMERA VIEW

You can press the button on the touch screen to access the different camera views.



**Normal + 360 view:** Contains the normal camera view next to a 360 degree camera view.



**Normal view:** Provides an image of what is directly in front of your vehicle.



**Split view:** Provides an extended view of what is in front of your vehicle.



**Split view:** Provides an extended view of what is behind your vehicle.



**Normal view:** Provides an image of what is directly behind your vehicle.



Zooms in on the image.

# 360 Degree Camera

---



Zooms out on the image.

# Active Park Assist

## WHAT IS ACTIVE PARK ASSIST

Active park assist aids you with parking into parallel and perpendicular parking spaces and out of parallel parking spaces.

## HOW DOES ACTIVE PARK ASSIST WORK

Once a parking space has been identified, the system steers, accelerates, brakes and shifts gears as necessary to maneuver in or out of a parking space.

## ACTIVE PARK ASSIST PRECAUTIONS



**WARNING:** You must remain in your vehicle when the system turns on. At all times, you are responsible for controlling your vehicle, supervising the system and intervening, if required. Failure to take care may result in the loss of control of your vehicle, serious personal injury or death.



**WARNING:** The sensors may not detect objects in heavy rain or other conditions that cause interference.



**WARNING:** You are responsible for controlling your vehicle at all times. The system is designed to be an aid and does not relieve you of your responsibility to drive with due care and attention. Failure to follow this instruction could result in the loss of control of your vehicle, personal injury or death.



**WARNING:** Do not use the system with accessories that extend beyond the front or rear of your vehicle, for example a trailer hitch or bike rack. The system is not able to make corrections for the additional length of the accessories.

## SWITCHING ACTIVE PARK ASSIST ON AND OFF



Press the parking button.



The active park assist icon appears on the touchscreen. Select the icon to display the instructions. You can activate the system to search for parking spaces, or after passing an available space and stopping.

## Cancelling Active Park Assist

To cancel active park assist at any time, shift out of neutral (N).

**Note:** *If you turn the steering wheel or open the driver door active park assist also cancels.*

## Pausing Active Park Assist

To pause active park assist at any time, release the parking button.

The vehicle stops moving until you press and hold the parking button again.

**Note:** *If you open the passenger or rear doors active park assist also pauses.*

# Active Park Assist

## ENTERING A PARKING SPACE

**Note:** The system detects other vehicles and curbs to find a parking space. The system does not recognize parking space lines and centers your vehicle between objects.

1. Press the parking aid button.
2. Touch the parking assistance icon on the touchscreen.
3. Drive your vehicle approximately 3 ft (1 m) away from the other parked vehicles when searching for a parking space. The system automatically searches both sides of the vehicle for available parallel and perpendicular parking spaces.

**Note:** Any available parking spaces detected by the active park assist system are shown on the touchscreen. When driving at speeds between 0-19 mph (0-30 km/h), a notification that a space is found appears on the left or right side in the touchscreen visual display. When driving at speeds below 9.3 mph (15 km/h), the type of space and its location relative to the vehicle is shown.

**Note:** Active park assist automatically searches both sides of the vehicle for available parallel and perpendicular parking spaces. If a space qualifies for both parallel and perpendicular parking, touch the swap parking slot symbol on the touchscreen to change the parking type.

4. When a space is found, bring the vehicle to a stop and hold the brake pedal.
5. Release the steering wheel and shift into neutral (N).
6. Press and hold the parking aid button.
7. Release the brake pedal to allow the vehicle to park.

**Note:** When parallel parking between objects, the system parks closer to the object in front of your vehicle.

**Note:** Active park assist aligns the front end of your vehicle with the object next to it. When perpendicular parking next to a single object, the system allows enough distance to open the door on either side.

**Note:** You can slow down your vehicle at any time by pressing the brake pedal.

**Note:** When parking is complete the vehicle shifts into park (P). You can finish the active park assist maneuver at any time by shifting into park (P) yourself.

## EXITING A PARKING SPACE

Active park assist only assists when exiting a parallel parking space.

1. Press the parking aid button.
2. Press the parking assistance icon on the touchscreen.
3. Use the turn signal to select and confirm the direction to exit the parking space.
4. Press and hold the brake pedal.
5. Release the steering wheel and shift into neutral (N).
6. Release the parking brake.
7. Press and hold the parking aid button.
8. Release the brake pedal to allow the vehicle to move.



# Active Park Assist

**Note:** After active park assist drives your vehicle to a position where you can exit the parking space in a forward movement, a message appears instructing you to take full control of your vehicle to continue on the steering path.

9. Take control of your vehicle by pressing the brake pedal and shifting into drive (D).

**Note:** You can slow down your vehicle at any time by pressing the brake pedal.

## ACTIVE PARK ASSIST – TROUBLESHOOTING

### ACTIVE PARK ASSIST – INFORMATION MESSAGES

Message	Action
Active Park Fault	The system requires service. Have your vehicle checked as soon as possible.

## ACTIVE PARK ASSIST – FREQUENTLY ASKED QUESTIONS

Symptom	Possible Cause
The system does not operate correctly.	The system is unable to detect a vehicle, curb or object to park next to or in between.
The system does not show the parking assistance option on the touchscreen.	The system requires that you press the parking aid button located just below the center display.
The system does not search for a parking space.	You may have switched traction control off.
	The transmission is in reverse (R). Your vehicle must be moving forward to be able to detect a parking space.

## Active Park Assist

Symptom	Possible Cause
The system does not offer a parking space.	The sensors may be blocked, affecting sensor operation. Check the sensors for any obstructions such as snow, ice or large accumulations of dirt. Blocked sensors can affect how the system functions.
	There is not enough room in the parking space for your vehicle to safely park.
	There is not enough space for the parking maneuver on the opposite side of the parking space.
	The parking space is more than 5 ft (1.5 m) or less than 2 ft (0.5 m) away.
	The vehicle speed is greater than 19 mph (30 km/h).
	You recently disconnected or replaced the battery. After you reconnect the battery you must drive your vehicle on a straight road for a short period of time.
	The sensors in the front or rear bumper could be damaged.
The system does not correctly position your vehicle in a parking space.	An irregular curb along the parking space prevents the system from correctly aligning your vehicle.
	Vehicles or objects bordering the space may not be correctly parked.
	Your vehicle stopped too far past the parking space.
	The tires may not be correctly installed or maintained. For example, not inflated correctly, improper size or of different sizes.
	A repair or alteration changes the detection capabilities.

## Active Park Assist

---

<b>Symptom</b>	<b>Possible Cause</b>
	A parked vehicle has a high attachment. For example, a salt sprayer, snowplow or moving truck bed.
	The parking space length or position of parked objects changes after your vehicle passes the space.
	You are using a spare tire or a tire that is significantly worn more than the other tires.
	The temperature around your vehicle quickly changes. For example, driving from a heated garage into cold outside temperature, or after leaving a car wash.

# Adaptive Cruise Control

## HOW DOES ADAPTIVE CRUISE CONTROL WITH STOP AND GO WORK

Adaptive cruise control with stop and go uses radar and camera sensors to maintain a set gap between your vehicle and the vehicle in front of you while following it to a complete stop. Stop and go can also be set to follow a vehicle directly in front of you and adjust the set speed, while you are at a complete stop.

## ADAPTIVE CRUISE CONTROL PRECAUTIONS

 **WARNING:** You are responsible for controlling your vehicle at all times. The system is designed to be an aid and does not relieve you of your responsibility to drive with due care and attention. Failure to follow this instruction could result in the loss of control of your vehicle, personal injury or death.

 **WARNING:** Do not use adaptive cruise control on winding roads, in heavy traffic or when the road surface is slippery. This could result in loss of vehicle control, serious injury or death.

 **WARNING:** Pay close attention to changing road conditions such as entering or leaving a highway, on roads with intersections or roundabouts, roads without visible lanes of travel, roads that are unpaved, or steep slopes. Failure to follow this instruction could result in the loss of control of your vehicle, personal injury or death.

 **WARNING:** The system is not a crash warning or avoidance system.

 **WARNING:** Do not use the system when towing a trailer that has aftermarket electronic trailer brake controls. Failure to follow this instruction could result in the loss of control of your vehicle, personal injury or death.

 **WARNING:** Do not use tire sizes other than those recommended because this can affect the normal operation of the system. Failure to do so may result in a loss of vehicle control, which could result in serious injury.

 **WARNING:** Do not use the system with a snow plow blade installed.

 **WARNING:** In situations with poor visibility, such as fog, heavy rain or other inclement weather, you may need to override or completely switch off the system.

## When Following a Vehicle

 **WARNING:** When following a vehicle that is braking, your vehicle does not always decelerate quickly enough to avoid a crash without driver intervention. Apply the brakes when necessary. Failure to follow this instruction could result in personal injury or death.

# Adaptive Cruise Control

## Hilly Condition Usage

Select a lower gear when the system is active in situations such as prolonged downhill driving on steep slopes, for example in mountainous areas.

## ADAPTIVE CRUISE CONTROL LIMITATIONS

### Sensor Limitations

**WARNING:** On rare occasions, detection issues can occur due to the road infrastructures, for example bridges, tunnels and safety barriers. In these cases, the system may brake late or unexpectedly. At all times, you are responsible for controlling your vehicle, supervising the system and intervening, if required.

**WARNING:** If the system malfunctions, have your vehicle checked as soon as possible.

**WARNING:** Large contrasts in outside lighting can limit sensor performance.

**WARNING:** The system only warns of vehicles detected by the radar sensor. In some cases there may be no warning or a delayed warning. Apply the brakes when necessary. Failure to follow this instruction could result in personal injury or death.

**WARNING:** The system may not detect stationary or slow moving vehicles below 6 mph (10 km/h).

**WARNING:** The system does not detect pedestrians or objects in the road.

**WARNING:** The system does not detect oncoming vehicles in the same lane.

**WARNING:** The system may not operate properly if the sensor is blocked. Keep the windshield free from obstruction.

**WARNING:** The sensor may incorrectly track lane markings as other structures or objects. This can result in a false or missed warning.

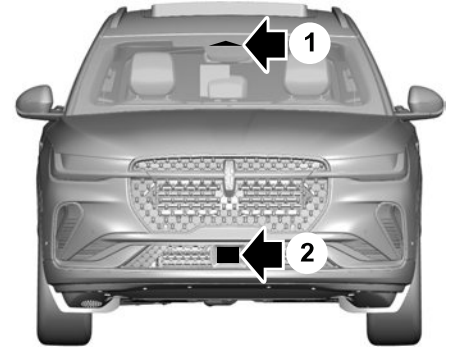

1. Camera.
2. Radar sensor.

The camera is on the windshield behind the interior mirror.

# Adaptive Cruise Control

---

The radar sensor is in the lower grille.

**Note:** *You cannot see the sensor. It is behind a fascia panel.*

**Note:** *Keep the front of your vehicle free of dirt, metal badges or objects. Vehicle front protectors, aftermarket lights, additional paint or plastic coatings could also degrade sensor performance.*

A message displays if something obstructs the camera or the sensor. When something blocks the sensor, the system cannot detect a vehicle ahead and does not function. See

**Adaptive Cruise Control – Information Messages** (page 281).

The radar sensor has a limited field of view. It may not detect vehicles at all or detect a vehicle later than expected in some situations. The lead vehicle image does not illuminate if the system does not detect a vehicle in front of you.

# Adaptive Cruise Control

## Detection Issues Can Occur:

**A**

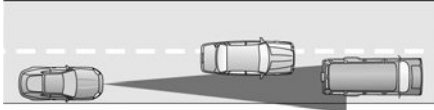

**B**



**C**

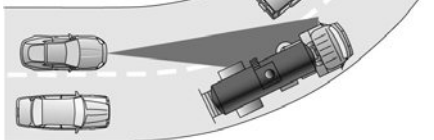

- A When driving on a different line than the vehicle in front.

- B With vehicles that edge into your lane. The system can only detect these vehicles once they move fully into your lane.
- C There may be issues with the detection of vehicles in front when driving into and coming out of a bend or curve in the road.

In these cases, the system may brake late or unexpectedly.

If something hits the front end of your vehicle or damage occurs, the radar-sensing zone may change. This could cause missed or false vehicle detection.

Optimal system performance requires a clear view of the road by the windshield camera.

Optimal performance may not occur if:

- The camera is blocked.
- There is poor visibility or lighting conditions.
- There are bad weather conditions.

## SWITCHING ADAPTIVE CRUISE CONTROL ON AND OFF

The cruise controls are on the steering wheel.

### Switching Adaptive Cruise Control On



Press the button to activate the system. When the system activates, the set speed is equal to whichever is greater, the current vehicle speed, or 15 mph when in imperial units or 20 km/h when in metric units. If the speed is too low, or other conditions are not correct for adaptive cruise control activation, the system enters standby mode. When you are below 15 mph when in imperial units or 20 km/h when in metric units, adaptive cruise control does not activate unless you are following another vehicle.

The indicator, current gap setting and set speed appear in the instrument cluster display.

# Adaptive Cruise Control

## Switching Adaptive Cruise Control Off



Press the button when the system is in standby mode or switch the ignition off.

**Note:** When you switch the system off, the set speed clears.

## ADAPTIVE CRUISE CONTROL AUTOMATIC CANCELLATION

The system may cancel if:

- The tires lose traction.
- You apply the parking brake.

The system may cancel and set the parking brake if:

- You unbuckle the seatbelt and open the driver door after adaptive cruise control stops your vehicle.
- Adaptive cruise control holds your vehicle at a stop continuously for more than three minutes.

The system may deactivate or prevent activating when requested if:

- The vehicle has a blocked sensor.
- The brake temperature is too high.
- There is a failure in the system or a related system.

## SETTING THE ADAPTIVE CRUISE CONTROL SPEED



**WARNING:** When you are going downhill, your vehicle speed could increase above the set speed. The system does not apply the brakes.

Drive to the speed you prefer.



Press either button to set the current speed.



Take your foot off the accelerator pedal.

The indicator, current gap setting and set speed appear in the instrument cluster display when initially activating adaptive cruise control.



After a few seconds, the graphic in the instrument cluster display changes to show that adaptive cruise control is active.



# Adaptive Cruise Control



A vehicle image illuminates if there is a vehicle detected in front of you.

**Note:** When adaptive cruise control is active, the speedometer can vary slightly from the set speed displayed in the instrument cluster display.

## Setting the Adaptive Cruise Speed from a Complete Stop



Press the SET+ or SET- buttons while keeping the brake pedal fully depressed.



The set speed adjusts to 20 km/h when in metric units or 15 mph when in imperial units.

The indicator, current gap setting and set speed appear in the instrument cluster display.

**Note:** The system activates from a complete stop only when it detects a lead vehicle in close proximity.

## Manually Changing the Set Speed



Press the button to increase the set speed in small increments.

Press and hold the button to

increase the set speed in large increments. Release the button when the set speed is equal to the desired speed.



Press the button to decrease the set speed in small increments.

Press and hold the button to

decrease the set speed in large increments. Release the button when the set speed is equal to the desired speed.

You can also press the accelerator or brake pedal until you reach the speed you prefer. Press either button to select the current speed as the set speed.

The system could apply the brakes to slow the vehicle to the new set speed. The set speed continuously displays in the instrument cluster display when the system is active.

## SETTING THE ADAPTIVE CRUISE CONTROL GAP

You can decrease or increase the distance between your vehicle and the vehicle in front by pressing the gap control.



Press button to increase the gap setting.

# Adaptive Cruise Control



Press the button to decrease the gap setting.



## Adaptive Cruise Control Gap Settings

Graphic Display, Bars Indicated Between Vehicles	Gap Distance	Dynamic Behavior
1	Closest	Sport
2	Close	Normal
3	Medium	Normal
4	Far	Comfort

Each time you switch the system on, it selects the last chosen gap setting.

## Following a Vehicle

When a vehicle ahead of you enters the same lane or a slower vehicle is ahead in the same lane, the vehicle speed adjusts to maintain the gap setting.

**Note:** When you are following a vehicle and you switch on a turn signal lamp, adaptive cruise control may provide a small, temporary acceleration to help you pass.

Your vehicle maintains a consistent gap from the vehicle ahead until:

- The vehicle in front of you accelerates to a speed above the set speed.
- The vehicle in front of you moves out of the lane you are in.
- You set a new gap distance.

The system applies the brakes to slow down your vehicle to maintain a safe gap distance from the vehicle in front of you. The system only applies limited braking. You can override the system by applying the brakes.

**Note:** The brakes may emit noise when applied by the system.

If the system determines that its maximum braking level is not sufficient, an audible warning sounds, a message appears in the instrument cluster display and an indicator flashes when the system continues to brake. Take immediate action.

The selected gap appears in the instrument cluster display as shown by the bars in the image.

**Note:** The gap setting is time dependent and therefore, the distance adjusts with your vehicle speed.

**Note:** It is your responsibility to select a gap appropriate to the driving conditions.

# Adaptive Cruise Control

## CANCELING THE SET SPEED

**CNL**

Press the button or tap the brake pedal.

The set speed does not erase.

## RESUMING THE SET SPEED

**RES**

Press the button.

The vehicle speed returns to the previously set speed and gap setting. The set speed displays continuously in the instrument cluster display when the system is active.

**Note:** Only use resume if you are aware of the set speed and intend to return to it.

## Resuming the Set Speed from a Complete Stop (If Equipped)

If your vehicle follows a vehicle to a complete stop and remains stationary for less than a few seconds, your vehicle accelerates from a stationary position to follow the vehicle ahead.

If your vehicle follows a vehicle to a complete stop and remains stationary for more than a few seconds, an indicator and message displays.

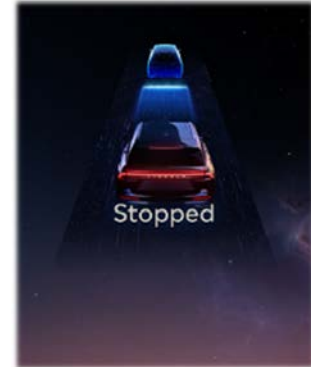

Message	Details
Stopped	Cruise control does not resume automatically when this display is active.
Press button to resume	If the lead vehicle begins to move, you are prompted to press the resume button.

# Adaptive Cruise Control

Message	Details
	Press and release the button or use the accelerator pedal to resume following the lead vehicle.
Auto-Resume	Displays when on a limited access highway after following a vehicle to a complete stop. In this situation, your vehicle resumes following the lead vehicle without a button press or pressing the accelerator pedal. The system can remain in auto-resume state for approximately 30 seconds, after which it no longer automatically resumes.

## OVERRIDING THE SET SPEED



**WARNING:** If you override the system by pressing the accelerator pedal, it does not automatically apply the brakes to maintain a gap from any vehicle ahead.

When you press the accelerator pedal, you override the set speed and gap distance.

Use the accelerator pedal to intentionally exceed the set speed limit.

When you override the system, the set speed icon changes to gray and the leading vehicle icon does not appear in the instrument cluster display.

The system resumes operation when you release the accelerator pedal. The vehicle speed decreases to the set speed, or a lower speed if following a slower vehicle.

## ADAPTIVE CRUISE CONTROL INDICATORS



Illuminates when you switch adaptive cruise control on. The color of the indicator changes to indicate the system status.

White indicates the system is on but inactive.

Blue indicates that you set the speed and the system is active.

## SWITCHING FROM ADAPTIVE CRUISE CONTROL TO CRUISE CONTROL



**WARNING:** Normal cruise control will not brake when your vehicle is approaching slower vehicles. Always be aware of which mode you have selected and apply the brakes when necessary.

# Adaptive Cruise Control

1. From the settings menu, press Driver Assistance. See **Center Display** (page 468).
2. Press Cruise Control.
3. Press Normal Cruise Control.



The cruise control indicator replaces the adaptive cruise control indicator if you select normal cruise control. The gap setting does not display, and the system does not respond to lead vehicles. Automatic braking remains active to maintain set speed. The system remembers the last setting when you start your vehicle.

## LANE CENTERING

### HOW DOES LANE CENTERING WORK

Adaptive cruise control with lane centering uses the vehicle's front radar sensor and front windshield camera sensor, together with the steering sensor to operate.

Using these sensors, the system applies continuous steering assistance towards driving in the middle of the lane you choose on highway roads.

**Note:** *The gap setting for adaptive cruise control with lane centering, operates in the same way as normal adaptive cruise control.*

## LANE CENTERING PRECAUTIONS



**WARNING:** Do not use the system when towing a trailer or when the vehicle is loaded to near or over maximum payload. Failure to follow this instruction could result in the loss of control of your vehicle, personal injury or death.



**WARNING:** Do not use the system if any changes or modifications to the steering, suspension system or wheels and tires have been made. Any changes or modifications to the steering, suspension system or wheels and tires could affect the functionality and performance of the system. Failure to follow this instruction could result in the loss of control of your vehicle, personal injury or death.

Adaptive cruise control precautions apply to lane centering unless stated otherwise or contradicted by a lane centering precaution. See **Adaptive Cruise Control Precautions** (page 264).

## LANE CENTERING REQUIREMENTS

You must keep your hands on the steering wheel at all times.

# Adaptive Cruise Control

Lane centering only activates when all of the following occur:

- Adaptive cruise control with lane centering is enabled in the touchscreen. See **Switching Lane Centering On and Off** (page 275).
- You have adaptive cruise control with stop and go enabled and set.
- The steering sensor detects your hands on the steering wheel.
- The system detects both lane markings when driving on a straight road.
- Your vehicle is initially centered in the lane between two visible line markings.

**Note:** *If the system does not detect valid lane line markings, the system remains in standby until valid line markings are available.*

**Note:** *If the system does not detect your hands on the steering wheel, apply a slight force to the steering wheel.*

## LANE CENTERING LIMITATIONS

Adaptive cruise control limitations apply to lane centering unless stated otherwise or contradicted by a lane centering limitation. See **Adaptive Cruise Control Limitations** (page 265).

Lane centering may not correctly operate in any of the following conditions:

- The lane width is too narrow or wide.
- The curve in the road is too sharp.
- The system does not detect the minimum required lane markings or when lanes merge or split.
- When the required steering effort to maintain lane center exceeds the lane centering system limit.
- When driving in areas that are under construction or when road work is in progress.
- If the front windshield camera and/or the front radar are blocked.
- When using a spare tire.

- Inclement weather conditions including, but not limited to, high wind, heavy rain, and fog.
- Driving into direct sunlight and/or low light conditions.
- When modification to the steering system has been made, including alterations to the steering wheel.
- When towing a trailer.
- When the vehicle is loaded to near or maximum payload. See **Load Carrying** (page 328).

See **Lane Centering Precautions** (page 273).

**Note:** *System operation may also be limited under snow, heavy rain, or road spray conditions.*

**Note:** *The system's steering assistance is limited and may not have sufficient effort for all driving situations and/or conditions, such as driving through sharp curves or driving through curves at high speeds.*

# Adaptive Cruise Control

## SWITCHING LANE CENTERING ON AND OFF

You must keep your hands on the steering wheel at all times.

The controls are on the steering wheel.



Press the button.

The indicator appears in the instrument cluster. When the lane centering system is on, the color of the indicator changes to indicate the system status.

You can override the system at any time by steering your vehicle.

**Note:** *The lane centering requirements must be met before you can enable the feature. See **Lane Centering Requirements** (page 273).*

### Enabling and Disabling Lane Centering

1. From the settings menu, press Driver Assistance. See **Center Display** (page 468).
2. Press Cruise Control.

3. Press Adaptive Cruise Control.
4. Switch Lane Centering on or off.

## LANE CENTERING ALERTS

You must keep your hands on the steering wheel at all times.

When the system is active and detects no steering activity for a period of time, the system alerts you to put your hands on the steering wheel. If you do not react appropriately to the warnings the adaptive cruise control with lane centering system cancels and slows your vehicle down to idle speeds while maintaining steering control. See **Lane Centering Automatic Cancellation** (page 275).

The system also alerts you if your vehicle crosses lane line markings without detected steering activity.

**Note:** *For keep hands on the wheel alert, the system may not detect a light grip or touch on the steering wheel. A slight steering wheel input may be required to cancel the message.*

## LANE CENTERING AUTOMATIC CANCELLATION

When an external condition cancels the system, and your hands are on the steering wheel, a tone sounds and a message appears in the instrument cluster display.

When an external condition cancels the system, and your hands are not on the steering wheel, the system immediately alerts you to take control of the vehicle. If this alert is ignored, the system slows the vehicle while maintaining steering assistance when lane markings are available. When no lane markings are available, the vehicle comes to a stop.



If your vehicle starts to slow down after system cancellation, you must take full control of the vehicle. To re-enable adaptive cruise control with lane centering after cancellation, press and release the resume button.

Automatic cancellation can also occur if:

- The lane becomes too wide or narrow.
- The system cannot detect valid lane markings.

# Adaptive Cruise Control

- Lane markings cross over one another.
- The curve of the road is too sharp.

**Note:** *If your vehicle slows down due to your inactivity twice within a key cycle, the system disables. To reset the system, when the vehicle is stationary, return the gear selector to park (P) and turn the vehicle off. Then, restart the vehicle with your foot on the brake pedal.*

## LANE CENTERING MANUAL CANCELLATION

When you perform the following actions, adaptive cruise control with lane centering will cancel:

- The brake pedal is pressed.
- Adaptive cruise control button on the steering wheel is switched off.

The lane centering system is momentarily suppressed when either of the following actions are performed:

- Turn signal indicator is latched or tapped.
- You steer the vehicle out of lane.

## LANE CENTERING INDICATORS



Illuminates when you switch lane centering on. The color of the indicator changes to indicate the system status.

Gray status indicates the system is on but in standby mode.

Green status indicates the system is enabled and applying steering assistance to keep the vehicle in the center of the lane.

Amber status with an audible tone, that then changes to gray status, indicates a system automatic cancellation.

## LANE CENTERING – TROUBLESHOOTING

## LANE CENTERING – INFORMATION MESSAGES

**Note:** *Depending on your vehicle options and instrument cluster type, some messages can appear different or not at all.*



# Adaptive Cruise Control

---

<b>Message</b>	<b>Details</b>
Keep Hands on Steering Wheel	You must return your hands to the steering wheel and provide steering input to cancel the message.
Lane Centering Assist Not Available	Lane centering is currently not available, due to conditions that prevent the system from becoming active. To reset the system, when the vehicle is stationary, return the gear selector to park (P) and turn the vehicle off. Then, restart the vehicle with your foot on the brake pedal.
Resume Control	Adaptive cruise control with lane centering is about to cancel. You must immediately take full control of the vehicle.
Press Accelerator Pedal to Resume	Adaptive cruise control with lane centering is in standby mode. When safe to do so, you can resume adaptive cruise control with lane centering by applying pressure on the accelerator pedal. Alternatively, you can also re-enable adaptive cruise control with lane centering by pressing the resume button on the steering wheel.

# Adaptive Cruise Control

## PREDICTIVE SPEED ASSIST

### HOW DOES PREDICTIVE SPEED ASSIST WORK

Predictive Speed Assist works with adaptive cruise control and adjusts the vehicle speed to the road geometry and to the speed limit detected by the speed sign recognition system. As the system identifies curves and highway exits, the vehicle speed temporarily decreases ahead of and during the changing road geometry. When passing new speed signs, the set speed updates. See **Predictive Speed Assist Precautions** (page 278).

There are limitations that affect the accuracy of the speed sign recognition system and its ability to determine the current speed limit. Predictive speed assist and its ability to determine the current speed limit shares these limitations. See **Speed Sign Recognition** (page 322).

**Note:** *The adaptive cruise control gap setting operates normally when the feature is enabled.*

## PREDICTIVE SPEED ASSIST PRECAUTIONS



**WARNING:** You are responsible for controlling your vehicle at all times. The system is designed to be an aid and does not relieve you of your responsibility to drive with due care and attention. Failure to follow this instruction could result in the loss of control of your vehicle, personal injury or death.



**WARNING:** Pay close attention to changing road conditions. You may need to override the system by pressing the brake or accelerator pedal if the adjusted speed becomes higher or lower than necessary.



**WARNING:** The system only provides limited braking. Your vehicle may not always decelerate quickly enough to avoid a crash without driver intervention. Apply the brakes when necessary.



**WARNING:** The system does not activate the turn signal.

Adaptive cruise control precautions apply to predictive speed assist unless stated otherwise or contradicted by a predictive speed assist precaution. See **Adaptive Cruise Control Precautions** (page 264).

The system only applies limited braking. You can override the system with the accelerator pedal or cancel the system by applying the brakes.

The system may adapt to various factors such as time of day, lane width. This could influence speed adjustments and accelerations.

The system may adapt to various drive modes. See **Drive Mode Control** (page 293). This could influence speed adjustments and accelerations.

**Note:** *The system does not activate the turn signal automatically.*

# Adaptive Cruise Control

## PREDICTIVE SPEED ASSIST LIMITATIONS



**WARNING:** The system may not always adjust vehicle speed in certain road or weather conditions such as crossing traffic, yield or stop signs, right of way, traffic lights, speed bumps, rain, snow, fog. You must always apply the brake or accelerator pedal when necessary.

The road geometry and speed limit information provided by the navigation map data could be inaccurate or out of date.

The system may not detect and read speed limit signs with conditional information, for example, when a sign is flashing, during specific time ranges, or when children are present.

**Note:** *The system does not set the vehicle speed to speed limits shown with a supplementary traffic sign.*

Under certain conditions, the system may not adjust the vehicle speed until after your vehicle passes the speed limit.

Detection of road geometry operates only where related information is available. Road geometry information may not be available in some areas.

## SWITCHING PREDICTIVE SPEED ASSIST MODE ON AND OFF

1. From the settings menu, press Driver Assistance. See **Center Display** (page 468).
2. Press Cruise Control.
3. Press Adaptive Cruise Control.
4. Switch Predictive Speed Assist on or off.

## ADJUSTING THE SET SPEED TOLERANCE

1. From the settings menu, press Driver Assistance. See **Center Display** (page 468).
2. Press Cruise Control.
3. Press Adaptive Cruise Control.
4. Switch Predictive Speed Assist on.
5. Press Tolerance.

6. Adjust the slider to set the tolerance.

**Note:** *You can set tolerance for vehicle speed adjustment based on speed sign recognition only.*

## PREDICTIVE SPEED ASSIST ALERTS

If the speed sign recognition system detects a speed limit below the minimum adaptive cruise control set speed, a tone sounds and the system returns to standby mode.

## PREDICTIVE SPEED ASSIST INDICATORS

A blue marker around the speed sign and a blue arrow next to the set speed indicates that the system is active.

# Adaptive Cruise Control

## Speed sign indicator



When the system detects a new speed sign, a gray indicator appears above the set speed while the system adjusts the vehicle speed to the speed limit. When the speed limit is reached, the set speed updates and the gray indicator disappears.

## Road geometry indicator

When the system detects a curve or highway exit, the vehicle starts to decelerate, and the indicator appears and changes color.

## Road geometry indicator symbols



Left curve.



Right curve.

# Adaptive Cruise Control

---

## PREDICTIVE SPEED ASSIST – TROUBLESHOOTING

### PREDICTIVE SPEED ASSIST – INFORMATION MESSAGES

Message	Details
Adaptive Cruise Control Speed Sign Recognition Not Available	Navigation system based speed limit information is not available. If the message continues to appear, have your vehicle checked as soon as possible.
Driver Resume Control	The system is going to cancel and you must take control.

### ADAPTIVE CRUISE CONTROL – TROUBLESHOOTING

### ADAPTIVE CRUISE CONTROL – INFORMATION MESSAGES

**Note:** Depending on your vehicle options and instrument cluster type, not all messages display or are available.

**Note:** The system could abbreviate or shorten certain messages depending upon which cluster type you have.

# Adaptive Cruise Control

<b>Message</b>	<b>Details</b>
Adaptive Cruise Malfunction	A malfunction is preventing the adaptive cruise from engaging.
Front Sensor Not Aligned	Contact an authorized dealer to have the radar checked for proper coverage and operation.
Adaptive Cruise Not Available	Conditions exist preventing the system from being available.
Adaptive Cruise Not Available Sensor Blocked See Manual	You have a blocked radar because of poor radar visibility due to inclement weather or ice, mud, or water in front of the sensor. You can typically clean the sensor to resolve this issue. Due to the nature of sensor technology, it is possible to get a blockage warning with no actual block. This happens, for example, when driving in sparse rural or desert environments. A false blocked condition either self clears, or clears after you restart your vehicle.
Normal Cruise Active Adaptive Braking Off	You have selected normal cruise control. The system does not brake or react to traffic.
Adaptive Cruise - Driver Resume Control	Displays when the adaptive cruise control is going to cancel and you must take control.
Adaptive Cruise Speed Too Low to Activate	Displays when the vehicle speed is too slow to activate the adaptive cruise control and there is no lead vehicle in range.

# Lincoln BlueCruise

## WHAT IS BLUECRUISE

BlueCruise keeps your vehicle centered in the lane and offers a hands-free driving mode in certain situations when using adaptive cruise control.

## HOW DOES BLUECRUISE WORK

BlueCruise uses cameras to monitor your vehicle position within a lane and applies steering support to keep your vehicle centered in the lane.

Using the cameras and location information, BlueCruise allows you to remove your hands from the steering wheel and offers a hands-free driving mode in certain areas.

When active, BlueCruise uses a driver facing camera and infrared lighting to monitor your eyes and head position to detect if you are distracted. If the system determines you are distracted, it alerts you to return your eyes to the road.

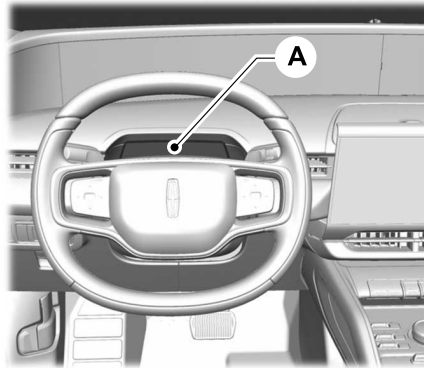



A Lighting and camera area.

**Note:** When BlueCruise is active, in certain crash or near crash-like situations, such as an air bag deployment or hitting a road obstacle, camera data may record through the vehicle event data recorder. See **Event Data** (page 26).

**Note:** No data records under normal driving conditions.

## BLUECRUISE PRECAUTIONS

 **WARNING:** You are responsible for keeping your eyes on the road at all times. The system is designed to be an aid and does not relieve you of your responsibility to drive with due care and attention. Failure to follow this instruction could result in the loss of control of your vehicle, personal injury or death.

 **WARNING:** You are responsible for controlling your vehicle at all times. The system is designed to be an aid and does not relieve you of your responsibility to drive with due care and attention. Failure to follow this instruction could result in the loss of control of your vehicle, personal injury or death.

 **WARNING:** Do not use the system when towing a trailer. Failure to follow this instruction could result in the loss of control of your vehicle, personal injury or death.

# Lincoln BlueCruise

 **WARNING:** Obstructions to the driver facing camera or infrared lighting could prevent the system from properly operating. Keep the camera and lighting areas free from obstruction. Failure to follow this instruction could result in the loss of control of your vehicle, personal injury or death.

 **WARNING:** Do not use the system if any changes or modifications to the steering wheel have been made. Any changes or modifications to the steering wheel could affect the functionality or performance of the system. Failure to follow this instruction could result in the loss of control of your vehicle, personal injury or death.

 **WARNING:** The system may not function if the sensor is blocked.

 **WARNING:** Pay close attention to changing road conditions such as entering or leaving a highway, on roads with intersections or roundabouts, roads without visible lanes of travel, roads that are unpaved, or steep slopes, railroad crossings, pedestrian crossings, and school zones. Failure to follow this instruction could result in the loss of control of your vehicle, personal injury or death.

 **WARNING:** The system is not a crash warning or avoidance system.

 **WARNING:** Large contrasts in outside lighting can limit sensor performance.

 **WARNING:** The system attempts to keep your vehicle in the center of the lane as well as maintain speed and gap control. The system may not be able to perform these tasks in all situations. Do not use the system in complex or uncertain driving conditions. Failure to follow this instruction could result in the loss of control of your vehicle, personal injury or death.

 **WARNING:** Your vehicle could drift out of the lane of travel. Always be prepared to manually steer your vehicle. Failure to follow this instruction could result in the loss of control of your vehicle, personal injury or death.

 **WARNING:** The system will not operate if the sensor cannot track the road lane markings.

## BLUECRUISE REQUIREMENTS

BlueCruise only activates when all of the following occur:

- BlueCruise service plan is active. See Lincoln.com (<https://www.lincoln.com/connectedservices/>) or the Lincoln Way App for details.
- Modem is enabled. See **Connecting the Vehicle to a Mobile Network** (page 456).
- BlueCruise is enabled in your center display screen. See **BlueCruise Settings** (page 285).



# Lincoln BlueCruise

- Adaptive cruise control is on.
- The system detects both lane markings.
- Your hands are on the steering wheel.
- Your eyes are on the road.

**Note:** For hands-free mode to work, your vehicle must be on certain limited access divided freeways.

**Note:** The system may require updated software for hands-free mode. See **Vehicle Software Updates** (page 485).

**Note:** Without an active BlueCruise subscription, your vehicle is still capable of lane centering. This system requires you to keep your hands on the steering wheel at all times. See **Lane Centering Requirements** (page 273).

## BLUECRUISE LIMITATIONS

Any of the following conditions could result in BlueCruise not correctly operating:

- You do not have your vehicle centered in the lane.
- The lane is too narrow or too wide.

- The system does not detect at least one lane marking or when lanes merge or split.
- You are applying a low amount of steering input.
- You are using the system in areas under construction.
- If you make any aftermarket modifications to the steering system.
- You are using a spare tire.

The driver-facing camera may not operate correctly due to any of the following:

- You have a pre-existing eye condition, such as an eye misalignment, or have had eye surgery.
- You cover your facial features by a mask, hat or other items.
- The lighting conditions change significantly.
- You are not in the field of view of the camera.
- You position or tilt yourself to one side.

- You are moving around extensively.
- You are wearing glasses or sunglasses that are too dark or reflective.

**Note:** The system has limited steering assistance and may not be sufficient for all driving situations.

**Note:** In exceptional conditions, such as inclement weather or direct sunlight, the system could deviate from the center line.

**Note:** The information provided by the navigation map data could be inaccurate or out of date.

## BLUECRUISE SETTINGS

### Enabling BlueCruise

1. From the settings menu, press Driver Assistance. See **Center Display** (page 468).
2. Press Cruise Control.
3. Press Adaptive Cruise Control.
4. Press Lane Centering With Hands Free.

# Lincoln BlueCruise

## Enabling Activation Prompts

1. From the settings menu, press Driver Assistance. See **Center Display** (page 468).
2. Press Cruise Control.
3. Press Adaptive Cruise Control.
4. Press Activation Prompts.

## SWITCHING BLUECRUISE ON AND OFF

### Switching BlueCruise On

The controls are on the steering wheel.

### Using Activation Prompts



When the prompt appears, press the button to switch BlueCruise on.

The indicator appears in the instrument cluster. When the system is on, the color of the indicator changes to indicate the system status.

**Note:** *You must enable activation prompts in the touchscreen.*

## Using Steering Wheel Controls



Using the adaptive cruise control and lane keeping buttons, make sure both systems are active.



BlueCruise activates.

## Switching BlueCruise Off



Press either the lane keeping or adaptive cruise control button when system is active or in standby mode.



BlueCruise turns off through each ignition cycle.

## BLUECRUISE ALERTS

When BlueCruise is providing hands-on driving or transitioning to hands-on driving from hands-free driving and detects no steering activity for a certain period of time, the system alerts you with a message in the instrument cluster to put your hands on the steering wheel. After the first alert, the system alerts you with a message in the instrument cluster and an audible warning.

When BlueCruise is providing hands-on or hands-free driving and detects you are not looking at the road for a certain period of time, the system alerts you to return your eyes to the road. Depending on where you are looking, the alert can be a message in the instrument cluster and an audible warning.

If you do not react to the warnings, BlueCruise cancels, quickly activates and releases the brakes, and slows your vehicle down to low speeds while maintaining steering control.

# Lincoln BlueCruise

If your vehicle slows down and you resume control, a message appears to prompt you to press the accelerator pedal to allow the system to resume.

**Note:** *If the system detects repeated inactivity, it disables until the next key cycle.*

## BLUECRUISE AUTOMATIC CANCELLATION

When an external condition cancels BlueCruise, for example, no lane markings available, a tone sounds and a message appears in the instrument cluster.

**RES** If your vehicle starts to slow down, you must take control of steering and press and release the button to reactivate BlueCruise.

System cancellation can also occur if:

- The lane becomes too narrow.
- The system cannot detect valid lane markings.

- Lane markings cross.
- Your eyes are not on the road or your hands are not on the steering wheel.

If you have your hands on the steering wheel and your eyes are on the road when the feature is active and a cancellation occurs, the system sounds a tone and displays a cancelled graphic in the instrument cluster.

If you are not paying attention to the road or your hands are not on the steering wheel and a cancellation occurs, the system displays a message and a tone sounds until you resume control. If you do not resume control in time, BlueCruise quickly activates and releases the brakes, and slows your vehicle to low speeds while maintaining steering control. If your vehicle slows down and you resume control, a message appears to prompt you to press the accelerator pedal to allow the system to resume.

**Note:** *The system disables until the vehicle is turned off and back on if it detects repeated inactivity.*

## BLUECRUISE INDICATORS



When on, the color of the indicator changes to indicate the status.

Gray indicates BlueCruise is on but inactive.

Green indicates BlueCruise is active and applying continuous steering support.

Blue indicates BlueCruise is active and hands-free driving mode is available.

## Hands-On Driving Support Available



# Lincoln BlueCruise

The graphic in the cluster changes to a wheel with hands on it indicating hands-on driving mode is active.

When this indicator is present, you must keep your hands on the steering wheel.

## Hands-Free Driving Support Available

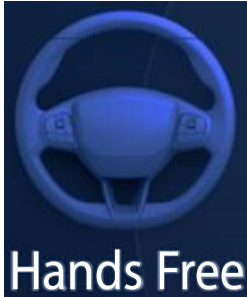

The graphic in the cluster changes to a wheel without hands on it indicating hands-free driving mode is available.

When this indicator is present, you can remove your hands from the steering wheel.

## LANE CHANGE ASSIST

### HOW DOES LANE CHANGE ASSIST WORK



Lane change assist can automatically perform a single lane change when you request the lane change using the turn signal lever. This feature is available down to 40 mph (65 km/h).

**WARNING:** Do not use the lane change assist system as a replacement for using the interior and exterior mirrors or looking over your shoulder before changing lanes. The lane change assist system is not a replacement for careful driving.

1. Make sure the lane you are requesting is clear of traffic or obstacles.
2. Tap or latch the lever in the direction of your planned lane change.
3. Once the lane change is complete, move the turn signal lever back to the middle position if necessary.

**Note:** When using lane change assist you can tap or latch the lever.

### Lane Change Suggestion

If you are approaching or have been following a slower moving vehicle, the system may suggest a lane change to pass that vehicle using an available passing lane.

# Lincoln BlueCruise

## LANE CHANGE ASSIST LIMITATIONS

Lane change assist will not perform the requested maneuver if traffic is identified in the selected lane.

## SWITCHING LANE CHANGE ASSIST ON AND OFF

1. From the settings menu, press Driver Assistance. See **Center Display** (page 468).
2. Press Cruise Control.

3. Press Lane Centering Assist to toggle the system on and off.

## LANE CHANGE ASSIST CANCELLATION

To cancel lane change assist, manually steer your vehicle or return the turn signal lever to the middle position.

## LANE CHANGE ASSIST – TROUBLESHOOTING

## LANE CHANGE ASSIST – INFORMATION MESSAGES

Message	Details
Lane is busy	The lane you have selected to enter has a vehicle or obstacle.
No lane detected	A lane is not recognized or available to perform the requested maneuver.
Driver canceled	The driver has manually overridden the lane change.
Changing lanes	The requested lane change is being performed.
Lane change suggested	If desired, press the turn signal lever in the direction indicated by the lane change suggestion to initiate the lane change.

# Lincoln BlueCruise

**Note:** The instrument cluster display may abbreviate or shorten certain messages.

## IN-LANE REPOSITIONING

### HOW DOES IN-LANE REPOSITIONING WORK

BlueCruise with in-lane repositioning uses the vehicle's front and corner radar sensors together with the front windshield camera sensor to operate.

Using these sensors, the system automatically adjusts your vehicle's position in the lane based on the current driving situation.

**Note:** In-lane repositioning is active only when BlueCruise is enabled while traveling on divided highways and when any of the following occur:

- Passing or being passed by adjacent lane vehicles in close proximity.
- In a curve.
- Driving in outer lanes.

**Note:** In certain situations, the vehicle may bias without showing the indicators.

**Note:** Keep the front of your vehicle free of dirt, metal badges or objects. Vehicle front protectors, aftermarket lights, additional paint or plastic coatings could also degrade sensor performance.

**Note:** The radar sensor has a limited field of view. It may not detect vehicles at all or detect a vehicle later than expected in some situations.

### SWITCHING IN-LANE REPOSITIONING ON AND OFF

1. From the settings menu, press Driver Assistance. See **Center Display** (page 468).
2. Press Cruise Control.
3. Press Adaptive Cruise Control.
4. Press Lane Centering.
5. Press In-Lane Repositioning to toggle the system on or off.

## IN-LANE REPOSITIONING INDICATORS



Biased towards right-hand side of the lane.

# Lincoln BlueCruise



Biased towards left-hand side of the lane.

## **BLUECRUISE – TROUBLESHOOTING**

### **BLUECRUISE – INFORMATION MESSAGES**

Depending on your vehicle options and instrument cluster type, not all messages display or are available.

<b>Message</b>	<b>Details</b>
Keep Hands on Steering Wheel	Make sure you return your hands to the steering wheel and provide steering input.
Resume Control	The system is going to cancel and you must take control.
Watch the Road	Return your attention to the road.
BlueCruise not available	Conditions exist preventing the system from being available. If the message continues to display, have the system checked as soon as possible.

# Lincoln BlueCruise

Message	Details
Press Accelerator Pedal to Resume	Press the accelerator pedal and follow the prompts.
Driver monitor camera cannot detect face See manual	Make sure your facial features are visible and in the field of view of the driver facing camera.
Driver monitor camera is blocked See manual	Make sure your hands, arms or other objects are not obscuring the camera.
Driver monitor camera fault See manual	Conditions exist preventing the system from being available. If the message continues to display, have the system checked as soon as possible.
BlueCruise On Watch the road Be prepared to resume control	BlueCruise is active, keep your attention on the road.
BlueCruise available Press {ICON} to activate	The system is in standby mode, press the button on the steering wheel to activate.

**Note:** *The instrument cluster display may abbreviate or shorten certain messages.*



# Drive Mode Control

## WHAT IS DRIVE MODE CONTROL

This feature connects multiple vehicle systems through a single interface, providing you with enhanced vehicle control and driving dynamics for different driving scenarios, terrains, weather, or various road conditions.

## HOW DOES DRIVE MODE CONTROL WORK

When a drive mode is selected it alters various electrical and mechanical systems within the vehicle to a predetermined configuration. The systems altered and features available will depend on which mode is selected.

**Note:** *The drive mode system reverts to the normal mode each time you start your vehicle. At startup, the system displays a prompt on the instrument cluster display that gives you the option to return to the last drive mode that you chose prior to shutting the vehicle off. If you select yes, the system returns to the last selected drive mode. If you select no or do not make a selection, the system remains in normal mode.*

## SELECTING A DRIVE MODE



Press the drive mode button located on the center console. The first press activates the drive mode selection menu in the display. Subsequent presses change the selected drive mode.

## DRIVE MODES

### CONSERVE



This mode decreases accelerator pedal responsiveness to soften driver inputs and encourage efficient driving. Depending on your vehicle's options, adaptive cruise control is slower to return to the set speed and auto start-stop engages more often. The system decreases air conditioning output to conserve energy when set to auto mode. Use this mode for fuel efficient driving which allows for an extended driving range.

### DEEP CONDITIONS



This mode lowers accelerator pedal responsiveness and delays transmission upshifts for improved vehicle control in low speed off-road environments. The system optimizes the traction and stability controls for improved traction and to help maintain forward momentum through loose deformable

# Drive Mode Control

terrains. Depending on your vehicle's options, the system disables auto-start stop and optimizes the all-wheel drive system for enhanced traction. Use this mode for driving on two-track trails, loose gravel, and mixed uneven terrain.

## EXCITE



This mode increases accelerator pedal responsiveness and holds the transmission in lower gears longer for enhanced acceleration. The system switches the chassis controls to their sport settings. Depending on your vehicle's options, this feature sets the exhaust to a louder tone, inhibits auto-start stop, increases steering torque buildup, and it adjusts the suspension for enhanced driver connectivity and responsive driving dynamics. Use this mode for a sportier and engaging driving experience.

## NORMAL



This mode adjusts all systems to their base settings and balances vehicle performance for all around drivability. Each time you switch your vehicle off it defaults to this mode. Use this mode for everyday driving, such as city and highway routes or commuting.

## SLIPPERY



This mode lowers accelerator pedal responsiveness, adjusts transmission shift points, and optimizes traction and stability controls to help mitigate wheel spin and maintain vehicle control in slick driving conditions. Depending on your vehicle's options, this feature adjusts the all-wheel drive control to provide optimum traction for slippery surfaces. Use this mode for less than ideal road conditions such as snow and ice covered roads or for firm surfaces that are covered with loose or slippery materials.

## DRIVE MODE CONTROL – TROUBLESHOOTING

### DRIVE MODE CONTROL – WARNING LAMPS



Some drive modes reduce traction and stability control performance and the indicator illuminates in the instrument cluster.

**Note:** *The system has diagnostic checks that continuously monitor the system for proper operation. If a mode is unavailable due to a system fault, the drive mode system defaults to normal. When the system defaults to normal, the driveline settings remain the same as prior to the system fault.*

# Drive Mode Control

---

## DRIVE MODE CONTROL – INFORMATION MESSAGES

Message	Details
Drive Mode Not Available	The system is not available. If it is still not available the next time you switch the ignition on, the system has malfunctioned. Have your vehicle checked as soon as possible.

# Drive Mode Control

---

## **DRIVE MODE CONTROL – FREQUENTLY ASKED QUESTIONS**

### **Why did the system default to normal mode?**

- If a mode is unavailable due to a system fault, it defaults to normal mode and the driveline settings remain the same as prior to the system fault.

# Lane Keeping System

## WHAT IS THE LANE KEEPING SYSTEM

The lane keeping system alerts you by providing temporary steering assistance or steering wheel vibration when it detects an unintended lane departure.

## HOW DOES THE LANE KEEPING SYSTEM WORK

The lane keeping system uses a forward looking camera mounted on the windshield to monitor vehicle movement within the travel lane.

When the camera detects a drift out of the travel lane, the lane keeping system alerts the driver by vibrating the steering wheel, or aids the driver by providing a small steering input to move the vehicle back into the travel lane.

The driver can select one of three modes:

- Alert
- Aid
- Alert + Aid

## LANE KEEPING SYSTEM PRECAUTIONS

 **WARNING:** You are responsible for controlling your vehicle at all times. The system is designed to be an aid and does not relieve you of your responsibility to drive with due care and attention. Failure to follow this instruction could result in the loss of control of your vehicle, personal injury or death.

 **WARNING:** The system will not operate if the sensor cannot track the road lane markings.

 **WARNING:** The sensor may incorrectly track lane markings as other structures or objects. This can result in a false or missed warning.

 **WARNING:** In cold and severe weather conditions the system may not function. Rain, snow and spray can all limit sensor performance.

 **WARNING:** The system may not operate properly if the sensor is blocked. Keep the windshield free from obstruction.

 **WARNING:** If damage occurs in the immediate area surrounding the sensor, have your vehicle checked as soon as possible.

 **WARNING:** The system may not correctly operate if your vehicle is fitted with a suspension kit not approved by us.

 **WARNING:** Large contrasts in outside lighting can limit sensor performance.

# Lane Keeping System

## LANE KEEPING SYSTEM LIMITATIONS

The lane keeping system only operates when the vehicle speed is greater than 40 mph (64 km/h).

The system works when the camera can detect at least one lane marking or the edge of the road.

The lane keeping system may not correctly operate in any of the following conditions:

- The lane keeping system does not detect at least one lane marking.
- You switch the turn signal on.
- You apply direct steering, accelerate fast or brake hard.
- The vehicle speed is less than 40 mph (64 km/h).
- The anti-lock brake, stability control or traction control system activates.

- The lane is too narrow.
- Something is obscuring the camera or it is unable to detect the lane markings due to environment, traffic or vehicle conditions.

The lane keeping system may not correct lane positioning in any of the following conditions:

- High winds.
- Uneven road surfaces.
- Heavy or uneven loads.
- Incorrect tire pressure.

## SWITCHING THE LANE KEEPING SYSTEM ON AND OFF



To activate the lane keeping system, press the button on the steering wheel according to the instrument cluster.

To deactivate the lane keeping system, press the button again.

**Note:** When switching the system on or off a message appears in the information display to show the status.

## SWITCHING THE LANE KEEPING SYSTEM MODE

1. From the settings menu, press Driver Assistance. See **Center Display** (page 468).
2. Press Lane-Keeping System.
3. Press Lane-Keeping Mode.
4. Select a mode.

**Note:** The system remembers the last setting when you start your vehicle.

## ALERT MODE

### WHAT IS ALERT MODE

Alert mode vibrates the steering wheel when it detects an unintended lane departure.

# Lane Keeping System

## HOW DOES ALERT MODE WORK

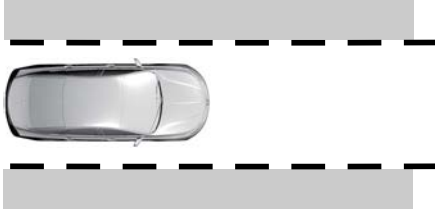

When in alert mode, the lane keeping system alerts you by vibrating the steering wheel. The intensity of the vibration is set through the lane keeping system menu.

## ADJUSTING THE STEERING WHEEL VIBRATION INTENSITY

1. From the settings menu, press Driver Assistance. See **Center Display** (page 468).
2. Press Lane-Keeping System.
3. Press Lane-Keeping Intensity.

4. Select an intensity setting.

## AID MODE

### WHAT IS AID MODE

Aid mode provides temporary steering assistance toward the center of the lane.

### HOW DOES AID MODE WORK

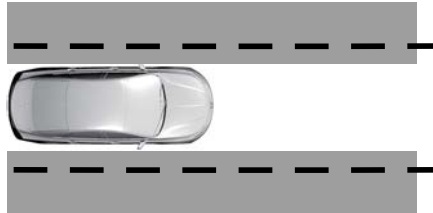

The lane keeping system aids you when an unintentional lane departure occurs. The system provides a small steering input to move the vehicle towards the center of the lane.

## ALERT AND AID MODE

### WHAT IS ALERT AND AID MODE

Alert and aid mode uses multiple features to keep you in your lane. The system first provides a small steering input to bring your vehicle back towards the center of the lane. If your vehicle moves too far from the center of the lane the system alerts you with vibration in the steering wheel.

# Lane Keeping System

## HOW DOES ALERT AND AID MODE WORK

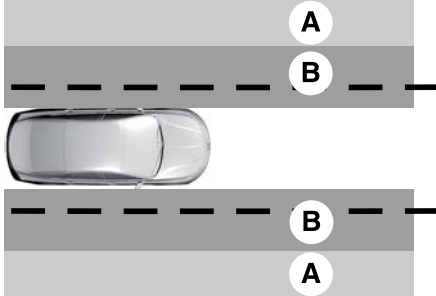

- A Alert.
- B Aid.

The lane keeping system detects a lane departure and provides aid when the vehicle enters **B** and applies the additional alert warning if **A** is entered.

## LANE KEEPING SYSTEM INDICATORS



If you switch the lane keeping system on, a graphic with lane markings appears in the instrument cluster display.

When you switch the system off, the lane marking graphics do not display.

**Note:** *The overhead vehicle graphic may still display if adaptive cruise control is enabled.*

When the lane keeping system is on, the color of the lane markings change to indicate the system's status.

Gray	White	Yellow	Red
Indicates that the system is temporarily unavailable to provide a warning or intervention on the indicated side.	Indicates that the system is available or ready to provide a warning or intervention on the indicated side.	Indicates that the system is providing or has just provided a lane keeping aid intervention.	Indicates that the system is providing or has just provided a lane keeping alert warning.



# Lane Keeping System

## BLIND SPOT ASSIST (IF EQUIPPED)

### WHAT IS BLIND SPOT ASSIST

Blind spot assist is an extension of the lane keeping system.

It may help you identify adjacent vehicles during a lane change.

Blind spot assist provides a blind spot warning and steering assistance to help you become aware of and steer away from vehicles in your blind spot during lane changes.

### HOW DOES BLIND SPOT ASSIST WORK



Activate and deactivate the system using the lane keeping system button on the steering wheel.

During lane changes, the design of the blind spot assist feature detects vehicles in, or approaching, your blind spot and provides a warning, plus steering assistance to direct your vehicle back into your lane.

When active, this system functions with or without the use of direction indicators and hazard flashers.

You must keep your hands on the steering wheel at all times.

### BLIND SPOT ASSIST LIMITATIONS

All system limitations present in the basic lane keeping system also apply to blind spot assist.

Blind spot assist does not function under the following conditions:

- No lane markings are detected.
- One or both rear radar sensors become blocked or faulty.
- Attaching bike or cargo racks could cause false alerts due to obstruction of the sensor.

Blind spot assist may have difficulty detecting hazards under the following conditions:

- If a vehicle is approaching in an adjacent lane at a speed higher than your vehicle.
- Bad weather obstructing the sensors.

# Lane Keeping System

## BLIND SPOT ASSIST INDICATORS

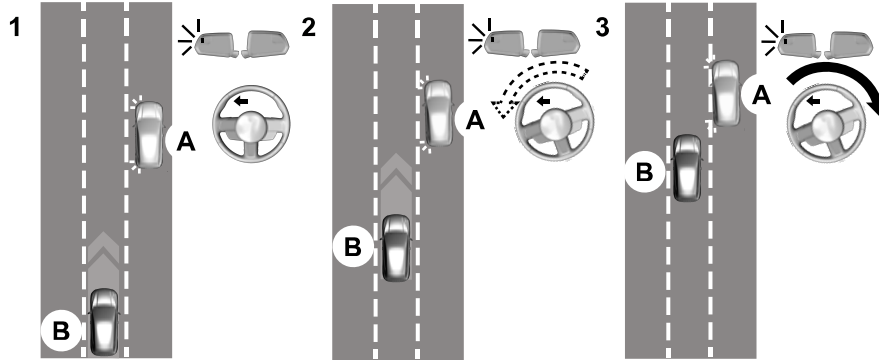

**Diagram 1:** Vehicle A uses its left turn signal preparing to change from the right lane to the middle lane. Vehicle B is already in the middle lane and just entered Vehicle A's blind spot causing the blind spot information system alert indicator to flash on the exterior mirror.

**Diagram 2:** The driver of Vehicle A begins to steer into the center lane not aware of Vehicle B.

**Diagram 3:** Blind spot assist counter steers to help alert the driver of Vehicle A to direct their vehicle back into the right lane to help avoid a possible collision with Vehicle B.

The lane keeping aid warning lamp or yellow lane marking in your instrument cluster display indicate blind spot assist activation. In addition, the blind spot information system alert indicator flashes on the exterior mirror on the same side as the detection. See **Blind Spot Information System** (page 307).

# Lane Keeping System

## Blind Spot Assist Information Messages

Message	Action
Blind Spot Assist Not Available Trailer Attached	Displays if you attach a trailer to your vehicle with the blind spot information system switched off or you have not configured the trailer.
Blind Spot Assist Not Available Side Sensor Blocked	Displays if your blind spot information system sensors are blocked.
Blind Spot Assist System fault	The system has detected a fault that requires service. Have your vehicle checked as soon as possible.
Trailer Brake Module Fault	Lost communication with the trailer module. Blind spot assist is suppressed until the failure is fixed.
Trailer Lighting Module Fault See Manual	Lost communication with the trailer module. Blind spot assist is suppressed until the failure is fixed.
Front Camera Fault Service Required	Front camera fault. Blind spot assist is disabled until the failure is fixed.

# Lane Keeping System

---

## LANE KEEPING SYSTEM – TROUBLESHOOTING

## LANE KEEPING SYSTEM – INFORMATION MESSAGES

Message	Action
Lane-Keeping System Fault Service required	The system has malfunctioned. Have your vehicle checked as soon as possible.
Front Camera Temporarily Not Available	The system has detected a condition that has caused the system to be temporarily unavailable.
Front Camera Low Visibility Clean Screen	The system has detected a condition that requires you to clean the windshield in order for it to operate properly.
Front Camera Fault Service required	The system has malfunctioned. Have your vehicle checked as soon as possible.
Keep Hands on Steering Wheel	The system requests that you keep your hands on the steering wheel.

# Lane Keeping System

## LANE KEEPING SYSTEM – FREQUENTLY ASKED QUESTIONS

<b>Why is the feature not available (lane markings are gray) when I can see the lane markings on the road?</b>
Your vehicle speed is less than 40 mph (64 km/h).
The sun is shining directly into the camera lens.
A quick intentional lane change has occurred.
Your vehicle stays too close to the lane markings for an extended interval of time.
Driving at high speeds in curves.
The last alert warning or aid intervention occurred a short time ago.
Ambiguous lane markings, for example, in construction zones.
Rapid transition from light to dark, or from dark to light.
Sudden offset in lane markings.
ABS or AdvanceTrac™ is active.
There is a camera blockage due to dirt, grime, fog, frost or water on the windshield.
You are driving too close to the vehicle in front of you.
Transitioning between no lane markings to lane markings, or vice versa.
There is standing water on the road.
Faint lane markings, for example, partial yellow lane markings on concrete roads.

# Lane Keeping System

---

<b>Why is the feature not available (lane markings are gray) when I can see the lane markings on the road?</b>
--

Lane width is too narrow or too wide.
---------------------------------------

You have not calibrated the camera after a windshield replacement.
--

Driving on tight or on uneven roads.
--------------------------------------

<b>Why does the vehicle not come back toward the middle of the lane, as expected, in the Aid, or Aid + Alert mode?</b>
--

High cross winds are present.
-------------------------------

There is a large road crown.
------------------------------

Rough roads, grooves or shoulder drop-offs.
---

Heavy, uneven loading of the vehicle or improper tire inflation pressure.
---

You changed the tires or modified the suspension.
---

# Blind Spot Information System

## WHAT IS BLIND SPOT INFORMATION SYSTEM

Blind spot information system detects vehicles that may have entered the blind spot zone.

## HOW DOES BLIND SPOT INFORMATION SYSTEM WORK

Blind spot information system uses sensors on both sides of your vehicle, detecting rearward from the exterior mirrors to approximately 13 ft (4 m) beyond the rear bumper. The detection area extends to approximately 59 ft (18 m) beyond the rear bumper when the vehicle speed is greater than 30 mph (48 km/h) to alert you of faster approaching vehicles.

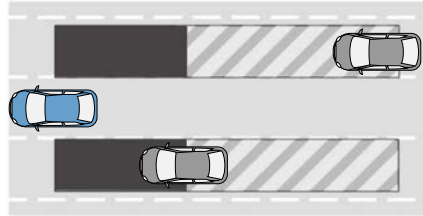

## BLIND SPOT INFORMATION SYSTEM PRECAUTIONS

**WARNING:** Do not use the blind spot information system as a replacement for using the interior and exterior mirrors or looking over your shoulder before changing lanes. The blind spot information system is not a replacement for careful driving.

**WARNING:** The system may not operate properly during severe weather conditions, for example snow, ice, heavy rain and spray. Always drive with due care and attention. Failure to take care may result in a crash.

**Note:** *Blind spot information system does not prevent contact with other vehicles. It does not detect parked vehicles, pedestrians, animals or other infrastructure.*

## BLIND SPOT INFORMATION SYSTEM LIMITATIONS

Blind spot information system does not operate in park (P) or reverse (R).

The system may not alert you if a vehicle quickly passes through the detection zone.

# Blind Spot Information System

## BLIND SPOT INFORMATION SYSTEM REQUIREMENTS

Blind spot information system turns on when all the following occur:

- You start your vehicle.
- You shift into drive (D).
- The vehicle speed is greater than 6 mph (10 km/h).

## SWITCHING BLIND SPOT INFORMATION SYSTEM ON AND OFF

1. From the settings menu, press Driver Assistance. See **Center Display** (page 468).
2. Press Blind Spot Information System.
3. Switch the feature on or off.

When you switch blind spot information system off, a warning lamp illuminates. When you switch the system on or off, the alert indicators flash twice.

**Note:** The system remembers the last setting when you start your vehicle.

To permanently switch the system off, contact an authorized dealer.

## LOCATING THE BLIND SPOT INFORMATION SYSTEM SENSORS

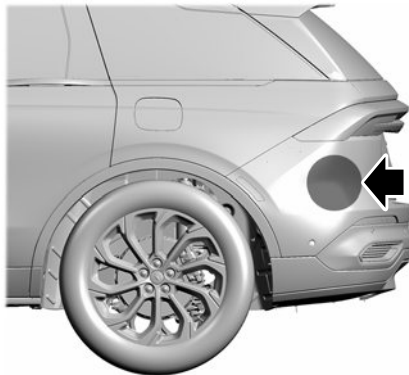

The sensors are above the rear bumper on both sides of your vehicle.

**Note:** Keep the sensors free from snow, ice and large accumulations of dirt. Do not cover the sensors with bumper stickers, repair compound or other objects. Blocked sensors may affect system accuracy.

**Note:** The system may not correctly operate when towing a trailer. For vehicles with a trailer tow module and tow bar approved by us, the system turns off when you attach a trailer. For vehicles with an aftermarket trailer tow module or tow bar, we recommend that you switch the system off when you attach a trailer. To permanently switch the system off, contact an authorized dealer.

**Note:** Bike and cargo racks could cause false alerts due to obstruction of the sensor. We recommend switching the feature off when using a bike or cargo rack.

If the sensors become blocked, a message may appear in the instrument cluster display. The alert indicators remain illuminated, but the system does not alert you.



# Blind Spot Information System

## BLIND SPOT INFORMATION SYSTEM INDICATORS



E355823



When blind spot information system detects a vehicle, an alert indicator illuminates in the exterior mirror on the side the approaching vehicle is coming from. If you turn the turn signal on for that side of your vehicle, the alert indicator flashes.

## BLIND SPOT INFORMATION SYSTEM – TROUBLESHOOTING

### BLIND SPOT INFORMATION SYSTEM – INFORMATION MESSAGES

Message	Action
Blind Spot System Fault	A fault with the system has occurred. Have your vehicle checked as soon as possible.
Blind Spot not available Sensor blocked See manual	Something is blocking the sensors. Clean the sensors.

# Cross Traffic Alert

## WHAT IS CROSS TRAFFIC ALERT

The system alerts you of vehicles approaching from the sides behind your vehicle when you shift into reverse (R).

## HOW DOES CROSS TRAFFIC ALERT WORK

Cross traffic alert detects vehicles that approach at a speed between 4–37 mph (6–60 km/h). Coverage decreases when the sensors are partially, mostly or fully obstructed.

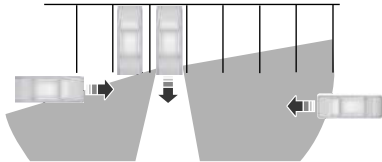

The sensor on the left-hand side is only partially obstructed and zone coverage on the right-hand side is maximized.

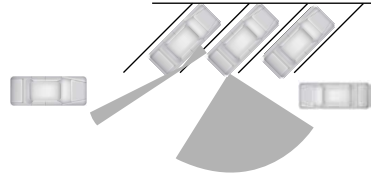

Zone coverage also decreases when parking at narrow angles. The sensor on the left-hand side is mostly obstructed and zone coverage on that side is severely reduced.

**Note:** *Slowly reversing helps increase the coverage area and effectiveness.*

## CROSS TRAFFIC ALERT PRECAUTIONS



**WARNING:** Do not use the cross traffic alert system as a replacement for using the interior and exterior mirrors or looking over your shoulder before reversing out of a parking space. The cross traffic alert system is not a replacement for careful driving.



**WARNING:** The system may not operate properly during severe weather conditions, for example snow, ice, heavy rain and spray. Always drive with due care and attention. Failure to take care may result in a crash.

# Cross Traffic Alert

## CROSS TRAFFIC ALERT LIMITATIONS

Cross traffic alert may not correctly operate when any of the following occur:

- Something is blocking the sensors.
- Adjacently parked vehicles or objects are obstructing the sensors.
- Vehicles approach at speeds less than 4 mph (6 km/h) or greater than 37 mph (60 km/h).
- Your vehicle speed is greater than 7 mph (12 km/h).
- You reverse out of an angled parking space.

## SWITCHING CROSS TRAFFIC ALERT ON AND OFF

1. From the settings menu, press Driver Assistance. See **Center Display** (page 468).
2. Press Cross Traffic Alert.
3. Switch the feature on or off.

When you switch the system on or off, the alert indicators flash twice.

**Note:** The system switches on every time you switch the ignition on.

## LOCATING THE CROSS TRAFFIC ALERT SENSORS

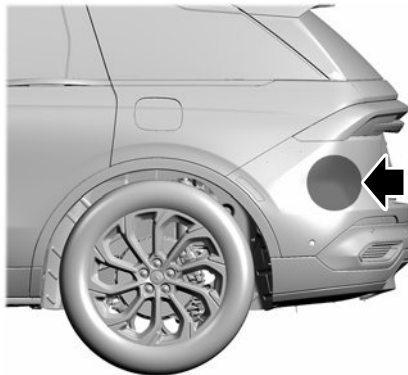

The sensors are above the rear bumper on both sides of your vehicle.

**Note:** Keep the sensors free from snow, ice and large accumulations of dirt.

**Note:** Do not cover the sensors with bumper stickers, repair compound or other objects.

**Note:** Blocked sensors could affect system performance.

If the sensors are blocked, a message may appear in the instrument cluster display when you shift into reverse (R).

## CROSS TRAFFIC ALERT INDICATORS



When the cross traffic alert detects an approaching vehicle, a tone sounds, a warning lamp illuminates in the relevant exterior mirror and arrows appear in the information display to show which side the vehicle is approaching from.

If the system malfunctions, a warning lamp illuminates in the instrument cluster and a message appears in the information display. Have your vehicle checked as soon as possible.

# Cross Traffic Alert

**Note:** *If arrows do not display, a message appears in the information display.*

**Note:** *In some conditions, the system could alert you, even when there is nothing in the detection zone, for example a vehicle passing further away from your vehicle.*

## CROSS TRAFFIC ALERT – TROUBLESHOOTING

### CROSS TRAFFIC ALERT – INFORMATION MESSAGES

Message	Action
Cross Traffic Alert	Displays instead of indication arrows when the system detects a vehicle. Check for approaching traffic.
Cross Traffic Not Available Sensor Blocked See Manual	Indicates blocked cross traffic alert system sensors. Clean the sensors. If the message continues to appear, have your vehicle checked as soon as possible.
Cross Traffic System Fault	The system has malfunctioned. Have your vehicle checked as soon as possible.

# Pre-Collision Assist

## WHAT IS PRE-COLLISION ASSIST

Pre-collision assist detects and warns of approaching hazards in the roadway. The system provides multiple levels of assistance to help avoid a collision if your vehicle is rapidly approaching another stationary vehicle, a vehicle traveling in the same direction as yours, or a pedestrian or cyclist within your driving path.

## HOW DOES PRE-COLLISION ASSIST WORK

The system warns the driver of potential hazards by providing three levels of assistance.



If your vehicle is rapidly approaching potential hazards, the system provides the following levels of functionality:

1. Alert.
2. Brake Support.

3. Automatic Emergency Braking.



**Alert:** When active, a flashing visual warning appears and an audible warning tone sounds.

**Brake Support:** The system is designed to help reduce the impact speed by preparing the brakes for rapid braking. The system does not automatically apply the brakes. If you press the brake pedal, the system could apply additional braking up to maximum braking force, even if you lightly press the brake pedal.

**Automatic Emergency Braking:** Automatic emergency braking may activate if the system determines that a collision is imminent.

**Note:** *If you perceive the pre-collision assist alerts as being too frequent or disturbing, then you can reduce the alert sensitivity. Setting the low sensitivity would result in fewer and later warnings of a potential forward collision. The manufacturer recommends using the high sensitivity setting where possible.*

**Note:** *Automatic emergency braking performance is not affected by the sensitivity setting.*

Each system has various levels of detection capabilities. See **Pre-Collision Assist Limitations** (page 314).

## PRE-COLLISION ASSIST PRECAUTIONS





**WARNING:** You are responsible for controlling your vehicle at all times. The system is designed to be an aid and does not relieve you of your responsibility to drive with due care and attention. Failure to follow this instruction could result in the loss of control of your vehicle, personal injury or death.

# Pre-Collision Assist

 **WARNING:** The system does not detect vehicles moving in a different direction or animals. Apply the brakes when necessary. Failure to follow this instruction could result in the loss of control of your vehicle, personal injury or death.

 **WARNING:** The system does not operate during hard acceleration or steering. Failure to take care may lead to a crash or personal injury.

 **WARNING:** The system may operate with reduced function during cold and inclement weather conditions. Snow, ice, rain, spray and fog can adversely affect the system. Keep the front camera and radar free of snow and ice. Failure to follow this instruction may result in the loss of control of your vehicle, serious personal injury or death.

 **WARNING:** Take additional care if your vehicle is heavily loaded or you are towing a trailer. These conditions could result in reduced performance of this system. Failure to follow this instruction could result in the loss of control of your vehicle, personal injury or death.

 **WARNING:** The system cannot help prevent all crashes. Do not rely on this system to replace driver judgment and the need to maintain a safe distance and speed.

 **WARNING:** In situations where the vehicle camera has limited detection capability, this may reduce system performance. These situations include but are not limited to direct or low sunlight, vehicles at night without tail lights, unconventional vehicle types, pedestrians with complex backgrounds, running

pedestrians, partly obscured pedestrians, or pedestrians that the system cannot distinguish from a group. Failure to take care may result in the loss of control of your vehicle, serious personal injury or death.

## PRE-COLLISION ASSIST LIMITATIONS

Pre-collision assist depends on the detection ability of its camera and sensors. Any obstructions or damage to these areas can limit detection or prevent the system from functioning. See **Locating the Pre-Collision Assist Sensors** (page 316).

The system is active at 3 mph (5 km/h) and above.

**Note:** *Brake support and automatic emergency braking are active up to the maximum speed of the vehicle.*

### Pedestrian Detection Limitations

Pedestrian detection is active at speeds up to 50 mph (80 km/h).

# Pre-Collision Assist

Pedestrian detection operates optimally when detected hazards are clearly identifiable. Certain situations can reduce system performance, examples are; where pedestrians are running, partly obscured, have a complex background, or when the system cannot distinguish them from a group.

## Cyclist Detection Limitations

Cyclist detection is active at speeds up to 50 mph (80 km/h).

Cyclist detection functions optimally when detected hazards are clearly identifiable. The system's detection level may be less in situations where cyclists are moving fast, partly hidden, have a complex background, or the system cannot distinguish the cyclist from a group.

## Intersection Assist (If Equipped)

The pre-collision assist system may operate in a scenario where you are turning across the path of an oncoming vehicle, or with crossing pedestrians and cyclists. Detection of vehicles driving in an oncoming direction is active if your vehicle is driving at speeds up to 19 mph (30 km/h). Detection of crossing pedestrians and cyclists at an intersection is active if your vehicle is driving at speeds up to 19 mph (30 km/h).

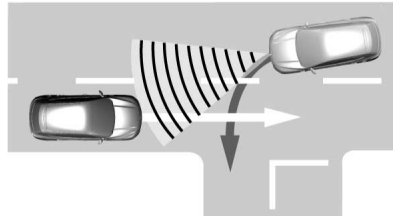

## SWITCHING PRE-COLLISION ASSIST ON AND OFF

You cannot switch the system off.

## Adjusting the Pre-Collision Assist Settings

You can adjust the following settings by using the touchscreen controls in the pre-collision assist menu:

- Change alert and distance alert sensitivity to one of three possible settings.
- Switch distance indication and alert on or off.
- If required, switch automatic emergency braking on or off.
- If required, switch evasive steering assist on or off.

**Note:** *Automatic emergency braking and evasive steering automatically turn on every time you start your vehicle.*

**Note:** *If you switch automatic emergency braking off, evasive steering assist switches off.*

# Pre-Collision Assist

## LOCATING THE PRE-COLLISION ASSIST SENSORS

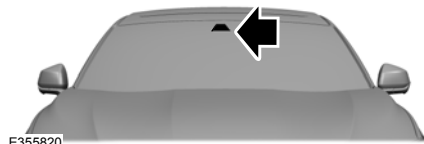

The camera is mounted on the windshield behind the interior mirror.

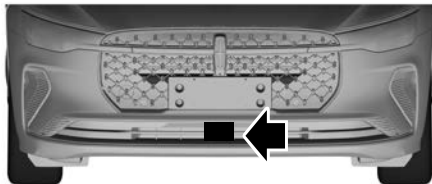

E364223

The radar sensor is in the lower grille.

If a message regarding a blocked sensor or camera appears in the information display, something is obstructing the radar signals or camera images. The radar sensor is behind the fascia cover in the center of the lower grille. With a blocked sensor or camera, the system may not function, or performance may reduce. See **Pre-Collision Assist – Frequently Asked Questions** (page 321).

**Note:** Proper system operation requires a clear view of the road by the camera. Have any windshield damage in the area of the camera's field of view repaired.

**Note:** If something hits the front end of your vehicle or damage occurs and your vehicle has a radar sensor, the radar sensing zone could change. This could cause missed or false vehicle detections. Have your vehicle serviced to have the radar checked for proper coverage and operation.

**Note:** If your vehicle detects excessive heat at the camera or a potential misalignment condition, a message could display in the information display indicating temporary camera unavailability. When operational conditions are correct, the message deactivates. For example, when the ambient temperature around the camera decreases or the camera recalibrates successfully.

## DISTANCE INDICATION

### WHAT IS DISTANCE INDICATION

Distance indication displays the gap between your vehicle and the vehicle ahead of you.

**Note:** The graphic does not display if you switch on cruise control or adaptive cruise control.



# Pre-Collision Assist

---

<b>Vehicle Speed</b>	<b>System Sensitivity</b>	<b>Distance Indicator Color</b>	<b>Distance Gap</b>	<b>Time Gap</b>
62 mph (100 km/h).	Normal.	Blue.	Greater than 82 ft (25 m).	Greater than 0.9 seconds.
		Yellow.	56–82 ft (17–25 m).	0.6-0.9 seconds.
		Red.	Less than 56 ft (17 m).	Less than 0.6 seconds.

# Pre-Collision Assist

## SWITCHING DISTANCE INDICATION ON AND OFF

1. From the settings menu, press Driver Assistance. See **Center Display** (page 468).
2. Press Pre-Collision Assist.
3. Press Distance Indication.
4. Switch the feature on or off.

## DISTANCE INDICATION INDICATOR

The indicator displays the time gap between your vehicle and vehicles traveling in the same direction ahead of you.



## DISTANCE ALERT

### WHAT IS DISTANCE ALERT

The system alerts you with a warning lamp if the distance to the vehicle ahead is small.

**Note:** *The warning lamp does not illuminate if cruise control or adaptive cruise control is active.*

### ADJUSTING THE SENSITIVITY OF DISTANCE ALERT

1. From the settings menu, press Driver Assistance. See **Center Display** (page 468).
2. Press Pre-Collision Assist.
3. Press Alert Sensitivity.

# Pre-Collision Assist

## AUTOMATIC EMERGENCY BRAKING

### WHAT IS AUTOMATIC EMERGENCY BRAKING

Automatic emergency braking may activate if the system determines that a collision is imminent. The system may help to reduce impact damage or avoid the crash completely.

Automatic emergency braking is only available up to certain speeds. See **Pre-Collision Assist Limitations** (page 314).

### SWITCHING AUTOMATIC EMERGENCY BRAKING ON AND OFF

1. From the settings menu, press Driver Assistance. See **Center Display** (page 468).
2. Press Pre-Collision Assist.
3. Press Auto Emergency Braking.
4. Switch the feature on or off.

## EVASIVE STEERING ASSIST

### WHAT IS EVASIVE STEERING ASSIST

If your vehicle is rapidly approaching a road user, evasive steering assist helps you steer around the road user.

After you turn the steering wheel in an attempt to avoid a crash with the road user, the system applies additional steering torque to help you steer around the road user. After you pass the road user, the system applies steering torque when you turn the steering wheel to steer back into the lane. The system deactivates after you fully pass the road user.

**Note:** Road users are defined as obstacles encountered on the road that the system is able to detect. See **Pre-Collision Assist Precautions** (page 313).

## EVASIVE STEERING ASSIST LIMITATIONS

Evasive steering assist only activates when all the following occur:

- Automatic emergency braking and evasive steering assist are on.
- The system detects a road user ahead and starts to apply the brakes.
- You significantly turn the steering wheel to steer around a road user.

**Note:** Evasive steering assist does not automatically steer around a road user. If you do not turn the steering wheel, evasive steering assist does not activate.

### SWITCHING EVASIVE STEERING ASSIST ON AND OFF

1. From the settings menu, press Driver Assistance. See **Center Display** (page 468).
2. Press Pre-Collision Assist.
3. Press Evasive Steering Assist.
4. Switch the feature on or off.

# Pre-Collision Assist

---

**Note:** *If you switch automatic emergency braking off, evasive steering assist turns off.*

**Note:** *Automatic emergency braking and evasive steering assist turn on every time you start your vehicle.*

## PRE-COLLISION ASSIST – TROUBLESHOOTING

### PRE-COLLISION ASSIST – INFORMATION MESSAGES

Message	Action
Pre-Collision Assist Not Available Sensor Blocked	A sensor is likely blocked due to bad weather, ice, mud or water in front of the radar sensor. You can typically clean the sensor to resolve.
Pre-Collision Assist Not Available	A fault with the system has occurred. Have your vehicle checked as soon as possible.

# Pre-Collision Assist

---

## **PRE-COLLISION ASSIST – FREQUENTLY ASKED QUESTIONS**

### **Camera Troubleshooting**

#### **The windshield in front of the camera is dirty or obstructed.**

Clean the outside of the windshield in front of the camera.

#### **The windshield in front of the camera is clean, but the message remains in the instrument cluster display.**

Wait a short time. It could take several minutes for the camera to detect that there is no obstruction.

### **Radar Troubleshooting**

#### **The surface of the radar in the grille is dirty or obstructed.**

Clean the grille surface in front of the radar or remove the object causing the obstruction.

#### **The surface of the radar in the grille is clean, but the message remains in the instrument cluster display.**

Wait a short time. It could take several minutes for the radar to detect that there is no obstruction.

#### **Heavy rain, spray or fog is interfering with the radar signals.**

The pre-collision assist system is temporarily disabled. Pre-collision assist reactivates a short time after the weather conditions improve.

#### **Swirling water or snow or ice on the surface of the road could interfere with the radar signals.**

The pre-collision assist system is temporarily disabled. Pre-collision assist reactivates a short time after the weather conditions improve.

#### **Radar is out of alignment due to a front end impact.**

Have your vehicle serviced to have the radar checked for proper coverage and operation.

# Speed Sign Recognition

## WHAT IS SPEED SIGN RECOGNITION

Speed sign recognition detects speed limit signs to inform you of the current speed limit. Detected speed signs appear in the instrument cluster display.

## HOW DOES SPEED SIGN RECOGNITION WORK

Speed sign recognition uses the front windshield camera to detect speed signs.

If your vehicle has speed sign recognition with Map Data, stored speed sign data may influence the indicated speed limit value.

## SPEED SIGN RECOGNITION PRECAUTIONS



**WARNING:** You are responsible for controlling your vehicle at all times. The system is designed to be an aid and does not relieve you of your responsibility to drive with due care and attention. Failure to follow this instruction could result in the loss of control of your vehicle, personal injury or death.



**WARNING:** In cold and severe weather conditions the system may not function. Rain, snow and spray can all limit sensor performance.



**WARNING:** The system may not operate properly if the sensor is blocked. Keep the windshield free from obstruction.



**WARNING:** Do not perform windshield repairs in the area surrounding the sensor.



**WARNING:** The system may not correctly operate if your vehicle is fitted with a suspension kit not approved by Ford.



**WARNING:** Not all traffic signs can be recognized by the system and displayed correctly.

**Note:** Always fit our original parts when replacing headlamp bulbs. Other bulbs may reduce system performance.

## SPEED SIGN RECOGNITION LIMITATIONS

Speed sign recognition may not operate correctly due to:

- Outdated map data.
- Incorrect recognition of speed limits by the sensor of signs on parallel roads or exit ramps.
- Missed recognition of faded, dirty, or distorted signs.

# Speed Sign Recognition

## SPEED SIGN RECOGNITION INDICATORS



When the system detects a speed limit sign, it appears in the instrument cluster display.

**Note:** *Sign indicator image may vary based on your vehicle's display type.*

### SETTING THE SPEED SIGN RECOGNITION SPEED WARNING

1. From the settings menu, press Driver Assistance. See **Center Display** (page 468).
2. Press Speed Limit Assist.

3. Select to switch the feature on or off.

### SETTING THE SPEED SIGN RECOGNITION SPEED TOLERANCE

1. From the settings menu, press Driver Assistance. See **Center Display** (page 468).
2. Press Speed Limit Assist.
3. Press Tolerance.
4. Use the slider bar to select the required level.

## SPEED SIGN RECOGNITION – TROUBLESHOOTING

### SPEED SIGN RECOGNITION – INFORMATION MESSAGES

Message	Details
Traffic Sign Reduced Performance See Manual	The traffic sign data provided by the Map Data is unavailable due to weak or no signal. Wait for a short period of time for the signal to improve. If the message continues to appear, have the system checked as soon as possible.

# Speed Sign Recognition

---

## **SPEED SIGN RECOGNITION – FREQUENTLY ASKED QUESTIONS**

### **Why does the speed limit change without any sign on the road?**

- The speed limit changes due to the speed limit data stored in the map data.

### **Why does speed sign recognition show a wrong speed limit?**

- The system shows a wrong speed limit due to incorrect and outdated map data or due to incorrect recognition of the speed limits by the camera.



# Driver Alert

## WHAT IS DRIVER ALERT

Driver alert alerts you if it determines that you are becoming drowsy or if your driving deteriorates.

## HOW DOES DRIVER ALERT WORK

Driver Alert determines your alertness level based on your driving behavior in relation to the lane markings and other factors through use of the front camera sensor behind the interior mirror.

If the system determines you are becoming drowsy, it alerts you to rest. If you continue to exhibit drowsy driving behavior, the system will deliver an additional warning to rest as soon as it is safe to do so.

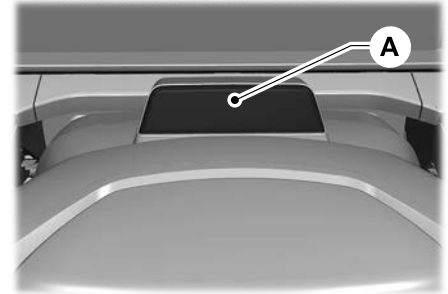
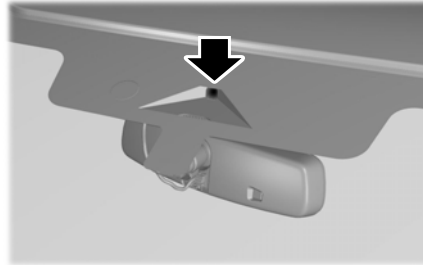

If your vehicle has a driver facing camera, driver alert determines if you are driving while distracted using the driver facing camera and infrared lighting to monitor your eyes and head position. If the system determines you are distracted, it alerts you to return your eyes to the road by sending a “watch the road” warning accompanied by a tone.

If you continue to not look at the road, another " watch the road" warning will be delivered with an additional chime. This warning remains visible in the instrument cluster until you press the "OK" button on the steering wheel.

- A Camera and lighting areas behind the steering wheel.

# Driver Alert

## DRIVER ALERT PRECAUTIONS

 **WARNING:** You are responsible for controlling your vehicle at all times. The system is designed to be an aid and does not relieve you of your responsibility to drive with due care and attention. Failure to follow this instruction could result in the loss of control of your vehicle, personal injury or death.

 **WARNING:** Take regular rest breaks if you feel tired. Do not wait for the system to warn you.

 **WARNING:** Certain driving styles may result in the system warning you even if you are not feeling tired.

 **WARNING:** In cold and severe weather conditions the system may not function. Rain, snow and spray can all limit sensor performance.

 **WARNING:** The system will not operate if the sensor cannot track the road lane markings.

 **WARNING:** If damage occurs in the immediate area surrounding the sensor, have your vehicle checked as soon as possible.

 **WARNING:** The system may not correctly operate if your vehicle is fitted with a suspension kit not approved by us.

 **WARNING:** The system may not operate properly if the sensor is blocked. Keep the windshield free from obstruction.

**Note:** *If something is blocking the camera or damaged the windshield, Driver Alert may not function.*

## DRIVER ALERT LIMITATIONS

Driver alert may not function correctly if:

- The sensor cannot track the road lane markings.
- Your vehicle's speed is less than approximately 40 mph (65 km/h).

## SWITCHING DRIVER ALERT ON AND OFF

1. From the settings menu, press Driver Assistance. See **Center Display** (page 468).
2. Press Driver Alert.
3. Switch the feature on or off.

## DRIVER ALERT INDICATORS

### System Warnings

The warning system has two stages:

1. A temporary warning is issued to advise you to take a rest. This message only appears for a short time.

# Driver Alert

---

2. If you do not rest and the system continues to detect that your driving deteriorates, it issues a further warning. This remains in the instrument cluster display until you cancel it.

**Note:** *The system does not warn you if the vehicle speed falls below approximately 40 mph (65 km/h).*

## Resetting Driver Alert

You can reset the system by either:

- Switching the ignition off and on.
- Stopping the vehicle and then opening and closing the driver door.

## DRIVER ALERT – TROUBLESHOOTING

### DRIVER ALERT – INFORMATION MESSAGES

Message	Action
Driver Alert Warning Rest Now	Stop and rest as soon as it is safe to do so.
Driver Alert Warning Rest Suggested	Take a rest soon.

# Load Carrying

## LOAD CARRYING PRECAUTIONS

Keep your loaded vehicle weight within its design rating capability, with or without a trailer. Properly loading your vehicle provides maximum return of vehicle design performance. Before you load your vehicle, become familiar with the following terms for determining your vehicle's weight rating, with or without a trailer, from the vehicle's Tire and Loading Information label or Safety Compliance Certification label.

 **WARNING:** The appropriate loading capacity of your vehicle can be limited either by volume capacity (how much space is available) or by payload capacity (how much weight the vehicle should carry). Once you have reached the maximum payload of your vehicle, do not add more cargo, even if there is space available. Overloading or improperly loading your vehicle can contribute to loss of vehicle control and vehicle rollover.

 **WARNING:** Exceeding the Safety Compliance Certification label vehicle weight limits can adversely affect the performance and handling of your vehicle, cause vehicle damage and can result in the loss of control of your vehicle, serious personal injury or death.

 **WARNING:** Do not use replacement tires with lower load carrying capacities than the original tires because they may lower your vehicle's GVWR and GAWR limitations. Replacement tires with a higher limit than the original tires do not increase the GVWR and GAWR limitations.

 **WARNING:** Do not exceed the GVWR or the GAWR specified on the certification label.

 **WARNING:** Exceeding any vehicle weight rating can adversely affect the performance and handling of your vehicle, cause vehicle damage and can result in the loss of control of your vehicle, serious personal injury or death.

 **WARNING:** When loading the roof racks, we recommend you evenly distribute the load, as well as maintain a low center of gravity. Loaded vehicles, with higher centers of gravity, may handle differently than unloaded vehicles. Take extra precautions, such as slower speeds and increased stopping distance, when driving a heavily loaded vehicle.

The gross combined weight must never exceed the Gross Combined Weight Rating.

# Load Carrying

## LOCATING THE SAFETY COMPLIANCE CERTIFICATION LABELS

### Safety Compliance Certification Label Example:

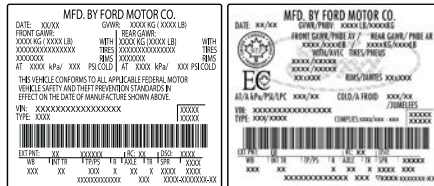

The Safety Compliance Certification label is located on the door hinge pillar, door-latch post, or the door edge that meets the door-latch post, next to the driver seating position.

## WHAT IS THE GROSS AXLE WEIGHT RATING

### GAWR (Gross Axle Weight Rating)

GAWR is the maximum allowable weight that a single axle (front or rear) can carry. These numbers are on the Safety Compliance Certification label.

## WHAT IS THE GROSS VEHICLE WEIGHT RATING

GVWR is the maximum allowable weight of the fully loaded vehicle. This includes all options, equipment, passengers and cargo. It appears on the Safety Compliance Certification label.

## WHAT IS THE GROSS COMBINED WEIGHT RATING

Gross Combined Weight Rating (GCWR) is the maximum allowable weight of the vehicle and the loaded trailer, including all cargo and passengers, that the vehicle can handle without risking damage. (Important: The towing vehicle's braking system is rated for operation at Gross Vehicle Weight Rating, not at Gross Combined Weight Rating.) Separate functional brakes should be used for safe control of towed vehicles and for trailers where the Gross Combined Weight of the towing vehicle plus the trailer exceed the Gross Vehicle Weight Rating of the towing vehicle. See **Recommended Towing Weights** (page 341).

# Load Carrying

## CALCULATING PAYLOAD

### Tire and Loading Label Information Example:



#### TIRE AND LOADING INFORMATION

SEATING CAPACITY TOTAL : 5 FRONT: 2 REAR: 3

The combined weight of occupants and cargo should never exceed **385 kg or 850 lbs.**

TIRE	SIZE	COLD TIRE PRESSURE	SEE OWNERS MANUAL FOR ADDITIONAL INFORMATION
FRONT	235/45R18 94V	235 KPA, 34 PSI	
REAR	235/45R18 94V	235 KPA, 34 PSI	
SPARE	NONE	NONE	



#### TIRE AND LOADING INFORMATION RENSEIGNEMENTS SUR LES PNEUS ET LE CHARGEMENT

SEATING CAPACITY TOTAL 5 FRONT 2 REAR 3  
NOMBRE DE PLACES AVANT ARRIERE

The combined weight of occupants and cargo should never exceed **396 kg or 875 lbs.**  
Le poids total des occupants et du chargement ne doit jamais dépasser **396 kg ou 875 lb.**

TIRE PNEU	SIZE DIMENSIONS	COLD TIRE PRESSURE PRESSION DES PNEUS A FROID	SEE OWNER'S MANUAL FOR ADDITIONAL INFORMATION VOIR LE MANUEL DE L'USAGER POUR PLUS DE RENSEIGNEMENTS
FRONT AVANT	235/40R19 96V	255 KPA, 37 PSI	
REAR ARRIERE	235/40R19 96V	255 KPA, 37 PSI	
SPARE DE SECOURS	T125/80R16 97M	415 KPA, 60 PSI	

Payload is the combined weight of cargo and passengers that your vehicle is carrying. The maximum payload for your vehicle appears on the Tire and Loading label. The label is either on the B-pillar or the edge of the driver door. Vehicles exported outside the US and Canada may not have a tire and loading label. Look for "The combined weight of occupants and cargo should never exceed XXX kg or XXX lb" for maximum payload. The payload listed on the Tire and Loading Information label is the maximum payload for your vehicle as built by the assembly plant. If you install any additional equipment on your vehicle, you must determine the new payload. Subtract the weight of the equipment from the payload listed on the Tire and Loading label. When towing, trailer tongue weight or king pin weight is also part of payload.

## CALCULATING THE LOAD LIMIT

Steps for determining the correct load limit:

1. Locate the statement "The combined weight of occupants and cargo should never exceed XXX kg or XXX lb." on your vehicle's placard.
2. Determine the combined weight of the driver and passengers that will be riding in your vehicle.
3. Subtract the combined weight of the driver and passengers from XXX kg or XXX lb.
4. The resulting figure equals the available amount of cargo and luggage load capacity. For example, if the "XXX" amount equals 1,400 lb. and there will be five 150 lb. passengers in your vehicle, the amount of available cargo and luggage load capacity is 650 lb.  $(1400 - 750 (5 \times 150) = 650 \text{ lb.})$
5. Determine the combined weight of luggage and cargo being loaded on the vehicle. That weight may not safely exceed the available cargo and luggage load capacity calculated in Step 4.

# Load Carrying

6. If your vehicle will be towing a trailer, load from your trailer will be transferred to your vehicle. Consult this manual to determine how this reduces the available cargo and luggage load capacity of your vehicle.

## Helpful examples for calculating the available amount of cargo and luggage load capacity

Suppose your vehicle has a 1400-pound (635-kilogram) cargo and luggage capacity. You decide to go golfing. Is there enough load capacity to carry you, four of your friends and all the golf bags? You and four friends average 220 pounds (99 kilograms) each and the golf bags weigh approximately 30 pounds (13.5 kilograms) each. The calculation would be:  $1400 - (5 \times 220) - (5 \times 30) = 1400 - 1100 - 150 = 150$  pounds. Yes, you

have enough load capacity in your vehicle to transport four friends and your golf bags. In metric units, the calculation would be:  $635 \text{ kilograms} - (5 \times 99 \text{ kilograms}) - (5 \times 13.5 \text{ kilograms}) = 635 - 495 - 67.5 = 72.5$  kilograms.

Suppose your vehicle has a 1400-pound (635-kilogram) cargo and luggage capacity. You and one of your friends decide to pick up cement from the local home improvement store to finish that patio you have been planning for the past two years. Measuring the inside of the vehicle with the rear seat folded down, you have room for twelve 100-pound (45-kilogram) bags of cement. Do you have enough load capacity to transport the cement to your home? If you and your friend each weigh 220 pounds (99 kilograms), the calculation would be:  $1400 - (2 \times 220) - (12 \times 100) = 1400 - 440 - 1200 = -240$  pounds. No, you do not have enough cargo capacity to carry that much weight. In metric units, the calculation would be:  $635 \text{ kilograms} - (2 \times 99 \text{ kilograms}) - (12 \times 45 \text{ kilograms}) = 635 -$

$198 - 540 = -103$  kilograms. You will need to reduce the load weight by at least 240 pounds (104 kilograms). If you remove three 100-pound (45-kilogram) cement bags, then the load calculation would be:  $1400 - (2 \times 220) - (9 \times 100) = 1400 - 440 - 900 = 60$  pounds. Now you have the load capacity to transport the cement and your friend home. In metric units, the calculation would be:  $635 \text{ kilograms} - (2 \times 99 \text{ kilograms}) - (9 \times 45 \text{ kilograms}) = 635 - 198 - 405 = 32$  kilograms.

The above calculations also assume that the loads are positioned in your vehicle in a manner that does not overload the front or the rear gross axle weight rating specified for your vehicle on the Safety Compliance Certification label.

# Load Carrying

## ROOF RACK (IF EQUIPPED)

### ROOF RACK PRECAUTIONS



**WARNING:** Read and follow the manufacturer's instructions when you are fitting a roof rack.



**WARNING:** When loading the roof racks, we recommend you evenly distribute the load, as well as maintain a low center of gravity. Loaded vehicles, with higher centers of gravity, may handle differently than unloaded vehicles. Take extra precautions, such as slower speeds and increased stopping distance, when driving a heavily loaded vehicle.

**Note:** *If you use a roof rack, the fuel consumption of your vehicle will be higher and you may experience different driving characteristics.*

You must place loads directly on the crossbars fitted to the roof rack side rails.

Make sure that you securely fasten the load. Check the tightness of the load before driving and at each fuel stop.

### ROOF RACK LOAD CAPACITIES

Do not install crossbars if your vehicle has a moonroof. Do not place any load on your vehicle if it has a moonroof. Using crossbars or loading the vehicle roof may void your vehicle's warranty.

Description	Maximum Recommended Load
Vehicles with a moonroof	0 lb (0 kg)
Vehicles without a moonroof	100 lb (45 kg)

**Note:** *The maximum roof load is based on the load being evenly distributed on the crossbars.*

**Note:** *When using a roof rack system, you must subtract the weight of the roof rack system from the maximum recommended load to determine your actual maximum cargo load. See the roof rack system manufacturer for more information.*





# Luggage Compartment

## LUGGAGE COMPARTMENT PRECAUTIONS

 **WARNING:** Make sure that you properly secure objects in the luggage compartment. Failure to follow this instruction could result in personal injury in the event of a sudden stop or crash.

 **WARNING:** Do not place objects on the luggage cover. Failure to follow this instruction could result in personal injury or death in the event of a sudden stop or crash.

 **WARNING:** The appropriate loading capacity of your vehicle can be limited either by volume capacity (how much space is available) or by payload capacity (how much weight the vehicle should carry). Once you have reached the maximum payload of your vehicle, do not add more cargo, even if there is space available. Overloading or improperly loading your vehicle can contribute to loss of vehicle control and vehicle rollover.

 **WARNING:** Make sure that you fully close the liftgate to prevent exhaust fumes from entering your vehicle. If you are unable to fully close the liftgate, open the air vents or the windows to allow fresh air to enter your vehicle. Failure to follow this instruction could result in personal injury or death.

 **WARNING:** Do not exceed the maximum front and rear axle loads for your vehicle.

**Note:** *When loading long objects into your vehicle, for example pipes, timber or furniture, be careful not to damage the interior trim.*

## INSTALLING AND REMOVING THE LUGGAGE COMPARTMENT CARGO NET

 **WARNING:** This net is not designed to restrain objects during a collision or heavy braking.

Attach the net to the anchors. Repeat the attachment on both sides of the vehicle.

# Luggage Compartment

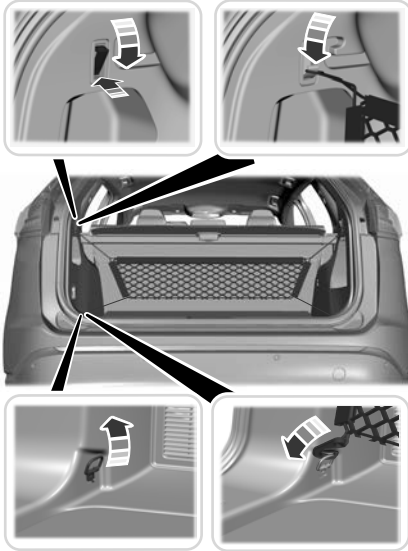

## INSTALLING AND REMOVING THE LUGGAGE COMPARTMENT COVER

(IF EQUIPPED)

Use the luggage cover to conceal items in the luggage compartment.

### Installing the Luggage Cover

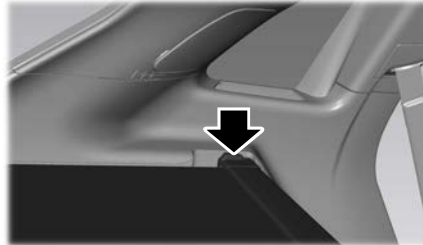

The luggage cover cassette attaches to the rear quarter trim panel.

1. Load the cassette into the rear quarter trim from the top down.

2. Push the cassette down, the click indicates the luggage cover is properly installed.

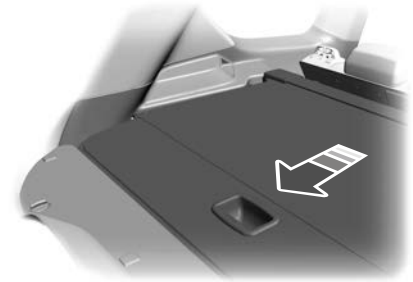

3. Pull the cover straight back until it locks.

### Removing the Luggage Cover

1. To release the cover, tap the center of the board by the pull handle.

# Luggage Compartment

---

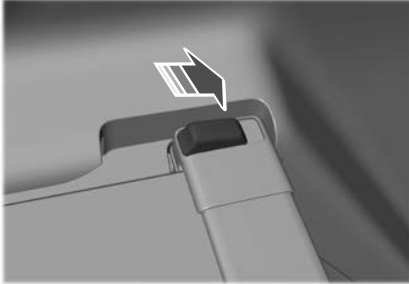

2. To release the cassette from the rear quarter trim panel, slide the button forward.
3. After sliding the button forward, lift the cassette up.

**Note:** *There are buttons on both sides of the cassette.*

# Connecting a Trailer

## CONNECTING A TRAILER PRECAUTIONS

Do not tow a trailer until you drive your vehicle at least 1,000 mi (1,600 km).

Consult your local motor vehicle laws for towing a trailer.

See the instructions included with towing accessories for the proper installation and adjustment specifications.

Service your vehicle more frequently if you tow a trailer. See **General Maintenance Information** (page 493).

If you use a rental trailer, follow the instructions the rental agency gives you.

When attaching the trailer wiring connector to your vehicle, only use a proper fitting connector that works with the vehicle and trailer functions.

Account for the trailer coupler weight as part of your vehicle load when calculating the total vehicle weight.

Do not exceed the load limits. See **Calculating the Load Limit** (page 330).

## CONNECTING A TRAILER

### Trailer Towing Connector (If Equipped)

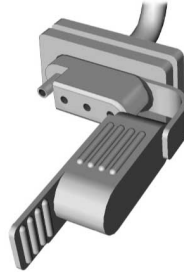

When attaching the trailer wiring connector to your vehicle, only use a proper fitting connector that works with the vehicle and trailer functions.

**Note:** *Install the waterproof protection cap back onto the trailer towing connector whenever it is not in use. This helps to prevent water damage and trailer towing connector malfunction.*

**Note:** *You cannot use a seven-pin trailer wiring connector for your vehicle and the trailer lighting equipment.*

### Trailer Lamps



**WARNING:** Never connect any trailer lamp wiring to the vehicle's tail lamp wiring; this may damage the electrical system resulting in fire. Contact your authorized dealer as soon as possible for assistance in proper trailer tow wiring installation. Additional electrical equipment may be required.

Trailer lamps are required on most towed vehicles. Make sure all running lights, brake lights, turn signals and hazard lights are working.

### Safety Chains

**Note:** *Do not attach safety chains to the bumper. Always connect the safety chains to the frame or hook retainers of your trailer hitch.*

# Connecting a Trailer

Install trailer safety chains to the trailer hitch as recommended by the manufacturer. Cross the chains under the trailer coupler and allow enough slack for turning tight corners. Do not allow the chains to drag on the ground.

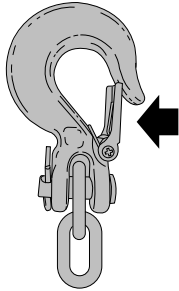

If the trailer safety chain hook has a latch, make sure the latch is fully closed.

## TRAILER LIGHTING CHECK

 **WARNING:** Never connect any trailer lamp wiring to the vehicle's tail lamp wiring; this may damage the electrical system resulting in fire. Contact your authorized dealer as soon as possible for assistance in proper trailer tow wiring installation. Additional electrical equipment may be required.

Perform a trailer light illumination sequence to confirm that all lights are functioning by using the LincolnWay app or the vehicle's touchscreen.

**Note:** *The LincolnWay app allows one person to confirm that all lights are functioning.*

**Note:** *The trailer light check feature is available only in vehicles with trailer capability. The trailer must be electrically connected for this feature to function.*

## Performing the Trailer Lighting Check Using the Touchscreen

1. From the apps menu, press Towing. See **Center Display** (page 468).
2. Press Trailer Light Check.
3. Press Start.
4. Follow the instructions until the lights sequence completes.

# Towing a Trailer

## TOWING A TRAILER PRECAUTIONS

 **WARNING:** Do not exceed the GVWR or the GAWR specified on the certification label.

 **WARNING:** Towing trailers beyond the maximum recommended gross trailer weight exceeds the limit of your vehicle and could result in engine damage, transmission damage, structural damage, loss of vehicle control, vehicle rollover and personal injury.

 **WARNING:** Do not exceed the lowest rating capacity for your vehicle or trailer hitch. Overloading your vehicle or trailer hitch can impair your vehicle stability and handling. Failure to follow this instruction could result in the loss of control of your vehicle, personal injury or death.

 **WARNING:** Make sure that the vertical load on the tow ball is between the minimum and maximum recommended weight at all times. Failure to follow this instruction could result in the loss of control of your vehicle, personal injury or death.

 **WARNING:** Do not cut, drill, weld or modify the trailer hitch. Modifying the trailer hitch could reduce the hitch rating.

 **WARNING:** The anti-lock brake system does not control the trailer brakes.

## TRAILER BRAKE PRECAUTIONS

 **WARNING:** Do not connect a trailer's hydraulic brake system directly to your vehicle's brake system. Your vehicle may not have enough braking power and your chances of having a collision greatly increase.

 **WARNING:** Do not tow a trailer fitted with electric trailer brakes unless your vehicle is fitted with a compatible aftermarket electronic trailer brake controller. Failure to follow this instruction could result in the loss of control of your vehicle, personal injury or death. For additional information and assistance, we recommend that you contact an authorized dealer.

Electric brakes and manual, automatic or surge-type trailer brakes are safe if you install them properly and adjust them to the manufacturer's specifications. The trailer brakes must meet local and federal regulations.

# Towing a Trailer

---

The rating for the tow vehicle's braking system operation is at the gross vehicle weight rating, not the gross combined weight rating.

Certain states require functioning trailer brakes for trailers over a specified weight. Be sure to check state regulations for this specified weight.

Ford Motor Company recommends separate functioning brake systems for trailers weighing more than 1,500 lb (680 kg) when loaded.

## TOWING A TRAILER LIMITATIONS

The vehicle's load capacity designation is by weight, not by volume, so you cannot necessarily use all available space when loading a vehicle or trailer.

**Note:** *Your vehicle could have reduced performance when operating at high altitudes and when heavily loaded or towing a trailer. When driving at elevation, to match driving performance as perceived at sea level, reduce gross vehicle weight and gross combination weight by 2% per 1,000 ft (300 m) elevation.*

## LOADING YOUR TRAILER

To help minimize how trailer movement affects your vehicle when driving:

- Load the heaviest items closest to the trailer floor.
- Load the heaviest items centered between the left and right side trailer tires.

- Load the heaviest items above the trailer axles or just slightly forward toward the trailer tongue. Do not allow the final trailer tongue weight to go above or below 10-15% of the loaded trailer weight. The trailer tongue weight should never exceed 10% of the maximum towing capacity.
- Select a ball mount with the correct rise or drop. When both the loaded vehicle and trailer are connected, the trailer frame should be level, or slightly angled down toward your vehicle, when viewed from the side.

## TRAILER TOWING HINTS

Towing a trailer places an extra load on your vehicle's engine, transmission, axle, brakes, tires and suspension. Periodically inspect these components during and after any towing operation.

When driving with a trailer or payload, a slight takeoff vibration or shudder may be present due to the increased payload weight.

# Towing a Trailer

---

Your vehicle may have a temporary or conventional spare tire. A temporary spare tire is different in diameter or width, tread-type, or is from a different manufacturer than the road tires on your vehicle. Consult information on the tire label or Safety Compliance label for limitations when using.

When towing a trailer:

- Obey country specific regulations for towing a trailer.
- Do not drive faster than 70 mph (113 km/h) during the first 500 mi (800 km).
- Do not make full-throttle starts.
- Check your hitch, electrical connections and trailer wheel lug nuts thoroughly after you have traveled 50 mi (80 km).
- When stopped in congested or heavy traffic during hot weather, place the transmission in park (P) to aid engine and transmission cooling and to help A/C performance.
- Turn off the speed control with heavy loads or in hilly terrain. The speed control may turn off when you are towing on long, steep slopes.
- Shift to a lower gear when driving down a long or steep hill. Do not continuously apply the brakes, as they may overheat and become less effective.
- If your transmission has Grade Assist or Tow/Haul, use this feature when towing. This provides engine braking and helps eliminate excessive transmission shifting for optimum fuel economy and transmission cooling.
- Your vehicle has AdvanceTrac with roll stability control. When towing a trailer, additional loads could cause the AdvanceTrac system to engage during cornering maneuvers. Reduce cornering speeds to make sure that you can maintain control of the vehicle and trailer if the AdvanceTrac system engages.
- Allow more distance for stopping with a trailer attached. Anticipate stops and gradually brake.
- Avoid parking on a slope. However, if you must park on a slope, turn the steering wheel to point your vehicle tires away from traffic flow, set the parking brake, place the transmission in park (P) and place wheel chocks in front and back of the trailer wheels.

**Note:** *Chocks are not included with your vehicle.*

## LAUNCHING OR RETRIEVING A BOAT OR PERSONAL WATERCRAFT

When backing down a ramp during boat launching or retrieval:

- Do not allow the static water level to rise above the bottom edge of the rear bumper.
- Do not allow waves to break higher than 6 in (15 cm) above the bottom edge of the rear bumper.



# Towing a Trailer

Exceeding 6 in (15 cm) could allow water to enter vehicle components, causing internal damage to the components and affecting driveability, emissions and reliability.

**Note:** *Replace the rear axle lubricant anytime the rear axle has been submerged in water.*

**Note:** *Disconnect the trailer wiring connector before backing the trailer into the water.*

**Note:** *Reconnect the trailer wiring connector after removing the trailer from the water.*

## TOWING WEIGHTS AND DIMENSIONS

### RECOMMENDED TOWING WEIGHTS

Market	Website
United States of America	<a href="https://www.fordpro.com/en-us/fleet-vehicles/manuals-and-guides/">https://www.fordpro.com/en-us/fleet-vehicles/manuals-and-guides/</a>
Canada	<a href="https://www.fordpro.com/en-us/fleet-vehicles/manuals-and-guides/">https://www.fordpro.com/en-us/fleet-vehicles/manuals-and-guides/</a>

# Towing a Trailer

---

## WHAT IS THE MAXIMUM LOADED TRAILER WEIGHT

The maximum loaded trailer weight is the highest possible weight of a fully loaded trailer the vehicle can tow.

## CALCULATING THE MAXIMUM LOADED TRAILER WEIGHT FOR YOUR VEHICLE

1. Start with the gross combined weight rating for your vehicle model and axle ratio.
2. Subtract all of the following that apply to your vehicle:
  - Vehicle curb weight.
  - Hitch hardware weight, for example a draw bar, ball, locks or weight distributing hardware.
  - Driver weight.
  - Passenger weight.
  - Payload, cargo and luggage weight.
  - Aftermarket equipment weight.

This equals the maximum loaded trailer weight for this combination.

**Note:** *The trailer tongue load is considered part of the payload for your vehicle. Reduce the total payload by the final trailer tongue weight.*

**Note:** *Consult an authorized dealer to determine the maximum trailer weight allowed for your vehicle if you are not sure.*

# Trailer Sway Control

## HOW DOES TRAILER SWAY CONTROL WORK

The system applies the brakes to the individual wheels and reduces engine torque to aid vehicle stability.

If the trailer begins to sway, the stability control lamp flashes and the message **Trailer Sway Reduce Speed** appears in the information display.

Stop your vehicle as soon as it is safe to do so. Check the vertical weight on the tow ball and trailer load distribution.

## TRAILER SWAY CONTROL PRECAUTIONS



**WARNING:** Turning off trailer sway control increases the risk of loss of vehicle control, serious injury or death. Ford does not recommend disabling this feature except in situations where speed reduction may be detrimental (such as hill climbing), the driver has significant trailer towing experience, and can control trailer sway and maintain safe operation.

**Note:** *This feature only activates when significant trailer sway occurs.*

**Note:** *This feature does not prevent trailer sway, but reduces it once it begins.*

**Note:** *This feature cannot stop all trailers from swaying.*

**Note:** *In some cases, if vehicle speed is too high, the system may activate multiple times, gradually reducing vehicle speed.*

## SWITCHING TRAILER SWAY CONTROL ON AND OFF

1. From the apps menu, press Towing. See **Center Display** (page 468).
2. Press Settings.
3. Switch Trailer Sway Control on or off.

The system turns on each time you start your vehicle.

# Driving Hints

---

## COLD WEATHER PRECAUTIONS

The functional operation of some components and systems can be affected at temperatures below approximately -13°F (-25°C).

## BREAKING-IN

You need to break in new tires for approximately 300 mi (480 km). During this time, your vehicle may exhibit some unusual driving characteristics.

## DRIVING ECONOMICALLY

The following helps to improve fuel consumption:

- Drive smoothly, accelerate gently and anticipate the road ahead to avoid heavy braking.
- Regularly check your tire pressures and make sure that they are inflated to the correct pressure.

- Follow the recommended maintenance schedule and carry out the recommended checks.
- Plan your journey and check the traffic before you set off. It is more efficient to combine errands into a single trip whenever possible.
- Avoid idling the engine in cold weather or for extended periods. Start the engine only when you are ready to set off.
- Do not carry unnecessary weight in your vehicle as extra weight wastes fuel.
- Do not add unnecessary accessories to the exterior of your vehicle, for example running boards. If you use a roof rack, remember to fold it down or remove it when not in use.
- Do not shift into neutral when you are braking or when your vehicle is slowing down.

- Shut all windows when driving at high speeds.
- Switch off all electric systems when not in use, for example air conditioning. Make sure that you unplug any accessories from the auxiliary power points when not in use.

## DRIVING IN SPECIAL CONDITIONS

### DRIVING THROUGH MUD AND WATER

#### Mud

Be cautious of sudden changes in vehicle speed or direction when you are driving in mud. Even all-wheel drive and four-wheel drive vehicles can lose traction in mud. If your vehicle slides, steer in the direction of the slide until you regain control of your vehicle. After driving through mud, clean off residue stuck to rotating driveshafts and tires. Excess residue can cause an imbalance that could damage drive components.

# Driving Hints

---

**Note:** *If your vehicle gets stuck in mud, it could be rocked out by shifting between forward and reverse gears, stopping between shifts in a steady pattern. Press lightly on the accelerator in each gear.*

**Note:** *Do not rock your vehicle if the engine is not at normal operating temperature, as damage to the transmission could occur.*

**Note:** *Do not rock your vehicle for more than a minute, as damage to the transmission and tires could occur or the engine could overheat.*

## Water

If you must drive through water approach it cautiously. See **Driving Through Shallow Water** (page 346).

## DRIVING ON HILLY OR SLOPING TERRAIN



**WARNING:** Extreme care should be used when steering the vehicle in reverse down a slope so as not to cause the vehicle to swerve out of control.

Although natural obstacles could make it necessary to travel diagonally up or down a hill or steep incline, you should try to drive straight up or straight down.

**Note:** *Avoid turning on steep slopes or hills. A danger lies in losing traction, slipping sideways and possible vehicle roll over. Whenever driving on a hill, determine beforehand the route you can use. Do not drive over the crest of a hill without seeing what conditions are on the other side. Do not drive in reverse over a hill without the aid of an observer.*

Apply just enough power to the wheels to climb the hill. Too much power causes the tires to slip, spin or lose traction, and you could lose control of your vehicle. When descending a steep hill, do not descend the hill in neutral. Avoid sudden hard braking to keep the front wheels rolling and to maintain your vehicle's steering.

**Note:** *Your vehicle has anti-lock brakes, apply the brakes steadily. Do not pump the brakes.*

**Note:** *If your vehicle gets stuck driving on hilly or sloping terrain, it could be rocked out by shifting between forward and reverse gears, stopping between shifts in a steady pattern. Press lightly on the accelerator in each gear.*

**Note:** *Do not rock your vehicle if the engine is not at normal operating temperature, as damage to the transmission could occur.*

**Note:** *Do not rock your vehicle for more than a minute, as damage to the transmission and tires could occur or the engine could overheat.*

# Driving Hints

## DRIVING IN SAND

When driving over sand, try to keep all four wheels on the most solid area of the trail. Steadily drive through the terrain. Apply the accelerator slowly and avoid excessive wheel slip. Do not drive your vehicle in deep sand for an extended period of time. This could overheat the system. A message appears in the instrument cluster display.

**Note:** *If your vehicle gets stuck driving on hilly or sloping terrain, it could be rocked out by shifting between forward and reverse gears, stopping between shifts in a steady pattern. Press lightly on the accelerator in each gear.*

**Note:** *Do not rock your vehicle if the engine is not at normal operating temperature, as damage to the transmission could occur.*

**Note:** *Do not rock your vehicle for more than a minute, as damage to the transmission and tires could occur or the engine could overheat*

## DRIVING THROUGH SHALLOW WATER



**WARNING:** Do not attempt to cross a deep or flowing body of water. Failure to follow this instruction could result in the loss of control of your vehicle, personal injury or death.

**Note:** *Driving through standing water can cause vehicle damage.*

**Note:** *Engine damage can occur if water enters the air filter.*

Before driving through standing water, check the depth. Never drive through water that is higher than the bottom of the front rocker area of your vehicle.



When driving through standing water, drive very slowly and do not stop your vehicle. Your brake performance and traction could be limited. After driving through water and as soon as it is safe to do so:

- Lightly press the brake pedal to dry the brakes and to check that they work.
- Turn the steering wheel to check that the steering power assist works.

Check the function of the following:

- Horn
- Exterior lights

# Driving Hints

## FLOOR MATS

 **WARNING:** Use a floor mat designed to fit the footwell of your vehicle that does not obstruct the pedal area. Failure to follow this instruction could result in the loss of control of your vehicle, personal injury or death.

 **WARNING:** Pedals that cannot move freely can cause loss of vehicle control and increase the risk of serious personal injury.

 **WARNING:** Secure the floor mat to both retention devices so that it cannot slip out of position and interfere with the pedals. Failure to follow this instruction could result in the loss of control of your vehicle, personal injury or death.

 **WARNING:** Do not place additional floor mats or any other covering on top of the original floor mats. This could result in the floor mat interfering with the operation of the pedals. Failure to follow this instruction could result in the loss of control of your vehicle, personal injury or death.

 **WARNING:** Always make sure that objects cannot fall into the driver foot well while your vehicle is moving. Objects that are loose can become trapped under the pedals causing a loss of vehicle control.

To install floor mats that have eyelets, position the floor mat eyelet over the retention post and press down to lock in position. Repeat for all eyelets on the floor mat.

To remove the floor mats, reverse the installation procedure.

**Note:** *Regularly check the floor mats to make sure they are secure.*



# Crash and Breakdown Information

---

## ROADSIDE ASSISTANCE

### Vehicles Sold in the United States: Getting Roadside Assistance

If you have a vehicle concern, Lincoln offers a complimentary roadside assistance program. This program is separate from the New Vehicle Limited Warranty.

The service is available:

- Throughout the life of the vehicle for original owners.
- For six years or 70,000 mi (110,000 km), whichever comes first, for subsequent owners.

Knowing your vehicle's VIN, mileage and your specific location allows help to get to you faster.

Roadside Assistance covers:

- A flat tire change with a good spare. For vehicles with an unusable tire inflation kit, we provide towing service.
- Battery jump start.
- Lock-out assistance - key replacement cost is the client's responsibility.

- Fuel delivery — independent service contractors, if not prohibited by state, local or municipal law shall deliver up to 2 gal (8 L) of gasoline fuel to a disabled vehicle. Roadside Assistance limits fuel delivery service to two no-charge occurrences within a 12-month period.
- Winch out — available within 100 ft (30 m) of a paved or county maintained road, no recoveries.
- Towing — independent service contractors, if not prohibited by state, local or municipal law shall tow Lincoln eligible vehicles to the client's selling or preferred dealer within 100 mi (160 km) of the disablement location or to the nearest Lincoln dealer. If a client requests a tow to a selling or preferred dealer that is more than 100 mi (160 km) from the disablement location, the client is responsible for any mileage costs in excess of 100 mi (160 km).
- Roadside Assistance includes up to \$200 for a towed trailer if the disabled eligible vehicle requires service at the nearest authorized dealer. If the towing vehicle is operational but the trailer is not, then the trailer does not qualify for any roadside services.

### Vehicles Sold in the United States: Using Roadside Assistance

United States clients who require roadside assistance, call 1-800-521-4140 or contact Roadside Assistance using the Lincoln Way mobile app.



# Crash and Breakdown Information

---

If you need to arrange roadside assistance on your own, Lincoln reimburses a reasonable amount for towing to the nearest Lincoln dealership within 100 mi (160 km). To obtain reimbursement information, United States clients, call 1-800-521-4140. Clients need to submit their original receipts.

## Vehicles Sold in Canada: Getting Roadside Assistance

If you have a vehicle concern, Lincoln offers a complimentary roadside assistance program. This program is eligible within Canada or the continental United States.

The service is available 24 hours a day, seven days a week.

This program is separate from the New Vehicle Limited Warranty, beginning from the original warranty start date and lasts the life of the vehicle for the original owner. Subsequent owners receive coverage that is concurrent with the 6 years or 70,000 mi (110,000 km), whichever occurs first, powertrain warranty coverage period.

**Note:** *Canadian roadside coverage and benefits may differ from the U.S. coverage.*

For complete program coverage details, review your warranty guide, contact your dealer, call us in Canada at 1-844-665-2007, or visit our website at [www.lincolncanada.com](http://www.lincolncanada.com).

Download the Sykes4Lincoln Roadside Assistance App for access to your roadside assistance services. For more information, scan here:



If you purchased your vehicle in Canada and require roadside assistance, please call 1-844-665-2007 or contact Roadside Assistance using the Lincoln Way mobile app.

Ford Motor Company reserves the right to modify or discontinue Roadside Assistance at any time. Certain restrictions apply to Roadside Assistance benefits.

For further details, call **1-800-521-4140** (United States) **1-844-665-2007** (Canada)

## HIGH VOLTAGE BATTERY VEHICLE PRECAUTIONS - HYBRID ELECTRIC VEHICLE (HEV)

In the event of damage or fire involving an electric vehicle or hybrid-electric vehicle:

- Assume the high-voltage battery and associated components are energized and fully charged.
- Exposed electrical components, wires and high-voltage batteries present potential high-voltage shock hazards.

# Crash and Breakdown Information

---

- Venting high-voltage battery vapors are potentially toxic and flammable.
- Physical damage to the vehicle or high-voltage battery could result in immediate or delayed release of toxic, flammable gases and fire.

Vehicle information and general safety practices include reviewing the owner's manual and becoming familiar with your vehicle's safety information and recommended safety practices.

## Crashes

A crash or impact significant enough to require an emergency response for conventional vehicles would also require the same response for an electric or hybrid-electric vehicle.

If Possible:

1. Move your vehicle to a safe, nearby location and remain on the scene.
2. Roll down the windows before you switch your vehicle off.
3. Place your vehicle in park (P), set the parking brake, switch off the vehicle, activate the hazard flashers and move your key(s) at least 16 ft (5 m) away from the vehicle.

Always:

- Call emergency assistance if needed and advise that an electric or hybrid-electric vehicle is involved.
- Avoid contact with leaking fluids and gases, and remain out of the way of oncoming traffic until emergency responders arrive.
- When emergency responders arrive, tell them that the vehicle involved is an electric vehicle or hybrid-electric vehicle.

## Fires

As with any vehicle, call emergency assistance immediately if you see sparks, smoke or flames coming from the vehicle. Remain a safe distance from the vehicle and try to stay clear of the smoke.

1. Exit the vehicle immediately.
2. Advise emergency assistance that an electric or hybrid-electric vehicle is involved.
3. As with any vehicle fire, do not inhale smoke, vapors or gas from the vehicle, as they may be hazardous.

## Post-Incident

1. Do not store a severely damaged vehicle with a lithium-ion battery inside a structure or within 49 ft (15 m) of any structure or vehicle.
2. Make sure that passenger and luggage compartments remain ventilated.
3. Call emergency assistance if you observe leaking fluids, sparks, smoke or flames, or hear gurgling or bubbling from the high-voltage battery.

# Crash and Breakdown Information

## SWITCHING THE HAZARD FLASHERS ON AND OFF



The hazard flasher button is on the center console. Press the button to switch the hazard flashers on if your vehicle is creating a safety hazard for other road users.

When you switch the hazard flashers on, all front and rear turn signals flash.

**Note:** *The hazard flashers operate when the ignition is in any position, or if the key is not in the ignition. If you leave the hazard flashers on while the vehicle is off, the battery loses charge and could have insufficient power to restart your vehicle.*

Press the button again to switch the hazard flashers off.

## JUMP STARTING THE VEHICLE

### JUMP STARTING PRECAUTIONS



**WARNING:** Batteries normally produce explosive gases which can cause personal injury. Therefore, do not allow flames, sparks or lighted substances to come near the battery. When working near the battery, always shield your face and protect your eyes. Always provide correct ventilation.



**WARNING:** Keep batteries out of reach of children. Batteries contain sulfuric acid. Avoid contact with skin, eyes or clothing. Shield your eyes when working near the battery to protect against possible splashing of acid solution. In case of acid contact with skin or eyes, flush immediately with water for a minimum of 15 minutes and get prompt medical attention. If acid is swallowed, call a physician immediately.



**WARNING:** Use only adequately sized cables with insulated clamps.



**WARNING:** Make sure that the cables are clear of any moving parts and fuel delivery system parts.



**WARNING:** Connect batteries with only the same nominal voltage.



**WARNING:** If the engine is running while the hood is open, stay clear of moving engine components. Failure to follow this warning could result in serious personal injury or death.

Do not attempt to push-start an automatic transmission vehicle. This could cause transmission damage.

Do not disconnect the battery of the disabled vehicle. This could damage your vehicle's electrical system.

## PREPARING THE VEHICLE

Use only a 12 volt supply to start your vehicle.

# Crash and Breakdown Information

Park the booster vehicle close to the hood of the disabled vehicle, making sure the two vehicles do not touch.

## JUMP STARTING THE VEHICLE - EXCLUDING: HYBRID ELECTRIC VEHICLE (HEV)

### Connecting the Jumper Cables



**WARNING:** Do not connect the negative jumper cable to any other part of your vehicle. Use the ground point.

**Note:** If you are using a jump pack or booster box, follow the manufacturer's instructions.

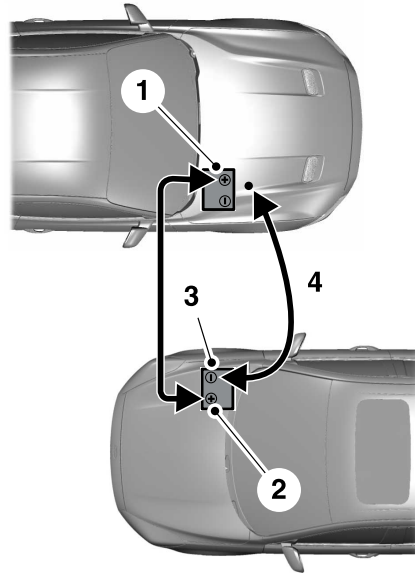

1. Unlatch the red cover to access the positive terminal. Connect the positive (+) jumper cable to the positive (+) terminal of the discharged battery.

2. Connect the other end of the positive (+) jumper cable to the positive (+) terminal of the booster vehicle battery.
3. Connect the negative (-) jumper cable to the negative (-) terminal of the booster vehicle battery.
4. Make the final connection of the negative (-) jumper cable to an exposed metal part of the disabled vehicle's engine, as shown in the following illustration, away from the battery and fuel injection system, or connect the negative (-) jumper cable to a ground connection point if available.

**Note:** Do not use the hood latch as a negative (-) connection point. This could cause springs in the latch to burn and prevent the hood from operating correctly.

# Crash and Breakdown Information

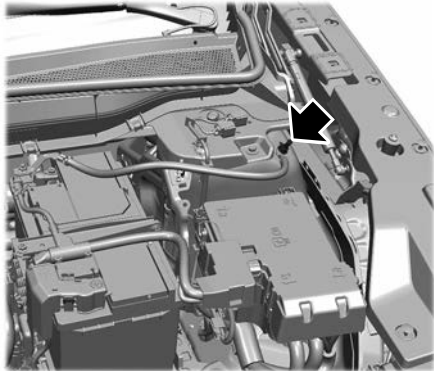

## Starting the Engine

1. Start the engine of the booster vehicle and moderately rev the engine, or gently press the accelerator to keep the engine speed between 2000 and 3000 RPM, as shown in your tachometer.
2. Start the engine of the disabled vehicle.
3. Once you start the disabled vehicle, run both vehicle engines for an additional three minutes before disconnecting the jumper cables.

## Removing the Jumper Cables

Remove the jumper cables in the reverse order that they were connected.

**Note:** Do not switch the headlamps on when disconnecting the cables. The peak voltage could blow the bulbs.

## JUMP STARTING THE VEHICLE - HYBRID ELECTRIC VEHICLE (HEV)

### Connecting the Jumper Cables



**WARNING:** Do not connect the negative jumper cable to any other part of your vehicle. Use the ground point.

**Note:** If you are using a jump pack or booster box, follow the manufacturer's instructions.

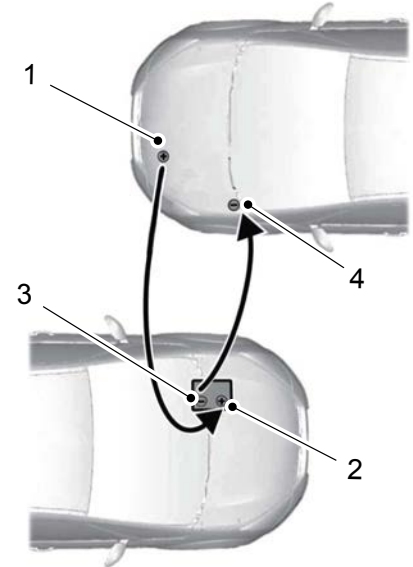

1. Pull the red rubber boot back. Connect the positive (+) jumper cable to the positive (+) terminal.

# Crash and Breakdown Information

**Note:** The positive terminal is located in the under hood fuse box.

2. Connect the other end of the positive (+) jumper cable to the positive (+) terminal of the booster vehicle battery.
3. Connect the negative (-) jumper cable to the negative (-) terminal of the booster vehicle battery.
4. Make the final connection of the negative (-) jumper cable to an exposed metal part of the disabled vehicle's engine, as shown in the following illustration, away from the battery and fuel injection system, or connect the negative (-) jumper cable to a ground connection point if available.

**Note:** Do not use the hood latch as a negative (-) connection point. This could cause springs in the latch to burn and prevent the hood from operating correctly.

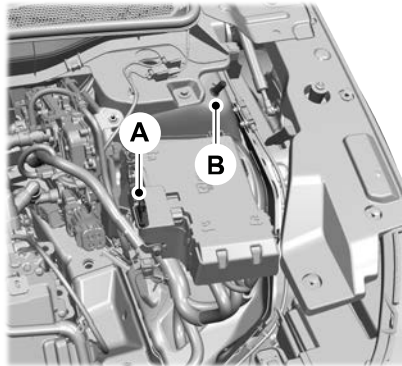

- A Positive (+) pin.
- B Ground connection point.

## Starting the Engine

1. Start the engine of the booster vehicle and moderately rev the engine, or gently press the accelerator to keep the engine speed between 2000 and 3000 RPM, as shown in your tachometer.
2. Start the engine of the disabled vehicle.

3. Once you start the disabled vehicle, run both vehicle engines for an additional three minutes before disconnecting the jumper cables.

## Removing the Jumper Cables

Remove the jumper cables in the reverse order that they were connected.

**Note:** Do not switch the headlamps on when disconnecting the cables. The peak voltage could blow the bulbs.

## POST-CRASH ALERT SYSTEM

### WHAT IS THE POST-CRASH ALERT SYSTEM

The system helps draw attention to your vehicle in the event of a serious impact.

# Crash and Breakdown Information

## HOW DOES THE POST-CRASH ALERT SYSTEM WORK

The system is designed to turn the hazard flashers on, turn the courtesy lamps on, intermittently sound the horn and unlock all doors in the event of a serious impact that deploys an airbag or the seatbelt pretensioners.

## POST-CRASH ALERT SYSTEM LIMITATIONS

Depending on applicable laws in the country your vehicle was built for, the horn does not sound in the event of a serious impact.

## SWITCHING THE POST-CRASH ALERT SYSTEM OFF

Press the hazard flasher switch, the unlock button on the remote control, the panic button on the remote control or cycle the ignition to switch the system off.

**Note:** *The alert turns off when the vehicle battery runs out of charge.*

## POST-COLLISION BRAKING

### How Does Post-Collision Braking Work

In the event of a moderate to severe crash, the braking system reduces the vehicle's speed to prevent or reduce the impact of a potential secondary crash.

### Post-Collision Braking Limitations

Post-collision braking does not activate if any of the following occur:

- The anti-lock braking system is damaged during the collision.
- Electronic stability control is disabled.

### Overriding Post-Collision Braking

You can override post-collision braking by pressing the brake or accelerator pedal.

### Post-Collision Braking Indicators



It flashes when a post-collision braking event is occurring.

## AUTOMATIC CRASH SHUTOFF

### WHAT IS AUTOMATIC CRASH SHUTOFF

The automatic crash shutoff is designed to stop the fuel going to the engine in the event of a moderate or severe crash.

**Note:** *Not every impact causes a shutoff.*

### AUTOMATIC CRASH SHUTOFF PRECAUTIONS



**WARNING:** If your vehicle has been involved in a crash, have the fuel system checked. Failure to follow this instruction could result in fire, personal injury or death.

### RE-ENABLING YOUR VEHICLE

1. Switch the ignition off.
2. Attempt to start your vehicle.
3. Switch the ignition off.
4. Attempt to start your vehicle.

# Crash and Breakdown Information

**Note:** *If your vehicle does not start after the third attempt, have your vehicle checked as soon as possible.*

## TRANSPORTING THE VEHICLE

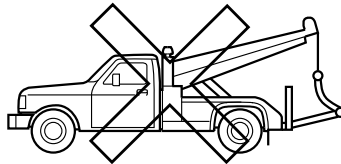
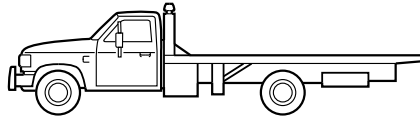
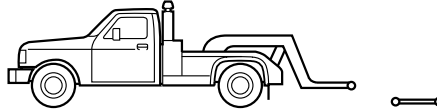

If you need to tow your vehicle, contact a professional towing service or your roadside assistance service provider.

Your manufacturer produces a towing manual for all authorized tow truck operators. Have your tow truck operator refer to this manual for proper hook-up and towing procedures.

We recommend the use of a wheel lift and dollies or flatbed equipment to tow your vehicle. Vehicle damage could occur if towed incorrectly, or by any other means.

Front-wheel and rear-wheel drive vehicles must have their designated drive wheels off the ground regardless of towing direction. Use tow dollies to prevent damage to the transmission.

All-wheel or four-wheel drive vehicles require that all wheels be off the ground using a wheel lift and dollies or flatbed equipment. This prevents damage to the transmission and drive system.

**Note:** *You need to switch on the ignition to unlock the steering.*



# Crash and Breakdown Information

**Note:** Make sure you check the steering column before towing. It could lock if the battery is dead.

## FAIL-SAFE COOLING

### WHAT IS FAIL-SAFE COOLING

Fail-safe cooling allows you to temporarily drive your vehicle before any incremental component damage occurs due to overheating.

The fail-safe distance depends on outside temperature, vehicle load and terrain.

### HOW DOES FAIL-SAFE COOLING WORK

If the engine reaches a preset over-temperature condition, the engine automatically switches to alternating cylinder operation. Each disabled cylinder acts as an air pump and cools the engine.

When this occurs, your vehicle still operates, however:

- Engine power is limited.
- The air conditioning system turns off.

Continued operation increases the engine temperature, causing the engine to completely shut down. Your steering and braking effort increases in this situation.

When the engine temperature cools, you can re-start the engine.

**Note:** Have your vehicle checked as soon as possible to minimize engine damage.

### DRIVING WHEN FAIL-SAFE MODE IS ACTIVATED



**WARNING:** Fail-safe mode is for use during emergencies only. Operate your vehicle in fail-safe mode only as long as necessary to bring your vehicle to rest in a safe location and seek immediate repairs. When in fail-safe mode, your vehicle will have limited power, will not be able to

maintain high-speed operation, and may completely shut down without warning, potentially losing engine power, power steering assist, and power brake assist, which may increase the possibility of a crash resulting in serious injury.



**WARNING:** Do not remove the coolant reservoir cap when the engine is on or the cooling system is hot. Wait 10 minutes for the cooling system to cool down. Cover the coolant reservoir cap with a thick cloth to prevent the possibility of scalding and slowly remove the cap. Failure to follow this instruction could result in personal injury.

Continued operation increases the engine temperature, causing the engine to completely shut down. Your steering and braking effort increases in this situation.

When the engine temperature cools, you can re-start the engine. Have your vehicle checked as soon as possible to minimize engine damage.

# Crash and Breakdown Information

---

Your vehicle has limited engine power when in the fail-safe mode, drive your vehicle with caution. Your vehicle does not maintain high-speed operation and the engine may operate poorly.

Remember that the engine is capable of automatically shutting down to prevent engine damage. In this situation:

1. Pull off the road as soon as safely possible and switch the engine off.
2. If you are a member of a roadside assistance program, we recommend that you contact your roadside assistance service provider.
3. If this is not possible, wait for a short period of time for the engine to cool.
4. Check the coolant level. If the coolant level is at or below the minimum mark, add prediluted coolant immediately.
5. When the engine temperature cools, you can re-start the engine. Have your vehicle checked as soon as possible to minimize engine damage.

**Note:** *Driving your vehicle without repair increases the chance of engine damage.*

## FAIL-SAFE COOLING INDICATORS



If the engine begins to overheat, the coolant temperature gauge moves toward the red zone.



A warning lamp illuminates and a message may appear in the instrument cluster display.

# Towing Your Vehicle

## TOWING YOUR VEHICLE PRECAUTIONS

Use the following guidelines when towing your vehicle. Failure to follow this instruction could result in vehicle damage not covered by the vehicle warranty.

**Note:** *Make sure you properly secure your vehicle to the tow vehicle.*

**Note:** *If you are unsure of the vehicle's configuration, contact an authorized dealer.*

## RECREATIONALLY TOWING YOUR VEHICLE - GASOLINE

You cannot recreational tow your vehicle with all wheels on the ground because vehicle or transmission damage could occur. You must recreational tow your vehicle with all four wheels off the ground, such as when using a car-hauling trailer. Otherwise, you cannot recreational tow your vehicle.

## RECREATIONALLY TOWING YOUR VEHICLE - FULL HYBRID ELECTRIC VEHICLE (FHEV)

Follow these guidelines if you have a need for recreational towing. An example of recreational towing is towing your vehicle behind a motorhome. These guidelines ensure that you do not damage the transmission.

**Note:** *Put your climate control system in recirculated air mode to prevent exhaust fumes from entering your vehicle. See **Switching Recirculated Air On and Off** (page 143).*

You can tow your vehicle with all four wheels on the ground under the following conditions:

- You switch **Neutral Tow** on.
- Your vehicle is facing forward for towing in a forward direction.
- You release the parking brake.
- You do not exceed 70 mph (113 km/h).

## Switching **Neutral Tow** On

1. From the settings menu, press Vehicle. See **Center Display** (page 468).
2. Press and hold Neutral Tow until a confirmation message appears on the touchscreen.
3. Fully press the brake pedal.
4. Shift into neutral (N).
5. Switch the ignition off.

**Note:** *Switching neutral tow on requires battery power.*

**Note:** *If the parking brake is applied, a message appears in the information display.*

**Note:** *If your vehicle has an ignition key, you cannot remove the key from the ignition when the transmission is in neutral (N) and your vehicle is off.*

**Note:** *Start the engine and allow it to run for a few minutes at the beginning of each day, and every six hours or fewer. With the engine running and your foot on the brake, shift into drive (D) and then into reverse (R) before shifting back into neutral (N). Before continuing to tow, switch neutral tow on.*

# Towing Your Vehicle

---

## EMERGENCY TOWING - GASOLINE

If you need to tow your vehicle, contact a professional towing service or, if you are a member of a roadside assistance program, your roadside assistance service provider.

## EMERGENCY TOWING - FULL HYBRID ELECTRIC VEHICLE (FHEV)

If your vehicle becomes inoperable without access to wheel dollies or a vehicle transport trailer, it can be flat-towed with all wheels on the ground, regardless of the powertrain and transmission configuration, under the following conditions:

- Your vehicle is facing forward for towing in a forward direction.
- You switch **Neutral Tow** on.
- You release the parking brake.
- Maximum speed is 35 mph (55 km/h).
- Maximum distance is 50 mi (80 km).

## Switching **Neutral Tow** On

1. From the settings menu, press Vehicle. See **Center Display** (page 468).
2. Press and hold Neutral Tow until a confirmation message appears on the touchscreen.
3. Fully press the brake pedal.
4. Shift into neutral (N).
5. Switch the ignition off.

**Note:** *Failure to follow these instructions could result in damage to the transmission.*

**Note:** *Switching neutral tow on requires battery power.*

**Note:** *Put your climate control system in recirculated air mode to prevent exhaust fumes from entering your vehicle. See **Switching Recirculated Air On and Off** (page 143).*

## Switching **Neutral Tow** Off

1. Switch your vehicle on in accessory mode.
2. Fully press the brake pedal.

3. Shift into park (P).

# Fuses

## FUSE PRECAUTIONS

**⚠️ WARNING:** Always disconnect the battery before servicing high current fuses.

**⚠️ WARNING:** To reduce risk of electrical shock, always replace the cover to the power distribution box before reconnecting the battery or refilling fluid reservoirs.

**⚠️ WARNING:** Always replace a fuse with one that has the specified amperage rating. Using a fuse with a higher amperage rating can cause severe wire damage and could start a fire.

## UNDER HOOD FUSE BOX

### LOCATING THE UNDER HOOD FUSE BOX

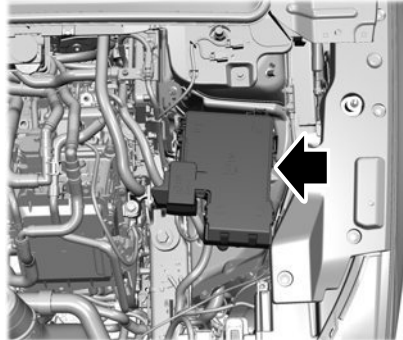

### ACCESSING THE UNDER HOOD FUSE BOX

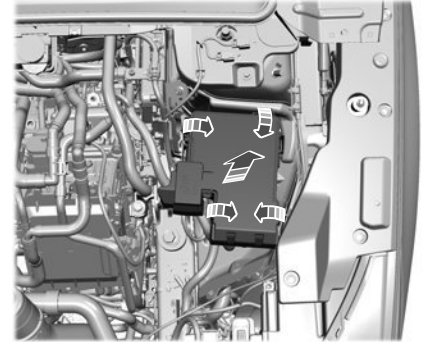

# Fuses

## IDENTIFYING THE FUSES IN THE UNDER HOOD FUSE BOX

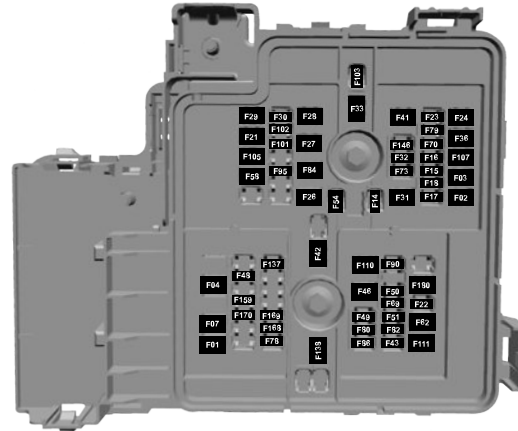

Fuse or Relay Number	Fuse Rating	Protected Components
1	30 A	Supply line body control module ignition 1.
2	30 A	Supply line body control module ignition 2.
3	40 A	Supply line body control module permanent power.

# Fuses

Fuse or Relay Number	Fuse Rating	Protected Components
4	60 A	Anti-lock brake system power 1. Electronic stability program power 1.
7	40 A	Anti-lock brake system power 2. Electronic stability program power 2.
14	5 A	Hybrid drive controller permanent power (hybrid).
15	15 A	Powertrain control module.
16	15 A	Exhaust gas sensors. Fuel system.
17	15 A	Air conditioning clutch. Grille shutter.
18	20 A	Exhaust gas sensors downstream.
21	40 A	Electric coolant heater 3.
22	30 A	Smart headlamp - right.
23	30 A	Smart headlamp - left.
24	30 A	Engine starter motor.
26	20 A	Fuel pump.
27	20 A	Cargo area power outlet.

# Fuses

Fuse or Relay Number	Fuse Rating	Protected Components
28	20 A	Center console power outlet. Front console power outlet.
30	5 A	USB smart charging type A. High mount camera.
31	30 A	Windshield wiper motor.
32	5 A	Windshield rain sensor.
33	60 A	Electric coolant heater 2.
36	40 A	Supply line body control module permanent power.
41	20 A	Running board - right.
42	40 A	Trailer tow module.
43	20 A	Interior fuse box supply.
46	30 A	Second row captain chairs control.
48	15 A	Audio amplifier 1.
49	10 A	Anti-lock brake system ignition supply. Electronic stability program ignition supply. Brakes ignition supply.
50	10 A	Powertrain control module ignition.



# Fuses

Fuse or Relay Number	Fuse Rating	Protected Components
51	10 A	Interior air quality sensor.
54	40 A	Rear window heater.
58	40 A	Electric coolant heater 1.
62	40 A	Front cooling pack blower motor.
69	5 A	Electric steering assist ignition supply.
70	10 A	On board diagnostic port power.
73	20 A	Rear wiper motor.
78	15 A	Heated windscreen wiper park area.
79	5 A	Smart headlamp control module.
80	15 A	Heated steering wheel.
82	10 A	Hybrid drive controller active power (hybrid).
84	15 A	Engine fuel injectors power.
86	10 A	Headlamp leveling motors.
90	15 A	Rear window washer.
95	10 A	Hybrid drive system control module (hybrid).
101	5 A	USB charging port 3 (console dual port - right).

# Fuses

Fuse or Relay Number	Fuse Rating	Protected Components
102	5 A	USB charging port 3 (console dual port - left).
103	10 A	USB smart dedicated charging port 3 (console).
105	25 A	Hybrid transmission oil pump.
107	30 A	Moonroof control module.
110	20 A	Running board - left.
111	30 A	Second row seat electric fold.
137	15 A	Audio amplifier 2.
138	60 A	Digital sound processor. Amplifier.
146	10 A	Traction battery control module (hybrid).
159	5 A	High voltage/12V transformer (hybrid).
168	5 A	Traction battery switch low voltage service disconnect (hybrid).
169	10 A	E-Drive electronics coolant pump (hybrid).
170	10 A	Traction battery coolant pump (hybrid). Acoustic vehicle alerting system (hybrid).
180	40 A	All wheel drive control module.

# Fuses

## INTERIOR FUSE BOX

### LOCATING THE INTERIOR FUSE BOX

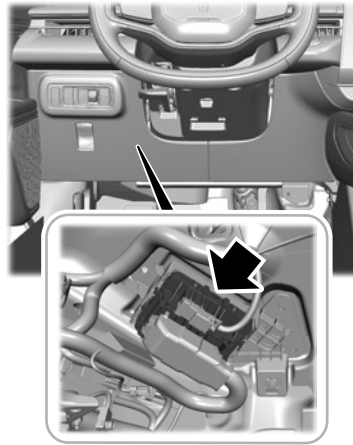

### ACCESSING THE INTERIOR FUSE BOX

The fuse box can be removed by releasing the tabs on either side. Exercise caution when moving the release tabs outward enough to release the detent.

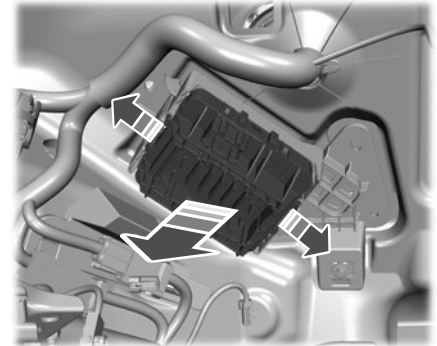

# Fuses

## IDENTIFYING THE FUSES IN THE INTERIOR FUSE BOX

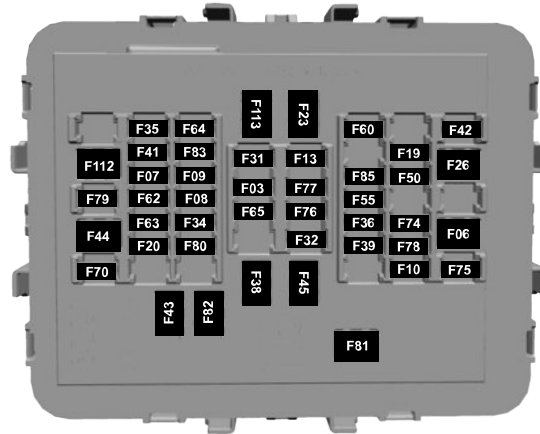

Fuse or Relay Number	Fuse Rating	Protected Components
3	7.5 A	Seat control switch. Wireless accessory control module.
6	30 A	Driver seat climate control.
7	7.5 A	Gear shift module.

# Fuses

Fuse or Relay Number	Fuse Rating	Protected Components
8	7.5 A	Telematics control module.
9	5 A	Interior anti-theft alarm sensor. Rear seat heater control module.
10	10 A	Driver seat massage.
13	7.5 A	Steering column module.
19	7.5 A	Bluetooth connectivity module.
20	5 A	Exterior lights switch.
23	30 A	Driver door control module.
26	30 A	Passenger door control module.
31	7.5 A	A/C control unit.
32	20 A	Voice control unit. Center display.
34	20 A	Multifunction display 2.
35	5 A	Electronic toll collection module 1.
36	5 A	Electronic toll collection module - ignition. Interior air particulate sensor.
38	40 A	High voltage power outlet.

# Fuses

Fuse or Relay Number	Fuse Rating	Protected Components
39	5 A	Hands-free power liftgate.
41	20 A	Multifunction display 3.
42	10 A	Keyless start remote key receiver.
43	30 A	Power liftgate.
44	30 A	Driver power seat.
45	30 A	Passenger power seat.
50	10 A	Left multi-contour seat control.
55	5 A	Electrochromatic rear view mirror.
60	10 A	Moonroof control module.
62	20 A	Driver power door latch.
63	20 A	Passenger power door latch.
64	20 A	Right rear power door latch.
65	20 A	Left rear power door latch.
70	20 A	Advanced driver assistance module.
75	10 A	Rear multi-contour seat 2.
76	7.5 A	Driver status monitor.

# Fuses

<b>Fuse or Relay Number</b>	<b>Fuse Rating</b>	<b>Protected Components</b>
77	20 A	Radio control unit.
78	10 A	A/C vents control.
79	10 A	Multifunction display 1.
80	5 A	Digital scent module.
81	20 A	Passenger door control module 2.
82	20 A	Driver door control module 2.
83	5 A	Driver keypad.
84	10 A	Rear electric multi-contour seat.
85	5 A	All wheel drive ignition power.
112	30 A	Left rear power seat.
113	30 A	Right rear power seat.

# Fuses

## IDENTIFYING FUSE TYPES

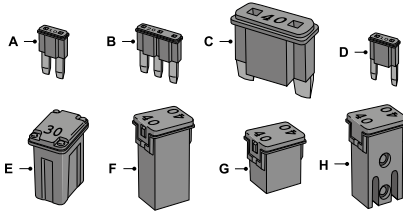

- A Micro 2.
- B Micro 3.
- C Maxi.
- D Mini.
- E M Case.
- F J Case.
- G J Case Low Profile.
- H Slotted M Case.

## FUSES – TROUBLESHOOTING

### FUSES – FREQUENTLY ASKED QUESTIONS

#### When do I need to check a fuse?

- If electrical components in the vehicle are not working.

#### When do I need to replace a fuse?

- If a fuse has blown.

#### How do I identify a blown fuse?

- You can identify a blown fuse by a broken wire within the fuse.



# Maintenance

## MAINTENANCE PRECAUTIONS

Service your vehicle regularly to help maintain its roadworthiness and resale value. There is a large network of authorized dealers that are there to help you with their professional servicing expertise. We believe that their specially trained technicians are best qualified to service your vehicle properly and expertly. They are supported by a wide range of highly specialized tools developed specifically for servicing your vehicle.

If your vehicle requires professional service, an authorized dealer can provide the necessary parts and service. Check your warranty information to find out which parts and services are covered.

Use only recommended fuels, lubricants, fluids and service parts conforming to specifications. See **Capacities and Specifications** (page 436).

- Do not work on a hot engine.
- Make sure that nothing gets caught in moving parts.

- Do not work on a vehicle with the engine running in an enclosed space, unless you are sure you have enough ventilation.
- Keep all open flames and other burning material, such as cigarettes, away from the battery and all fuel related parts.
- Set the parking brake, shift the transmission to park (P) and block the wheels.

## OPENING AND CLOSING THE HOOD

### Opening the Hood

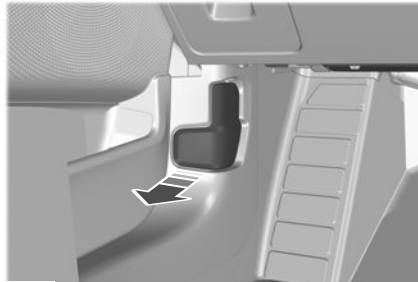

E356526

1. Open the left-hand front door and locate the hood release handle.
2. Fully pull the hood release handle and let it completely retract.

**Note:** *This action releases the hood latch.*

3. Fully pull the hood release handle for a second time.

**Note:** *This action fully releases the hood.*

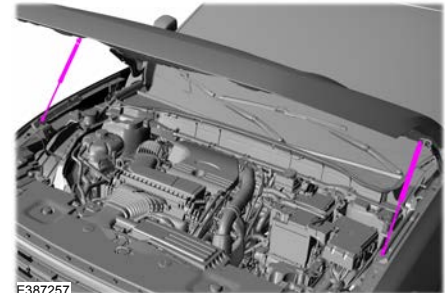

E387257

4. Open the hood.

**Note:** *There is no secondary hood release under the hood.*

**Note:** *The hood struts automatically support the hood.*

# Maintenance

---

## Closing the Hood

1. Lower the hood to a height of about 12–16 in (30–40 cm) from the closed position.
2. Firmly push down on the front of the hood to close it fully.

**Note:** *Make sure that the hood is correctly closed.*

**Note:** *If the hood does not close fully, open the hood and close it again.*

# Maintenance

## UNDER HOOD OVERVIEW - GASOLINE

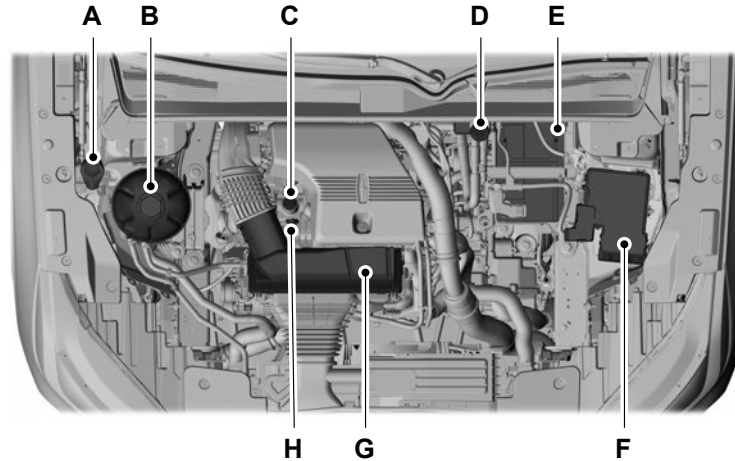

E391072

- A Washer fluid reservoir.
- B Engine coolant reservoir. See **Checking the Coolant Level** (page 381).
- C Engine oil filler cap. See **Checking the Engine Oil Level** (page 379).

# Maintenance

---

- D Brake fluid reservoir. See **Checking the Brake Fluid** (page 222).
- E Battery. See **Changing the 12V Battery** (page 388).
- F Engine compartment fuse box. See **Fuses** (page 361).
- G Air filter. See **Changing the Engine Air Filter** (page 380).
- H Engine oil dipstick. See **Engine Oil Dipstick Overview** (page 379).

# Maintenance

## UNDER HOOD OVERVIEW - FULL HYBRID ELECTRIC VEHICLE (FHEV)

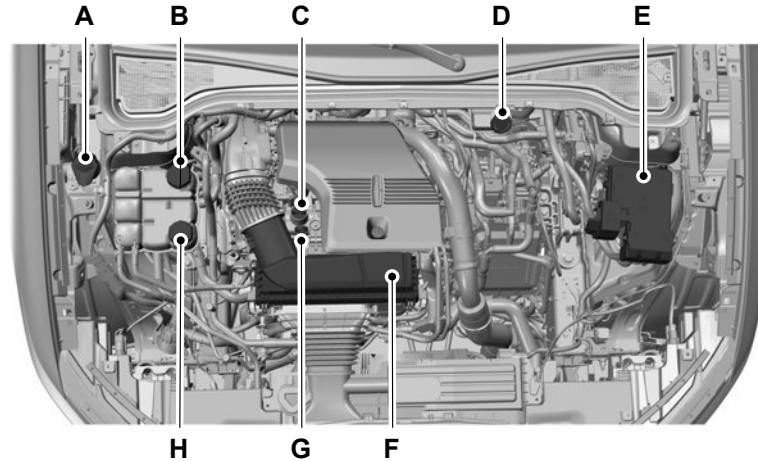

E410091

- A Washer fluid reservoir.
- B High voltage battery coolant reservoir. See **Adding Coolant** (page 382).
- C Engine oil filler cap. See **Checking the Engine Oil Level** (page 379).

# Maintenance

---

- D Brake fluid reservoir. See **Checking the Brake Fluid** (page 222).
- E Engine compartment fuse box. See **Fuses** (page 361).
- F Air filter. See **Changing the Engine Air Filter** (page 380).
- G Engine oil dipstick. See **Engine Oil Dipstick Overview** (page 379).
- H Engine coolant reservoir. See **Adding Coolant** (page 382).

# Maintenance

## ENGINE OIL

### ENGINE OIL DIPSTICK OVERVIEW

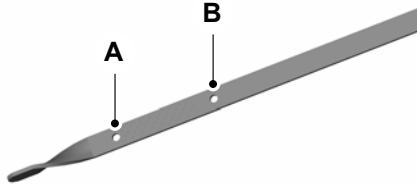

E389999

- A Minimum.
- B Maximum.

### CHECKING THE ENGINE OIL LEVEL

1. Make sure that your vehicle is on level ground.

2. Check the oil level before starting the engine, or switch the engine off after warm up and wait 15 minutes for the oil to drain into the oil pan.

**Note:** Checking the oil level too soon could result in an inaccurate reading.

3. Remove the dipstick and wipe it with a clean, lint-free cloth.
4. Reinstall the dipstick and make sure it is fully seated.
5. Remove the dipstick again to check the oil level.

**Note:** Read both sides of the dipstick and use the lowest oil level as the correct reading.

**Note:** If the oil level is between the maximum and minimum marks, the oil level is acceptable. Do not add oil.

6. If the oil level is at the minimum mark, immediately add oil.
7. Reinstall the dipstick. Make sure it is fully seated.

**Note:** The oil consumption of new engines reaches its normal level after approximately 3,000 mi (5,000 km).

**Note:** Increases in oil level can occur from frequent short trips that do not allow the engine to get to operating temperature, as well as frequent idling or low speed driving for long periods of time.

**Note:** If oil levels are continuously noted above the maximum mark, have your vehicle checked as soon as possible.

### ADDING ENGINE OIL



**WARNING:** Do not remove the filler cap when the engine is running.



**WARNING:** Do not add engine oil when the engine is hot. Failure to follow this instruction could result in personal injury.

# Maintenance

Do not use supplemental engine oil additives because they are unnecessary and could lead to engine damage that the vehicle warranty may not cover.

1. Clean the area surrounding the engine oil filler cap before you remove it.
2. Remove the engine oil filler cap.
3. Add engine oil that meets our specifications. See **Capacities and Specifications** (page 436).
4. Reinstall the engine oil filler cap. Turn it clockwise until you feel a strong resistance.

**Note:** *Do not add oil further than the maximum mark. Oil levels above the maximum mark may cause engine damage.*

**Note:** *Immediately soak up any oil spillage with an absorbent cloth.*

## INTELLIGENT OIL LIFE MONITOR

Under certain conditions the vehicle's intelligent oil life monitor may determine your oil requires replacement prior to your general service. Should this occur it is recommended you replace your oil within two weeks or 500 mi (800 km) of being alerted.

Your authorized dealer will be able to advise you whether only an engine oil and filter change is recommended or whether you should complete your general service inclusive of oil and oil filter.

## RESETTING THE INTELLIGENT OIL LIFE MONITOR

1. From the settings menu, press Vehicle Settings. See **Center Display** (page 468).
2. Press Oil Life.
3. Press and hold the **OK** button until the system reset confirmation appears.

## ENGINE OIL CAPACITY AND SPECIFICATION

For filling information, please refer to the Capacities and Specifications section of your owner's manual. See **Engine Oil Capacity and Specification** (page 441).

## ENGINE AIR FILTER

### CHANGING THE ENGINE AIR FILTER



**WARNING:** To reduce the risk of vehicle damage and personal burn injuries, do not start your engine with the air cleaner removed and do not remove it while the engine is running.

When servicing the air cleaner, it is important that no foreign material enter the air induction system. The engine and turbocharger are susceptible to damage from even small particles.



# Maintenance

Change the air filter element at the proper interval. See **Scheduled Maintenance** (page 493).

**Note:** *Failure to use the correct air filter element may result in severe engine damage. The customer warranty may be void for any damage to the engine if the correct air filter element is not used.*

## 2.0L

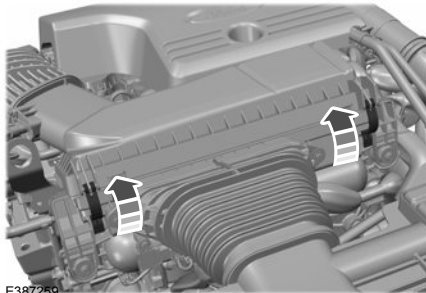

E387259

1. Release the clamps that secure the air filter housing cover.
2. Carefully lift the air filter housing cover.

3. Remove the air filter element from the air filter housing.
4. Wipe any dirt or debris from the air filter housing and cover to make sure no dirt gets in the engine and to make sure you have a good seal.
5. Install a new air filter element. Be careful not to crimp the filter element edges between the air filter housing and cover. This could cause filter damage and allow unfiltered air to enter the engine if not properly seated.
6. Install the air filter housing cover.
7. Engage the clamps to secure the air filter housing cover to the air filter housing.

## COOLANT

### CHECKING THE COOLANT LEVEL



**WARNING:** Do not remove the coolant reservoir cap when the engine is on or the cooling system is hot. Wait 10 minutes for the cooling system to cool down. Cover the coolant reservoir cap with a thick cloth to prevent the possibility of scalding and slowly remove the cap. Failure to follow this instruction could result in personal injury.



**WARNING:** To reduce the risk of personal injury, make sure the engine is cool before unscrewing the coolant pressure relief cap. The cooling system is under pressure. Steam and hot liquid can come out forcefully when you loosen the cap slightly.

# Maintenance

When the engine is cold, check the concentration and level of the coolant at the intervals listed in the scheduled maintenance information. See **Scheduled Maintenance** (page 493).

**Note:** Make sure that the coolant level is between the **MIN** and the **MAX** marks on the coolant reservoir.

**Note:** Coolant expands when it is hot. The level may extend beyond the **MAX** mark. This is normal.

Maintain coolant concentration within 48% to 50%, which equates to a freeze point between -29°F (-34°C) and -35°F (-37°C). Coolant concentration should be checked using a refractometer. We do not recommend the use of hydrometers or coolant test strips for measuring coolant concentration.

## ADDING COOLANT



**WARNING:** Do not add coolant when the vehicle is on or the cooling system is hot. Failure to follow this instruction could result in personal injury.



**WARNING:** Do not remove the coolant reservoir cap when the engine is on or the cooling system is hot. Wait 10 minutes for the cooling system to cool down. Cover the coolant reservoir cap with a thick cloth to prevent the possibility of scalding and slowly remove the cap. Failure to follow this instruction could result in personal injury.



**WARNING:** Do not allow the fluid to touch your skin or eyes. If this happens, rinse the affected areas immediately with plenty of water and contact your physician.



**WARNING:** Do not put coolant in the windshield washer reservoir. If sprayed on the windshield, coolant could make it difficult to see through the windshield.



**WARNING:** Do not add coolant further than the **MAX** mark.

**Note:** Do not use stop leak pellets, cooling system sealants, or non-specified additives as they can cause damage to the engine cooling or heating systems. Resulting component damage may not be covered by the vehicle Warranty.

**Note:** Automotive fluids are not interchangeable.

It is very important to use prediluted coolant approved to the correct specification in order to avoid plugging the small passageways in the engine cooling system. See **Capacities and Specifications** (page 436). Do not mix different colors or types of coolant in your vehicle. Mixing of engine coolants or using an incorrect coolant may harm the engine or cooling system components and may not be covered by the vehicle Warranty.

# Maintenance

---

**Note:** *If prediluted coolant is not available, use the approved concentrated coolant diluting it to 50/50 with deionised or distilled water. See **Capacities and Specifications** (page 436). Using water that has not been deionised may contribute to deposit formation, corrosion and plugging of the small cooling system passageways.*

**Note:** *Coolants marketed for all makes and models may not be approved to our specifications and may cause damage to the cooling system. Resulting component damage may not be covered by the vehicle Warranty.*

If the coolant level is at or below the minimum mark, add prediluted coolant immediately.

To top up the coolant level do the following:

1. Unscrew the cap slowly. Any pressure escapes as you unscrew the cap.
2. Add prediluted coolant approved to the correct specification. See **Capacities and Specifications** (page 436).
3. Add enough prediluted coolant to reach the correct level.

4. Replace the coolant reservoir cap. Turn the cap clockwise until it contacts the hard stop.
5. Check the coolant level in the coolant reservoir the next few times you drive your vehicle. If necessary, add enough prediluted engine coolant to bring the coolant level to the correct level.

If you have to add more than 1.1 qt (1 L) of engine coolant per month, have your vehicle checked as soon as possible. Operating an engine with a low level of coolant can result in engine overheating and possible engine damage.

In case of emergency, you can add a large amount of water without engine coolant in order to reach a vehicle service location.

Water alone, without engine coolant, can cause engine damage from corrosion, overheating or freezing.

Do not use the following as a coolant substitute:

- Alcohol.
- Methanol.

- Brine.
- Any coolant mixed with alcohol or methanol antifreeze.

Alcohol and other liquids can cause engine damage from overheating or freezing.

Do not add extra inhibitors or additives to the coolant. These can be harmful and compromise the corrosion protection of the coolant.

## CHANGING THE COOLANT

For coolant change, see your authorized dealer.

Changing the coolant is necessary at specific mileage intervals listed in the scheduled maintenance information. See **Scheduled Maintenance** (page 493).

# Maintenance

## MANAGING THE COOLANT TEMPERATURE

If you tow a trailer with your vehicle, the engine may temporarily reach a higher temperature during severe operating conditions, for example ascending a long or steep grade in high ambient temperatures.

At this time, you may notice the coolant temperature gauge moves toward the red zone and a message may appear in the information display.



**WARNING:** To reduce the risk of crash and injury, be prepared that the vehicle speed may reduce and the vehicle may not be able to accelerate with full power until the coolant temperature reduces.



**WARNING:** If you continue to drive your vehicle when the engine is overheating, the engine could stop without warning. Failure to follow this instruction could result in the loss of control of your vehicle.

You may notice a reduction in vehicle speed caused by reduced engine power in order to manage the engine coolant temperature. Your vehicle may enter this mode if certain high-temperature and high-load conditions take place. The amount of speed reduction depends on vehicle loading, grade and outside temperature. If this occurs, there is no need to stop your vehicle. You can continue to drive. See **Fail-Safe Cooling** (page 357).

The air conditioning may automatically turn on and off during severe operating conditions to protect the engine from overheating. When the coolant temperature decreases to the normal operating temperature, the air conditioning turns on.

If the coolant temperature gauge moves fully into the red zone, or if the coolant temperature warning or service engine soon messages appear in your information display, do the following:

1. Stop your vehicle as soon as it is safe to do so. Fully apply the parking brake, shift into park (P) or neutral (N).

2. Leave the engine running until the coolant temperature gauge needle returns to the normal position. If the temperature does not drop after several minutes, follow the remaining steps.
3. Switch the engine off and wait for it to cool. Check the coolant level.
4. If the coolant level is at or below the minimum mark, add prediluted coolant immediately.
5. If the coolant level is normal, restart the engine and continue.

## COOLANT – WARNING LAMPS



If the engine begins to overheat, the coolant temperature gauge moves toward the red zone.



A warning lamp illuminates and a message may appear in the information display.

# Maintenance

---

## COOLANT – INFORMATION MESSAGES

Message	Description and Action
High engine temperature Stop safely	Displays when the engine temperature is too high. Stop your vehicle as soon as it is safe to do so, switch the engine off and allow it to cool. If the problem persists, have your vehicle checked as soon as possible. See <b>Checking the Coolant Level</b> (page 381).

## CHANGING THE FUEL FILTER

Your vehicle has a lifetime fuel filter that integrates with the fuel tank. It does not need regular maintenance or replacement.

# Maintenance

## DRIVE BELT ROUTING OVERVIEW

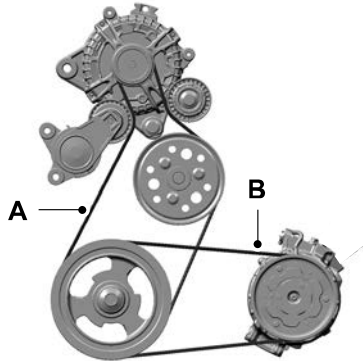



- A. The long drive belt is on the first pulley groove closest to the engine.
- B. The short drive belt is on the second pulley groove farthest from engine.

## 12V BATTERY

### 12V BATTERY PRECAUTIONS

 **WARNING:** Batteries normally produce explosive gases which can cause personal injury. Therefore, do not allow flames, sparks or lighted substances to come near the battery. When working near the battery, always shield your face and protect your eyes. Always provide correct ventilation.

 **WARNING:** When lifting a plastic-cased battery, excessive pressure on the end walls could cause acid to flow through the vent caps, resulting in personal injury and damage to the vehicle or battery. Lift the battery with a battery carrier or with your hands on opposite corners.

 **WARNING:** Keep batteries out of reach of children. Batteries contain sulfuric acid. Avoid contact with skin, eyes or clothing. Shield your eyes when working near the battery to protect against possible splashing of acid solution. In case of acid contact with skin or eyes, flush immediately with water for a minimum of 15 minutes and get prompt medical attention. If acid is swallowed, call a physician immediately.

 **WARNING:** Battery posts, terminals and related accessories contain lead and lead compounds, chemicals known to the State of California to cause cancer and reproductive harm. **Wash your hands after handling.**

# Maintenance



**WARNING:** This vehicle may have more than one battery. Removing the battery cables from only one battery does not disconnect your vehicle electrical system. Make sure you disconnect the battery cables from all batteries when disconnecting power. Failure to do so may cause serious personal injury or property damage.



**WARNING:** For vehicles with Auto-Start-Stop the battery requirement is different. You must replace the battery with one of exactly the same specification.

## WHAT IS THE BATTERY MANAGEMENT SYSTEM

The battery management system monitors battery conditions and takes actions to extend battery life.

## HOW DOES THE BATTERY MANAGEMENT SYSTEM WORK

If excessive battery drain is detected, the system temporarily disables some electrical systems to protect the battery.

Systems included are:

- Heated rear window.
- Heated seats.
- Climate control.
- Heated steering wheel.
- Audio unit.
- Navigation system.

A message could appear in the information display to alert you that battery protection actions are active. This message is only for notification that an action is taking place, and not intended to indicate an electrical problem or that the battery requires replacement.

## BATTERY MANAGEMENT SYSTEM LIMITATIONS

After battery replacement, or in some cases after charging the battery with an external charger, the battery management system requires eight hours of vehicle sleep time to relearn the battery state of charge. During this time, your vehicle must remain fully locked with the ignition switched off.

**Note:** *Prior to relearning the battery state of charge, the battery management system could temporarily disable some electrical systems.*

## Electrical Accessory Installation

To make sure the battery management system works correctly, do not connect an electrical device ground connection directly to the battery negative post. This can cause inaccurate measurements of the battery condition and potential incorrect system operation.

# Maintenance

---

**Note:** *If you add electrical accessories or components to the vehicle, it could adversely affect battery performance and durability. This could also affect the performance of other electrical systems in the vehicle.*

## CHANGING THE 12V BATTERY - GASOLINE

The battery is in the engine compartment. See **Maintenance** (page 373).

Your vehicle has a maintenance-free battery. It does not require additional water during service.

If the vehicle battery has a cover, make sure you correctly install it after cleaning or replacing the battery.

For longer, trouble-free operation, keep the top of the battery clean and dry and the battery cables tightly fastened to the battery terminals. If any corrosion is present on the battery or terminals, remove the cables from the terminals and clean with a wire brush. You can neutralize the acid with a solution of baking soda and water.

We recommend that you disconnect the negative battery cable terminal from the battery if you plan to store your vehicle for an extended period.

**Note:** *If you only disconnect the negative battery cable terminal, make sure it is isolated or placed away from the battery terminal to avoid unintended connection or arcing.*

If you disconnect or replace the battery and your vehicle has an automatic transmission, it must relearn its adaptive strategy. Because of this, the transmission may shift firmly when first driven. This is normal operation while the transmission fully updates its operation to optimum shift feel.

### Removing the Battery

1. Apply the parking brake and switch the ignition off.
2. Switch all electrical equipment off, for example lights and radio.
3. Wait a minimum of two minutes before disconnecting the battery.

**Note:** *The engine management system has a power hold function and remains powered for a period of time after you switch the ignition off. This is to allow diagnostic and adaptive tables to be stored. Disconnecting the battery without waiting can cause damage not covered by the vehicle Warranty.*

4. Disconnect and isolate the negative battery cable terminal.
5. Disconnect and isolate the positive battery cable terminal.
6. Remove the battery securing clamp.
7. Remove the battery.

If you disconnect or replace the vehicle battery, you must reset the following features:

- Window bounce-back. See **Window Bounce-Back** (page 125).
- Clock Settings.
- Pre-set radio stations.



# Maintenance

## Replacing the Battery

**Note:** Before reconnecting the battery, make sure the ignition remains switched off.

You must replace the battery with one of exactly the same specification.

To install, reverse the removal procedure.

**Note:** Make sure that you correctly install the battery terminal covers, battery cover and battery cable terminals.

## CHANGING THE 12V BATTERY - FULL HYBRID ELECTRIC VEHICLE (FHEV)

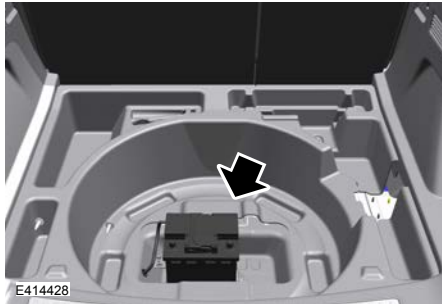

The 12V battery is located under the spare tire in the rear of the vehicle.

If the 12 volt battery needs servicing, see your authorized dealer.

## RESETTING THE BATTERY SENSOR

When you install a new battery, reset the battery sensor by doing the following:

1. Switch the ignition on, and leave the engine off.

**Note:** Complete Steps 2 and 3 within 10 seconds.

2. Flash the high beam headlamps five times, ending with the high beams off.
3. Press and release the brake pedal three times.

The battery warning lamp flashes three times to confirm that the reset is successful.

## RECYCLING AND DISPOSING OF THE 12V BATTERY



Make sure that you dispose of old batteries in an environmentally friendly way. Seek advice from your local authority about recycling old batteries.

## 12V BATTERY – TROUBLESHOOTING

### 12V BATTERY – WARNING LAMPS



If it illuminates while driving, it indicates a charging system error. Switch off all unnecessary electrical equipment and have your vehicle immediately checked.

# Maintenance

## 12V BATTERY – INFORMATION MESSAGES

Message	Details
Check Charging System	The charging system needs servicing. If the warning stays on or continues to come on, have your vehicle checked as soon as possible.
Charging System Service Soon	The charging system needs servicing. If the warning stays on or continues to come on, have your vehicle checked as soon as possible.
Charging System Service Now	The charging system needs servicing. Have your vehicle immediately checked.
Battery State of Charge Low	The battery management system determines that the 12V battery is at a low state of charge. Start the engine to charge the battery or charge the battery using an aftermarket battery charger. Always use the vehicle ground point when connecting the negative cable of the external battery charger. See <b>Jump Starting the Vehicle</b> (page 352). This message clears once you restart your vehicle and the battery state of charge has recovered. Do not switch on the ignition when a battery charger is in use to charge the battery.
Turn Power Off To Save Battery	The battery management system determines that the battery is at a low state of charge. Turn the ignition off as soon as possible to protect the battery. This message will clear once the vehicle has been started and the battery state of charge has recovered. Turning off unnecessary electrical loads will allow faster battery state-of-charge recovery.
Electrical Power Saver Active Some Features Turned Off See Manual	Displayed when the battery management system detects an extended low-voltage condition. Various vehicle features will be disabled to help preserve the battery. Turn off as many of the electrical loads as soon as possible to improve system voltage. If the system voltage has recovered, the disabled features will operate again as normal.

# Maintenance

## ADJUSTING THE HEADLAMPS

### Vertical Aim Adjustment

The headlamps on your vehicle are properly aimed at the assembly plant. If your vehicle has been involved in a crash, have the aim of the headlamp beam checked by an authorized dealer.

### Headlamp Aiming Target

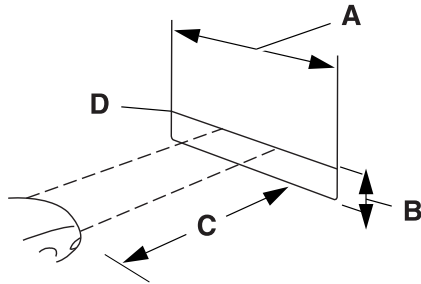

A 8 ft (2.4 m).

B Center height of lamp to ground.

C 25 ft (7.6 m).

D Horizontal reference line.

### Vertical Aim Adjustment Procedure

1. Park the vehicle directly in front of a wall or screen on a level surface, approximately 25 ft (7.6 m) away.
2. Measure the height of the headlamp bulb center from the ground and mark an 8 ft (2.4 m) horizontal reference line on the vertical wall or screen at this height.

**Note:** To see a clearer light pattern for adjusting, you may want to block the light from one headlamp while adjusting the other.

3. Turn on the low beam headlamps to illuminate the wall or screen and open the hood.



4. On the wall or screen you will observe a flat zone of high intensity light at the top of the right hand portion of the beam pattern. If the top edge of the high intensity light zone is not at the horizontal reference line, the headlamp needs to be adjusted.

# Maintenance

---

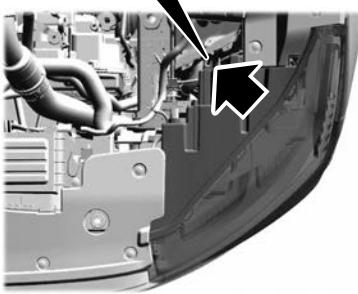

5. Locate the vertical adjuster on each headlamp. Using a Phillips #2 screwdriver, turn the adjuster either clockwise or counterclockwise in order to adjust the vertical aim of the headlamp. The horizontal edge of the brighter light should touch the horizontal reference line.
6. Close the hood and turn off the lamps.

# Maintenance

## EXTERIOR BULBS

### EXTERIOR BULB SPECIFICATION CHART

Lamp	Specification	Power (Watt)
Brake and rear lamp.	LED	LED
Central high mounted brake lamp.	LED	LED
Central lamp-position/parking	LED	LED
Daytime running lamps.	LED	LED
Front turn signal lamp.	LED	LED
Front side marker lamp.	LED	LED
Headlamp high beam.	LED	LED
Headlamp low beam.	LED	LED
License plate lamp.	LED	LED
Rear turn signal lamp.	LED	LED
Rear side marker lamp.	LED	LED
Reversing lamps.	LED	LED
Side direction indicator.	LED	LED

# Maintenance

---

**Note:** *LED lamps are not serviceable. See an authorized dealer if they fail.*

## **INTERIOR BULBS**

### **INTERIOR BULB SPECIFICATION CHART**

Your vehicle has LED lamps. These are not serviceable items. See an authorized dealer if they fail.

# Vehicle Care

## CLEANING PRODUCTS

For best results, use the following products or products of equivalent quality:

For additional information and assistance, we recommend that you contact an authorized dealer.

### Materials

Name	Specification
Motorcraft® Bug and Tar Remover, ZC-42 (U.S. & Canada)	
Motorcraft® Custom Bright Metal Cleaner, ZC-15 (U.S. & Canada)	ESR-M5B194-B
Motorcraft® Detail Wash, ZC-3-A (U.S. & Canada)	ESR-M14P4-A
Motorcraft® Engine Shampoo and Degreaser, ZC-20 (U.S.)	ESR-M14P3-A
Motorcraft® Engine Shampoo, CXC-66-A (Canada)	
Motorcraft® Premium Leather and Vinyl Cleaner, ZC-56 (U.S. & Canada)	
Motorcraft® Multi-Purpose Cleaner, CXC-101 (Canada)	
Motorcraft® Premium Windshield Wash Concentrate with Bitterant, ZC-32-B2 (U.S.)	WSS-M14P19-A
Motorcraft® Premium Quality Windshield Washer Fluid, CXC-37-F/M (Canada)	WSS-M14P19-A
Motorcraft® Professional Strength Carpet & Upholstery Cleaner, ZC-54 (U.S. & Canada)	
Motorcraft® Premium Glass Cleaner, CXC-100 (Canada)	ESR-M14P5-A

# Vehicle Care

Name	Specification
Motorcraft® Spot and Stain Remover, ZC-14 (U.S.)	
Motorcraft® Ultra-Clear Spray Glass Cleaner, ZC-23 (U.S.)	ESR-M14P5-A
Motorcraft® Wheel and Tire Cleaner, ZC-37-A (U.S. & Canada)	

## CLEANING THE EXTERIOR

### CLEANING THE EXTERIOR PRECAUTIONS

Immediately remove fuel spillages, additive residuals, bird droppings, insect deposits and road tar. These may cause damage to your vehicle's paintwork or trim over time.

Remove any exterior accessories, before entering a car wash.

### CLEANING HEADLAMPS AND REAR LAMPS

We recommend that you only use cold or lukewarm water containing car shampoo to clean the headlamps and the rear lamps.

Do not scrape the lamps.

Do not wipe lamps when they are dry.

### CLEANING WINDOWS AND WIPER BLADES

To clean the windshield and wiper blades:

- Clean the windshield with a non-abrasive glass cleaner.

**Note:** When cleaning the interior of the windshield, avoid getting any glass cleaner on the instrument panel or door panels. Wipe any glass cleaner off these surfaces immediately.

- Clean the wiper blades with washer fluid or water applied with a soft sponge or cloth.

**Note:** Do not use razor blades or other sharp objects to clean or remove decals from the inside of the heated rear window. This can cause damage not covered by the vehicle Warranty.

**Note:** We recommend cleaning the power sliding rear window at regular intervals to avoid dust and debris accumulation to deliver appropriate function.

### CLEANING CHROME, ALUMINIUM OR STAINLESS STEEL

We recommend that you only use a car shampoo, a soft cloth and water on bumpers and other chrome, aluminium or stainless steel parts.



# Vehicle Care

---

**Note:** For additional information and assistance, we recommend that you contact an authorized dealer.

**Note:** Rinse the area well after cleaning.

**Note:** Do not use abrasive materials, for example steel wool or plastic pads, as they can scratch these surfaces.

**Note:** Do not use chrome cleaner, metal cleaner or polish on wheels or wheel covers.

## CLEANING WHEELS

Only use a recommended wheel and tire cleaner to clean the wheels weekly. For additional information and assistance, we recommend that you contact an authorized dealer.

1. Use a sponge to remove heavy deposits of dirt and brake dust.
2. Rinse well after cleaning.

**Note:** Do not apply a cleaning chemical to warm or hot wheel rims and covers.

If you intend on parking your vehicle for an extended period after cleaning the wheels with a wheel cleaner, drive your vehicle for a few minutes before parking your vehicle. This reduces the risk of corrosion of the brake discs, brake pads and linings.

Do not clean the wheels when they are hot.

**Note:** Some car washes could damage wheel rims and covers.

**Note:** Using non-recommended cleaners, harsh cleaning products, chrome wheel cleaners or abrasive materials could damage wheel rims and covers.

## CLEANING THE ENGINE COMPARTMENT

Use a vacuum cleaner to remove debris from the screen area below windshield.

**Note:** If you are not familiar with the parts around the engine do not wash the engine compartment. Avoid frequent engine washes.

When washing the engine compartment:

- Never wash or rinse the engine while it is hot or running.
- Never wash or rinse any ignition coil, spark plug wire or spark plug well.
- Cover the battery, power distribution box, and air filter assembly to prevent water damage.

**Note:** If your vehicle has an engine cover remove the cover before application of shampoo and degreaser.

- Spray an approved engine shampoo and degreaser on all parts that require cleaning.

## CLEANING STRIPES OR GRAPHICS

It is recommended to wash your vehicle by hand however, pressure washing may be used under the following conditions:

- Use a spray with a minimum of 40° wide spray angle pattern.
- Keep the nozzle 12 in (30 cm) and at a 90° angle to your vehicle.

# Vehicle Care

- Do not use water pressure higher than 1,000 psi (6,895 kPa).
- Do not use water hotter than 73°F (23°C).

**Note:** *Holding the pressure washer nozzle at an angle to the vehicle's surface may damage graphics and cause the edges to peel away.*

## CLEANING CAMERA LENSES AND SENSORS

We recommend that you only use lukewarm or cold water and a soft cloth to clean the camera lens and sensors.

**Note:** *Do not pressure wash camera lens and sensors.*

## CLEANING THE UNDERBODY

Flush the complete underside of your vehicle frequently. Keep body and door drain holes free from packed dirt.

Rear suspension components may require regular cleaning with a power washer or a thorough rinse with a strong stream of water if the vehicle is operated in dusty or muddy environments. Rear leaf springs or other suspension components may emit squeaking or popping noises while operating the vehicle if particles, such as dirt, rocks, or other debris, are present in the components.

## CLEANING THE INTERIOR

### CLEANING THE INSTRUMENT PANEL

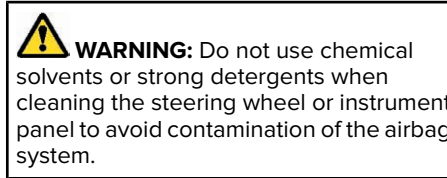

We recommend that you only clean the instrument panel and cluster lens with a damp soft cloth. Dry the area with a clean, soft cloth.

For additional information and assistance, we recommend that you contact an authorized dealer.

**Note:** *Avoid cleaners or polishes that increase the gloss of the upper portion of the instrument panel. The dull finish in this area helps protect you from undesirable windshield reflection.*

## CLEANING PLASTIC

We recommend that you only use a mild soap and water solution on a soft cloth. Dry the area with a clean, soft cloth.

## CLEANING DISPLAYS AND SCREENS

We recommend that you only use a microfiber cloth in a circular motion to clean off the fingerprint or dust.

If dirt or fingerprints are still on the screen, apply a small amount of alcohol to the cloth and try to clean it again.

**Note:** *Do not pour or spray alcohol onto the touchscreen.*

# Vehicle Care

**Note:** Do not use detergent or any type of solvent to clean the touchscreen.

## CLEANING FABRIC



**WARNING:** On vehicles equipped with seat-mounted airbags, do not use chemical solvents or strong detergents. Such products could contaminate the side airbag system and affect performance of the side airbag in a crash.

We recommend that you only clean fabric in the following way:

1. Remove dust and loose dirt with a vacuum cleaner.
2. Wipe the surface with a soft, damp cloth and a mild soap and water solution. Dry the area with a clean, soft cloth.
3. For additional information and assistance, we recommend that you contact an authorized dealer.

For heavy stains, spot clean the area. If a ring forms on the fabric, clean the entire area immediately, but do not oversaturate or the ring could set.

## CLEANING LEATHER



**WARNING:** On vehicles equipped with seat-mounted airbags, do not use chemical solvents or strong detergents. Such products could contaminate the side airbag system and affect performance of the side airbag in a crash.

We recommend that you only clean the leather surfaces in the following way:

1. Remove dust and loose dirt with a vacuum cleaner.
2. Wipe the surface with a soft, damp cloth and a mild soap and water solution. Dry the area with a clean, soft cloth.
3. Make sure the leather is dry, then apply a small amount of conditioner to a clean, dry cloth.

4. Rub the conditioner into the leather until it disappears. Allow the conditioner to dry, then repeat the process for the entire interior. If a film appears, wipe it off with a dry, clean cloth.
5. For additional information and assistance, we recommend that you contact an authorized dealer.

## CLEANING VINYL



**WARNING:** On vehicles equipped with seat-mounted airbags, do not use chemical solvents or strong detergents. Such products could contaminate the side airbag system and affect performance of the side airbag in a crash.

We recommend that you only clean vinyl surfaces in the following way:

1. Remove dust and loose dirt with a vacuum cleaner.
2. Wipe the surface with a soft, damp cloth and a mild soap and water solution. Dry the area with a clean, soft cloth.

# Vehicle Care

3. For additional information and assistance, we recommend that you contact an authorized dealer.

## CLEANING CARPETS AND FLOOR MATS

We recommend that you only clean your carpets in the following way:

1. Remove dust and loose dirt with a vacuum cleaner.
2. Wipe the surface with a soft, damp cloth and a mild soap and water solution. Dry the area with a clean, soft cloth.
3. For additional information and assistance, we recommend that you contact an authorized dealer.

For heavy stains, spot clean the area. If a ring forms on the fabric, clean the entire area immediately, but do not oversaturate or the ring could set.

We recommend that you only clean your floor mats in the following way:

1. Remove dust and loose dirt with a vacuum cleaner.

2. Wash rubber floor mats using mild soap and lukewarm or cold water.
3. Completely dry the floor mat before placing them back in your vehicle.

## CLEANING SEATBELTS



**WARNING:** Do not use cleaning solvents, bleach or dye on the vehicle's seatbelts, as these actions may weaken the belt webbing.

1. Wipe the surface with a soft, damp cloth and a mild soap and water solution. Dry the area with a clean, soft cloth.

## CLEANING STORAGE COMPARTMENTS

1. Remove dust and loose dirt with a vacuum cleaner.
2. Wipe the surface with a soft, damp cloth and a mild soap and water solution. Dry the area with a clean, soft cloth.

## CLEANING MOONROOF TRACKS

1. Remove debris from the tracks with a vacuum cleaner.
2. Wipe the bulb seal and mating painted roof metal surface with a soft, damp cloth and a mild soap and water solution.

**Note:** *The moonroof rail tracks are greased to maintain proper functionality. Do not wipe off the grease.*

## REPAIRING MINOR PAINT DAMAGE

We recommend that you contact an authorized dealer to identify your vehicle color code. Authorized dealers have touch-up paint to match your vehicle's color.

Before repairing minor paint damage, use a cleaner to remove particles such as bird droppings, tree sap, insect deposits, tar spots, road salt and industrial fallout.

Read the instructions before using cleaning products.

# Vehicle Care

---

## WAXING YOUR VEHICLE

Wax the high-gloss painted surface of your prewashed vehicle once or twice a year.

We recommend that you only use an approved quality wax that does not contain abrasives. Follow the manufacturer's instructions to apply and remove the wax. For additional information and assistance, we recommend that you contact an authorized dealer.

When washing and waxing, park your vehicle in a shaded area out of direct sunlight.

**Note:** *Avoid waxing unpainted or low-gloss black colored parts, they discolor over time.*

# Body Styling Kits

---

## **BODY STYLING KIT PRECAUTIONS**

The distance between the underside of your vehicle and the ground is less than that of other models. Drive with extreme care to avoid damage to your vehicle.

# Storing Your Vehicle

---

## PREPARING YOUR VEHICLE FOR STORAGE

If you plan on storing your vehicle for 30 days or more, the following maintenance recommendations ensures your vehicle stays in good operating condition.

Under various conditions, long-term storage may lead to degraded engine performance or failure unless you use specific precautions to preserve your vehicle.

### General

- Store all vehicles in a dry, ventilated place.
- If vehicles are stored outside, they require regular maintenance to protect against rust and weather damage.
- Make sure all linkages, cables, levers and pins under your vehicle are covered with grease to prevent rust.

- Move vehicles at least 25 ft (7.5 m) every 15 days to lubricate working parts and prevent corrosion.
- Fill the fuel tank with high-quality fuel until the first automatic shutoff of the fuel pump nozzle.

### Engine

- Change the engine oil and filter prior to storage because used engine oil contains contaminants which may cause engine damage.
- Start the engine every 15 days for a minimum of 15 minutes. Run at fast idle with the climate controls set to defrost until the engine reaches normal operating temperature.
- With your foot on the brake, shift through all the gears while the engine is running.

### Body

- Wash your vehicle thoroughly to remove dirt, grease, oil, tar or mud from exterior surfaces, rear wheel housings and the underside of front fenders.
- Periodically wash your vehicle if it is stored in exposed locations.
- Touch-up exposed or primed metal to prevent rust.
- Cover chrome and stainless steel parts with a thick coat of auto wax to prevent discoloration. Rewax as necessary when you wash your vehicle.
- Lubricate all hood, door and luggage compartment hinges and latches with a light grade oil.
- Cover interior trim to prevent fading.
- Keep all rubber parts free from oil and solvents.

# Storing Your Vehicle

---

## 12 Volt Battery

- When storing your vehicle for longer than 30 days the state of charge should be approximately 50%. Additionally, we recommend to disconnect the 12v battery to reduce system loads on the battery, or you can use a trickle charger for longer storage periods.
- Check and recharge as necessary. Keep connections clean.

**Note:** *It is necessary to reset memory features if you disconnect the battery cables.*

## Tires

- Maintain recommended air pressure.
- To minimize flat spots on the tires, inflate all four tires to the recommended cold pressures listed on the Safety Compliance Certification label or Tire Label affixed to your vehicle. When the vehicle is taken out of storage, reset the tire pressures as necessary to the recommended levels listed on the Safety Compliance Certification label or Tire Label affixed to your vehicle.

**Note:** *If you store your vehicle in a location with low ambient temperatures, follow the instructions for care of summer tires.*

## Brakes

Make sure the brakes and parking brake fully release.

**Note:** *If you intend on parking your vehicle for an extended period after cleaning the wheels with a wheel cleaner, drive your vehicle for a few minutes before doing so to reduce the risk of increased corrosion of the brake discs, brake pads and linings.*

## REMOVING YOUR VEHICLE FROM STORAGE

When your vehicle is ready to come out of storage, do the following:

- We recommend that you change the engine oil before you use your vehicle again.
- Wash your vehicle to remove any dirt or grease film build-up on window surfaces.

- Check windshield wipers for any deterioration.
- Check the underhood for any foreign materials such as mice or squirrel nests.
- Check the exhaust for any foreign materials.
- Check tire pressures and set tire inflation per the Tire Label.
- Check brake pedal operation. Corroded brake rotors could cause brake noise. Drive your vehicle and gently apply and release the brakes repeatedly over a 10-minute drive to reduce the corrosion from the brakes.
- Check fluid levels (including coolant, oil and gas) to make sure there are no leaks, and fluids are at recommended levels.
- If you remove the battery, clean the battery cable ends and check for damage.

Contact an authorized dealer if you have any concerns or issues.



# Wheel and Tire Information

## LOCATING THE TIRE LABEL

The tire label or safety certification label is on the driver side B-pillar or the edge of the driver door. It contains information on the recommended front and rear tire inflation pressures. See **Locating the Safety Compliance Certification Labels** (page 329).

## DEPARTMENT OF TRANSPORTATION UNIFORM TIRE QUALITY GRADES



Tire Quality Grades apply to new pneumatic passenger car tires. The Quality grades can be found where applicable on the tire sidewall between tread shoulder and maximum section width. For example: **Treadwear 200 Traction AA Temperature A**.

These Tire Quality Grades are determined by standards that the United States Department of Transportation has set.

Tire Quality Grades apply to new pneumatic passenger car tires. They do not apply to deep tread, winter-type snow tires, space-saver or temporary use spare tires, light truck or LT type tires, tires with nominal rim diameters of 10 to 12 inches or limited production tires as defined in Title 49 Code of Federal Regulations Part 575.104 (c)(2).

**U.S. Department of Transportation Tire quality grades:** The U.S. Department of Transportation requires us to give you the following information about tire grades exactly as the government has written it.

## Treadwear

The treadwear grade is a comparative rating based on the wear rate of the tire when tested under controlled conditions on a specified government test course. For example, a tire graded 150 would wear 1½ times as well on the government course as a tire graded 100. The relative performance of tires depends upon the actual conditions of their use, however, and may depart significantly from the norm due to variations in driving habits, service practices, and differences in road characteristics and climate.

## Traction AA A B C



**WARNING:** The traction grade assigned to this tire is based on straight-ahead braking traction tests, and does not include acceleration, cornering, hydroplaning or peak traction characteristics.

# Wheel and Tire Information

The traction grades, from highest to lowest are AA, A, B, and C. The grades represent the tire's ability to stop on wet pavement as measured under controlled conditions on specified government test surfaces of asphalt and concrete. A tire marked C may have poor traction performance.

## Temperature A B C



**WARNING:** The temperature grade for this tire is established for a tire that is properly inflated and not overloaded. Excessive speed, underinflation, or excessive loading, either separately or in combination, can cause heat buildup and possible tire failure.

The temperature grades are A (the highest), B and C, representing the tire's resistance to the generation of heat and its ability to dissipate heat when tested under controlled conditions on a specified indoor laboratory test wheel. Sustained high temperature can cause

the material of the tire to degenerate and reduce tire life, and excessive temperature can lead to sudden tire failure. The grade C corresponds to a level of performance which all passenger car tires must meet under the Federal Motor Vehicle Safety Standard No. 139. Grades B and A represent higher levels of performance on the laboratory test wheel than the minimum required by law.

## INFORMATION ON THE TIRE SIDEWALL

Both United States and Canada Federal regulations require tire manufacturers to place standardized information on the sidewall of all tires. This information identifies and describes the fundamental characteristics of the tire and also provides a U.S. DOT Tire Identification Number for safety standard certification and in case of a recall.

## Information on P Type Tires

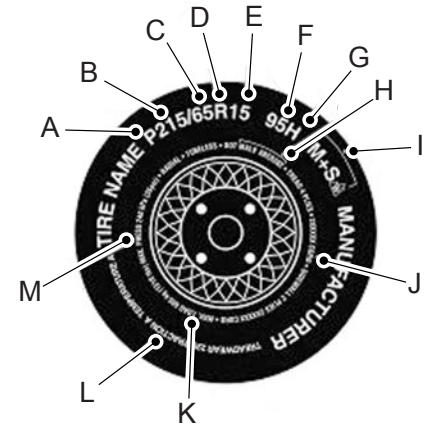

P215/65R15 95H is an example of a tire size, load index and speed rating. The definitions of these items are listed below. (Note that the tire size, load index and speed rating for your vehicle may be different from this example.)

## Wheel and Tire Information

A. **P:** Indicates a tire, designated by the Tire and Rim Association, that may be used for service on cars, sport utility vehicles, minivans and light trucks. **Note:** If your tire size does not begin with a letter this may mean it is designated by either the European Tire and Rim Technical Organization or the Japan Tire Manufacturing Association.

B. **215:** Indicates the nominal width of the tire in millimeters from sidewall edge to sidewall edge. In general, the larger the number, the wider the tire.

C. **65:** Indicates the aspect ratio which gives the tire's ratio of height to width.

D. **R:** Indicates a radial type tire.

E. **15:** Indicates the wheel or rim diameter in inches. If you change your wheel size, you will have to purchase new tires to match the new wheel diameter.

F. **95:** Indicates the tire's load index. It is an index that relates to how much weight a tire can carry. You may find this information in your owner's manual. If not, contact a local tire dealer.

**Note:** *You may not find this information on all tires because it is not required by federal law.*

G. **H:** Indicates the tire's speed rating. The speed rating denotes the speed at which a tire is designed to be driven for extended periods of time under a standard condition of load and inflation pressure. The tires on your vehicle may operate at different conditions for load and inflation pressure. These speed ratings may need to be adjusted for the difference in conditions. The ratings range from 81 mph (130 km/h) to 186 mph (300 km/h). These ratings are listed in the following chart.

**Note:** *You may not find this information on all tires because it is not required by federal law.*

Letter rating	Speed rating
M	81 mph (130 km/h)
N	87 mph (140 km/h)
Q	99 mph (160 km/h)
R	106 mph (170 km/h)
S	112 mph (180 km/h)
T	118 mph (190 km/h)
U	124 mph (200 km/h)
H	130 mph (210 km/h)
V	149 mph (240 km/h)

# Wheel and Tire Information

Letter rating	Speed rating
W	168 mph (270 km/h)
Y	186 mph (300 km/h)

**Note:** For tires with a maximum speed capability over 149 mph (240 km/h), tire manufacturers sometimes use the letters ZR. For those with a maximum speed capability over 186 mph (299 km/h), tire manufacturers always use the letters ZR.

**H. U.S. DOT Tire Identification Number (TIN):** This begins with the letters DOT and indicates that the tire meets all federal standards. The next two numbers or letters are the plant code designating where it was manufactured, the next two are the tire size code and the last four numbers represent the week and year the tire was built. For example, the numbers 317 mean the 31st week of 1997. After 2000, the numbers

go to four digits. For example, 2501 means the 25th week of 2001. The numbers in between are identification codes used for traceability. This information is used to contact customers if a tire defect requires a recall.

I. **M+S or M/S:** Mud and Snow, or

**AT:** All Terrain, or

**AS:** All Season.

### J. Tire Ply Composition and Material

**Used:** Indicates the number of plies or the number of layers of rubber-coated fabric in the tire tread and sidewall. Tire manufacturers also must indicate the ply materials in the tire and the sidewall, which include steel, nylon, polyester, and others.

K. **Maximum Load:** Indicates the maximum load in kilograms and pounds that can be carried by the tire. See the Safety Compliance Certification Label (affixed to either the door hinge pillar, door-latch post, or the door edge that meets the door-latch post, next to the driver's seating position), for the correct tire pressure for your vehicle.

### L. Treadwear, Traction and Temperature Grades:

\***Treadwear** The treadwear grade is a comparative rating based on the wear rate of the tire when tested under controlled conditions on a specified government test course. For example, a tire graded 150 would wear one and one-half times as well on the government course as a tire graded 100.

## Wheel and Tire Information

**\*Traction:** The traction grades, from highest to lowest are AA, A, B, and C. The grades represent the tire's ability to stop on wet pavement as measured under controlled conditions on specified government test surfaces of asphalt and concrete. A tire marked C may have poor traction performance.

**\*Temperature:** The temperature grades are A (the highest), B and C, representing the tire's resistance to the generation of heat and its ability to dissipate heat when tested under controlled conditions on a specified indoor laboratory test wheel.

### M. Maximum Inflation Pressure:

Indicates the tire manufacturers' maximum permissible pressure or the pressure at which the maximum load can be carried by the tire. This pressure is normally higher than the vehicle manufacturer's recommended cold inflation pressure which can be found on the Safety Compliance Certification Label (affixed to either the door hinge pillar, door-latch post, or the door edge that meets the door-latch post, next to

the driver's seating position), or Tire Label which is located on the B-Pillar or the edge of the driver's door. The cold inflation pressure should never be set lower than the recommended pressure on the vehicle label.

The tire suppliers may have additional markings, notes or warnings such as standard load or radial tubeless.

### Additional Information Contained on the Tire Sidewall for LT Type Tires

**Note:** *Tire Quality Grades do not apply to this type of tire.*

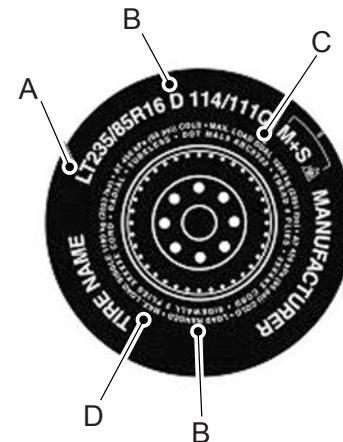

LT type tires have some additional information beyond those of P type tires; these differences are described below.

**A. LT:** Indicates a tire, designated by the Tire and Rim Association, that is intended for service on light trucks.

# Wheel and Tire Information

## B. Load Range and Load Inflation

**Limits:** Indicates the tire's load-carrying capabilities and its inflation limits.

## C. Maximum Load Dual lb (kg) at psi

**(kPa) cold:** Indicates the maximum load and tire pressure when the tire is used as a dual, defined as four tires on the rear axle (a total of six or more tires on the vehicle).

## D. Maximum Load Single lb (kg) at psi

**(kPa) cold:** Indicates the maximum load and tire pressure when the tire is used as a single, defined as two tires (total) on the rear axle.

## Information on T Type Tires

T145/80D16 is an example of a tire size.

**Note:** *The temporary tire size for your vehicle may be different from this example. Tire Quality Grades do not apply to this type of tire.*

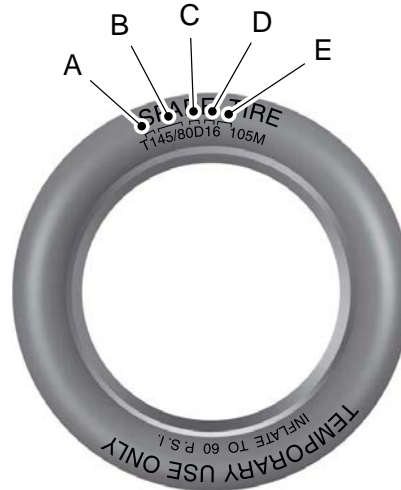

T type tires have some additional information beyond those of P type tires; these differences are described below:

A. **T:** Indicates a type of tire, designated by the Tire and Rim Association, that is intended for temporary service on cars, sport utility vehicles, minivans and light trucks.

B. **145:** Indicates the nominal width of the tire in millimeters from sidewall edge to sidewall edge. In general, the larger the number, the wider the tire.

C. **80:** Indicates the aspect ratio which gives the tire's ratio of height to width. Numbers of 70 or lower indicate a short sidewall.

D. **D:** Indicates a diagonal type tire.

**R:** Indicates a radial type tire.

E. **16:** Indicates the wheel or rim diameter in inches. If you change your wheel size, you will have to purchase new tires to match the new wheel diameter.

# Wheel and Tire Information

---

## GLOSSARY OF TIRE TERMINOLOGY

**\*Tire label:** A label showing the original equipment tire sizes, recommended inflation pressure and the maximum weight the vehicle can carry.

**\*Tire Identification Number (TIN):** A number on the sidewall of each tire providing information about the tire brand and manufacturing plant, tire size and date of manufacture. Also referred to as DOT code.

**\*Inflation pressure:** A measure of the amount of air in a tire.

**\*Standard load:** A class of P-metric or Metric tires designed to carry a maximum load at set pressure. For example: For P-metric tires 35 psi (2.4 bar) and for Metric tires 36 psi (2.5 bar). Increasing the inflation pressure beyond this pressure will not increase the tire's load carrying capability.

**\*Extra load:** A class of P-metric or Metric tires designed to carry a heavier maximum load at 42 psi (2.9 bar). Increasing the inflation pressure beyond this pressure will not increase the tire's load carrying capability.

**\*kPa:** Kilopascal, a metric unit of air pressure.

**\*PSI:** Pounds per square inch, a standard unit of air pressure.

**\*Cold tire pressure:** The tire pressure when the vehicle has been stationary and out of direct sunlight for an hour or more and prior to the vehicle being driven for 1 mi (1.6 km).

**\*Recommended inflation pressure:** The cold inflation pressure found on the Safety Compliance Certification Label (affixed to either the door hinge pillar, door-latch post, or the door edge that meets the door-latch post, next to the driver's seating position), or Tire Label located on the B-Pillar or the edge of the driver door.

**\* B-pillar:** The structural member at the side of the vehicle behind the front door.

**\*Bead area of the tire:** Area of the tire next to the rim.

**\* Sidewall of the tire:** Area between the bead area and the tread.

**\*Tread area of the tire:** Area of the perimeter of the tire that contacts the road when mounted on the vehicle.

**\*Rim:** The metal support (wheel) for a tire or a tire and tube assembly upon which the tire beads are seated.

## TIRE REPLACEMENT REQUIREMENTS

Your vehicle is equipped with tires designed to provide a safe ride and handling capability.

## Wheel and Tire Information



**WARNING:** Only use replacement tires and wheels that are the same size, load index, speed rating, and type as those originally provided for your vehicle. The recommended tire and wheel sizes can be found on the Tire Label on the driver side door frame or the edge of the driver door. If this information is not found in those locations, or for additional options, contact your authorized dealer. Use of any tire or wheel not recommended, could affect the safety and performance of your vehicle, which could result in an increased risk of loss of vehicle control, vehicle rollover, personal injury and death.



**WARNING:** To reduce the risk of serious injury, when mounting replacement tires and wheels, you should not exceed the maximum pressure indicated on the sidewall of the tire to set the beads without additional precautions listed below. If the beads do not seat at the maximum pressure indicated, re-lubricate and try again.



**WARNING:** For a mounting pressure more than 20 psi (1.38 bar) greater than the maximum pressure, a Ford dealer or other tire service professional should do the mounting.



**WARNING:** Always inflate steel carcass tires with a remote air fill with the person inflating standing at a minimum of 12 ft (3.66 m) away from the wheel and tire assembly.



**WARNING:** Only use the specified jacking points. If you use any other locations you could damage vehicle components, such as brake lines.



**WARNING:** When inflating the tire for mounting pressures up to 20 psi (1.38 bar) greater than the maximum pressure on the tire sidewall, the following precautions must be taken to protect the person mounting the tire:

- Make sure that you have the correct tire and wheel size.
- Lubricate the tire bead and wheel bead seat area again.
- Stand at a minimum of 12 ft (3.66 m) away from the wheel and tire assembly.
- Use both eye and ear protection.

**Important:** Remember to replace the wheel valve stems when the road tires are replaced on your vehicle.



# Wheel and Tire Information

It is recommended that the two front tires or two rear tires generally be replaced as a pair if the worn tires still have usable depth.

To avoid potential All-Wheel Drive (AWD) malfunction or (AWD) system damage, it is recommended to replace all four tires rather than mixing significantly worn tires with new tires.

The tire pressure sensors mounted in the wheels (originally installed on your vehicle) are not designed to be used in aftermarket wheels.

The use of wheels or tires not recommended may affect the operation of your tire pressure monitoring system.

If the tire pressure monitoring system indicator is flashing, your system is malfunctioning. Your replacement tire might be incompatible with your tire pressure monitoring system, or some component of the system may be damaged.

## Age



**WARNING:** Tires degrade over time depending on many factors such as weather, storage conditions, and conditions of use (load, speed, inflation pressure) the tires experience throughout their lives.

In general, tires should be replaced after six years regardless of tread wear. However, heat caused by hot climates or frequent high loading conditions can accelerate the aging process and may require tires to be replaced more frequently.

You should replace your spare tire when you replace the road tires or after six years due to aging even if it has not been used.

## U.S. DOT Tire Identification Number

Both United States and Canada Federal regulations require tire manufacturers to place standardized information on the sidewall of all tires. This information identifies and describes the fundamental characteristics of the tire and also provides a U.S. DOT Tire Identification Number for safety standard certification and in case of a recall.

This begins with the letters DOT and indicates that the tire meets all federal standards. The next two numbers or letters are the plant code designating where it was manufactured, the next two are the tire size code and the last four numbers represent the week and year the tire was built. For example, the numbers 317 mean the 31st week of 1997. After 2000, the numbers go to four digits. For example, 2501 means the 25th week of 2001. The numbers in between are identification codes used for traceability. This information is used to contact customers if a tire defect requires a recall.

# Wheel and Tire Information

## USING SNOW CHAINS

 **WARNING:** Do not exceed 30 mph (50 km/h). Failure to follow this instruction could result in the loss of control of your vehicle, personal injury or death.

 **WARNING:** Do not use snow chains on snow-free roads.

 **WARNING:** Only fit snow chains to specified tires.

 **WARNING:** If your vehicle is fitted with wheel trims, remove them before fitting snow chains.

 **WARNING:** Wheels and tires must be the same size, load index and speed rating as those originally fitted on the vehicle. Use of any other tire or wheel can affect the safety and performance of your vehicle. Additionally, the use of non-recommended tires and wheels can cause steering, suspension, axle, transfer case or power transfer unit failure. Follow

the recommended tire inflation pressures found on the Safety Compliance Certification label, or the Tire Label on the B-Pillar or the edge of the driver door. Failure to follow this instruction could result in loss of vehicle control, vehicle rollover, or personal injury or death.

 **WARNING:** If you are driving in slippery conditions that require tire chains or cables, then it is critical that you drive cautiously. Keep speeds down, allow for longer stopping distances and avoid aggressive steering to reduce the chances of a loss of vehicle control which can lead to serious injury or death. If the rear end of your vehicle slides while cornering, steer in the direction of the slide until you regain control of your vehicle.

Only use snow chains on the front wheels. Install snow chains in pairs. Do not use self-tensioning snow chains.

Only use snow chains on the following specified tire size:

- 235/55R20 all season tires.
  - Only use ultra low profile snow chains that are 10 mm or less.

We recommend you use steel wheels of the same size and specification if snow chains are required because chains may chip aluminum wheels.

Do not use snow chains or cables with 255/60R19, 255/55R20, 255/50R21 or 255/45R22.

Follow these guidelines when using snow tires and traction devices:

- If possible, avoid fully loading your vehicle.
- Purchase snow chains from a manufacturer that clearly labels body to tire dimension restrictions.
- When driving with snow chains do not exceed 30 mph (50 km/h) or the maximum speed recommended by the chain manufacturer, whichever is less.

# Wheel and Tire Information

---

- Drive cautiously. If you hear the snow chains rub or bang against the vehicle, stop and tighten them. If this does not work, remove the snow chains to prevent vehicle damage.
- Remove the snow chains when they are no longer needed. Do not use snow chains on dry roads.
- If a temporary spare wheel is mounted on your vehicle, do not use snow chains on the axle with the temporary spare wheel.
- Use snow chains that fit against the sidewall of the tire to prevent the chains from touching the wheel rims or suspension.

If you have any questions regarding snow tires or snow chains, contact your authorized dealer.

# Tire Care

## CHECKING THE TIRE PRESSURES

Safe operation of your vehicle requires that your tires are properly inflated. Every day before you drive, check your tires.

At least once a month and before long trips, inspect each tire and check the tire pressure with a tire gauge. Inflate all tires to the recommended inflation pressure. See **Inflating the Tires** (page 416).

## INFLATING THE TIRES



**WARNING:** Under-inflation is the most common cause of tire failures and may result in severe tire cracking, tread separation or blowout, with unexpected loss of vehicle control and increased risk of injury. Under-inflation increases sidewall flexing and rolling resistance, resulting in heat buildup

and internal damage to the tire. It also may result in unnecessary tire stress, irregular wear, loss of vehicle control and accidents. A tire can lose up to half of its air pressure and not appear to be flat!



**WARNING:** Do not use the tire pressure displayed in the information display as a tire pressure gauge. Failure to follow this instruction could result in personal injury or death.

Use the recommended cold inflation pressure for optimum tire performance and wear. Under-inflation or over-inflation may cause uneven treadwear patterns.

Inflate your tires to the recommended inflation pressure even if it is less than the maximum inflation pressure information found on the tire. You can find the tire label with the recommended tire inflation pressure next to the tire size on the B-Pillar or the edge of the driver door.

The recommended tire inflation pressure is also found on the Safety Compliance Certification Label, affixed to either the door hinge pillar, door-latch post, or the door edge that meets the door-latch on the B-pillar, or on the edge of the driver door.

Failure to follow the tire pressure recommendations can cause uneven treadwear patterns and adversely affect the way your vehicle handles.

## Checking Pressure when tires are hot:

If pressures are checked after tires have been driven for more than three minutes or more than 1 mile, (2 km) the tires become hot and the pressures will increase by approximately 4 psi (27.6 kPa). Therefore when the tire pressure is adjusted under these conditions, it should be increased to a gauge reading of 4 psi (27.6 kPa) greater than the recommended cold inflation pressure.

After inflating the tires while hot, make sure to recheck tire pressure later once the tires are cold.

# Tire Care

## For Example Only

Gauge reading of hot tire	33 psi (230 kPa)
If recommended, cold inflation pressure is	32 psi (220 kPa)
The hot tire pressure is only 1 psi (10 kPa) greater than the recommended cold inflation pressure. Therefore, add 3 psi (20 kPa) more to increase the hot pressure to 4 psi (30 kPa) over the recommended cold inflation pressure.	

New hot pressure | 36 psi (250 kPa)

## INSPECTING THE TIRE FOR WEAR

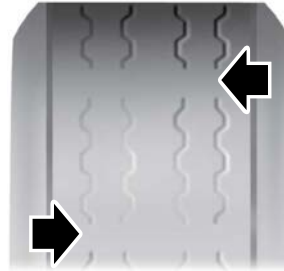

When the tread is worn down to 2/32 inch (1.6 mm), tires must be replaced to help prevent your vehicle from skidding and hydroplaning. Built-in treadwear indicators, or wear bars, which look like narrow strips of smooth rubber across the tread will appear on the tire when the tread is worn down to 2/32 inch (1.6 mm).

When the tire tread wears down to the same height as these wear bars, the tire is worn out and must be replaced.

The tires should also be balanced periodically. An unbalanced tire and wheel assembly may result in irregular tire wear.

Periodically inspect the tire treads for uneven or excessive wear and remove objects such as stones, nails or glass that may be wedged in the tread grooves.

## INSPECTING THE TIRE FOR DAMAGE

Inspect the tire sidewalls for cracking, cuts, bruises and other signs of damage or excessive wear. If internal damage to the tire is suspected, have the tire dismounted and inspected in case it needs to be repaired or replaced. For your safety, tires that are damaged or show signs of excessive wear should not be used because they are more likely to blow out or fail.

# Tire Care

Periodically inspect the tire treads and sidewalls for damage, such as bulges in the tread or sidewalls, cracks in the tread groove and separation in the tread or sidewall. If damage is observed or suspected, have the tire inspected by a tire professional.

## Safety Practices



**WARNING:** If your vehicle is stuck in snow, mud or sand, do not rapidly spin the tires; spinning the tires can tear the tire and cause an explosion. A tire can explode in as little as three to five seconds.



**WARNING:** Do not spin the wheels at over 34 mph (55 km/h). The tires may fail and injure a passenger or bystander.

## HIGH SPEED DRIVING CAN BE DANGEROUS

Correct inflation pressure is especially important. However, at high speeds, even with the correct inflation pressure, a road hazard for example is more difficult to avoid and if contact is made, has a greater chance of causing tire damage than at a lower speed. Moreover, driving at high speed reduces the reaction time available to avoid accidents and bring your vehicle to a safe stop.

If you see any damage to a tire or wheel, replace it with the spare at once and visit a participating Tire Retailer.

Exceeding the maximum speeds shown on the following page for each type of tire will cause the tire to build up excessive heat which can cause tire damage that could result in sudden tire destruction and rapid air loss. Failure to control a vehicle when one or more tires experience a sudden air loss can lead to an accident.

**In any case, you should not exceed reasonable speeds as indicated by the legal limits and driving conditions.**

## DO NOT OVERLOAD: DRIVING ON ANY OVERLOADED TIRE IS DANGEROUS

The maximum load rating of your tires is molded on the tire sidewall. Do not exceed this rating. Follow the loading instructions of the manufacturer of your vehicle and this will ensure that your tires are not overloaded. Tires which are loaded beyond their maximum allowable loads for the particular application will build up excessive heat that may result in sudden tire destruction. Do not exceed the gross axle weight rating for any axle on your vehicle.

# Tire Care

---

## TIRE ALTERATIONS

Do not make or allow to be made any alterations on your tires. Alterations may prevent proper performance, leading to tire damage which can result in an accident. Tires which become unserviceable due to alterations such as truing, whitewall inlays, addition of balancing or sealant liquids, or the use of tire dressing containing petroleum distillates are excluded from warranty coverage.

## REPAIRS - WHEREVER POSSIBLE, SEE YOUR TIRE RETAILER AT ONCE

If any tire sustains a puncture, have the tire demounted and thoroughly inspected by a tire retailer for possible damage that may have occurred. A tread area puncture in any passenger or light truck tire can be repaired provided that the puncture hole is not more than 1/4" in diameter, not more than one radial cable per casing ply is damaged, and the tire has not been damaged further by the puncturing object or by running

underinflated. Tire punctures consistent with these guidelines should only be repaired by following the US Tire Manufacturers Association (USTMA) recommended repair procedures. Plug-only repairs done on-the-wheel are considered improper and therefore, not recommended. Such repairs are not reliable and may cause further damage to the tire.

## STORAGE

Tires contain waxes and emollients to protect their outer surfaces from ozone and weather checking. As the tire rolls and flexes, the waxes and emollients continually migrate to the surface, replenishing this protection throughout the normal use of the tire. Consequently, when tires sit unused for long periods of time (a month or more) their surfaces become dry and more susceptible to ozone and weather checking and the casing becomes susceptible to flat spotting. **For this reason, tires should always be stored in a cool, dry, clean, indoor environment. If storage is for**

**one month or more, eliminate the weight from the tires by raising the vehicle or by removing the tires from the vehicle. Failure to store tires in accordance with these instructions could result in damage to your tires or premature aging of the tires and sudden tire failure.**

When tires are stored, be sure they are placed away from sources of heat and ozone such as direct sunlight, hot pipes and electric generators. Be sure that surfaces on which tires are stored are clean and free from grease, gasoline or other substances, which could deteriorate the rubber. Failure to store tires in accordance with these instructions could result in damage to your tires or premature aging of the tires and sudden tire failure.

# Tire Care

---

## **FOLLOW THESE MOUNTING RECOMMENDATIONS**

**Tire changing can be dangerous and must be done by professionally trained persons using proper tools and procedures as specified by the US Tire Manufacturers Association (USTMA). Single or dual assemblies must be completely deflated before demounting.**

Your tires should be mounted on wheels of correct size and type and which are in good, clean condition. Wheels that are bent, chipped, rusted (steel wheels) or corroded (alloy wheels) may cause tire damage. The inside of the tire must be free from foreign material. Have your retailer check the wheels before mounting new tires. Mismatched tires and rims can explode during mounting. Also, mismatched tires and rims can result in dangerous tire failure on the road. If a tire is mounted by error on the

wrong-sized rim, do not remount it on the proper rim - scrap it. It may have been damaged internally (which is not externally visible) by having been dangerously stretched and could fail on the highway.

**Old valves may leak. When new tubeless tires are mounted, have new valves of the correct type installed. Tubeless tires must only be mounted on wheels designed for tubeless tires i.e., wheels which have safety humps or ledges.**

It is recommended that you have your tires and wheels balanced. Tires and wheels, which are not balanced, may cause steering difficulties, a bumpy ride, and irregular tire wear.

**Be sure that all your valves have suitable valve caps. The valve cap is the primary seal against air loss.**

## **TEMPORARY SPARE TIRES**

When using any temporary spare tire, be sure to follow the vehicle manufacturer's instructions.

## **REMEMBER... TO AVOID DAMAGE TO YOUR TIRES AND POSSIBLE ACCIDENT:**

- CHECK TIRE PRESSURE AT LEAST ONCE EACH MONTH WHEN TIRES ARE COLD AND BEFORE LONG TRIPS.
- DO NOT UNDERINFLATE/OVERINFLATE.
- DO NOT OVERLOAD.
- DRIVE AT MODERATE SPEEDS, OBSERVE LEGAL LIMITS.
- AVOID DRIVING OVER POTHOLES, OBSTACLES, CURBS OR EDGES OF PAVEMENT.
- AVOID EXCESSIVE WHEEL SPINNING.
- IF YOU SEE ANY DAMAGE TO A TIRE, REPLACE WITH THE SPARE AND VISIT ANY AUTHORIZED RETAILER AT ONCE.
- IF YOU HAVE ANY QUESTIONS, CONTACT YOUR AUTHORIZED RETAILER.



# Tire Care

## Highway Hazards

No matter how carefully you drive, there is always the possibility that you could eventually have a flat tire on the highway. Drive slowly to the closest safe area out of traffic. This could further damage the flat tire, but your safety is more important.

If you feel a sudden vibration or ride disturbance while driving, or you suspect your tire or vehicle has been damaged, immediately reduce your speed. Drive with caution until you can safely pull off the road. Stop and inspect the tires for damage. If a tire is under-inflated or damaged, deflate it, remove the wheel and replace it with your spare tire and wheel. If you cannot detect a cause, have the vehicle towed to the nearest repair facility or tire dealer to have the vehicle inspected.

## Tire and Wheel Alignment

A bad jolt from hitting a curb or pothole can cause the front end of your vehicle to become misaligned or cause damage to your tires. If your vehicle seems to pull to one side when you are driving, the wheels could be out of alignment. Have an authorized dealer check the wheel alignment periodically.

Wheel misalignment in the front or the rear can cause uneven and rapid treadwear of your tires and should be corrected by an authorized dealer.

## INSPECTING THE WHEEL VALVE STEMS

Check the valve stems for holes, cracks, or cuts that could permit air leakage.

## TIRE ROTATION



**WARNING:** If the tire label shows different tire pressures for the front and rear tires and the vehicle has a tire pressure monitoring system, then you need to update the settings for the system sensors. Always perform the system reset procedure after tire rotation. If you do not reset the system, it may not provide a low tire pressure warning when necessary.

Rotating your tires at the recommended interval will help your tires wear more evenly, providing better tire performance and longer tire life.

**Note:** *If your tires show any uneven wear have the alignment checked by an authorized dealer before rotating tires.*

**Note:** *If you have a dissimilar spare wheel and tire assembly, it is intended for temporary use only and should not be used in a tire rotation.*

# Tire Care

---

**Note:** *After having your tires rotated, inflation pressure must be checked and adjusted to the vehicle requirements.*

## Tire Rotation Diagram

Follow the diagram indicating the correct tire locations for rotating the tires.

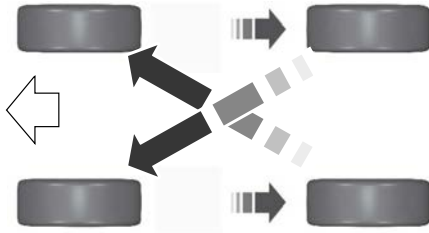

# Tire Pressure Monitoring System

## WHAT IS THE TIRE PRESSURE MONITORING SYSTEM



The tire pressure monitoring system measures the vehicle's tire pressures. A warning lamp illuminates if one or more tires are significantly underinflated or if there is a system malfunction.

## TIRE PRESSURE MONITORING SYSTEM OVERVIEW



**WARNING:** Under-inflation is the most common cause of tire failures and may result in severe tire cracking, tread separation or blowout, with unexpected loss of vehicle control and increased risk of injury. Under-inflation increases sidewall flexing and rolling resistance, resulting in

heat buildup and internal damage to the tire. It also may result in unnecessary tire stress, irregular wear, loss of vehicle control and accidents. A tire can lose up to half of its air pressure and not appear to be flat!



**WARNING:** To determine the required pressure(s) for your vehicle, see the Safety Compliance Certification Label (on the door hinge pillar, door-latch post or the door edge that meets the door-latch post, next to the driver seat) or the Tire Label on the B-Pillar or the edge of the driver door.

Each tire, including the spare (if provided), should be checked monthly when cold and inflated to the inflation pressure recommended by the vehicle manufacturer on the vehicle placard or tire inflation pressure label. (If your vehicle has tires of a different size than the size indicated on the vehicle placard or tire inflation pressure label, you should determine the proper tire inflation pressure for those tires).

As an added safety feature, your vehicle has been equipped with a Tire Pressure Monitoring System (TPMS) that illuminates a low tire pressure telltale when one or more of your tires is significantly under-inflated. Accordingly, when the low tire pressure telltale illuminates, you should stop and check your tires as soon as possible, and inflate them to the proper pressure. Driving on a significantly under-inflated tire causes the tire to overheat and can lead to tire failure. Under-inflation also reduces fuel efficiency and tire tread life, and may affect the vehicle's handling and stopping ability.

Please note that the TPMS is not a substitute for proper tire maintenance, and it is the driver's responsibility to maintain correct tire pressure, even if under-inflation has not reached the level to trigger illumination of the TPMS low tire pressure telltale.

# Tire Pressure Monitoring System

Your vehicle has also been equipped with a TPMS malfunction indicator to indicate when the system is not operating properly. The TPMS malfunction indicator is combined with the low tire pressure telltale. When the system detects a malfunction, the telltale will flash for approximately one minute and then remain continuously illuminated. This sequence will continue upon subsequent vehicle start-ups as long as the malfunction exists.

When the malfunction indicator is illuminated, the system may not be able to detect or signal low tire pressure as intended. TPMS malfunctions may occur for a variety of reasons, including the installation of replacement or alternate tires or wheels on the vehicle that prevent the TPMS from functioning properly. Always check the TPMS malfunction telltale after replacing one or more tires or wheels on your vehicle to ensure that the replacement or alternate tires and wheels allow the TPMS to continue to function properly.



**WARNING:** Changes or modifications not expressly approved by the party responsible for compliance could void the user's authority to operate the equipment. The term "IC:" before the radio certification number only signifies that Industry Canada technical specifications were met.

This device complies with Part 15 of the FCC Rules and with License exempt RSS Standards of Industry Canada. Operation is subject to the following two conditions:

1. This device may not cause harmful interference, and
2. This device must accept any interference received, including interference that may cause undesired operation.

## TIRE PRESSURE MONITORING SYSTEM PRECAUTIONS



**WARNING:** The tire pressure monitoring system is not a substitute for manually checking tire pressures. You should periodically check tire pressures using a pressure gauge. Failure to correctly maintain tire pressures could increase the risk of tire failure, loss of control, vehicle rollover and personal injury.



**WARNING:** Do not use the tire pressure displayed in the information display as a tire pressure gauge. Failure to follow this instruction could result in personal injury or death.

**Note:** *The use of tire sealants can damage the tire pressure monitoring system.*

**Note:** *If the tire pressure monitor sensor becomes damaged it may not function.*

# Tire Pressure Monitoring System

## TIRE PRESSURE MONITORING SYSTEM LIMITATIONS

When the outside temperature drops significantly, the tire pressure could decrease and activate the low tire pressure warning lamp.

The warning lamp could also illuminate when you use a spare wheel, or tire sealant from the inflator kit.

**Note:** Regularly checking the vehicle tire pressures can reduce the possibility for the warning lamp to illuminate due to outside air temperature changes.

**Note:** After you inflate the tires to the recommended pressure it could take up to two minutes of driving over 20 mph (32 km/h) for the warning indicator to turn off.

## VIEWING THE TIRE PRESSURES



To view the current tire pressures, use the information display or touchscreen.

## TIRE PRESSURE MONITORING SYSTEM – TROUBLESHOOTING

### TIRE PRESSURE MONITORING SYSTEM – WARNING LAMPS



The low tire pressure warning lamp has combined functions, as it warns you when your tires need air, and when the system is no longer capable of functioning as intended.

# Tire Pressure Monitoring System

---

<b>Warning Lamp</b>	<b>Possible Cause</b>	<b>Action Required</b>
Solid warning lamp	One or more tires are significantly under inflated	After inflating your tires to the manufacturer's recommended pressure as shown on the tire label, on the edge of driver door or the B-pillar, drive your vehicle for at least two minutes over 20 mph (32 km/h) before the light turns off.
Solid warning lamp or flashing warning lamp	Temporary spare wheel in use	Repair the damaged road wheel and tire and refit it to your vehicle to restore operation of the system.
	Tire pressure monitoring system malfunction	If the tires are inflated to the recommended tire pressures and the temporary spare wheel is not in use, the system detected a fault that requires service. Have your vehicle checked as soon as possible.

# Tire Pressure Monitoring System

---

## TIRE PRESSURE MONITORING SYSTEM – INFORMATION MESSAGES

Message	Action
Tire Pressure Low	After inflating your tires to the manufacturer's recommended pressure as shown on the tire label, on the edge of the driver door or the B-pillar, drive your vehicle for at least two minutes over 20 mph (32 km/h) before the light turns off.
Tire Pressure Monitor Fault	The system has detected a fault that requires service. Have your vehicle checked as soon as possible.
Tire Pressure Sensor Fault	The system has detected a fault that requires service or a spare tire is in use. Have your vehicle checked as soon as possible.

# Changing a Road Wheel (If Equipped)

## CHANGING A FLAT TIRE

If you get a flat tire while driving, do not apply the brake heavily. Instead, gradually decrease your speed, hold the steering wheel firmly and slowly move to a safe place on the side of the road.

Have a flat serviced by an authorized dealer in order to prevent damage to the tire pressure monitoring system sensors. See **Tire Pressure Monitoring System Overview** (page 423). Replace the spare tire with a road tire as soon as possible. During repairing or replacing of the flat tire, have an authorized dealer inspect the tire pressure monitoring system sensor for damage.

**Note:** Only use tire sealants in roadside emergencies as they may damage the tire pressure monitoring system sensor. If you must use a sealant, use the *Tire Mobility Kit sealant*. Replace the tire pressure monitoring system sensor and valve stem on the wheel by an authorized dealer after use of the sealant.

**Note:** The tire pressure monitoring system indicator illuminates when the spare tire is in use. To restore the full function of the tire pressure monitoring system, all road wheels equipped with tire pressure monitoring sensors must be mounted on the vehicle.

## Dissimilar Spare Wheel and Tire Assembly Information



**WARNING:** Failure to follow these guidelines could result in an increased risk of loss of vehicle control, injury or death.

If you have a dissimilar spare wheel and tire, then it is intended for temporary use only. This means that if you need to use it, you should replace it as soon as possible with a road wheel and tire assembly that is the same size and type as the road tires and wheels that were originally provided on your vehicle. If the dissimilar spare tire or wheel is damaged, replace it instead of repairing it.

A dissimilar spare wheel and tire assembly is defined as a spare wheel and tire assembly that is different in brand, size or appearance from the road tires and wheels and can be one of three types:

1. **T-type mini-spare:** This spare tire begins with the letter T for tire size and could have Temporary Use Only molded in the sidewall.
2. **Full-size dissimilar spare with label on wheel:** This spare tire has a label on the wheel that states: THIS WHEEL AND TIRE ASSEMBLY FOR TEMPORARY USE ONLY.

When driving with one of the dissimilar spare tires listed above, do not:

- Exceed 50 mph (80 km/h).
- Load the vehicle beyond maximum vehicle load rating listed on the Safety Compliance Label.
- Tow a trailer.
- Use snow chains on the end of the vehicle with the dissimilar spare tire.
- Use more than one dissimilar spare tire at a time.



# Changing a Road Wheel (If Equipped)

- Use commercial car washing equipment.
- Try to repair the dissimilar spare tire.

Use of one of the dissimilar spare tires listed above at any one wheel location can compromise any of the following:

- Handling, stability and braking performance.
- Comfort and noise.
- Ground clearance and parking at curbs.
- Winter weather driving capability.
- Wet weather driving capability.
- All-wheel driving capability, if applicable.

### 3. Full-size dissimilar spare without label on wheel

When driving with the full-size dissimilar spare wheel and tire assembly, do not:

- Exceed 70 mph (113 km/h).
- Use more than one dissimilar spare wheel and tire assembly at a time.
- Use commercial car washing equipment.
- Use snow chains on the end of the vehicle with the dissimilar spare wheel and tire assembly.

Using a full-size dissimilar spare wheel and tire assembly can compromise the effectiveness of the following:

- Handling, stability and braking performance.
- Comfort and noise.
- Ground clearance and parking at curbs.
- Winter weather driving capability.
- Wet weather driving capability.
- All-wheel driving capability.

When driving with the full-size dissimilar spare wheel and tire assembly additional caution should be given to:

- Towing a trailer.
- Driving vehicles equipped with a camper body.
- Driving vehicles with a load on the cargo rack.

Drive cautiously when using a full-size dissimilar spare wheel and tire assembly and seek service as soon as possible.

## Tire Change Procedure



**WARNING:** Failure to follow these guidelines could result in an increased risk of loss of vehicle control, injury or death.





**WARNING:** The jack supplied with this vehicle is only intended for changing a flat tire in an emergency. Do not attempt to do any other work on your vehicle when it is supported by the jack, as your vehicle could slip off the jack. Failure to follow this instruction could result in personal injury or death.





**WARNING:** To help prevent your vehicle from moving when changing a wheel, shift the transmission into park (P), set the parking brake and use an appropriate block or wheel chock to secure the wheel diagonally opposite to the wheel being changed. For example, when changing the front left wheel, place an appropriate block or wheel chock on the right rear wheel.

## Changing a Road Wheel (If Equipped)

 **WARNING:** Never place anything between the vehicle jack and your vehicle.

 **WARNING:** Never place anything between the vehicle jack and the ground.

 **WARNING:** Do not attempt to change a tire on the side of the vehicle close to moving traffic. Pull far enough off the road to not obstruct the flow of traffic and avoid the danger of being hit when operating the jack or changing the wheel.

 **WARNING:** Do not get under a vehicle that is supported by a jack.

 **WARNING:** Only use the specified jacking points. If you use any other locations you could damage vehicle components, such as brake lines.

 **WARNING:** Only use the jack provided as original equipment with your vehicle.

 **WARNING:** Make sure there is no grease or oil on the threads or the surface between the wheel studs and the wheel nuts. This can cause the wheel nuts to loosen while driving.

 **WARNING:** Always fully apply the parking brake. Failure to follow this instruction could result in personal injury or death.

 **WARNING:** The jack should be used on level firm ground wherever possible.

 **WARNING:** It is recommended that the wheels of the vehicle be chocked, and that no person should remain in a vehicle that is being jacked.

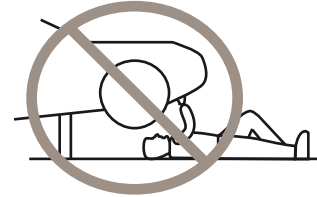

1. Park on a level surface, set the parking brake and activate the hazard flashers.
2. Place the transmission in park (P) and turn the engine off.

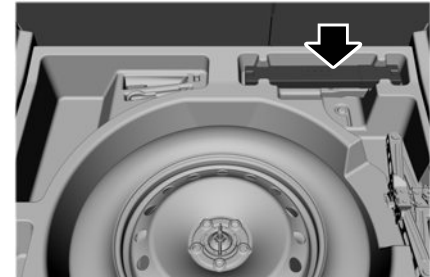

E392495

## Changing a Road Wheel (If Equipped)

3. Lift the cargo area floor and remove the warning triangle from spare tire compartment and set the warning triangle at a safe distance behind.

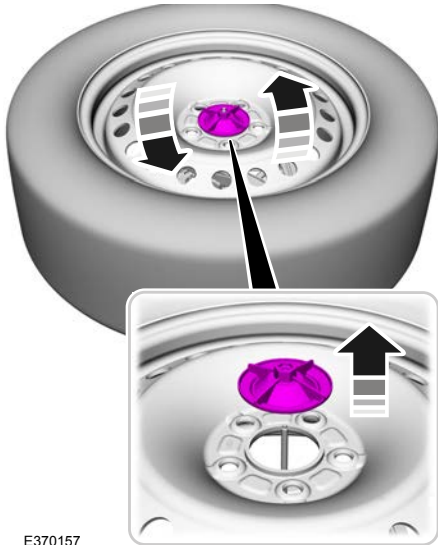

4. Remove the spare tire from spare tire compartment by turning the wing nut counterclockwise.

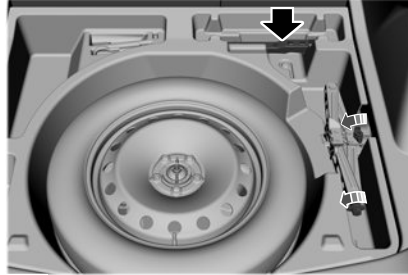

5. Remove the jack from spare tire compartment by turning the jack retainer counterclockwise.
6. Turn the jack hex nut drive screw counterclockwise to lower the jack and release the mechanical lock.

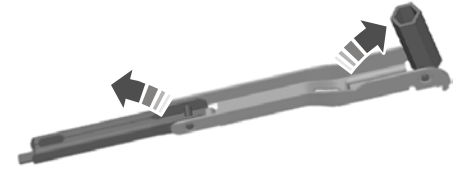

7. Remove the lug wrench from the spare tire compartment and unfold the lug wrench for use.

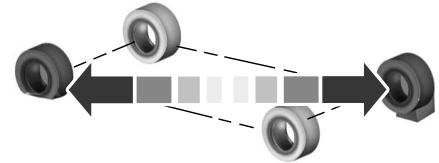

8. Block the wheel diagonally opposite the flat tire. For example, if the left front tire is flat, block the right rear wheel.

## Changing a Road Wheel (If Equipped)



9. If your vehicle has a wheel trim, use the tool supplied to remove it and access the lug nuts, the tool is located under cargo area floor.

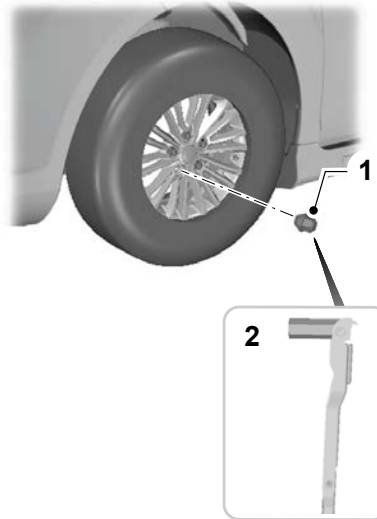

10. Loosen each wheel lug nut one-half turn counterclockwise. Do not remove them until the wheel is raised off the ground.



**Note:** Jack at the specified locations to avoid damage to the vehicle.

11. The vehicle jacking points shown here are also depicted on the warning label on the jack. Small arrow-shaped marks on the vehicle sills show the location of the jacking points.

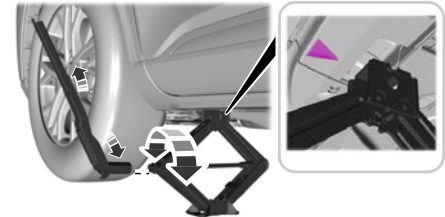

## Changing a Road Wheel (If Equipped)

- Turn the wrench clockwise to raise the vehicle until the flat tire is completely off the ground.
- Remove the lug nuts with the lug wrench.
- Replace the flat tire with the spare tire, making sure the valve stem is facing outward. Reinstall the lug nuts until the wheel is snug against the hub. Do not fully tighten the lug nuts until the wheel has been lowered.
- Lower the wheel by turning the jack handle counterclockwise.

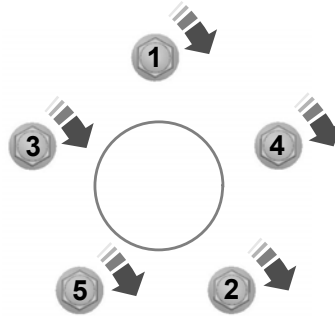

- Remove the jack and fully tighten the lug nuts in the order shown.
- Stow the flat tire, jack, wrench back to spare tire compartment.
- Remove the wheel blocks and retrieve the warning triangle.

### Stowing the flat tire

You cannot store the full-sized road wheel in the temporary spare tire well.

- Find the flat tire retainer strap located under the load floor near the warning triangle. Lower the carpeted load floor.
- Stow the flat tire in the cargo area on the load floor with the wheel facing up. Secure the flat tire with the retainer strap by following the next steps.

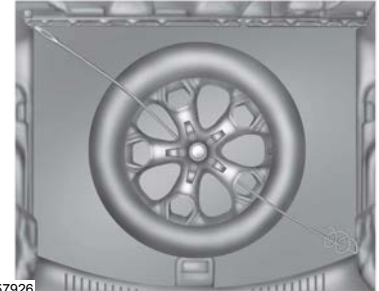

E157926

- Locate the rear left side and right side cargo tie-down rings. Push the loop end of the retainer strap through one cargo tie-down ring. Thread the non-loop end through the loop.

# Changing a Road Wheel (If Equipped)

## WHEEL NUTS



4. Weave the retainer strap through the wheel openings.
5. Locate the cargo tie-down in the opposite rear corner of the cargo area. Thread the retainer strap through the tie-down and pull tight.
6. Secure the flat tire by tying two half hitch knots.

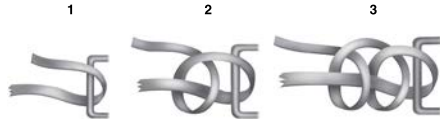

**WARNING:** When you install a wheel, remove any corrosion, dirt or foreign materials present on the mounting surfaces of the wheel or the surface of the wheel hub, brake drum or brake disc that contacts the wheel. Make sure to secure any fasteners that attach the rotor to the hub so they do not interfere with the mounting surfaces of the wheel. Installing wheels without following these steps can cause the wheel nuts to loosen and the wheel to come off while your vehicle is in motion, resulting in loss of vehicle control, personal injury or death.

Bolt Size	Nm <sup>1</sup>
M14 x 1.5	150 ± 15 lb.ft (204 ± 20 Nm)

<sup>1</sup> Torque specifications are for nut and bolt threads free of dirt and rust. Use only Lincoln recommended replacement wheel nuts and or wheel bolts.

Retighten the wheel nuts to the specified torque within 100 mi (160 km) after any wheel disturbance, such as tire rotation, changing a flat tire or wheel removal.

## Changing a Road Wheel (If Equipped)

---



A Hub pilot bore.

Inspect the wheel pilot hole and mounting surface prior to installation. Remove any visible corrosion or loose particles.

# Capacities and Specifications

---

## ENGINE SPECIFICATIONS - 2.0L, GASOLINE

Engine	Specification
Compression ratio.	10.0:1
Displacement.	122 in <sup>3</sup> (2,000 cm <sup>3</sup> )
Firing order.	1-3-4-2
Ignition system.	Coil on plug
Required fuel.	Minimum 87 octane
Spark plug gap.	0.028–0.031 in (0.7–0.8 mm)



# Capacities and Specifications

---

## ENGINE SPECIFICATIONS - 2.0L, FULL HYBRID ELECTRIC VEHICLE (FHEV)

Engine	Specification
Compression ratio.	10.0:1
Displacement.	122 in <sup>3</sup> (2,000 cm <sup>3</sup> )
Firing order.	1-3-4-2
Ignition system.	Coil on plug
Required fuel.	Minimum 87 octane
Spark plug gap.	0.028–0.031 in (0.7–0.8 mm)

# Capacities and Specifications

---

## TRANSMISSION SPECIFICATIONS - FULL HYBRID ELECTRIC VEHICLE (FHEV)

INVERTER	MODEL	KTZ50X39SHF55	MAX VOLTAGE	500V
	COOLING METHOD	WATER COOLING	MAX CURRENT	385A
	DUTY CYCLE	S9	PHASE NUMBER	3
TRACTION MOTOR	MODEL	TZ236XYHF55	PEAK TORQUE	320NM
	COOLING METHOD	OIL COOLING	PEAK POWER	140KW
	MAX SPEED(GB/T)	17000rpm	ISOLATION LEVEL	H

# Capacities and Specifications

## MOTORCRAFT PARTS - 2.0L, GASOLINE

Component	Motorcraft Part Number
Air filter element.	FA-2064
Battery.	BAGM-94RH7-800
Cabin air filter.	FP-103
Engine oil filter. <sup>1</sup>	FL-2127
Spark plug.	SP-597-X
Windshield wiper blade.	WW-2505 (driver side-heated) WW-2506 (driver side-non heated) WW-2055 (passenger side-heated) WW-2056 (passenger side-non heated) WW-1113 (rear window)

<sup>1</sup> If a Motorcraft oil filter is not available, use an oil filter that aligns to SAE/USCAR – 36 Performance Specifications. Filter Type B.

We recommend Motorcraft parts that are available at your authorized dealer or at [www.fordparts.com](http://www.fordparts.com). We engineer these parts for your vehicle to meet or exceed our specifications. Use of other parts could impact vehicle performance, emissions and durability. Your warranty could be void for any damage related to use of other parts.

# Capacities and Specifications

## MOTORCRAFT PARTS - 2.0L, FULL HYBRID ELECTRIC VEHICLE (FHEV)

Component	Motorcraft Part Number
Air filter element.	FA-2064
Battery.	BAGM-H4
Cabin air filter.	FP-103
Engine oil filter. <sup>1</sup>	FL-2127
Spark plug.	SP-597-X
Windshield wiper blade.	WW-2505 (driver side-heated) WW-2506 (driver side-non heated) WW-2055 (passenger side-heated) WW-2056 (passenger side-non heated) WW-1113 (rear window)

<sup>1</sup>If a Motorcraft oil filter is not available, use an oil filter that aligns to SAE/USCAR – 36 Performance Specifications. Filter Type B.

We recommend Motorcraft parts that are available at your authorized dealer or at [www.fordparts.com](http://www.fordparts.com). We engineer these parts for your vehicle to meet or exceed our specifications. Use of other parts could impact vehicle performance, emissions and durability. Your warranty could be void for any damage related to use of other parts.

# Capacities and Specifications

## ENGINE OIL CAPACITY AND SPECIFICATION - 2.0L, GASOLINE

Use oil that meets the defined specification and viscosity grade.

If you do not use oil that meets the defined specification and viscosity grade, it could result in:

- Component damage that your vehicle warranty does not cover.
- Longer engine cranking periods.
- Increased emission levels.

- Reduced vehicle performance.
- Reduced fuel economy.



An oil that displays this symbol conforms to current engine, emission system and fuel economy performance standards of ILSAC.

We recommend Motorcraft motor oil for your vehicle. If Motorcraft oil is not available, use motor oils of the recommended viscosity grade that display the API Certification Mark for gasoline engines.

Do not use supplemental engine oil additives because they are unnecessary and could lead to engine damage that your vehicle warranty does not cover.

### Capacities

Variant	Including the Oil Filter
All.	6.1 qt (5.8 L)

# Capacities and Specifications

---

## Materials

Name	Specification
Motorcraft® SAE 5W-30 Motor Oil(U.S.) Motorcraft® SAE 5W-30 Motor Oil / Huile moteur SAE 5W-30 Motorcraft®(Canada) XO-5W30-Q1SP, XO-5W30-Q1FS(U.S.) CXO-5W30-LSP6, CXO-5W30-LFS6(Canada)	WSS-M2C961-A1

## Alternative Engine Oil for Extremely Cold Climates

To improve engine cold start performance, use the following engine oil in climates where the ambient temperature reaches -22.0°F (-30°C) or below.

## Materials

Name	Specification
Engine Oil - SAE 0W-30	WSS-M2C963-A1

# Capacities and Specifications

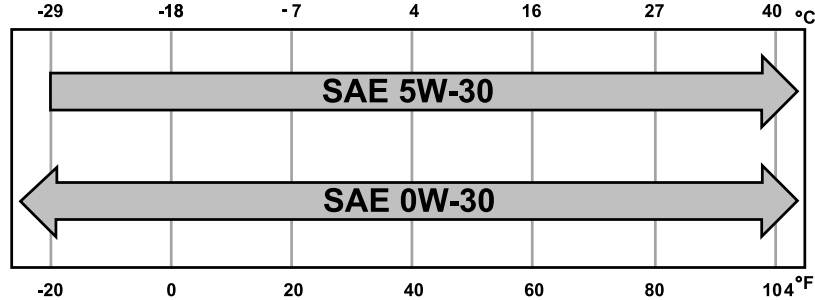

**Note:** *If you use your vehicle regularly above the altitude of 5,000 ft (1,524 m) and under the temperature of -4.0°F (-20°C), it is recommended to use the alternative engine oil.*

## **ENGINE OIL CAPACITY AND SPECIFICATION - 2.0L, FULL HYBRID ELECTRIC VEHICLE (FHEV)**

Use oil that meets the defined specification and viscosity grade.

If you do not use oil that meets the defined specification and viscosity grade, it could result in:

- Component damage that your vehicle warranty does not cover.
- Longer engine cranking periods.
- Increased emission levels.
- Reduced vehicle performance.
- Reduced fuel economy.



# Capacities and Specifications

An oil that displays this symbol conforms to current engine, emission system and fuel economy performance standards of ILSAC.

We recommend Motorcraft motor oil for your vehicle. If Motorcraft oil is not available, use motor oils of the recommended viscosity grade that display the API Certification Mark for gasoline engines.

Do not use supplemental engine oil additives because they are unnecessary and could lead to engine damage that your vehicle warranty does not cover.

## Capacities

Variant	Including the Oil Filter
All.	6.1 qt (5.8 L)

## Materials

Name	Specification
Motorcraft® SAE 5W-30 Motor Oil(U.S.) Motorcraft® SAE 5W-30 Motor Oil / Huile moteur SAE 5W-30 Motorcraft®(Canada) XO-5W30-Q1SP, XO-5W30-Q1FS(U.S.) CXO-5W30-LSP6, CXO-5W30-LFS6(Canada)	WSS-M2C961-A1



# Capacities and Specifications

## Alternative Engine Oil for Extremely Cold Climates

To improve engine cold start performance,

use the following engine oil in climates where the ambient temperature reaches -22.0°F (-30°C) or below.

### Materials

Name	Specification
Engine Oil - SAE 0W-30	WSS-M2C963-A1

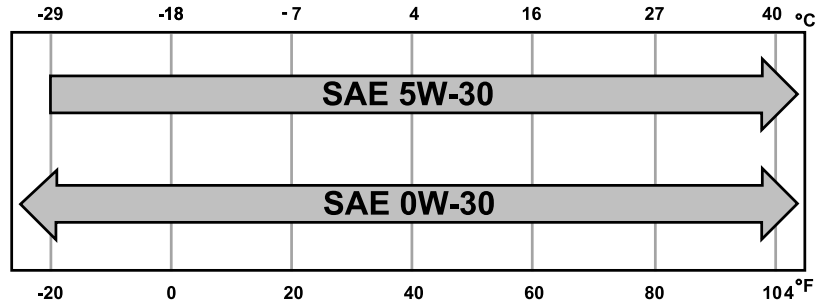

# Capacities and Specifications

**Note:** *If you use your vehicle regularly above the altitude of 5,000 ft (1,524 m) and under the temperature of -4.0°F (-20°C), it is recommended to use the alternative engine oil.*

## COOLING SYSTEM CAPACITY AND SPECIFICATION - 2.0L, GASOLINE

Use coolant that meets the defined specification.

If you do not use coolant that meets the defined specification, it could result in:

- Component damage that your vehicle warranty does not cover.
- Reduced vehicle performance.

### Capacities

Variant	Quantity
All.	2.32 ± 0.05 gal (8.79 ± 0.19 L)

### Materials

Name	Specification
Motorcraft® Yellow Prediluted Antifreeze/Coolant(U.S.) Motorcraft® Yellow Prediluted Antifreeze/Coolant / Antigel/liquide de refroidissement prédilué jaune Motorcraft®(Canada) VC-13DL-G(U.S.) CVC-13DL-G(Canada)	WSS-M97B57-A2

# Capacities and Specifications

## COOLING SYSTEM CAPACITY AND SPECIFICATION - 2.0L, FULL HYBRID ELECTRIC VEHICLE (FHEV)

Use coolant that meets the defined specification.

If you do not use coolant that meets the defined specification, it could result in:

- Component damage that your vehicle warranty does not cover.
- Reduced vehicle performance.

### Capacities

Variant	Quantity
Main engine loop.	2.2 ± 0.0 gal (8.38 ± 0.16 L)
Battery loop.	0.75 ± 0.02 gal (2.85 ± 0.09 L)

### Materials

Name	Specification
Motorcraft® Yellow Prediluted Antifreeze/Coolant(U.S.) Motorcraft® Yellow Prediluted Antifreeze/Coolant / Antigél/liquide de refroidissement pré-dilué jaune Motorcraft®(Canada) VC-13DL-G(U.S.) CVC-13DL-G(Canada)	WSS-M97B57-A2

# Capacities and Specifications

---

## FUEL TANK CAPACITY

### Capacities

Variant	Quantity
Gas.	20.3 gal (77 L)
FHEV.	20.1 gal (76 L)

# Capacities and Specifications

## AIR CONDITIONING SYSTEM CAPACITY AND SPECIFICATION - 2.0L, GASOLINE



**WARNING:** The air conditioning refrigerant system contains refrigerant

under high pressure. Only qualified personnel should service the air conditioning refrigerant system. Opening the air conditioning refrigerant system can cause personal injury.

Use refrigerant and oil that meets the defined specifications.

If you do not use refrigerant and oil that meets the defined specifications, it could result in:

- Component damage that your vehicle warranty does not cover.
- Reduced vehicle performance.

### Capacities

Variant	Refrigerant	Refrigerant Oil
All.	21.2 oz (0.6 kg)	3.4 fl oz (100 ml)

# Capacities and Specifications

---

## Materials

Name	Specification
R-1234yf Refrigerant(U.S.) R-1234yf Refrigerant / Frigorigène R-1234yf(Canada) YN-33-A(U.S.) HS7Z-19B519-BA(Canada)	WSS-M17B21-A
Motorcraft® R-1234yf Refrigerant PAG Oil(U.S.) Motorcraft® R-1234yf Refrigerant PAG Oil / Huile PAG pour frigorigène R-1234yf Motorcraft®(Canada) YN-35(U.S. & Canada)	WSS-M2C300-A2

# Capacities and Specifications

## AIR CONDITIONING SYSTEM CAPACITY AND SPECIFICATION - 2.0L, FULL HYBRID ELECTRIC VEHICLE (FHEV)



**WARNING:** The air conditioning

refrigerant system contains refrigerant under high pressure. Only qualified personnel should service the air conditioning refrigerant system. Opening the air conditioning refrigerant system can cause personal injury.

Use refrigerant and oil that meets the defined specifications.

If you do not use refrigerant and oil that meets the defined specifications, it could result in:

- Component damage that your vehicle warranty does not cover.
- Reduced vehicle performance.

### Capacities

Variant	Refrigerant	Refrigerant Oil
All.	22.0 oz (0.625 kg)	5.4 fl oz (160 ml)

# Capacities and Specifications

## Materials

Name	Specification
R-1234yf Refrigerant(U.S.) R-1234yf Refrigerant / Frigorigène R-1234yf(Canada) YN-33-A(U.S.) HS7Z-19B519-BA(Canada)	WSS-M17B21-A
Motorcraft® R-1234yf Refrigerant PAG Oil(U.S.) Motorcraft® R-1234yf Refrigerant PAG Oil / Huile PAG pour frigorigène R-1234yf Motorcraft®(Canada) YN-35(U.S. & Canada)	WSS-M2C300-A2

## WASHER FLUID SPECIFICATION

### Capacities

Variant	Quantity
All.	Fill as required.



# Capacities and Specifications

---

## Materials

Name	Specification
Motorcraft® Premium Windshield Wash Concentrate with Bitterant(U.S.) Motorcraft® Premium Quality Windshield Washer Fluid -35 °C / Liquide lave-glace de haute qualité -35 °C Motorcraft®(Canada) ZC-32-B2(U.S.) CXC-37-M(Canada)	WSS-M14P19-A

## AUTOMATIC TRANSMISSION FLUID CAPACITY AND SPECIFICATION

## Materials

Name	Specification
Motorcraft® MERCON® ULV Automatic Transmission Fluid(U.S.) Motorcraft® MERCON® ULV Automatic Transmission Fluid / MERCON® ULV huile pour boîtes automatique Motorcraft®(Canada) XT-12-QULV(U.S. & Canada)	WSS-M2C949-A,

# Capacities and Specifications

**Note:** Only use MERCON® ULV transmission fluid for automatic transmissions that require MERCON® ULV transmission fluid. The use of any other fluid could cause transmission damage.

## BRAKE FLUID SPECIFICATION

Use fluid that meets the defined specification and viscosity grade.

If you do not use fluid that meets the defined specification and viscosity grade, it could result in:

- Component damage that your vehicle warranty does not cover.
- Reduced brake performance.

**Note:** We recommend you use Dot 4 Low Viscosity (LV) High Performance Brake Fluid meeting WSS-M6C65-A2 specifications or ISO 4925 Class 6 standards. If you use any fluid other than the recommended fluid, it could cause reduced brake performance and not meet our performance standards. Keep brake fluid clean and dry. Contamination with dirt, water, petroleum products or other materials could result in brake system damage and possible failure.

## Capacities

Variant	Quantity
All.	Fill as required.

## Materials

Name	Specification
Motorcraft® DOT 4 LV High Performance Motor Vehicle Brake Fluid(U.S.) Motorcraft® DOT 4 LV High Performance Motor Vehicle Brake Fluid / Liquide de frein automobile haute performance DOT 4 LV Motorcraft®(Canada) PM-20(U.S. & Canada)	WSS-M6C65-A2

# Vehicle Identification

## VEHICLE IDENTIFICATION NUMBER

### LOCATING THE VEHICLE IDENTIFICATION NUMBER

The vehicle identification number is located on the left-hand side of the instrument panel.

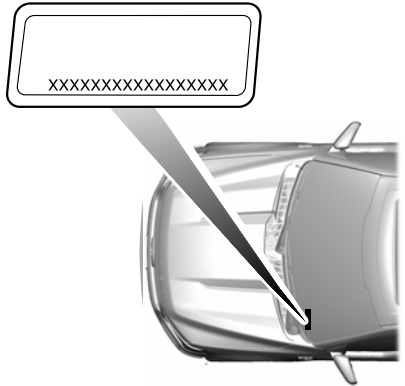

In the graphic, XXXX is representative of your vehicle identification number.

## VEHICLE IDENTIFICATION NUMBER OVERVIEW

The vehicle identification number contains the following information:

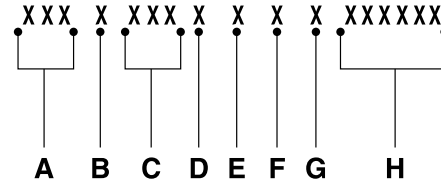

- A World manufacturer identifier.
- B Brake system, gross vehicle weight rating, restraint devices and their locations.
- C Make, vehicle line, series, body type.
- D Engine or motor type.
- E Check digit.

- F Model year.
- G Assembly plant.
- H Production sequence number.

# Connected Vehicle

## WHAT IS A CONNECTED VEHICLE

A connected vehicle has technology that allows your vehicle to connect to a mobile network and for you to access a range of features. When used in conjunction with the Lincoln Way app, it could allow you to monitor and control your vehicle further, for example checking the tire pressures, and the vehicle location. For additional information, refer to the local Lincoln website.

## CONNECTED VEHICLE REQUIREMENTS

Connected service and related feature functionality requires a compatible vehicle network.

Some remote features require additional service activation. Log in to your Lincoln account for details. Some restrictions, third party terms and message or data rates may apply.

## CONNECTED VEHICLE LIMITATIONS

Evolving technology, cellular networks, or regulations could affect functionality and availability, or continued provision of some features. These changes could even stop some features from functioning.

## CONNECTING THE VEHICLE TO A MOBILE NETWORK

### WHAT IS THE MODEM



The modem allows access to a range of features built into your vehicle.

### ENABLING AND DISABLING THE MODEM

1. From the settings menu, press Network & Internet. See **Center Display** (page 468).
2. Switch Vehicle Connectivity on or off.

## CONNECTING LINCOLN WAY TO THE MODEM

1. Make sure that the modem is enabled using the vehicle settings menu.
2. Open the Lincoln Way app on your device and log in.
3. Add your vehicle or select your vehicle if already added.
4. Select the option to activate your vehicle.
5. Make sure that the name on the screen matches the name shown in your Lincoln Way account.
6. Confirm that your Lincoln Way account is connected to the modem.

## CONNECTING THE VEHICLE TO A WI-FI NETWORK

1. From the settings menu, press Network & Internet. See **Center Display** (page 468).
2. Press Wi-Fi.
3. Switch Wi-Fi on.

# Connected Vehicle

4. Select an available Wi-Fi network.

**Note:** Enter the network password to connect to a secure network.

## CONNECTED VEHICLE SETTINGS

From the settings menu, press Privacy and Data Sharing. See **Center Display** (page 468).

You can adjust several settings, such as:

- Share vehicle data.
- Share vehicle location.
- Share driving data.

**Note:** Depending on your vehicle, different options may be available.

**Note:** *Editing connectivity settings could result in some features not operating correctly or at all. When you edit connectivity settings, pop-up messages may appear to notify you that services will not work without that setting. If you switch a feature on, pop-up messages could appear informing you of the settings that will be turned on. Some features, for example driver assistance features, use map data. We recommend having all connected vehicle settings enabled to allow the map content to be updated to the latest version.*



Press the button next to a menu option for more information.

## CONNECTED VEHICLE – TROUBLESHOOTING

### CONNECTED VEHICLE – FREQUENTLY ASKED QUESTIONS

**Why can I not confirm the connection of my Lincoln Way account to the modem?**

- The modem is not enabled. Switch vehicle connectivity on.
- The network signal is weak. Move your vehicle closer to a place where the network signal is not obstructed.

# Connected Vehicle

---

## Why can I not connect to a Wi-Fi network?

- You entered the wrong network password. Enter the correct password.
- The network signal is weak. Move your vehicle closer to the Wi-Fi router or to a place where the network signal is not obstructed.
- There are multiple access points in range with the same network name. Choose a unique name for your network. Do not use the default name unless it contains a unique identifier, for example as part of the MAC address.

## Why does the Wi-Fi connection disconnect after successful connection?

- The network signal is weak. Move your vehicle closer to the Wi-Fi router or to a place where the network signal is not obstructed.

## What can I do if I am close to a Wi-Fi router but the network signal strength is weak?

- If your vehicle has a heated windshield, position your vehicle so that the windshield is not facing the Wi-Fi router.
- If your vehicle has metallic tinting on the windows but not on the windshield, position your vehicle so that the windshield is facing the Wi-Fi router or open the windows that are facing the router.
- If your vehicle has metallic tinting on the windows and the windshield, open the windows that are facing the router.
- If your vehicle is in a garage and you have the garage door closed, open the garage door as it could block the signal.

## Why can I not see a network I expect to see in the list of available networks?

- The network is hidden. Make the network visible and try again, or manually add a network in the Wi-Fi settings menu.
- Some network security types are not supported, for example WEP.

## Why do software downloads take too long?

- The network signal is weak. Move your vehicle closer to the Wi-Fi router or to a place where the network signal is not obstructed.
- Wi-Fi network is in high demand or has a slow Internet connection. Use a more reliable Wi-Fi network.

**Why does the software not update when the system seems to connect to a Wi-Fi network and the signal strength is excellent?**

- No software update is available at this time.
- Select automatic updates option in the settings menu to enable automatic software update or contact an authorized dealer.
- There could be a connection problem. Test the network using another device.

# Vehicle Hotspot

---

## SETTING UP A VEHICLE HOTSPOT

With a data plan, your hotspot can provide devices in and around your vehicle with Wi-Fi data.

**Note:** A mobile device is required to complete hotspot setup.

1. From the apps menu, press Hotspot. See **Center Display** (page 468).
2. Connect your device to the vehicle hotspot by scanning the code on the touchscreen with your device or following the text instructions on the touchscreen.

## Activating a Trial or Purchasing a Data Plan

1. Connect a device to your vehicle hotspot. The vehicle network carrier's service activation website opens on your device.

**Note:** If the website does not open, open a new website and it redirects to the vehicle network carrier's website.

2. Follow the instructions on the carrier portal to purchase a plan or start a trial.

**Note:** Visit the vehicle network carrier's website to purchase more data.

**Note:** Hotspot services are subject to your vehicle network carrier agreement, coverage and availability.

## VEHICLE HOTSPOT SETTINGS

You can change the following in the vehicle hotspot settings menu:

- Vehicle hotspot name or password.
- Vehicle hotspot frequency.

## Changing the Vehicle Hotspot Name or Password

The hotspot information can only be updated once you activate the hotspot.

1. From the apps menu, press Hotspot. See **Center Display** (page 468).
2. Press settings.
3. Press Network name.
4. Enter your required network name.
5. Press Enter.

6. Press Password.
7. Enter your required password.
8. Press Enter.

## Changing the Vehicle Hotspot Frequency

The vehicle hotspot frequency band is selectable depending upon your device capabilities. You cannot connect your device to the vehicle hotspot if it does not support the selected frequency band.

1. From the apps menu, press Hotspot. See **Center Display** (page 468).
2. Press settings.
3. Press Frequency.
4. Select a frequency.



# Vehicle Hotspot

---

## **VEHICLE HOTSPOT – TROUBLESHOOTING**

### **VEHICLE HOTSPOT – FREQUENTLY ASKED QUESTIONS**

#### **Why can I not see the vehicle hotspot name when I search for Wi-Fi networks on my cell phone or other device?**

- Make sure the vehicle hotspot is switched on.
- Make sure hidden network is switched off under the hotspot security menu.
- Check what frequency the hotspot is transmitting in the vehicle hotspot settings menu. If the frequency is 5 GHz and your device cannot see the network, change the frequency to 2.4 GHz.

#### **How do I remove the vehicle from the vehicle network carrier's account?**

- Contact your vehicle network carrier.

# Audio System

## AUDIO SYSTEM PRECAUTIONS



**WARNING:** Driving while distracted can result in loss of vehicle control, crash and injury. We strongly recommend that you use extreme caution when using any device that may take your focus off the road. Your primary responsibility is the safe operation of your vehicle. We recommend against the use of any hand-held device while driving and encourage the use of voice-operated systems when possible. Make sure you are aware of all applicable local laws that may affect the use of electronic devices while driving.

Listening to loud audio for long periods of time could damage your hearing.

## SWITCHING THE AUDIO UNIT ON AND OFF



Press the button on the volume control.

## SELECTING THE AUDIO SOURCE

### Home Screen View

From the apps menu, press your preferred audio source. See **Center Display** (page 468).

**Note:** Available audio sources are listed on the *Apps menu*.

### Now Playing View

Press the Audio Source dropdown menu and scroll through the audio sources.

## PLAYING OR PAUSING THE AUDIO SOURCE

### Touchscreen



Press to pause playback. Press again to resume playback.

**Note:** Not all sources can be paused.

## ADJUSTING THE VOLUME

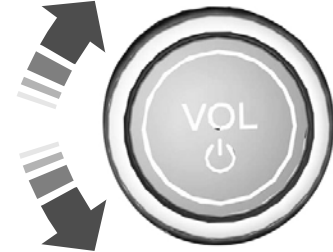

Turn to adjust the volume.

Some vehicles may be able to adjust the volume using buttons on the steering wheel.

**Note:** Do not place heavy objects on the knob, this could result in restarting of the audio system.

# Audio System

## SWITCHING SHUFFLE MODE ON AND OFF



Press the button on the touchscreen to switch shuffle mode on or off.

**Note:** *Not all sources have shuffle mode.*

## SWITCHING REPEAT MODE ON AND OFF



Press the button on the touchscreen to switch repeat mode on or off.

**Note:** *Not all sources have repeat mode.*

## SETTING A MEMORY PRESET

1. Select a station or channel.
2. Press the memory preset button on the touchscreen.

**Note:** *The audio mutes briefly while the system saves the preset and returns once it is stored.*

**Note:** *You can save presets from multiple sources to the memory preset bar.*

## ADJUSTING THE SOUND SETTINGS

1. From the settings menu, press Sound. See **Center Display** (page 468).

From the menu, you can adjust the following:

- Tone.
- Balance and fade.
- Speed compensated volume.
- Occupancy mode/Sound mode.
- Volume settings.

**Note:** *Depending on your vehicle options, not all settings are available.*

## SETTING THE CLOCK AND DATE

### Switching Automatic Time Updates On and Off

1. From the settings menu, press System. See **Center Display** (page 468).

2. Press Date & Time.
3. Switch Time Zone Automatically on or off.

**Note:** *The Select Time Zone option is not available if Time Zone Auto Mode is switched on.*

**Note:** *By default 12-hour or 24-hour mode are available.*

**Note:** *The AM and PM options are not available if 24-hour mode is on.*

## AM/FM RADIO

### AM/FM RADIO LIMITATIONS

The further you travel from an AM or FM station, the weaker the signal and the weaker the reception.

Hills, mountains, tall buildings, bridges, tunnels, freeway overpasses, parking garages, dense tree foliage and thunderstorms can interfere with the reception.

# Audio System

When you pass a ground-based broadcast repeating tower, a stronger signal may overtake a weaker one and result in the audio system muting.

## SELECTING AN AM/FM RADIO STATION

### Manually Selecting a Radio Station



Press the button on the radio tuner to go up the frequency band.



Press the button on the radio tuner to go down the frequency band.

### Using Seek



Press to seek the next station up the frequency band.

Press and hold to quickly seek up the frequency band.



Press to seek the next station down the frequency band.

Press and hold to quickly seek down the frequency band.

## Using the Station List

1. Press the search button on the radio screen.
2. Press a radio station from the list.

## DIGITAL RADIO

### WHAT IS DIGITAL RADIO

HD Radio™ technology is the digital evolution of analog AM/FM radio.

For additional information, visit [www.HDRadio.com](http://www.HDRadio.com).

HD Radio Technology is manufactured under license from iBiquity Digital Corporation and foreign patents. HD Radio and the HD and HD Radio logos are proprietary trademarks of XPERI. The vehicle manufacturer and XPERI are not responsible for the content sent using HD Radio technology. Content may be changed, added or deleted at any time at the station owner's discretion.

## HOW DOES DIGITAL RADIO WORK

Your system has a special receiver that allows it to receive digital broadcasts in addition to analog broadcasts.

HD1 signifies the main programming status and is available in both analog and digital broadcasts. Other multicast stations are only available digitally and could contain new or different content.

**Note:** *When the system first receives an HD1 station, it plays the station in the analog version until it verifies the station is an HD Radio station. Then it shifts to the digital version.*

**Note:** *There is an audio mute delay when switching to an HD2 or HD3 station because the system has to reacquire and decode the digital signal.*

## DIGITAL RADIO LIMITATIONS

If you are outside the reception area, the system could not work.

# Audio System

If you are on the fringe of the reception area, the station could mute due to weak signal strength.

**Note:** *If you are listening to HD1, the system changes back to the analog broadcast until the digital broadcast is available again. If you are listening to any other multicast channels, the station mutes and stays muted unless it is able to connect to the digital signal again.*

Depending on the station quality, you could hear a slight sound change when the station changes between analog and digital audio.

You cannot access a saved HD station if your vehicle is outside the station's reception area.

## SWITCHING DIGITAL RADIO RECEPTION ON AND OFF

1. From the apps menu, press AM or FM. See **Center Display** (page 468).
2. Press Settings.
3. Switch HD radio on or off.

## DIGITAL RADIO INDICATORS

### HD Radio Indicator

The indicator appears when HD Radio is on and you tune to a station broadcasting HD Radio technology.



The color of the indicator changes to indicate the system status.

Gray indicates the system is acquiring a digital station.

Orange indicates digital audio is playing.

### Multicast Indicator

The multicast indicator appears if the current station is broadcasting multiple digital broadcasts. The highlighted numbers indicate additional digital channels available.

**Note:** *For stations that have more than one HD multicast, the HD indicator and radio text appears as a button. Press the button to cycle through all of the HD stations on that specific frequency.*

## SATELLITE RADIO

### WHAT IS SATELLITE RADIO

Your factory-installed SiriusXM radio system includes a limited subscription term, which begins on the date of sale or lease of your vehicle. See an authorized dealer for availability.

For additional information about extended subscription terms, visit [www.SiriusXM.com](http://www.SiriusXM.com) in the United States, [www.SiriusXM.ca](http://www.SiriusXM.ca) in Canada, or call SiriusXM at 1-888-539-7474.

# Audio System

**Note:** SiriusXM reserves the unrestricted right to change, rearrange, add or delete programming including canceling, moving or adding particular channels, and its prices, at any time, with or without notice to you. Neither SiriusXM and its affiliates nor Ford Motor Company and its affiliates will be liable to you or any third party for any such modification, suspension or termination.

## SATELLITE RADIO LIMITATIONS

For optimal reception performance, keep the antenna clear of snow and ice build-up and keep luggage and other material as far away from the antenna as possible. Placing luggage over the antenna may reduce performance. Factory-installed and aftermarket vehicle structures including, but not limited to, roof racks and soft top roofs in a partially open position could reduce reception performance.

Hills, mountains, tall buildings, bridges, tunnels, freeway overpasses, parking garages, dense tree foliage and thunderstorms can interfere with your reception.

When you pass a ground-based broadcast-repeating tower, a stronger signal may overtake a weaker one and could result in the audio system muting. Your display could show an error message to indicate the interference.

## LOCATING THE SATELLITE RADIO IDENTIFICATION NUMBER

1. Select SiriusXM as the audio source.
2. Tune to channel 0.

## SELECTING A CHANNEL

### Manually Selecting a Channel

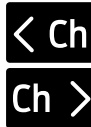

Press the button to find the previous or next available radio channel.

## Linear Tuner

The linear tuner is displayed when manually selecting a channel. You can swipe left or right on the linear tuner carousel to navigate through the channel list. Tap on a channel title to listen to it.

## Using Direct Tune

1. Press the channel up or down button to open the linear tuner screen.
2. Press Direct Tune to open the number pad.
3. Enter the channel you prefer.

## Using Seek



Press either button.

## Using the Channel List

1. Press Browse.
2. Select a channel.

# Audio System

---

## SATELLITE RADIO SETTINGS

### Subscription

Your subscription status is displayed. You can subscribe or manage your subscription directly from the touchscreen.

### SiriusXM Favorites

While you are listening to SiriusXM, you can save favorites by:

- Tapping the currently tuned channel or show logo on the SiriusXM audio screen.
- Tuning to a channel or show you want to save as a favorite. Navigate to the SiriusXM Favorites screen and press the Add Current button. The currently tuned channel or show is saved as a favorite.
- Saving a radio preset. This saves the currently tuned SiriusXM channel or show as a favorite

**Note:** *Requires a trial or active subscription to use.*

### Listening History

Listening history is a list of recently listened to SiriusXM content. You can view, manage and reset the listening history using the controls on the touchscreen.

**Note:** *Requires a trial or active subscription to use.*

### Help and Support

You can contact SiriusXM Customer Care directly from the operating system and view information required to manage your SiriusXM account.

## SETTING AN ALERT



Set a notification for the current song, artist, or sports team by pressing the icon. The system alerts you when it plays again on any channel. Selecting this button allows you to enable and edit alerts.

**Note:** *Notifications can be switched on or off and edited in the satellite radio settings.*

# Center Display

## CENTER DISPLAY OVERVIEW



**WARNING:** Driving while distracted can result in loss of vehicle control, crash and injury. We strongly recommend that you use extreme caution when using any device that may take your focus off the road. Your primary responsibility is the safe operation of your vehicle. We recommend against the use of any hand-held device while driving and encourage the use of voice-operated systems when possible. Make sure you are aware of all applicable local laws that may affect the use of electronic devices while driving.

For your safety, features that are not critical while driving are not available when the vehicle is moving at or above 5 mph (8 km/h).

**Note:** Illustrations are provided for conceptual understanding only and may appear differently on your vehicle.

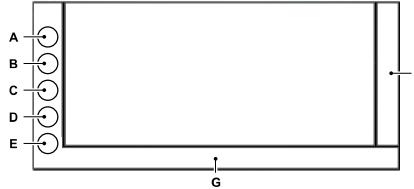

- A Home screen.
- B Controls. See **Controls** (page 469).
- C Apps. See **Apps** (page 469).
- D Instrument panel display. See **Customizing the Instrument Panel Display** (page 470).
- E Android Auto or Apple CarPlay. See **Switching Android Auto On and Off** (page 479). See **Switching Apple CarPlay On and Off** (page 479).
- F Status bar. See **Status Bar** (page 468).
- G Climate control. See **Climate Control** (page 143).



If you see this icon, press it for more information.



If you see this icon, press it to open the settings menu for the app or feature.



If you see this icon, press it to search within that app or feature.

## STATUS BAR

The following icons can appear in the status bar.

### Notification Center



Press to view notifications.



Unread notifications available. Press to view notifications.

### Device Signal



Device signal strength.



# Center Display



Device signal roaming.



Device signal not available.

## Vehicle Signal



Data unavailable or disabled.



Wi-Fi connected.



Wi-Fi not connected.



Wi-Fi connected, internet unavailable.



Vehicle signal strength.



Vehicle signal roaming.



Vehicle signal not available.

## Privacy



Vehicle location sharing on.



Microphone active.

## APPS



Press to see a list of apps. To open an app, select the app.

You can download additional apps on your vehicle through Google Play. To download additional apps, make sure your vehicle is in park (P), connected to the internet and signed in to an active personal Google account.

When you start an app through the system for the first time, you could be asked to grant certain permissions. You can review and change the permissions at any time when your vehicle is not moving. We recommend that you check the app provider's terms and conditions and privacy policy before using

their app. Make sure that you have an active account for apps that you want to use through the system. Some apps work with no setup. Others require you to configure personal settings and enable data connectivity before you can use them.

## Customizing the Apps Screen

1. Press and hold an app.
2. Drag the app to a new location.

## CONTROLS



Press to open the controls screen where you can turn common features off and on.

## Customizing the Controls Screen

1. Press and hold a control tile.
2. Drag the control tile to a new location.

# Center Display

## CUSTOMIZING THE INSTRUMENT PANEL DISPLAY



Press to change the layout for the instrument panel display screen.



If you see this icon on an item, press it to see more actions for that item.

### Adding, Removing, or Reordering Items

- To add an item to the instrument panel display screen, drag it into one of the spots at the top of the screen.
- To remove an item, drag it down from the spot at the top of the screen.
- To reorder items, drag an item from one spot to another.

### Switching On the Calm Screen

The calm screen changes the instrument panel display screen to a simplified view.

1. At the top of the screen, turn on the Calm switch.

## SETTINGS



From the apps menu, press to open the settings app.

You can change the display language and other measurement units under the System menu.



If you see this icon next to a menu option, press it for more information.



If you see this icon in the top corner, press it to open the settings for that app or feature.

## REBOOTING THE CENTER DISPLAY

1. Press and hold the audio system power button for 10 seconds.

# Voice Interaction

## WHAT IS VOICE INTERACTION

Voice Interaction allows you to control vehicle features using conversational requests.

## SETTING YOUR DEFAULT ASSISTANT

You can set your default assistant to Google Assistant or Alexa Built-In.

1. From the settings menu, press Assistant & voice. See **Center Display** (page 468).
2. Press Digital assistant app.
3. Select the digital assistant you prefer.

## ALEXA BUILT-IN

Alexa Built-In allows you to use Alexa in your vehicle for auto-specific use cases on the road and gives you access to an ever-evolving number of skills that help to make your life more productive, entertaining, and connected while using your vehicle.

## Alexa Built-In Requirements

To use Alexa, all of the following must occur:

- Your vehicle modem is enabled.
- You are signed in to an existing Amazon account.
- Vehicle connectivity and vehicle data sharing is enabled.

## Signing In to Your Account

1. Open the app menu.

2.  Press the button and follow the on-screen prompts to sign in to your account.

**Note:** You can also sign in to Alexa via the settings menu.

## Signing Out of Your Account

1.  From the Alexa screen, press the button.
2. Press **Sign Out**.

## Using Alexa Built-In

Alexa can be used in three ways:

1. Say Alexa.

**Note:** Alexa must be set as your default assistant and the wake word must be enabled.

2.  Press the voice interaction button on the steering wheel and then say Alexa to invoke Alexa to start listening.

**Note:** Alexa must be set as your default assistant.

3.  From the Alexa app screen, press the button.

You can use Alexa for the following and more:

- Entertainment.
- Hands-free calling.
- Traffic and navigation.
- Vehicle controls.

# Voice Interaction

- Smart home device control.
- Weather and news information.

You can adjust the following settings in the touchscreen:

- Enable or disable the wake word.
- Enable or disable contact list sharing for connected phones.
- Learn more about what you can do with Alexa by browsing the things to try.
- Set the default assistant setting.

## GOOGLE ASSISTANT

Google Assistant allows you to use your voice to perform everyday tasks. You can make calls, get directions, play music, and control certain functions of your vehicle.

### Signing In to Your Account

Signing in to Google Assistant can be done in a number of ways, but the setup wizard on first boot is the most convenient way.

1. From the settings menu, press Driver profile settings. See **Center Display** (page 468).
2. Press Accounts.
3. Press Add.
4. Select Google account under associate accounts.

**Note:** *You can use Google Assistant without signing into a Google account, but signing in unlocks greater functionality such as smart home functionality and productivity features.*

### Signing Out of Your Account

1. From the settings menu, press Driver profile settings. See **Center Display** (page 468).
2. Press Accounts.
3. Press Remove.
4. Select Google account under associate accounts.

### Using Google Assistant

Google Assistant can be used in three ways:

1. Say OK Google.

**Note:** *Google Assistant must be set as your default assistant and the wake word must be enabled.*

2.  Press the voice interaction button on the steering wheel and then say OK Google or Hey Google to invoke Google Assistant to start listening.

**Note:** *Press the voice interaction button again to interrupt a voice prompt and begin speaking.*

**Note:** *Google Assistant must be set as your default assistant.*

3.  From the Google Assistant screen, press the button.

You can use Google Assistant for the following and more:

- Entertainment.
- Hands-free calling.
- Traffic and navigation.
- Vehicle controls.
- Managing your schedule.

# Voice Interaction

---

- Looking up answers.
- Smart home device control.
- Weather and news information.

You can adjust the following settings in the touchscreen:

- Adjust the language of your Assistant.
- Enable or disable the wake word.
- Allow personal results in this car.
- Allow suggestions from Assistant.
- Get notifications from your Assistant.
- Read and respond to vehicle notifications.

For additional information and settings about Google Assistant, scan the code.



# Phone

## PHONE PRECAUTIONS



**WARNING:** Driving while distracted can result in loss of vehicle control, crash and injury. We strongly recommend that you use extreme caution when using any device that may take your focus off the road. Your primary responsibility is the safe operation of your vehicle. We recommend against the use of any hand-held device while driving and encourage the use of voice-operated systems when possible. Make sure you are aware of all applicable local laws that may affect the use of electronic devices while driving.

## CONNECTING YOUR PHONE

1. From the settings menu, press Bluetooth. See **Center Display** (page 468).
2. Press Add device.

**Note:** A prompt alerts you to search for your vehicle on your cell phone.

3. Select your vehicle on your cell phone.

**Note:** A number appears on your cell phone and on the touchscreen.

4. Confirm the number on your cell phone matches the number on the touchscreen.

**Note:** The touchscreen indicates that you have successfully paired your cell phone.

5. Approve phonebook download request on your cell phone.

## PHONE MENU

This menu becomes available after pairing a phone.

### **Recent Call List**

Display and select an entry from a list of previous calls.

### **Contacts**

Display a smart search form to look up your contacts. Use the List button to alphabetically sort your contacts.

## **Favorites**

Display the list of favorite contacts that are set up on your phone.

## **SMS app**

Displays the list of text messages to read, listen to, or respond to.

## **Phone List**

Display the list of paired or connected devices that you can select.

**Note:** Up to 12 devices can be stored.

## **Do Not Disturb**

Reject incoming calls and switch ring tones and alerts off.

## **Phone Keypad**

Directly dial a number.

# Phone

---

## Voice Control

Press the button and say a command to use the Google or Siri voice assistant available on your connected phone to access supported features.

**Note:** *Some features under the phone menu may not be available if the feature is not supported through the phone.*

# Phone

## MAKING AND RECEIVING A PHONE CALL

### Making Calls

To call a number in your contacts, select:

Menu Item	Action and Description
Contacts	Select the name of the contact you want to call. Any numbers stored for that contact display along with any stored contact photos. Select the number that you want to call. The system begins the call.

To call a number from your recent calls, select:

Menu Item	Action and Description
Recent Call List	Select an entry that you want to call. The system begins the call.

To call a number from your favorites, select:

Menu Item	Action and Description
Favorites	Select an entry that you want to call. The system begins the call.

To call a number that is not stored in your phone, select:

Menu Item	Action and Description
Phone Keypad	Select the digits of the number you wish to call.
Call	The system begins the call.

Pressing the backspace button deletes the last digit you typed.

### Receiving Calls

During an incoming call, an audible tone sounds. Caller information appears in the display if it is available.

To accept the call, select:

Menu Item
Accept

**Note:** You can also accept the call by pressing the phone button on the steering wheel.

To reject the call, select:

Menu Item
Reject

Ignore the call by doing nothing. The system logs it as a missed call.

### During a Phone Call

During a phone call, the contacts name and number display on the screen along with the call duration.

The phone status items are also visible:

- Signal Strength.
- Battery.



# Phone

---

You can select any of the following during an active phone call:

Item	
End Call	Immediately end a phone call. You can also press the button on the steering wheel.
Keypad	Press this to access the phone keypad.
Mute	You can switch the microphone off so the caller does not hear you.
Privacy	Transfer the phone call audio to the cell phone or back to the touchscreen.
Hold	This feature allows you to put the active call on hold, to either make another call or answer an incoming call.

# Phone

---

## SENDING AND RECEIVING A TEXT MESSAGE

Menu Item	Description
Hear It	Hear the text message.
View	View the text message.
Call	Call the sender.
Reply	Reply to the text message with a standard text message.

# Phone

## SWITCHING TEXT MESSAGE NOTIFICATION ON AND OFF

The settings on your device must be enabled to receive text message notifications on the center display. Check your device settings to enable these features.

## SWITCHING APPLE CARPLAY ON AND OFF

The operating system is compatible with wireless Apple CarPlay on iPhone 6s or later. Make sure your iPhone has been updated to the latest version of iOS.

### Enabling Wireless Apple CarPlay

1. Pair your device to **Bluetooth**. See **Connecting Your Phone** (page 474).
2. Follow the instructions on your device and the touchscreen.

### Disabling Wireless Apple CarPlay

While Apple CarPlay is connected:

1. From the settings menu, press Bluetooth. See **Center Display** (page 468).
2. Find your device in the list.
3. Press the Apple CarPlay button.

### Re-Enabling Wireless Apple CarPlay

1. From the settings menu, press Bluetooth. See **Center Display** (page 468).
2. Select your device from the list.
3. Press the Apple CarPlay button.

## SWITCHING ANDROID AUTO ON AND OFF

### Enabling Android Auto with USB (If Equipped)

1. Connect your device to a USB port.
2. Follow the instructions on your device and the touchscreen.

### Enabling Android Auto with Wireless

1. Pair your device to **Bluetooth**®.

2. Follow the instructions on your device and the touchscreen.

**Note:** *Android Auto Wireless is not supported on certain Android devices. For more information, scan here.*



### Disabling Android Auto

While Android Auto is connected:

1. From the settings menu, press Bluetooth. See **Center Display** (page 468).
2. Find your device in the list.
3. Press the Android Auto button.

### Re-Enabling Android Auto

1. From the settings menu, press Bluetooth. See **Center Display** (page 468).

# Phone

---

2. Find your device in the list.
3. Press the Android Auto button.

**Note:** *While using Android Auto/Apple CarPlay, some vehicle data such as speed and location is shared with your phone. This data does not identify you. Vehicle manufacturer is not responsible for the way this data is handled and may disable Android Auto/Apple CarPlay at any time.*

## CONNECTING A BLUETOOTH® DEVICE

1. From the settings menu, press Connectivity. See **Center Display** (page 468).
2. Press Phone list.
3. Press Bluetooth.

**Note:** A prompt alerts you to search for your vehicle on your device.

1. Select your vehicle on your device.

**Note:** A number appears on your device and on the touchscreen.

2. Confirm that the number on your device matches the number on the touchscreen.

**Note:** The touchscreen indicates that you have successfully paired your device.

The **Bluetooth®** word mark and logos are registered trademarks owned by **Bluetooth SIG, Inc.** and any use of such marks by Ford Motor Company is under license. Other trademarks and trade names are those of their respective owners.

## PLAYING MEDIA USING BLUETOOTH®



**WARNING:** Driving while distracted can result in loss of vehicle control, crash and injury. We strongly recommend that you use extreme caution when using any device that may take your focus off the road. Your primary responsibility is the safe operation of your vehicle. We recommend against the use of any hand-held device while driving and encourage the use of voice-operated systems when possible. Make sure you are aware of all applicable local laws that may affect the use of electronic devices while driving.



Connect your device.



 Press the audio button on the feature bar.

 Press **Sources**.

 Press the **Bluetooth®** option.

 Press to play a track. Press again to pause the track.

 Press to skip to the next track.  
 Press and hold to fast forward through the track.

 Press once to return to the beginning of a track. Repeatedly press to return to previous tracks.  
 Press and hold to fast rewind through the track.

# Personal Profiles

---

## HOW DO PERSONAL PROFILES WORK

This feature allows you to create multiple personal profiles enabling users to personalize vehicle's settings such as seats and mirrors, as well as non-positional settings like radio, navigation and driver assist.

Positional settings are saved by holding a memory seat button. Non-positional settings are saved when you change a setting while a profile is active. You can create one profile for each preset memory seat button along with a guest profile.

### Recalling and Changing a Profile

You can recall a profile using the touchscreen or the preset button you selected when you created your profile. You can also link a remote control and a mobile device to your profile, to recall the profile.

## ENABLING OR DISABLING PERSONAL PROFILES

The vehicle does not allow the user to disable personal profiles.

**Note:** *Personal profiles are disabled automatically when Valet Mode is entered.*

## CREATING A PERSONAL PROFILE

1. Switch the vehicle on and leave it in park (P).
2. From the settings menu, press Profile. See **Center Display** (page 468).
3. Follow the instructions on the display.

**Note:** *The guest profile is auto created with its own memory settings.*

**Note:** *You cannot link a personalized name to a guest profile.*

## LINKING OR UNLINKING A PERSONAL PROFILE TO A REMOTE CONTROL

You can save Personal Profiles, including preset memory positions, for up to three remote controls by assigning a remote control to a personal profile using the touchscreen.

1. Switch the vehicle on and leave the vehicle in park (P).
2. From the settings menu, press Personal Profiles. See **Center Display** (page 468).
3. Select the profile you wish to link to a remote control.
4. Press Edit.
5. Press ID methods.
6. Follow the instructions on the display.

**Note:** *If more than one linked remote control is in range, the memory function moves to the settings of the first key to initiate a memory recall.*

# Personal Profiles

---

**Note:** *The guest profile consists of existing settings when there is no driver profile created. After you create a driver profile, the guest profile serves as an additional driver profile.*

**Note:** *You cannot link a remote control to a guest profile.*

**Note:** *The guest profile consists of existing settings when there is no driver profile created. After you create a driver profile, the guest profile serves as an additional driver profile.*

**Note:** *You cannot link a personalized name to a guest profile.*

## LINKING OR UNLINKING A PERSONAL PROFILE TO A DEVICE

1. Switch the vehicle on and leave the vehicle in park (P).
2. From the settings menu, press Personal Profiles. See **Center Display** (page 468).
3. Select the profile you wish to link to a mobile device.
4. Press Edit.
5. Press ID methods.
6. Follow the instructions on the display.

**Note:** *To successfully link a mobile device, the mobile device must be in your vehicle, and previously set up as a remote control for your vehicle.*

# Navigation

---

## CONNECTED NAVIGATION

Google Maps provides the navigation software on your vehicle. For more information scan here:





# Vehicle Software Updates

Lincoln Enhance software updates uses over-the-air technology to deliver the latest features, software enhancements and quality improvements to your vehicle.

When Automatic Updates is turned on updates are downloaded in the background while you are driving.

Some updates require your vehicle to be parked. You can set a recurring schedule when your vehicle is not in use (like overnight). Scheduled updates usually take up to 45 minutes and some updates can take longer than that. Check your center display screen or the Lincoln Way app for the most accurate estimated update time.

Software updates are delivered wirelessly using the vehicle modem or Wi-Fi. To make sure the most seamless experience. See **Connecting the Vehicle to a Wi-Fi Network** (page 456).

## Software Update Requirements

The following conditions must be met to receive scheduled updates:

- The vehicle is parked.
- The ignition is off.
- All doors are closed.
- Your foot is off the brake pedal.
- The parking lamps are off.
- The alarm is not triggered.
- The hazard indicators are off.
- Your 12V battery is charged.
- No emergency calls are in place.
- Your vehicle is not in limp home mode.

## Software Update Limitations

Once a scheduled update begins you cannot:

- Cancel the update.
- Drive your vehicle.
- Start the ignition.
- Start your vehicle.
- Use the alarm, central locks or door tones.

- Use the remote control to lock, unlock or start your vehicle.
- Use the electronic door locks.
- Fast charge your electric vehicle.
  - If connected to a level 1 or 2 charger, charging pauses until the update is completed.

**Note:** *If an update is interrupted you will receive a notification on Lincoln Way app with instructions to resolve it. If there are no action steps, contact your authorized dealer.*

## SOFTWARE UPDATE SETTINGS

To access the Software Updates menu:

1. Press Setting on the touchscreen.
2. Press System.
3. Press Software Updates.

You can do the following in the Software Updates menu:

- Switch Automatic Updates on and off.
- Schedule and install software updates.

# Vehicle Software Updates

- View software update details.
- Switch Notifications on or off.



Press the button next to a menu option for more information.

## Switching Automatic Updates On and Off

Your vehicle may come with Automatic Updates switched on. To make sure your vehicle always has the latest software, which could include security or other enhancements, we do not recommend switching Automatic Updates off.

**Note:** *Software updates require approval to download or install with Automatic Updates switched off.*

## Scheduling and Installing Software Updates

### Scheduling Software Updates

From the Software Updates menu:

1. Press **Schedule Updates**.
2. Select the days and time for updates.

The more days that updates are scheduled, the more frequently your vehicle installs new updates. We recommend selecting a time you normally do not need your vehicle, such as overnight.

Some updates require your vehicle to be switched off.

**Note:** *The schedule you set is recurring. If Automatic Updates is on, every time a scheduled update is available, it installs on this schedule unless you change it. You are notified on your touchscreen and connected device prior to a scheduled update, with an option to reschedule it.*

### Installing Software Updates

#### Using the Status Bar

1. Press a Software Update indicator on your touchscreen when it appears.
2. Follow the instructions on the touchscreen.

#### Using the Touchscreen

From the Software Updates menu:

1. Press Update Details.

2. Press Update Now.

## Viewing Software Update Details

From the Software Updates menu:  
Press Update Details.

## SOFTWARE UPDATE INDICATORS



Vehicle software update reminder, schedule required, confirmation of default schedule required, or consent required.



Vehicle software update canceled, update not successful, or precondition not met.



Vehicle software update successful.

# Vehicle System Reset

---

## PERFORMING A SYSTEM RESET

To perform a reset:

1. Press Settings from the Apps menu.
2. Press System.
3. Press Reset options.
4. Select the reset you prefer.
5. Follow the prompts on screen to complete the reset.



There are multiple resets available, press the button next to each for more information.

Perform a factory reset whenever there is a transfer of vehicle ownership to prevent the loss of personal data. Performing a factory reset allows you to remove all personal information and restore the modem and center display to their factory defaults.

In the modem, this deletes all the authorized users and removes access to the connected vehicle. In the system this deletes all data imported from mobile devices connected to the vehicle via **Bluetooth**® including the addresses manually entered into the navigation system.

**Note:** *If you are the first owner, your modem comes in a partially activated state.*

**Note:** *If you are not the first owner, it comes in either a fully activated, partially activated or deactivated state.*

# Accessories

For a complete listing of the accessories that are available for your vehicle, please contact your authorized dealer or visit the online store website:

<b>Web Address (United States)</b>
<a href="https://accessories.lincoln.com/">https://accessories.lincoln.com/</a>

<b>Web Address (Canada)</b>
<a href="http://www.lincolncanada.com">www.lincolncanada.com</a>

We will repair or replace any properly authorized dealer-installed Lincoln Original Accessory found to be defective in factory-supplied materials or workmanship during the warranty period, as well as any component damaged by the defective accessories.

We will warrant your Lincoln Original Accessory through the warranty that provides the greatest benefit:

- 24 months, unlimited mileage.
- The remainder of your new vehicle limited warranty.

## Lincoln Licensed Accessories

The accessory manufacturer designs, develops and therefore warrants Lincoln Licensed Accessories, and does not design or test these accessories to Lincoln engineering requirements. Contact an authorized Lincoln dealer for the accessory manufacturer's limited warranty details and request a copy of the Lincoln Licensed Accessories product limited warranty from the accessory manufacturer. See your warranty guide for more information.

For maximum vehicle performance, keep the following information in mind when adding accessories or equipment to your vehicle:

- When adding accessories, equipment, passengers and luggage to your vehicle, do not exceed the total weight capacity of the vehicle or of the front or rear axle (GVWR or GAWR as indicated on the Safety Compliance Certification label). Ask an authorized dealer for specific weight information.
- The Federal Communications Commission (FCC) and Canadian Radio Telecommunications Commission (CRTC) regulate the use of mobile communications systems that have radio transmitters, for example two-way radios, telephones and theft alarms. Any such equipment installed in your vehicle should comply with Federal Communications Commission (FCC) and Canadian Radio Telecommunications Commission (CRTC) regulations and should only be installed by an authorized dealer.

# Accessories

---

- Mobile communications systems may harm the operation of your vehicle, particularly if their manufacturer did not design them specifically for automotive use.
- If you or an authorized Lincoln dealer add any non-Lincoln electrical or electronic accessories or components to your vehicle, you may adversely affect battery performance and durability. In addition, you may also adversely affect the performance of other electrical systems in the vehicle.

# Lincoln Protect

---

## WHAT IS LINCOLN PROTECT

Protect yourself from the rising cost of vehicle repairs with the Lincoln Protect extended service plan.

### Lincoln Protect Extended Service Plans (United States Only)

Lincoln Protect means peace of mind. It is the extended service plan backed by Lincoln, and provides more protection beyond the New Vehicle Limited Warranty coverage. When you visit your Lincoln Dealer, insist on genuine Lincoln Protect extended service plans.

### Lincoln Protect Extended Service Plan Can Quickly Pay for Itself

One trip to the Service Center could easily exceed the price of your Lincoln Protect extended service plan. With Lincoln Protect, you minimize your risk for unexpected repair bills and rising repair costs.

## Up to 1000+ Covered Vehicle Components

There are four mechanical Lincoln Protect extended service plans with different levels of coverage. Ask your authorized dealer for details.

1. PremiumCARE - Our most comprehensive coverage. With over 1,000 covered components, this plan is so complete it is probably easier to list what is not covered.
2. ExtraCARE - Covers 113 components, and includes many high-tech items.
3. BaseCARE - Covers 84 components.
4. PowertrainCARE - Covers 29 critical components.

Lincoln Protect extended service plans are honored by all authorized Lincoln dealers in the United States, Canada and Mexico.

That means you get:

- Reliable, quality service at any Lincoln or Ford dealership.
- Repairs performed by factory trained technicians, using genuine parts.

## Rental Car Reimbursement

### *First Day Rental Benefit*

If you bring your car into your dealer for service, we will give you a rental vehicle to use for the day.

### *Extended Rental Benefits*

If your vehicle is kept overnight for covered repairs, you are eligible for rental car coverage, including bumper to bumper warranty repairs, and field service actions.

### Roadside Assistance

Exclusive 24/7 roadside assistance, including:

- Towing, flat-tire change and battery jump starts.
- Out of fuel and lock-out assistance.
- Travel expense reimbursement for lodging, meals and rental car.
- Assistance for taxi, shuttle, rental car coverage and other transportation.

# Lincoln Protect

---

## Transferable Coverage

If you sell your vehicle before your Lincoln Protect extended service plan coverage expires, you can transfer any remaining coverage to the new owner. This should give you and your potential buyer a little more peace of mind.

## Less Cost to Properly Maintain Your Vehicle

The Lincoln Protect extended service plan also offers a Premium Maintenance Plan that covers all scheduled maintenance, and selected wear items. The coverage is prepaid, so you never have to worry about the cost of your vehicle's maintenance.

Covered maintenance includes:

- Windshield wiper blades.
- Spark plugs.
- The clutch disc - if equipped.
- Brake pads and linings.
- Shock absorbers and struts.
- Engine cooling hoses, clamps and o-rings.

- Engine belts.
- Diesel exhaust fluid replenishment - if equipped.

## Interest Free Finance Options

Just a 5% down payment will provide you with an affordable, no interest, no fee payment program allowing you all the security and benefits Lincoln Protect extended service plan has to offer while paying over time. You are pre-approved with no credit check or hassles. To learn more, call our Lincoln Protect extended service plan specialists at 800-367-3377.

Complete the information below and mail to:

Lincoln Protect Extended Service Plan  
P.O. Box 321067  
Detroit, MI 48232

## Lincoln Protect (Canada Only)

You can get more protection for your vehicle by purchasing a Lincoln Protect extended service plan. The Lincoln Protect extended service plan is the only service contract backed by Lincoln, Limited. Depending on the plan you purchase, the Lincoln Protect extended service plan provides benefits such as:

- Rental reimbursement.
- Coverage for certain maintenance and wear items.
- Protection against repair costs after your New Vehicle Limited Warranty Coverage expires.
- Roadside Assistance benefits.

# Lincoln Protect

---

There are several Lincoln Protect extended service plans available in various time, distance and deductible combinations. Each plan is tailored to fit your own driving needs, including reimbursement for towing and rental. When you purchase a Lincoln Protect extended service plan, you receive added peace-of-mind protection throughout Canada, the United States and Mexico, provided by a network of participating authorized Lincoln dealers.

**Note:** *Repairs performed outside of Canada, the United States and Mexico are not eligible for Lincoln Protect extended service plan coverage.*

This information is subject to change. For more information, visit your local Lincoln of Canada dealer or [www.LincolnCanada.com](http://www.LincolnCanada.com) to find the Lincoln Protect extended service plan that is right for you.



# Scheduled Maintenance

---

## GENERAL MAINTENANCE INFORMATION

### Why Maintain Your Vehicle?

Carefully following the maintenance schedule helps protect against major repair expenses resulting from neglect or inadequate maintenance and may help to increase the value of your vehicle when you sell or trade it. Keep all receipts for completed maintenance with your vehicle.

It is important that you have your vehicle serviced at the proper times. These intervals serve two purposes: first is to maintain the reliability of your vehicle and the second is to keep the cost of owning your vehicle down.

It is your responsibility to have all scheduled maintenance performed and to make sure that the materials used meet the specifications identified in this owner's manual. See **Capacities and Specifications** (page 436).

Failure to perform scheduled maintenance and regularly inspect your vehicle may result in vehicle damage not covered by the vehicle Warranty.

### Why Maintain Your Vehicle at Your Dealership?

#### Our Genuine Replacement Parts

Dealerships stock our parts and our authorized branded remanufactured replacement parts. These parts meet or exceed our specifications. Parts installed at your dealership carry a nationwide 24-month or unlimited mile (kilometer) parts and labor limited warranty.

If you do not use our authorized parts, they may not meet our specifications and could affect emissions compliance.

### Protecting Your Investment

Maintenance is an investment that pays dividends in the form of improved reliability, durability and resale value. To maintain the proper performance of your vehicle and its emission control systems, make sure you have scheduled maintenance performed at the designated intervals.

Your vehicle comes with the Intelligent Oil-Life Monitor system, a message appears in the instrument cluster display at the proper oil change interval. This interval may be up to one year or 10,000 mi (16,000 km), hybrid vehicles could exceed 10,000 mi (16,000 km).

When the oil change message appears in the instrument cluster display, it is time for an oil change. Make sure you perform the oil change within two weeks or 500 mi (800 km) of the message appearing. Make sure to reset the Intelligent Oil-Life Monitor after each oil change. See **Resetting the Intelligent Oil Life Monitor** (page 380).

# Scheduled Maintenance

---

If your instrument cluster display resets prematurely or becomes inoperative, you should perform the oil change interval at six months or 5,000 mi (8,000 km) from your last oil change. Never exceed one year or 10,000 mi (16,000 km) between oil change intervals.

You can drive your vehicle in such a way that may lead to higher oil consumption including extended time at high engine speeds, high loads, engine braking, hard cornering maneuvers, track and off-road usage. Under these conditions, oil consumption of approximately 1 quart per 500 miles (1 liter per 800 km) is possible. Check the engine oil level at every refueling and adjust to maintain proper levels to avoid engine damage.

You can also drive your vehicle in such a way that dilutes and increases the level of oil by frequent short trips that do not allow the engine to get to operating temperature, extended idling and low speed driving for long periods of time.

It is important to rely upon your dealership to properly diagnose and repair your vehicle.

We strongly recommend only using our genuine or our authorized re-manufactured replacement parts engineered for your vehicle.

## **Additives and Chemicals**

We do not recommend using chemicals or additives not approved by us as part of your vehicle's normal maintenance. Please consult your warranty information.

## **Oils, Fluids and Flushing**

In many cases, fluid discoloration is a normal operating characteristic and, by itself, does not necessarily indicate a concern or that the fluid needs to be changed. Have discolored fluids that also show signs of overheating or foreign material contamination checked immediately.

Make sure to change the vehicle's oils and fluids at the specified intervals or in conjunction with a repair. Flushing is a viable way to change fluid for many vehicle sub-systems during scheduled maintenance. It is critical that systems are flushed only with new fluid that is the same as that required to fill and operate the system or using our approved flushing chemical.

## **Scheduled Maintenance Service Intervals**

For your scheduled maintenance service intervals, visit <https://www.ford.com/support/maintenance-schedule>.

## **Owner Checks and Services**

Make sure you perform the following basic maintenance checks and inspections.

# Scheduled Maintenance

---

<b>Check Every Month</b>
The engine oil level.
Function of all interior and the exterior lights.
The tires including the spare for wear and proper pressure.
The windshield washer fluid level.

<b>Check Every Six Months</b>
The battery connections. Clean if necessary.
The body and door drain holes for obstructions. Clean if necessary.
The cooling system fluid level and the coolant system strength.
The door weatherstrips for wear. Lubricate if necessary.
The hinges, latches and outside locks for proper operation. Lubricate if necessary.
The parking brake for proper operation.
The seatbelts and seat latches for wear and function.
Safety warning lamps, brake, ABS, airbag and seatbelt for operation.
The washer spray and wiper operation. Clean or replace blades as necessary.

# Scheduled Maintenance

## Multi-Point Inspection

It is important to have the systems on your vehicle regularly checked. This can help identify potential issues and prevent major

problems. We recommend having the following multi-point inspection performed at every scheduled maintenance interval to help make sure your vehicle keeps running great.

Multi-Point Inspection	
Accessory drive belt or belts	Hazard warning system operation
Battery performance	Horn operation
Engine air filter	Radiator, cooler, heater and air conditioning hoses
Exhaust system	Suspension components for leaks or damage
Exterior lamps operation	Steering and linkage
Fluid levels <sup>1</sup> ; fill if necessary	Tires including the spare for wear and proper pressure <sup>2</sup>
For oil and fluid leaks	Windshield for cracks, chips or pits
Halfshaft dust boots	Washer spray and wiper operation

<sup>1</sup> Brake, coolant recovery reservoir, automatic transmission and window washer.

<sup>2</sup> If your vehicle has a temporary mobility kit, check the tire sealant expiration Use By date on the canister. Replace as needed.

# Scheduled Maintenance

---

Be sure to ask your dealership service advisor or technician about the multi-point vehicle inspection. It is a comprehensive way to perform a thorough inspection of your vehicle. Your checklist gives you immediate feedback on the overall condition of your vehicle.

# Customer Information

## ROLLOVER WARNING



**WARNING:** Utility vehicles have a significantly higher rollover rate than other types of vehicles.



**WARNING:** Vehicles with a higher center of gravity (utility and four-wheel drive vehicles) handle differently than vehicles with a lower center of gravity (passenger cars). Avoid sharp turns, excessive speed and abrupt steering in these vehicles. Failure to drive cautiously increases the risk of losing control of your vehicle, vehicle rollover, personal injury and death.



**WARNING:** In a rollover crash, an unbelted person is significantly more likely to die than a person wearing a seatbelt.



**WARNING:** Do not become overconfident in the ability of four-wheel drive vehicles. Although a four-wheel drive vehicle may accelerate better than a two-wheel drive vehicle in low traction situations, it won't stop any faster than two-wheel drive vehicles. Always drive at a safe speed.

Utility vehicles and trucks handle differently than passenger cars in the various driving conditions that are encountered on streets, highways and off-road. Utility vehicles and trucks are not designed for cornering at speeds as high as passenger cars any more than low-slung sports cars are designed to perform satisfactorily under off-road conditions.

## THE BETTER BUSINESS BUREAU AUTO LINE PROGRAM

Your satisfaction is important to Ford Motor Company and to your dealer. If a warranty concern has not been resolved using the three-step procedure outlined earlier in this chapter in the Getting the Services you need section, you may be eligible to participate in the BBB AUTO LINE program.

The BBB AUTO LINE program consists of two parts – mediation and arbitration. During mediation, a representative of the BBB will contact both you and Ford Motor Company to explore options for settlement of the claim. If an agreement is not reached during mediation or you do not want to participate in mediation, and if your claim is eligible, you may participate in the arbitration process. An arbitration hearing will be scheduled so that you can present your case in an informal setting before an impartial person. The arbitrator considers the testimony provided and makes a decision after the hearing.

## Customer Information

---

Disputes submitted to the BBB AUTO LINE program are usually decided within 40 days after you file your claim with the BBB. You are not bound by the decision, and may reject the decision and proceed to court where all findings of the BBB Auto Line dispute, and decision, are admissible in the court action. Should you choose to accept the BBB AUTO LINE decision, Ford is then bound by the decision, and must comply with the decision within 30 days of receipt of your acceptance letter.

**BBB AUTO LINE Application:** Using the information that follows, call or write to request a program application. You will be asked for your name and address, general information about your new vehicle, information about your warranty concerns, and any steps you have already taken to try to resolve them. A Customer Claim Form will be mailed that needs to be completed, signed and returned to the BBB along with proof of ownership. Upon receipt, the BBB reviews the claim for eligibility under the Program Summary Guidelines.

**You can get more information by calling BBB AUTO LINE at 1-800-955-5100, or writing to:**

**BBB AUTO LINE a Division of BBB National Programs, Inc.  
1676 International Drive, Suite 550  
McLean, VA 22102**

BBB AUTO LINE applications can also be requested by calling the Ford Motor Company Customer Relationship Center at 1-800-392-3673.

For additional information, refer to the Better Business Bureau website.

**Note:** *Ford Motor Company reserves the right to change eligibility limitations, modify procedures, or to discontinue this process at any time without notice and without obligation.*

### **THE MEDIATION AND ARBITRATION PROGRAM**

For vehicles delivered to authorized Canadian dealers. In those cases where you continue to feel that the efforts by Ford of Canada and the authorized dealer to resolve a factory-related vehicle service concern have been unsatisfactory, Ford of Canada participates in an impartial third party mediation/arbitration program administered by the Canadian Motor Vehicle Arbitration Plan (CAMVAP).

The CAMVAP program is a straightforward and relatively speedy alternative to resolve a disagreement when all other efforts to produce a settlement have failed. This procedure is without cost to you and is designed to eliminate the need for lengthy and expensive legal proceedings.

## Customer Information

---

In the CAMVAP program, impartial third-party arbitrators conduct hearings at mutually convenient times and places in an informal environment. These impartial arbitrators review the positions of the parties, make decisions and, when appropriate, render awards to resolve disputes. CAMVAP decisions are fast, fair, and final as the arbitrator's award is binding on both you and Ford of Canada.

CAMVAP services are available in all Canadian territories and provinces. For more information, without charge or obligation, call your CAMVAP Provincial Administrator directly at 1-800-207-0685 or visit [www.camvap.ca](http://www.camvap.ca).

### **ORDERING A CANADIAN FRENCH OWNER'S MANUAL**

You can obtain a French owner's manual from an authorized dealer or by contacting Helm, LLC at:

HELM, LLC  
47911 Halyard Drive, Suite 200  
Plymouth, Michigan 48170  
Attention: Customer Service  
Call toll free: 1-800-782-4356  
Monday-Friday 8:00 a.m. - 6:00 p.m. EST  
For additional information, visit [www.helminc.com](http://www.helminc.com).

### **REPORTING SAFETY DEFECTS IN THE UNITED STATES**

If you believe that your vehicle has a defect which could cause a crash or could cause injury or death, you should immediately inform the National Highway Traffic Safety Administration (NHTSA) in addition to notifying Ford Motor Company.

If NHTSA receives similar complaints, it may open an investigation, and if it finds that a safety defect exists in a group of vehicles, it may order a recall and remedy campaign. However, NHTSA cannot become involved in individual problems between you, your dealer, or Ford Motor Company.

To contact NHTSA, you may call the Vehicle Safety Hotline toll-free at 1-888-327-4236 (TTY: 1-800-424-9153); go to [www.safercar.gov](http://www.safercar.gov); or write to:

Administrator

1200 New Jersey Avenue, Southeast  
Washington, D.C. 20590

You can also obtain other information about motor vehicle safety from [www.safercar.gov](http://www.safercar.gov).



# Customer Information

---

## REPORTING SAFETY DEFECTS IN CANADA

If you believe that your vehicle has a defect

which could cause a crash or could cause injury or death, you should immediately inform Transport Canada and Ford of Canada.

Transport Canada Contact Information	
Website (English)	<a href="http://tc.canada.ca/recalls">http://tc.canada.ca/recalls</a>
Website (French)	<a href="http://tc.canada.ca/rappels">http://tc.canada.ca/rappels</a>
Phone	1-800-333-0510

Lincoln of Canada Contact Information	
Website	<a href="http://www.LincolnCanada.com">www.LincolnCanada.com</a>
Phone	1-800-387-9333

# Customer Information

---

## THIRD PARTY SOFTWARE COPYRIGHT ACKNOWLEDGMENT

Your vehicle could have components that use open source software. For additional information, visit <http://corporate.ford.com/ford-open-source.html>.

## RADIO FREQUENCY CERTIFICATION LABELS

## BLIND SPOT INFORMATION SYSTEM SENSORS

Device	Supplier	Type Designation
SRR5 BLIS Corner Radar (RRU2)	Aptiv	2F5TR

# Customer Information

## Argentina



H-28070

## Brazil



15375-23-12270

## China

CMIIT ID: 2023LJ10407

## Europe Union EU

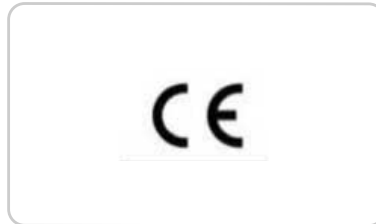

## Ghana

NCA APPROVED: 7E6-M0-XDF-TME

## Jamaica

This product has been Type Approved by Jamaica: SMA - 2F5TR.

## Paraguay



# Customer Information

---

NR: 2022-04-I-0255

Taiwan



CCAI23LP0640T2

**United Arab Emirates (U.A.E.)**



TDR

ER10085/22  
United Arab Emirates



# Customer Information

## United Kingdom



## United States and Canada

 **WARNING:** Changes or modifications not expressly approved by the party responsible for compliance could void the user's authority to operate the equipment. The term "IC:" before the radio certification number only signifies that Industry Canada technical specifications were met.

FCC ID: L2C2F5TR

IC: 3432A-2F5TR

This device complies with Part 15 of the FCC Rules and with Innovation, Science and Economic Development Canada's licence-exempt RSS(s). Operation is subject to the following two conditions:

1. This device may not cause harmful interference, and
2. This device must accept any interference received, including interference that may cause undesired operation.

## BLIND SPOT INFORMATION SYSTEM SENSORS

Device	Supplier	Type Designation
SRR5 BLIS Corner Radar	Aptiv	F5TR

# Customer Information

## Argentina



## Djibouti

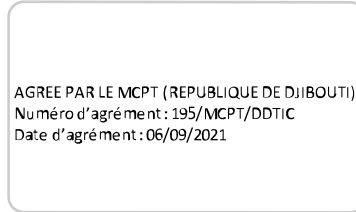

## Ghana



## Brazil



## Europe Union EU



## Jamaica

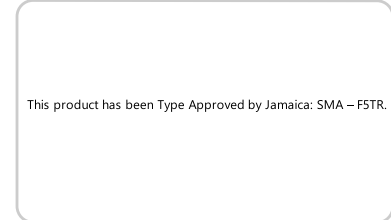

# Customer Information

---

## Mauritania

AGREE PAR L'ANEMAURITANIE  
Numéro d'agrément : 0985/ARE/2021  
Date d'agrément : 24/08/2021

## Mexico

IFETEL: RCPAPF520-0480

## Morocco

AGREE PAR L'ANRT MAROC  
Numéro d'agrément : MR00030033ANRT2021  
Date d'agrément : 16/09/2021

## Paraguay



2020-10-I-0753

# Customer Information

## Singapore

Complies with IMDA Standards

DA 00461

## South Korea



## Taiwan

## Thailand

- (1) เพื่อใช้โทรคมนาคมและอุปกรณ์นี้ มีความสอดคล้องตามข้อกำหนดของ กททช.
- (2) เพื่อใช้โทรคมนาคมและอุปกรณ์นี้ ครอบคลุมแม้กระทั่งใช้ทั้งที่สอดคล้องตามมาตรฐานความปลอดภัยของข้อมูลของประเทศไทย

## Ukraine



## South Africa





# Customer Information

## United Arab Emirates (U.A.E.)



## United Kingdom



## United States and Canada

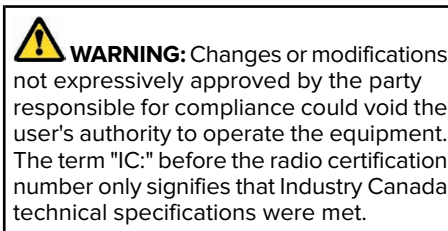

FCC ID: L2CF5TR

IC: 3432A-F5TR

This device complies with Part 15 of the FCC Rules and with Innovation, Science and Economic Development Canada's licence-exempt RSS(s). Operation is subject to the following two conditions:

1. This device may not cause harmful interference, and
2. This device must accept any interference received, including interference that may cause undesired operation.

# Customer Information

## Vietnam

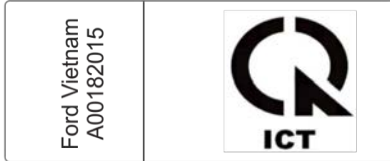

## REMOTE FUNCTION ACTUATOR

### China

CMIIT ID: 2018DJ4563

## United States and Canada

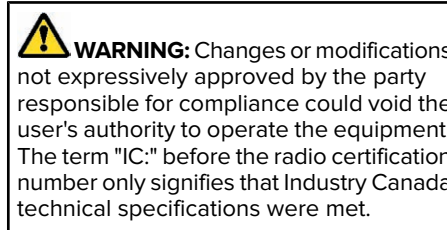

FCC ID: HYQS2NA0

IC: 1551A-S2NA0

This device complies with Part 15 of the FCC Rules and with Innovation, Science and Economic Development Canada's licence-exempt RSS(s). Operation is subject to the following two conditions:

1. This device may not cause harmful interference, and
2. This device must accept any interference received, including interference that may cause undesired operation.

## BODY CONTROL MODULE

### European Union EU



### Israel

1. מספר אישור התאמה סטטוס משרד התקשורת: 5I-87448
2. חל איסור לבצע פעולות במכשיר שיש בהן כדי לשנות את תכונותיו האלחוטיות של המכשיר, ובכלל זה שינוי תוכנה, החלפת אנטנה סקורית או הוספת אפשרות לחיבור לאנטנה חיצונית, בלא קבלת אישור משרד התקשורת, כישל החשש להפרעות אלחוטיות.

# Customer Information

## Malaysia



HIDF16000009

## Mexico



IFT: ROCOM323-07072

## Moldova



## Morocco

AGREE PAR L'ANRT MAROC

Numéro d'agrément:  
MR00034975ANRT2022

Date d'agrément: 21/10/2022

## Serbia



# Customer Information

---

## Singapore

Complies with IMDA Standards

DA 00461

## South Africa



**CCAB22LP1260T7**

## Ukraine



## Taiwan



**CCAB22LP1250T4**

# Customer Information

## United Arab Emirates (U.A.E.)



## United Kingdom



## United States and Canada

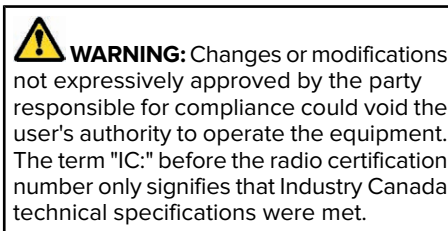

FCC ID: M3NA2C780107

IC: 7812A-A2C780107

This device complies with Part 15 of the FCC Rules and with Innovation, Science and Economic Development Canada's licence-exempt RSS(s). Operation is subject to the following two conditions:

1. This device may not cause harmful interference, and
2. This device must accept any interference received, including interference that may cause undesired operation.

# Customer Information

## CRUISE CONTROL MODULE

Device	Supplier	Type Designation
MRR3 Medium Range Radar	Aptiv	F3TR

### Argentina



### Brazil



### Djibouti

AGREE PAR LE MCPT (REPUBLIQUE DE DJIBOUTI)  
Numéro d'agrément : 059/DDTIC/2020  
Date d'agrément : 01/10/2020

# Customer Information

## EAC Marking - Russia, Belarus, Kazakhstan



## Europe Union EU



## Ghana

NCA APPROVED: SRO-1M-7E4-X13

## Independent State Of Samoa



## Israel

1. מספר אישור התאמה מסוג מסדד התקשורת: 51-82320
2. חל אישור לבצע פעולות במכשיר שיש בהן כדי לשנות את תכונותיו האלחוטיות של המכשיר, ובכלל זה שינוי תוכנה, החלפת אנטנה מקורית או הוספת אפשרות לחיבור לאנטנה חיצונית, בלא קבלת אישור משרד התקשורת, כשל החשש להפרעת אלחוטיות.

## Jamaica

This product has been Type Approved by Jamaica: SMA – F3TR.

# Customer Information

---

## Malaysia



HIDF16000009

## Mauritania

AGREE PAR L'ANEMAURITANIE  
Numéro d'agrément : 0835/ARE/2020  
Date d'agrément : 31/08/2020

## Mexico

IFT: RCPAPF320-0479

## Moldova



## Morocco

AGREE PAR L'ANRT MAROC

Numéro d'agrément:  
MR00030034ANRT2021

Date d'agrément: 16/09/2021



# Customer Information

## Pakistan



NR: 2020-10-I-0752

## Sierra Leone



## Singapore

Complies with IMDA Standards

DA 00461

## Paraguay



TAN: 2021-002-0028

## South Africa



# Customer Information

## South Korea



R-C-1Ap-F3TR

## Taiwan



## Thailand

- (1) เครื่องโทรคมนาคมและอุปกรณ์อื่น ๆ มีความสอดคล้องตามข้อกำหนดของ กทท.
- (2) เครื่องโทรคมนาคมและระบบการเคลื่อนที่ผ่านเครือข่ายที่สอดคล้องตามมาตรฐานความปลอดภัยข้อมูลของศูนย์จัดการขึ้นเพื่อวัตถุประสงค์และกรรมการจัดการโทรคมนาคมแห่งชาติประกาศ

## Ukraine



# Customer Information

## Unites Arab Emirates (U.A.E.)



## United Kingdom



## United States and Canada

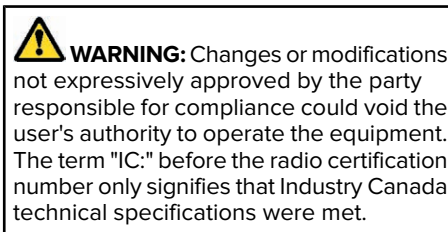

FCC ID: L2CF3TR

IC: 3432A-F3TR

This device complies with Part 15 of the FCC Rules and with Innovation, Science and Economic Development Canada's licence-exempt RSS(s). Operation is subject to the following two conditions:

1. This device may not cause harmful interference, and
2. This device must accept any interference received, including interference that may cause undesired operation.

# Customer Information

## Zambia



## KEYS AND REMOTE CONTROLS

### Argentina



H-28042

### Israel

1- מספר אישור התאמת סמנים משרד התקשורת: **51-85634**  
2- חל אישור לבצע פעולות במוכשרי שישו בידו לשנות את תוכנותיה האלחוטיות של המכשיר, ככלל זה שיוכי תוכנה, התחלת אנטנה מקורית או הסמכת אישורת להיכיר לאנטנה חיצונית, בלא קבלת אישור משרד התקשורת, בעל החשב להפרעת אלחוטיות.

### Jamaica

This product has been Type Approved by Jamaica: SMA – M3N-A3C108397

# Customer Information

## Paraguay



NR: 2022-03-I-0162

## Serbia



## Singapore

Complies with IMDA Standards

Dealer License Number:

DA 00461

## South Africa



## Taiwan



**CCAB22LP1030T3**

## Thailand

(1) เพื่อเป็นประโยชน์แก่ผู้บริโภคและผู้ประกอบการ มีมาตรฐานผลิตภัณฑ์และบริการที่ดี

(2) เพื่อคุ้มครองผู้บริโภคและผู้ประกอบการ ให้ได้รับบริการที่ดี มีมาตรฐานผลิตภัณฑ์และบริการที่ดี

# Customer Information

---

## United Arab Emirates (U.A.E.)

TRA REGISTERED No:

ER08930/22

DEALER No:

DA37380/15

## OPERATING SYSTEM

Device	Supplier	Type Designation
PDC	Ford	SG5PHX

# Customer Information

---

## Jamaica

This product has been Type Approved by  
Jamaica: SMA – SG5PHX

NR: 2023-06-I-0457

R-C-FDM-SG5PHX

## Paraguay



## South Korea



# Customer Information

## United Arab Emirates (U.A.E.)



## United States and Canada

FCC ID: KMH SG5PHX

IC: 1422A SG5PHX

***This device complies with Part 15 of the FCC Rules and with ISED Canada license-exempt RSSs. Operation is subject to the following two conditions:***

- 1. This device may not cause harmful interference, and***
- 2. This device must accept any interference received, including interference that may cause undesired operation.***

***Le présent appareil est conforme aux CNR d'ISDE Canada applicables aux appareils radio exempts de licence. L'exploitation est autorisée aux deux conditions suivantes:***

- 1. L'appareil ne doit pas produire de brouillage;***
- 2. L'appareil doit accepter tout brouillage radioélectrique subi, même si le brouillage est susceptible d'en compromettre le fonctionnement.***



# Customer Information

**Note:** *Changes or modifications not expressly approved by the party responsible for compliance could void the user's authority to operate the equipment.*

RF Radiation Exposure Statement: This equipment complies with FCC RF Radiation exposure limits set forth for an uncontrolled environment. This device and its antenna must not be co-located or operating in conjunction with any other antenna or transmitter. This equipment should be installed and operated with a normally maintained separation distance of at least 20cm between the radiator and your body.

## RADIO TRANSCEIVER MODULE

### Argentina



### Brazil



### Djibouti

AGREE PAR LE MCPT (REPUBLIQUE DE DJIBOUTI)  
Numéros d'agrément : 033/DDTIC/2020  
Date d'agrément : 07/06/2020

AGREE PAR LE MCPT (REPUBLIQUE DE DJIBOUTI)  
Numéros d'agrément : 034/DDTIC/2020  
Date d'agrément : 07/06/2020

### Ghana

NCA APPROVED: SRO-1M-7E4-108

NCA APPROVED: SRO-1M-7E4-114

# Customer Information

## Mauritania

AGREE PAR L'ANE MAURITANIE  
Numéro d'agrément: 0803/ARE/2020  
Date d'agrément: 03/06/2020

## Moldova



## Pakistan



## Morocco

AGREE PAR L'ANE MAURITANIE  
Numéro d'agrément : 0802/ARE/2020  
Date d'agrément : 03/06/2020

AGREE PAR L'ANE MAROC  
Numéro d'agrément : MR 24102 ANRT 2020  
Date d'agrément : 18/05/2020

## Serbia



1011 20

# Customer Information

## South Africa



## Ukraine

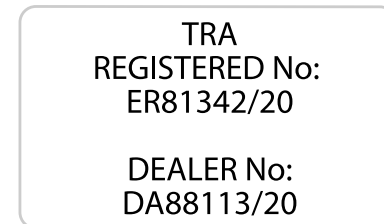

## Taiwan, China



## United Arab Emirates (U.A.E.)

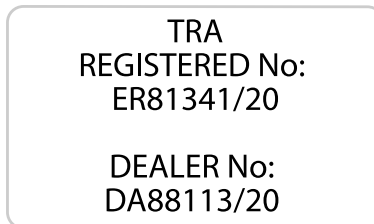

## United States and Canada

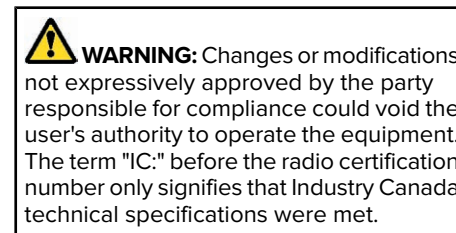

FCC ID: L2C0082R

FCC ID: L2C0083TR

IC: 342A-0083TR

# Customer Information

---

This device complies with Part 15 of the FCC Rules and with Innovation, Science and Economic Development Canada's licence-exempt RSS(s). Operation is subject to the following two conditions:

1. This device may not cause harmful interference, and
2. This device must accept any interference received, including interference that may cause undesired operation.

## Zambia



## TELEMATICS CONTROL UNIT

Device	Supplier	Type Designation
Telematics Control Unit	Ford	FNV3-B6

# Customer Information

---

## China

CMIIT ID: 2023CJ1792

## European Union EU



## Malaysia



HIDF16000009

## Mexico



# Customer Information

---

## Paraguay



NR: 2023-01-I-0047

## Serbia



## South Africa



## South Korea



R-C-FDM-FNV3B6ROW

## Taiwan



## United Arab Emirates (U.A.E.)

TRA REGISTERED No:

ER19896/23

DEALER No:

DA83047/19

## United Kingdom



# Customer Information

## United States and Canada



**WARNING:** Changes or modifications not expressly approved by the party responsible for compliance could void the user's authority to operate the equipment. The term "IC:" before the radio certification number only signifies that Industry Canada technical specifications were met.

FCC ID: KMH-14H317-NA1

IC: 1422A-14H317NA1

This device complies with Part 15 of the FCC Rules and with Innovation, Science and Economic Development Canada's licence-exempt RSS(s). Operation is subject to the following two conditions:

1. This device may not cause harmful interference, and
2. This device must accept any interference received, including interference that may cause undesired operation.

## TIRE PRESSURE MONITORING SYSTEM SENSORS

### Argentina



CNC ID: H-28035

### Brazil



# Customer Information

---

13309-22-08001

## European Union EU

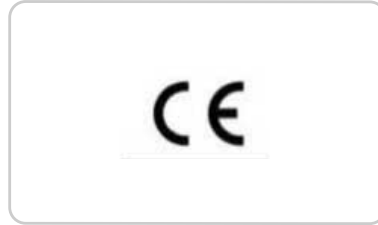

The RED 2014/53/EU (replacing R&TTE Directive 1999/5/EC on 13 June 2016) explicitly states that instructions for intentional radiators include reference to "(a) frequency band(s) in which the radio equipment operates; and (b) maximum radio-frequency power transmitted in the frequency band(s) in which the radio equipment operates," in addition to carrying over the general operational instruction and Declaration of Conformity inclusion requirements from the R&TTE Directive.

Hereby, Schrader Electronics Ltd. declares that the radio equipment type BG2BP4 is in compliance with Directive 2014/53/EU. The full text of the EU declaration of conformity is available at the following internet address:

[http://www.tpmseuroshop.com/documents/declaration\\_conformities](http://www.tpmseuroshop.com/documents/declaration_conformities)

f=433.92MHz

P<10mW (e.i.r.p)

Schrader Electronics Ltd. 11 Technology Park, Belfast Road, Antrim BT41 1QS, Northern Ireland United Kingdom.



# Customer Information

## Israel

1. מספר אישור התאמה מסעם משרד התקשורת: 51-86230
2. חל אישור לבצע מעולות במכשיר שיש בהן כדי לשנות את תכונותיו האלחוטיות של המכשיר, ובכלל זה שינוי תוכנו, החלפת אנטנה מקורית או הוספת אפשרות לתיבור לאנטנה חיצונית, בלא קבלת אישור משרד התקשורת, בשל החשש להפרעות אלחוטיות.

## Jamaica

This product has been Type Approved by Jamaica: SMA - BG2BP4.

## Malaysia



HIDF16000009

## Mexico

IFT: RLVSCBG22-2502

## Moldova



## Morocco

AGREE PAR L'ANRT MAROC

Numéro d'agrément:  
MR00034968ANRT2022

Date d'agrément: 21/12/2022

# Customer Information

---

## Paraguay



NR: 2022-05-I-0000331

## Serbia



## Singapore

Complies with IMDA Standards

DA 00461

## South Africa



# Customer Information

## South Korea



MSIP-R-C-SRD-BG2BP4

## Taiwan



CCAB22LP0730T0

## Thailand

- (1) เครื่องใช้โทรคมนาคมและอุปกรณ์อื่น ๆ มีความสอดคล้องตามข้อกำหนดของ กทท.
- (2) เครื่องใช้โทรคมนาคมและอุปกรณ์อื่น ๆ มีความสอดคล้องตามมาตรฐานความปลอดภัยต่อสุขภาพของมนุษย์จากการใช้ เครื่องใช้โทรคมนาคมที่คณะกรรมการกิจการโทรคมนาคมแห่งชาติประกาศ

## Ukraine



## Unites Arab Emirates (U.A.E.)

TRA REGISTERED No:

ER10488/22

DEALER No:

DA37380/15

## United Kingdom



# Customer Information

## United States and Canada

FCC ID: MRXBG2BP4

IC: 2546A-BG2BP4

This device complies with Part 15 of the FCC Rules and with Innovation, Science and Economic Development Canada's licence-exempt RSS(s). Operation is subject to the following two conditions:

1. This device may not cause harmful interference, and
2. This device must accept any interference received, including interference that may cause undesired operation.

 **WARNING:** Changes or modifications not expressly approved by the party responsible for compliance could void the user's authority to operate the equipment. The term "IC:" before the radio certification number only signifies that Industry Canada technical specifications were met.

## WIRELESS ACCESSORY CHARGING MODULE

Device	Supplier	Type Designation
Wireless Charger (WCM)	LG/BH EVS	WCFDM00N2A1 WCFDM00N2A3 WCFDM00N2A5

# Customer Information

---

## Argentina



## Democratic Republic of Congo

Agréé par l'ARPTC  
N° d'homologation : HER-0054/Juin/2021  
Date d'homologation : 02/06/2021

## Brazil



## European Union



# Customer Information

## Ghana

NCA APPROVED: 7ES-7M-XB1-RDR

Model: WCFDM00N2A3  
Sertifikat Nomor: 80111/SDPPI/2022  
PLG ID: 13493



## Israel

1. מספר אישור התאמה מטעם משרד התקשורת : 51-80014  
2. חל אישור לבצע פעולות במכשיר שיש בהן כדי לשנות את תכונותיו האלחוטיות של המכשיר, ובכלל זה שיווי תכנה, החלפת אנטנה מקורית או הוספת אפשרות לחיבור לאנטנה חיצונית, בלא קבלת אישור משרד התקשורת, בשל החשש להפרעת אלחוטיות

## Indonesia

Model: WCFDM00N2A1  
Sertifikat Nomor: 80110/SDPPI/2022  
PLG ID: 13493



Model: WCFDM00N2A5  
Sertifikat Nomor: 80112/SDPPI/2022  
PLG ID: 13493



1. מספר אישור התאמה מטעם משרד התקשורת : 51-80015  
2. חל אישור לבצע פעולות במכשיר שיש בהן כדי לשנות את תכונותיו האלחוטיות של המכשיר, ובכלל זה שיווי תכנה, החלפת אנטנה מקורית או הוספת אפשרות לחיבור לאנטנה חיצונית, בלא קבלת אישור משרד התקשורת, בשל החשש להפרעת אלחוטיות

# Customer Information

## Malaysia

HIDF16000009

## Mauritania



AGREE PAR L'ANE MAURITANIE  
Numéro d'agrément : 0935/ARE/2021  
Date d'agrément : 23/03/2021

## Jamaica

1. מספר אישור התאמה מסעם משרד התקשורת: 51-80013
2. חל אישור לבצע פעולות בממשיר שיש בידו לשנות את תכונותיו האלחוטיות של המכשיר, ובכלל זה שינוי תדונה, החלפת אנטנה מקורית או הוספת אנטנה חדשה לחיבור לאנטנה חיצונית, בלא קבלת אישור משרד התקשורת, בשל הסיכוי להפרעות אלחוטיות

This product has been Type Approved by Jamaica:  
SMA - WCFDM00N2A.

# Customer Information

## Moldova

AGREE PAR L'ANEMAURITANIE  
Numéro d'agrément : 0934/ARE/2021  
Date d'agrément : 23/03/2021



AGREE PAR L'ANRT MAROC  
Numéro d'agrément : MR 00027925ANRT 2021  
Date d'agrément : 25/03/2021

## Morocco

AGREE PAR L'ANEMAURITANIE  
Numéro d'agrément : 0933/ARE/2021  
Date d'agrément : 23/03/2021

AGREE PAR L'ANRT MAROC  
Numéro d'agrément : MR 00027924ANRT 2021  
Date d'agrément : 25/03/2021

AGREE PAR L'ANRT MAROC  
Numéro d'agrément : MR 00027923ANRT 2021  
Date d'agrément : 25/03/2021



# Customer Information

## Paraguay



NR: 2021-04-I-0202

NR: 2021-04-I-0203

NR: 2021-04-I-0204

## Russia



## Serbia



## Singapore

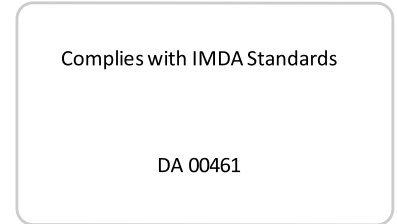

## Sierra Leone



## South Africa



# Customer Information

## South Korea



R-R-LGE-WCFDM00N2A1

## Taiwan



**CCAB21LP050AT3**



**CCAB21LP0500T1**



**CCAB21LP050BT5**

**品名 (Product name):** 無線充電座

**型號 (Type Designation):** WCFDM00N2A1, WCFDM00N2A3, WCFDM00N2A5 **產地 (Origin):** 馬來西亞

**額定電壓 (Input rating):** 12V

**製造日期 (Approval date):** 2021.04.21



R43208  
Rolls

**申請廠商名稱 (Approval name):** 福特六和汽車股份有限公司

**申請廠商地址 (Approval address):** 桃園市中壢區中華路一段705號

## Customer Information

---

**Ukraine**



**United Kingdom**



**United Arab Emirates (U.A.E.)**



# Customer Information

---

**TDR**

ER00421/21  
United Arab Emirates



**TDR**

ER00421/21  
United Arab Emirates



# Customer Information

---

## United States and Canada

FCC ID: BEJWCDFM00N2A

IC: 2703H-WCFDM00N2A

This equipment generates, uses, and can radiate radio frequency energy and may cause harmful interference to radio communications. There is no guarantee that interference will not occur in a particular installation. If this equipment does cause harmful interference to radio or television reception, please consult the dealer.

This product is not end-user serviceable.

RF Radiation Exposure Statement: This equipment complies with FCC RF Radiation exposure limits set forth for an uncontrolled environment. This device and its antenna must not be co-located or operating in conjunction with any other antenna or transmitter. This equipment should be installed and operated with a minimum distance of 20cm between the radiator and your body.

This device complies with Part 15 of the FCC Rules and with Innovation, Science and Economic Development Canada's licence-exempt RSS(s). Operation is subject to the following two conditions:

1. This device may not cause harmful interference, and
2. This device must accept any interference received, including interference that may cause undesired operation.

*Le présent appareil est conforme aux CNR d'Industrie Canada applicables aux appareils radio exempts de licence. L'exploitation est autorisée aux deux conditions suivantes:*

1. *L'appareil ne doit pas produire de brouillage;*
2. *L'appareil doit accepter tout brouillage radioélectrique subi, même si le brouillage est susceptible d'en compromettre le fonctionnement.*

# Customer Information

## Zambia



## PERCHLORATE

Certain components in your vehicle such as airbag modules, seatbelt pretensioners and remote control batteries may contain perchlorate material. Special handling may apply for service or vehicle end of life disposal.

For more information visit:  
[www.dtsc.ca.gov/hazardouswaste/perchlorate](http://www.dtsc.ca.gov/hazardouswaste/perchlorate).

## REPLACEMENT PARTS RECOMMENDATION

We have built your vehicle to the highest standards using quality parts. We recommend that you demand the use of genuine Ford and Motorcraft parts whenever your vehicle requires scheduled maintenance or repair. You can clearly identify genuine Ford and Motorcraft parts by looking for the Ford, FoMoCo or Motorcraft branding on the parts or their packaging.

## Scheduled Maintenance and Mechanical Repairs

One of the best ways for you to make sure that your vehicle provides years of service is to have it maintained in line with our recommendations using parts that conform to the specifications detailed in this Owner's Manual.

Genuine Ford and Motorcraft parts meet or exceed these specifications.

## Collision Repairs

We hope that you never experience a collision, but accidents happen sometimes.

Genuine Ford replacement collision parts meet our stringent requirements for fit, finish, structural integrity, corrosion protection and dent resistance. During vehicle development we validate that these parts deliver the intended level of protection as a whole system. A great way to know for sure you are getting this level of protection is to use genuine Ford replacement collision parts.

## Warranty on Replacement Parts

Genuine Ford and Motorcraft replacement parts are the only replacement parts that benefit from a Ford Warranty.

The Ford Warranty may not cover damage caused to your vehicle as a result of failed non-Ford parts.

For additional information, refer to the terms and conditions of the Ford Warranty.

# Customer Information

## MOBILE COMMUNICATIONS EQUIPMENT



**WARNING:** Driving while distracted can result in loss of vehicle control, crash and injury. We strongly recommend that you use extreme caution when using any device that may take your focus off the road. Your primary responsibility is the safe operation of your vehicle. We recommend against the use of any hand-held device while driving and encourage the use of voice-operated systems when possible. Make sure you are aware of all applicable local laws that may affect the use of electronic devices while driving.

Using mobile communications equipment is becoming increasingly important in the conduct of business and personal affairs. However, you must not compromise your own or others' safety when using such equipment. Mobile communications can enhance personal safety and security when appropriately used, particularly in emergency situations. Safety must be paramount when

using mobile communications equipment to avoid negating these benefits. Mobile communication equipment includes, but is not limited to, cellular phones, pagers, portable email devices, text messaging devices and portable two-way radios.

## FEDERAL HIGHWAY ADMINISTRATION REGULATION

Regulations such as those issued by the Federal Highway Administration or issued pursuant to the Occupational Safety and Health Act (OSHA), and state and local laws and regulations may require additional equipment for the way you intend to use your vehicle. It is the responsibility of the registered owner to determine the applicability of such laws and regulations to your intended use for the vehicle, and to arrange for the installation of required equipment. The dealer has information about the availability of equipment which can be ordered for your vehicle.

## EMISSION LAW



**WARNING:** Do not remove or alter the original equipment floor covering or insulation between it and the metal floor of the vehicle. The floor covering and insulation protect occupants of the vehicle from the engine and exhaust system heat and noise. On vehicles with no original equipment floor covering insulation, do not carry passengers in a manner that permits prolonged skin contact with the metal floor. Failure to follow these instructions may result in fire or personal injury.

U.S. federal laws and certain state laws prohibit removing or rendering inoperative emission control system components. Similar federal or provincial laws may apply in Canada. We do not approve of any vehicle modification without first determining applicable laws.

# Customer Information



Tampering with emissions control systems including related sensors or the Diesel Exhaust Fluid system can result in reduced engine power and the illumination of the service engine soon light.

## Tampering With a Noise Control System

Federal laws prohibit the following acts:

- Removal or rendering inoperative by any person other than for purposes of maintenance.
- Repair or replacement of any device or element of the design incorporated into a new vehicle for the purpose of noise control prior to its sale or delivery to the ultimate purchaser or while it is in use.
- The use of the vehicle after any person removes or renders inoperative any device or element of the design.

The U.S. Environmental Protection Agency may presume to constitute tampering as follows:

- Removal of hood blanket, fender apron absorbers, fender apron barriers, underbody noise shields or acoustically absorptive material.
- Tampering or rendering inoperative the engine speed governor, to allow engine speed to exceed manufacturer specifications.

If the engine does not start, runs rough, experiences a decrease in engine performance, experiences excess fuel consumption or produces excessive exhaust smoke, check for the following:

- A plugged or disconnected air inlet system hose.
- A plugged engine air filter element.
- Water in the fuel filter and water separator.
- A clogged fuel filter.
- Contaminated fuel.
- Air in the fuel system, due to loose connections.

- An open or pinched sensor hose.
- Incorrect engine oil level.
- Incorrect fuel for climatic conditions.
- Incorrect engine oil viscosity for climatic conditions.

**Note:** *Some vehicles have a lifetime fuel filter that is integrated with the fuel tank. Regular maintenance or replacement is not needed.*

**Note:** *If these checks do not help you correct the concern, have your vehicle checked as soon as possible.*

## Noise Emissions Warranty, Prohibited Tampering Acts and Maintenance

On January 1, 1978, Federal regulation became effective governing the noise emission on trucks over 10,000 lb (4,536 kg) Gross Vehicle Weight Rating (GVWR). The preceding statements concerning prohibited tampering acts and maintenance, and the noise warranty found in the Warranty Guide, are applicable to complete chassis cabs over 10,000 lb (4,536 kg) GVWR.



# Customer Information

---

## EXPORT UNIQUE OPTIONS

For your particular global region, your vehicle may be equipped with features and options that are different from the features and options that are described in this Owner's Manual. A market unique supplement may be supplied that complements this book. By referring to the market unique supplement, if provided, you can properly identify those features, recommendations and specifications that are unique to your vehicle. This Owner's Manual is written primarily for the U.S. and Canadian markets. Features or equipment listed as standard may be different on units built for export. **Refer to this Owner's Manual for all other required information and warnings.**

## WARRANTY INFORMATION

The following warranties may apply to your vehicle:

- New vehicle limited warranties.
- Emissions warranties, if applicable. (Note: Fully-electric vehicles are not eligible for emissions warranties.)
- Other warranties, if applicable.

Detailed warranty information specific to your vehicle can be found in the Warranty Guide at [www.owner.lincoln.com](http://www.owner.lincoln.com).

The following California Warranty Statement, required by California regulations, applies to vehicles certified to California emissions standards and registered in a state that requires California emissions warranty. If applicable, additional California Emissions Warranties can be found in the Warranty Guide at [www.owner.lincoln.com](http://www.owner.lincoln.com).

## CALIFORNIA EMISSION CONTROL WARRANTY STATEMENT

### YOUR WARRANTY RIGHTS AND OBLIGATIONS

The California Air Resources Board and Ford Motor Company are pleased to explain the emission control system warranty on your (year) vehicle. In California, new motor vehicles must be designated, built and equipped to meet the State's stringent anti-smog standards. Ford Motor Company must warrant the emission control system on your vehicle for the periods of time listed below provided there has been no abuse, neglect or improper maintenance of your vehicle.

Your emission control system may include parts such as the carburetor or fuel-injection system, the ignition system, catalytic converter and engine computer. Also included may be hoses, belts, connectors and other emission-related assemblies. Where a warrantable condition exists, Ford Motor Company will repair your vehicle at no cost to you including diagnosis, parts and labor.

# Customer Information

---

## **MANUFACTURER'S WARRANTY COVERAGE:**

(For 1990 and subsequent model passenger cars, light-duty trucks, and medium-duty vehicles.)

- For 3 years or 50,000 miles (whichever occurs first);

1) If your vehicle fails a Smog Check inspection, all necessary repairs and adjustments will be made by Ford Motor Company to ensure that your emission control system **PERFORMANCE WARRANTY**.

2) If any emission-related part on your vehicle is defective, the part will be repaired or replaced by Ford Motor Company. This is your short-term emission control system **DEFECTS WARRANTY**.

- For 7 years or 70,000 miles (whichever occurs first);

1) If an emission-related part listed in this warranty booklet specially noted with coverage for 7 years or 70,000 miles is defective, the part will be repaired or replaced by Ford Motor Company. This is your long-term emission control system **DEFECTS WARRANTY**.

## **OWNER'S WARRANTY RESPONSIBILITIES:**

- As the vehicle owner, you are responsible for the performance of the required maintenance listed in your owner's manual. Ford Motor Company recommends that you retain all receipts covering maintenance on your vehicle, but Ford Motor Company cannot deny warranty solely for the lack of receipts or for your failure to ensure the performance of all scheduled maintenance.

- You are responsible for presenting your vehicle to a Ford or Lincoln dealer as soon as a problem exists. The warranty repairs should be completed in a reasonable amount of time, not to exceed 30 days.

- As the vehicle owner, you should also be aware that Ford Motor Company may deny you warranty coverage if your vehicle or a part has failed due to abuse, neglect, improper maintenance or unapproved modifications.

If you have any questions regarding your warranty rights and responsibilities, you should contact Lincoln Concierge at 1-800-521-4140 or the California Air Resource Board at 9528 Telstar Avenue, El Monte, CA 91731.

## **New Vehicle Limited Warranty**

Your vehicle comes with a New Vehicle Limited Warranty. The express warranties of the New Vehicle Limited Warranty are in substitution for and exclude all other liabilities of any kind whether arising under statute, in tort, by implication of law or otherwise including, to the full extent as may be allowed by law, liability for any other representations respecting the vehicle, statutory warranties or implied warranties or conditions as to its merchantability or fitness.

# Customer Information

---

Download a free electronic copy or order one free printed copy of the most up-to-date Warranty Guide by visiting the Owner Manuals section of [owner.lincoln.com](http://owner.lincoln.com) (United States).

For Canada, visit [lincolncanada.com/warranty](http://lincolncanada.com/warranty).

For Limo/Livery/Hearse vehicles: View and download your Warranty Guide by visiting the Warranty Information section of the Fleet website, [fleet.ford.com/limo](http://fleet.ford.com/limo) (United States only).

# Appendices

---

## ELECTROMAGNETIC COMPATIBILITY



**WARNING:** Do not place objects or mount equipment on or near the airbag cover, on the side of the front or rear seatbacks, or in areas that may come into contact with a deploying airbag. Failure to follow these instructions may increase the risk of personal injury in the event of a crash.



**WARNING:** Keep antenna and power cables at least 4 in (10 cm) from any electronic modules and airbags.

**Note:** *We test and certify your vehicle to meet electromagnetic compatibility legislation. It is your responsibility to make sure that any equipment an authorized dealer installs on your vehicle complies with applicable local legislation and other requirements. Installation of some aftermarket electronic devices could degrade the performance of vehicle functions, which use radio frequency signals such as broadcast radio receiver, tire pressure monitoring system, push button start, **Bluetooth**® connectivity or satellite navigation.*

**Note:** *Any radio frequency transmitter equipment in your vehicle, such as, cellular telephones and amateur radio transmitters, must keep to the parameters in the following illustrations and table. We do not provide any other special provisions or conditions for installations or use.*

# Appendices

---

**Car**

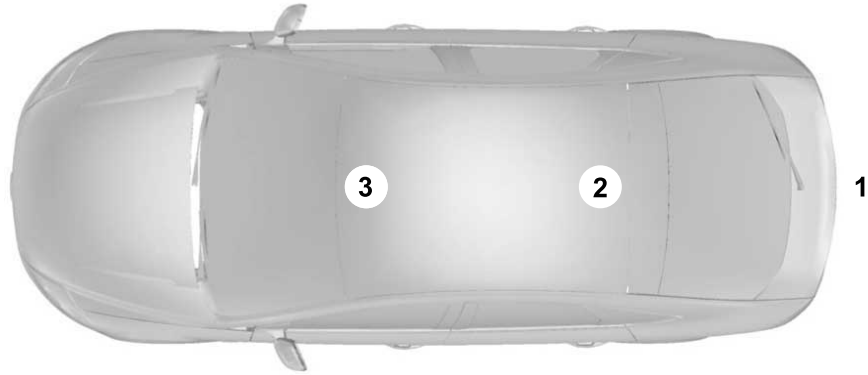

# Appendices

---

## Van

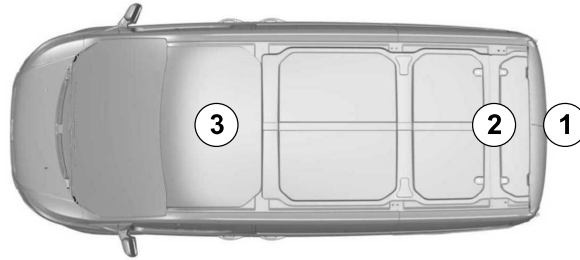

# Appendices

## Truck

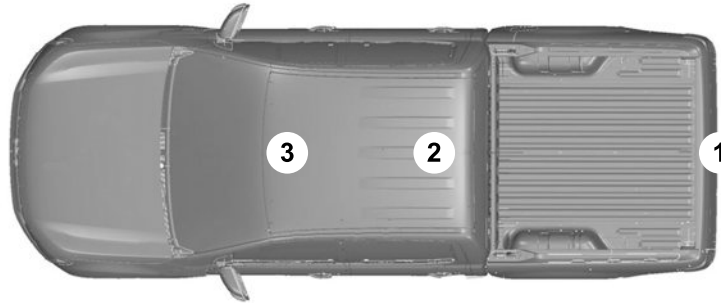

Frequency Band MHz	Maximum Output Power Watt (Peak RMS)	Antenna Positions
1-30	50	1
50-54	50	2, 3
68-88	50	2, 3

# Appendices

---

<b>Frequency Band MHz</b>	<b>Maximum Output Power Watt (Peak RMS)</b>	<b>Antenna Positions</b>
142-176	50	2, 3
380-512	50	2, 3
806-870	10	2, 3



# Index

<b>1</b>		
12V Battery.....	386	
12V Battery Precautions.....	386	
Battery Management System		
Limitations.....	387	
Changing the 12V Battery.....	388	
How Does the Battery Management System		
Work.....	387	
Recycling and Disposing of the 12V		
Battery.....	389	
Resetting the Battery Sensor.....	389	
What Is the Battery Management		
System.....	387	
12V Battery – Troubleshooting.....	389	
12V Battery – Information Messages.....	390	
12V Battery – Warning Lamps.....	389	
<b>3</b>		
360 Degree Camera.....	254	
360 Degree Camera Settings.....	257	
360 Degree Camera Guide Lines.....	256	
360 Degree Camera Precautions.....	254	
360 Degree Camera Settings.....	257	
Switching the 360 Degree Camera On and		
Off.....	257	
Switching the 360 Degree Camera		
View.....	257	
<b>9</b>		
911 Assist.....	69	
<b>A</b>		
A/C		
See: Climate Control.....	143	
About This Publication.....	19	
ABS		
See: Brakes.....	222	
Accessing the Passive Key Backup		
Position.....	190	
Accessing the Trip Computer.....	140	
Accessories.....	488	
Active Park Assist.....	259	
Active Park Assist – Troubleshooting.....	261	
Active Park Assist Precautions.....	259	
Active Park Assist –		
Troubleshooting.....	261	
Active Park Assist – Frequently Asked		
Questions.....	261	
Active Park Assist – Information		
Messages.....	261	
Adaptive Cruise Control.....	264	
Adaptive Cruise Control –		
Troubleshooting.....	281	
Lane Centering.....	273	
Lane Centering – Troubleshooting.....	276	
Predictive Speed Assist.....	278	
Predictive Speed Assist –		
Troubleshooting.....	281	
Adaptive Cruise Control Automatic		
Cancellation.....	268	
Adaptive Cruise Control Indicators.....	272	
Adaptive Cruise Control Limitations.....	265	
Adaptive Cruise Control		
Precautions.....	264	
Adaptive Cruise Control –		
Troubleshooting.....	281	
Adaptive Cruise Control – Information		
Messages.....	281	
Adaptive Front Lighting.....	119	
How Does Adaptive Front Lighting Work.....	119	
Switching Adaptive Front Lighting On and		
Off.....	121	
Adjusting the Exterior Mirrors.....	129	
Adjusting the Headlamps.....	391	
Adjusting the Instrument Panel Lighting		
Brightness.....	122	
Adjusting the Seatbelt Height.....	52	

# Index

Adjusting the Seatbelts During Pregnancy.....	51	Alexa Built-In.....	471	What are the Alarm Security Levels.....	99
Adjusting the Sound Settings.....	463	All-Wheel Drive.....	220	What Is Ask on Exit.....	99
Adjusting the Steering Wheel.....	103	All-Wheel Drive – Troubleshooting.....	221	Appendices.....	552
Adjusting the Volume.....	462	All-Wheel Drive Limitations.....	220	Applying the Electric Parking Brake.....	225
Aid Mode.....	299	All-Wheel Drive Precautions.....	220	Applying the Electric Parking Brake in an Emergency.....	225
How Does Aid Mode Work.....	299	All-Wheel Drive – Troubleshooting.....	221	Approach Detection	
What Is Aid Mode.....	299	All-Wheel Drive – Information		See: Switching Welcome Lighting On and Off.....	114
Airbag Precautions.....	61	Messages.....	221	Apps.....	469
Airbags.....	58	AM/FM Radio.....	463	Audio System.....	462
Front Passenger Sensing System.....	62	AM/FM Radio Limitations.....	463	AM/FM Radio.....	463
Air Conditioning		Selecting an AM/FM Radio Station.....	464	Digital Radio.....	464
See: Climate Control.....	143	Ambient Lighting.....	123	Satellite Radio.....	465
Air Conditioning System Capacity and Specification - 2.0L, Full Hybrid Electric Vehicle (FHEV).....	451	Adjusting Ambient Lighting.....	123	Audio System Precautions.....	462
Air Conditioning System Capacity and Specification - 2.0L, Gasoline.....	449	Switching Ambient Lighting On and Off.....	123	Auto Air Refresh.....	148
Air Filter		Anti-Lock Braking System.....	222	Auto Air Refresh Hints.....	151
See: Changing the Engine Air Filter.....	380	Anti-Lock Braking System Limitations.....	222	Auto Air Refresh Indicators.....	150
Alert and Aid Mode.....	299	Anti-Theft Alarm System.....	98	Automatically Refreshing the Interior Air.....	151
How Does Alert and Aid Mode Work.....	300	Arming the Anti-Theft Alarm System.....	99	Checking the Exterior Air Quality.....	150
What Is Alert and Aid Mode.....	299	Disarming the Anti-Theft Alarm System.....	99	Checking the Interior Air Quality.....	148
Alert Mode.....	298	How Does the Anti-Theft Alarm System Work.....	98	How Does Auto Air Refresh Work.....	148
Adjusting the Steering Wheel Vibration Intensity.....	299	What Are the Inclination Sensors.....	98	Manually Refreshing the Interior Air.....	150
How Does Alert Mode Work.....	299	What Are the Interior Sensors.....	98	What Is Auto Air Refresh.....	148
What Is Alert Mode.....	298	What Is the Anti-Theft Alarm System.....	98	Auto-Dimming Interior Mirror.....	128
		What Is the Perimeter Alarm.....	98	Auto-Dimming Interior Mirror Limitations.....	128
		Anti-Theft Alarm System Settings.....	99		
		Setting the Alarm Security Level.....	99		
		Switching Ask on Exit On and Off.....	99		

# Index

What Is the Auto-Dimming Interior Mirror.....	128	Automatic High Beam Control.....	115	Automatic Transmission.....	214
Auto Hold.....	239	Automatic High Beam Control Indicators.....	117	Automatic Return to Park (P).....	218
Auto Hold Indicators.....	240	Automatic High Beam Control Limitations.....	117	Automatic Transmission Positions.....	214
Autolamps.....	112	Automatic High Beam Control Precautions.....	116	Automatic Transmission – Troubleshooting.....	219
Autolamp Settings.....	113	Automatic High Beam Control Requirements.....	116	Grade Assist.....	218
What Are Autolamps.....	112	How Does Automatic High Beam Control Work.....	115	Temporary Neutral Mode.....	217
Autolock.....	81	Overriding Automatic High Beam Control.....	117	Automatic Transmission Fluid Capacity and Specification.....	453
Autolock Requirements.....	81	Switching Automatic High Beam Control On and Off.....	117	Automatic Transmission Position Indicators.....	215
What Is Autolock.....	81	Automatic High Beam Control – Troubleshooting.....	118	Automatic Transmission Positions.....	214
Automatically Releasing the Electric Parking Brake.....	226	Automatic High Beam Control – Information Messages.....	118	Drive (D).....	215
Automatic Crash Shutoff.....	355	Automatic Locking Mode.....	51	Low (L).....	215
Automatic Crash Shutoff Precautions.....	355	Disengaging Automatic Locking Mode.....	51	Neutral (N).....	215
Re-Enabling Your Vehicle.....	355	Engaging Automatic Locking Mode.....	51	Park (P).....	214
What Is Automatic Crash Shutoff.....	355	What Is Automatic Locking Mode.....	51	Reverse (R).....	214
Automatic Emergency Braking.....	319	Automatic Return to Park (P).....	218	Automatic Transmission Precautions.....	214
Switching Automatic Emergency Braking On and Off.....	319	Automatic Return to Park (P) Limitations.....	218	Automatic Transmission – Troubleshooting.....	219
What Is Automatic Emergency Braking.....	319	How Does Automatic Return to Park (P) Work.....	218	Automatic Transmission – Information Messages.....	219
Automatic Engine Stop.....	189	Automatic Transmission Audible Warnings.....	216	Auto Mode.....	145
How Does Automatic Engine Stop Work.....	189			Switching Auto Mode On and Off.....	145
Overriding Automatic Engine Stop.....	189			Auto-Start-Stop.....	197
Switching Automatic Engine Stop On and Off.....	189			Auto-Start-Stop – Troubleshooting.....	198
What Is Automatic Engine Stop.....	189			Auto-Start-Stop Indicators.....	197
				Auto-Start-Stop Precautions.....	197

# Index

Auto-Start-Stop – Troubleshooting.....	198	Blind Spot Information System Indicators.....	309	Brake Over Accelerator.....	222
Auto-Start-Stop – Frequently Asked Questions.....	199	Blind Spot Information System Limitations.....	307	Brake Precautions.....	222
Auto-Start-Stop – Information Messages.....	198	Blind Spot Information System Precautions.....	307	Brakes.....	222
Autounlock.....	81	Blind Spot Information System Requirements.....	308	Anti-Lock Braking System.....	222
Autounlock Requirements.....	81	Blind Spot Information System – Troubleshooting.....	309	Brakes – Troubleshooting.....	223
Switching Autounlock On and Off.....	81	Blind Spot Information System – Information Messages.....	309	Brakes – Troubleshooting.....	223
What Is Autounlock.....	81	BlueCruise Alerts.....	286	Brakes – Frequently Asked Questions.....	224
Autowipers.....	105	BlueCruise Automatic Cancellation.....	287	Brakes – Information Messages.....	224
Adjusting the Sensitivity of the Rain Sensor.....	106	BlueCruise Indicators.....	287	Brakes – Warning Lamps.....	223
Autowipers Settings.....	106	BlueCruise Limitations.....	285	Breaking-In.....	344
What Are Autowipers.....	105	BlueCruise Precautions.....	283		
AWD		BlueCruise Requirements.....	284	<b>C</b>	
See: All-Wheel Drive.....	220	BlueCruise Settings.....	285	Calculating Payload.....	330
<b>B</b>		BlueCruise – Troubleshooting.....	291	Calculating the Load Limit.....	330
Blind Spot Assist.....	301	BlueCruise – Information Messages.....	291	Canceling the Set Speed.....	271
Blind Spot Assist Indicators.....	302	Bluetooth®.....	481	Capacities and Specifications.....	436
Blind Spot Assist Limitations.....	301	Body Styling Kit Precautions.....	402	Catalytic Converter.....	211
How Does Blind Spot Assist Work.....	301	Body Styling Kits.....	402	Catalytic Converter – Troubleshooting.....	212
What Is Blind Spot Assist.....	301	Bonnet Lock		Catalytic Converter Precautions.....	211
Blind Spot Information System.....	307	See: Opening and Closing the Hood.....	373	Catalytic Converter – Troubleshooting.....	212
Blind Spot Information System – Troubleshooting.....	309	Booster Seats.....	44	Catalytic Converter – Warning Lamps.....	212
		Brake Fluid Specification.....	223	Center Console.....	183
				Opening the Center Console.....	183
				Center Display.....	468
				Center Display Overview.....	468
				Changing a Flat Tire.....	428

# Index

Changing a Road Wheel.....	428	Child Safety Locks – Troubleshooting.....	47	Cleaning the Instrument Panel.....	398
Changing the Engine Air Filter.....	380	Installing Child Restraints.....	39	Cleaning Vinyl.....	399
Changing the Fuel Filter.....	385	Child Safety Locks.....	46	Climate Control.....	143
Changing the Language.....	139	Child Safety Locks – Troubleshooting.....	47	Auto Mode.....	145
Changing the Measurement Unit.....	139	Child Safety Locks – Information		Climate Control Hints.....	146
Changing the Remote Control Battery.....	73	Messages.....	47	Closing the Liftgate.....	93
Changing the Temperature Unit.....	139	Child Safety Precautions.....	34	Closing the Hands-Free Liftgate.....	94
Changing the Tire Pressure Unit.....	139	Cleaning Products.....	395	Closing the Liftgate From Inside Your	
Charging a Device.....	176	Cleaning the Exterior.....	396	Vehicle.....	93
Charging a Wireless Device.....	181	Cleaning Camera Lenses and Sensors.....	398	Closing the Liftgate From Outside Your	
Checking the Brake Fluid.....	222	Cleaning Chrome, Aluminium or Stainless		Vehicle.....	94
Checking the Seatbelts.....	54	Steel.....	396	Closing the Liftgate Using the Remote	
Checking the Tire Pressures.....	416	Cleaning Headlamps and Rear Lamps.....	396	Control.....	94
Checking the Wiper Blades.....	107	Cleaning Stripes or Graphics.....	397	Cold Weather Precautions.....	344
Children and Airbags.....	62	Cleaning the Engine Compartment.....	397	Connected Navigation.....	484
Child Restraint Anchor Points.....	35	Cleaning the Exterior Precautions.....	396	Connected Vehicle.....	456
Locating the Child Restraint Lower Anchor		Cleaning the Underbody.....	398	Connected Vehicle – Troubleshooting.....	457
Points.....	36	Cleaning Wheels.....	397	Connecting the Vehicle to a Mobile	
Locating the Child Restraint Top Tether		Cleaning Windows and Wiper Blades.....	396	Network.....	456
Anchor Points.....	36	Cleaning the Interior.....	398	Connected Vehicle Data.....	27
What Are the Child Restraint Anchor		Cleaning Carpets and Floor Mats.....	400	Connected Vehicle Limitations.....	456
Points.....	35	Cleaning Displays and Screens.....	398	Connected Vehicle Requirements.....	456
Child Restraints.....	36	Cleaning Fabric.....	399	Connected Vehicle Settings.....	457
Child Restraint Position Information.....	36	Cleaning Leather.....	399	Connected Vehicle –	
Child Restraints Recommendation.....	38	Cleaning Moonroof Tracks.....	400	Troubleshooting.....	457
Child Safety.....	34	Cleaning Plastic.....	398	Connected Vehicle – Frequently Asked	
Child Restraint Anchor Points.....	35	Cleaning Seatbelts.....	400	Questions.....	457
Child Restraints.....	36	Cleaning Storage Compartments.....	400	Connecting a Bluetooth® Device.....	481

# Index

Connecting a Trailer.....	336	Fail-Safe Cooling.....	357	Customer Information.....	498
Connecting a Trailer Precautions.....	336	Jump Starting the Vehicle.....	351	Radio Frequency Certification Labels.....	502
Connecting the Vehicle to a Mobile Network.....	456	Post-Crash Alert System.....	354	Customizing the Instrument Panel Display.....	470
Connecting Lincoln Way to the Modem.....	456	Crash Sensors and Airbag Indicator.....	66	<b>D</b>	
Enabling and Disabling the Modem.....	456	Creating a Personal Profile.....	482	Data Privacy.....	24
What Is the Modem.....	456	Cross Traffic Alert.....	310	Department of Transportation Uniform Tire Quality Grades.....	405
Connecting the Vehicle to a Wi-Fi Network.....	456	Cross Traffic Alert – Troubleshooting.....	312	Digital Radio.....	464
Connecting Your Phone.....	474	Cross Traffic Alert Indicators.....	311	Digital Radio Indicators.....	465
Contacting Us.....	17	Cross Traffic Alert Limitations.....	311	Digital Radio Limitations.....	464
Controls.....	469	Cross Traffic Alert Precautions.....	310	How Does Digital Radio Work.....	464
Coolant.....	381	Cross Traffic Alert – Troubleshooting.....	312	Switching Digital Radio Reception On and Off.....	465
Adding Coolant.....	382	Cross Traffic Alert – Information Messages.....	312	What Is Digital Radio.....	464
Changing the Coolant.....	383	Cross Traffic Braking.....	234	Digital Scent.....	151
Checking the Coolant Level.....	381	Cross Traffic Braking – Troubleshooting.....	236	Dinghy Tow See: Recreationally Towing Your Vehicle - Full Hybrid Electric Vehicle (FHEV).....	359
Coolant – Information Messages.....	385	Cross Traffic Braking Indicators.....	235	See: Recreationally Towing Your Vehicle - Gasoline.....	359
Coolant – Warning Lamps.....	384	Cross Traffic Braking Precautions.....	234	Directing the Flow of Air.....	144
Managing the Coolant Temperature.....	384	Cross Traffic Braking – Troubleshooting.....	236	Disposing of Airbags.....	67
Cooled Seats.....	159	Cross Traffic Braking – Frequently Asked Questions.....	237	Distance Alert.....	318
Switching the Cooled Seats On and Off.....	159	Cross Traffic Braking – Information Messages.....	236	Adjusting the Sensitivity of Distance Alert.....	318
Cooling System Capacity and Specification - 2.0L, Full Hybrid Electric Vehicle (FHEV).....	447	Cup Holders.....	182		
Cooling System Capacity and Specification - 2.0L, Gasoline.....	446	Cup Holder Precautions.....	182		
Crash and Breakdown Information.....	348	Locating the Cup Holders.....	182		
Automatic Crash Shutoff.....	355				

# Index

What Is Distance Alert.....	318
Distance Indication.....	316
Distance Indication Indicator.....	318
Switching Distance Indication On and Off.....	318
What Is Distance Indication.....	316
Doors and Locks Audible Warnings.....	82
Doors and Locks.....	80
Autolock.....	81
Autounlock.....	81
Doors and Locks – Troubleshooting.....	82
Mislock.....	81
Operating the Doors From Inside Your Vehicle.....	80
Operating the Doors From Outside Your Vehicle.....	80
Doors and Locks – Troubleshooting.....	82
Doors and Locks – Information Messages.....	82
Doors and Locks – Warning Lamps.....	82
Drive Belt Routing Overview.....	386
Drive Mode Control.....	293
Drive Mode Control – Troubleshooting.....	294
Drive Modes.....	293
Drive Mode Control – Troubleshooting.....	294
Drive Mode Control – Frequently Asked Questions.....	296

Drive Mode Control – Information Messages.....	295
Drive Mode Control – Warning Lamps.....	294
Drive Modes.....	293
Conserve.....	293
Deep Conditions.....	293
Excite.....	294
Normal.....	294
Slippery.....	294
Driver Alert.....	325
Driver Alert – Troubleshooting.....	327
Driver Alert Indicators.....	326
Driver Alert Limitations.....	326
Driver Alert Precautions.....	326
Driver Alert – Troubleshooting.....	327
Driver Alert – Information Messages.....	327
Driving Economically.....	344
Driving Hints.....	344
Driving in Special Conditions.....	344
Driving in Special Conditions.....	344
Driving In Sand.....	346
Driving on Hilly or Sloping Terrain.....	345
Driving Through Mud and Water.....	344
Driving Through Shallow Water.....	346
Drowsiness Monitor See: Driver Alert.....	325

## E

Easy Entry and Exit.....	89
Electric Parking Brake Audible Warning.....	226
Electric Parking Brake.....	225
Electric Parking Brake – Troubleshooting.....	226
Electric Parking Brake – Troubleshooting.....	226
Electric Parking Brake – Information Messages.....	228
Electric Parking Brake – Warning Lamps.....	226
Electric Power Steering.....	245
Electric Power Steering Precautions.....	245
How Does Electric Power Steering Work.....	245
Electromagnetic Compatibility.....	552
Emergency Call Limitations.....	70
Emergency Call Requirements.....	69
Emergency Call System Data.....	28
Emergency Towing - Full Hybrid Electric Vehicle (FHEV).....	360
Emergency Towing - Gasoline.....	360
Emission Law.....	547
Enabling or Disabling Personal Profiles.....	482

# Index

Enabling Remote Start.....	141	Evasive Steering Assist.....	319	Headlamps.....	111
Engine Air Filter.....	380	Evasive Steering Assist Limitations.....	319	Headlamps – Troubleshooting.....	112
Engine Block Heater.....	187	Switching Evasive Steering Assist On and Off.....	319	Exterior Mirrors.....	129
Engine Block Heater Precautions.....	187	What Is Evasive Steering Assist.....	319	Exterior Overview.....	32
How Does the Engine Block Heater Work.....	188	Event Data.....	26	<b>F</b>	
Using the Engine Block Heater.....	188	Exiting a Parking Space.....	260	Fail-Safe Cooling.....	357
Engine Coolant Temperature Gauge.....	134	Expanse Display		Driving When Fail-Safe Mode Is Activated.....	357
Engine Oil Capacity and Specification - 2.0L, Full Hybrid Electric Vehicle (FHEV).....	443	See: Customizing the Instrument Panel Display.....	470	Fail-Safe Cooling Indicators.....	358
Engine Oil Capacity and Specification - 2.0L, Gasoline.....	441	Export Unique Options.....	549	How Does Fail-Safe Cooling Work.....	357
Engine Oil.....	379	Extending the Remote Start Duration.....	142	What Is Fail-Safe Cooling.....	357
Adding Engine Oil.....	379	Exterior Bulbs.....	393	Fastening and Unfastening the Seatbelts.....	49
Checking the Engine Oil Level.....	379	Exterior Bulb Specification Chart.....	393	Federal Highway Administration Regulation.....	547
Engine Oil Capacity and Specification.....	380	Exterior Lamps.....	113	Flat Tire	
Engine Oil Dipstick Overview.....	379	Exterior Lamps On Audible Warning.....	114	See: Changing a Flat Tire.....	428
Intelligent Oil Life Monitor.....	380	Switching the Daytime Running Lamps On and Off.....	113	Flat Tow	
Resetting the Intelligent Oil Life Monitor.....	380	Switching Welcome Lighting On and Off.....	114	See: Recreationally Towing Your Vehicle - Full Hybrid Electric Vehicle (FHEV).....	359
Engine Specifications - 2.0L, Full Hybrid Electric Vehicle (FHEV).....	437	Using the Turn Signal Lamps.....	113	See: Recreationally Towing Your Vehicle - Gasoline.....	359
Engine Specifications - 2.0L, Gasoline.....	436	Exterior Lighting Control.....	111	Floor Mats.....	347
Entering a Parking Space.....	260	Exterior Lighting.....	111	Folding the Exterior Mirrors.....	129
Environment.....	29	Adaptive Front Lighting.....	119		
		Autolamps.....	112		
		Automatic High Beam Control.....	115		
		Automatic High Beam Control – Troubleshooting.....	118		
		Exterior Lamps.....	113		



# Index

Four Wheels Down Tow		
See: Recreationally Towing Your Vehicle - Full Hybrid Electric Vehicle (FHEV).....	359	
See: Recreationally Towing Your Vehicle - Gasoline.....	359	
Front Parking Aid.....	250	
Front Parking Aid Audible Warnings.....	251	
Front Parking Aid Limitations.....	250	
Locating the Front Parking Aid Sensors.....	250	
What is the Front Parking Aid.....	250	
Front Passenger Sensing System.....	62	
Front Passenger Sensing System Indicators.....	65	
Front Passenger Sensing System Precautions.....	64	
How Does the Front Passenger Sensing System Work.....	62	
What Is the Front Passenger Sensing System.....	62	
Front Seat Precautions.....	154	
Front Seats.....	154	
Cooled Seats.....	159	
Heated Seats.....	159	
Massage Seats.....	158	
Power Seats.....	155	
Fuel and Refueling.....	200	
Fuel and Refueling – Troubleshooting.....	208	
Fuel Quality.....	201	
Refueling.....	203	
Running Out of Fuel.....	202	
Fuel and Refueling Precautions.....	200	
Fuel and Refueling – Troubleshooting.....	208	
Fuel and Refueling – Information Messages.....	209	
Fuel and Refueling – Warning Lamps.....	208	
Fuel Gauge.....	134	
Fuel Gauge Limitations.....	134	
Locating the Fuel Filler Door.....	134	
What Is Distance to Empty.....	134	
What Is the Fuel Gauge.....	134	
What Is the Low Fuel Reminder.....	134	
Fuel Quality.....	201	
Selecting the Correct Fuel.....	201	
Fuel Tank Capacity.....	208	
Fuse Precautions.....	361	
Fuses.....	361	
Fuses – Troubleshooting.....	372	
Interior Fuse Box.....	367	
Under Hood Fuse Box.....	361	
Fuses – Troubleshooting.....	372	
Fuses – Frequently Asked Questions.....	372	
<b>G</b>		
Garage Door Opener.....	170	
Garage Door Opener Introduction.....	170	
Garage Door Opener Precautions and Frequencies.....	170	
General Maintenance Information.....	493	
Glasses Holder.....	184	
Locating the Glasses Holder.....	184	
Global Opening and Closing.....	125	
Switching Global Closing On and Off.....	125	
Switching Global Opening On and Off.....	125	
Using Global Closing.....	125	
Using Global Opening.....	125	
What Is Global Opening and Closing.....	125	
Glossary of Tire Terminology.....	411	
Glove Compartment.....	183	
Opening the Glove Compartment.....	183	
Google Assistant.....	472	
Grade Assist.....	218	
How Does Grade Assist Work.....	218	
<b>H</b>		
Headlamp Adjusting		
See: Adjusting the Headlamps.....	391	
Headlamps.....	111	
Headlamp Indicators.....	111	
Switching Headlamp Exit Delay On and Off.....	111	
Using the High Beam Headlamps.....	111	



# Index

Installing and Removing the Luggage Compartment Cargo Net.....	333
Installing and Removing the Luggage Compartment Cover.....	334
Installing Child Restraints.....	39
Combining the Seatbelt and Lower Anchors for Attaching Child Restraints.....	42
Installing a Child Restraint in a Center Seat.....	42
Using Lower Anchors and Tethers for Children.....	41
Using Seatbelts.....	39
Using Tether Straps.....	43
Instrument Cluster Indicators.....	137
Instrument Cluster.....	133
Fuel Gauge.....	134
Instrument Cluster Overview.....	133
Instrument Cluster Warning Lamps.....	135
Interior Air Quality.....	148
Auto Air Refresh.....	148
Interior Air Quality – Troubleshooting.....	153
Interior Air Quality – Troubleshooting.....	153
Interior Air Quality – Information Messages.....	153
Interior Bulbs.....	394
Interior Bulb Specification Chart.....	394

Interior Fuse Box.....	367
Accessing the Interior Fuse Box.....	367
Identifying the Fuses in the Interior Fuse Box.....	368
Locating the Interior Fuse Box.....	367
Interior Lamp Function.....	122
Switching the Interior Lamp Function On and Off.....	122
What Is the Interior Lamp Function.....	122
Interior Lighting.....	122
Ambient Lighting.....	123
Interior Lamp Function.....	122
Interior Lighting – Troubleshooting.....	123
Interior Lighting – Troubleshooting.....	123
Interior Lighting – Frequently Asked Questions.....	123
Interior Mirror.....	128
Auto-Dimming Interior Mirror.....	128
Interior Mirror Precautions.....	128
Interior Overview.....	30
Introduction.....	19
<b>J</b>	
Jump Starting the Vehicle.....	351
Jump Starting Precautions.....	351
Jump Starting the Vehicle.....	352
Preparing the Vehicle.....	351

## K

Keyless Entry.....	83
Keyless Entry – Troubleshooting.....	84
Keyless Entry Keypad.....	85
Keyless Entry Keypad – Troubleshooting.....	88
Keyless Entry Keypad Limitations.....	85
Keyless Entry Keypad Master Access Code.....	85
Keyless Entry Keypad Personal Access Codes.....	86
Keyless Entry Keypad – Troubleshooting.....	88
Keyless Entry Keypad – Frequently Asked Questions.....	88
Keyless Entry Limitations.....	83
Keyless Entry Settings.....	83
Keyless Entry – Troubleshooting.....	84
Keyless Entry – Frequently Asked Questions.....	84
Keys and Remote Controls Audible Warnings.....	75
Keys and Remote Controls.....	71
Keys and Remote Controls – Troubleshooting.....	75

# Index

Keys and Remote Controls – Troubleshooting.....	75	Lane Change Assist – Troubleshooting.....	289	Liftgate – Troubleshooting.....	96
Keys and Remote Controls – Information Messages.....	75	Lane Change Assist – Information Messages.....	289	Liftgate – Frequently Asked Questions.....	97
<b>L</b>		Lane Keeping System Indicators.....	300	Liftgate – Information Messages.....	96
Lane Centering.....	273	Lane Keeping System.....	297	Liftgate – Warning Lamps.....	96
How Does Lane Centering Work.....	273	Aid Mode.....	299	Lincoln BlueCruise.....	283
Lane Centering Alerts.....	275	Alert and Aid Mode.....	299	BlueCruise – Troubleshooting.....	291
Lane Centering Automatic Cancellation.....	275	Alert Mode.....	298	In-Lane Repositioning.....	290
Lane Centering Indicators.....	276	Blind Spot Assist.....	301	Lane Change Assist.....	288
Lane Centering Limitations.....	274	Lane Keeping System – Troubleshooting.....	304	Lane Change Assist – Troubleshooting.....	289
Lane Centering Manual Cancellation.....	276	Lane Keeping System Limitations.....	298	Lincoln Protect.....	490
Lane Centering Precautions.....	273	Lane Keeping System Precautions.....	297	Linking or Unlinking a Personal Profile to a Device.....	483
Lane Centering Requirements.....	273	Lane Keeping System – Troubleshooting.....	304	Linking or Unlinking a Personal Profile to a Remote Control.....	482
Switching Lane Centering On and Off.....	275	Lane Keeping System – Frequently Asked Questions.....	305	Load Carrying.....	328
Lane Centering – Troubleshooting.....	276	Lane Keeping System – Information Messages.....	304	Roof Rack.....	332
Lane Centering – Information Messages.....	276	Launching or Retrieving a Boat or Personal Watercraft.....	340	Load Carrying Precautions.....	328
Lane Change Assist.....	288	Liftgate.....	90	Loading Your Trailer.....	339
How Does Lane Change Assist Work.....	288	Closing the Liftgate.....	93	Locating the 360 Degree Cameras.....	255
Lane Change Assist Cancellation.....	289	Liftgate – Troubleshooting.....	96	Locating the Blind Spot Information System Sensors.....	308
Lane Change Assist Limitations.....	289	Opening the Liftgate.....	90	Locating the Brake Fluid Reservoir.....	222
Switching Lane Change Assist On and Off.....	289	Liftgate Obstacle Detection.....	96	Locating the Cross Traffic Alert Sensors.....	311
		Liftgate Precautions.....	90	Locating the Fuel Filler Funnel.....	201
				Locating the Keyless Entry Keypad.....	85
				Locating the Memory Function Buttons.....	168

# Index

Locating the Power Outlets.....	177
Locating the Pre-Collision Assist Sensors.....	316
Locating the Safety Compliance Certification Labels.....	329
Locating the Tire label.....	405
Locating the USB Ports.....	175
Locating the Wireless Accessory Charger.....	180
Locating Your Vehicle.....	72
Locking the Rear Window Controls.....	126
Luggage Compartment.....	333
Luggage Compartment Precautions.....	333

## M

Maintenance.....	373
12V Battery.....	386
12V Battery – Troubleshooting.....	389
Coolant.....	381
Engine Air Filter.....	380
Engine Oil.....	379
Exterior Bulbs.....	393
Interior Bulbs.....	394
Maintenance Precautions.....	373
Making and Receiving a Phone Call.....	476
Manually Releasing the Electric Parking Brake.....	226

Manual Seats.....	161
Adjusting the Head Restraint.....	161
Adjusting the Seat Backrest.....	162
Folding the Seat Backrest.....	162
Head Restraint Components.....	161
Installing the Head Restraint.....	161
Moving the Seat Backward and Forward.....	162
Removing the Head Restraint.....	161
Unfolding the Seat Backrest.....	163
Massage Seats.....	158
Adjusting the Massage Seat Settings.....	158
Massage Seat Limitations.....	158
Memory Function.....	168
Memory Function Precautions.....	168
Mislock.....	81
Mislock Limitations.....	81
Switching Mislock On and Off.....	81
What Is Mislock.....	81
Mobile Communications Equipment.....	547
Mobile Device Data.....	27
Moonroof Bounce-Back.....	132
Overriding Moonroof Bounce-Back.....	132
What Is Moonroof Bounce-Back.....	132
Moonroof.....	131
Moonroof Bounce-Back.....	132
Motorcraft Parts - 2.0L, Full Hybrid Electric Vehicle (FHEV).....	440

Motorcraft Parts - 2.0L, Gasoline.....	439
--	-----

## N

Navigation.....	484
Neutral Towing See: Recreationally Towing Your Vehicle - Full Hybrid Electric Vehicle (FHEV).....	359
See: Recreationally Towing Your Vehicle - Gasoline.....	359
Neutral Tow See: Recreationally Towing Your Vehicle - Full Hybrid Electric Vehicle (FHEV).....	359
See: Recreationally Towing Your Vehicle - Gasoline.....	359

## O

Opening and Closing the Hood.....	373
Opening and Closing the Moonroof.....	131
Opening and Closing the Sunshade.....	131
Opening and Closing the Windows.....	124
Opening the Liftgate.....	90
Opening the Hands-Free Liftgate.....	91
Opening the Liftgate From Inside Your Vehicle.....	90
Opening the Liftgate From Outside Your Vehicle.....	90

# Index

Opening the Liftgate Using the Remote Control.....	91
Operating the Doors From Inside Your Vehicle.....	80
Opening the Doors From Inside Your Vehicle.....	80
Unlocking and Locking the Doors Using the Central Locking.....	80
Operating the Doors From Outside Your Vehicle.....	80
Unlocking and Locking the Doors Using the Key Blade.....	80
Unlocking and Locking the Doors Using the Remote Control.....	80
Ordering a Canadian French Owner's Manual.....	500
OTA	
See: Software Update Settings.....	485
See: Vehicle Software Updates.....	485
Overriding Cross Traffic Braking.....	235
Overriding Reverse Brake Assist.....	231
Overriding the Set Speed.....	272
Over the air	
See: Software Update Settings.....	485
Over-the-air	
See: Software Update Settings.....	485
See: Vehicle Software Updates.....	485
See: Vehicle Software Updates.....	485

## P

Panoramic Display	
See: Customizing the Instrument Panel Display.....	470
Parking Aid Indicators.....	252
Parking Aid Precautions.....	248
Parking Aids.....	248
Front Parking Aid.....	250
Parking Aids – Troubleshooting.....	252
Rear Parking Aid.....	249
Side Parking Aid.....	251
Parking Aids – Troubleshooting.....	252
Parking Aids – Information Messages.....	252
Passive Anti-Theft System.....	98
How Does the Passive Anti-Theft System Work.....	98
What Is the Passive Anti-Theft System.....	98
Pedestrian Alert System.....	68
Perchlorate.....	546
Performing a System Reset.....	487
Personalized Settings.....	139
Personal Profiles.....	482
Personal Safety System Components.....	57
Personal Safety System™.....	57
Phone as a Key Limitations.....	76
Phone as a Key.....	76
Phone as a Key – Troubleshooting.....	78

Phone as a Key – Troubleshooting.....	78
Phone as a Key – Frequently Asked Questions.....	78
Phone Menu.....	474
Phone.....	474
Phone Precautions.....	474
Playing Media Using Bluetooth®.....	481
Playing Media Using the USB Port.....	175
Playing or Pausing the Audio	
Source.....	462
Post-Collision Braking.....	355
Post-Crash Alert System.....	354
How Does the Post-Crash Alert System Work.....	355
Post-Crash Alert System Limitations.....	355
Switching the Post-Crash Alert System Off.....	355
What Is the Post-Crash Alert System.....	354
Power Flow.....	195
Power Gauge.....	134
Power Outlet Indicators.....	177
Power Outlet.....	177
Power Outlet Precautions.....	177
Power Seats.....	155
Adjusting the Head Restraint.....	155
Adjusting the Lumbar Support.....	158
Adjusting the Seat Backrest.....	157
Adjusting the Seat Cushion.....	157

# Index

Adjusting the Seat Height.....	158	Predictive Speed Assist Indicators.....	279	Keys and Remote Controls.....	520
Head Restraint Components.....	155	Predictive Speed Assist Limitations.....	279	Operating System.....	522
Installing the Head Restraint.....	156	Predictive Speed Assist Precautions.....	278	Radio Transceiver Module.....	525
Moving the Seat Backward and Forward.....	157	Switching Predictive Speed Assist Mode On and Off.....	279	Remote Function Actuator.....	510
Removing the Head Restraint.....	156	<b>Predictive Speed Assist – Troubleshooting.....</b>	<b>281</b>	Telematics Control Unit.....	528
<b>Power-Up</b>		Predictive Speed Assist – Information Messages.....	281	Tire Pressure Monitoring System Sensors.....	531
See: Software Update Settings.....	485	Preparing Your Vehicle for Storage.....	403	Wireless Accessory Charging Module.....	536
See: Vehicle Software Updates.....	485	Programming the Garage Door Opener.....	171	<b>Rear Cross Traffic Braking</b>	
Pre-Collision Assist Limitations.....	314	Programming the Remote Control.....	74	See: Cross Traffic Braking.....	234
Pre-Collision Assist Precautions.....	313	Programming Your Phone.....	76	<b>Rear Occupant Alert System Audible Warnings.....</b>	<b>167</b>
Pre-Collision Assist.....	313	Properly Adjusting the Driver and Front Passenger Seats.....	62	<b>Rear Occupant Alert System</b>	
Automatic Emergency Braking.....	319	Protecting the Environment.....	29	Indicators.....	166
Distance Alert.....	318	Puncture		<b>Rear Occupant Alert System</b>	
Distance Indication.....	316	See: Changing a Flat Tire.....	428	Limitations.....	165
Evasive Steering Assist.....	319	Push Button Ignition Switch.....	185	<b>Rear Occupant Alert System</b>	
Pre-Collision Assist – Troubleshooting.....	320	<b>R</b>		Precautions.....	165
<b>Pre-Collision Assist – Troubleshooting.....</b>	<b>320</b>	Radio Frequency Certification		<b>Rear Occupant Alert System.....</b>	<b>165</b>
Pre-Collision Assist – Frequently Asked Questions.....	321	Labels.....	502	<b>Rear Occupant Alert System</b>	
Pre-Collision Assist – Information Messages.....	320	Blind Spot Information System Sensors.....	502	Settings.....	166
<b>Predictive Speed Assist.....</b>	<b>278</b>	Body Control Module.....	510	<b>Rear Parking Aid.....</b>	<b>249</b>
Adjusting the Set Speed Tolerance.....	279	Cruise Control Module.....	514	Locating the Rear Parking Aid Sensors.....	249
How Does Predictive Speed Assist Work.....	278			Rear Parking Aid Audible Warnings.....	250
Predictive Speed Assist Alerts.....	279			Rear Parking Aid Limitations.....	249
				What is the Rear Parking Aid.....	249
				<b>Rear Seats.....</b>	<b>161</b>
				Heated Seats.....	163

# Index

Manual Seats.....	161	Replacement Parts		Reverse Brake Assist – Information	
Rebooting the Center Display.....	470	Recommendation.....	546	Messages.....	232
Recalling a Preset Position.....	168	Replacing a Lost Key or Remote		Reverse Wipe.....	107
Recreationally Towing Your Vehicle - Full		Control.....	74	Reverse Wipe Settings.....	107
Hybrid Electric Vehicle (FHEV).....	359	Replacing the Cabin Air Filter.....	148	What Is Reverse Wipe.....	107
Recreationally Towing Your Vehicle -		Replacing the Front Wiper Blades -		Roadside Assistance.....	348
Gasoline.....	359	Vehicles With: Heated Wiper		Rollover Warning.....	498
Recycling and Disposing of the High		Blades.....	108	Roof Rack.....	332
Voltage Battery.....	213	Replacing the Front Wiper Blades -		Roof Rack Load Capacities.....	332
Refueling.....	203	Vehicles Without: Heated Wiper		Roof Rack Precautions.....	332
Manually Opening the Fuel Filler Door.....	207	Blades.....	107	Running-In	
Refueling System Overview.....	203	Replacing the Rear Wiper Blades.....	108	See: Breaking-In.....	344
Refueling Your Vehicle.....	203	Reporting Safety Defects in Canada.....	501	Running Out of Fuel.....	202
Releasing the Electric Parking Brake if the		Reporting Safety Defects in the United		Adding Fuel From a Portable Fuel	
Vehicle Battery Has Run Out of		States.....	500	Container.....	202
Charge.....	226	Resetting the Stopping Position.....	103	Filling a Portable Fuel Container.....	202
Remote Control Limitations.....	71	Resetting the Trip Computer.....	140		
Remotely Starting and Stopping the		Restarting the Engine.....	197		
Vehicle.....	141	Resuming the Set Speed.....	271		
Remote Start Limitations.....	141	Reverse Brake Assist Indicators.....	232		
Remote Start Precautions.....	141	Reverse Brake Assist Precautions.....	230	S	
Remote Start.....	141	Reverse Brake Assist.....	230	Satellite Radio.....	465
Remote Start Settings.....	142	Reverse Brake Assist –		Locating the Satellite Radio Identification	
Removing the Key Blade.....	72	Troubleshooting.....	232	Number.....	466
Removing Your Vehicle From		Reverse Brake Assist –		Satellite Radio Limitations.....	466
Storage.....	404	Troubleshooting.....	232	Satellite Radio Settings.....	467
Repairing Minor Paint Damage.....	400	Reverse Brake Assist – Frequently Asked		Selecting a Channel.....	466
		Questions.....	233	Setting an Alert.....	467
				What Is Satellite Radio.....	465
				Saving a Preset Position.....	168



# Index

Scheduled Maintenance.....	493	Selecting the Audio Source.....	462	Side Parking Aid.....	251
Seatbelt Extensions.....	55	Sending and Receiving a Text Message.....	478	Locating the Side Parking Aid Sensors.....	252
Seatbelt Precautions.....	48	Sensitive Locking Mode.....	50	Side Parking Aid Audible Warnings.....	252
Seatbelt Reminder.....	52	How Does Sensitive Locking Mode Work.....	50	Side Parking Aid Limitations.....	251
Checking Seatbelt Status.....	54	What is Sensitive Locking Mode.....	50	What is the Side Parking Aid.....	251
How Does the Seatbelt Reminder Work.....	52	Service Data.....	25	Sitting in the Correct Position.....	154
Seatbelt Reminder Audible Warnings.....	53	Setting a Memory Preset.....	463	Software Update Indicators.....	486
Seatbelt Reminder Indicators.....	52	Settings Data.....	26	Software Update Settings.....	485
Switching the Seatbelt Reminder On and Off.....	53	Setting the Adaptive Cruise Control Gap.....	470	Software Update See: Software Update Settings.....	485
Seatbelts.....	48	Setting the Adaptive Cruise Control Speed.....	268	See: Vehicle Software Updates.....	485
Automatic Locking Mode.....	51	Setting the Adaptive Cruise Control Tolerance.....	323	Sounding the Panic Alarm.....	72
Seatbelt Reminder.....	52	Setting the Blower Motor Speed.....	144	Speedometer.....	134
Seatbelts – Troubleshooting.....	56	Setting the Clock and Date.....	463	Speed Sign Recognition Indicators.....	323
Sensitive Locking Mode.....	50	Setting the Liftgate Opening Height.....	93	Speed Sign Recognition Limitations.....	322
Seatbelts – Troubleshooting.....	56	Setting the Speed Sign Recognition Speed Warning.....	323	Speed Sign Recognition Precautions.....	322
Seatbelts – Information Messages.....	56	Setting the Temperature.....	144	Speed Sign Recognition.....	322
SecuriCode See: Keyless Entry Keypad.....	85	Setting Up a Vehicle Hotspot.....	460	Speed Sign Recognition – Troubleshooting.....	323
Security.....	98	Setting Your Default Assistant.....	471	Speed Sign Recognition – Troubleshooting.....	323
Anti-Theft Alarm System.....	98	Shifting Your Immobile Vehicle Out of Park (P).....	216	Speed Sign Recognition – Frequently Asked Questions.....	324
Anti-Theft Alarm System Settings.....	99	Shifting Your Vehicle Into Gear.....	215	Speed Sign Recognition – Information Messages.....	323
Passive Anti-Theft System.....	98			Stability Control Indicator.....	243
Security – Troubleshooting.....	100				
Security – Troubleshooting.....	100				
Security – Frequently Asked Questions.....	101				
Security – Information Messages.....	100				
Selecting a Drive Mode.....	293				

# Index

Stability Control.....	242	Steering.....	245	Switching Air Conditioning On and Off.....	143
Stability Control – Troubleshooting.....	244	Electric Power Steering.....	245	Switching All of the Interior Lamps On and Off.....	122
Stability Control – Troubleshooting.....	244	Steering – Troubleshooting.....	245	Switching Android Auto On and Off.....	479
Stability Control – Information Messages.....	244	Steering – Troubleshooting.....	245	Switching Apple CarPlay On and Off.....	479
Starting and Stopping the Engine – Precautions.....	185	Steering – Frequently Asked Questions.....	247	Switching Auto Hold On and Off - Full Hybrid Electric Vehicle (FHEV).....	239
Starting and Stopping the Engine.....	185	Steering – Information Messages.....	246	Switching Auto Hold On and Off - Gasoline.....	239
Automatic Engine Stop.....	189	Steering – Warning Lamps.....	245	Switching Auto-Start-Stop On and Off.....	197
Engine Block Heater.....	187	Steering Wheel.....	102	Switching Blind Spot Information System On and Off.....	308
Starting and Stopping the Engine – Troubleshooting.....	190	Stopping the Engine.....	197	Switching BlueCruise On and Off.....	286
Starting the Engine.....	186	Stopping the Engine When Your Vehicle is Moving.....	188	Switching Climate Control On and Off.....	143
Stopping the Engine.....	188	Stopping the Engine When Your Vehicle is Stationary.....	188	Switching Cross Traffic Alert On and Off.....	311
Starting and Stopping the Engine – Troubleshooting.....	190	Stopping the Liftgate Movement.....	96	Switching Cross Traffic Braking On and Off.....	235
Starting and Stopping the Engine – Frequently Asked Questions.....	192	Storage.....	182	Switching Driver Alert On and Off.....	326
Starting and Stopping the Engine – Information Messages.....	191	Center Console.....	183	Switching Easy Entry and Exit On and Off.....	89
Starting and Stopping the Engine – Warning Lamps.....	190	Cup Holders.....	182	Switching From Adaptive Cruise Control to Cruise Control.....	272
Starting the Engine.....	186	Glasses Holder.....	184	Switching Maximum Cooling On and Off.....	144
Restarting the Engine After Stopping It.....	187	Glove Compartment.....	183		
Starting a Gasoline Engine.....	186	Under Floor Storage.....	184		
Starting a Hybrid Electric Vehicle System.....	186	Storing Your Vehicle.....	403		
Status Bar.....	468	Sunroof			
		See: Moonroof.....	131		
		Switching Active Park Assist On and Off.....	259		
		Switching Adaptive Cruise Control On and Off.....	267		

# Index

Switching Maximum Defrost On and Off.....	143
Switching Parking Aid On and Off.....	249
Switching Pre-Collision Assist On and Off.....	315
Switching Recirculated Air On and Off.....	143
Switching Repeat Mode On and Off.....	463
Switching Reverse Brake Assist On and Off.....	231
Switching Shuffle Mode On and Off.....	463
Switching Stability Control On and Off.....	243
Switching Text Message Notification On and Off.....	479
Switching the Audio Unit On and Off.....	462
Switching the Front Interior Lamps On and Off.....	122
Switching the Hazard Flashers On and Off.....	351
Switching the Heated Mirrors On and Off.....	144
Switching the Heated Rear Window On and Off.....	144
Switching the Lane Keeping System Mode.....	298
Switching the Lane Keeping System On and Off.....	298
Switching the Rear Interior Lamps On and Off.....	122
Switching the Rear Window Wiper On and Off.....	106
Switching Traction Control On and Off.....	241
Switching Trailer Sway Control On and Off.....	343
Symbols Glossary.....	21
Symbols Used on Your Vehicle.....	21
System Update See: Software Update Settings.....	485
See: Vehicle Software Updates.....	485
<b>T</b>	
Tachometer.....	134
Technical Specifications See: Capacities and Specifications.....	436
Temporary Neutral Mode.....	217
Entering Temporary Neutral Mode.....	217
Exiting Temporary Neutral Mode.....	217
How Does Temporary Neutral Mode Work.....	217
Temporary Neutral Mode Limitations.....	217
The Better Business Bureau Auto Line Program.....	498
The Mediation and Arbitration Program.....	499
Third Party Software Copyright Acknowledgment.....	502
Tire Care.....	416
Tire Pressure Monitoring System Limitations.....	425
Tire Pressure Monitoring System Overview.....	423
Tire Pressure Monitoring System Precautions.....	424
Tire Pressure Monitoring System.....	423
Tire Pressure Monitoring System – Troubleshooting.....	425
Tire Pressure Monitoring System – Troubleshooting.....	425
Tire Pressure Monitoring System – Information Messages.....	427
Tire Pressure Monitoring System – Warning Lamps.....	425
Tire Replacement Requirements.....	411
Tire Rotation.....	421
Towing a Trailer Limitations.....	339
Towing a Trailer Precautions.....	338
Towing a Trailer.....	338
Towing Weights and Dimensions.....	341

# Index

Towing Weights and Dimensions.....	341	Under Hood Fuse Box.....	361	Vehicle Hotspot – Troubleshooting.....	461
Calculating the Maximum Loaded Trailer		Accessing the Under Hood Fuse Box.....	361	Vehicle Hotspot – Frequently Asked	
Weight for Your Vehicle.....	342	Identifying the Fuses in the Under Hood Fuse		Questions.....	461
Recommended Towing Weights.....	341	Box.....	362	Vehicle Hotspot.....	460
What Is the Maximum Loaded Trailer		Locating the Under Hood Fuse Box.....	361	Vehicle Hotspot – Troubleshooting.....	461
Weight.....	342	Under Hood Overview - Full Hybrid Electric		Vehicle Identification Number.....	455
Towing Your Vehicle Precautions.....	359	Vehicle (FHEV).....	377	Locating the Vehicle Identification	
Towing Your Vehicle.....	359	Under Hood Overview - Gasoline.....	375	Number.....	455
Traction Control Indicator.....	241	USB Ports.....	175	Vehicle Identification Number	
Traction Control.....	241	Using Auto Hold.....	240	Overview.....	455
Traction Control – Troubleshooting.....	241	Using Keyless Entry.....	83	Vehicle Identification.....	455
Traction Control – Troubleshooting.....	241	Using Snow Chains.....	414	Vehicle Identification Number.....	455
Traction Control – Warning Lamps.....	241	Using the Backup Start Passcode.....	77	Vehicle Software Updates.....	485
Trailer Brake Precautions.....	338	Using the Controls on the Steering		Vehicle System Reset.....	487
Trailer Lighting Check.....	337	Wheel.....	102	Ventilation	
Trailer Sway Control Precautions.....	343	Using the Keyless Entry Keypad.....	87	See: Climate Control.....	143
Trailer Sway Control.....	343	Using the Remote Control.....	71	Venting the Moonroof.....	132
Trailer Towing Hints.....	339	Using the Valet Mode.....	76	Viewing the Tire Pressures.....	425
Transmission Specifications - Full Hybrid		Using This Publication.....	20	Visual Search.....	30
Electric Vehicle (FHEV).....	438	<b>V</b>		Voice Interaction.....	471
Transporting the Vehicle.....	356	Vehicle Care.....	395	<b>W</b>	
Trip Computer.....	140	Cleaning the Exterior.....	396	Warranty Information.....	549
<b>U</b>		Cleaning the Interior.....	398	Washer Fluid Specification.....	452
Under Floor Storage.....	184	Vehicle Hotspot Settings.....	460	Washers.....	109
Locating the Rear Under Floor Storage.....	184			Adding Washer Fluid.....	110

# Index

Switching the Courtesy Wipe On and Off.....	109	What Is Pre-Collision Assist.....	313	Wheel Nuts.....	434
Using the Rear Window Washer.....	109	What Is Remote Start.....	141	Wi Fi	
Using the Windshield Washer.....	109	What Is Reverse Brake Assist.....	230	See: Connecting the Vehicle to a Wi-Fi Network.....	456
Washer Fluid Specification.....	110	What Is Speed Sign Recognition.....	322	Window Bounce-Back.....	125
Washer Precautions.....	109	What Is the 360 Degree Camera.....	254	Overriding Window Bounce-Back.....	126
Washers		What Is the Cabin Air Filter.....	148	Resetting Window Bounce-Back.....	126
See: Wipers and Washers.....	105	What Is the Catalytic Converter.....	211	What Is Window Bounce-Back.....	125
Waxing Your Vehicle.....	401	What Is the Electric Parking Brake.....	225	Windows.....	124
What Are the Instrument Cluster Indicators.....	136	What Is the Gross Axle Weight Rating.....	329	Global Opening and Closing.....	125
What Are the Instrument Cluster Warning Lamps.....	135	What Is the Gross Combined Weight Rating.....	329	Window Bounce-Back.....	125
What Is 911 Assist.....	69	What Is the Gross Vehicle Weight Rating.....	329	Wipers and Washers – Troubleshooting.....	110
What Is a Connected Vehicle.....	456	What Is the High Voltage Battery.....	213	Wipers and Washers – Frequently Asked Questions.....	110
What Is Active Park Assist.....	259	What Is the Keyless Entry Keypad.....	85	Wipers and Washers – Warning Lamps.....	110
What Is Auto-Start-Stop.....	197	What Is the Lane Keeping System.....	297	Wipers and Washers.....	105
What Is Blind Spot Information System.....	307	What Is the Pedestrian Alert System.....	68	Autowipers.....	105
What Is BlueCruise.....	283	What Is the Personal Safety System.....	57	Reverse Wipe.....	107
What Is Cross Traffic Alert.....	310	What Is the Power Outlet.....	177	Washers.....	109
What Is Cross Traffic Braking.....	234	What Is the Rear Occupant Alert System.....	165	Wipers.....	105
What Is Drive Mode Control.....	293	What Is the Tire Pressure Monitoring System.....	423	Wipers and Washers – Troubleshooting.....	110
What Is Driver Alert.....	325	What Is the Tire Pressure Monitoring System.....	423	Wipers.....	105
What Is Hill Start Assist.....	238	What Is the Wireless Accessory Charger.....	180	Switching Windshield Wipers On and Off.....	105
What Is Keyless Entry.....	83	What is Voice Interaction.....	471	Wiper Precautions.....	105
What Is Lincoln Protect.....	490	Wheel and Tire Information.....	405	Wireless Accessory Charger Precautions.....	180
What Is Phone as a Key.....	76				

# Index

---

Wireless Accessory Charger.....180



, Edition date: 202310