

Pictorial index	Search by illustration	
For safety and security	Make sure to read through them (Main topics: Child seat, theft deterrent system)	1
Vehicle status information and indicators	Reading driving-related information (Main topics: Meters, multi-information display)	2
Before driving	Opening and closing the doors and windows, adjustment before driving (Main topics: Keys, doors, seats)	3
Driving	Operations and advice which are necessary for driving (Main topics: Starting engine, refueling)	4
Interior features	Usage of the interior features (Main topics: Air conditioner, storage features)	5
Maintenance and care	Caring for your vehicle and maintenance procedures (Main topics: Interior and exterior, light bulbs)	6
When trouble arises	What to do in case of malfunction and emergency (Main topics: Battery discharge, flat tire)	7
Vehicle specifications	Vehicle specifications, customizable features (Main topics: Fuel, oil, tire inflation pressure)	8
For owners	Reporting safety defects for U.S. owners, and seat belt, SRS airbag and headlight aim instructions for Canadian owners	9
Index	Search by symptom	
	Search alphabetically	

2 TABLE OF CONTENTS

For your information	5
Reading this manual	9
How to search	10
Pictorial index	11

1 For safety and security

1-1. For safe use	
Before driving	22
For safe driving	23
Seat belts	24
SRS airbags	28
Front passenger occupant classification system	36
Riding with children	40
Child restraint systems	40
Exhaust gas precautions	51
1-2. LEXUS Enform	
Lexus Enform Safety Connect ...	52
1-3. Theft deterrent system	
Engine immobilizer system	56
Alarm	57
Theft prevention labels (U.S.A.)	59

2 Vehicle status information and indicators

2-1. Instrument cluster	
Warning lights and indicators	62
Gauges and meters	66
Multi-information display	71
Fuel consumption information ...	79

3 Before driving

3-1. Key information	
Keys	84
3-2. Opening, closing and locking the doors and trunk	
Doors	88
Trunk	91
Smart access system with push-button start	95
3-3. Adjusting the seats	
Front seats	99
Rear seats	101
Power easy access system/driving position memory/memory recall function	102
Head restraints	105
3-4. Adjusting the steering wheel and mirrors	
Steering wheel	108
Inside rear view mirror	109
Outside rear view mirrors	110
3-5. Opening, closing the windows and moon roof	
Power windows	112
Moon roof	114

4 Driving

4-1. Before driving	
Driving the vehicle	118
Cargo and luggage	123
Vehicle load limits	125
Trailer towing	126
Dinghy towing	126

4-2. Driving procedures
 Engine (ignition) switch **127**
 Automatic transmission..... **131**
 Turn signal lever..... **136**
 Parking brake **137**
 Brake Hold..... **139**
 ASC (Active Sound Control)... **141**

4-3. Operating the lights and wipers
 Headlight switch..... **142**
 AHB (Automatic High Beam)
 **144**
 Windshield wipers and washer
 **147**

4-4. Refueling
 Opening the fuel tank cap..... **155**

4-5. Using the driving support systems
 Lexus Safety System + **158**
 PCS (Pre-Collision System)..... **162**
 LDA (Lane Departure Alert with
 steering control)..... **169**
 Dynamic radar cruise control with
 full-speed range..... **176**
 Intuitive parking assist **185**
 BSM (Blind Spot Monitor)..... **191**
 Driving mode select switch..... **199**
 Driving assist systems..... **201**

4-6. Driving tips
 Winter driving tips **205**

5 Interior features

5-1. Remote Touch/Display
 Remote Touch..... **210**
 Center Display..... **212**

5-2. Using the air conditioning system
 Automatic air conditioning system
 **215**
 Heated steering wheel/seat heat-
 ers/seat ventilators..... **223**

5-3. Using the interior lights
 Interior lights list **225**

5-4. Using the storage features
 List of storage features **227**
 Trunk features **229**

5-5. Using the other interior features
 Other interior features **230**
 Garage door opener **232**
 Compass **237**

6 Maintenance and care

6-1. Maintenance and care
 Cleaning and protecting the vehi-
 cle exterior..... **242**
 Cleaning and protecting the vehi-
 cle interior **245**

6-2. Maintenance
 Maintenance requirements..... **248**
 General maintenance..... **249**
 Emission inspection and mainte-
 nance (I/M) programs..... **252**

6-3. Do-it-yourself maintenance
 Do-it-yourself service precautions
 **253**
 Hood **255**
 Positioning a floor jack **255**
 Engine compartment **257**
 Tires **265**
 Tire inflation pressure..... **273**
 Wheels **274**



4 TABLE OF CONTENTS

Air conditioning filter.....	275
Electronic key battery	277
Checking and replacing fuses	278
Headlight aim.....	280
Light bulbs.....	281

7 When trouble arises

7-1. Essential information	
Emergency flashers.....	286
If your vehicle has to be stopped in an emergency.....	286
If the vehicle is trapped in rising water.....	287
7-2. Steps to take in an emergency	
If your vehicle needs to be towed	289
If you think something is wrong	293
Fuel pump shut off system	294
If a warning light turns on or a warn- ing buzzer sounds.....	295
If a warning message is displayed	303
If you have a flat tire.....	307
If the engine will not start	314
If you lose your keys.....	316
If the fuel filler door cannot be opened.....	316
If the electronic key does not oper- ate properly	317
If the vehicle battery is discharged	319
If your vehicle overheats	322
If the vehicle becomes stuck ...	326

8 Vehicle specifications

8-1. Specifications	
Maintenance data (fuel, oil level, etc.).....	328
Fuel information.....	339
Tire information	341
8-2. Customization	
Customizable features	351
8-3. Items to initialize	
Items to initialize.....	361
8-4. Certifications	
Certifications	362

9 For owners

9-1. For owners	
Reporting safety defects for U.S. owners.....	372
Seat belt instructions for Canadian owners (in French)	372
SRS airbag instructions for Cana- dian owners (in French)	374
Headlight aim instructions for Canadian owners (in French)	380

Index

What to do if... (Troubleshooting)	382
Alphabetical Index	385

For your information

Main Owner's Manual

Please note that this manual applies to all models and explains all equipment, including options. Therefore, you may find some explanations for equipment not installed on your vehicle.

All specifications provided in this manual are current at the time of printing. However, because of the Lexus policy of continual product improvement, we reserve the right to make changes at any time without notice.

Depending on specifications, the vehicle shown in the illustrations may differ from your vehicle in terms of color and equipment.

Noise from under vehicle after turning off the engine

Approximately five hours after the engine is turned off, you may hear sound coming from under the vehicle for several minutes. This is the sound of a fuel evaporation leakage check and, it does not indicate a malfunction.

Accessories, spare parts and modification of your Lexus

A wide variety of non-genuine spare parts and accessories for Lexus vehicles are currently available in the market. You should know that Toyota does not warrant these products and is not responsible for their performance,

repair, or replacement, or for any damage they may cause to, or adverse effect they may have on, your Lexus vehicle.

This vehicle should not be modified with non-genuine Lexus products. Modification with non-genuine Lexus products could affect its performance, safety or durability, and may even violate governmental regulations. In addition, damage or performance problems resulting from the modification may not be covered under warranty.

Installation of a mobile two-way radio system

The installation of a mobile two-way radio system in your vehicle could affect electronic systems such as:

- Multiport fuel injection system/sequential multiport fuel injection system
- Lexus Safety System +
- Anti-lock brake system
- Vehicle dynamics integrated management
- SRS airbag system
- Seat belt pretensioner system

Be sure to check with your Lexus dealer for precautionary measures or special instructions regarding installation of a mobile two-way radio system.

Vehicle data recording

The vehicle is equipped with sophisti-

cated computers that will record certain data, such as:

- Engine speed / Electric motor speed (traction motor speed)
- Accelerator status
- Brake status
- Vehicle speed
- Operation status of the driving assist systems
- Images from the cameras

Your vehicle is equipped with cameras. Contact your Lexus dealer for the location of recording cameras.

The recorded data varies according to the vehicle grade level and options with which it is equipped.

These computers do not record conversations or sounds, and only record images outside of the vehicle in certain situations.

● Data Transmission

Your vehicle may transmit the data recorded in these computers to Lexus without notification to you.

● Data usage

Lexus may use the data recorded in this computer to diagnose malfunctions, conduct research and development, and improve quality.

Lexus will not disclose the recorded data to a third party except:

- With the consent of the vehicle owner or with the consent of the lessee if the vehicle is leased
- In response to an official request by the police, a court of law or a government agency
- For use by Lexus in a lawsuit
- For research purposes where the data is

not tied to a specific vehicle or vehicle owner

- Recorded image information can be erased by your Lexus dealer.

The image recording function can be disabled. However, if the function is disabled, data from when the system operates will not be available.

- To learn more about the vehicle data collected, used and shared by Lexus, please visit www.lexus.com/privacyvts/.

Usage of data collected through Lexus Enform (U.S. mainland only)

If your Lexus has Lexus Enform and if you have subscribed to those services, please refer to the Lexus Enform Telematics Subscription Service Agreement for information on data collected and its usage.

To learn more about the vehicle data collected, used and shared by Lexus, please visit www.lexus.com/privacyvts/.

Event data recorder

This vehicle is equipped with an event data recorder (EDR). The main purpose of an EDR is to record, in certain crash or near crash-like situations, such as an air bag deployment or hitting a road obstacle, data that will assist in understanding how a vehicle's systems performed. The EDR is designed to record data related to vehicle dynamics and safety systems for a short

period of time, typically 30 seconds or less.

The EDR in this vehicle is designed to record such data as:

- How various systems in your vehicle were operating;
- Whether or not the driver and passenger safety belts were buckled/fastened;
- How far (if at all) the driver was depressing the accelerator and/or brake pedal; and,
- How fast the vehicle was traveling.

These data can help provide a better understanding of the circumstances in which crashes and injuries occur.

NOTE: EDR data are recorded by your vehicle only if a non-trivial crash situation occurs; no data are recorded by the EDR under normal driving conditions and no personal data (e.g., name, gender, age, and crash location) are recorded. However, other parties, such as law enforcement, could combine the EDR data with the type of personally identifying data routinely acquired during a crash investigation.

To read data recorded by an EDR, special equipment is required, and access to the vehicle or the EDR is needed. In addition to the vehicle manufacturer, other parties, such as law enforcement, that have the special equipment, can read the information if they have access to the vehicle or the EDR.

- Disclosure of the EDR data

Lexus will not disclose the data recorded in an EDR to a third party except when:

- An agreement from the vehicle's owner (or the lessee for a leased vehicle) is obtained
- In response to an official request by the police, a court of law or a government agency
- For use by Lexus in a lawsuit

However, if necessary, Lexus may:

- Use the data for research on vehicle safety performance
- Disclose the data to a third party for research purposes without disclosing information about the specific vehicle or vehicle owner

Scrapping of your Lexus

The SRS airbag and seat belt pretensioner devices in your Lexus contain explosive chemicals. If the vehicle is scrapped with the airbags and seat belt pretensioners left as they are, this may cause an accident such as fire. Be sure to have the systems of the SRS airbag and seat belt pretensioner removed and disposed of by a qualified service shop or by your Lexus dealer before you scrap your vehicle.

Perchlorate Material

Special handling may apply, See www.dtsc.ca.gov/hazardouswaste/perchlorate.

Your vehicle has components that may contain perchlorate. These components may include airbag, seat belt pretensioners, and wireless remote control batteries.

**WARNING****■ General precautions while driving**

Driving under the influence: Never drive your vehicle when under the influence of alcohol or drugs that have impaired your ability to operate your vehicle. Alcohol and certain drugs delay reaction time, impair judgment and reduce coordination, which could lead to an accident that could result in death or serious injury.

Defensive driving: Always drive defensively. Anticipate mistakes that other drivers or pedestrians might make and be ready to avoid accidents.

Driver distraction: Always give your full attention to driving. Anything that distracts the driver, such as adjusting controls, talking on a cellular phone or reading can result in a collision with resulting death or serious injury to you, your occupants or others.

■ General precaution regarding children's safety



Never leave children unattended in the vehicle, and never allow children to have or use the key.

Children may be able to start the vehicle or shift the vehicle into neutral. There is also a danger that children may injure themselves by playing with the windows, the moon roof, or other features of the vehicle. In addition, heat build-up or extremely cold temperatures inside the vehicle can be fatal to children.

Reading this manual



Explains symbols used in this manual.

Symbols in this manual

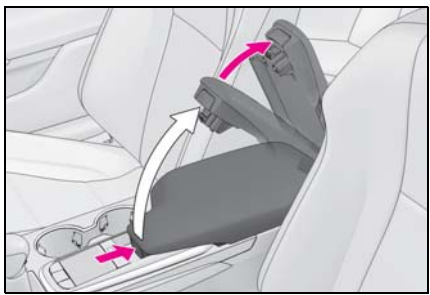

Symbols	Meanings
	WARNING: Explains something that, if not obeyed, could cause death or serious injury to people.
	NOTICE: Explains something that, if not obeyed, could cause damage to or a malfunction in the vehicle or its equipment.
	Indicates operating or working procedures. Follow the steps in numerical order.

Symbols in illustrations

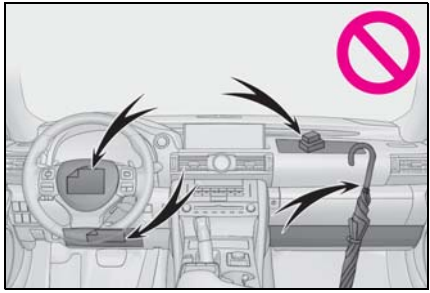

Symbols	Meanings
	Indicates the action (pushing, turning, etc.) used to operate switches and other devices.
	Indicates the outcome of an operation (e.g. a lid opens).



Symbols	Meanings
	Indicates the component or position being explained.
	Means Do not, Do not do this, or Do not let this happen.

How to search

■ Searching by name

- Alphabetical index: →P.385

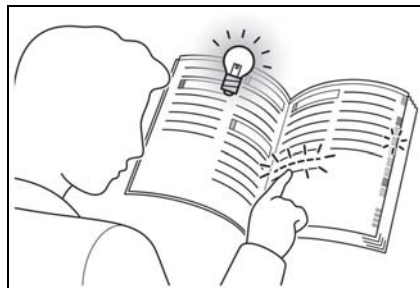
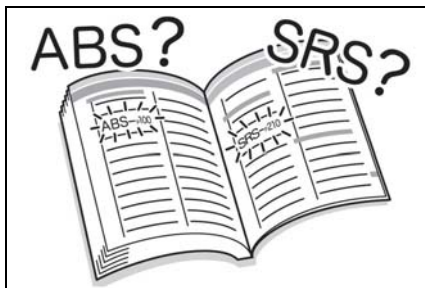

■ Searching by installation position

- Pictorial index: →P.11

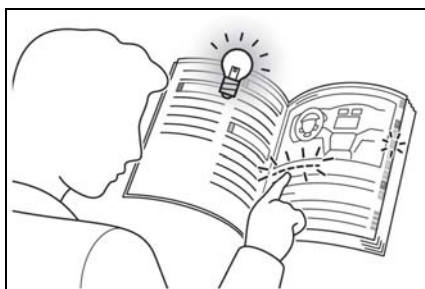

■ Searching by symptom or sound

- What to do if... (Troubleshooting):
→P.382



■ Searching by title

- Table of contents: →P.2

Pictorial index

■ Exterior

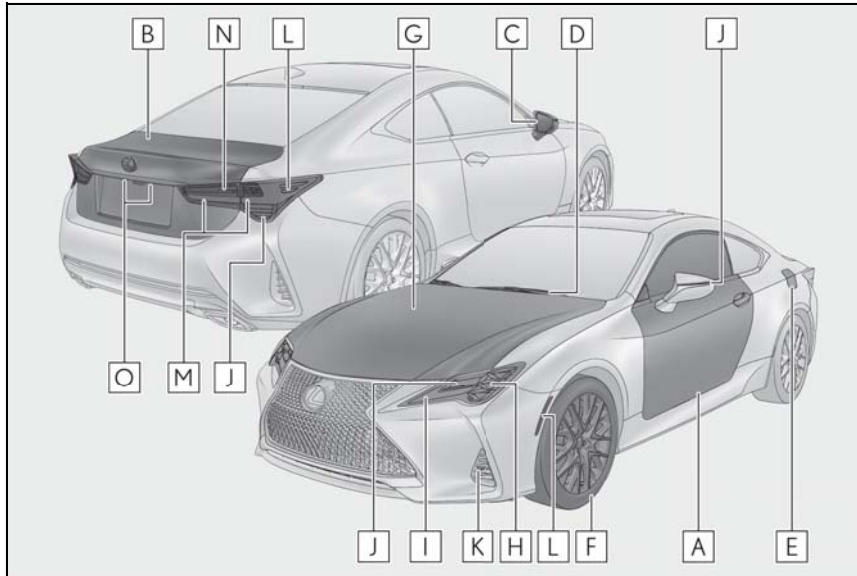

The shape of the headlights may differ depending on the grade, etc.

A	Doors	P.88
	Locking/unlocking	P.88
	Opening/closing the side windows	P.112
	Locking/unlocking by using the mechanical key	P.317
	Warning lights/warning messages	P.295, 303
B	Trunk	P.91
	Opening from inside the cabin	P.92
	Opening from outside	P.92
	Opening by using the mechanical key	P.317
	Warning lights/warning messages	P.295, 303
C	Outside rear view mirrors	P.110
	Adjusting the mirror angle	P.110
	Folding the mirrors	P.111
	Driving position memory *	P.102
	Defogging the mirrors	P.219

D	Windshield wipers	P.147
	Precautions for winter season	P.205
	To prevent freezing (windshield wiper de-icer)*	P.219
	Precautions against car wash	P.243
E	Fuel filler door	P.155
	Refueling method	P.155
	Fuel type/fuel tank capacity	P.330
F	Tires	P.265
	Tire size/inflation pressure	P.334
	Winter tires/tire chain	P.205
	Checking/rotation/tire pressure warning system.....	P.265
	Coping with flat tires.....	P.307
G	Hood	P.255
	Opening	P.255
	Engine oil.....	P.330
	Coping with overheating.....	P.322
	Warning messages	P.303

Light bulbs of the exterior lights for driving
(Replacing method: P.281, Watts: P.338)

H	Headlights	P.142
I	Parking lights/daytime running lights	P.142
J	Turn signal lights	P.136
K	Cornering lights	P.142
L	Side marker lights	P.142
M	Tail lights	P.142
	Stop lights	
N	Back up light	
	Shifting the shift lever to R.....	P.132
O	License plate lights	P.142

*: If equipped

■ Instrument panel

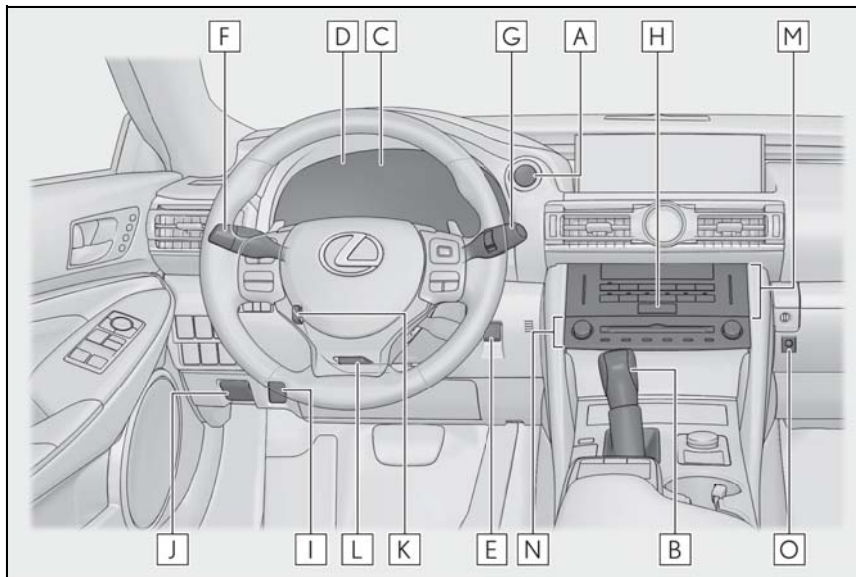

- | | | |
|----------|--|--------------|
| A | Engine switch | P.127 |
| | Starting the engine/changing the mode | P.127 |
| | Emergency stop of the engine | P.286 |
| | When the engine will not start | P.314 |
| | Warning messages | P.303 |
| B | Shift lever | P.131 |
| | Changing the shift position | P.132 |
| | Precautions for towing | P.289 |
| | When the shift lever does not move | P.132 |
| C | Meters | P.66 |
| | Reading the meters/adjusting the instrument panel lights | P.66 |
| | Warning lights/indicator lights | P.62 |
| | When a warning light comes on | P.295 |
| D | Multi-information display | P.71 |
| | Display | P.71 |
| | When the warning messages are displayed | P.303 |

E	Parking brake switch	P.137
	Applying/releasing	P.137
	Precautions for winter season	P.206
	Warning buzzer/message.....	P.303
F	Headlight switch	P.142
	Turn signal lever	P.136
	Headlights/parking lights/tail lights/license plate lights/daytime running lights	P.142
G	Windshield wiper and washer switch	P.147
	Usage.....	P.147
	Adding washer fluid.....	P.264
	Warning messages	P.303
	Headlight cleaners ^{*1}	P.147
H	Emergency flasher switch	P.286
I	Trunk opener switch	P.92
J	Hood lock release lever	P.255
K	Tilt and telescopic steering control switch ^{*1}	P.108
	Adjustment	P.108
	Driving position memory ^{*1}	P.102
L	Tilt and telescopic steering lock release lever ^{*1}	P.108
	Adjustment	P.108
M	Air conditioning system	P.215
	Usage.....	P.215
	Rear window defogger.....	P.219
N	Audio system ^{*2}	
O	Trunk opener main switch	P.94

^{*1}: If equipped

^{*2}: Refer to "NAVIGATION AND MULTIMEDIA SYSTEM OWNER'S MANUAL".

■ Switches

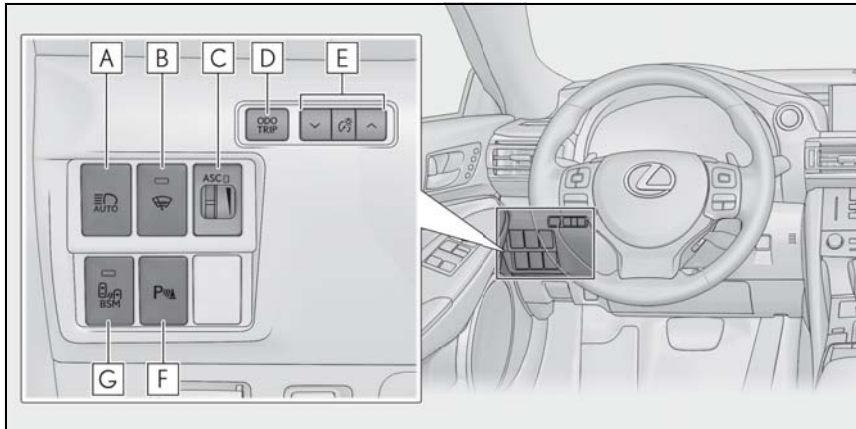

- A** Automatic High Beam switch.....P.144
- B** Windshield wiper de-icer switch *P.219
- C** ASC switch*P.141
- D** Odometer/trip meter/trip meter reset buttonP.70
- E** Instrument panel light control switchesP.71
- F** Intuitive parking assist switch *P.185
- G** BSM (Blind Spot Monitor) main switch *P.191

* : If equipped

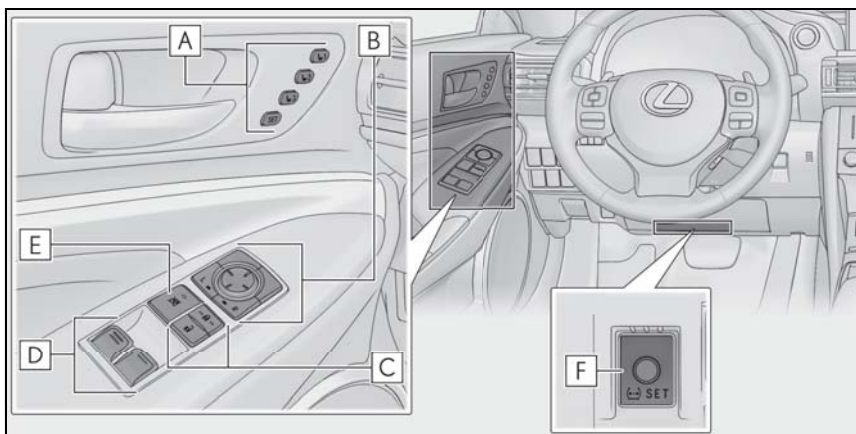

- A** Driving position memory buttons *P.102

B Outside rear view mirror switches P.110
C Door lock switches P.90
D Power window switches P.112
E Window lock switch P.113
F Tire pressure warning reset switch..... P.269

* : If equipped

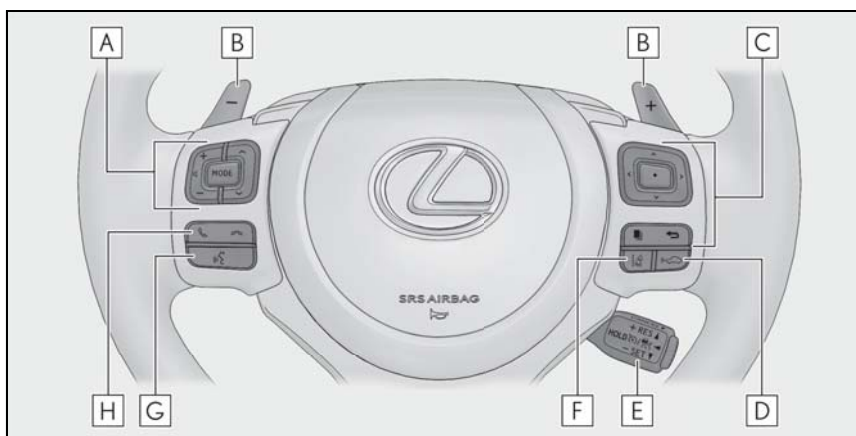

A Audio remote control switches *
B Paddle shift switches P.133, 134
C Meter control switches P.72
D Vehicle-to-vehicle distance switch P.180
E Cruise control switch
 Dynamic radar cruise control with full-speed range P.176
F LDA (Lane Departure Alert with steering control) switch P.169
G Talk switch *
H Telephone switches *

* : Refer to "NAVIGATION AND MULTIMEDIA SYSTEM OWNER'S MANUAL".

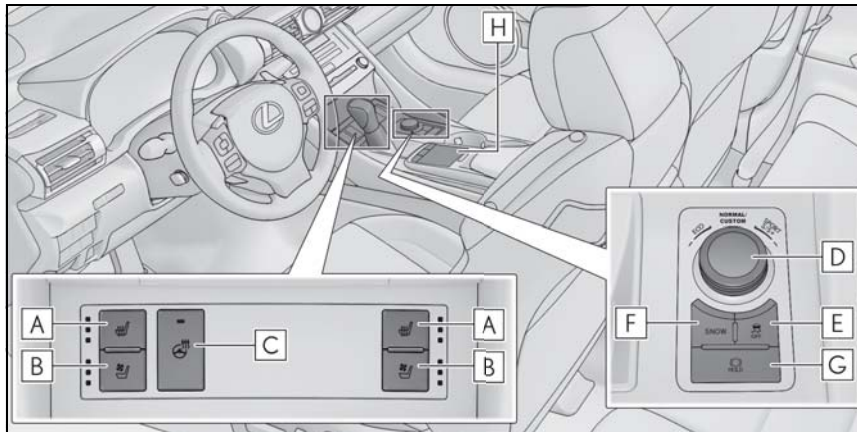

A Seat heater switches ^{*1}	P.223
B Seat ventilator switches ^{*1}	P.224
C Heated steering wheel switch ^{*1}	P.223
D Driving mode select switch	P.199
E VSC OFF switch	P.202
F Snow mode switch	P.133
G Brake hold switch	P.139
H Remote Touch ^{*2}	P.210

^{*1}: If equipped

^{*2}: Refer to "NAVIGATION AND MULTIMEDIA SYSTEM OWNER'S MANUAL".

■ Interior

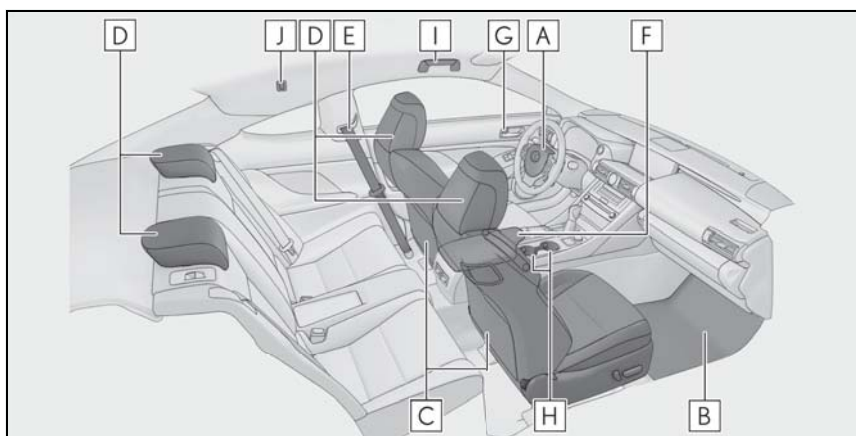

A	SRS airbags.....	P.28
B	Floor mats.....	P.22
C	Front seats.....	P.99
D	Head restraints.....	P.105
E	Seat belts.....	P.24
F	Console box.....	P.228
G	Inside lock buttons.....	P.90
H	Cup holders.....	P.228
I	Assist grips.....	P.230
J	Coat hooks.....	P.230

■ Ceiling

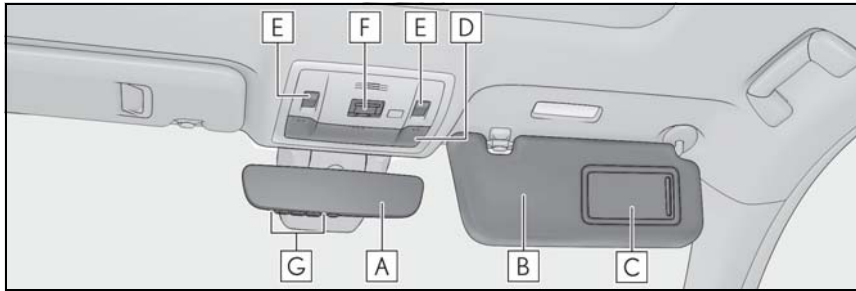

A	Inside rear view mirror	P.109
B	Sun visors.....	P.231
C	Vanity mirrors	P.231
D	Interior light	P.225
	Personal lights.....	P.226
E	Moon roof switches *	P.114
F	"SOS" button *	P.52
G	Garage door opener buttons.....	P.232

* : If equipped

For safety and security

1

21

1-1. For safe use
Before driving22
For safe driving..... 23
Seat belts24
SRS airbags 28
Front passenger occupant classification system36
Riding with children..... 40
Child restraint systems 40
Exhaust gas precautions 51

1-2. LEXUS Enform
Lexus Enform Safety Connect 52

1-3. Theft deterrent system
Engine immobilizer system 56
Alarm..... 57
Theft prevention labels (U.S.A.) 59

For safety and security

Before driving

Observe the following before starting off in the vehicle to ensure safety of driving.

Installing floor mats

Use only floor mats designed specifically for vehicles of the same model and model year as your vehicle. Fix them securely in place onto the carpet.

- 1 Insert the retaining hooks (clips) into the floor mat eyelets.

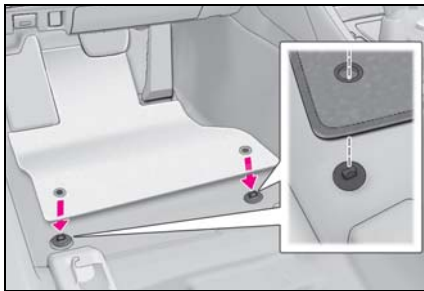

- 2 Turn the upper knob of each retaining hook (clip) to secure the floor mats in place.

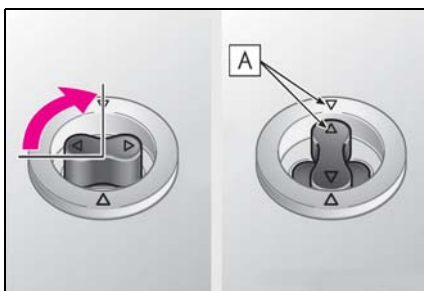

Always align the \triangle marks **A**.

The shape of the retaining hooks (clips) may differ from that shown in the illustration.

⚠ WARNING

Observe the following precautions. Failure to do so may cause the driver's floor mat to slip, possibly interfering with the pedals while driving. An unexpectedly high speed may result or it may become difficult to stop the vehicle. This could lead to an accident, resulting in death or serious injury.

■ When installing the driver's floor mat

- Do not use floor mats designed for other models or different model year vehicles, even if they are Lexus Genuine floor mats.
- Only use floor mats designed for the driver's seat.
- Always install the floor mat securely using the retaining hooks (clips) provided.
- Do not use two or more floor mats on top of each other.
- Do not place the floor mat bottom-side up or upside-down.

■ Before driving

- Check that the floor mat is securely fixed in the correct place with all the provided retaining hooks (clips). Be especially careful to perform this check after cleaning the floor.

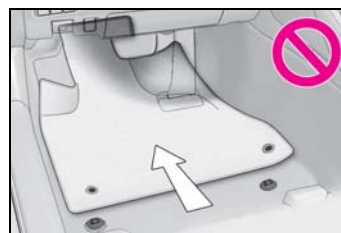

- With the engine stopped and the shift lever in P, fully depress each pedal to the floor to make sure it does not interfere with the floor mat.

For safe driving

For safe driving, adjust the seat and mirror to an appropriate position before driving.

Correct driving posture

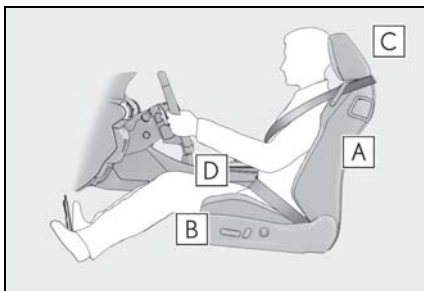

- A** Adjust the angle of the seatback so that you are sitting straight up and so that you do not have to lean forward to steer. (→P.99)
- B** Adjust the seat so that you can depress the pedals fully and so that your arms bend slightly at the elbow when gripping the steering wheel. (→P.99)
- C** Lock the head restraint in place with the center of the head restraint closest to the top of your ears. (→P.105)
- D** Wear the seat belt correctly. (→P.24)

WARNING

■ For safe driving

Observe the following precautions. Failure to do so may result in death or serious injury.

- Do not adjust the position of the driver's seat while driving. Doing so could cause the driver to lose control of the vehicle.
- Do not place a cushion between the driver or passenger and the seatback. A cushion may prevent correct posture from being achieved, and reduce the effectiveness of the seat belt and head restraint.
- Do not place anything under the front seats. Objects placed under the front seats may become jammed in the seat tracks and stop the seat from locking in place. This may lead to an accident and the adjustment mechanism may also be damaged.
- Always observe the legal speed limit when driving on public roads.
- When driving over long distances, take regular breaks before you start to feel tired. Also, if you feel tired or sleepy while driving, do not force yourself to continue driving and take a break immediately.

Correct use of the seat belts

Make sure that all occupants are wearing their seat belts before driving the vehicle. (→P.24)

Use a child restraint system appropriate for the child until the child becomes large enough to properly wear the vehicle's seat belt. (→P.40)

Adjusting the mirrors

Make sure that you can see backward clearly by adjusting the inside and outside rear view mirrors properly. (→P.109, 110)

Seat belts

Make sure that all occupants are wearing their seat belts before driving the vehicle.

WARNING

Observe the following precautions to reduce the risk of injury in the event of sudden braking, sudden swerving or an accident. Failure to do so may cause death or serious injury.

■ Wearing a seat belt

- Ensure that all passengers wear a seat belt.
- Always wear a seat belt properly.
- Each seat belt should be used by one person only. Do not use a seat belt for more than one person at once, including children.
- Lexus recommends that children be seated in the rear seat and always use a seat belt and/or an appropriate child restraint system.
- To achieve a proper seating position, do not recline the seat more than necessary. The seat belt is most effective when the occupants are sitting up straight and well back in the seats.
- Do not wear the shoulder belt under your arm.
- Always wear your seat belt low and snug across your hips.

■ Pregnant women

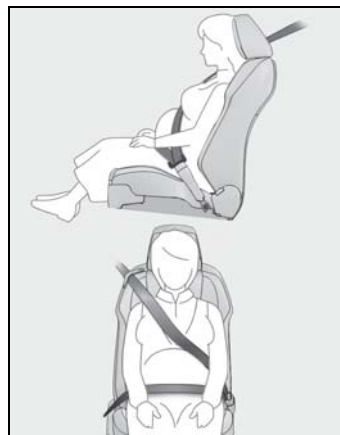

Obtain medical advice and wear the seat belt in the proper way. (→P.25)

Women who are pregnant should position the lap belt as low as possible over the hips in the same manner as other occupants, extending the shoulder belt completely over the shoulder and avoiding belt contact with the rounding of the abdominal area.

If the seat belt is not worn properly, not only the pregnant woman, but also the fetus could suffer death or serious injury as a result of sudden braking or a collision.

■ People suffering illness

Obtain medical advice and wear the seat belt in the proper way. (→P.25)

■ When children are in the vehicle

Do not allow children to play with the seat belt. If the seat belt becomes twisted around a child's neck, it may lead to choking or other serious injuries that could result in death.

If this occurs and the buckle cannot be unfastened, scissors should be used to cut the belt.

■ Seat belt damage and wear

- Do not damage the seat belts by allowing the belt, plate, or buckle to be jammed in the door.

⚠ WARNING

- Inspect the seat belt system periodically. Check for cuts, fraying, and loose parts. Do not use a damaged seat belt until it is replaced. Damaged seat belts cannot protect an occupant from death or serious injury.
- Ensure that the belt and plate are locked and the belt is not twisted. If the seat belt does not function correctly, immediately contact your Lexus dealer.
- Replace the seat assembly, including the belts, if your vehicle has been involved in a serious accident, even if there is no obvious damage.
- Do not attempt to install, remove, modify, disassemble or dispose of the seat belts. Have any necessary repairs carried out by your Lexus dealer. Inappropriate handling may lead to incorrect operation.

Correct use of the seat belts

- Extend the shoulder belt so that it comes fully over the shoulder, but does not come into contact with the neck or slide off the shoulder.
- Position the lap belt as low as possible over the hips.
- Adjust the position of the seatback. Sit up straight and well back in the seat.

- Do not twist the seat belt.

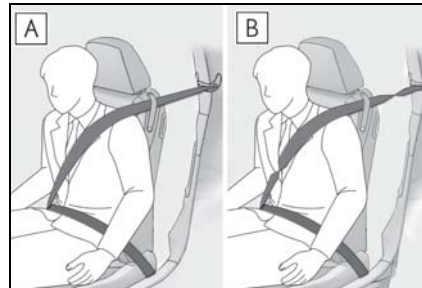
**A** Not twisted**B** Twisted**Child seat belt usage**

The seat belts of your vehicle were principally designed for persons of adult size.

- Use a child restraint system appropriate for the child, until the child becomes large enough to properly wear the vehicle's seat belt. (→P.40)
- When the child becomes large enough to properly wear the vehicle's seat belt, follow the instructions regarding seat belt usage. (→P.24)

Seat belt extender

If your seat belts cannot be fastened securely because they are not long enough, a personalized seat belt extender is available from your Lexus dealer free of charge.

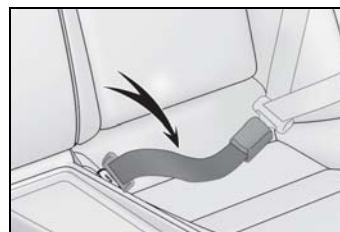
**⚠ WARNING**

- **Using a seat belt extender**
- Do not wear the seat belt extender if you can fasten the seat belt without the extender.

⚠ WARNING

- Do not use the seat belt extender when installing a child restraint system because the belt will not securely hold the child restraint system, increasing the risk of death or serious injury in the event of an accident.
- The personalized extender may not be safe on another vehicle, when used by another person, or at a different seating position other than the one originally intended.

⚠ NOTICE**■ When using a seat belt extender**

When releasing the seat belt, press on the buckle release button on the extender, not on the seat belt. This helps prevent damage to the vehicle interior and the extender itself.

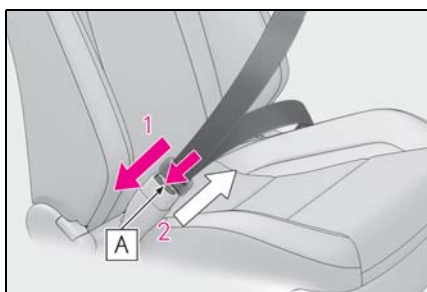
Fastening and releasing the seat belt

- 1 To fasten the seat belt, push the plate into the buckle until a click sound is heard.
- 2 To release the seat belt, press the release button **A**.

■ Emergency locking retractor (ELR)

The retractor will lock the belt during a sudden stop or on impact. It may also lock if you lean forward too quickly. A slow, easy

motion will allow the belt to extend so that you can move around fully.

■ Automatic locking retractor (ALR)

When a passenger's shoulder belt is completely extended and then retracted even slightly, the belt is locked in that position and cannot be extended. This feature is used to hold a child restraint system (CRS) firmly. To free the belt again, fully retract the belt and then pull the belt out once more. (→P.40)

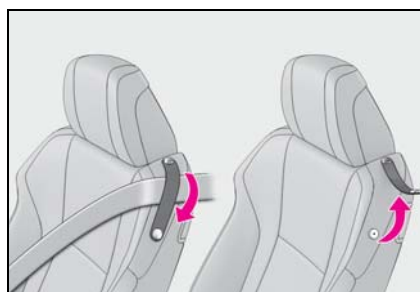
Seat belt guide

When fastening a front seat belt, ensure that it is passed through the seat belt guide. Passing the seat belt through the guide enables the seat belt to be easily extended.

When you get into or out of the rear seats, release the seat belt from the seat belt guide.

⚠ WARNING**■ When using the seat belt guide**

- Always make sure that the belt is not twisted, and runs freely through the guide.
- Regardless of whether the guide is used or not, always secure the seat belt guide button.
- Do not hang from or pull the guide forcefully.

Seat belt pretensioners

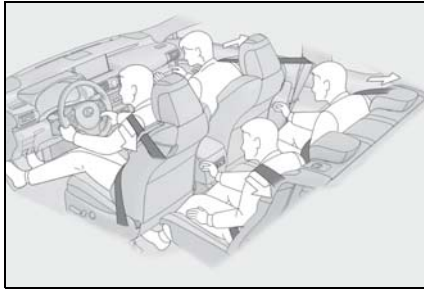

The pretensioners help the seat belts to quickly restrain the occupants by retracting the seat belts when the vehicle is subjected to certain types of severe frontal collision or a vehicle roll-over.

The front seat belt pretensioners also activate when the vehicle is subjected to certain types of severe side collision.

The pretensioners do not activate in the event of a minor frontal impact, a minor side impact or a rear impact.

■ Replacing the belt after the pretensioner has been activated

If the vehicle is involved in multiple collisions, the pretensioner will activate for the first collision, but will not activate for the second or subsequent collisions.

⚠ WARNING

■ Seat belt pretensioners

- Do not place anything, such as a cushion, on the front passenger's seat. Doing so will disperse the passenger's weight, which prevents the sensor from detecting the passenger's weight properly. As a result, the seat belt pretensioner for the front passenger's seat may not activate in the event of a collision.

- If the pretensioner has activated, the SRS warning light will come on. In that case, the seat belt cannot be used again and must be replaced at your Lexus dealer.

SRS airbags

The SRS airbags inflate when the vehicle is subjected to certain types of severe impacts that may cause significant injury to the occupants. They work together with the seat belts to help reduce the risk of death or serious injury.

SRS airbag system

■ Location of the SRS airbags

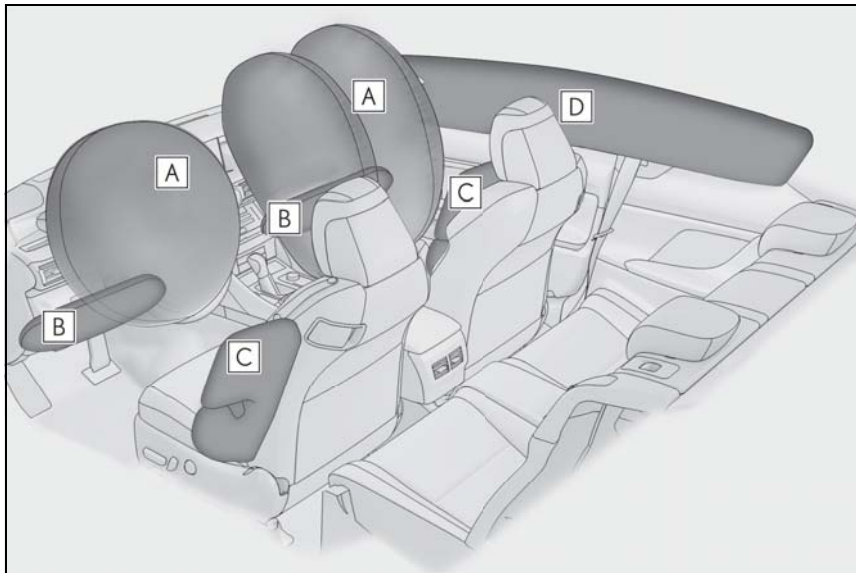

► SRS front airbags

A SRS driver airbag/front passenger airbag

Can help protect the head and chest of the driver and front passenger from impact with interior components

B SRS knee airbags

Can help provide driver and front passenger protection

► SRS side and curtain shield airbags

C SRS side airbags

Can help protect the torso of the front seat occupants

D SRS curtain shield airbags

- Can help protect primarily the head of occupants in the outer seats
- Can help prevent the occupants from being thrown from the vehicle in the event of vehi-

cle rollover

■ SRS airbag system components

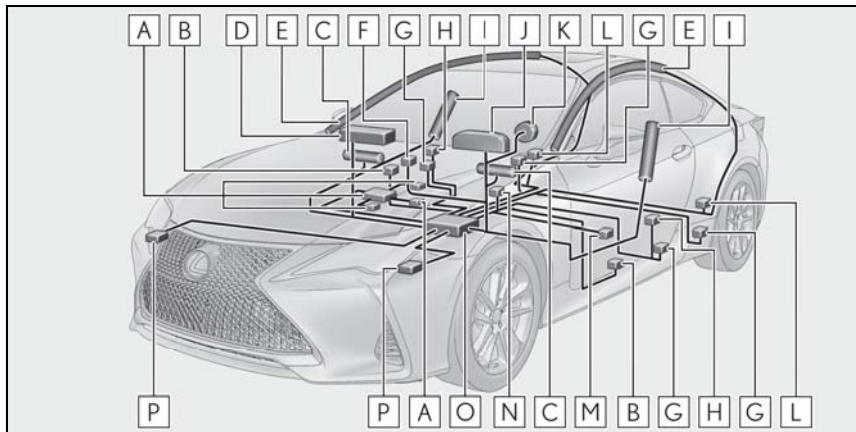

- A** Front passenger occupant classification system (ECU and sensors)
- B** Side impact sensors (front door)
- C** Knee airbags
- D** Front passenger airbag
- E** Curtain shield airbags
- F** "AIR BAG ON" and "AIR BAG OFF" indicator lights
- G** Seat belt pretensioners and force limiters
- H** Side impact sensors (front)
- I** Front side airbags
- J** SRS warning light
- K** Driver airbag
- L** Side impact sensors (rear)
- M** Driver's seat position sensor
- N** Driver's seat belt buckle switch
- O** Airbag sensor assembly
- P** Front impact sensors

Your vehicle is equipped with ADVANCED AIRBAGS designed based on the US motor vehicle safety standards (FMVSS208). The airbag sensor assembly (ECU) controls airbag deployment based on information obtained from the sensors etc. shown in the system components diagram above. This information includes crash

severity and occupant information. As the airbags deploy, a chemical reaction in the inflators quickly fills the airbags with non-toxic gas to help restrain the motion of the occupants.

■ If the SRS airbags deploy (inflate)

- Slight abrasions, burns, bruising etc., may be sustained from SRS airbags, due to the extremely high speed deployment (inflation) by hot gases.
- A loud noise and white powder will be emitted.
- Parts of the airbag module (steering wheel hub, airbag cover and inflator) as well as the front seats, parts of the front and rear pillars, and roof side rails, may be hot for several minutes. The airbag itself may also be hot.
- The windshield may crack.
- All of the doors will be unlocked. (→P.89)
- Fuel supply to the engine will be stopped. (→P.294)
- For Lexus Enform Safety Connect subscribers, if any of the following situations occur, the system is designed to send an emergency call to the response center, notifying them of the vehicle's location (without needing to push the "SOS" button) and an agent will attempt to speak with the occupants to ascertain the level of emergency and assistance required. If the occupants are unable to communicate, the agent automatically treats the call as an emergency and helps to dispatch the necessary emergency services. (→P.52)
 - An SRS airbag is deployed.
 - A seat belt pretensioner is activated.
 - The vehicle is involved in a severe rear-end collision.

■ SRS airbag deployment conditions (SRS front airbags)

- The SRS front airbags will deploy in the event of an impact that exceeds the set threshold level (the level of force corresponding to an approximately 12 - 18 mph [20 - 30 km/h] frontal collision with a fixed wall that does not move or deform).

However, this threshold velocity will be considerably higher in the following situations:

- If the vehicle strikes an object, such as a parked vehicle or sign pole, which can move or deform on impact
- If the vehicle is involved in an underride collision, such as a collision in which the front of the vehicle "underrides", or goes under, the bed of a truck
- Depending on the type of collision, it is possible that only the seat belt pretensioners will activate.
- The SRS front airbags for the front passenger will not activate if there is no passenger sitting in the front passenger seat. However, the SRS front airbags for the front passenger may deploy if luggage is put in the seat, even if the seat is unoccupied.

■ SRS airbag deployment conditions (SRS side and curtain shield airbags)

- The SRS side and curtain shield airbags will deploy in the event of an impact that exceeds the set threshold level (the level of force corresponding to the impact force produced by an approximately 3300 lb. [1500 kg] vehicle colliding with the vehicle cabin from a direction perpendicular to the vehicle orientation at an approximate speed of 12 - 18 mph [20 - 30 km/h]).
- Both SRS curtain shield airbags will deploy in the event of vehicle rollover.
- All SRS side and curtain shield airbags will deploy in the event of a severe frontal collision.

■ Conditions under which the SRS airbags may deploy (inflate), other than a collision

The SRS front airbags and SRS side and curtain shield airbags may also deploy if a serious impact occurs to the underside of your vehicle. Some examples are shown in the illustration.

- Hitting a curb, edge of pavement or hard

surface

- Falling into or jumping over a deep hole
- Landing hard or falling

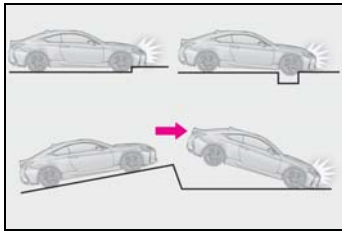

The SRS curtain shield airbags may also deploy under the situations shown in the illustration.

- The angle of vehicle tip-up is marginal.
- The vehicle skids and hits a curb stone.

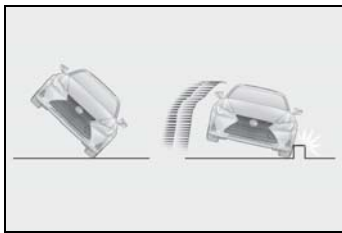

■ Types of collisions that may not deploy the SRS airbags (SRS front airbags)

The SRS front airbags do not generally inflate if the vehicle is involved in a side or rear collision, if it rolls over, or if it is involved in a low-speed frontal collision. But, whenever a collision of any type causes sufficient forward deceleration of the vehicle, deployment of the SRS front airbags may occur.

- Collision from the side
- Collision from the rear
- Vehicle rollover

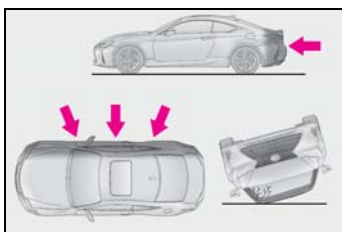

■ Types of collisions that may not deploy the SRS airbags (SRS side and curtain shield airbags)

The SRS side and curtain shield airbags may not activate if the vehicle is subjected to a collision from the side at certain angles, or a collision to the side of the vehicle body other than the passenger compartment.

- Collision from the side to the vehicle body other than the passenger compartment
- Collision from the side at an angle

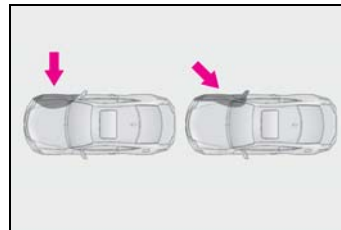

The SRS side airbags do not generally inflate if the vehicle is involved in a rear collision, if it rolls over, or if it is involved in a low-speed side or low-speed frontal collision.

- Collision from the rear
- Vehicle rollover

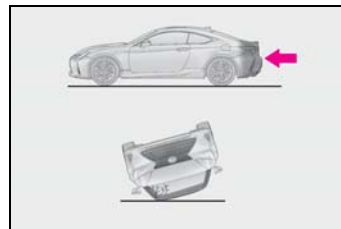

The SRS curtain shield airbags do not generally inflate if the vehicle is involved in a rear collision, if it pitches end over end, or if it is involved in a low-speed side or low-speed frontal collision.

- Collision from the rear
- Pitching end over end

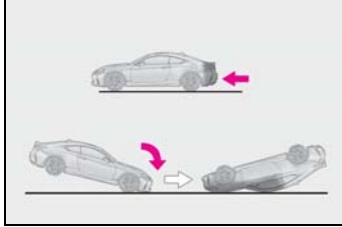

■ When to contact your Lexus dealer

In the following cases, the vehicle will require inspection and/or repair. Contact your Lexus dealer as soon as possible.

- Any of the SRS airbags have been inflated.
- The front of the vehicle is damaged or deformed, or was involved in an accident that was not severe enough to cause the SRS front airbags to inflate.

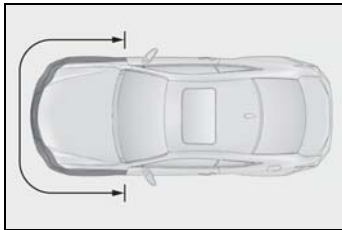

- A portion of a door or its surrounding area is damaged or deformed, or the vehicle was involved in an accident that was not severe enough to cause the SRS side and curtain shield airbags to inflate.

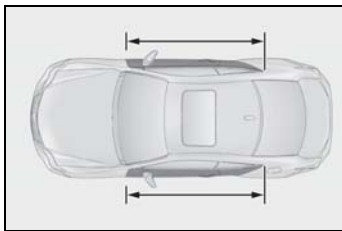

- The pad section of the steering wheel, dashboard near the front passenger airbag or lower portion of the instrument panel is scratched, cracked, or otherwise damaged.

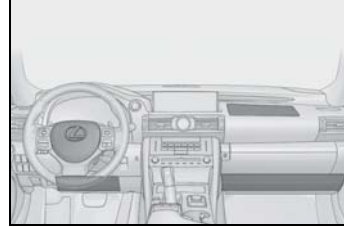

- The surface of the seats with the SRS side airbag is scratched, cracked, or otherwise damaged.

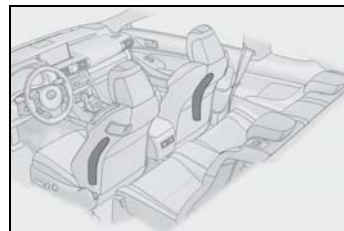

- The portion of the front pillars, rear pillars or roof side rail garnishes (padding) containing the SRS curtain shield airbags inside is scratched, cracked, or otherwise damaged.

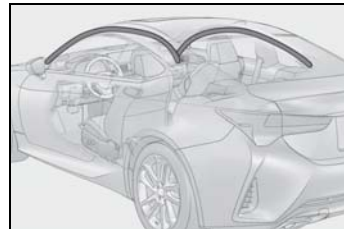

⚠ WARNING

■ SRS airbag precautions

Observe the following precautions regarding the SRS airbags. Failure to do so may cause death or serious injury.

- The driver and all passengers in the vehicle must wear their seat belts properly. The SRS airbags are supplemental devices to be used with the seat belts.

⚠ WARNING

- The SRS driver airbag deploys with considerable force, and can cause death or serious injury especially if the driver is very close to the airbag. The National Highway Traffic Safety Administration (NHTSA) advises: Since the risk zone for the driver's airbag is the first 2 - 3 in. (50 - 75 mm) of inflation, placing yourself 10 in. (250 mm) from your driver airbag provides you with a clear margin of safety. This distance is measured from the center of the steering wheel to your breastbone. If you sit less than 10 in. (250 mm) away now, you can change your driving position in several ways:
 - Move your seat to the rear as far as you can while still reaching the pedals comfortably.
 - Slightly recline the back of the seat. Although vehicle designs vary, many drivers can achieve the 10 in. (250 mm) distance, even with the driver seat all the way forward, simply by reclining the back of the seat somewhat. If reclining the back of your seat makes it hard to see the road, raise yourself by using a firm, non-slippery cushion, or raise the seat if your vehicle has that feature.
 - If your steering wheel is adjustable, tilt it downward. This points the airbag toward your chest instead of your head and neck.

The seat should be adjusted as recommended by NHTSA above, while still maintaining control of the foot pedals, steering wheel, and your view of the instrument panel controls.

- If the seat belt extender has been connected to the front seat belt buckles but the seat belt extender has not also been fastened to the latch plate of the seat belt, the SRS front airbags will judge that the driver and front passenger are wearing the seat belt even though the seat belt has not been connected. In this case, the SRS front airbags may not activate correctly in a collision, resulting in death or serious injury in the event of a collision. Be sure to wear the seat belt with the seat belt extender.

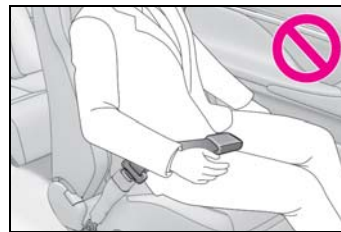

- The SRS front passenger airbag also deploys with considerable force, and can cause death or serious injury especially if the front passenger is very close to the airbag. The front passenger seat should be as far from the airbag as possible with the seatback adjusted, so the front passenger sits upright.
- Improperly seated and/or restrained infants and children can be killed or seriously injured by a deploying airbag. An infant or child who is too small to use a seat belt should be properly secured using a child restraint system. Lexus strongly recommends that all infants and children be placed in the rear seats of the vehicle and properly restrained. The rear seats are safer for infants and children than the front passenger seat. (→P.40)

⚠ WARNING

- Do not sit on the edge of the seat or lean against the dashboard.

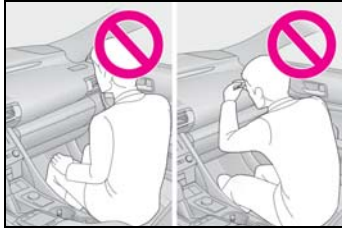

- Do not allow a child to stand in front of the SRS front passenger airbag unit or sit on the knees of a front passenger.

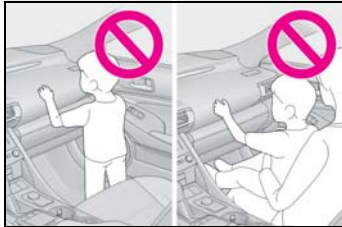

- Do not allow the front seat occupants to hold items on their knees.
- Do not lean against the door, the roof side rail or the front, side and rear pillars.



- Do not allow anyone to kneel on the passenger seats toward the door or put their head or hands outside the vehicle.



- Do not attach anything to or lean anything against areas such as the dashboard, steering wheel pad and lower portion of the instrument panel. These items can become projectiles when the SRS driver, front passenger and knee airbags deploy.

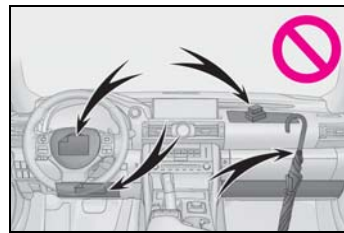

- Do not attach anything to areas such as a door, windshield, side windshield, front or rear pillar, roof side rail and assist grip.

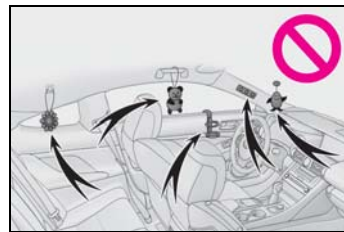

- Do not hang coat hangers or hard objects on the coat hooks. All of these items could become projectiles and may cause death or serious injury, should the SRS curtain shield airbags deploy.

⚠ WARNING

- If a vinyl cover is put on the area where the SRS knee airbag will deploy, be sure to remove it.
- Do not use seat accessories which cover the parts where the SRS side airbags inflate as they may interfere with inflation of the airbags. Such accessories may prevent the side airbags from activating correctly, disable the system or cause the side airbags to inflate accidentally, resulting in death or serious injury.
- Do not strike or apply significant levels of force to the area of the SRS airbag components. Doing so can cause the SRS airbags to malfunction.
- Do not touch any of the component parts immediately after the SRS airbags have deployed (inflated) as they may be hot.
- If breathing becomes difficult after the SRS airbags have deployed, open a door or window to allow fresh air in, or leave the vehicle if it is safe to do so. Wash off any residue as soon as possible to prevent skin irritation.
- If the areas where the SRS airbags are stored, such as the steering wheel pad and front and rear pillar garnishes, are damaged or cracked, have them replaced by your Lexus dealer.
- Do not place anything, such as a cushion, on the front passenger's seat. Doing so will disperse the passenger's weight, which prevents the sensor from detecting the passenger's weight properly. As a result, the SRS front airbags for the front passenger may not deploy in the event of a collision.

■ Modification and disposal of SRS airbag system components

Do not dispose of your vehicle or perform any of the following modifications without consulting your Lexus dealer. The SRS airbags may malfunction or deploy (inflate) accidentally, causing death or serious injury.

- Installation, removal, disassembly and repair of the SRS airbags
- Repairs, modifications, removal or replacement of the steering wheel, instrument panel, dashboard, seats or seat upholstery, front, side and rear pillars or roof side rails
- Repairs or modifications of the front fender, front bumper, or side of the occupant compartment
- Installation of a grille guard (bull bars, kangaroo bar, etc.), snow plows, winches or roof luggage carrier
- Modifications to the vehicle's suspension system
- Installation of electronic devices such as mobile two-way radios and CD players
- Modifications to your vehicle for a person with a physical disability

Front passenger occupant classification system

Your vehicle is equipped with a front passenger occupant classification system. This system detects the conditions of the front passenger seat and activates or deactivates the front passenger airbag and front passenger knee airbag.

System components

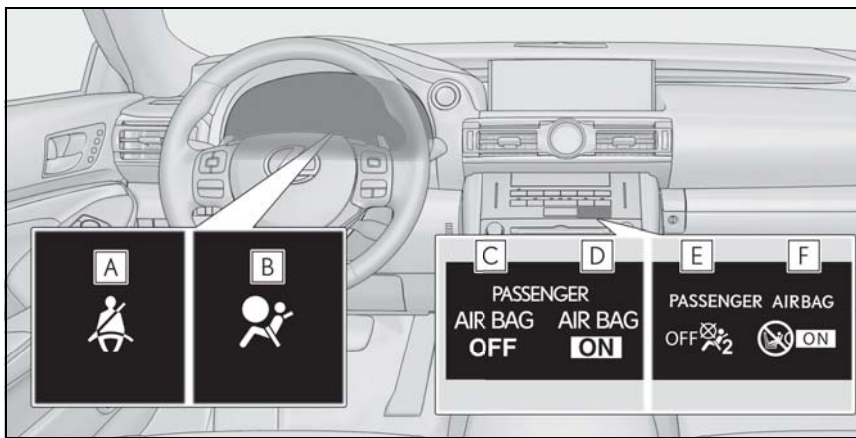

- A** Driver's and front passenger's seat belt reminder light
- B** SRS warning light
 - ▶ For the U.S.A.
- C** "AIR BAG OFF" indicator light
- D** "AIR BAG ON" indicator light
 - ▶ For the Canada
- E** "AIR BAG OFF" indicator light
- F** "AIR BAG ON" indicator light

⚠ WARNING

■ Front passenger occupant classification system precautions

Observe the following precautions regarding the front passenger occupant classification system. Failure to do so may cause death or serious injury.

- Wear the seat belt properly.
- Make sure the front passenger's seat belt plate has not been left inserted into the buckle before someone sits in the front passenger seat.

 **WARNING**

- Make sure the "AIR BAG OFF" indicator light is not illuminated when using the seat belt extender for the front passenger seat. If the "AIR BAG OFF" indicator light is illuminated, disconnect the extender tongue from the seat belt buckle, and reconnect the seat belt. Reconnect the seat belt extender after making sure the "AIR BAG ON" indicator light is illuminated. If you use the seat belt extender while the "AIR BAG OFF" indicator light is illuminated, the SRS airbags for the front passenger may not activate, which could cause death or serious injury in the event of a collision.
- Do not apply a heavy load to the front passenger seat or equipment (e.g. seatback pocket).
- Do not put weight on the front passenger seat by putting your hands or feet on the front passenger seat seatback from the rear passenger seat.
- Do not let a rear passenger lift the front passenger seat with their feet or press on the seatback with their legs.
- Do not put objects under the front passenger seat.
- Do not recline the front passenger seatback so far that it touches a rear seat. This may cause the "AIR BAG OFF" indicator light to be illuminated, which indicates that the SRS airbags for the front passenger will not activate in the event of a severe accident. If the seatback touches the rear seat, return the seatback to a position where it does not touch the rear seat. Keep the front passenger seatback as upright as possible when the vehicle is moving. Reclining the seatback excessively may lessen the effectiveness of the seat belt system.
- If an adult sits in the front passenger seat, the "AIR BAG ON" indicator light is illuminated. If the "AIR BAG OFF" indicator is illuminated, ask the passenger to sit up straight, well back in the seat, feet on the floor, and with the seat belt worn correctly. If the "AIR BAG OFF" indicator still remains illuminated, either ask the passenger to move to the rear seat, or if that is not possible, move the front passenger seat fully rearward.
- When it is unavoidable to install a forward-facing child restraint system on the front passenger seat, install the child restraint system on the front passenger seat in the proper order. (→P.41)
- Do not modify or remove the front seats.
- Do not kick the front passenger seat or subject it to severe impact. Otherwise, the SRS warning light may come on to indicate a malfunction of the front passenger occupant classification system. In this case, contact your Lexus dealer immediately.
- Child restraint systems installed on the rear seat should not contact the front seatbacks.
- Do not use a seat accessory, such as a cushion and seat cover, that covers the seat cushion surface.
- Do not modify or replace the upholstery of the front seat.
- Do not place anything between the console box and front passenger seat. Otherwise, the system may not detect the front passenger properly, leading to improper operation of the airbags.
- Adjust the front passenger seat so that the head restraint does not touch the ceiling. If the head restraint is left in contact with the ceiling, the system may not detect the front passenger properly, leading to improper operation of the airbags.

Condition and operation in the front passenger occupant classification system

■ Adult^{*1}

Indicator/warning light	"AIRBAG ON" and "AIRBAG OFF" indicator lights	"AIR BAG ON"
	SRS warning light	Off
	Driver's and front passenger's seat belt reminder light	Off ^{*2} or flashing ^{*3}
Devices	Front passenger airbag	Activated
	Front passenger knee airbag	

■ Child^{*4}

Indicator/warning light	"AIRBAG ON" and "AIRBAG OFF" indicator lights	"AIR BAG OFF" or "AIR BAG ON" ^{*4}
	SRS warning light	Off
	Driver's and front passenger's seat belt reminder light	Off ^{*2} or flashing ^{*3}
Devices	Front passenger airbag	Deactivated or activated ^{*4}
	Front passenger knee airbag	

■ Child restraint system with infant^{*5}

Indicator/warning light	"AIRBAG ON" and "AIRBAG OFF" indicator lights	"AIR BAG OFF" ^{*6}
	SRS warning light	Off
	Driver's and front passenger's seat belt reminder light	Off ^{*2} or flashing ^{*3}
Devices	Front passenger airbag	Deactivated
	Front passenger knee airbag	

■ Unoccupied

Indicator/warning light	"AIRBAG ON" and "AIRBAG OFF" indicator lights	"AIR BAG OFF"
	SRS warning light	Off
	Driver's and front passenger's seat belt reminder light	
Devices	Front passenger airbag	Deactivated
	Front passenger knee airbag	

■ There is a malfunction in the system

Indicator/warning light	"AIRBAG ON" and "AIRBAG OFF" indicator lights	"AIR BAG OFF"
	SRS warning light	On
	Driver's and front passenger's seat belt reminder light	
Devices	Front passenger airbag	Deactivated
	Front passenger knee airbag	

*1: The system judges a person of adult size as an adult. When a smaller adult sits in the front passenger seat, the system may not recognize him/her as an adult depending on his/her physique and posture.

*2: In the event the front passenger is wearing a seat belt.

*3: In the event the front passenger does not wear a seat belt.

*4: For some children, child in seat, child in booster seat or child in convertible seat, the system may not recognize him/her as a child. Factors which may affect this can be the physique or posture.

*5: Never install a rear-facing child restraint system on the front passenger seat. A forward-facing child restraint system should only be installed on the front passenger seat when it is unavoidable. (→P.40)

*6: In case the indicator light is not illuminated, consult this manual on how to install the child restraint system properly. (→P.41)

Riding with children

Observe the following precautions when children are in the vehicle. Use a child restraint system appropriate for the child, until the child becomes large enough to properly wear the vehicle's seat belt.

- It is recommended that children sit in the rear seats to avoid accidental contact with the shift lever, wiper switch, etc.
- Use the window lock switch to avoid children operating the power window accidentally. (→P.113)
- Do not let small children operate equipment which may catch or pinch body parts, such as the power window, hood, trunk, seats etc.

WARNING

■ When children are in the vehicle

Never leave children unattended in the vehicle, and never allow children to have or use the key.

Children may be able to start the vehicle or shift the vehicle into neutral. There is also a danger that children may injure themselves by playing with the windows, the moon roof or other features of the vehicle. In addition, heat build-up or extremely cold temperatures inside the vehicle can be fatal to children.

Child restraint systems

Before installing a child restraint system in the vehicle, there are precautions that need to be observed, different types of child restraint systems, as well as installation methods, etc., written in this manual.

Use a child restraint system when riding with a small child that cannot properly use a seat belt. For the child's safety, install the child restraint system to a rear seat. Be sure to follow the installation method that is in the operation manual enclosed with the restraint system.

Table of contents

Points to remember: →P.40

Child restraint system: →P.41

When using a child restraint system: →P.42

Child restraint system installation method

- Fixed with a seat belt: →P.44
- Fixed with child restraint LATCH anchors: →P.47
- Using an anchor bracket (for top tether strap): →P.49

Points to remember

The laws of all 50 states of the U.S.A. as well as Canada now require the use of child restraint systems.

- Prioritize and observe the warn-

ings, as well as the laws and regulations for child restraint systems.

- Use a child restraint system appropriate for the child until the child becomes large enough to properly wear the vehicle's seat belt.
- Choose a child restraint system that suits your vehicle and is appropriate to the age and size of the child.

WARNING

■ When a child is riding

Observe the following precautions. Failure to do so may result in death or serious injury.

- For effective protection in automobile accidents and sudden stops, a child must be properly restrained, using a seat belt or child restraint system which is correctly installed. For installation details, refer to the operation manual enclosed with the child restraint system. General installation instruction is provided in this manual.
- Lexus strongly urges the use of a proper child restraint system that conforms to the weight and size of the child, installed on the rear seat. According to accident statistics, the child is safer when properly restrained in the rear seat than in the front seat.

- Holding a child in your or someone else's arms is not a substitute for a child restraint system. In an accident, the child can be crushed against the windshield or between the holder and the interior of the vehicle.

■ Handling the child restraint system

If the child restraint system is not properly fixed in place, the child or other passengers may be seriously injured or even killed in the event of sudden braking, sudden swerving, or an accident.

- If the vehicle were to receive a strong impact from an accident, etc., it is possible that the child restraint system has damage that is not readily visible. In such cases, do not reuse the restraint system.
- Make sure you have complied with all installation instructions provided with the child restraint system manufacturer and that the system is properly secured.
- Keep the child restraint system properly secured on the seat even if it is not in use. Do not store the child restraint system unsecured in the passenger compartment.
- If it is necessary to detach the child restraint system, remove it from the vehicle or store it securely in the trunk.

Child restraint system

■ Types of child restraint system installation methods

Confirm with the operation manual enclosed with the child restraint system about the installation of the child restraint system.

Installation method		Page
Seat belt attachment		P.44
Child restraint LATCH anchors attachment		P.47
Anchor brackets (for top tether strap) attachment		P.49

When using a child restraint system on the front passenger seat

■ When installing a child restraint system to a passenger seat

For the safety of a child, install child restraint systems to a rear seat. When installing child restraint system to a front passenger seat is unavoidable, adjust the passenger seat as follows and install the child restraint system.



- Raise the seatback as much as position
- Move the seat to the rearmost posi-

tion

- Raise the seat to the highest position
- If the head restraint interferes with the installation of the child restraint system, and the head restraint can be removed, remove the head restraint

WARNING

■ When installing a child restraint system

Observe the following when installing child restraint system to the front passenger seat if it is unavoidable. The front passenger SRS airbag inflates with considerable speed and force that if not observed may lead to death or serious injury to the child.

- Never install a rear-facing child restraint system on the front passenger seat even if the "AIR BAG OFF" indicator light is illuminated. In the event of an accident, the force of the rapid inflation of the front passenger airbag can cause death or serious injury to the child if the rear-facing child restraint system is installed on the front passenger seat.
- A forward-facing child restraint system may be installed on the front passenger seat only when it is unavoidable. A child restraint system that requires a top tether strap should not be used in the front passenger seat since there is no top tether strap anchor for the front passenger seat.

- A forward-facing child restraint system may be installed on the front passenger seat only when it is unavoidable. When installing a forward-facing child restraint system on the front passenger seat, adjust the seatback to the most upright position, move the seat to the rearmost position, and raise the seat to the highest position, even if the "AIR BAG OFF" indicator light is illuminated.

If the head restraint interferes with the installation of the child restraint system, and the head restraint can be removed, remove the head restraint.



- Do not allow the child to lean his/her head or any part of his/her body against the door or the area of the seat, front pillars or roof side rails from which the SRS side airbags or SRS curtain shield airbags deploy even if the child is seated in the child restraint system. It is dangerous if the SRS side and curtain shield airbags inflate, and the impact could cause death or serious injury to the child.



- When a booster seat is installed, always ensure that the shoulder belt is positioned across the center of the child's shoulder. The belt should be kept away from the child's neck, but not so that it could fall off the child's shoulder.

⚠ WARNING

- Use child restraint system suitable to the age and size of the child and install it to the rear seat.
- If the driver's seat interferes with the child restraint system and prevents it from being attached correctly, attach the child restraint system to the right-hand rear seat.

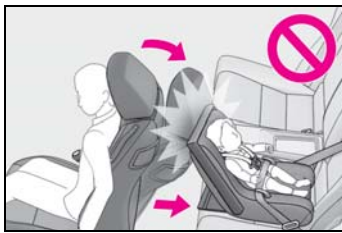

- Adjust the front passenger seat so that it does not interfere with the child restraint system.

Child restraint system fixed with a seat belt

A child restraint system for a small child or baby must itself be properly restrained on the seat with the lap portion of the lap/shoulder belt.

■ Installing child restraint system using a seat belt (child restraint lock function belt)

Install the child restraint system in accordance to the operation manual enclosed with the child restraint system.

■ Rear-facing—Infant seat/convertible seat

- 1 When using the front seat: Adjust the seatback

If there is gap between the child seat and the seatback, adjust the seatback until

good contact is achieved.

- 2 Place the child restraint system on the rear seat facing the rear of the vehicle.

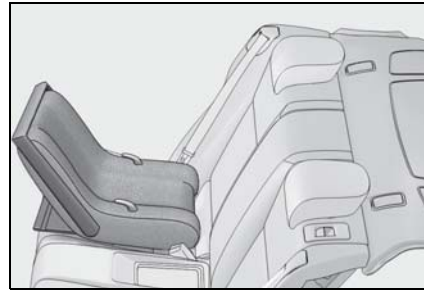

- 3 Run the seat belt through the child restraint system and insert the plate into the buckle. Make sure that the belt is not twisted.

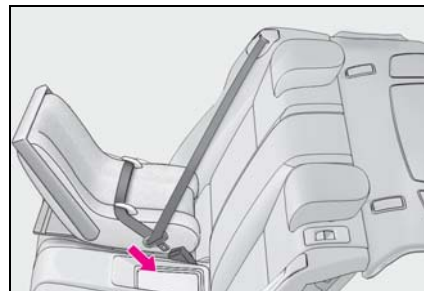

- 4 Fully extend the shoulder belt and allow it to retract to put it in lock mode. In lock mode, the belt cannot be extended.



- 5 While pushing the child restraint system down into the rear seat,

allow the shoulder belt to retract until the child restraint system is securely in place.

After the shoulder belt has retracted to a point where there is no slack in the belt, pull the belt to check that it cannot be extended.

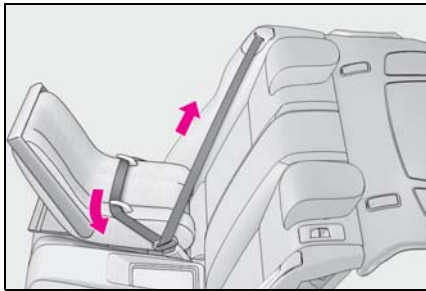

- 6** After installing the child restraint system, rock it back and forth to ensure that it is installed securely.

■ **Forward-facing—Convertible seat**

- 1** When using the front seat: Adjust the seatback

If there is gap between the child seat and the seatback, adjust the seatback until good contact is achieved.

- 2** Remove the head restraint if it interferes with your child restraint system. (→P.105)

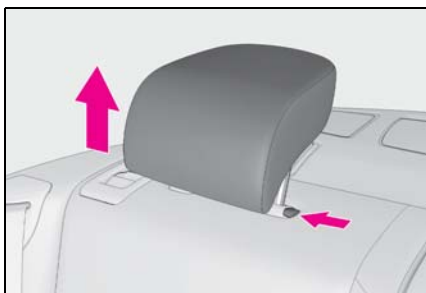

- 3** Place the child restraint system on the seat facing the front of the vehicle.



- 4** Run the seat belt through the child restraint system and insert the plate into the buckle. Make sure that the belt is not twisted.



- 5** Fully extend the shoulder belt and allow it to retract to put it in lock mode. In lock mode, the belt cannot be extended.



- 6** While pushing the child restraint system into the rear seat, allow the shoulder belt to retract until the

child restraint system is securely in place.

After the shoulder belt has retracted to a point where there is no slack in the belt, pull the belt to check that it cannot be extended.

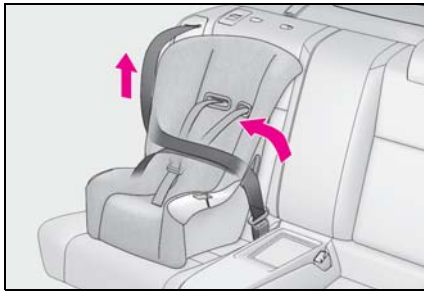

- 7 If the child restraint has a top tether strap, follow the child restraint manufacturer's operation manual regarding the installation, using the top tether strap to latch onto the top tether strap anchor. (→P.49)
- 8 After installing the child restraint system, rock it back and forth to ensure that it is installed securely.

■ Booster seat

- 1 High back type: Remove the head restraint if it interferes with your child restraint system. (→P.105)

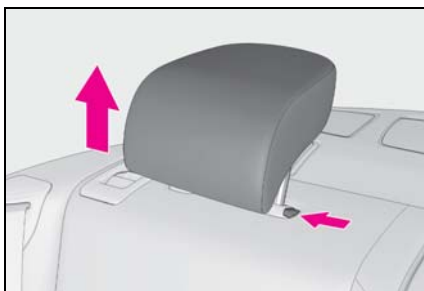

- 2 Place the child restraint system on the seat facing the front of the vehicle.

▶ Booster type



▶ High back type

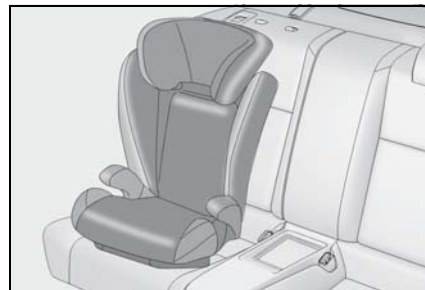

- 3 Sit the child in the child restraint system. Fit the seat belt to the child restraint system according to the manufacturer's instructions and insert the plate into the buckle. Make sure that the belt is not twisted.

Check that the shoulder belt is correctly positioned over the child's shoulder and that the lap belt is as low as possible. (→P.24)



■ Removing a child restraint system installed with a seat belt

Press the buckle release button and fully retract the seat belt.

When releasing the buckle, the child restraint system may spring up due to the rebound of the seat cushion. Release the buckle while holding down the child restraint system.

Since the seat belt automatically reels itself, slowly return it to the stowing position.

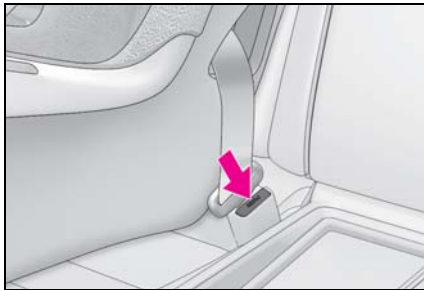

⚠ WARNING

■ When installing a child restraint system

Observe the following precautions. Failure to do so may result in death or serious injury.

- Do not allow children to play with the seat belt. If the seat belt becomes twisted around a child's neck, it may lead to choking or other serious injuries that could result in death. If this occurs and the buckle cannot be unfastened, scissors should be used to cut the belt.
- Ensure that the belt and plate are securely locked and the seat belt is not twisted.
- Shake the child restraint system left and right, and forward and backward to ensure that it has been securely installed.

- After securing a child restraint system, never adjust the seat.

- When a booster seat is installed, always ensure that the shoulder belt is positioned across the center of the child's shoulder. The belt should be kept away from the child's neck, but not so that it could fall off the child's shoulder.

- Follow all installation instructions provided by the child restraint system manufacturer.

■ When installing a booster seat

To prevent the belt from going into ALR lock mode, do not fully extend the shoulder belt. ALR mode causes the belt to tighten only. This could cause injury or discomfort to the child. (→P.26)

■ Do not use a seat belt extender

If a seat belt extender is used when installing a child restraint system, the seat belt will not securely hold the child restraint system, which could cause death or serious injury to the child or other passengers in the event of sudden braking, sudden swerving or an accident.

Child restraint system fixed with child restraint LATCH anchors

■ Child restraint LATCH anchors

LATCH anchors are provided for the each rear seat. (Buttons displaying the location of the anchors are attached to the seats.)

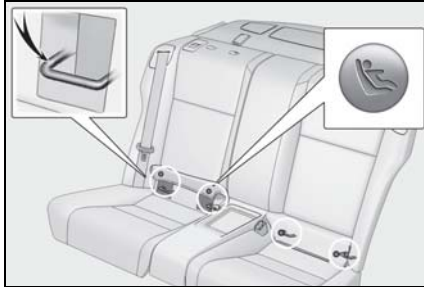

■ Installation with LATCH system

Install the child restraint system in accordance to the operation manual enclosed with the child restraint system.

- 1 Remove the head restraint if it interferes with your child restraint system. (→P.105)

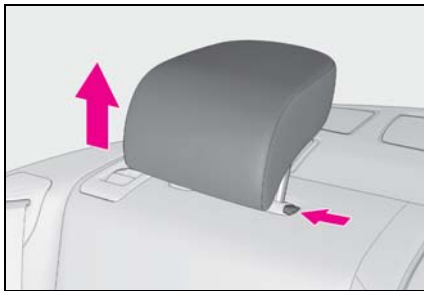

- 2 Flip up and fold the cover, and fix it with the hook-and-loop fastener.

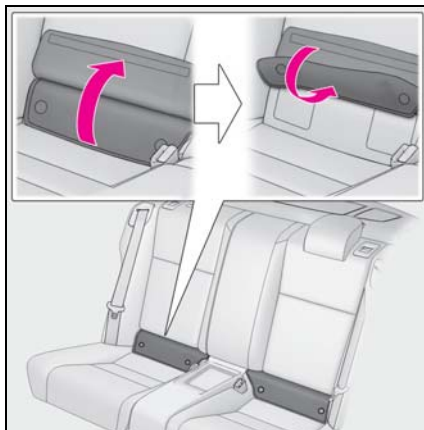

► Type A

- 3 Latch the hooks of the lower straps onto the LATCH anchors.

For owners in Canada:
The symbol on a child restraint system indicates the presence of a lower connector system.

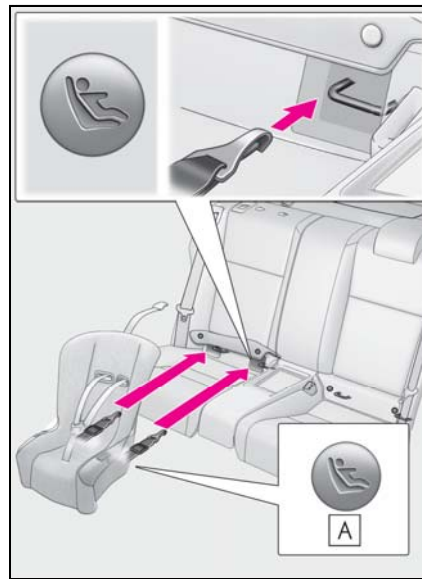

A Canada only

► Type B

- 3 Latch the buckles onto the LATCH anchors.

For owners in Canada:
The symbol on a child restraint system indicates the presence of a lower connector

system.

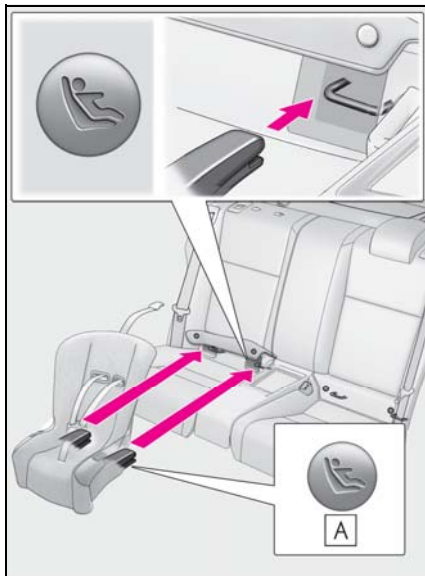

A Canada only

- 4 If the child restraint has a top tether strap, follow the child restraint manufacturer's operation manual regarding the installation, using the top tether strap to latch onto the top tether strap anchor. (→P.49)
- 5 After installing the child restraint system, rock it back and forth to ensure that it is installed securely.

■ Laws and regulations pertaining to anchorages

The LATCH system conforms to FMVSS225 or CMVSS210.2. Child restraint systems conforming to FMVSS213 or CMVSS213 specifications can be used. This vehicle is designed to conform to the SAE J1819.

⚠ WARNING

■ When installing a child restraint system

Observe the following precautions. Failure to do so may result in death or serious injury.

- Shake the child restraint system left and right, and forward and backward to ensure that it has been securely installed.
- After securing a child restraint system, never adjust the seat.
- When using the LATCH anchors, be sure that there are no foreign objects around the anchors and that the seat belt is not caught behind the child restraint system.
- Follow all installation instructions provided by the child restraint system manufacturer.

Using an anchor bracket (for top tether strap)

■ Anchor brackets (for top tether strap)

Anchor brackets are provided for the each rear seat.

Use anchor brackets when fixing the top tether strap.

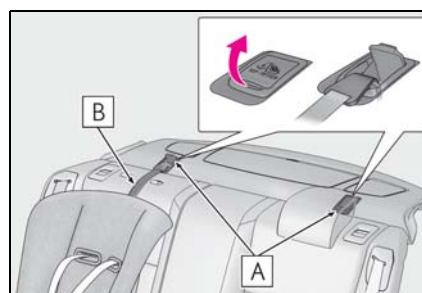

A Anchor brackets

B Top tether strap

■ Fixing the top tether strap to the anchor bracket

Install the child restraint system in accordance to the operation manual enclosed with the child restraint system.

- 1 Adjust the head restraint to the upmost position.

If the head restraint interferes with the child restraint system installation and the head restraint can be removed, remove the head restraint. (→P.105)

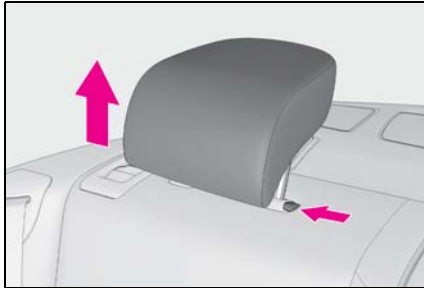

- 2 Open the anchor bracket cover, latch the hook onto the anchor bracket and tighten the top tether strap.

Make sure the top tether strap is securely latched. (→P.47)

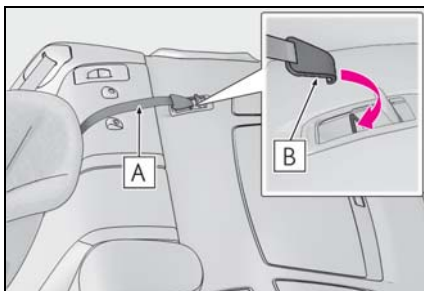

A Top tether strap

B Hook

■ Laws and regulations pertaining to anchorages

The LATCH system conforms to FMVSS225 or CMVSS210.2.

Child restraint systems conforming to FMVSS213 or CMVSS213 specifications can be used.

This vehicle is designed to conform to the SAE J1819.

⚠ WARNING

■ When installing a child restraint system

Observe the following precautions. Failure to do so may result in death or serious injury.

- Firmly attach the top tether strap and make sure that the belt is not twisted.
- Do not attach the top tether strap to anything other than the anchor bracket.
- Shake the child restraint system left and right, and forward and backward to ensure that it has been securely installed.
- After securing a child restraint system, never adjust the seat.
- Follow all installation instructions provided by the child restraint system manufacturer.

⚠ NOTICE

■ Anchor brackets (for top tether strap)

When not in use, make certain to close the lid. If it remains open, the lid may be damaged.

Exhaust gas precautions

Harmful substance to the human body is included in exhaust gases if inhaled.

WARNING

Exhaust gases include harmful carbon monoxide (CO), which is colorless and odorless. Observe the following precautions.

Failure to do so may cause exhaust gases enter the vehicle and may lead to an accident caused by light-headedness, or may lead to death or a serious health hazard.

■ Important points while driving

- Keep the trunk lid closed.
- If you smell exhaust gases in the vehicle even when the trunk lid is closed, open the windows and have the vehicle inspected at your Lexus dealer as soon as possible.

■ When parking

- If the vehicle is in a poorly ventilated area or a closed area, such as a garage, stop the engine.
- Do not leave the vehicle with the engine on for a long time.
If such a situation cannot be avoided, park the vehicle in an open space and ensure that exhaust fumes do not enter the vehicle interior.
- Do not leave the engine running in an area with snow build-up, or where it is snowing. If snowbanks build up around the vehicle while the engine is running, exhaust gases may collect and enter the vehicle.

■ Exhaust pipe

The exhaust system needs to be checked periodically. If there is a hole or crack caused by corrosion, damage to a joint or abnormal exhaust noise, be sure to have the vehicle inspected and repaired by your Lexus dealer.

Lexus Enform Safety Connect*

*: If equipped

Safety Connect is a subscription-based telematics service that uses Global Positioning System (GPS) data and embedded cellular technology to provide safety and security features to subscribers. Safety Connect is supported by Lexus' designated response center, which operates 24 hours per day, 7 days per week.

Safety Connect service is available by subscription on select, telematics hardware-equipped vehicles.

By using the Safety Connect service, you are agreeing to be bound by the Telematics Subscription Service Agreement and its Terms and Conditions, as in effect and amended from time to time, a current copy of which is available at Lexus.com. All use of the Safety Connect service is subject to such then-applicable Terms and Conditions.

System components

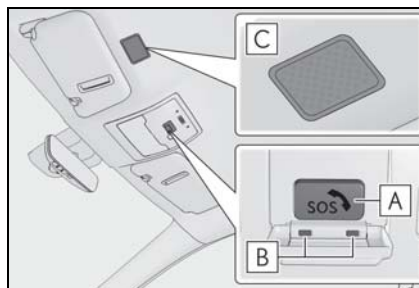

- A** "SOS" button
- B** LED light indicators
- C** Microphone

Services

Subscribers have the following Safety Connect services available:

- **Automatic Collision Notification***
Helps drivers receive necessary response from emergency service providers. (→P.54)
*: U.S. Patent No. 7,508,298 B2
- **Stolen Vehicle Location**
Helps drivers in the event of vehicle theft. (→P.54)
- **Emergency Assistance Button ("SOS")**
Connects drivers to response-center support. (→P.54)
- **Enhanced Roadside Assistance**
Provides drivers various on-road assistance. (→P.54)

Subscription

After you have signed the Telematics

Subscription Service Agreement and are enrolled, you can begin receiving services.

A variety of subscription terms is available for purchase. Contact your Lexus dealer, call the following or push the "SOS" button in your vehicle for further subscription details.

- The United States
1-800-25-LEXUS
(1-800-255-3987)
- Canada
1-800-26-LEXUS
(1-800-265-3987)
- Puerto Rico
1-877-539-8777

■ Safety Connect Services Information

- Phone calls using the vehicles Bluetooth® technology will not be possible during Safety Connect.
- Safety Connect is available beginning Fall 2009 on select Lexus models (in the contiguous United States only). Contact with the Safety Connect response center is dependent upon the telematics device being in operative condition, cellular connection availability, and GPS satellite signal reception, which can limit the ability to reach the response center or receive emergency service support. Enrollment and Telematics Subscription Service Agreement required. A variety of subscription terms is available; charges vary by subscription term selected and location.
- Automatic Collision Notification, Emergency Assistance and Stolen Vehicle Location will function in the United States, including Hawaii and Alaska, Puerto Rico and in Canada, and Enhanced Roadside Assistance will function in the United States, Puerto Rico and in Canada.
- Automatic Collision Notification, Emer-

gency Assistance, Stolen Vehicle and Enhanced Road Assistance will not function in the United States Virgin Islands. For vehicles first sold in the USVI, no Safety Connect services will function in and outside the United States Virgin Islands.

- Safety Connect services are not subject to section 255 of the Telecommunications Act and the device is not TTY compatible.

■ Languages

The Safety Connect response center will offer support in multiple languages. The Safety Connect system will offer voice prompts in English, Spanish, and French. Please indicate your language of choice when enrolling.

■ When contacting the response center

You may be unable to contact the response center if the network is busy.

Safety Connect LED light Indicators

When the engine switch is turned to IGNITION ON mode, the red indicator light comes on for 2 seconds then turns off. Afterward, the green indicator light comes on, indicating that the service is active.

The following indicator light patterns indicate specific system usage conditions:

- Green indicator light on = Active service
- Green indicator light flashing = Safety Connect call in process
- Red indicator light (except at vehicle start-up) = System malfunction (contact your Lexus dealer)
- No indicator light (off) = Safety

Connect service not active

Safety Connect services

■ Automatic Collision Notification

In case of either airbag deployment or severe rear-end collision, the system is designed to automatically call the response center. The responding agent receives the vehicle's location and attempts to speak with the vehicle occupants to assess the level of emergency. If the occupants are unable to communicate, the agent automatically treats the call as an emergency, contacts the nearest emergency services provider to describe the situation, and requests that assistance be sent to the location.

■ Stolen Vehicle Location

If your vehicle is stolen, Safety Connect can work with local authorities to assist them in locating and recovering the vehicle. After filing a police report, call the Safety Connect response center at 1-800-25-LEXUS (1-800-255-3987) in the United States, 1-877-539-8777 in Puerto Rico or 1-800-265-3987 in Canada, and follow the prompts for Safety Connect to initiate this service.

In addition to assisting law enforcement with recovery of a stolen vehicle, Safety-Connect-equipped vehicle location data may, under certain circumstances, be shared with third parties to locate your vehicle. Further information is available at Lexus.com.

■ Emergency Assistance Button ("SOS")

In the event of an emergency on the road, push the "SOS" button to reach the Safety Connect response center. The answering agent will determine your vehicle's location, assess the emergency, and dispatch the necessary assistance required.

If you accidentally press the "SOS" button, tell the response-center agent that you are not experiencing an emergency.

■ Enhanced Roadside Assistance

Enhanced Roadside Assistance adds GPS data to the already included warranty-based Lexus roadside service.

Subscribers can press the "SOS" button to reach a Safety Connect response-center agent, who can help with a wide range of needs, such as: towing, flat tire, fuel delivery, etc. For a description of the Roadside Assistance services and their limitations, please see the Safety Connect Terms and Conditions, which are available at Lexus.com.

Safety information for Safety Connect

Important! Read this information about exposure to radio frequency signals before using Safety Connect;

The Safety Connect system installed in your vehicle is a low-power radio transmitter and receiver. It receives and also sends out radio frequency (RF) signals.

In August 1996, the Federal Commu-

nications Commission (FCC) adopted RF exposure guidelines with safety levels for mobile wireless phones. Those guidelines are consistent with the safety standards previously set by the following U.S. and international standards bodies.

- ANSI (American National Standards Institute) C95.1 [1992]
- NCRP (National Council on Radiation Protection and Measurement) Report 86 [1986]
- ICNIRP (International Commission on Non-Ionizing Radiation Protection) [1996]

Those standards were based on comprehensive and periodic evaluations of the relevant scientific literature. Over 120 scientists, engineers, and physicians from universities, and government health agencies and industries reviewed the available body of research to develop the ANSI Standard (C95.1).

The design of Safety Connect complies with the FCC guidelines in addition to those standards.

Engine immobilizer system

The vehicle's keys have built-in transponder chips that prevent the engine from starting if a key has not been previously registered in the vehicle's on-board computer.

Never leave the keys inside the vehicle when you leave the vehicle.

This system is designed to help prevent vehicle theft but does not guarantee absolute security against all vehicle thefts.

Operating the system

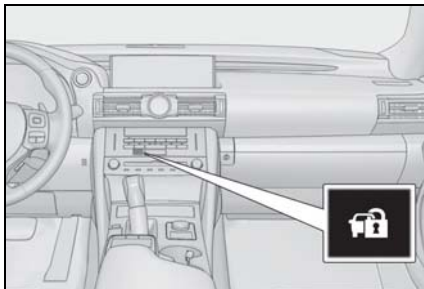

The indicator light flashes after the engine switch has been turned off to indicate that the system is operating.

The indicator light stops flashing after the engine switch has been turned to ACCESSORY or IGNITION ON mode to indicate that the system has been canceled.

System maintenance

The vehicle has a maintenance-free type engine immobilizer system.

Conditions that may cause the system to malfunction

- If the grip portion of the key is in contact with a metallic object
- If the key is in close proximity to or touching a key registered to the security system (key with a built-in transponder chip) of another vehicle

NOTICE

To ensure the system operates correctly

Do not modify or remove the system. If modified or removed, the proper operation of the system cannot be guaranteed.

Alarm

The alarm uses light and sound to give an alert when an intrusion is detected.

The alarm is triggered in the following situations when the alarm is set:

- Except for Canada: A locked door is unlocked or opened in any way other than using the entry function, wireless remote control or mechanical key. (The doors will lock again automatically.)
- For Canada: A locked door is unlocked or opened in any way other than using the entry function or wireless remote control. (The doors will lock again automatically.)
- The trunk is opened in any way other than using the entry function or wireless remote control.
- The hood is opened.

Setting/canceling/stopping the alarm system

■ Items to check before locking the vehicle

To prevent unexpected triggering of the alarm and vehicle theft, make sure of the following:

- Nobody is in the vehicle.
- The windows and moon roof (if equipped) are closed before the alarm is set.
- No valuables or other personal

items are left in the vehicle.

■ Setting

Close the doors, trunk and hood, and lock both side doors. The system will be set automatically after 30 seconds.

The indicator light changes from being on to flashing when the system is set.

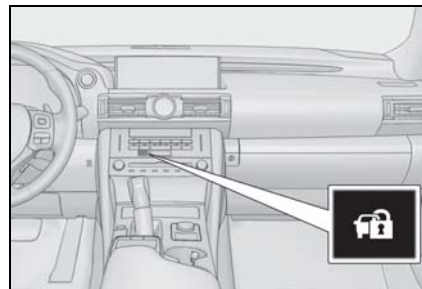

■ Canceling or stopping

Do one of the following to deactivate or stop the alarms:

- Unlock the doors.
- Open the trunk using the entry function or wireless remote control.
- Turn the engine switch to ACCESSORY or IGNITION ON mode, or start the engine. (The alarm will be deactivated or stopped after a few seconds.)

■ System maintenance

The vehicle has a maintenance-free type alarm system.

■ Triggering of the alarm

The alarm may be triggered in the following situations: (Stopping the alarm deactivates the alarm system.)

- For Canada: The doors are unlocked using the mechanical key.

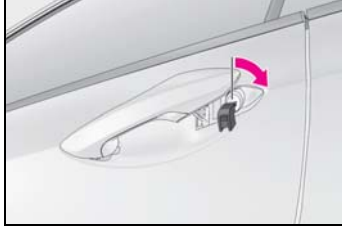

- The trunk is opened using the mechanical key.

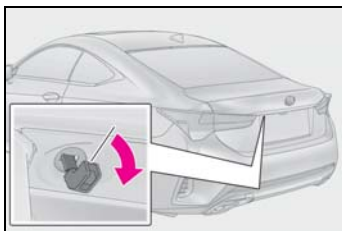

- A person inside the vehicle opens a door, the trunk or hood, or unlocks the vehicle using an inside lock button.



- The battery is recharged or replaced when the vehicle is locked. (→P.321)

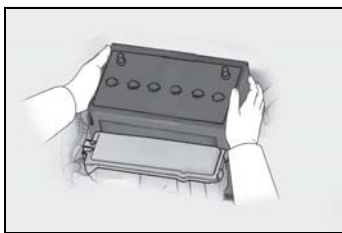

■ Alarm-operated door lock

In the following cases, depending on the situation, the door may automatically lock to prevent improper entry into the vehicle:

- When a person remaining in the vehicle unlocks the door and the alarm is activated.
- While the alarm is activated, a person

remaining in the vehicle unlocks the door.

- When recharging or replacing the battery



NOTICE

■ To ensure the system operates correctly

Do not modify or remove the system. If modified or removed, the proper operation of the system cannot be guaranteed.

**Theft prevention labels
(U.S.A.)**

These labels are attached to the vehicle to reduce vehicle theft by facilitating the tracing and recovery of parts from stolen vehicles. Do not remove under penalty of law.



**Vehicle status information
and indicators**

2

61

2-1. Instrument cluster

Warning lights and indicators **62**
Gauges and meters **66**
Multi-information display **71**
Fuel consumption information **79**

2

Vehicle status information and indicators

Warning lights and indicators

The warning lights and indicators on the instrument cluster, center panel and outside rear view mirrors inform the driver of the status of the vehicle's various systems.

Warning lights and indicators displayed on the instrument cluster

For the purpose of explanation, the following illustrations display all warning lights and indicators illuminated.

- ▶ Except F SPORT models















- ▶ F SPORT models















The units used on the meters and some indicators may differ depending on the target region.

Warning lights

Warning lights inform the driver of malfunctions in the indicated vehicle systems.

-  Brake system warning light*¹
(U.S.A.) (→P.295)
-  Brake system warning light*¹
(red) (→P.295)
(Canada)
-  Brake system warning light*¹
(yellow) (→P.295)
-  High coolant temperature warning light*² (→P.295)
-  Charging system warning light*³ (→P.296)
-  Low engine oil pressure warning light*² (→P.296)
-  Malfunction indicator lamp*¹
(U.S.A.) (→P.296)
-  Malfunction indicator lamp*¹
(Canada) (→P.296)
-  SRS warning light*¹ (→P.296)
-  ABS warning light*¹ (→P.297)
(U.S.A.)
-  ABS warning light*¹ (→P.297)
(Canada)
-  Parking brake warning light
(flashes) (→P.300)
(U.S.A.)

-  Parking brake warning light
(flashes) (→P.300)
(Canada)
-  Brake hold operated indicator*¹
(flashes) (→P.295)
-  Brake Override System warning light/Drive-Start Control warning light*² (→P.297)
-  Electric power steering system warning light*¹ (→P.297)
-  LDA (Lane Departure Alert) indicator (→P.298)
(orange)
-  PCS warning light*¹ (→P.298)
(flashes or illuminates)
-  Slip indicator*¹ (→P.298)
-  Open door warning light
(→P.299)
-  Low fuel level warning light
(→P.299)
-  Driver's and front passenger's seat belt reminder light
(→P.299)
-  Rear passenger's seat belt reminder lights*⁴ (→P.299)
-  Master warning light*¹
(→P.300)
-  Tire pressure warning light*¹
(→P.300)

*¹: These lights turn on when the engine switch is turned to IGNITION ON mode to indicate that a system check is being performed. They will turn off after the engine is started, or after a few seconds. There may be a malfunction in a system if a light does not come on, or turn off. Have the vehicle inspected by your Lexus dealer.

*2: This light illuminates on the multi-information display.

*3: Except F SPORT models: This light illuminates on the multi-information display.
F SPORT models: This light illuminates on the meter.

*4: This light illuminates on the center panel.







⚠ WARNING

















■ If a safety system warning light does not come on

Should a safety system light such as the ABS and SRS warning light not come on when you start the engine, this could mean that these systems are not available to help protect you in an accident, which could result in death or serious injury. Have the vehicle inspected by your Lexus dealer immediately if this occurs.

Indicators

The indicators inform the driver of the operating state of the vehicle's various systems.

-  Turn signal indicator (→P.136)
-  Headlight indicator (→P.142) (U.S.A.)
-  Tail light indicator (→P.142) (Canada)
-  Headlight high beam indicator (→P.143)
-  Automatic High Beam indicator*1 (→P.144)
-  PCS warning light*1,2 (→P.164)
-  Cruise control indicator (→P.182)

-  Dynamic radar cruise control indicator (→P.176)
-  Cruise control "SET" indicator (→P.176)
-  LDA (Lane Departure Alert) indicator (→P.171) (white)
-  LDA (Lane Departure Alert) indicator (→P.171) (green)
-  LDA (Lane Departure Alert) indicator (→P.171) (orange) (flashes)
-  BSM (Blind Spot Monitor) outside rear view mirror indicators*3,4 (if equipped) (→P.191)
-  Intuitive parking assist indicator (if equipped) (→P.185)
-  Slip indicator*1 (→P.202) (flashes)
-  VSC OFF indicator*1,2 (→P.202)
-  Parking brake indicator (→P.137) (U.S.A.)
-  Parking brake indicator (→P.137) (Canada)
-  Brake hold standby indicator*1 (→P.139)
-  Brake hold operated indicator*1 (→P.139)
-  Security indicator*5 (→P.56, 57)
-  Low outside temperature indicator*6 (→P.66)
-  Eco Driving Indicator Light*1 (→P.74)

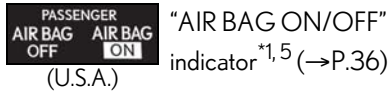

(U.S.A.)

"AIR BAG ON/OFF" indicator^{*1,5} (→P.36)

(Canada)

"AIR BAG ON/OFF" indicator^{*1,5} (→P.36)

- Drive mode indicators

- ▶ Except F SPORT models

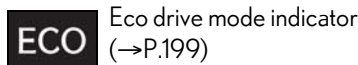

Eco drive mode indicator (→P.199)



"SPORT" indicator (→P.199)

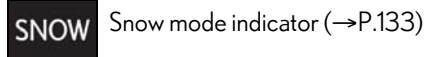

Snow mode indicator (→P.133)

- ▶ F SPORT models

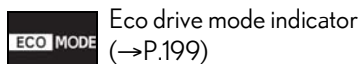

Eco drive mode indicator (→P.199)



"SPORT S" indicator (→P.199)



"SPORT S+" indicator (→P.199)



"CUSTOM" indicator (→P.199)

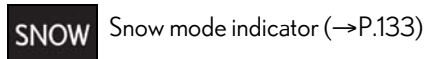

Snow mode indicator (→P.133)

^{*1}: These lights turn on when the engine switch is turned to IGNITION ON mode to indicate that a system check is being performed. They will turn off after the engine is started, or after a few seconds. There may be a malfunction in a system if a light does not come on, or turn off. Have the vehicle inspected by your Lexus dealer.

^{*2}: The light comes on when the system is turned off.

^{*3}: In order to confirm operation, the BSM outside rear view mirror indicators illuminate in the following situations:

- When the engine switch is turned to

IGNITION ON mode while the BSM main switch is turned on.

- When the BSM main switch is turned on while the engine switch is in IGNITION ON mode.

If the system is functioning correctly, the BSM outside rear view mirror indicators will turn off after a few seconds. If the BSM outside rear view mirror indicators do not illuminate or do not turn off, there may be a malfunction in the system. If this occurs, have the vehicle inspected by your Lexus dealer.

^{*4}: This light illuminates on the outside rear view mirrors.

^{*5}: This light illuminates on the center panel.

^{*6}: When the outside temperature is approximately 37°F (3°C) or lower, this indicator will flash for approximately 10 seconds, then stay on.

Gauges and meters

Meter display

■ Locations of gauges and meters (except F SPORT models)

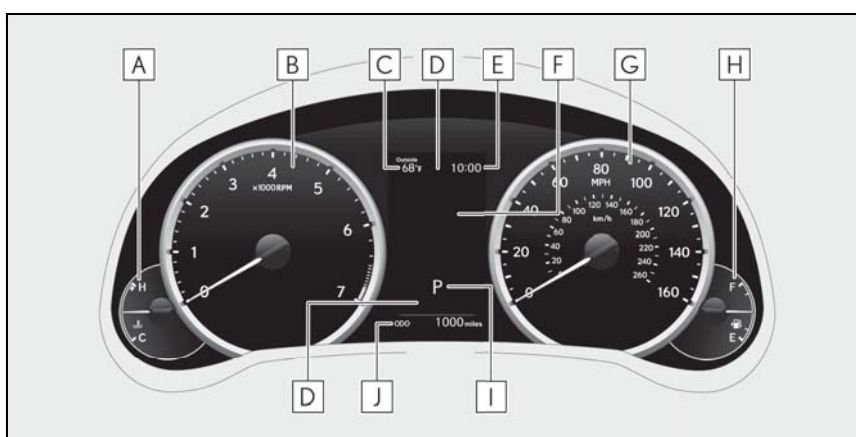

A Engine coolant temperature gauge

Displays the engine coolant temperature

B Tachometer

Displays the engine speed in revolutions per minute

C Outside temperature

Displays the outside temperature within the range of -40°F (-40°C) to 122°F (50°C). Low outside temperature indicator comes on when the ambient temperature is 37°F (3°C) or lower.

D Background color of drive mode

Background color changes according to the drive mode. (→P.199)

- Sport mode: Red
- Eco mode: Blue

E Clock

Time displayed is linked to the analog clock on the instrument panel. (→P.230)

F Multi-information display

Presents the driver with a variety of vehicle data (→P.71)

Displays warning messages in case of a malfunction (→P.303)

G Speedometer

H Fuel gauge

I Shift position/shift range/gear position (→P.131, 133)

J Odometer and trip meter display (→P.70)

■ **Locations of gauges and meters (F SPORT models)**

When the main meter is moved to the right, some of the meter displays and the gauge layout will change.

The units used on the meters may differ depending on the target region.

► Main meter in center position

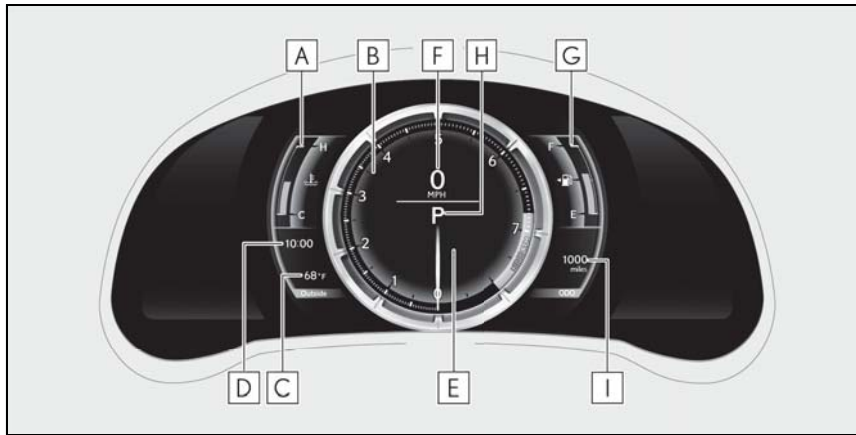

A Engine coolant temperature gauge

Displays the engine coolant temperature

B Tachometer

Displays the engine speed in revolutions per minute

When sport mode is selected for the driving mode, the periphery of the tachometer will change color and the scale of the tachometer will be emphasized.

C Outside temperature

Displays the outside temperature within the range of -40°F (-40°C) to 122°F (50°C). Low outside temperature indicator comes on when the ambient temperature is 37°F (3°C) or lower.

D Clock

Time displayed is linked to the analog clock on the instrument panel. (→P.230)

E Multi-information display

Presents the driver with a variety of vehicle data (→P.71)

Displays warning messages in case of a malfunction (→P.303)

F Speedometer

G Fuel gauge

H Shift position/shift range/gear position (→P.131, 133)

I Odometer and trip meter display (→P.70)

▶ Main meter moved to the right

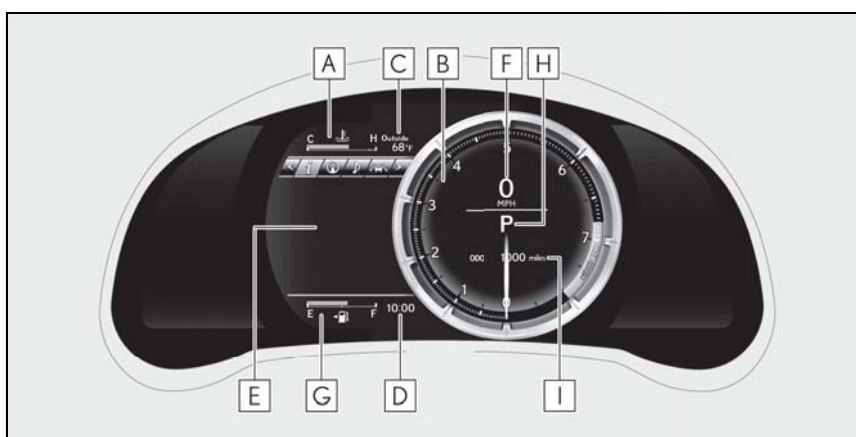

A Engine coolant temperature gauge

Displays the engine coolant temperature

B Tachometer

Displays the engine speed in revolutions per minute

When sport mode is selected for the driving mode, the periphery of the tachometer will change color and the scale of the tachometer will be emphasized.

C Outside temperature

Displays the outside temperature within the range of -40°F (-40°C) to 122°F (50°C). Low outside temperature indicator comes on when the ambient temperature is 37°F (3°C) or lower.

D Clock

Time displayed is linked to the analog clock on the instrument panel. (→P.230)

E Multi-information display

Presents the driver with a variety of vehicle data (→P.71)

Displays warning messages in case of a malfunction (→P.303)

F Speedometer

G Fuel gauge

H Shift position/shift range/gear position (→P.131, 133)



I Odometer and trip meter display (→P.70)

■ **Speed indicator (F SPORT models)**

indicators will be displayed on both sides of the displayed speed unit.

When the vehicle reaches a set speed,



- The indicators will be displayed in yellow (corresponding to a speed set by a user) or red (fixed at 100 mph[160 km/h])^{*}.
- The desired vehicle speed at which the speed indicator will begin to be displayed can be set in  of the multi-information display. (→P.76)
- The default setting of the indicator is off. This setting can be changed in  of the multi-information display. (→P.76)

^{*}: Always observe the legal speed limit when driving on public roads.

■ Rev indicator (F SPORT models)

When the engine speed reaches a set speed, a ring-shaped indicator will be displayed on the tachometer.



The desired engine speed at which the Rev indicator will begin to be displayed can be set on  of the multi-information display.

(→P.76)

■ Rev peak (F SPORT models)

The engine speed reaches or exceeds 5000 rpm, an afterimage of the tachometer will be displayed at the highest engine speed for approximately 0.5 seconds.



Changing the main meter location (F SPORT models)

Moves between center and right-side positions.

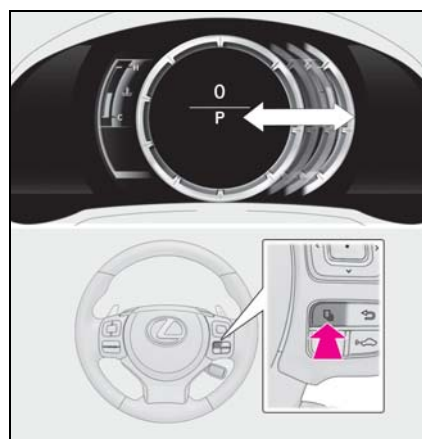

■ The meters and display illuminate when

The engine switch is in IGNITION ON mode.

■ Outside temperature display

- In the following situations, the correct

outside temperature may not be displayed, or the display may take longer than normal to change:

- When stopped, or driving at low speeds (less than 12 mph [20 km/h])
- When the outside temperature has changed suddenly (at the entrance/exit of a garage, tunnel, etc.)
- When “_ _” or “E” is displayed, the system may be malfunctioning. Take your vehicle to your Lexus dealer.

■ Pop-up display

- In some situations, such as when a switch operation is performed, a pop-up display will be temporarily displayed on the multi-information display or the odometer/trip meter screen (F SPORT models).
- Some pop-up displays can be set on/off. (→P.76)

■ Customization

The meter display can be customized on the multi-information display. (→P.351)

⚠ WARNING

■ The information display at low temperatures

Allow the interior of the vehicle to warm up before using the liquid crystal information display. At extremely low temperatures, the information display monitor may respond slowly, and display changes may be delayed.

For example, there is a lag between the driver's shifting and the new gear number appearing on the display. This lag could cause the driver to downshift again, causing rapid and excessive engine braking and possibly an accident resulting in death or injury.

⚠ NOTICE

■ To prevent damage to the engine and its components

- Do not let the indicator needle of the tachometer enter the red zone, which indicates the maximum engine speed.

- The engine may be overheating if the engine coolant temperature gauge is in the red zone (H). In this case, immediately stop the vehicle in a safe place, and check the engine after it has cooled completely. (→P.322)

Odometer and trip meter display

■ Display items

● Odometer

Displays the total distance the vehicle has been driven.

● Trip meter A/trip meter B

Displays the distance the vehicle has been driven since the meter was last reset. Trip meters A and B can be used to record and display different distances independently.

● Distance until next engine oil change

Displays the distance the vehicle can be driven until an oil change is necessary.

■ Changing the display

Each time the “ODO TRIP” switch is pressed, the displayed item will be changed. When the trip meter is displayed, pressing and holding the switch will reset the trip meter.

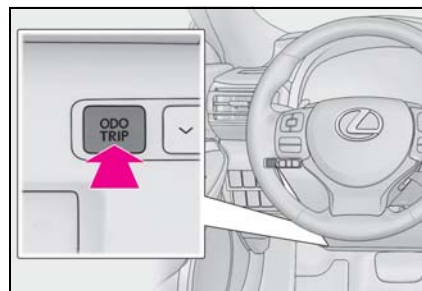

■ Pop-up display

In some situations the following will be temporarily displayed:

- Distance until next engine oil change

Distance until the next engine oil change will be displayed when a warning message indicating that oil maintenance should be performed soon or is required is displayed.

Changing the instrument panel light brightness

The brightness of the instrument panel lights can be adjusted.

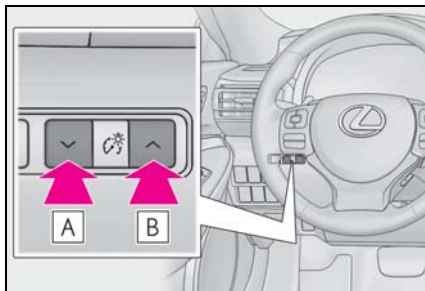

- A** Darker
- B** Brighter

■ Instrument panel brightness adjustment

The instrument panel brightness levels when the tail lights are on and off can be adjusted individually. However, when the surroundings are bright (daytime, etc.), turning on the tail lights will not change the instrument panel brightness.

At this time, any adjustments made to the instrument panel brightness levels will be applied to both settings at once.

Multi-information display

The multi-information display presents the driver with a variety of vehicle data.

Displays and menu icons

- ▶ Except F SPORT models

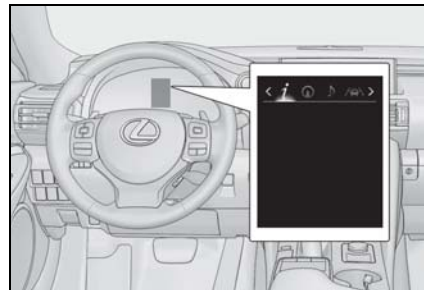



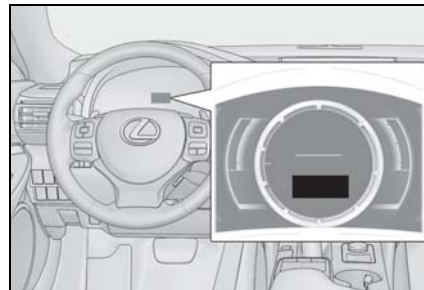

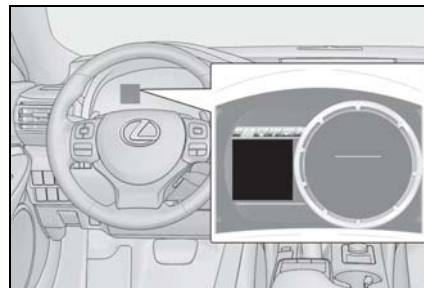

- ▶ F SPORT models (main meter in center position)



- ▶ F SPORT models (main meter moved to the right)



■ Menu icons

	Drive information
	Navigation system-linked display (if equipped)
	Audio system-linked display
	Driving assist system information
	Warning message display
	Settings display

■ Liquid crystal display

→P.70

! WARNING

■ The multi-information display at low temperatures

Allow the interior of the vehicle to warm up before using the liquid crystal information display. At extremely low temperatures, the information display monitor may respond slowly, and display changes may be delayed.

For example, there is a lag between the driver's shifting and the new gear number appearing on the display. This lag could cause the driver to downshift again, causing rapid and excessive engine braking and possibly an accident resulting in death or injury.

Changing the meter display

The multi-information display is operated using the meter control switches.

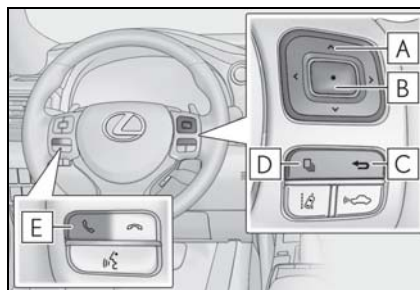

A Select an item/change pages

B Press: Enter/Set
Press and hold: Reset

C Return to the previous screen
Pressing and holding the switch will display the first screen of the selected menu icon.

▶ Except F SPORT models

D Press: Display the top screen
Press and hold: Register current screen as the top screen

E Call sending/receiving and history display

Linked with the hands-free system, sending or receiving call is displayed. For details regarding the hands-free system, refer to "NAVIGATION AND MULTIMEDIA SYSTEM OWNER'S MANUAL".

▶ F SPORT models

D Move the main meter

E Call sending/receiving and history display

Linked with the hands-free system, sending or receiving call is displayed. For details regarding the hands-free system, refer to "NAVIGATION AND MULTIMEDIA SYSTEM OWNER'S MANUAL".

■ Registering a top screen (except F SPORT models)

The displayed top screen can be

changed to a registered screen of your choice.





To register a screen as the top screen, display the desired screen and press and hold .

Drive information

■ Content displayed as drive information

Select to display various drive data.

Up to 2 of the following items can be selected for each drive information screen:

Items displayed can be switched by pressing  or  of the meter control switches to select  and pressing  or .

F SPORT models: When the main meter is in the center position, only one item will be displayed at a time.

F SPORT models: Some drive information items can only be displayed when the main meter is in the center position or when it is moved to the right.

● Current fuel consumption

Displays instantaneous current fuel consumption

● Average fuel economy

- After reset: Displays average fuel consumption since display reset ^{*1,2}
- After start: Displays average fuel consumption since engine start ^{*2}
- After refuel: Displays average fuel consumption since refuel ^{*2,3}

● Average vehicle speed

- After reset: Displays average vehicle speed since display reset ^{*1}
- After start: Displays average vehicle speed since engine start
- Elapsed time
- After reset: Displays elapsed time since the display was reset ^{*1}
- After start: Displays elapsed time since engine start
- Distance
- Driving range: Displays driving range with remaining fuel ^{*3,4}
- After start: Displays drive distance since vehicle start

● Other

Blank: No item

^{*1}: The function can be reset by pressing the  of the meter control switches for longer than 1 second when the item to reset is displayed.

If there is more than one item that can be reset, the item selection screen will appear.

^{*2}: Use the displayed fuel consumption as a reference.

^{*3}: When only a small amount of fuel is added to the tank, the display may not be updated. When refueling, turn the engine switch off. If the vehicle is refueled without turning the engine switch off, the display may not be updated.

^{*4}: This distance is computed based on your average fuel consumption. As a result, the actual distance that can be driven may differ from that displayed.

■ Eco Driving Indicator

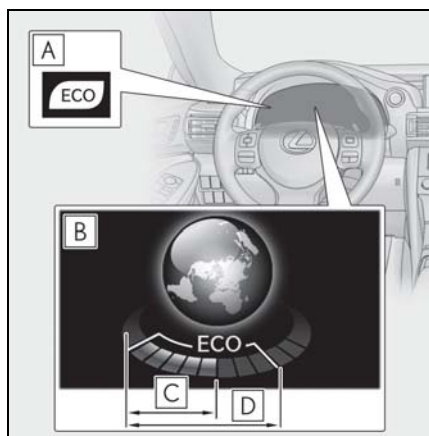

A Eco Driving Indicator Light

During Eco-friendly acceleration (Eco driving), the Eco Driving Indicator Light will turn on. When the acceleration exceeds the Zone of Eco driving, or when the vehicle is stopped, the light turns off.

B Eco Driving Indicator Zone Display
Suggests the Zone of Eco driving with current Eco driving ratio based on acceleration.

C Eco driving ratio based on acceleration

If the acceleration exceeds the Zone of Eco driving, the right side of the Eco Driving Indicator Zone Display will illuminate. At this time, the Eco Driving Indicator Light will turn off.

D Zone of Eco driving

Eco Driving Indicator will not operate under the following conditions:

- The shift lever is in any position other than D.
- A paddle shift switch is operated.
- Neither normal mode nor Eco drive mode is selected. (→P.199)

- The vehicle speed is approximately 80 mph (130 km/h) or higher.

■ Boost gauge/engine oil temperature gauge/engine oil pressure gauge (if equipped)*

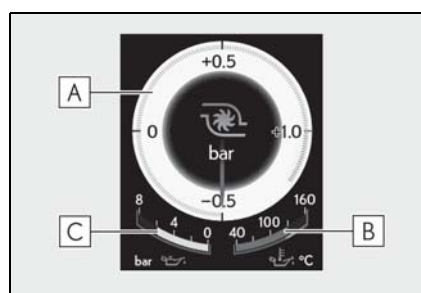

A Boost gauge

Displays the boost pressure. The display will change color if the specified pressure is exceeded.

B Engine oil temperature gauge

Displays the engine oil temperature. The display will flash if the engine oil temperature exceeds 284 °F (140 °C).

C Engine oil pressure gauge

Displays the engine oil pressure. A buzzer will sound and warning message will be displayed if the engine oil pressure becomes low. (→P.295)

This display is intended for use as a guideline. Depending on factors such as the road surface condition, temperature and vehicle speed, the display may not show the actual condition of the vehicle.

*: For F SPORT models, this item is not available when the main meter is in the center position.

■ G-force (if equipped)*

Displays lateral G-forces on the vehicle.

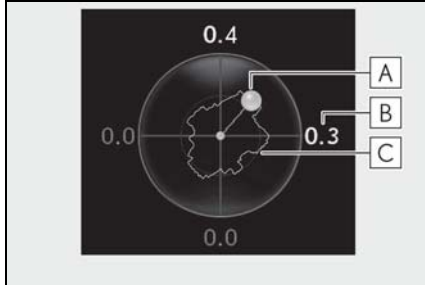

- A** Acceleration G-force on the vehicle
- B** Current G-force value (analyzed value of front/rear and left/right G-forces)
- C** Record of the maximum G-forces

This display is intended for use as a guideline. Depending on factors such as the road surface condition, temperature and vehicle speed, the display may not show the actual condition of the vehicle.

- Resetting the record of maximum G-forces

Press and hold  to reset the record.

- Peak hold function

If lateral G-forces of 0.5 G or greater are generated, the G-force value display will turn amber and be held for 2 seconds.

*: For F SPORT models, this item is not available when the main meter is in the center position.

■ Tire pressure

→P.268

■ Vehicle sway warning*

Detects the sway of the vehicle within a lane, which is often associated with a decrease in the driver's attention level,

and displays the decrease in attention using a bar display.

The shorter the bar length, the more the driver may need to rest.

This display is a part of the LDA (Lane Departure Alert with steering control) system. The display is enabled when the operating conditions of the vehicle sway warning are met. (→P.170)



*: For F SPORT models, this item is not available when the main meter is in the center position.

■ Gear positions

Displays the current gear position when the shift lever is in D or M.

■ Units (if equipped)*

The units of measure used can be changed while driving.

Unlike the units setting performed on , the units setting performed on  can be changed while driving.

*: For F SPORT models, this item is not available when the main meter is in the right-side position.

■ Blank (No items)

Displays no drive information contents.

■ Tire pressure

- It may take a few minutes to display the tire inflation pressure after the engine switch is turned to IGNITION ON mode. It may also take a few minutes to display the tire inflation pressure after inflation pressure has been adjusted.
- “---” may be displayed if the tire position information cannot be determined due to unfavorable radio wave conditions.
- Tire inflation pressure changes with temperature. The displayed values may also be different from the values measured

using a tire pressure gauge.

Navigation system-linked display (if equipped)

Select to display the following navigation system-linked information.

- Route guidance
- Compass display (heading-up display)

Audio system-linked display

Select to enable selection of an audio source or track on the display using the meter control switches.

Driving assist system information

Select to display the operational status of the following systems:

- LDA (Lane Departure Alert with steering control) (→P.169)
- Dynamic radar cruise control with full-speed range (→P.176)

Warning message display

Select to display warning messages and measures to be taken if a malfunction is detected. (→P.303)

Settings display

The settings of the following items can be changed using the meter control switches.

For functions that can be enabled or disabled, the function switches

between on and off each time  is pressed.

■ LDA (Lane Departure Alert with steering control) (→P.169)

Select to set up the following items.

- Steering Assist

Select to enable/disable steering wheel assistance.

- Alert

Select to set a vibrator or buzzer as the notification method used to warn the driver.

- Sensitivity

Select to set the warning sensitivity.

- Sway warning

Select to enable/disable the vehicle sway warning.

- Sway sensitivity

Select to set the vehicle sway warning sensitivity.

■ PCS (Pre-Collision System) (→P.162)

Select to set up the following items.

- PCS

Select to enable/disable the pre-collision system.

- Warning sensitivity

Select to change the warning timing.

■ Speed indicator (F SPORT models) (→P.68)

Select to set up the following items.

- Speed Indicator

Select to enable/disable the speed indicator.

- Speed Setting *

Select to set the desired vehicle speed at which the speed indicator will begin to be displayed.

*: Always observe the legal speed limit when driving on public roads.

- Clock (→P.66)

Select to switch between 12-hour display and 24-hour display.

- Vehicle Settings

- Scheduled Maintenance (→P.248)

Select to reset the message indicating maintenance is required, after the required maintenance is performed.

- Oil maintenance (→P.260)

Select to reset the engine oil maintenance information (message indicating maintenance is required and distance until the next oil change) after engine oil maintenance is performed.

- Meter settings

- Language

Select to change the language on the display.

- Units

Select to change the units of measure displayed.

-  Eco Driving Indicator Light (→P.74)

Select to enable/disable the Eco Driving Indicator Light.

-  Switch settings (except F SPORT models)

Displays a procedure to register a desired screen to .

You can register 1 screen as a shortcut,

which can be displayed by pressing



- Drive information screen (→P.73)

Select to choose between 2 items that will be displayed on each drive information screen ("Drive info 1", "Drive Info 2" and "Drive Info 3") respectively.

- Pop-up display (→P.70)

Select to enable/disable the pop-up display.

- Intersection guidance (if equipped)
- Incoming calls
- Audio Feedback (F SPORT)
- Volume Feedback (F SPORT)
- Brightness adjustment

- Color (except F SPORT models)

Select to set the color of the cursor on the multi-information display.

- Needle (F SPORT models)

Select to set the tachometer needle color.

- Rev indicator (F SPORT models) (→P.69)

Select to enable/disable the Rev indicator.

Select to set the desired engine speed at which the Rev indicator will begin to be displayed.

- Rev peak (F SPORT models) (→P.69)

Select to enable/disable the Rev peak.

- Default setting

Select to reset the meter display settings to the default setting.

■ Background color of the indicator/shift position display area (except F SPORT models)

The background color of the indicator/shift position display area is changed according to the driving mode as follows (→P.199):

- Eco drive mode: Blue
- Sport mode: Red

■ G-force display (if equipped)

The G-force values may not be zero even when the vehicle is parked, such as when it is parked on an incline.

■ Suspension of the settings display

- Some settings cannot be changed while driving. When changing settings, park the vehicle in a safe place.
- If a warning message is displayed, operation of the settings display will be suspended.



NOTICE

■ While setting up the display

To prevent battery discharge, ensure that the engine is running while setting up the display features.



WARNING

■ Caution for use while driving

- When operating the multi-information display while driving, pay extra attention to the safety of the area around the vehicle.
- Do not look continuously at the multi-information display while driving as you may fail to see pedestrians, objects on the road, etc. ahead of the vehicle.

■ Cautions during setting up the display

As the engine needs to be running during setting up the display, ensure that the vehicle is parked in a place with adequate ventilation. In a closed area such as a garage, exhaust gases including harmful carbon monoxide (CO) may collect and enter the vehicle. This may lead to death or a serious health hazard.

Fuel consumption information

Fuel consumption information can be displayed on the Center Display.

Vehicles with a 10.3-inch display: The fuel consumption information can be displayed and operated on the side display.

System components

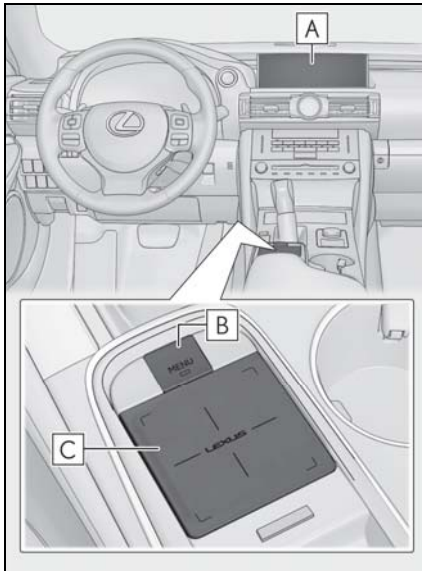

- A** Center Display
- B** "MENU" button
- C** Touchpad

Consumption

■ Trip information

Press the "MENU" button on the Remote Touch, then select **i** on the

menu screen, and then select "ECO".

If a screen other than "Trip Information" is displayed, select "Trip Information".

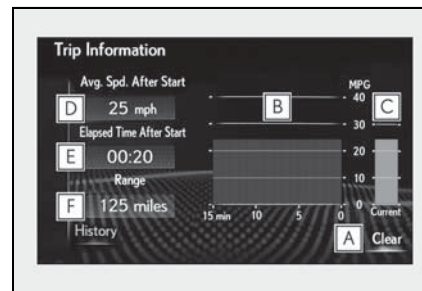

- A** Resetting the consumption data
- B** Fuel consumption in the past 15 minutes
- C** Current fuel consumption
- D** Average vehicle speed since the engine was started.
- E** Elapsed time since the engine was started.
- F** Cruising range

Average fuel consumption for the past 15 minutes is divided by color into past averages and averages attained since the engine switch was last turned to IGNITION ON mode. Use the displayed average fuel consumption as a reference.

The image is an example only, and may vary slightly from actual conditions.

■ History

Press the "MENU" button on the Remote Touch, then select **i** on the menu screen, and then select "ECO".

If a screen other than "History" is displayed, select "History".

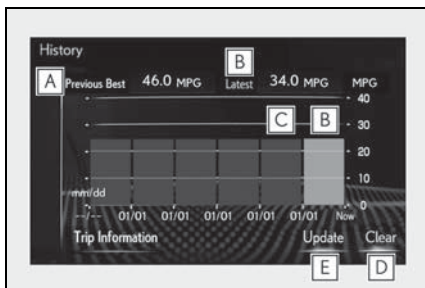

- A** Best recorded fuel consumption
- B** Latest fuel consumption
- C** Previous fuel consumption record
- D** Resetting the history data
- E** Updating the latest fuel consumption data

The average fuel consumption history is divided by color into past averages and the average fuel consumption since the last updated. Use the displayed average fuel consumption as a reference.

The image is an example only, and may vary slightly from actual conditions.

■ Updating the history data

Update the latest fuel consumption by selecting "Update" to measure the current fuel consumption again.

■ Resetting the data

The fuel consumption data can be deleted by selecting "Clear".

■ Cruising range

Displays the estimated maximum distance that can be driven with the quantity of fuel remaining.

This distance is computed based on your average fuel consumption.

As a result, the actual distance that can be driven may differ from that displayed.

Using the side display (vehicles with a 10.3-inch display)

Display the vehicle information on the side display (→P.214), and then select

◀ or ▶ to display the desired screen.

The image is an example only, and may vary slightly from actual conditions.

■ Trip information (type A)

Displays the average fuel consumption for the past 10 minutes in 1 minute intervals, as well as the cruising range.

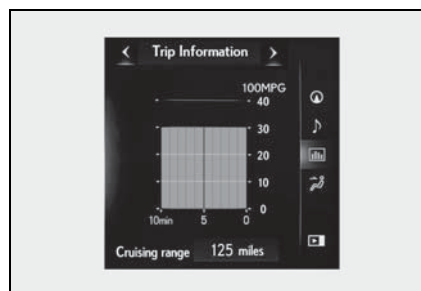

Use the displayed average fuel consumption as a reference.

■ Trip information (type B)

Displays the cruising range, latest fuel consumption and the amount of time elapsed since the engine was started.

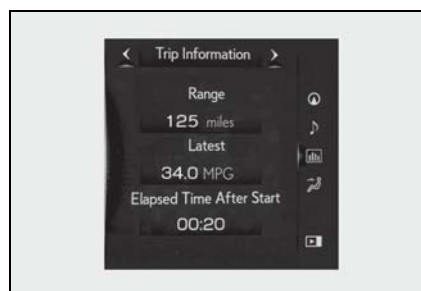

Use the displayed average fuel consumption as a reference.

■ History

Displays the average fuel consumption and highest fuel consumption.



Use the displayed average fuel consumption as a reference.

- 3-1. Key information
 - Keys 84
- 3-2. Opening, closing and locking the doors and trunk
 - Doors..... 88
 - Trunk..... 91
 - Smart access system with push-button start 95
- 3-3. Adjusting the seats
 - Front seats..... 99
 - Rear seats..... 101
 - Power easy access system/driving position memory/memory recall function..... 102
 - Head restraints..... 105
- 3-4. Adjusting the steering wheel and mirrors
 - Steering wheel..... 108
 - Inside rear view mirror 109
 - Outside rear view mirrors..... 110
- 3-5. Opening, closing the windows and moon roof
 - Power windows..... 112
 - Moon roof 114

Keys

The keys

The following keys are provided with the vehicle.

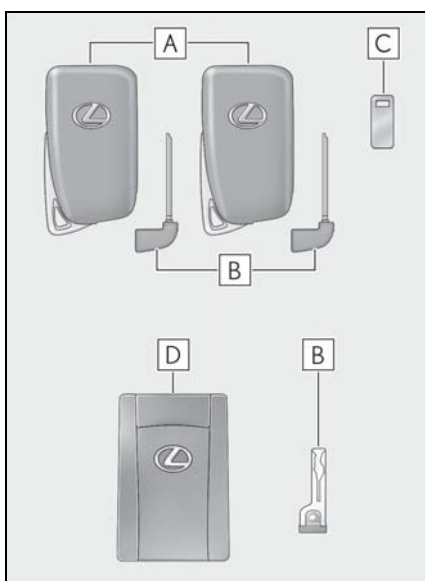

A Electronic keys

- Operating the smart access system with push-button start (→P.95)
- Operating the wireless remote control function (→P.86)

B Mechanical keys

C Key number plate

D Card key (electronic key) (if equipped)

Operating the smart access system with push-button start (→P.95)

■ Card key (if equipped)

- The card key is not waterproof.
- The mechanical key that is stored inside the card key should be used only if a problem arises, such as when the card

key does not operate properly.

- If it is difficult to take out the mechanical key, push down the lock release button using a pen tip etc. If it is still difficult to pull it out, use a coin etc.
- To store the mechanical key in the card key, insert it while pressing the lock release button.

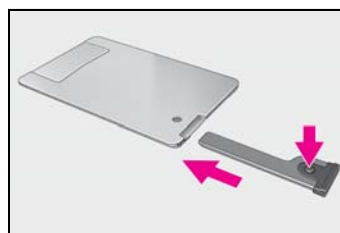

- If the battery cover is not installed and the battery falls out or if the battery was removed because the key got wet, reinstall the battery with the positive terminal facing the Lexus emblem.

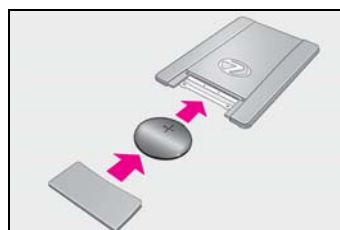

■ When riding in an aircraft

When bringing an electronic key onto an aircraft, make sure you do not press any buttons on the electronic key while inside the aircraft cabin. If you are carrying an electronic key in your bag etc., ensure that the buttons are not likely to be pressed accidentally. Pressing a button may cause the electronic key to emit radio waves that could interfere with the operation of the aircraft.

■ Electronic key battery depletion

- The standard battery life is 1 to 2 years. (The card key battery life is about a year and a half.)
- If the battery becomes low, an alarm will sound in the cabin and a message will be shown on the multi-information display when the engine is stopped.

- As the electronic key always receives radio waves, the battery will become depleted even if the electronic key is not used. The following symptoms indicate that the electronic key battery may be depleted. Replace the battery when necessary.
 - The smart access system with push-button start or the wireless remote control does not operate.
 - The detection area becomes smaller.
 - The LED indicator on the key surface does not turn on.
- To avoid serious deterioration, do not leave the electronic key within 3 ft. (1 m) of the following electrical appliances that produce a magnetic field:
 - TVs
 - Personal computers
 - Cellular phones, cordless phones and battery chargers
 - Recharging cellular phones or cordless phones
 - Table lamps
 - Induction cookers

■ Replacing the battery

→P.277

■ Confirmation of the registered key number

The number of keys already registered to the vehicle can be confirmed. Ask your Lexus dealer for details.



NOTICE

■ To prevent key damage

- Do not drop the keys, subject them to strong shocks or bend them.
- Do not expose the keys to high temperatures for long periods of time.
- Do not get the keys wet or wash them in an ultrasonic washer etc.
- Do not attach metallic or magnetic materials to the keys or place the keys close to such materials.
- Do not disassemble the keys.

- Do not attach a sticker or anything else to the surface of the electronic key.

- Do not place the keys near objects that produce magnetic fields, such as TVs, audio systems and induction cookers.

■ Carrying the electronic key on your person

Carry the electronic key 3.9 in. (10 cm) or more away from electric appliances that are turned on. Radio waves emitted from electric appliances within 3.9 in. (10 cm) of the electronic key may interfere with the key, causing the key to not function properly.

■ In case of a smart access system with push-button start malfunction or other key-related problems

→P.317

■ When an electronic key is lost

→P.316

■ Handling the card key (if equipped)

- Do not apply excess force when inserting the mechanical key into the card key. Doing so may damage the card key.
- If the battery or card key terminals get wet, the battery may corrode. If the key is dropped into water, or if drinking water etc. is spilled on the key, immediately remove the battery cover and wipe the battery and terminals. (To remove the battery cover, lightly grasp and pull it.) If the battery is corroded, have your Lexus dealer replace the battery.
- Do not crush the battery cover or use a screwdriver to remove the battery cover. Forcibly removing the battery cover may bend or damage the key.
- If the battery cover is frequently removed, the battery cover may become loose.

 NOTICE

- When installing the battery, make sure to check the direction of the battery. Installing the battery in the wrong direction may cause the battery to deplete rapidly.
- The surface of the card key may be damaged, or its coating may peel off in the following situations:
 - The card key is carried together with hard objects, such as coins and keys.
 - The card key is scraped with a sharp object, such as the tip of a mechanical pencil.
 - The surface of the card key is wiped with thinner or benzene.

Wireless remote control

The electronic keys are equipped with the following wireless remote control:

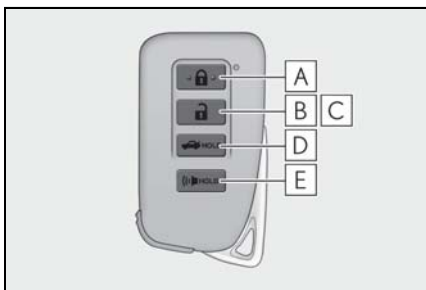

- A** Locks the doors (→P.88)
- B** Unlocks the doors (→P.88)
- C** Opens the windows and moon roof (if equipped)* (→P.88)
- D** Opens the trunk (→P.93)
- E** Sounds the alarm

*: This setting must be customized at your Lexus dealer.

■ Panic mode

When  is pressed for longer than about one second, an alarm will sound intermittently and the vehicle lights will flash to deter any person from trying to break into or damage your vehicle.

To stop the alarm, press any button on the electronic key.

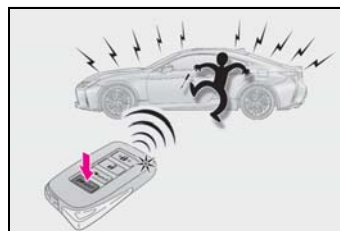

Using the mechanical key

To take out the mechanical key, push the release button and take the key out.

The mechanical key can only be inserted in one direction, as the key only has grooves on one side. If the key cannot be inserted in a lock cylinder, turn it over and re-attempt to insert it.

After using the mechanical key, store it in the electronic key. Carry the mechanical key together with the electronic key. If the electronic key battery is depleted or the entry function does not operate properly, you will need the mechanical key. (→P.317)

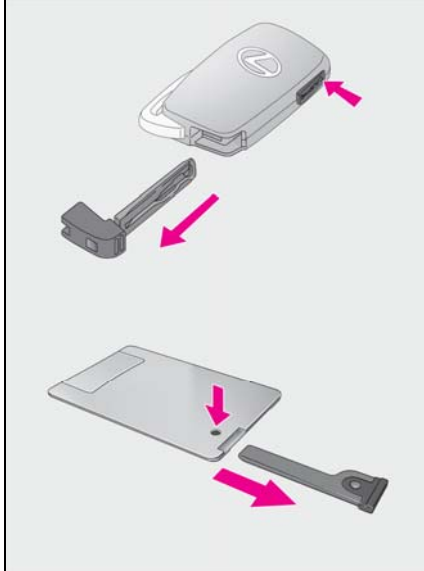

■ **When required to leave the vehicle's key with a parking attendant**

Set the luggage security system (→P.94) on and lock the glove box (→P.227) as circumstances demand.

Remove the mechanical key for your own use and provide the attendant with the electronic key only.

■ **If you lose your mechanical keys**

→P.316

■ **If a wrong key is used**

The key cylinder rotates freely, isolated from the internal mechanism.

Doors

Unlocking and locking the doors from the outside

■ Smart access system with push-button start

Carry the electronic key to enable this function.

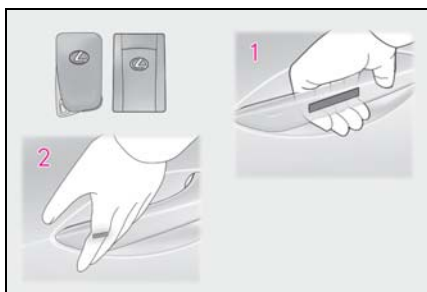

- 1** Grip the driver's door handle to unlock the door. Grip the passenger's door handle to unlock both side doors.*

Make sure to touch the sensor on the back of the handle.

The doors cannot be unlocked for 3 seconds after the doors are locked.

*: The door unlock settings can be changed.

- 2** Touch the lock sensor (indentation on the side of the door handle) to lock the doors.

Check that the door is securely locked.

■ Wireless remote control

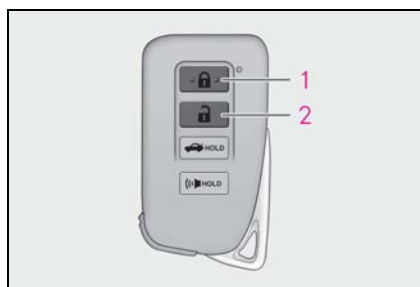

- 1** Locks both side doors

Check that the door is securely locked.

- 2** Unlocks both side doors

Pressing the button unlocks the driver's door. Pressing the button again within 5 seconds unlocks the other door.

Press and hold to open the windows and moon roof.*

*: This setting must be customized at your Lexus dealer.

■ Side window open/close function linked to door operation

When a door is opened, its window opens slightly. When a door is closed, its window closes completely.

■ Switching the door unlock function



It is possible to set which doors the entry function unlocks using the wireless remote control.

- 1** Turn the engine switch off.
- 2** When the indicator light on the key surface is not on, press and hold 

 or  for approximately 5 seconds while pressing and holding



The setting changes each time an operation is performed, as shown below. (When changing the setting continuously, release the buttons, wait for at least 5 seconds, and repeat step 2.)

Multi-information display/Beep	Unlocking function
 <p>Exterior: Beeps 3 times Interior: Pings once</p>	<p>Holding the driver's door handle unlocks only the driver's door.</p> <p>Holding the passenger's door handle unlocks both side doors.</p>
 <p>Exterior: Beeps twice Interior: Pings once</p>	<p>Holding either door handle unlocks both side doors.</p>

To prevent unintended triggering of the alarm, unlock the doors using the wireless remote control and open and close a door once after the settings have been changed. (If a door is not opened within 60 seconds after  is pressed, the doors will be locked again and the alarm will automatically be set.)

In a case that the alarm is triggered, immediately stop the alarm. (→P.57)

■ Impact detection door lock release system

In the event that the vehicle is subject to a strong impact, both side doors are unlocked. Depending on the force of the impact or the type of accident, however, the system may not operate.

■ Operation signals

A buzzer sounds and the emergency flashers flash to indicate that the doors have been locked/unlocked. (Locked: once; Unlocked: twice)

A buzzer sounds to indicate that the windows and moon roof are operating.

■ Welcome light illumination control

The side marker, parking, tail and license plate lights automatically turn on at night

when the doors are unlocked using the entry function or wireless remote control if the light switch is in the **AUTO** position.

■ Security feature

If a door is not opened within approximately 60 seconds after the vehicle is unlocked, the security feature automatically locks the vehicle again.

■ When the door cannot be locked by the lock sensor on the surface of the door handle

Use your palm to touch the lock sensor.

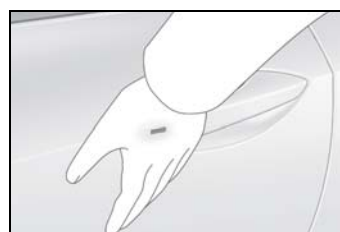

■ Open door warning buzzer

If an attempt to lock the doors is made when a door is not fully closed, a buzzer sounds continuously for 5 seconds. Fully close the door to stop the buzzer, and lock the vehicle once more.

■ Setting the alarm

Locking the doors will set the alarm system. (→P.57)

■ Conditions affecting the operation of the smart access system with push-button start or wireless remote control

→P.96

■ If the smart access system with push-button start or the wireless remote control does not operate properly

Use the mechanical key and/or inside lock buttons to lock and unlock the doors. (→P.317)

Replace the key battery with a new one if it is depleted. (→P.277)

■ Customization

Some functions can be customized. (→P.351)

⚠ WARNING**■ To prevent an accident**

Observe the following precautions while driving the vehicle. Failure to do so may result in a door opening and an occupant being thrown out of the vehicle, resulting in death or serious injury.

- Ensure that both side doors are properly closed and locked.
- Do not pull the inside handle of the doors while driving.

The doors may be opened even if the inside lock buttons are in locked position.

■ Side window open/close function linked to door operation

Do not hold the upper edge of the side window when you close the door. Otherwise, your fingers or hand may be caught in the window.

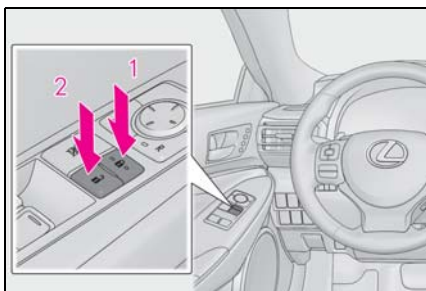
Unlocking and locking the doors from the inside**■ Door lock switches (to lock/unlock)**

- 1 Locks both side doors
- 2 Unlocks both side doors

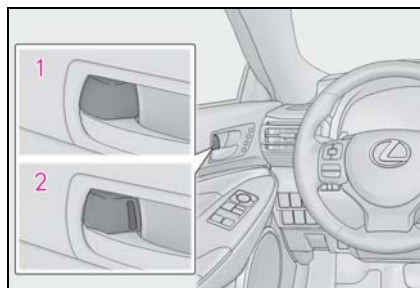
■ Inside lock buttons (to lock/unlock)

- 1 Locks the door
- 2 Unlocks the door

Both side doors can be opened by pulling the inside handle even if the lock buttons are in the lock position.

■ Locking the doors from the outside without a key

- 1 Move the inside lock button to the lock position.
- 2 Close the door.

The door cannot be locked if the engine switch is in ACCESSORY or IGNITION ON mode, or the electronic key is left inside the vehicle. However, the key may not be detected correctly and the door may be locked.

■ If a symbol indicating one or more of the doors open is shown on the multi-information display

The hood, one or more of the doors, or trunk is not fully closed. If the vehicle reaches a speed of 3 mph (5 km/h), the master warning light flashes and a buzzer sounds to indicate that the door(s) are not fully closed. Make sure to close hood, all doors and trunk.

Automatic door locking and unlocking systems

The following functions can be set or canceled:

For instructions on customizing, refer to

P.351

Function	Operation
Speed linked door locking function	Both side doors are automatically locked when vehicle speed is approximately 12 mph (20 km/h) or higher.
Shift position linked door locking function	Both side doors are automatically locked when the shift lever is shifted to a position other than P.
Shift position linked door unlocking function	Both side doors are automatically unlocked when the shift lever is shifted to P.
Driver's door linked door unlocking function	Both side doors are automatically unlocked when driver's door is opened.

Trunk

The trunk can be opened using the trunk opener switch, entry function or wireless remote control.

WARNING

Observe the following precautions. Failure to do so may result in death or serious injury.

■ Before driving

- Make sure that the trunk lid is fully closed. If the trunk lid is not fully closed, it may open unexpectedly while driving and hit near-by objects or luggage in the trunk may be thrown out, causing an accident.

- Do not allow children to play in the trunk. If a child is accidentally locked in the trunk, they could suffer from heat exhaustion, suffocation or other injuries.

- Do not allow a child to open or close the trunk lid. Doing so may cause the trunk lid to open unexpectedly, or cause the child's hands, head, or neck to be caught by the closing trunk lid.

■ Important points while driving

Never let anyone sit in the trunk. In the event of sudden braking or a collision, they are susceptible to death or serious injury.

■ Using the trunk

Observe the following precautions. Failure to do so may cause parts of the body to be caught, resulting in serious injury.

- Remove any heavy loads, such as snow and ice, from the trunk lid before opening it. Failure to do so may cause the trunk lid to suddenly shut again after it is opened.

3

Before driving

⚠ WARNING

- When opening or closing the trunk lid, thoroughly check to make sure the surrounding area is safe.
- If anyone is in the vicinity, make sure they are safe and let them know that the trunk is about to open or close.
- Use caution when opening or closing the trunk lid in windy weather as it may move abruptly in strong wind.
- On an incline it is more difficult to open or close the trunk lid than on a level surface, so beware of the trunk lid unexpectedly opening or closing by itself. Make sure that the trunk lid is fully open and secure before using the trunk.
- When opening the trunk lid, take care so that it does not hit anyone in the face or any other part of the body.

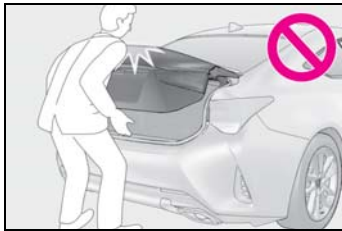

- When closing the trunk lid, take extra care to prevent your fingers etc. from being caught.

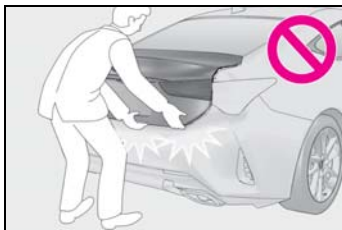

- When closing the trunk lid, make sure to press it lightly on its outer surface. If the trunk handle is used to fully close the trunk lid, it may result in hands or arms being caught.

- Do not attach any accessories other than genuine Lexus parts to the trunk lid. Such additional weight on the trunk lid may cause the lid to suddenly shut again after it is opened.

Opening/closing the trunk**■ Trunk opener switch**

Press the trunk opener switch.

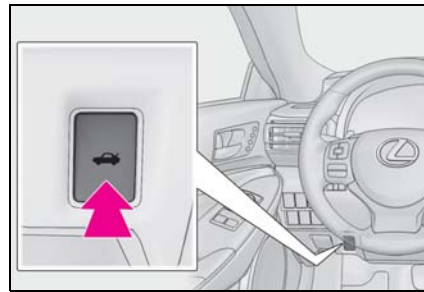
**■ Smart access system with push-button start**

While carrying the electronic key, press the button on the trunk lid.

When both side doors are unlocked using one of the following methods, the trunk can be opened without the electronic key:

- Entry function
- Wireless remote control
- Door lock switches
- Automatic door unlocking system
- Mechanical key

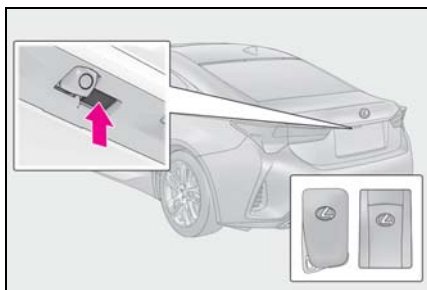

■ Wireless remote control

Press and hold the switch.

A buzzer sounds.



■ Trunk grip

Using the trunk grip, lower the trunk without applying force to the side and push the trunk down from the outside to close it.

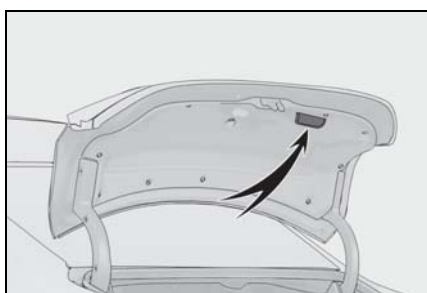

■ Trunk light

- The trunk light turns on when the trunk is opened.
- If the trunk light is left on when the engine switch is turned off, the light will go off

automatically after 20 minutes.

■ Function to prevent the trunk being locked with the electronic key inside

- When both side doors are locked, closing the trunk lid with the electronic key left inside the trunk will sound an alarm. In this case, the trunk lid can be opened by pressing the trunk release button on the trunk lid.
- If the spare electronic key is put in the trunk with both side doors locked, the key confinement prevention function is activated so the trunk can be opened. In order to prevent theft, take all electronic keys with you when leaving the vehicle.
- If the electronic key is put in the trunk with both side doors locked, the key may not be detected depending on the location of the key and the surrounding radio wave conditions. In this case, the key confinement prevention function cannot be activated, causing the doors to lock when the trunk is closed. Make sure to check where the key is before closing the trunk.
- The key confinement prevention function cannot be activated if either door is unlocked. In this case, open the trunk using the trunk opener.

■ Internal trunk release lever

The trunk lid can be opened by pulling the glow-in-the-dark lever located on the inside of the trunk lid upward.

The lever will continue to glow for some time after the trunk lid is closed.

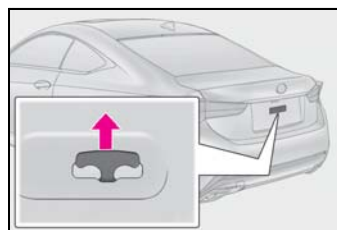

■ Using the mechanical key

The trunk can be also opened using the mechanical key. (→P.317)

- If the smart access system with push-button start or the wireless remote control does not operate properly

Use the mechanical key to unlock the trunk. (→P.317)

Replace the key battery with a new one if it is depleted. (→P.277)

- If a symbol indicating the trunk opens is shown on the multi-information display

→P.90

- Customization

Some functions can be customized. (→P.351)

Luggage security system

To protect luggage stored in the trunk against theft, the luggage security system can be set to on.

- 1 Move the luggage security system levers to the lock position.

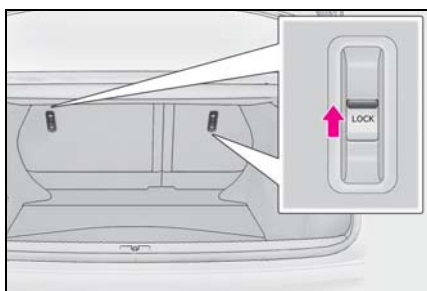

To lock a luggage security system lever from inside the cabin, fold the rear seatback forward, move the lever to the lock position, and return the seatback to its original position.

- 2 To disable the trunk opener, turn the main switch in the glove box off.

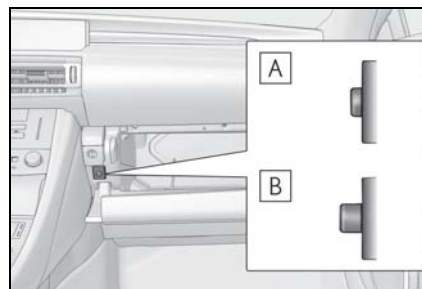

A On

B Off

When the main switch is off, the trunk lid cannot be opened even with the wireless remote control or entry function.

- When leaving a key to the vehicle with a parking attendant

→P.87

Smart access system with push-button start

The following operations can be performed simply by carrying the electronic key (including the card key) on your person, for example in your pocket. The driver should always carry the electronic key.

- Locks and unlocks the doors (→P.88)
- Opens the trunk (→P.92)
- Starts the engine (→P.127)

■ Antenna location

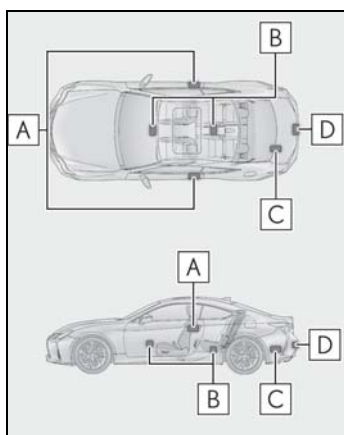

- A** Antennas outside the cabin
- B** Antennas inside the cabin
- C** Antenna inside the trunk
- D** Antenna outside the trunk

■ Effective range (areas within which the electronic key is detected)

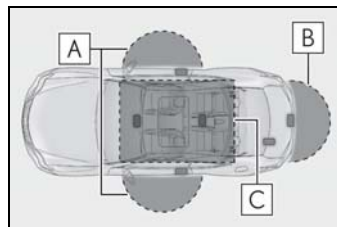

A When locking or unlocking the doors

The system can be operated when the electronic key is within about 2.3 ft. (0.7 m) of an outside door handle. (Only the doors detecting the key can be operated.)

B When opening the trunk

The system can be operated when the electronic key is within about 2.3 ft. (0.7 m) of the trunk release button.

C When starting the engine or changing engine switch modes

The system can be operated when the electronic key is inside the vehicle.

■ Alarms and warning messages

An alarm sounds and warning messages are displayed on the multi-information display to protect against unexpected accidents or theft of the vehicle resulting from erroneous operation. When a warning message is displayed, take appropriate measures based on the displayed message. (→P.303)

When only an alarm sounds, circumstances and correction procedures are as follows.

- When an exterior alarm sounds once for 5 seconds

Situation	Correction procedure
The trunk was closed while the electronic key was still inside the trunk and both side doors were locked.	Retrieve the electronic key from the trunk and close the trunk lid.
An attempt was made to lock the vehicle while a door was open.	Close both side doors and lock the doors again.

- When an interior alarm sounds continuously

Situation	Correction procedure
The engine switch was turned to ACCESSORY mode while the driver's door was open (or the driver's door was opened while the engine switch was in ACCESSORY mode).	Turn the engine switch off and close the driver's door.
The engine switch was turned off while the driver's door was open.	Close the driver's door.

■ Battery-saving function



The battery-saving function will be activated in order to prevent the electronic key battery and the vehicle battery from being discharged while the vehicle is not in operation for a long time.

- In the following situations, the smart access system with push-button start may take some time to unlock the doors.
 - The electronic key has been left within approximately 6 ft. (2 m) of the outside of the vehicle for 10 minutes or longer.
 - The smart access system with push-button start has not been used for 5 days or longer.
- If the smart access system with push-button start has not been used for 14 days or

longer, the doors cannot be unlocked at the passenger door. In this case, take hold of the driver's door handle, or use the wireless remote control or mechanical key, to unlock the doors.

■ Electronic Key Battery-Saving Function

When battery-saving mode is set, battery depletion is minimized by stopping the electronic key from receiving radio waves.

Press  twice while pressing and holding . Confirm that the electronic key indicator flashes 4 times.

While the battery-saving mode is set, the smart access system with push-button start cannot be used. To cancel the function, press any of the electronic key buttons.



■ Conditions affecting operation

The smart access system with push-button start uses weak radio waves. In the following situations, the communication between the electronic key and the vehicle may be affected, preventing the smart access system with push-button start, wireless remote control and engine immobilizer system from operating properly. (Ways of coping: →P.317)

- When the electronic key battery is depleted
- Near a TV tower, electric power plant, gas station, radio station, large display, airport or other facility that generates strong radio waves or electrical noise
- When carrying a portable radio, cellular phone, cordless phone or other wireless communication device
- When the electronic key is in contact with, or is covered by the following metallic objects
 - Cards to which aluminum foil is attached

- Cigarette boxes that have aluminum foil inside
 - Metallic wallets or bags
 - Coins
 - Hand warmers made of metal
 - Media such as CDs and DVDs
 - When other wireless keys (that emit radio waves) are being used nearby
 - When carrying the electronic key together with the following devices that emit radio waves
 - Another vehicle's electronic key or a wireless key that emits radio waves
 - Personal computers or personal digital assistants (PDAs)
 - Digital audio players
 - Portable game systems
 - If window tint with a metallic content or metallic objects are attached to the rear window
 - When the electronic key is placed near a battery charger or electronic devices
- **Note for the entry function**
- Even when the electronic key is within the effective range (detection areas), the system may not operate properly in the following cases:
 - The electronic key is too close to the window or outside door handle, near the ground, or in a high place when the doors are locked or unlocked.
 - The electronic key is near the ground or in a high place, or too close to the rear bumper center when the trunk is opened.
 - The electronic key is on the instrument panel, rear package tray or floor, or in the door pockets or glove box when the engine is started or engine switch modes are changed.
 - Do not leave the electronic key on top of the instrument panel or near the door pockets when exiting the vehicle. Depending on the radio wave reception conditions, it may be detected by the antenna outside the cabin and the doors will become lockable from the outside, possibly trapping the electronic key inside the vehicle.
 - As long as the electronic key is within the effective range, the doors may be locked or unlocked by anyone. However, only the doors detecting the electronic key can be used to unlock the vehicle.
 - Even if the electronic key is not inside the vehicle, it may be possible to start the engine if the electronic key is near the window.
 - The doors may unlock or lock if a large amount of water splashes on the door handle, such as in the rain or in a car wash, when the electronic key is within the effective range. (The doors will automatically be locked after approximately 60 seconds if the doors are not opened and closed.)
 - If the wireless remote control is used to lock the doors when the electronic key is near the vehicle, there is a possibility that the door may not be unlocked by the entry function. (Use the wireless remote control to unlock the doors.)
 - Touching the door lock or unlock sensor while wearing gloves may prevent lock or unlock operation.
 - When the lock operation is performed using the lock sensor, recognition signals will be shown up to two consecutive times. After this, no recognition signals will be given.
 - If the door handle becomes wet while the electronic key is within the effective range, the door may lock and unlock repeatedly. In this case, follow the following correction procedures to wash the vehicle:
 - Place the electronic key in a location 6 ft. (2 m) or more away from the vehicle. (Take care to ensure that the key is not stolen.)
 - Set the electronic key to battery-saving mode to disable the smart access system with push-button start. (→P.96)
 - If the electronic key is inside the vehicle and a door handle becomes wet during a car wash, a message may be shown on the multi-information display and a buzzer will sound outside the vehicle. To turn off the alarm, lock both side doors.
 - The lock sensor may not work properly if it comes into contact with ice, snow, mud, etc. Clean the lock sensor and attempt to operate it again.

- A sudden handle operation or a handle operation immediately after entering the effective range may prevent the doors from being unlocked. Touch the door unlock sensor and check that the doors are unlocked before pulling the door handle again.
- Unlocking the vehicle may take more time if another electronic key is within the effective range.
- **When the vehicle is not driven for extended periods**
- To prevent theft of the vehicle, do not leave the electronic key within 6 ft. (2 m) of the vehicle.
- The smart access system with push-button start can be deactivated in advance.
- **To operate the system properly**
- Make sure to carry the electronic key when operating the system. Do not get the electronic key too close to the vehicle when operating the system from the outside of the vehicle.

Depending on the position and holding condition of the electronic key, the key may not be detected correctly and the system may not operate properly. (The alarm may go off accidentally, or the door lock prevention function may not operate.)

- Do not leave the electronic key inside the trunk.
The key confinement prevention function may not operate, depending on the location of the key (close to a spare tire [if equipped], the inside edge of the trunk), conditions (inside a metal bag, close to metallic objects) and the radio waves in the surrounding area. (→P.95)
- **If the smart access system with push-button start does not operate properly**
- Locking and unlocking the doors and opening the trunk: →P.317
- Starting the engine: →P.318

■ Customization

Some functions can be customized. (→P.351)

■ If the smart access system with push-button start has been deactivated in a customized setting

- Locking and unlocking the doors and opening the trunk:
Use the wireless remote control or mechanical key. (→P.88, 92, 317)
- Starting the engine and changing engine switch modes: →P.318
- Stopping the engine: →P.128

WARNING

■ Caution regarding interference with electronic devices

- People with implantable cardiac pacemakers, cardiac resynchronization therapy-pacemakers or implantable cardioverter defibrillators should keep away from the smart access system with push-button start antennas. (→P.95)

The radio waves may affect the operation of such devices. If necessary, the entry function can be disabled. Ask your Lexus dealer for details, such as the frequency of radio waves and timing of the emitted radio waves. Then, consult your doctor to see if you should disable the entry function.

- Users of any electrical medical device other than implantable cardiac pacemakers, cardiac resynchronization therapy-pacemakers or implantable cardioverter defibrillators should consult the manufacturer of the device for information about its operation under the influence of radio waves. Radio waves could have unexpected effects on the operation of such medical devices.

Ask your Lexus dealer for details on disabling the entry function.

Front seats

⚠ WARNING

■ When adjusting the seat position

- Take care when adjusting the seat position to ensure that other passengers are not injured by the moving seat.
- Do not put your hands under the seat or near the moving parts to avoid injury.

Fingers or hands may become jammed in the seat mechanism.

- Make sure to leave enough space around the feet so they do not get stuck.

■ Seat adjustment

To reduce the risk of sliding under the lap belt during a collision, do not recline the seat more than necessary.

If the seat is too reclined, the lap belt may slide past the hips and apply restraint forces directly to the abdomen, or your neck may contact the shoulder belt, increasing the risk of death or serious injury in the event of an accident.

Adjustments should not be made while driving as the seat may unexpectedly move and cause the driver to lose control of the vehicle.

Adjustment procedure

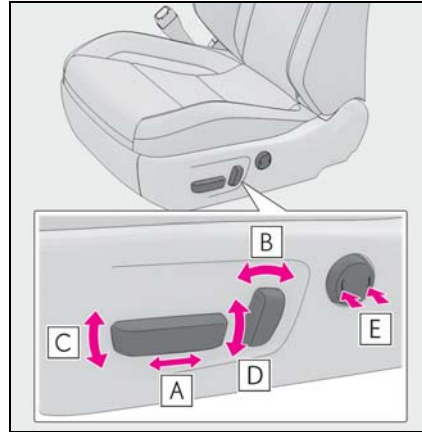

- A** Seat position adjustment
- B** Seatback angle adjustment
- C** Seat cushion (front) angle adjustment
- D** Vertical height adjustment
- E** Lumbar support adjustment (if equipped)

■ Power easy access system

The driver's seat and steering wheel move in accordance with engine switch mode and the driver's seat belt condition. (→P.102)

■ When adjusting the seat

- Take care when adjusting the seat so that the head restraint does not touch the ceiling.
- When folding down a rear seatback, if it interferes with a front seatback, adjust the front seat position so that the seats no longer interfere with each other. However, if adjusting the front seat position causes the correct driving posture to not be maintained, return the rear seatback to its original position. (→P.101)

3

Before driving

Entering/exiting the rear seats (lever-operated "Front, Fold & Return" seat)

■ Before entering/exiting the rear seats

Remove the seat belt from the seat belt guide. (→P.26)

■ Entering/exiting the rear seat

1 Pull the lever.

The front seat will lower automatically.



2 Fold the seatback completely forward.

The front seat will move forward automatically.

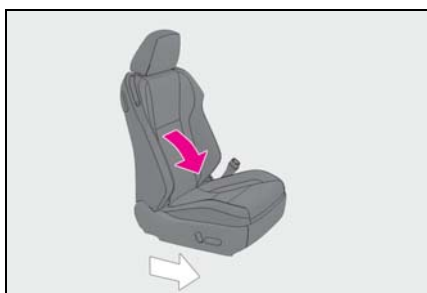

■ Returning the front seat to its original position

Move the seatback backward until it locks. The front seat will return to its original position automatically.

■ Lever-operated "Front, Fold & Return" seat

- After the front seat is moved forward by operating the "Front, Fold & Return" seat lever, if a power seat adjusting switch or a driving position memory switch is pressed, the front seat will not return to its original position even if the front seatback is moved backward until it locks.
- The lever-operated "Front, Fold & Return" seat will not operate in the following situations:
 - The front seat belt of the seat to be operated is fastened.
 - The engine switch is in IGNITION ON mode and the shift lever is in a position other than P (driver's seat only).
- Operation of the lever-operated "Front, Fold & Return" seat will stop in the following situations:
 - A power seat adjusting switch or a driving position memory switch is pressed.
 - The front seat belt of the seat which is operating is fastened.
 - The engine switch is in IGNITION ON mode and the shift lever is moved to a position other than P (driver's seat only).

■ Jam protection function

While the lever-operated "Front, Fold & Return" seat is operating, if an object is stuck either in front of or behind the front seat, the front seat will stop and then move in the opposite direction slightly.

⚠ WARNING

■ Lever-operated "Front, Fold & Return" seat

- Before operating the lever-operated "Front, Fold & Return" seat, ensure that any surrounding passengers or objects will not contact the seat.
- Make sure the seatback is locked securely before driving.
- Never operate the lever-operated "Front, Fold & Return" seat while the vehicle is moving.

⚠ WARNING**■ Jam protection function**

Do not use a hand, foot, or any other part of your body to intentionally activate the jam protection function.

Rear seats

The rear seatbacks can be folded down.

Folding down the rear seatbacks

- 1 Move the luggage security system lever to the unlock position.

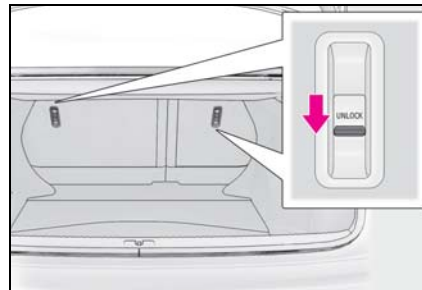

- 2 Pull the seatback lock release lever and fold the seatback down.

To return a rear seatback to its original position, lift it until it locks. If a rear head restraint contacts the ceiling and the seatback cannot be returned smoothly, lower the head restraint to the lowest position.

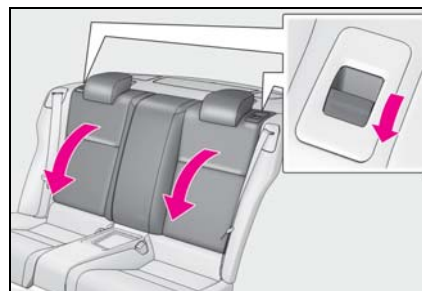
**⚠ WARNING**

Observe the following precautions. Failure to do so may result in death or serious injury.

3

Before driving

⚠ WARNING**■ When folding the rear seatbacks down**

- Do not fold the seatbacks down while driving.
- Stop the vehicle on level ground, set the parking brake and shift the shift lever to P.
- Do not allow anyone to sit on a folded seatback or in the trunk while driving.
- Do not allow children to enter the trunk.

■ After returning the rear seatback to the upright position

- Make sure that the seatback is securely locked in position by lightly pushing it back and forth.

If the seatback is not securely locked, the red marking will be visible on the seatback lock release knob. Make sure that the red marking is not visible.

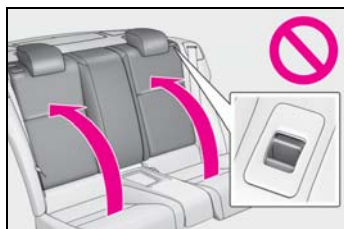

- Check that the seat belts are not twisted or caught in the seatback.

Luggage security system

→P.94

Power easy access system/driving position memory* /memory recall function*

*: If equipped

This feature automatically adjusts the driver's seat, steering wheel and outside rear view mirrors to make entering and exiting the vehicle easier or to suit your preferences.

Power easy access system

The seat and steering wheel* are automatically adjusted to allow the driver to enter and exit the vehicle easily.

When all of the following have been performed, the driver's seat and steering wheel* are automatically adjusted to a position that allows driver to enter and exit the vehicle easily.

- The shift lever has been shifted to P.
- The engine switch has been turned off.
- The driver's seat belt has been unfastened.

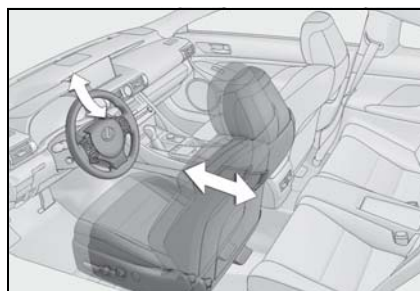

When any of the following has been performed, the driver's seat and steer-

ing wheel* automatically return to their original positions.

- The engine switch has been turned to ACCESSORY mode or IGNITION ON mode.
- The driver's seat belt has been fastened.

* : Power type

■ Operation of the power easy access system

When exiting the vehicle, the power easy access system may not operate if the seat is already close to the rear position, etc.

■ Customization

Some functions can be customized. (→P.351)

Recording a driving position into memory (vehicles with driving position memory)

- 1 Check that the shift lever is in P.
- 2 Turn the engine switch to IGNITION ON mode.
- 3 Adjust the driver's seat, steering wheel, and outside rear view mirrors to the desired positions.
- 4 While pressing the "SET" button, or within 3 seconds after the "SET" button is pressed, press button "1", "2" or "3" until the buzzer sounds.

If the selected button has already been preset, the previously recorded position

will be overwritten.

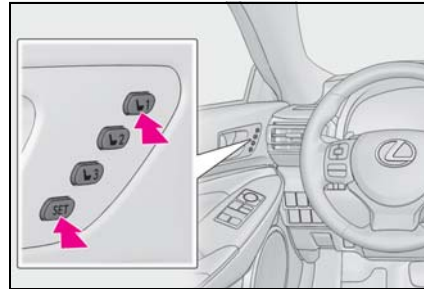

⚠ WARNING

■ Seat adjustment caution

Take care during seat adjustment so that the seat does not strike the rear passenger or squeeze your body against the steering wheel.

Recalling a driving position (vehicles with driving position memory)

- 1 Check that the shift lever is in P.
- 2 Turn the engine switch to IGNITION ON mode.
- 3 Press one of the buttons for the driving position you want to recall until the buzzer sounds.

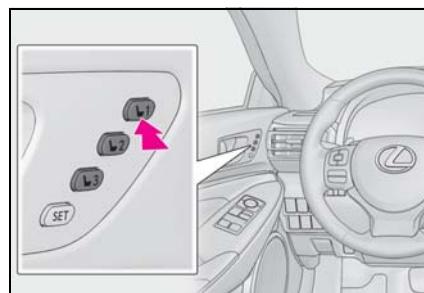

■ To stop the position recall operation part-way through

Perform any of the following:

- Press the "SET" button.

- Press button “1”, “2” or “3”.
- Operate any of the seat adjustment switches (only cancels seat position recall).
- Operate the tilt and telescopic steering control switch (only cancels steering wheel position recall).

■ **Seat positions that can be memorized (→P.99)**

The adjusted positions other than the position adjusted by lumbar support switch can be recorded.

■ **Operating the driving position memory after turning the engine switch off**

Recorded seat positions can be activated up to 180 seconds after the driver’s door is opened and another 60 seconds after it is closed again.

■ **In order to correctly use the driving position memory function**

If a seat position is already in the furthest possible position and the seat is operated in the same direction, the recorded position may be slightly different when it is recalled.

Registering/canceling/recall a driving position to an electronic key (including a card key) (memory recall function) (vehicles with memory recall function)

■ **Registering procedure**

Record your driving position to button “1”, “2” or “3” before performing the following:

Carry only the key you want to register, and then close the driver’s door.

If 2 or more keys are in the vehicle, the driving position cannot be recorded properly.

- 1 Check that the shift lever is in P.

- 2 Turn the engine switch to IGNITION ON mode.
- 3 Recall the driving position that you want to record.
- 4 While pressing the recalled button, press and hold the door lock switch (either lock or unlock) until the buzzer sounds.

If the button could not be registered, the buzzer sounds continuously for approximately 3 seconds.

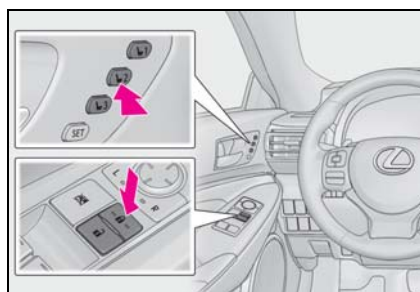

■ **Cancelation procedure**

Carry only the key you want to cancel and then close the driver’s door.

If 2 or more keys are in the vehicle, the driving position cannot be canceled properly.

- 1 Turn the engine switch to IGNITION ON mode.
- 2 While pressing the “SET” button, press and hold the door lock switch (either lock or unlock) until the buzzer sounds twice.

If the button could not be canceled, the buzzer sounds continuously for approximately 3 seconds.

■ **Recall procedure**

- 1 Make sure that the doors are locked before recalling the driving position. Carry the electronic key

that has been registered to the driving position, and then unlock and open the driver's door using the smart access system with push-button start or wireless remote control.

The driving position will move to the recorded position (not including the steering wheel). However, the seat will move to a position slightly behind the recorded position in order to make entering the vehicle easier.

If the driving position is in a position that has already been recorded, the seat and outside rear view mirrors will not move.

- 2 Turn the engine switch to ACCESSORY mode or IGNITION ON mode, or fasten a seat belt.

The seat and steering wheel will move to the recorded position.

■ Recalling the driving position using the memory recall function

- Different driving positions can be registered for each electronic key. Therefore, the driving position that is recalled may be different depending on the key being carried.
- If a door other than the driver's door is unlocked with the smart access system with push-button start, the driving position cannot be recalled. In this case, press the driving position button which has been set.

■ Customization

Some functions can be customized. (→P.351)

Head restraints

Head restraints are provided for all seats.

⚠ WARNING

■ Head restraint precautions

Observe the following precautions regarding the head restraints. Failure to do so may result in death or serious injury.

- Use the head restraints designed for each respective seat.
- Adjust the head restraints to the correct position at all times.
- After adjusting the head restraints, push down on them and make sure they are locked in position.
- Do not drive with the head restraints removed.

Adjusting a head restraint vertically

► Front seats

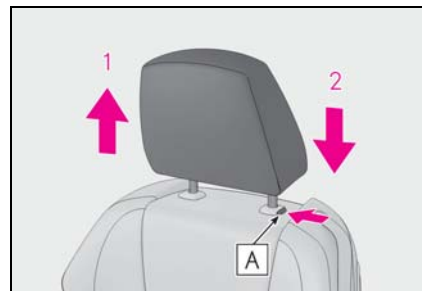

1 Up

Pull the head restraints up.

2 Down

Push the head restraint down while pressing the lock release button **A**.

► Rear seats

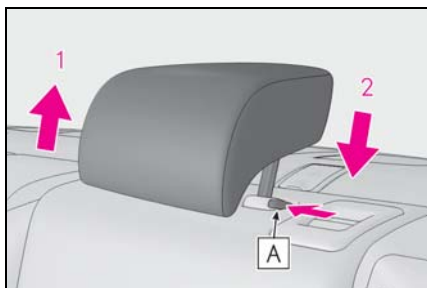

1 Up

Pull the head restraints up.

2 Down

Push the head restraint down while pressing the lock release button **A**.

■ **Adjusting the height of the head restraints**

Make sure that the head restraints are adjusted so that the center of the head restraint is closest to the top of your ears.

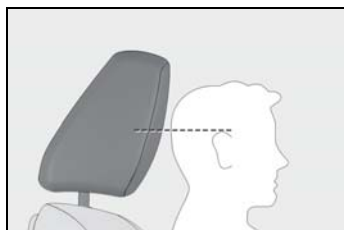

■ **Adjusting the rear seat head restraint**

Always raise the head restraint one level from the stowed position when using.

Adjusting a head restraint horizontally

The position of the head restraint can be adjusted forward in 4 stages.

If the head restraint is pulled forward from the foremost position, it will return to the rearmost position.



Removing the head restraints

Pull the head restraint up while pressing the lock release button **A**.

If the head restraint touches the ceiling, making the removal difficult, change the seat height or angle. (→P.99, 101)

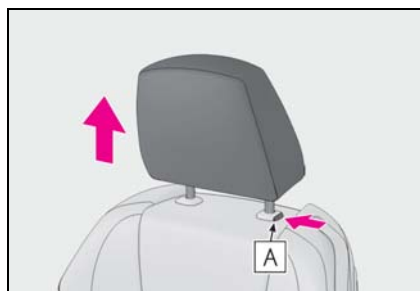

Installing the head restraints

► Front seats

Align the head restraint with the installation holes and push it down to the lock position.

Press and hold the lock release button **A** when lowering the head restraint.

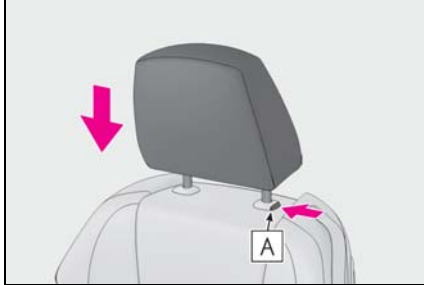

► Rear seats

Align the head restraint with the installation holes and push it down to the lowest lock position while pressing the lock release button **A**.

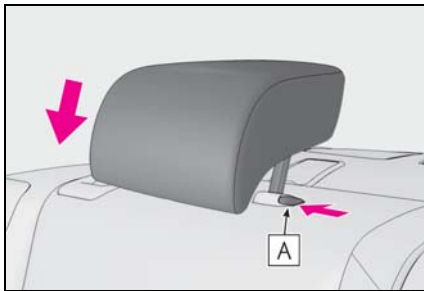

3

Before driving

Steering wheel

Adjustment procedure

► Manual type

- 1 Hold the steering wheel and push the lever down.

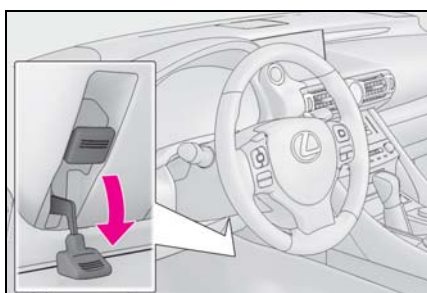

- 2 Adjust to the ideal position by moving the steering wheel horizontally and vertically.

After adjustment, pull the lever up to secure the steering wheel.

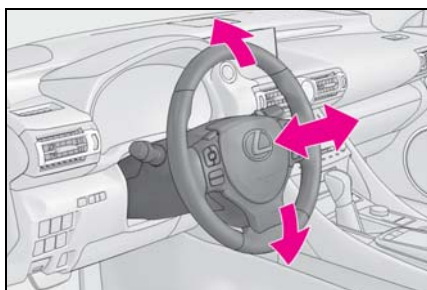

► Power type

Operating the switch moves the steering wheel in the following directions:

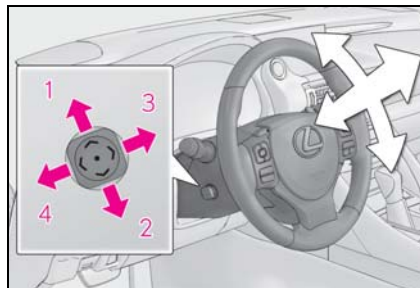

- 1 Up
- 2 Down
- 3 Toward the driver
- 4 Away from the driver

■ The steering wheel can be adjusted when (power type)

The engine switch is in ACCESSORY or IGNITION ON mode*.

*: If the driver's seat belt is fastened, the steering wheel can be adjusted regardless of engine switch mode.

■ Automatic adjustment of the steering position (if equipped)

A desired steering position can be entered to memory and recalled automatically by the driving position memory system. (→P.102)

■ Power easy access system (power type)

The steering wheel and driver's seat move in accordance with engine switch mode and the driver's seat belt condition. (→P.102)

! WARNING

■ Caution while driving

Do not adjust the steering wheel while driving.

Doing so may cause the driver to mishandle the vehicle and cause an accident, resulting in death or serious injury.

! WARNING**■ After adjusting the steering wheel (manual type)**

Make sure that the steering wheel is securely locked.

Otherwise, the steering wheel may move suddenly, possibly causing an accident, and resulting in death or serious injury. Also, the horn may not sound if the steering wheel is not securely locked.

Horn

To sound the horn, press on or close to the  mark.

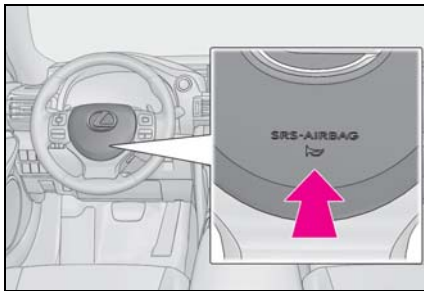
**Inside rear view mirror**

The rear view mirror's position can be adjusted to enable sufficient confirmation of the rear view.

Adjusting the height of rear view mirror

The height of the rear view mirror can be adjusted to suit your driving posture.

Adjust the height of the rear view mirror by moving it up and down.

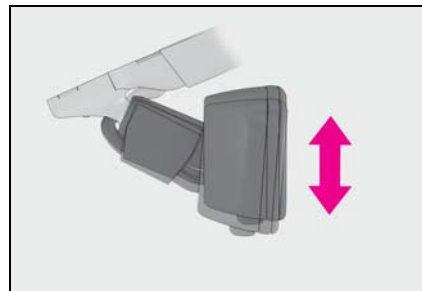
**! WARNING****■ Caution while driving**

Do not adjust the position of the mirror while driving.

Doing so may lead to mishandling of the vehicle and cause an accident, resulting in death or serious injury.

Anti-glare function

Responding to the level of brightness of the headlights of vehicles behind, the reflected light is automatically reduced.

Turn the automatic anti-glare function mode on/off

When the automatic anti-glare function is in ON mode, the indicator **A** illuminates.

The function will set to ON mode each time the engine switch is turned to IGNITION ON mode.

Pressing the button turns the function to OFF mode. (The indicator **A** also turns off.)

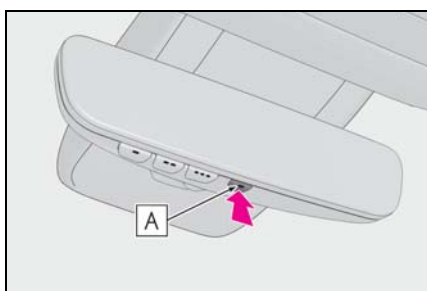

■ To prevent sensor error

To ensure that the sensors operate properly, do not touch or cover them.

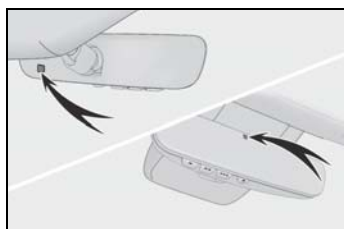

Outside rear view mirrors

The rear view mirror's position can be adjusted to enable sufficient confirmation of the rear view.

⚠ WARNING

■ Important points while driving

Observe the following precautions while driving.

Failure to do so may result in loss of control of the vehicle and cause an accident, resulting in death or serious injury.

- Do not adjust the mirrors while driving.
- Do not drive with the mirrors folded.
- Both the driver and passenger side mirrors must be extended and properly adjusted before driving.

Adjustment procedure

- 1 To select a mirror to adjust, press the switch.

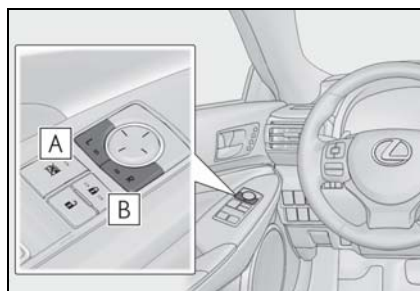

A Left

B Right

Pressing the same switch again will put the switch in neutral.

- 2** To adjust the mirror, press the switch.

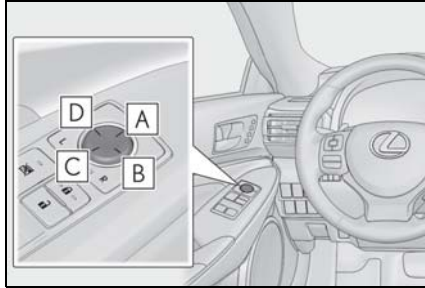

- A** Up
- B** Right
- C** Down
- D** Left

■ Mirror angle can be adjusted when

The engine switch is in ACCESSORY or IGNITION ON mode.

■ Defogging the mirrors

The outside rear view mirrors can be cleared using the mirror defoggers. Turn on the rear window defogger to turn on the outside rear view mirror defoggers. (→P.219)

■ Auto anti-glare function (if equipped)

When the anti-glare inside rear view mirror is set to automatic mode, the outside rear view mirrors will activate in conjunction with the anti-glare inside rear view mirror to reduce reflected light. (→P.109)

■ Automatic adjustment of the mirror angle (if equipped)

A desired mirror face angle can be entered to memory and recalled automatically by the driving position memory. (→P.102)

■ Linked mirror function when reversing (if equipped)

When either "L" or "R" of the mirror select switch is selected, the outside rear view mirrors will automatically angle downwards when the vehicle is reversing in order to give a better view of the ground.

To disable this function, select neither "L" nor "R".

To set the mirror angle used when the vehicle is reversing, adjust the mirror angle at a desired position with the shift lever in R.

The adjusted angle will be memorized and the mirror will automatically tilt to the memorized angle whenever the shift lever is shifted to R from next time.

The memorized downward tilt position of the mirror is linked to the normal position (angle adjusted with the shift lever in other than R). Therefore, if the normal position is changed after adjustment, the tilt position will also change.

When the normal position is changed, readjust the angle in reversing.

WARNING

■ When the mirror defoggers are operating

Do not touch the rear view mirror surfaces, as they can become very hot and burn you.

Folding the mirrors

Push the mirror back in the direction of the vehicle's rear.

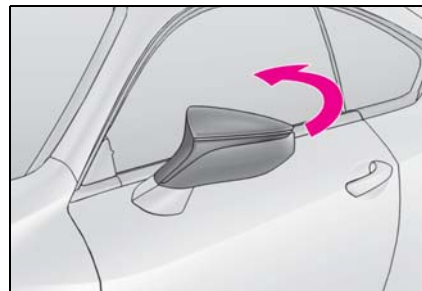

3

Before driving

Power windows

Opening and closing the power windows

The power windows can be opened and closed using the switches.

Operating the switch moves the windows as follows:

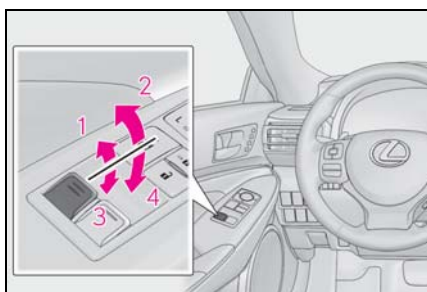

- 1 Closing
- 2 One-touch closing *
- 3 Opening
- 4 One-touch opening *

* : To stop the window partway, operate the switch in the opposite direction.

■ The power windows can be operated when

The engine switch is in IGNITION ON mode.

■ Operating the power windows after turning the engine off

The power windows can be operated for approximately 45 seconds after the engine switch is turned to ACCESSORY mode or turned off. They cannot, however, be operated once either door is opened.

■ Jam protection function

If an object becomes jammed between the window and the window frame while the window is closing, window movement is stopped and the window is opened slightly.

■ Catch protection function

If an object becomes caught between the door and window while the window is opening, window movement is stopped.

■ When the window cannot be opened or closed

When the jam protection function or catch protection function operates unusually and the door window cannot be opened or closed, perform the following operations with the power window switch of that door.

- Stop the vehicle. With the engine switch in IGNITION ON mode, within 4 seconds of the jam protection function or catch protection function activating, continuously operate the power window switch in the one-touch closing direction or one-touch opening direction so that the door window can be opened and closed.

- If the door window cannot be opened and closed even when performing the above operations, perform the following procedure for function initialization.

- 1 Turn the engine switch to IGNITION ON mode.
- 2 Pull and hold the power window switch in the one-touch closing direction and completely close the door window.
- 3 Release the power window switch for a moment, resume pulling the switch in the one-touch closing direction, and hold it there for approximately 6 seconds or more.
- 4 Press and hold the power window switch in the one-touch opening direction. After the door window is completely opened, continue holding the switch for an additional 1 second or more.
- 5 Release the power window switch for a moment, resume pushing the switch in the one-touch opening direction, and hold it there for approximately 4 seconds or more.
- 6 Pull and hold the power window switch in the one-touch closing direction again. After the door window is completely closed, continue holding the switch for a further 1 second or more.

If you release the switch while the window is moving, start again from the beginning. If the window reverses and cannot be fully closed or opened, have the vehicle inspected by your Lexus dealer.

■ Door lock linked window operation

- The power windows can be opened and closed using the mechanical key.* (→P.318)
- The power windows can be opened using the wireless remote control.* (→P.88)

*: These settings must be customized at your Lexus dealer.

■ Power windows open warning buzzer

A buzzer sounds and a message is shown on the multi-information display in the instrument cluster when the engine switch is turned off and the driver's door is opened with the power windows open.

■ Customization

Some functions can be customized. (→P.351)



WARNING

Observe the following precautions. Failure to do so may result in death or serious injury.

■ Closing the windows

- The driver is responsible for all the power window operations, including the operation for the passengers. In order to prevent accidental operation, especially by a child, do not let a child operate the power windows. It is possible for children and other passengers to have body parts caught in the power window. Also, when riding with a child, it is recommended to use the window lock switch. (→P.113)
- Check to make sure that all passengers do not have any part of their body in a position where it could be caught when a window is being operated.

- When using the wireless remote control or mechanical key and operating the power windows, operate the power window after checking to make sure that there is no possibility of any passenger having any of their body parts caught in the window. Also do not let a child operate window by the wireless remote control or mechanical key. It is possible for children and other passengers to get caught in the power window.

- When exiting the vehicle, turn the engine switch off, carry the key and exit the vehicle along with the child. There may be accidental operation, due to mischief, etc., that may possibly lead to an accident.

■ Jam protection function

- Never use any part of your body to intentionally activate the jam protection function.
- The jam protection function may not work if something gets jammed just before the window is fully closed. Be careful not to get any part of your body jammed in the window.

■ Catch protection function

- Never use any part of your body or clothing to intentionally activate the catch protection function.
- The catch protection function may not work if something gets caught just before the window is fully opened. Be careful not to get any part of your body or clothing caught in the window.

Preventing accidental operation (window lock switch)

This function can be used to prevent children from accidentally opening or closing a passenger window.

Press the switch.

The indicator **A** will come on and the pas-

senger windows will be locked.

The passenger window can still be opened and closed using the driver's switch even if the lock switch is on.

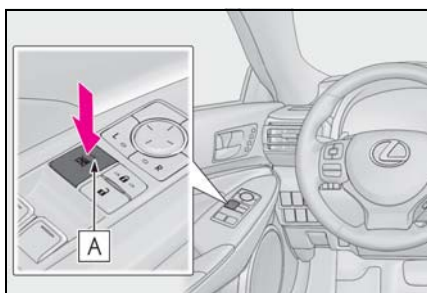

■ When the battery is disconnected

The window lock switch is disabled. If necessary, press the window lock switch after reconnecting the battery.

Moon roof*

*: If equipped

Use the overhead switches to open and close the moon roof and tilt it up and down.

Operating the moon roof

■ Opening and closing

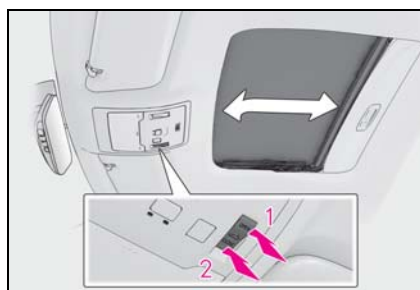

1 Opens the moon roof*

The moon roof tilts up and then fully opens.

2 Closes the moon roof*

*: Lightly press either way of the moon roof switch to stop the moon roof partway.

■ Tilting up and down

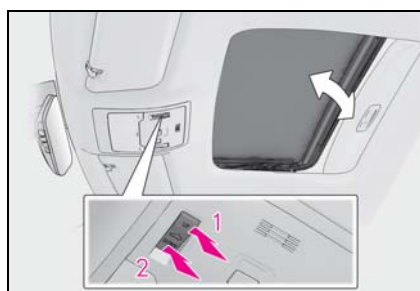

1 Tilts the moon roof up*

2 Tilts the moon roof down*

*: Lightly press either way of the moon roof switch to stop the moon roof partway.

■ The moon roof can be operated when

The engine switch is in IGNITION ON mode.

■ Operating the moon roof after turning the engine off

The moon roof can be operated for approximately 45 seconds after the engine switch is turned to ACCESSORY mode or turned off. It cannot, however, be operated once either door is opened.

■ Jam protection function

If an object is detected between the moon roof and the frame while the moon roof is closing or tilting down, travel is stopped and the moon roof opens slightly.

■ Sunshade

The sunshade can be opened and closed manually. However, the sunshade will open automatically when the moon roof is opened.

■ Door lock linked moon roof operation

- The moon roof can be opened and closed using the mechanical key.* (→P.318)
- The moon roof can be opened using the wireless remote control.* (→P.86)

* : These settings must be customized at your Lexus dealer.

■ If the moon roof does not close normally

Perform the following procedure:

- 1 Stop the vehicle.
- 2 Press and hold the "CLOSE" switch.*

The moon roof will close, reopen and pause for approximately 10 seconds. Then it will close again and stop at the completely closed position.

- 3 Check to make sure that the moon roof is completely closed and then release the switch.

* : If the switch is released at the incorrect time, the procedure will have to be performed again from the beginning.

If the moon roof does not fully close even after performing the above procedure cor-

rectly, have the vehicle inspected by your Lexus dealer.

■ If the moon roof does not move normally

If the moon roof does not open or close normally or the automatic opening function does not operate, perform the following initialization procedure.

- 1 Turn the engine switch to IGNITION ON mode.
- 2 Operate the moon roof.

Depending on the kind of malfunction perform either of the following:

- ▶ If the moon roof does not open when the "OPEN" switch is pressed
- 3 Press and hold the "DOWN" switch or "CLOSE" switch until the moon roof is completely closed.
The moon roof will open and close a few times before it closes completely.
- 4 Confirm that the moon roof has completely stopped and release the switch.
- ▶ If the moon roof does not open completely automatically even though it tilts up and opens while the "OPEN" switch is being pressed and held
- 3 Press and hold the "OPEN" switch until the moon roof opens completely.
- 4 Press and hold the "CLOSE" switch until the moon roof closes completely.
- 5 Press and hold the "UP" switch until the moon roof tilts up and stops.
- 6 Press and hold the "DOWN" switch until the moon roof tilts down and stops at the completely closed position.

If you release the switch while the moon roof is moving, perform the procedure again from the beginning.

If, after performing the above procedures correctly, the moon roof still does not open or close normally or the automatic opening function does not operate, have the vehicle inspected by your Lexus dealer.

■ Moon roof open warning buzzer

A buzzer sounds and a message is shown on the multi-information display in the instrument cluster when the engine switch is turned off and the driver's door is opened with the moon roof open.

■ Customization

Some functions can be customized.
(→P.351)

⚠ WARNING

Observe the following precautions. Failure to do so may cause death or serious injury.

■ Opening the moon roof

- Do not allow any passengers to put their hands or heads outside the vehicle while it is moving.
- Do not sit on top of the moon roof.

■ Opening and closing the moon roof

- The driver is responsible for moon roof opening and closing operations. In order to prevent accidental operation, especially by a child, do not let a child operate the moon roof. It is possible for children and other passengers to have body parts caught in the moon roof.
- Check to make sure that all passengers do not have any part of their body in a position where it could be caught when the moon roof is being operated.

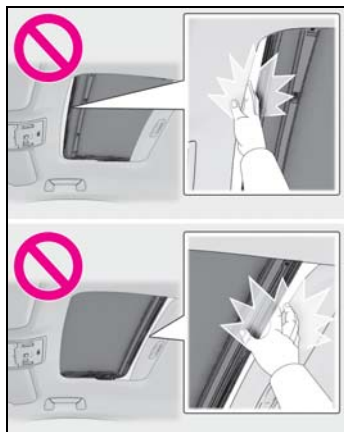

- When using the wireless remote control or mechanical key and operating the moon roof, operate the moon roof after checking to make sure that there is no possibility of any passenger having any of their body parts caught in the moon roof. Also, do not let a child operate moon roof by the wireless remote control or mechanical key. It is possible for children and other passengers to get caught in the moon roof.

- When exiting the vehicle, turn the engine switch off, carry the key and exit the vehicle along with the child. There may be accidental operation, due to mischief, etc., that may possibly lead to an accident.

■ Jam protection function

- Never use any part of your body to intentionally activate the jam protection function.
- The jam protection function may not work if something gets caught just before the moon roof is fully closed. Also, the jam protection function is not designed to operate while the moon roof switch is being pressed. Take care so that your fingers, etc. do not get caught.

⚠ NOTICE

■ To prevent damage to the moon roof

- Before opening, make sure that there are no foreign objects such as stones or ice around the opening.
- Do not hit the face or edge of the moon roof with hard objects.

■ Operating the moon roof

There is the possibility that water or rain will get into the vehicle if you operate the moon roof after a rainfall, snowfall or car wash. Wipe the moon roof dry with a cloth before operating it.

- 4-1. Before driving**
 - Driving the vehicle..... **118**
 - Cargo and luggage..... **123**
 - Vehicle load limits..... **125**
 - Trailer towing..... **126**
 - Dinghy towing **126**
- 4-2. Driving procedures**
 - Engine (ignition) switch **127**
 - Automatic transmission..... **131**
 - Turn signal lever..... **136**
 - Parking brake **137**
 - Brake Hold..... **139**
 - ASC (Active Sound Control)
..... **141**
- 4-3. Operating the lights and wipers**
 - Headlight switch..... **142**
 - AHB (Automatic High Beam)
..... **144**
 - Windshield wipers and washer
..... **147**
- 4-4. Refueling**
 - Opening the fuel tank cap..... **155**
- 4-5. Using the driving support systems**
 - Lexus Safety System + **158**
 - PCS (Pre-Collision System)
..... **162**
 - LDA (Lane Departure Alert with
steering control) **169**
 - Dynamic radar cruise control with
full-speed range..... **176**
 - Intuitive parking assist **185**
 - BSM (Blind Spot Monitor)..... **191**
 - Driving mode select switch ... **199**
 - Driving assist systems..... **201**
- 4-6. Driving tips**
 - Winter driving tips **205**

Driving the vehicle

The following procedures should be observed to ensure safe driving:

Driving procedure

■ Starting the engine

→P.127

■ Driving

- 1 With the brake pedal depressed, shift the shift lever to D. (→P.131)
- 2 If the parking brake is in manual mode, release the parking brake. (→P.137)
- 3 Gradually release the brake pedal and gently depress the accelerator pedal to accelerate the vehicle.

■ Stopping

- 1 With the shift lever in D, depress the brake pedal.
- 2 If necessary, set the parking brake.

If the vehicle is to be stopped for an extended period of time, shift the shift lever to P or N. (→P.131)

■ Parking the vehicle

- 1 With the shift lever in D, depress the brake pedal.
- 2 Set the parking brake (→P.137), and shift the shift lever to P (→P.131).
- 3 Press the engine switch to stop the engine.
- 4 Lock the door, making sure that you have the electronic key on your person.

If parking on a hill, block the wheels as needed.

■ Starting off on a steep uphill

- 1 With the brake pedal depressed, shift the shift lever to D.
- 2 Pull the parking brake switch to set the parking brake manually.
- 3 Release the brake pedal and gently depress the accelerator pedal to accelerate the vehicle.
- 4 Press the parking brake switch to release the parking brake manually.

■ When starting off on an uphill

The hill-start assist control will activate. (→P.201)

■ Driving in the rain

- Drive carefully when it is raining, because visibility will be reduced, the windows may become fogged-up, and the road will be slippery.
- Drive carefully when it starts to rain, because the road surface will be especially slippery.
- Refrain from high speeds when driving on an expressway in the rain, because there may be a layer of water between the tires and the road surface, preventing the steering and brakes from operating properly.

■ Engine speed while driving

In the following conditions, the engine speed may become high while driving. This is due to automatic up-shifting control or down-shifting implementation to meet driving conditions. It does not indicate sudden acceleration.

- The vehicle is judged to be driving uphill or downhill
- When the accelerator pedal is released
- When the brake pedal is depressed while sport mode is selected

■ **Restraining the engine output (Brake Override System)**

- When the accelerator and brake pedals are depressed at the same time, the engine output may be restrained.
- A warning message is displayed on the multi-information display while the system is operating.

■ **Restraining sudden start (Drive-Start Control)**

- When the following unusual operation is performed, the engine output may be restrained.
 - When the shift lever is shifted from R to D, D to R, N to R, P to D, or P to R (D includes M) with the accelerator pedal depressed, a warning message appears on the multi-information display. If a warning message is shown on the multi-information display, read the message and follow the instruction.
 - When the accelerator pedal is depressed too much while the vehicle is in reverse.
- While Drive-Start Control is being activated, your vehicle may have trouble escaping from the mud or fresh snow. In such case, deactivate TRAC (→P.202) to cancel Drive-Start Control so that the vehicle may become able to escape from the mud or fresh snow.

■ **Breaking in your new Lexus**

To extend the life of the vehicle, observing the following precautions is recommended:

- For the first 186 miles (300 km):
Avoid sudden stops.
- For the first 621 miles (1000 km):
 - Do not drive at extremely high speeds.
 - Avoid sudden acceleration.
 - Do not drive continuously in low gears.
 - Do not drive at a constant speed for extended periods.

■ **Drum-in-disc type parking brake system**

Your vehicle has a drum-in-disc type parking brake system. This type of brake system needs bedding-down of the brake shoes periodically or whenever the parking brake shoes and/or drum are replaced. Have your Lexus dealer perform the bedding down operation.

■ **Operating your vehicle in a foreign country**

Comply with the relevant vehicle registration laws and confirm the availability of the correct fuel. (→P.330)

■ **Idling time before engine stop (RC300)**

To prevent damage to the turbocharger, allow the engine to idle immediately after high-load driving.

Driving condition	Idling time
Normal city driving or high-speed driving (at the highway speed limit or recommended speed)	Not necessary
Steep hill driving, continuous driving (race track driving etc.)	Approximately 1 minute

 **WARNING**

Observe the following precautions. Failure to do so may result in death or serious injury.

■ **When starting the vehicle**

Always keep your foot on the brake pedal while stopped with the engine running. This prevents the vehicle from creeping.

■ **When driving the vehicle**

- Do not drive if you are unfamiliar with the location of the brake and accelerator pedals to avoid depressing the wrong pedal.
 - Accidentally depressing the accelerator pedal instead of the brake pedal will result in sudden acceleration that may lead to an accident.
- When backing up, you may twist your body around, leading to a difficulty in operating the pedals. Make sure to operate the pedals properly.

 **WARNING**

- Make sure to keep a correct driving posture even when moving the vehicle only slightly. This allows you to depress the brake and accelerator pedals properly.
- Depress the brake pedal using your right foot. Depressing the brake pedal using your left foot may delay response in an emergency, resulting in an accident.
- Do not drive the vehicle over or stop the vehicle near flammable materials. The exhaust system and exhaust gases can be extremely hot. These hot parts may cause a fire if there is any flammable material nearby.
- During normal driving, do not turn off the engine. Turning the engine off while driving will not cause loss of steering or braking control, but the power assist to these systems will be lost. This will make it more difficult to steer and brake, so you should pull over and stop the vehicle as soon as it is safe to do so.
However, in the event of an emergency, such as if it becomes impossible to stop the vehicle in the normal way:
→P.286
- Use engine braking (downshift) to maintain a safe speed when driving down a steep hill.
Using the brakes continuously may cause the brakes to overheat and lose effectiveness. (→P.131)
- Do not adjust the positions of the steering wheel, the seat, or the inside or outside rear view mirrors while driving.
Doing so may result in a loss of vehicle control.
- Always check that all passengers' arms, heads or other parts of their body are not outside the vehicle.
- Do not drive in excess of the speed limit. Even if the legal speed limit permits it, do not drive over 85 mph (140 km/h) unless your vehicle has high-speed capability tires. Driving over 85 mph (140 km/h) may result in tire failure, loss of control and possible injury. Be sure to consult a tire dealer to determine whether the tires on your vehicle are high-speed capability tires or not before driving at such speeds.

■ When driving on slippery road surfaces

- Sudden braking, acceleration and steering may cause tire slippage and reduce your ability to control the vehicle.
- Sudden acceleration, engine braking due to shifting, or changes in engine speed could cause the vehicle to skid.
- After driving through a puddle, lightly depress the brake pedal to make sure that the brakes are functioning properly. Wet brake pads may prevent the brakes from functioning properly. If the brakes on only one side are wet and not functioning properly, steering control may be affected.

■ When shifting the shift lever

- Do not let the vehicle roll backward while the shift lever is in a driving position, or roll forward while the shift lever is in R.
Doing so may cause the engine to stall or lead to poor brake and steering performance, resulting in an accident or damage to the vehicle.
- Do not shift the shift lever to P while the vehicle is moving.
Doing so can damage the transmission and may result in a loss of vehicle control.
- Do not shift the shift lever to a driving position while the vehicle is moving backward.
Doing so can damage the transmission and may result in a loss of vehicle control.

**WARNING**

- Do not shift the shift lever to R while the vehicle is moving forward. Doing so can damage the transmission and may result in a loss of vehicle control.
- Moving the shift lever to N while the vehicle is moving will disengage the engine from the transmission. Engine braking is not available when N is selected.
- Be careful not to shift the shift lever with the accelerator pedal depressed. Shifting the shift lever to a gear other than P or N may lead to unexpected rapid acceleration of the vehicle that may cause an accident and result in death or serious injury.

■ **If you hear a squealing or scraping noise (brake pad wear limit indicators)**

Have the brake pads checked and replaced by your Lexus dealer as soon as possible. Rotor damage may result if the pads are not replaced when needed.

It is dangerous to drive the vehicle when the wear limits of the brake pads and/or those of the brake discs are exceeded.

■ **When the vehicle is stopped**

- Do not race the engine. If the vehicle is in any gear other than P or N, the vehicle may accelerate suddenly and unexpectedly, causing an accident.
- In order to prevent accidents due to the vehicle rolling away, always keep depressing the brake pedal while the engine is running, and apply the parking brake as necessary.
- If the vehicle is stopped on an incline, in order to prevent accidents caused by the vehicle rolling forward or backward, always depress the brake pedal and securely apply the parking brake as needed.

- Avoid revving or racing the engine. Running the engine at high speed while the vehicle is stopped may cause the exhaust system to overheat, which could result in a fire if combustible material is nearby.

■ **When the vehicle is parked**

- Do not leave glasses, cigarette lighters, spray cans, or soft drink cans in the vehicle when it is in the sun. Doing so may result in the following:
 - Gas may leak from a cigarette lighter or spray can, and may lead to a fire.
 - The temperature inside the vehicle may cause the plastic lenses and plastic material of glasses to deform or crack.
 - Soft drink cans may fracture, causing the contents to spray over the interior of the vehicle, and may also cause a short circuit in the vehicle's electrical components.
- Do not leave cigarette lighters in the vehicle. If a cigarette lighter is in a place such as the glove box or on the floor, it may be lit accidentally when luggage is loaded or the seat is adjusted, causing a fire.
- Do not attach adhesive discs to the windshield or windows. Do not place containers such as air fresheners on the instrument panel or dashboard. Adhesive discs or containers may act as lenses, causing a fire in the vehicle.
- Do not leave a door or window open if the curved glass is coated with a metallized film such as a silver-colored one. Reflected sunlight may cause the glass to act as a lens, causing a fire.

**WARNING**

- Always apply the parking brake, shift the shift lever to P, stop the engine and lock the vehicle.
Do not leave the vehicle unattended while the engine is running.
If the vehicle is parked with the shift lever in P but the parking brake is not set, the vehicle may start to move, possibly leading to an accident.
- Do not touch the exhaust pipes while the engine is running or immediately after turning the engine off.
Doing so may cause burns.

■ When taking a nap in the vehicle

Always turn the engine off. Otherwise, if you accidentally move the shift lever or depress the accelerator pedal, this could cause an accident or fire due to engine overheating. Additionally, if the vehicle is parked in a poorly ventilated area, exhaust gases may collect and enter the vehicle, leading to death or a serious health hazard.

■ When braking

- When the brakes are wet, drive more cautiously.
Braking distance increases when the brakes are wet, and this may cause one side of the vehicle to brake differently than the other side. Also, the parking brake may not securely hold the vehicle.
- If the brake booster device does not operate, do not follow other vehicles closely and avoid hills or sharp turns that require braking.
In this case, braking is still possible, but the brake pedal should be depressed more firmly than usual. Also, the braking distance will increase. Have your brakes fixed immediately.
- Do not pump the brake pedal if the engine stalls.
Each push on the brake pedal uses up the reserve for the power-assisted brakes.

- The brake system consists of 2 individual hydraulic systems; if one of the systems fails, the other will still operate. In this case, the brake pedal should be depressed more firmly than usual and the braking distance will increase.
Have your brakes fixed immediately.

■ If the vehicle becomes stuck

Do not spin the wheels excessively when any of the tires is up in the air, or the vehicle is stuck in sand, mud, etc. This may damage the driveline components or propel the vehicle forward or backward, causing an accident.

**NOTICE****■ When driving the vehicle**

- Do not depress the accelerator and brake pedals at the same time while driving, as this may restrain the engine output.
- Do not use the accelerator pedal or depress the accelerator and brake pedals at the same time to hold the vehicle on a hill.

■ When parking the vehicle

Always set the parking brake and shift the shift lever to P. Failure to do so may cause the vehicle to move or the vehicle may accelerate suddenly if the accelerator pedal is accidentally depressed.

■ Avoiding damage to vehicle parts

- Do not turn the steering wheel fully in either direction and hold it there for an extended period of time. Doing so may damage the power steering motor.
- When driving over bumps in the road, drive as slowly as possible to avoid damaging the wheels, underside of the vehicle, etc.

 NOTICE

- RC300: Make sure to idle the engine immediately after high-load driving. Stop the engine only after the turbocharger has cooled down. Failure to do so may cause damage to the turbocharger.

■ If you get a flat tire while driving

A flat or damaged tire may cause the following situations. Hold the steering wheel firmly and gradually depress the brake pedal to slow down the vehicle.

- It may be difficult to control your vehicle.
- The vehicle will make abnormal sounds or vibrations.
- The vehicle will lean abnormally.

Information on what to do in case of a flat tire (→P.307)

■ When encountering flooded roads

Do not drive on a road that has flooded after heavy rain etc. Doing so may cause the following serious damage to the vehicle:

- Engine stalling
- Short in electrical components
- Engine damage caused by water immersion

In the event that you drive on a flooded road and the vehicle is flooded, be sure to have your Lexus dealer check the following:

- Brake function
- Changes in quantity and quality of oil and fluid used for the engine, transmission, transfer (AWD models), differential, etc.
- Lubricant condition for the propeller shaft, bearings and suspension joints (where possible), and the function of all joints, bearings, etc.

Cargo and luggage

Take notice of the following information about storage precautions, cargo capacity and load:

Capacity and distribution

Cargo capacity depends on the total weight of the occupants.

$$(\text{Cargo capacity}) = (\text{Total load capacity}) - (\text{Total weight of occupants})$$

Steps for Determining Correct Load Limit –

(1) Locate the statement “The combined weight of occupants and cargo should never exceed XXX kg or XXX lbs.” on your vehicle’s placard.

(2) Determine the combined weight of the driver and passengers that will be riding in your vehicle.

(3) Subtract the combined weight of the driver and passengers from XXX kg or XXX lbs.

(4) The resulting figure equals the available amount of cargo and luggage load capacity.

For example, if the “XXX” amount equals 1400 lbs. and there will be five 150 lb passengers in your vehicle, the amount of available cargo and luggage load capacity is 650 lbs. (1400 - 750 (5 × 150) = 650 lbs.)

(5) Determine the combined weight of luggage and cargo being loaded on the vehicle. That weight may not safely exceed the available cargo and lug-

gage load capacity calculated in Step 4.

(6) If your vehicle will be towing a trailer, load from your trailer will be transferred to your vehicle. Consult this manual to determine how this reduces the available cargo and luggage load capacity of your vehicle. (→P.125)

Lexus does not recommend towing a trailer with your vehicle. Your vehicle is not designed for trailer towing.

Calculation formula for your vehicle

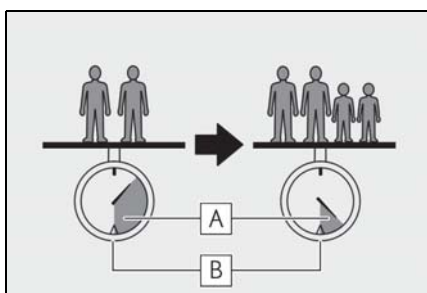

- A** Cargo capacity
- B** Total load capacity (vehicle capacity weight) (→P.328)

When 2 people with the combined weight of A lb. (kg) are riding in your vehicle, which has a total load capacity (vehicle capacity weight) of B lb. (kg), the available amount of cargo and luggage load capacity will be C lb. (kg) as follows:

$$B^{*2} \text{ lb. (kg)} - A^{*1} \text{ lb. (kg)} = C^{*3} \text{ lb. (kg)}$$

^{*1}: A =Weight of people
^{*2}: B =Total load capacity

^{*3}: C =Available cargo and luggage load

In this condition, if 2 more passengers with the combined weight of D lb. (kg) get on, the available cargo and luggage load will be reduced E lb. (kg) as follows:

$$C \text{ lb. (kg)} - D^{*4} \text{ lb. (kg)} = E^{*5} \text{ lb. (kg)}$$

^{*4}: D =Additional weight of people

^{*5}: E =Available cargo and luggage load

As shown in the example above, if the number of occupants increases, the cargo and luggage load will be reduced by an amount that equals the increased weight due to the additional occupants. In other words, if an increase in the number of occupants causes an excess of the total load capacity (combined weight of occupants plus cargo and luggage load), you must reduce the cargo and luggage on your vehicle.

WARNING

Things that must not be carried in the trunk

The following things may cause a fire if loaded in the trunk:

- Receptacles containing gasoline
- Aerosol cans

Storage precautions

Observe the following precautions. Failure to do so may prevent the pedals from being depressed properly, may block the driver's vision, or may result in items hitting the driver or passengers, possibly causing an accident.

- Stow cargo and luggage in the trunk whenever possible.

⚠ WARNING

- To prevent cargo and luggage from sliding forward during braking, do not stack anything in the enlarged trunk. Keep cargo and luggage low, as close to the floor as possible.
- When you fold down the rear seats, long items should not be placed directly behind the front seats.
- Never allow anyone to ride in the enlarged trunk. It is not designed for passengers. They should ride in their seats with their seat belts properly fastened.
- Do not place cargo or luggage in or on the following locations.
 - At the feet of the driver
 - On the front passenger or rear seats (when stacking items)
 - On the package tray
 - On the instrument panel
 - On the dashboard
 - In front of the Center Display
- Secure all items in the occupant compartment.
- **Capacity and distribution**
 - Do not exceed the maximum axle weight rating or the total vehicle weight rating.
 - Even if the total load of occupant's weight and the cargo load is less than the total load capacity, do not apply the load unevenly. Improper loading may cause deterioration of steering or braking control which may cause death or serious injury.

Vehicle load limits

Vehicle load limits include total load capacity, seating capacity, towing capacity and cargo capacity.

- Total load capacity (vehicle capacity weight): →P.328

Total load capacity means the combined weight of occupants, cargo and luggage.

- Seating capacity: →P.328

Seating capacity means the maximum number of occupants whose estimated average weight is 150 lb. (68 kg) per person.

- Towing capacity

Lexus does not recommend towing a trailer with your vehicle.

- Cargo capacity

Cargo capacity may increase or decrease depending on the weight and the number of occupants.

■ Total load capacity and seating capacity

These details are also described on the tire and loading information label. (→P.273)

⚠ WARNING**■ Overloading the vehicle**

Do not overload the vehicle. It may not only cause damage to the tires, but also degrade steering and braking ability, resulting in an accident.

Trailer towing

Lexus does not recommend towing a trailer with your vehicle. Lexus also does not recommend the installation of a tow hitch or the use of a tow hitch carrier for a wheelchair, scooter, bicycle, etc. Your vehicle is not designed for trailer towing or for the use of tow hitch mounted carriers.



Dinghy towing

Your vehicle is not designed to be dinghy towed (with 4 wheels on the ground) behind a motor home.

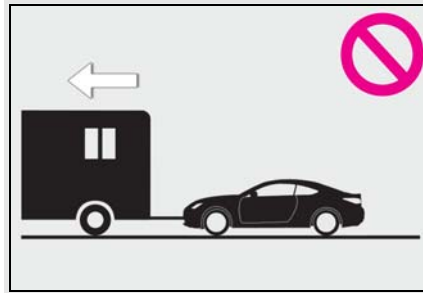

NOTICE

■ To avoid serious damage to your vehicle

Do not tow your vehicle with the four wheels on the ground.

Engine (ignition) switch

Performing the following operations when carrying the electronic key on your person starts the engine or changes engine switch modes.

Starting the engine

- 1 Check that the parking brake is set.
- 2 Check that the shift lever is in P.
- 3 Firmly depress the brake pedal.
 and a message will be displayed on the multi-information display. If it is not displayed, the engine cannot be started.
- 4 Press the engine switch shortly and firmly.

When operating the engine switch, one short, firm press is enough.

It is not necessary to press and hold the switch.

The engine will crank until it starts or for up to 30 seconds, whichever is less.

Continue depressing the brake pedal until the engine is completely started.

The engine can be started from any engine switch mode.



■ If the engine does not start

- The engine immobilizer system may not

have been deactivated. (→P.56)
Contact your Lexus dealer.

- Check that the shift lever is securely set in P. The engine may not start if the shift lever is displaced out of P. "To Start Vehicle. Put Shift Lever into P" will be displayed on the multi-information display.

■ Electronic key battery depletion

→P.84

■ Conditions affecting operation

→P.96

■ Notes for the entry function

→P.97

■ Steering lock function

- After turning the engine switch off and opening and closing the doors, the steering wheel will be locked due to the steering lock function. Operating the engine switch again automatically cancels the steering lock.

- When the steering lock cannot be released, "Steering Wheel Lock Press Engine Switch while Turning Wheel" will be displayed on the multi-information display. Check that the shift lever is in P. Press the engine switch while turning the steering wheel left and right.

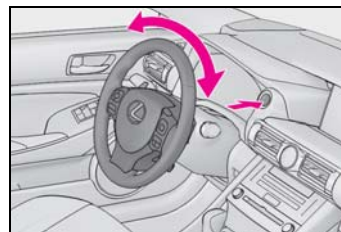

- To prevent the steering lock motor from overheating, operation of the motor may be suspended if the engine is turned on and off repeatedly in a short period of time. In this case, refrain from operating the engine switch. After about 10 seconds, the steering lock motor will resume functioning.

■ **When “Access System with Elec. Key Malfunction See Owner’s Manual” is displayed on the multi-information display**

The system may be malfunctioning. Have the vehicle inspected by your Lexus dealer immediately.

■ **Electronic key battery**

→P.277

■ **Operation of the engine switch**

- If the switch is not pressed shortly and firmly, the engine switch mode may not change or the engine may not start.
- If attempting to restart the engine immediately after turning the engine switch off, the engine may not start in some cases. After turning the engine switch off, please wait a few seconds before restarting the engine.

■ **Customization**

If the smart access system with push-button start has been deactivated in a customized setting, refer to P.317.



WARNING

■ **When starting the engine**

Always start the engine while sitting in the driver’s seat. Do not depress the accelerator pedal while starting the engine under any circumstances. Doing so may cause an accident resulting in death or serious injury.

■ **Caution while driving**

If engine failure occurs while the vehicle is moving, do not lock or open the doors until the vehicle reaches a safe and complete stop. Activation of the steering lock in this circumstance may lead to an accident, resulting in death or serious injury.



NOTICE

■ **When starting the engine**

- Do not race a cold engine.

- If the engine becomes difficult to start or stalls frequently, have your vehicle checked by your Lexus dealer immediately.

■ **Symptoms indicating a malfunction with the engine switch**

If the engine switch seems to be operating somewhat differently than usual, such as the switch sticking slightly, there may be a malfunction. Contact your Lexus dealer immediately.

Stopping the engine

- 1 Stop the vehicle.
- 2 Set the parking brake (→P.137), and shift the shift lever to P.
- 3 Press the engine switch.
- 4 Release the brake pedal and check that the display on the meters is off.

■ **Automatic engine shut off feature**

- The vehicle is equipped with a feature that automatically shuts off the engine when the shift lever is in P with the engine running for an extended period.
- The engine will automatically shut off after approximately 1 hour if it has been left running while the shift lever is in P.
- The timer for the automatic engine shut off feature will reset if the brake pedal is depressed or if the shift lever is in a position other than P.
- After the vehicle is parked, if the door is locked with the door lock switch (→P.90) from the inside or the mechanical key (→P.317) from the outside, the automatic engine shut off feature will be disabled. The timer for the automatic engine shut off feature will be re-enabled if the driver’s door is opened.

■ Locking the door from outside with the engine running

- 1 With the driver's door open, pull the driver's door handle and insert the mechanical key.



- 2 Turn the mechanical key counterclockwise.

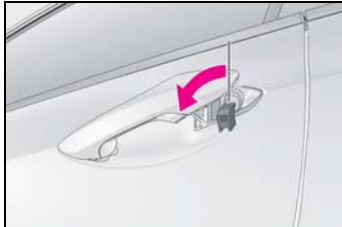

- 3 Pull out the mechanical key and close the door.

⚠ WARNING

■ Stopping the engine in an emergency

If you want to stop the engine in an emergency while driving the vehicle, press and hold the engine switch for more than 2 seconds, or press it briefly 3 times or more in succession. (→P.286)

However, do not touch the engine switch while driving except in an emergency. Turning the engine off while driving will not cause loss of steering or braking control, but the power assist to these systems will be lost. This will make it more difficult to steer and brake, so you should pull over and stop the vehicle as soon as it is safe to do so.

■ When parking

Exhaust gases include harmful carbon monoxide (CO), which is colorless and odorless. Observe the following precautions.

Failure to do so may cause exhaust gases to enter the vehicle and may lead to an accident caused by light-headedness, or may lead to death or a serious health hazard.

- If the vehicle is in a poorly ventilated area or a closed area, such as a garage, stop the engine.
- Do not leave the vehicle with the engine running for a long time. If such a situation cannot be avoided, park the vehicle in an open space and ensure that exhaust fumes do not enter the vehicle interior.
- Do not leave the engine running in an area with snow build-up, or where it is snowing. If snowbanks build up around the vehicle while the engine is running, exhaust gases may collect and enter the vehicle.

Changing engine switch modes

Modes can be changed by pressing the engine switch with brake pedal released. (The mode changes each time the switch is pressed.)

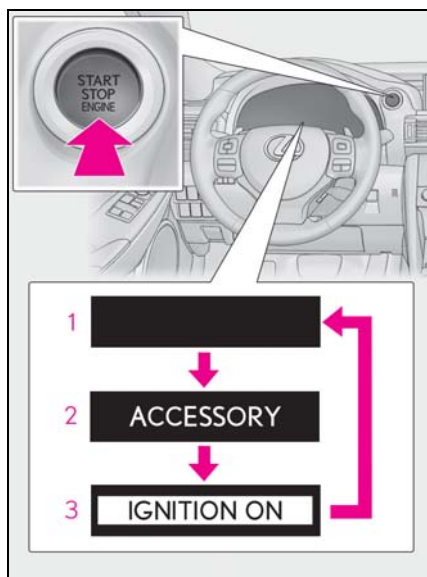
**1** Off*

The emergency flashers can be used.

2 ACCESSORY mode

Some electrical components such as the audio system can be used.

"ACCESSORY" will be displayed on the meters.

3 IGNITION ON mode

All electrical components can be used.

"IGNITION ON" will be displayed on the meters.

*: If the shift lever is in a position other than P when turning off the engine, the engine switch will be turned to ACCESSORY mode, not to off.

■ Auto power off function

If the vehicle is left in ACCESSORY mode for more than 20 minutes or IGNITION ON mode (with the engine not running) for more than an hour with the shift lever in P, the engine switch will automatically turn off. However, this function cannot entirely prevent battery discharge. Do not leave the vehicle with the engine switch in ACCES-

SORY or IGNITION ON mode for long periods of time when the engine is not running.

⚠ NOTICE**■ To prevent battery discharge**

- Do not leave the engine switch in ACCESSORY or IGNITION ON mode for long periods of time without the engine running.
- If "ACCESSORY" or "IGNITION ON" is displayed on the meters while the engine is not running, the engine switch is not off. Exit the vehicle after turning the engine switch off.

When stopping the engine with the shift lever in a position other than P

If the engine is stopped with the shift lever in a position other than P, the engine switch will not be turned off but instead be turned to ACCESSORY mode. Perform the following procedure to turn the switch off:

- 1** Check that the parking brake is set.
- 2** Shift the shift lever to P.
- 3** Check that "Turn Off Vehicle" is displayed on the multi-information display and then press the engine switch once.
- 4** Check that "Turn Off Vehicle" on the multi-information display is off.

**NOTICE****■ To prevent battery discharge**

Do not stop the engine when the shift lever is in a position other than P. If the engine is stopped in another shift lever position, the engine switch will not be turned off but instead be turned to ACCESSORY mode. If the vehicle is left in ACCESSORY mode, battery discharge may occur.

Automatic transmission

Select the shift position depending on your purpose and situation.

Shift position purpose and functions

Shift position	Objective or function
P	Parking the vehicle/starting the engine
R	Reversing
N	Neutral (Condition in which the power is not transmitted)
D	Normal driving ^{*1}
M	M mode driving ^{*2} (→P.134)

^{*1}: To improve fuel efficiency and reduce noise, shift the shift lever to D for normal driving.

^{*2}: Any gear range can be fixed when driving in M mode.

■ To protect the automatic transmission

If the automatic transmission fluid temperature is high, "Transmission Fluid Temp High See Owner's Manual" will be displayed on the multi-information display and the vehicle will go into transmission protection mode automatically. Have the vehicle inspected by your Lexus dealer.

■ When driving with dynamic radar cruise control with full-speed range activated

Even when performing the following actions with the intent of enabling engine braking, engine braking will not occur because dynamic radar cruise control with full-speed range will not be canceled.

- 6-speed models: While driving in the D

position, downshifting to 5 or 4.
(→P.133)

- 8-speed models: While driving in the D position, downshifting to 7, 6, 5 or 4.
(→P.133)
- When switching the driving mode to sport mode while driving in the D position. (→P.199)

■ **Restraining sudden start (Drive-Start Control)**

→P.119

■ **AI-SHIFT**

The AI-SHIFT automatically selects the suitable gear according to driver performance and driving conditions.

The AI-SHIFT automatically operates when the shift lever is in D. (Shifting the shift lever to the M position cancels the function.)

⚠ WARNING

■ **When driving on slippery road surfaces**

Be careful of downshifting and sudden acceleration, as this could result in the vehicle skidding to the side or spinning.

Shifting the shift lever

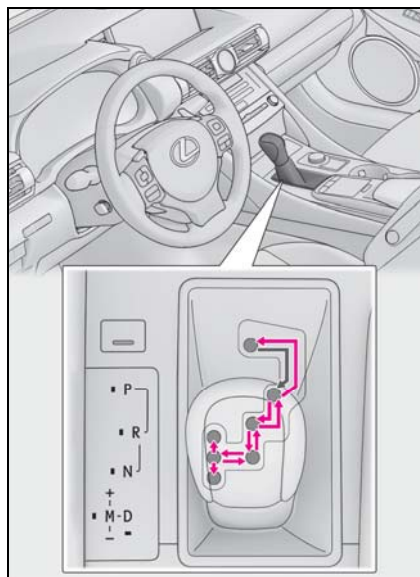

← While the engine switch is in IGNITION ON mode, move the shift lever with the brake pedal depressed.

When shifting the shift lever between P and D, make sure that the vehicle is completely stopped.

■ **Shift lock system**

The shift lock system is a system to prevent accidental operation of the shift lever in starting.

The shift lever can be shifted from P only when the engine switch is in IGNITION ON mode and the brake pedal is being depressed.

■ **If the shift lever cannot be shifted from P**

First, check whether the brake pedal is being depressed.

If the shift lever cannot be shifted with your foot on the brake pedal, there may be a problem with the shift lock system. Have the vehicle inspected by your Lexus dealer immediately.

The following steps may be used as an

emergency measure to ensure that the shift lever can be shifted.

Releasing the shift lock:

- 1 Turn the engine switch to IGNITION ON mode and check that the parking brake is set. (→P.129, 137)
- 2 Turn the engine switch to off.
- 3 Depress the brake pedal.
- 4 Pry the cover up with a flathead screwdriver or equivalent tool.

To prevent damage to the cover, cover the tip of the screwdriver with a rag.

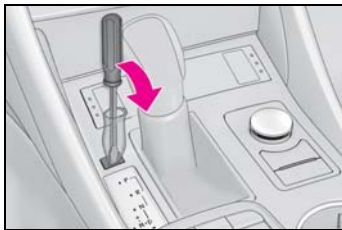

- 5 Press the shift lock override button.

The shift lever can be shifted while the button is pressed.



⚠ WARNING

■ To prevent an accident when releasing the shift lock

Before pressing the shift lock override button, make sure to set the parking brake and depress the brake pedal. If the accelerator pedal is accidentally depressed instead of the brake pedal when the shift lock override button is pressed and the shift lever is shifted out of P, the vehicle may suddenly start, possibly leading to an accident resulting in death or serious injury.

Selecting the driving mode

■ Sport mode/Eco drive mode

→P.199

■ Snow mode

Snow mode can be selected to suit the conditions when driving on slippery road surfaces, such as snow.

Press the switch.

Press the switch again to return to normal mode.

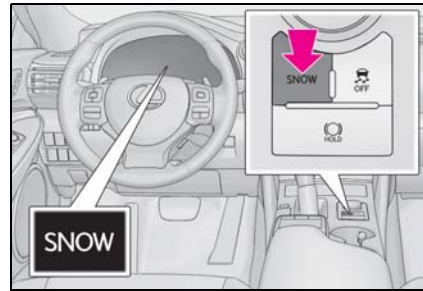

■ Snow mode automatic deactivation

Snow mode is automatically deactivated if the engine switch is turned off after driving in snow mode.

Selecting shift ranges in the D position

To drive using temporary shift range selection, operate the “-” or “+” paddle shift switch.

When the “-” paddle shift switch is operated, the shift range will be downshifted to a range that enables engine braking force that is suitable to driving conditions. When the “+” paddle shift switch is operated, the shift range will be one gear higher than the gear in use during normal D position driving.

Changing the shift range allows restriction of the highest gear, preventing unnecessary upshifting and enabling the level of engine braking force to be selected.

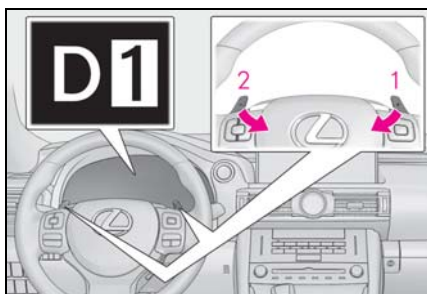

1 Upshifting

2 Downshifting

8-speed models: The selected shift range, from D1 to D8, will be displayed on the meter.

6-speed models: The selected shift range, from D1 to D6, will be displayed on the meter.

To return to normal D position driving, the "+" paddle shift switch must be held down for a period of time.

Meter display	Function
D2 - D8 (8-speed models)	A gear in the range between 1 and the selected gear is automatically chosen depending on vehicle speed and driving conditions
D2 - D6 (6-speed models)	
D1	Setting the gear at 1

A lower shift range will provide greater engine braking forces than a higher shift range.

Automatic deactivation of shift range selection in the D position

Shift range selection in the D position will be deactivated in the following situations:

- When the vehicle comes to a stop
- If the accelerator pedal is depressed for more than a certain period of time
- When the shift lever is shifted to a position other than D

Downshifting restriction warning buzzer

To help ensure safety and driving performance, downshifting operation may sometimes be restricted. In some circumstances, downshifting may not be possible even when the paddle shift switch is operated. (A buzzer will sound twice.)

Selecting gears in the M position

To enter M mode, shift the shift lever to M. Gears can then be selected by operating the shift lever or paddle shift switches, allowing you to drive in the gear of your choosing.

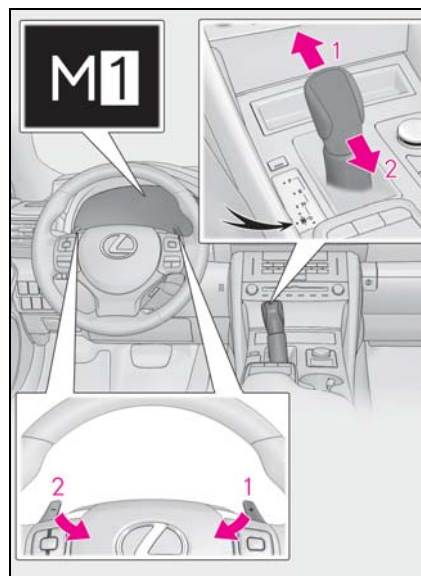

1 Upshifting**2** Downshifting

The gear changes once every time the shift lever or paddle shift switch is operated.

8-speed models: The selected gear, from M1 to M8, will be fixed and displayed on the meter.

6-speed models: The selected gear, from M1 to M6, will be fixed and displayed on the meter.

When in the M position, the gear will not change unless the shift lever or paddle shift switches are operated.

However, even when in the M position, the gears will be automatically changed in the following situation:

- When vehicle speed drops (downshift only).
- When a gear change is necessary to protect the engine or automatic transmission when the engine coolant temperature or automatic transmission fluid temperature is low, or other reasons.

In the following situations, the gear will not shift even if the shift lever or paddle shift switches are operated.

- "Slippery Road. Cannot Shift to Lower Gear." is displayed on the multi-information display.
- The vehicle speed is low (upshift only).

■ Downshifting restriction warning buzzer

To help ensure safety and driving performance, downshifting operation may sometimes be restricted. In some circumstances, downshifting may not be possible even when the shift lever or paddle shift switch is

operated. (A buzzer will sound twice.)

Turn signal lever

Operating instructions

The lever will return to its original position immediately after operation.

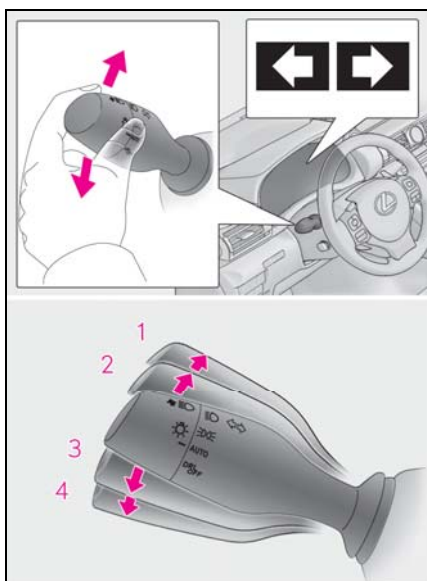

- 1** Right turn
- 2** Lane change to the right (move the lever partway and release it)
The right hand signals will flash 3 times.
- 3** Lane change to the left (move the lever partway and release it)
The left hand signals will flash 3 times.
- 4** Left turn

- **If the turn signals do not stop flashing after turning left or right, or if you want to stop them flashing**

Operate the lever in the opposite direction to either position **2** or **3**. If you move the lever to either position **1** or **4**, the selected turn signals will flash.

- **Turn signals can be operated when**

The engine switch is in IGNITION ON mode.

- **If the indicator flashes faster than usual**

Check that a light bulb in the front or rear turn signal lights has not burned out.

- **If the turn signals stop flashing before a lane change has been performed**

Operate the lever again.

- **Customization**

Some functions can be customized. (→P.351)

Parking brake

The parking brake can be set or released automatically or manually.

In automatic mode, the parking brake can be set or released automatically according to the shift lever operation. Also, even in automatic mode, the parking brake can be set or released manually.

Operating instructions

■ **Using the manual mode**

The parking brake can be set and released manually.

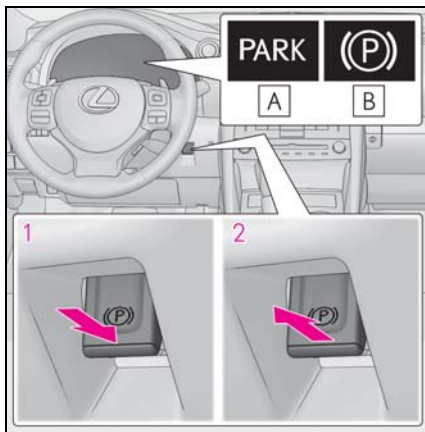

A U.S.A.

B Canada

- 1** Push the switch to set the parking brake

The parking brake indicator light will turn on.

Press and hold the parking brake switch if an emergency occurs and it is necessary to operate the parking brake while driving.

- 2** Pull the switch to release the parking brake

- Operate the parking brake switch while depressing the brake pedal.
- Using the parking brake automatic release function, the parking brake can be released by depressing the accelerator pedal. When using this function, slowly depress the accelerator pedal.

Make sure that the parking brake indicator light turn off.

■ **Turns automatic mode on**

While the vehicle is stopped, press and hold the parking brake switch until “EPB Shift Interlock Function Activated” will be displayed on the multi-information display.

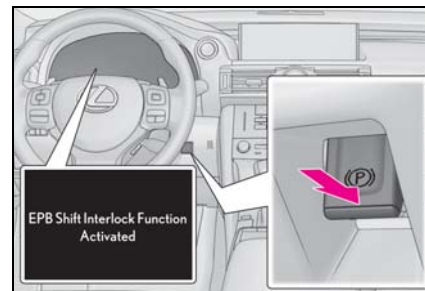

When the automatic mode is turned on, the parking brake operates as follows.

- When the shift lever is moved out of P, the parking brake will be released, and the parking brake indicator light will turn off.
- When the shift lever is moved into P, the parking brake will be set, and the parking brake indicator light will turn on.

Operate the shift lever with the vehicle stopped and the brake pedal depressed.

■ Turns automatic mode off

While the vehicle is stopped, pull and hold the parking brake switch until “EPB Shift Interlock Function Deactivated” will be displayed on the multi-information display.

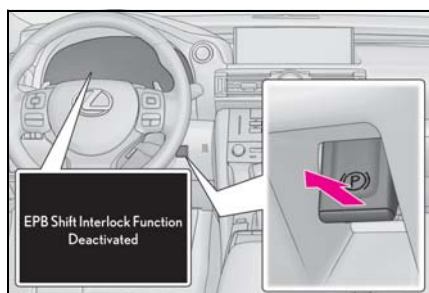

■ Parking brake operation

- When the engine switch is not in IGNITION ON mode, the parking brake cannot be released using the parking brake switch.
- When the engine switch is not in IGNITION ON mode, automatic mode (automatic brake setting and releasing) is not available.

■ Parking brake automatic release function

The parking brake is automatically released when slowly depress the accelerator pedal.

The parking brake will be released automatically under the following conditions:

- The driver's door is closed.
- The driver's seatbelt is fastened.
- Shift the shift lever is in a forward or reverse position.
- The malfunction indicator lamp or brake system warning light is not illuminated.

If the automatic release function does not operate, manually release the parking brake.

■ If “Parking Brake Temporarily Unavailable” is displayed on the multi-information display

If the parking brake is operated repeatedly

over a short period of time, the system may restrict operation to prevent overheating. If this happens, refrain from operating the parking brake. Normal operation will return after about 1 minute.

■ If “EPB Activation Stopped Incompletely” or “Parking Brake Unavailable” is displayed on the multi-information display

Operate the parking brake switch. If the message does not disappear after operating the switch several times, the system may be malfunctioning. Have the vehicle inspected by your Lexus dealer immediately.

■ Parking brake operation sound

When the parking brake operates, a motor sound (whirring sound) may be heard. This does not indicate a malfunction.

■ Parking brake operation

- Depending on the engine switch mode, the parking brake indicator light will turn on and stay on as described below:
IGNITION ON mode: Comes on until the parking brake is released.
Not in IGNITION ON mode: Stays on for approximately 15 seconds.
- When the engine switch is turned off with the parking brake set, the parking brake indicator light will stay on for about 15 seconds. This does not indicate a malfunction.

■ Parking the vehicle

→P.118

■ Parking brake engaged warning buzzer

A buzzer will sound if the vehicle is driven with the parking brake engaged. “Parking Brake ON” is displayed on the multi-information display.

■ Warning messages and buzzers

Warning messages and buzzers are used to indicate a system malfunction or to inform the driver of the need for caution. If a warning message is shown on the multi-information display, read the message and follow the instructions.

■ If the brake system warning light comes on

→P.295

■ Usage in winter time

→P.205

⚠ WARNING

■ When parking the vehicle

Do not leave a child in the vehicle alone. The parking brake may be released unintentionally and there is the danger of the vehicle moving that may lead to an accident resulting in death or serious injury.

⚠ NOTICE

■ When parking the vehicle

Before you leave the vehicle, shift the shift lever to P, set the parking brake and make sure that the vehicle does not move.

■ When the system malfunctions

Stop the vehicle in a safe place and check the warning messages.

■ When the parking brake cannot be released due to a malfunction

Driving the vehicle with the parking brake set will lead to brake components overheating, which may affect braking performance and increase brake wear. Have the vehicle inspected by your Lexus dealer immediately if this occurs.

Brake Hold

The brake hold system keeps the brake applied when the shift lever is in D, M or N with the system on and the brake pedal has been depressed to stop the vehicle. The system releases the brake when the accelerator pedal is depressed with the shift lever in D or M to allow smooth start off.

Enabling the system

Turns the brake hold system on

The brake hold standby indicator (green)

A comes on. While the system is holding the brake, the brake hold operated indicator (yellow) **B** comes on.

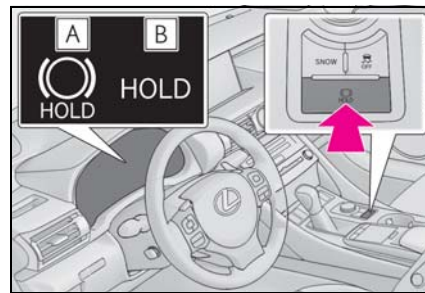

■ Brake hold system operating conditions

The brake hold system cannot be turned on in the following conditions:

- The driver's door is not closed.
- The driver is not wearing the seat belt.
- The parking brake is engaged.

If any of the conditions above are detected when the brake hold system is enabled, the system will turn off and the brake hold standby indicator light will go off. In addition, if any of the conditions are detected while the system is holding the brake, a

warning buzzer will sound and a message will be shown on the multi-information display. The parking brake will then be set automatically.

■ Brake hold function

- If the brake pedal is left released for a period of about 3 minutes after the system has started holding the brake, the parking brake will be set automatically. In this case, a warning buzzer sounds and a message is shown on the multi-information display.
- To turn the system off while the system is holding the brake, firmly depress the brake pedal and press the button again.
- The brake hold function may not hold the vehicle when the vehicle is on a steep incline. In this situation, it may be necessary for the driver to apply the brakes. A warning buzzer will sound and the multi-information display will inform the driver of this situation. If a warning message is shown on the multi-information display, read the message and follow the instructions.

■ When the parking brake is set automatically while the system is holding the brakes

Perform any of the following operations to release the parking brake.

- Depress the accelerator pedal. (The parking brake will not be released automatically if the seat belt is not fastened.)
- Operate the parking brake switch with the brake pedal depressed.

Make sure that the parking brake indicator light goes off. (→P.137)

■ When an inspection at your Lexus dealer is necessary

When the brake hold standby indicator (green) does not illuminate even when the brake hold switch is pressed with the brake hold system operating conditions met, the system may be malfunctioning. Have the vehicle inspected at your Lexus dealer.

■ If “Brake Hold Fault Depress Brake to Deactivate Visit Your Dealer”, “Brake Hold Malfunction Press Brake to Deactivate Visit Your Dealer” or “Brake Hold Malfunction Visit Your Dealer” is displayed on the multi-information display

The system may be malfunctioning. Have the vehicle inspected by your Lexus dealer.

■ Warning messages and buzzers

Warning messages and buzzers are used to indicate a system malfunction or to inform the driver of the need for caution. If a warning message is shown on the multi-information display, read the message and follow the instructions.

■ If the brake hold operated indicator flashes

→P.295

WARNING

■ When the vehicle is on a steep incline

When using the brake hold system on a steep incline, exercise caution. The brake hold function may not hold the vehicle in such a situation.

■ When stopped on a slippery road

The system cannot stop the vehicle when the gripping ability of the tires has been exceeded. Do not use the system when stopped on a slippery road.

NOTICE

■ When parking the vehicle

The brake hold system is not designed for use when parking the vehicle for a long period of time. Turning the engine switch off while the system is holding the brake may release the brake, which would cause the vehicle to move. When operating the engine switch, depress the brake pedal, shift the shift lever to P and set the parking brake.

ASC (Active Sound Control)*

*: If equipped

The ASC system is an electronic sound system that generates engine sound, conveying the kinetic situations of the vehicle's acceleration and deceleration to the driver through the speakers inside the instrument panel.

The vehicle's response to the driver's acceleration behavior and shift operations are also conveyed in sound.

When sport mode is selected, the sound conveyed to the driver will be louder.

■ The ASC system can be operated when

The driving mode select switch is in normal mode or sport mode. (→P.199)

■ Temporary cancelation of the ASC system functions

The ASC system may be temporarily canceled depending on the driving conditions, such as when the tires slip due to sudden acceleration.

Controlling volume

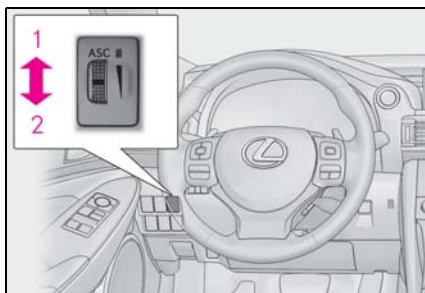

1 Louder

2 Lower

The indicator comes on when the ASC system is on.

When the dial is turned to the lowest volume, the ASC system will be turned off and the indicator will go off.

Headlight switch

The headlights can be operated manually or automatically.

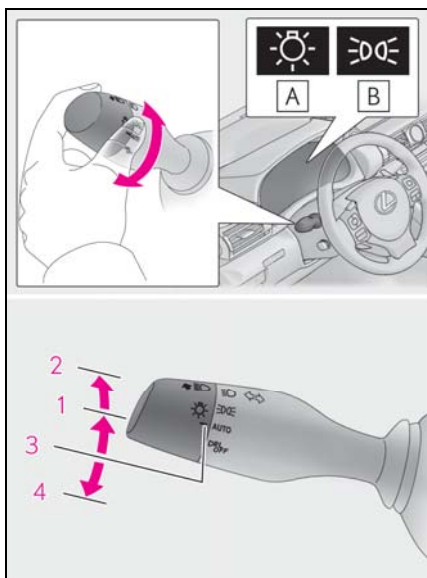

Operating instructions

Operating the  switch turns on the lights as follows:



A U.S.A.

B Canada



- 1**  The side marker, parking, tail, license plate, instrument panel lights, and daytime running lights (→P.142) turn on.
- 2**  The headlights and all lights listed above (except daytime running lights) turn on.
- 3** AUTO The headlights, daytime running lights (→P.142) and all the

lights listed above turn on and off automatically. (When the engine switch is in IGNITION ON mode.)

- 4**  (U.S.A.) Off /  (Canada)

The daytime running lights turn on. (→P.142)

Daytime running light system

- The daytime running lights illuminate using the same lights as the parking lights and illuminate brighter than the parking lights.
- To make your vehicle more visible to other drivers during daytime driving, the daytime running lights turn on automatically when all of the following conditions are met. (The daytime running lights are not designed for use at night.)
 - The engine is running
 - The parking brake is released
 - The headlight switch is in the  (Canada only),  or AUTO* position

*: When the surroundings are bright

The daytime running lights remain on after they illuminate, even if the parking brake is set again.

- For the U.S.A.: Daytime running lights can be turned off by operating the switch.
- Compared to turning on the headlights, the daytime running light system offers greater durability and consumes less electricity, so it can help improve fuel economy.

Headlight control sensor

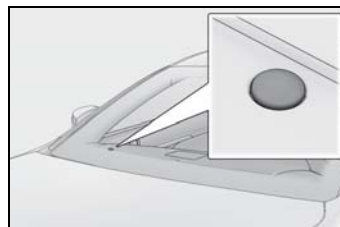





The sensor may not function properly if an object is placed on the sensor, or anything

that blocks the sensor is affixed to the windshield. Doing so interferes with the sensor detecting the level of ambient light and may cause the automatic headlight system to malfunction.

■ Automatic light off system

When the light switch is in AUTO,  or

: The headlights and tail lights turn off 30 seconds after the engine switch is turned to ACCESSORY mode or turned off and a door is opened and all of the doors and trunk are closed. (The lights turn off immediately if  on the key is pressed twice after both side doors are closed.)

To turn the lights on again, turn the engine switch to IGNITION ON mode, or turn the light switch off once and then back to  or .

If any of the doors or trunk lid is left open, the lights automatically turn off after 20 minutes.

■ Light reminder buzzer

A buzzer sounds when the engine switch is turned off or turned to ACCESSORY mode and the driver's door is opened while the lights are turned on.

■ Automatic headlight leveling system

The level of the headlights is automatically adjusted according to the number of passengers and the loading condition of the vehicle to ensure that the headlights do not interfere with other road users.

■ Customization

Some functions can be customized. (→P.351)



NOTICE

■ To prevent battery discharge

Do not leave the lights on longer than necessary when the engine is not running.

Turning on the high beam headlights

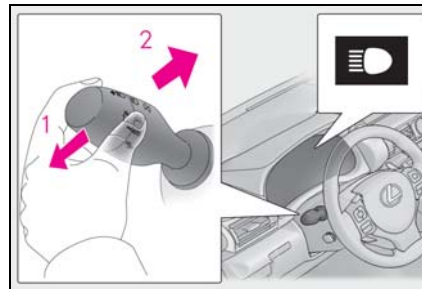

- 1 With the headlights on, push the lever away from you to turn on the high beams.

Pull the lever toward you to the center position to turn the high beams off.

- 2 Pull the lever toward you and release it to flash the high beams once.

You can flash the high beams with the headlights on or off.

Cornering lights

- When the steering wheel or turn signal lever is operated while the headlights are on (low beam) and the vehicle speed is 19 mph (30 km/h) or lower, a cornering light will turn on and light up the direction of movement of the vehicle. The cornering lights are designed to ensure excellent visibility when making a turn at an intersection.
- When the shift position is in R while the headlights are on (low beam), both cornering lights will turn on. This is designed to enhance visibility when parking.

■ Cornering lights

When the cornering lights are on for more than 30 minutes, they will turn off automatically.

AHB (Automatic High Beam)

The Automatic High Beam uses a camera sensor located behind the upper portion of the windshield to assess the brightness of the lights of vehicles ahead, streetlights, etc., and automatically turns the high beams on or off as necessary.

⚠ WARNING

■ Limitations of the Automatic High Beam

Do not overly rely on the Automatic High Beam. Always drive safely, taking care to observe your surroundings and turning the high beams on or off manually if necessary.

■ To prevent incorrect operation of the Automatic High Beam system

Do not overload the vehicle.

Activating the Automatic High Beam

- 1 Press the Automatic High Beam switch.

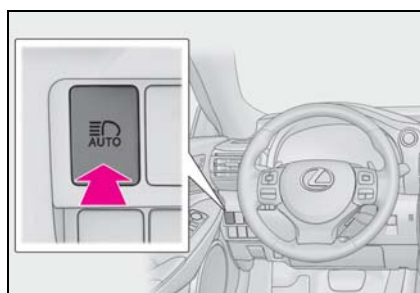

- 2 Turn the headlight switch to the AUTO or  position.

The Automatic High Beam indicator will

come on when the system is operating.

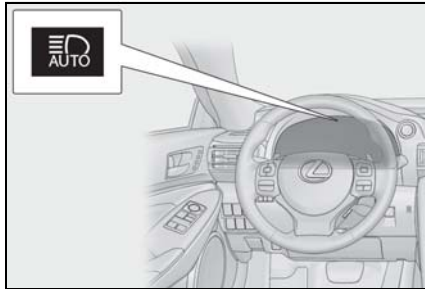

■ Conditions to turn the high beams on/off automatically

- When all of the following conditions are met, the high beams will be turned on automatically (after approximately 1 second):
 - The vehicle speed is approximately 21 mph (34 km/h) or more.
 - The area ahead of the vehicle is dark.
 - There are no vehicles ahead with headlights or tail lights turned on.
 - There are few streetlights on the road ahead.
- If any of the following conditions is met, the high beams will turn off automatically:
 - The vehicle speed is below approximately 17 mph (27 km/h).
 - The area ahead of the vehicle is not dark.
 - Vehicles ahead have their headlights or tail lights turned on.
 - There are many streetlights on the road ahead.

■ Camera sensor detection information

- The high beams may not be automatically turned off in the following situations:
 - When a vehicle suddenly appears from around a curve
 - When the vehicle is cut in front of by another vehicle
 - When vehicles ahead cannot be detected due to repeated curves, road dividers or roadside trees
 - When vehicles ahead appear in a far-away lane on a wide road
 - When the lights of vehicles ahead are not on
- The high beams may be turned off if a vehicle ahead that is using fog lights with-

out its headlights turned on is detected.

- House lights, street lights, traffic signals, and illuminated billboards or signs and other reflective objects may cause the high beams to change to the low beams, or the low beams to remain on.
- The following factors may affect the amount of time taken for the high beams to turn on or off:
 - The brightness of the headlights, fog lights, and tail lights of vehicles ahead
 - The movement and direction of vehicles ahead
 - When a vehicle ahead only has operational lights on one side
 - When a vehicle ahead is a two-wheeled vehicle
 - The condition of the road (gradient, curve, condition of the road surface, etc.)
 - The number of passengers and amount of luggage in the vehicle
- The high beams may turn on or off unexpectedly.
- Bicycles or similar vehicles may not be detected.
- In the following situations the system may not be able to correctly detect the surrounding brightness level. This may cause the low beams to remain on or the high beams to flash or dazzle pedestrians or vehicles ahead. In such a case, it is necessary to manually switch between the high and low beams.
 - When driving in inclement weather (heavy rain, snow, fog, sandstorms, etc.)
 - When the windshield is obscured by fog, mist, ice, dirt, etc.
 - When the windshield is cracked or damaged
 - When the camera sensor is deformed or dirty
 - When the temperature of the camera sensor is extremely high
 - When the surrounding brightness level is equal to that of headlights, tail lights or fog lights
 - When headlights or tail lights of vehicles ahead are turned off, dirty, changing color, or not aimed properly
 - When the vehicle is hit by water, snow, dust, etc. from a preceding vehicle
 - When driving through an area of inter-

mittently changing brightness and darkness

- When frequently and repeatedly driving ascending/descending roads, or roads with rough, bumpy or uneven surfaces (such as stone-paved roads, gravel roads, etc.)
- When frequently and repeatedly taking curves or driving on a winding road
- When there is a highly reflective object ahead of the vehicle, such as a sign or mirror
- When the back of a preceding vehicle is highly reflective, such as a container on a truck
- When the vehicle's headlights are damaged or dirty, or are not aimed properly
- When the vehicle is listing or titling due to a flat tire, a trailer being towed, etc.
- When the headlights are changed between the high beams and low beams repeatedly in an abnormal manner
- When the driver believes that the high beams may be flashing or dazzling pedestrians or other drivers

■ Temporarily lowering sensor sensitivity

The sensitivity of the sensor can be temporarily lowered.

- 1 Turn the engine switch off while the following conditions are met.
 - The headlight switch is in  or AUTO.
 - The headlight switch lever is in the original position.
 - Automatic High Beam switch is on.
- 2 Turn the engine switch to IGNITION ON mode.
- 3 Within 30 seconds after **2**, repeat pushing the headlight switch lever to the high beam position then pulling it to the original position quickly 10 times, then leave the lever in original position.
- 4 If the sensitivity is changed, the Automatic High Beam indicator is turn on and off 3 times.

Turning the high beams on/off manually

■ Switching to the high beams

Push the lever away from you.

The Automatic High Beam indicator will turn off and the high beam indicator will turn on.

Pull the lever to its original position to activate the Automatic High Beam system again.

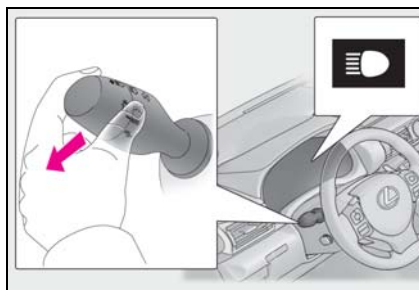

■ Switching to the low beams

Press the Automatic High Beam switch.

The Automatic High Beam indicator will turn off.

Press the switch to activate the Automatic High Beam system again.

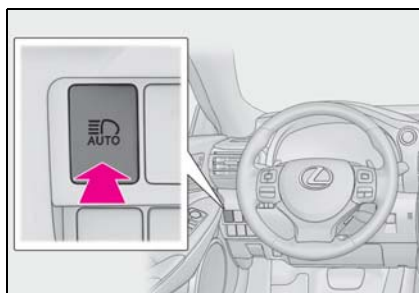

■ Temporarily switching to the low beams

Pull the lever toward you and then

return it to its original position.

The high beams are on while the lever is pulled toward you, however, after the lever is returned to its original position, the low beams remain on for a certain amount of time. Afterwards, the Automatic High Beam will be activated again.

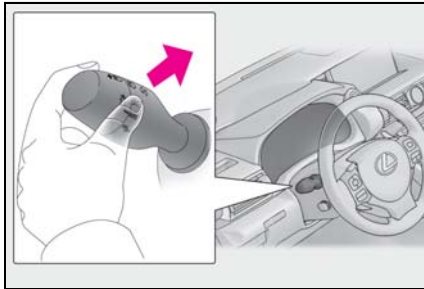

■ **Temporarily switching to the low beams**

It is recommended to switch to the low beams when the high beam may cause problems or distress to other drivers or pedestrians nearby.

Windshield wipers and washer

Operating the lever can use the windshield wipers or the washer.

 NOTICE

■ **When the windshield is dry**



Do not use the wipers, as they may damage the windshield.

Operating the wiper lever

Operating the  lever operates the wipers or washer as follows. The lever will return to its original position after operation.

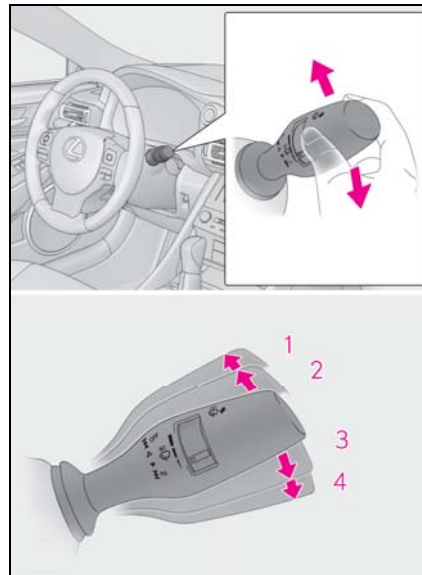
- ▶ Intermittent windshield wipers with interval adjuster



- 1  OFF (U.S.A.) or  (Canada)
Move the lever up by 2 levels

- 2 ▲ Move the lever up by 1 level
- 3 ▼ (U.S.A.) or ▽ (Canada)
Move the lever down by 1 level
- 4 ⚡ HI (U.S.A.) or ⚡ (Canada)
Move the lever down by 2 levels

Depending on the operating state of the wipers when the wiper lever is operated, the wipers will operate as follows.

- Current wiper operation: Off

Wiper lever operation	Wiper operation
⚡ OFF or ○	Temporary operation
▲	Temporary operation
▼ or ▽	Intermittent operation
⚡ HI or ⚡	High speed operation

- Current wiper operation: Intermittent operation

Wiper lever operation	Wiper operation
⚡ OFF or ○	Off
▲	Off
▼ or ▽	Low speed operation
⚡ HI or ⚡	High speed operation

- Current wiper operation: Low speed operation

Wiper lever operation	Wiper operation
⚡ OFF or ○	Off
▲	Intermittent operation
▼ or ▽	High speed operation
⚡ HI or ⚡	High speed operation

- Current wiper operation: High speed operation

Wiper lever operation	Wiper operation
⚡ OFF or ○	Off
▲	Low speed operation
▼ or ▽	No change
⚡ HI or ⚡	No change

Wiper intervals can be adjusted when intermittent operation is selected.

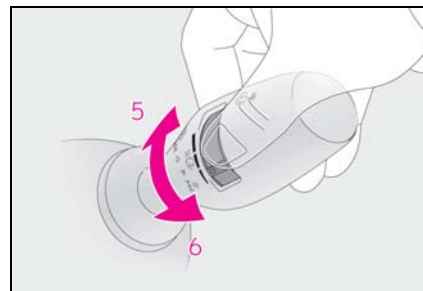

- 5 Increases the intermittent windshield wiper frequency
- 6 Decreases the intermittent windshield wiper frequency

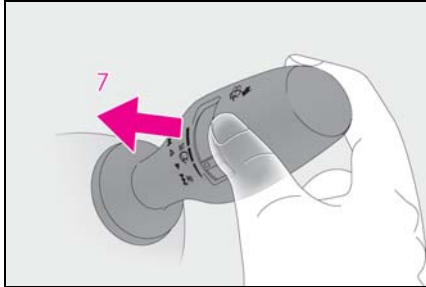

7  Washer/wiper dual operation



Pulling the lever operates the wipers and washer.

The wipers will automatically operate a couple of times after the washer squirts.

Vehicles with headlight cleaners: When the engine switch is in IGNITION ON mode and the headlights are on, if the lever is pulled, the headlight cleaners will operate once. After this, the headlight cleaners will operate every 5th time the lever is pulled.

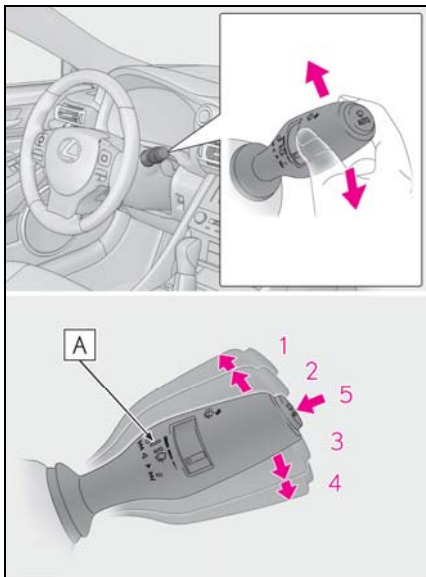

► Rain-sensing windshield wipers





1  OFF (U.S.A.) or  (Canada)

Move the lever up by 2 levels

2  Move the lever up by 1 level

3  (U.S.A.) or  (Canada)
Move the lever down by 1 level

4  HI (U.S.A.) or  (Canada)
Move the lever down by 2 levels







5  AUTO mode on/off switch

With AUTO mode selected, the wipers will operate automatically when the sensor detects falling rain. The system automatically adjusts wiper timing in accordance with rain volume and vehicle speed.



The AUTO mode indicator **A** will turn on when AUTO mode is selected.

Depending on the operating state of the wipers when the wiper lever is operated, the wipers will operate as follows.

- Current wiper operation: Off

Wiper lever operation	Wiper operation
 OFF or 	Temporary operation
	Temporary operation
 or 	Low speed operation
 HI or 	High speed operation

- Current wiper operation: Low speed operation

Wiper lever operation	Wiper operation
 OFF or 	Off
	Off

Wiper lever operation	Wiper operation
▼ or ▽	High speed operation
↕ HI or ↕	High speed operation

- Current wiper operation: High speed operation

Wiper lever operation	Wiper operation
⏏ OFF or ○	Off
△	Low speed operation
▼ or ▽	No change
↕ HI or ↕	No change

- Current wiper operation: AUTO mode (Intermittent operation)

Wiper lever operation	Wiper operation
⏏ OFF or ○	Off
△	Temporary operation ^{*1}
▼ or ▽	Low speed operation ^{*2}
↕ HI or ↕	High speed operation ^{*2}

- Current wiper operation: AUTO mode (Continuously)

Wiper lever operation	Wiper operation
⏏ OFF or ○	Off
△	No change

Wiper lever operation	Wiper operation
▼ or ▽	Low speed operation ^{*2}
↕ HI or ↕	High speed operation ^{*2}

^{*1}: After temporary operation, the mode will return to AUTO mode.

^{*2}: AUTO mode will be canceled.

When AUTO mode is selected, the sensor sensitivity can be adjusted by turning the switch ring.

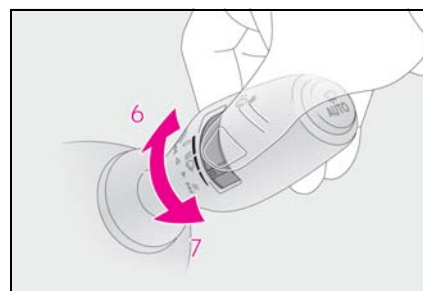

6 Increases the sensitivity

7 Decreases the sensitivity

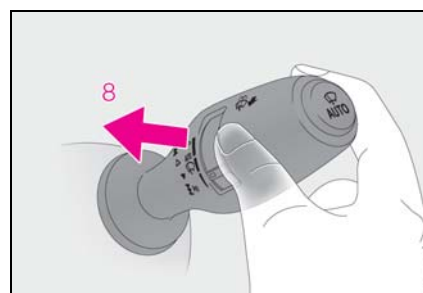

8  Washer/wiper dual operation

Pulling the lever operates the wipers and washer.

The wipers will automatically operate a couple of times after the washer squirts.

Vehicles with headlight cleaners: When the engine switch is in IGNITION ON mode and the headlights are on, if the lever is pulled, the headlight cleaners will operate once. After this, the headlight cleaners will operate every 5th time the lever is pulled.

Switching between the intermittent windshield wipers and rain-sensing windshield wipers (vehicles with rain-sensing windshield wipers)

The wipers can be used as intermittent windshield wipers, which operate regardless of vehicle speed or amount of raindrops. The intermittent windshield wiper operation can be switched when the vehicle is stopped and the wiper is off. The wiper operation cannot be switched during AUTO mode or while the intermittent windshield wipers are operating.

Press and hold  until the AUTO mode indicator stops flashing.

If  is pressed and held until the AUTO mode indicator stops flashing again, it will return to its previous state.

The wiper can be switched when the vehicle is stopped and the wipers are off.

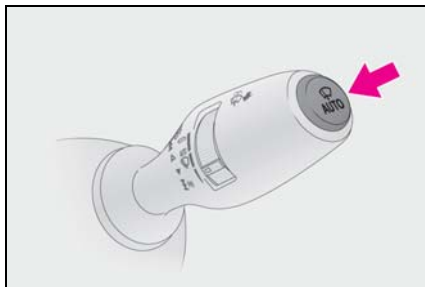

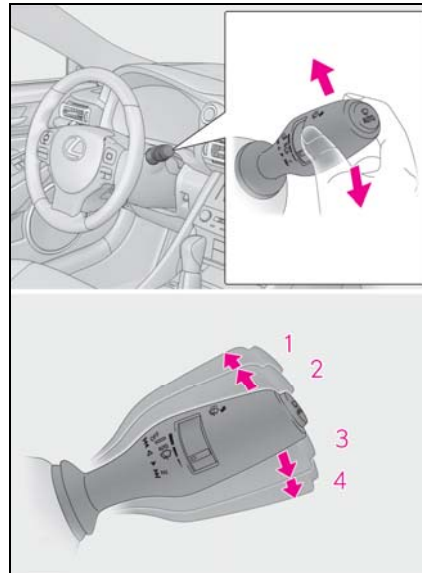

Operation of the intermittent windshield wipers with interval adjuster



- 1**  OFF (U.S.A.) or  (Canada)
Move the lever up by 2 levels
- 2**  Move the lever up by 1 level
- 3**  (U.S.A.) or  (Canada)
Move the lever down by 1 level
- 4**  HI (U.S.A.) or  (Canada)
Move the lever down by 2 levels

Depending on the operating state of the wipers when the wiper lever is operated, the wipers will operate as follows.

- Current wiper operation: Off

Wiper lever operation	Wiper operation
 OFF or 	Temporary operation
	Temporary operation

Wiper lever operation	Wiper operation
▼ or ▽	Intermittent operation
HI or HI	High speed operation

- Current wiper operation: Intermittent operation

Wiper lever operation	Wiper operation
OFF or ○	Off
△	Off
▼ or ▽	Low speed operation
HI or HI	High speed operation

- Current wiper operation: Low speed operation

Wiper lever operation	Wiper operation
OFF or ○	Off
△	Intermittent operation
▼ or ▽	High speed operation
HI or HI	High speed operation

- Current wiper operation: High speed operation

Wiper lever operation	Wiper operation
OFF or ○	Off
△	Low speed operation

Wiper lever operation	Wiper operation
▼ or ▽	No change
HI or HI	No change

Wiper intervals can be adjusted when intermittent operation is selected.

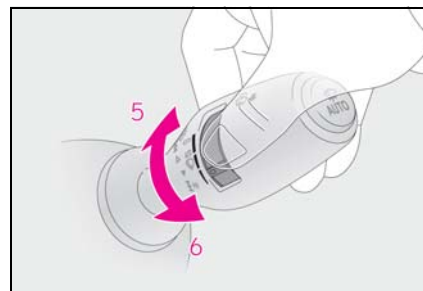

- 5 Increases the intermittent windshield wiper frequency
- 6 Decreases the intermittent windshield wiper frequency

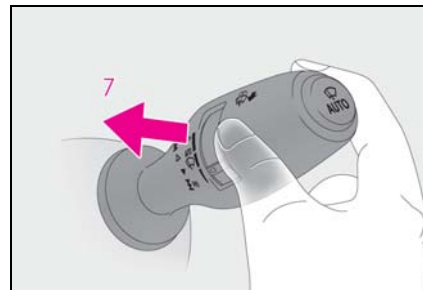

- 7 Washer/wiper dual operation

Pulling the lever operates the wipers and washer.

The wipers will automatically operate a couple of times after the washer squirts.

Vehicles with headlight cleaners: When the engine switch is in IGNITION ON mode and the headlights are on, if the lever is pulled, the headlight cleaners will operate

once. After this, the headlight cleaners will operate every 5th time the lever is pulled.

■ The windshield wiper and washer can be operated when

The engine switch is in IGNITION ON mode.

■ Dripping prevention wiper sweep

After performing a washing and wiping operation several times, the wipers operate one more time after a short delay to prevent dripping.

However, this final wiper operation will not be performed while driving.

■ Effects of vehicle speed on wiper operation (vehicles with rain-sensing windshield wipers)

Vehicle speed affects the following even when the wipers are not in AUTO mode.

- Intermittent wiper interval
- Wiper operation when the washer is being used (delay until drip prevention wiper sweep occurs)

With low speed windshield wiper operation selected, wiper operation will be switched from low speed to intermittent wiper operation only when the vehicle is stationary.

■ Raindrop sensor (vehicles with rain-sensing windshield wipers)

- The raindrop sensor judges the amount of raindrops.
An optical sensor is adopted. It may not operate properly when sunlight from the rising or setting of the sun intermittently strikes the windshield, or if bugs etc. are present on the windshield.

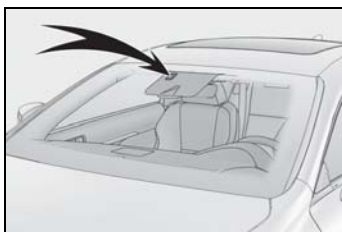

- If the wiper is turned to AUTO mode while the engine switch is in IGNITION

ON mode, the wipers will operate once to show that AUTO mode is activated.

- If the temperature of the raindrop sensor is 185°F (85°C) or higher, or -22°F (-30°C) or lower, automatic operation may not occur. In this case, operate the wipers in any mode other than AUTO mode.

■ When the windshield wipers are in temporary operation (vehicles with rain-sensing windshield wipers)

AUTO mode cannot be activated even if  is pressed.

■ If no windshield washer fluid sprays

Check that the washer nozzles are not blocked if there is washer fluid in the windshield washer fluid reservoir.

WARNING

■ Caution regarding the use of windshield wipers in AUTO mode

The windshield wipers may operate unexpectedly if the sensor is touched or the windshield is subject to vibration in AUTO mode. Take care that your fingers or anything else do not become caught in the windshield wipers.

■ Caution regarding the use of washer fluid

When it is cold, do not use the washer fluid until the windshield becomes warm. The fluid may freeze on the windshield and cause low visibility. This may lead to an accident, resulting in death or serious injury.

NOTICE

■ When there is no washer fluid spray from the nozzle

Damage to the washer fluid pump may be caused if the lever is pulled toward you and held continually.



NOTICE

■ When a nozzle becomes blocked

In this case, contact your Lexus dealer.
Do not try to clear it with a pin or other
object. The nozzle will be damaged.

Opening the fuel tank cap

Perform the following steps to open the fuel tank cap:

Before refueling the vehicle

- Close both side doors and windows, and turn the engine switch off.
- Confirm the type of fuel.

■ **Fuel types**

→P.339

■ **Fuel tank opening for unleaded gasoline**

To help prevent incorrect fueling, your vehicle has a fuel tank opening that only accommodates the special nozzle on unleaded fuel pumps.

■ **If the malfunction indicator lamp illuminates**

The malfunction indicator lamp may illuminate erroneously if refueling is performed repeatedly when the fuel tank is nearly full.

 **WARNING**

■ **When refueling the vehicle**

Observe the following precautions while refueling the vehicle. Failure to do so may result in death or serious injury.

- After exiting the vehicle and before opening the fuel door, touch an unpainted metal surface to discharge any static electricity. It is important to discharge static electricity before refueling because sparks resulting from static electricity can cause fuel vapors to ignite while refueling.

- Always hold the grips on the fuel tank cap and turn it slowly to remove it. A whooshing sound may be heard when the fuel tank cap is loosened. Wait until the sound cannot be heard before fully removing the cap. In hot weather, pressurized fuel may spray out the filler neck and cause injury.

- Do not allow anyone that has not discharged static electricity from their body to come close to an open fuel tank.

- Do not inhale vaporized fuel. Fuel contains substances that are harmful if inhaled.

- Do not smoke while refueling the vehicle. Doing so may cause the fuel to ignite and cause a fire.

- Do not return to the vehicle or touch any person or object that is statically charged. This may cause static electricity to build up, resulting in a possible ignition hazard.

■ **When refueling**

Observe the following precautions to prevent fuel overflowing from the fuel tank:

- Securely insert the fuel nozzle into the fuel filler neck.
- Stop filling the tank after the fuel nozzle automatically clicks off.
- Do not top off the fuel tank.

 **NOTICE**

■ **Refueling**

Do not spill fuel during refueling. Doing so may damage the vehicle, such as causing the emission control system to operate abnormally or damaging fuel system components or the vehicle's painted surface.

Opening the fuel tank cap

- 1 With the doors unlocked, press the center of the rear edge of the fuel filler door.

Push until you hear a click and take your hand away to slightly open the fuel filler door. Then open the door fully by hand.

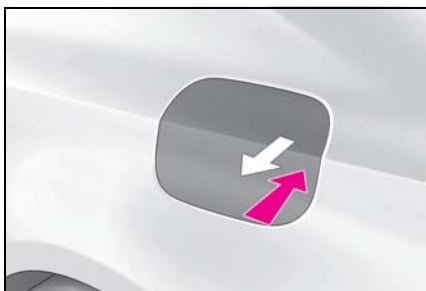

- 2 Turn the fuel tank cap slowly and remove it, then put it into the holder on the fuel filler door.

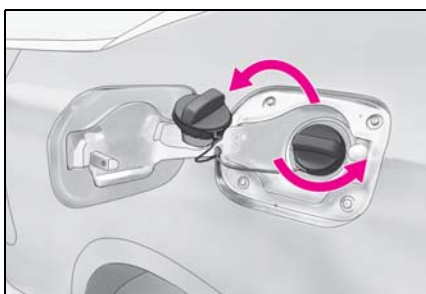

■ If the fuel filler door cannot be opened
→P.316

Closing the fuel tank cap

- 1 After refueling, turn the fuel tank cap until you hear a click. Once the

cap is released, it will turn slightly in the opposite direction.

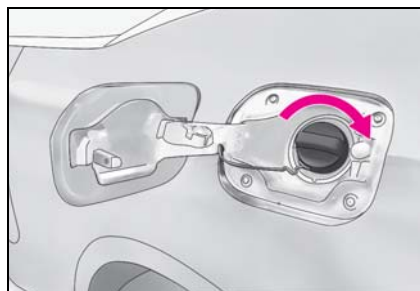

- 2 Close the fuel filler door, and press the center of the rear edge of the fuel filler door until you hear a click.

When you lock the doors, the fuel filler door will also lock.

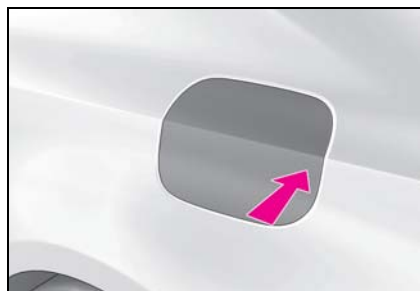

■ When closing the fuel filler door

Do not lock the doors before closing the fuel filler door, as the fuel filler door cannot be closed if the doors are locked. If the doors are locked and the fuel filler door cannot be closed, unlock the doors and then close the fuel filler door.

■ Fuel filler door lock condition

The fuel filler door may not be locked even when the vehicle's doors are locked in the following situations:

- When operating the door lock button inside the vehicle
- When the automatic door locking system is operated (→P.90)

**WARNING****■ When replacing the fuel tank cap**

Do not use anything but a genuine Lexus fuel tank cap designed for your vehicle. Doing so may cause a fire or other incident which may result in death or serious injury.

Lexus Safety System +

The Lexus Safety System + consists of the following drive assist systems and contributes to a safe and comfortable driving experience:

Driving assist system

■ PCS (Pre-Collision System)

→P.162

■ LDA (Lane Departure Alert with steering control)

→P.169

■ AHB (Automatic High Beam)

→P.144

■ Dynamic radar cruise control with full-speed range

→P.176

⚠ WARNING

■ Lexus Safety System +

The Lexus Safety System + is designed to operate under the assumption that the driver will drive safely, and is designed to help reduce the impact to the occupants and the vehicle in the case of a collision or assist the driver in normal driving conditions.

As there is a limit to the degree of recognition accuracy and control performance that this system can provide, do not overly rely on this system. The driver is always responsible for paying attention to the vehicle's surroundings and driving safely.

Sensors

Two types of sensors, located behind the front grille and windshield, detect

information necessary to operate the drive assist systems.

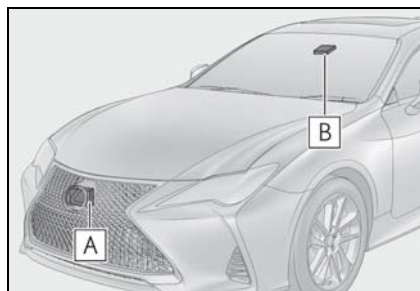

A Radar sensor

B Front camera

⚠ WARNING

■ To avoid malfunction of the radar sensor

Observe the following precautions.

Otherwise, the radar sensor may not operate properly, possibly leading to an accident resulting in death or serious injury.

- Keep the radar sensor and the radar sensor cover clean at all times.

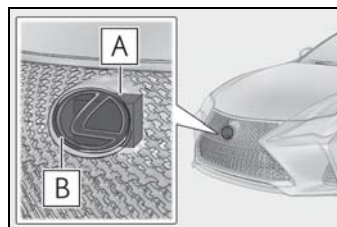

A Radar sensor

B Radar sensor cover

If the front of the radar sensor or the front or back of the radar sensor cover is dirty or covered with water droplets, snow, etc., clean it.

Clean the radar sensor and radar sensor cover with a soft cloth to avoid damaging them.

⚠ WARNING

- Do not attach accessories, stickers (including transparent stickers) or other items to the radar sensor, radar sensor cover or surrounding area.
- Do not subject the radar sensor or its surrounding area to a strong impact. If the radar sensor, front grille, or front bumper has been subjected to a strong impact, have the vehicle inspected by your Lexus dealer.
- Do not disassemble the radar sensor.
- Do not modify or paint the radar sensor or radar sensor cover.
- In the following cases, the radar sensor must be recalibrated. Contact your Lexus dealer for details.
 - When the radar sensor or front grille are removed and installed, or replaced
 - When the front bumper is replaced

■ To avoid malfunction of the front camera

Observe the following precautions.

Otherwise, the front camera may not operate properly, possibly leading to an accident resulting in death or serious injury.

- Keep the windshield clean at all times.
 - If the windshield is dirty or covered with an oily film, water droplets, snow, etc., clean the windshield.
 - If a glass coating agent is applied to the windshield, it will still be necessary to use the windshield wipers to remove water droplets, etc. from the area of the windshield in front of the front camera.
 - If the inner side of the windshield where the front camera is installed is dirty, contact your Lexus dealer.

- Do not attach objects, such as stickers, transparent stickers, etc., to the outer side of the windshield in front of the front camera (shaded area in the illustration).

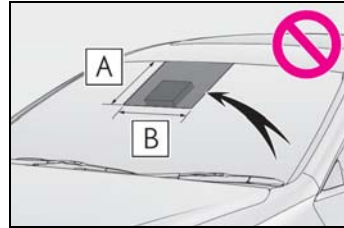

- A** From the top of the windshield to approximately 0.4 in. (1 cm) below the bottom of the front camera
- B** Approximately 7.9 in. (20 cm) (Approximately 4.0 in. [10 cm] to the right and left from the center of the front camera)

- If the part of the windshield in front of the front camera is fogged up or covered with condensation, or ice, use the windshield defogger to remove the fog, condensation, or ice. (→P.219)
- If water droplets cannot be properly removed from the area of the windshield in front of the front camera by the windshield wipers, replace the wiper insert or wiper blade.
- Do not attach window tint to the windshield.
- Replace the windshield if it is damaged or cracked. After replacing the windshield, the front camera must be recalibrated. Contact your Lexus dealer for details.
- Do not allow liquids to contact the front camera.
- Do not allow bright lights to shine into the front camera.

**WARNING**

- Do not dirty or damage the front camera.
When cleaning the inside of the windshield, do not allow glass cleaner to contact the lens of the front camera. Also, do not touch the lens. If the lens is dirty or damaged, contact your Lexus dealer.
- Do not subject the front camera to a strong impact.
- Do not change the installation position or direction of the front camera or remove it.
- Do not disassemble the front camera.
- Do not modify any components of the vehicle around the front camera (inside rear view mirror, etc.) or ceiling.
- Do not attach any accessories to the hood, front grille or front bumper that may obstruct the front camera. Contact your Lexus dealer for details.
- If a surfboard or other long object is to be mounted on the roof, make sure that it will not obstruct the front camera.
- Do not modify the headlights or other lights.

■ If a warning message is displayed on the multi-information display

A system may be temporarily unavailable or there may be a malfunction in the system.

- In the following situations, perform the actions specified in the table. When the normal operating conditions are detected, the message will disappear and the system will become operational.

If the message does not disappear, contact your Lexus dealer.

Situation	Actions
When the area around a sensor is covered with dirt, moisture (fogged up, covered with condensation, ice, etc.), or other foreign matter	To clean the part of the windshield in front of the front camera, use the windshield wipers or the windshield defogger of the air conditioning system (→P.219).
When the temperature around the front camera is outside of the operational range, such as when the vehicle is in the sun or in an extremely cold environment	If the front camera is hot, such as after the vehicle had been parked in the sun, use the air conditioning system to decrease the temperature around the front camera. If a sunshade was used when the vehicle was parked, depending on its type, the sunlight reflected from the surface of the sunshade may cause the temperature of the front camera to become excessively high.
	If the front camera is cold, such after the vehicle is parked in an extremely cold environment, use the air conditioning system to increase the temperature around the front camera.
The area in front of the front camera is obstructed, such as when the hood is open or a sticker is attached to the part of the windshield in front of the front camera.	Close the hood, remove the sticker, etc. to clear the obstruction.

- In the following situations, if the situation has changed (or the vehicle has been driven for some time) and the normal operating conditions are detected, the message will disappear and the system will become operational.
If the message does not disappear, contact your Lexus dealer.
- When the temperature around the radar sensor is outside of the operational range, such as when the vehicle is in the sun or in an extremely cold environment
- When the front camera cannot detect objects in front of the vehicle, such as when driving in the dark, snow, or fog, or when bright lights are shining into the front camera

PCS (Pre-Collision System)

The pre-collision system uses a radar sensor and front camera to detect vehicles and pedestrians in front of your vehicle. When the system determines that the possibility of a frontal collision with a vehicle or pedestrian is high, a warning operates to urge the driver to take evasive action and the potential brake pressure is increased to help the driver avoid the collision. If the system determines that the possibility of a frontal collision with a vehicle or pedestrian is extremely high, the brakes are automatically applied to help avoid the collision or help reduce the impact of the collision.

The pre-collision system can be disabled/enabled and the warning timing can be changed. (→P.164)

System functions

■ Pre-collision warning

When the system determines that the possibility of a frontal collision is high, a buzzer will sound and a warning message will be displayed on the multi-information display to urge the driver to take evasive action.

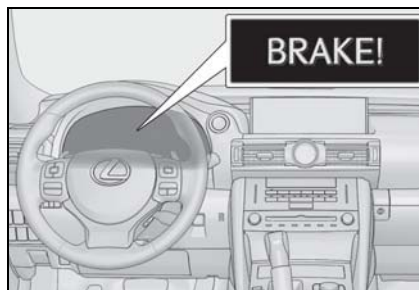

■ Pre-collision brake assist

When the system determines that the possibility of a frontal collision is high, the system applies greater braking force in relation to how strongly the brake pedal is depressed.

■ Pre-collision braking

When the system determines that the possibility of a frontal collision is high, the system warns the driver. If the system determines that the possibility of a frontal collision is extremely high, the brakes are automatically applied to help avoid the collision or reduce the collision speed.

■ Suspension control (if equipped)

When the system determines that the possibility of a frontal collision is high, the Adaptive Variable Suspension System (→P.201) will control the damping force of the shock absorbers to help maintain an appropriate vehicle posture.

■ Steering control (if equipped)

When the system determines that the possibility of a frontal collision is high and the driver is operating the steering wheel, the LDH system (→P.202) will control the turning angle of the front

and rear wheels and effort necessary to turn the steering wheel to help enhance steering responsiveness.

WARNING

■ Limitations of the pre-collision system

- The driver is solely responsible for safe driving. Always drive safely, taking care to observe your surroundings. Do not use the pre-collision system instead of normal braking operations under any circumstances. This system will not prevent collisions or lessen collision damage or injury in every situation. Do not overly rely on this system. Failure to do so may lead to an accident, resulting in death or serious injury.
- Although this system is designed to help avoid a collision or help reduce the impact of the collision, its effectiveness may change according to various conditions, therefore the system may not always be able to achieve the same level of performance. Read the following conditions carefully. Do not overly rely on this system and always drive carefully.
 - Conditions under which the system may operate even if there is no possibility of a collision: →P.165
 - Conditions under which the system may not operate properly: →P.167
- Do not attempt to test the operation of the pre-collision system yourself. Depending on the objects used for testing (dummies, cardboard objects imitating detectable objects, etc.), the system may not operate properly, possibly leading to an accident.

■ Pre-collision braking

- When the pre-collision braking function is operating, a large amount of braking force will be applied.

- If the vehicle is stopped by the operation of the pre-collision braking function, the pre-collision braking function operation will be canceled after approximately 2 seconds. Depress the brake pedal as necessary.

- The pre-collision braking function may not operate if certain operations are performed by the driver. If the accelerator pedal is being depressed strongly or the steering wheel is being turned, the system may determine that the driver is taking evasive action and possibly prevent the pre-collision braking function from operating.

- In some situations, while the pre-collision braking function is operating, operation of the function may be canceled if the accelerator pedal is depressed strongly or the steering wheel is turned and the system determines that the driver is taking evasive action.

- If the brake pedal is being depressed, the system may determine that the driver is taking evasive action and possibly delay the operation timing of the pre-collision braking function.

■ When to disable the pre-collision system

In the following situations, disable the system, as it may not operate properly, possibly leading to an accident resulting in death or serious injury:

- When the vehicle is being towed
- When your vehicle is towing another vehicle
- When transporting the vehicle via truck, boat, train or similar means of transportation
- When the vehicle is raised on a lift with the engine running and the tires are allowed to rotate freely

⚠ WARNING

- When inspecting the vehicle using a drum tester such as a chassis dynamometer or speedometer tester, or when using an on vehicle wheel balancer
- When a strong impact is applied to the front bumper or front grille, due to an accident or other reasons
- If the vehicle cannot be driven in a stable manner, such as when the vehicle has been in an accident or is malfunctioning
- When the vehicle is driven in a sporty manner or off-road
- When the tires are not properly inflated
- When the tires are very worn
- When tires of a size other than specified are installed
- When tire chains are installed
- When a compact spare tire or an emergency tire puncture repair kit is used
- If equipment (snow plow, etc.) that may obstruct the radar sensor or front camera is temporarily installed to the vehicle

Changing settings of the pre-collision system**■ Enabling/disabling the pre-collision system**

The pre-collision system can be enabled/disabled on  (→P.71) of the multi-information display.

The system is automatically enabled each time the engine switch is turned to IGNITION ON mode.

If the system is disabled, the PCS warning light will turn on and a message will be displayed on the multi-information display.

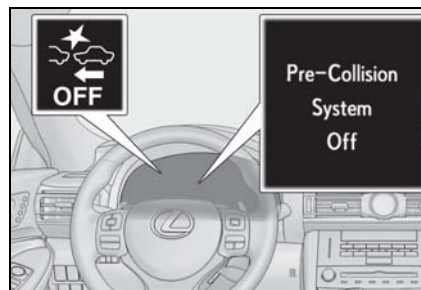
**■ Changing the pre-collision warning timing**

The pre-collision warning timing can be changed on  (→P.71) of the multi-information display.

The operation timing setting is retained when the engine switch is turned off.

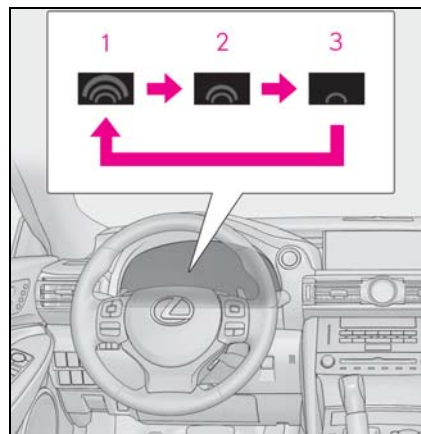
**1 Far**

The warning will begin to operate earlier than with the default timing.

2 Middle

This is the default setting.

3 Near

The warning will begin to operate later than with the default timing.

■ Operational conditions

The pre-collision system is enabled and the system determines that the possibility of a frontal collision with a vehicle or pedestrian is high.

Each function is operational at the following speeds:

- Pre-collision warning:
 - Vehicle speed is between approximately 7 and 110 mph (10 and 180 km/h). (For detecting a pedestrian, vehicle speed is between approximately 7 and 50 mph [10 and 80 km/h].)
 - The relative speed between your vehicle and the vehicle or pedestrian ahead is approximately 7 mph (10 km/h) or more.
- Pre-collision brake assist:
 - Vehicle speed is between approximately 20 and 110 mph (30 and 180 km/h). (For detecting a pedestrian, vehicle speed is between approximately 20 and 50 mph [30 and 80 km/h].)
 - The relative speed between your vehicle and the vehicle or pedestrian ahead is approximately 20 mph (30 km/h) or more.
- Pre-collision braking:
 - Vehicle speed is between approximately 7 and 110 mph (10 and 180 km/h). (For detecting a pedestrian, vehicle speed is between approximately 7 and 50 mph [10 and 80 km/h].)
 - The relative speed between your vehicle and the vehicle or pedestrian ahead is approximately 7 mph (10 km/h) or more.

The system may not operate in the following situations:

- If a battery terminal has been disconnected and reconnected and then the vehicle has not been driven for a certain amount of time
- If the shift lever is in R
- If VSC is disabled (only the pre-collision warning function will be operational)

■ Pedestrian detection function

The pre-collision system detects pedestri-

ans based on the size, profile, and motion of a detected object. However, a pedestrian may not be detected depending on the surrounding brightness and the motion, posture, and angle of the detected object, preventing the system from operating properly. (→P.167)

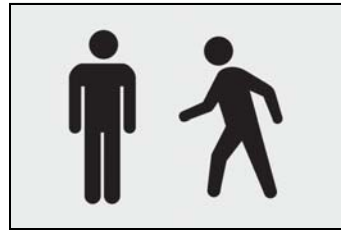

■ Cancellation of the pre-collision braking

If either of the following occur while the pre-collision braking function is operating, it will be canceled:

- The accelerator pedal is depressed strongly.
- The steering wheel is turned sharply or abruptly.

■ Conditions under which the system may operate even if there is no possibility of a collision

- In some situations such as the following, the system may determine that there is a possibility of a frontal collision and operate.
 - When passing a vehicle or pedestrian
 - When changing lanes while overtaking a preceding vehicle
 - When overtaking a preceding vehicle that is changing lanes
 - When overtaking a preceding vehicle that is making a left/right turn

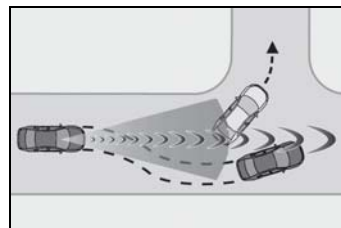

- When passing a vehicle in an oncoming lane that is stopped to make a right/left turn

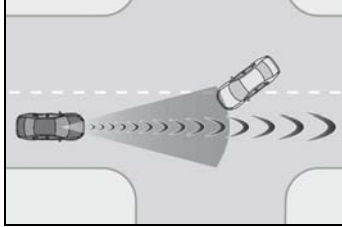

- When driving on a road where relative location to vehicle ahead in an adjacent lane may change, such as on a winding road

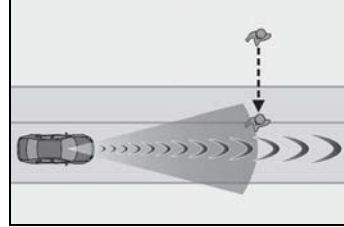

- When passing through a place with a low structure above the road (low ceiling, traffic sign, etc.)

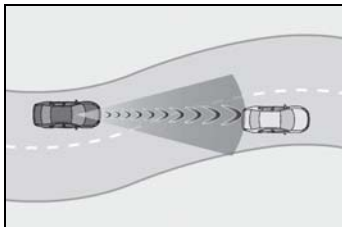

- When rapidly closing on a vehicle ahead
- If the front of the vehicle is raised or lowered, such as when the road surface is uneven or undulating
- When approaching objects on the roadside, such as guardrails, utility poles, trees, or walls
- When there is a vehicle, pedestrian, or object by the roadside at the entrance of a curve

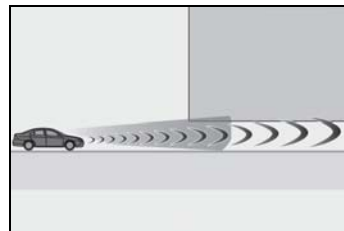

- When passing under an object (billboard, etc.) at the top of an uphill road

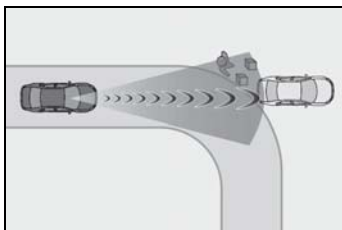

- When driving on a narrow path surrounded by a structure, such as in a tunnel or on an iron bridge
- When there is a metal object (manhole cover, steel plate, etc.), steps, or a protrusion on the road surface or roadside
- When a crossing pedestrian approaches very close to the vehicle

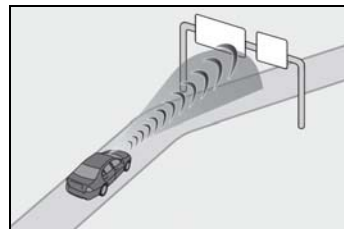

- When rapidly closing on an electric toll gate barrier, parking area barrier, or other barrier that opens and closes
- When using an automatic car wash
- When driving through or under objects that may contact the vehicle, such as thick grass, tree branches, or a banner

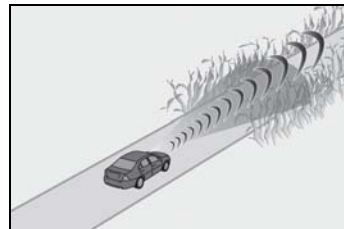

- When the vehicle is hit by water, snow, dust, etc. from a vehicle ahead
- When driving through steam or smoke
- When there are patterns or paint on the

- road or a wall that may be mistaken for a vehicle or pedestrian
- When driving near an object that reflects radio waves, such as a large truck or guardrail
- When driving near a TV tower, broadcasting station, electric power plant, or other location where strong radio waves or electrical noise may be present

■ Situations in which the system may not operate properly

- In some situations such as the following, a vehicle may not be detected by the radar sensor and front camera, preventing the system from operating properly:
 - If an oncoming vehicle is approaching your vehicle
 - If a vehicle ahead is a motorcycle or bicycle
 - When approaching the side or front of a vehicle
 - If a preceding vehicle has a small rear end, such as an unloaded truck
 - If a preceding vehicle has a low rear end, such as a low bed trailer

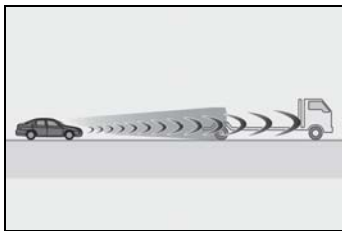

- If a vehicle ahead is carrying a load which protrudes past its rear bumper
- If a vehicle ahead has extremely high ground clearance

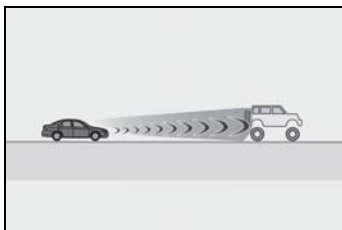

- If a vehicle ahead is irregularly shaped, such as a tractor or side car
- If the sun or other light is shining directly on a vehicle ahead
- If a vehicle cuts in front of your vehicle or

- emerges from beside a vehicle
- If a vehicle ahead makes an abrupt maneuver (such as sudden swerving, acceleration or deceleration)
- When suddenly cutting behind a preceding vehicle
- When a vehicle ahead is not directly in front of your vehicle

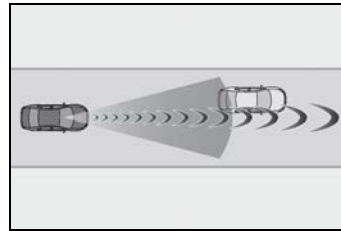

- When driving in inclement weather such as heavy rain, fog, snow or a sandstorm
- When the vehicle is hit by water, snow, dust, etc. from a vehicle ahead
- When driving through steam or smoke
- When driving in a place where the surrounding brightness changes suddenly, such as at the entrance or exit of a tunnel
- When a very bright light, such as the sun or the headlights of oncoming traffic, shines directly into the front camera
- When the surrounding area is dim, such as at dawn or dusk, or while at night or in a tunnel
- After the engine has started the vehicle has not been driven for a certain amount of time
- While making a left/right turn and for a few seconds after making a left/right turn
- While driving on a curve and for a few seconds after driving on a curve
- If your vehicle is skidding
- If the front of the vehicle is raised or lowered

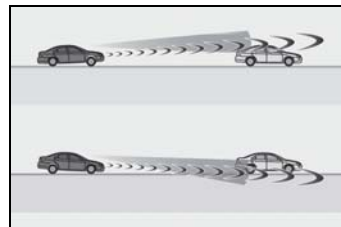

- If the wheels are misaligned
- If a wiper blade is blocking the front camera

- The vehicle is wobbling.
 - The vehicle is being driven at extremely high speeds.
 - When driving on a hill
 - If the radar sensor or front camera is misaligned
 - In some situations such as the following, sufficient braking force may not be obtained, preventing the system from performing properly:
 - If the braking functions cannot operate to their full extent, such as when the brake parts are extremely cold, extremely hot, or wet
 - If the vehicle is not properly maintained (brakes or tires are excessively worn, improper tire inflation pressure, etc.)
 - When the vehicle is being driven on a gravel road or other slippery surface
 - Some pedestrians such as the following may not be detected by the radar sensor and front camera, preventing the system from operating properly:
 - Pedestrians shorter than approximately 3.2 ft. (1 m) or taller than approximately 6.5 ft. (2 m)
 - Pedestrians wearing oversized clothing (a rain coat, long skirt, etc.), making their silhouette obscure
 - Pedestrians who are carrying large baggage, holding an umbrella, etc., hiding part of their body
 - Pedestrians who are bending forward or squatting
 - Pedestrians who are pushing a stroller, wheelchair, bicycle or other vehicle
 - Groups of pedestrians which are close together
 - Pedestrians who are wearing white and look extremely bright
 - Pedestrians in the dark, such as at night or while in a tunnel
 - Pedestrians whose clothing appears to be nearly the same color or brightness as their surroundings
 - Pedestrians near walls, fences, guardrails, or large objects
 - Pedestrians who are on a metal object (manhole cover, steel plate, etc.) on the road
 - Pedestrians who are walking fast
 - Pedestrians who are changing speed abruptly
 - Pedestrians running out from behind a vehicle or a large object
 - Pedestrians who are extremely close to the side of the vehicle (outside rear view mirror, etc.)
- **If VSC is disabled**
- If VSC is disabled (→P.201), the pre-collision brake assist and pre-collision braking functions are also disabled.
 - The PCS warning light will turn on and “VSC Turned Off Pre-Collision Brake System Unavailable” will be displayed on the multi-information display.

LDA (Lane Departure Alert with steering control)

When driving on highways and freeways with white (yellow) lines, this function alerts the driver when the vehicle might depart from its lane and provides assistance by operating the steering wheel to keep the vehicle in its lane.

The LDA system recognizes visible white (yellow) lines with the camera sensor on the upper portion of the front windshield.

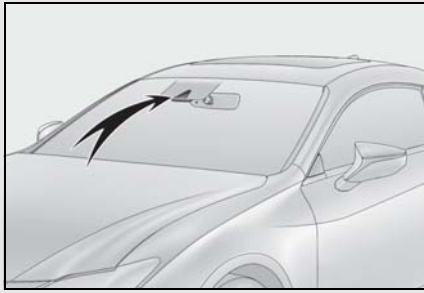

Functions included in LDA system

■ Lane departure alert function

When the system determines that the vehicle might depart from its lane, a warning is displayed on the multi-information display, and either the warning buzzer sounds or the steering wheel vibrates to alert the driver.

When the warning buzzer sounds or the steering wheel vibrates, check the surrounding road situation and carefully operate the steering wheel to move the vehicle back to the center of the lane.

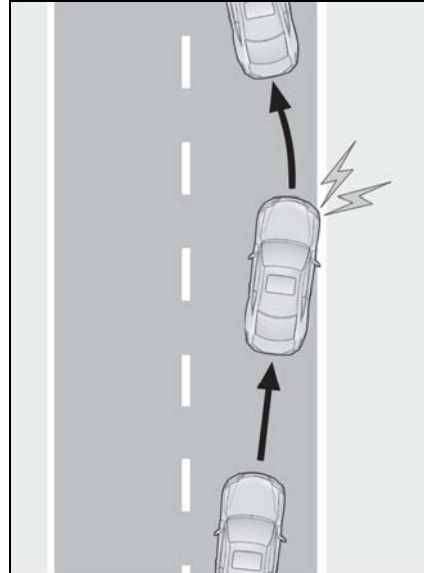

■ Steering control function

When the system determines that the vehicle might depart from its lane, the system provides assistance as necessary by operating the steering wheel in small amounts for a short period of time to keep the vehicle in its lane.

If the system detects that the steering wheel has not been operated for a fixed amount of time or the steering wheel is not being firmly gripped, a warning is displayed on the multi-information display and the function is temporarily canceled.

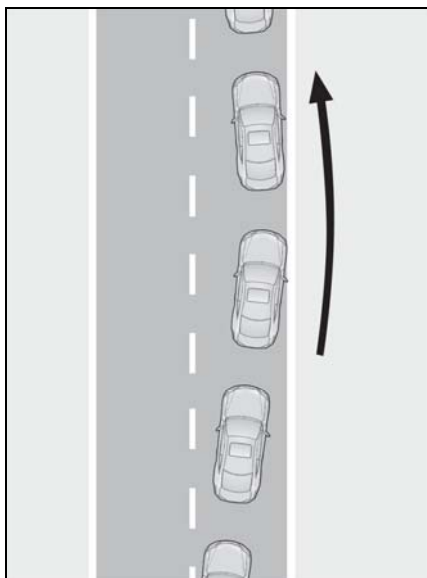

■ Vehicle sway warning function

When the vehicle is swaying or appears as if it may depart from its lane multiple times, the warning buzzer sounds and a message is displayed on the multi-information display to alert the driver.

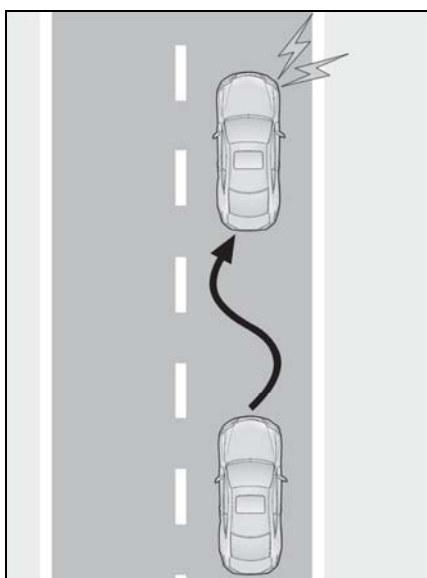

⚠ WARNING

■ Before using LDA system

Do not rely solely upon the LDA system. The LDA system does not automatically drive the vehicle or reduce the amount of attention that must be paid to the area in front of the vehicle. The driver must always assume full responsibility for driving safely by paying careful attention to the surrounding conditions and operating the steering wheel to correct the path of the vehicle. Also, the driver must take adequate breaks when fatigued, such as from driving for a long period of time.

Failure to perform appropriate driving operations and pay careful attention may lead to an accident, resulting in death or serious injury.

■ To avoid operating LDA system by mistake

When not using the LDA system, use the LDA switch to turn the system off.

■ Situations unsuitable for LDA system

Do not use the LDA system in the following situations.

The system may not operate properly and lead to an accident, resulting in death or serious injury.

- A spare tire, tire chains, etc. are equipped.
- When the tires have been excessively worn, or when the tire inflation pressure is low.
- Tires which differ by structure, manufacturer, brand or tread pattern are used.
- Objects or patterns that could be mistaken for white (yellow) lines are present on the side of the road (guardrails, curbs, reflective poles, etc.).
- Vehicle is driven on a snow-covered road.
- White (yellow) lines are difficult to see due to rain, snow, fog, dust, etc.

⚠ WARNING

- Asphalt repair marks, white (yellow) line marks, etc. are present due to road repair.
- Vehicle is driven in a temporary lane or restricted lane due to construction work.
- Vehicle is driven on a road surface which is slippery due to rainy weather, fallen snow, freezing, etc.
- Vehicle is driven in traffic lanes other than on highways and freeways.
- Vehicle is driven in a construction zone.
- During emergency towing
- **Preventing LDA system malfunctions and operations performed by mistake**
- Do not modify the headlights or place stickers, etc. on the surface of the lights.
- Do not modify the suspension etc. If the suspension etc. needs to be replaced, contact your Lexus dealer.
- Do not install or place anything on the hood or grille. Also, do not install a grille guard (bull bars, kangaroo bar, etc.).
- If your windshield needs repairs, contact your Lexus dealer.

Turning LDA system on

Press the LDA switch to turn the LDA system on.

The LDA indicator illuminates and a message is displayed on the multi-information display.

Press the LDA switch again to turn the LDA system off.

When the LDA system is turned on or off, operation of the LDA system continues in

the same condition the next time the engine is started.

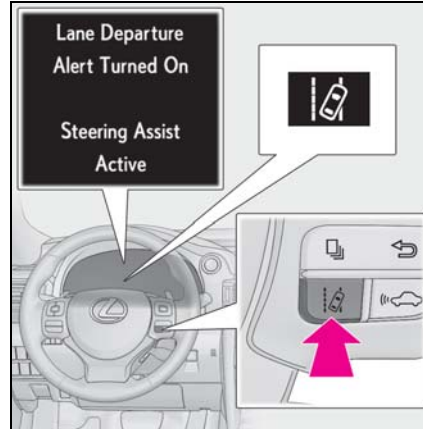
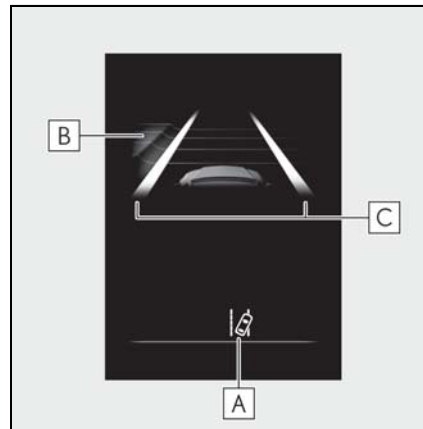
**Indications on multi-information display****A** LDA indicator

The illumination condition of the indicator informs the driver of the system operation status.

Illuminated in white:
LDA system is operating.

Illuminated in green:
Steering wheel assistance of the steering control function is operating.

Flashing in orange:

Lane departure alert function is operating.

B Operation display of steering wheel operation support

Indicates that steering wheel assistance of the steering control function is operating.

C Lane departure alert function display

Displayed when the multi-information display is switched to the driving assist system information screen.

- ▶ Inside of displayed white lines is white

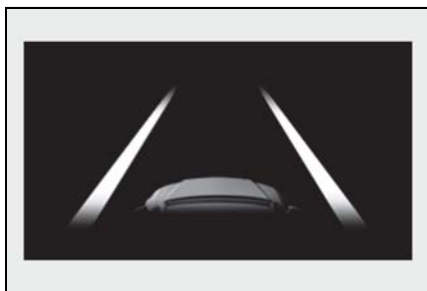

Indicates that the system is recognizing white (yellow) lines. When the vehicle departs from its lane, the white line displayed on the side the vehicle departs from flashes orange.

- ▶ Inside of displayed white lines is black



Indicates that the system is not able to recognize white (yellow) lines or is temporarily canceled.

■ Operation conditions of each function

● Lane departure alert function

This function operates when all of the following conditions are met.

- LDA is turned on.
- Vehicle speed is approximately 32 mph (50 km/h) or more.
- System recognizes white (yellow) lines.
- Width of traffic lane is approximately 9.8 ft. (3 m) or more.
- Turn signal lever is not operated.
- Vehicle is driven on a straight road or around a gentle curve with a radius of more than approximately 492 ft. (150 m).
- No system malfunctions are detected. (→P.174)

● Steering control function

This function operates when all of the following conditions are met in addition to the operation conditions for the lane departure alert function.

- Setting for "Steering Assist" in  of the multi-information display is set to "On". (→P.71)
- Vehicle is not accelerated or decelerated by a certain amount or more.
- Steering wheel is not operated with a steering force level suitable for changing lanes.
- ABS, VSC, TRAC and PCS are not operating.
- TRAC or VSC is not turned off.
- Hands off steering wheel warning is not displayed. (→P.173)

● Vehicle sway warning function

This function operates when all of the following conditions are met.

- Setting for "Sway Warning" in  of the multi-information display is set to "On". (→P.71)
- Vehicle speed is approximately 32 mph (50 km/h) or more.
- Width of traffic lane is approximately 9.8 ft. (3 m) or more.
- No system malfunctions are detected. (→P.174)

■ Temporary cancellation of functions

When the operation conditions are no longer met, a function may be temporarily can-

celed. However, when the operation conditions are met again, operation of the function is automatically restored. (→P.172)

■ Steering control function

Depending on the vehicle speed, lane departure situation, road conditions, etc., the driver may not feel the function is operating or the function may not operate at all.

■ Lane departure alert function

The warning buzzer may be difficult to hear due to external noise, audio playback, etc. Also, it may be difficult to feel steering wheel vibrations due to the road conditions etc.

■ Hands off steering wheel warning

In the following situations, a warning message urging the driver to hold the steering wheel and the symbol shown in the illustration are displayed on the multi-information display to warn the driver. The warning stops when the system determines that the driver holds the steering wheel. Always keep your hands on the steering wheel when using this system, regardless of warnings.

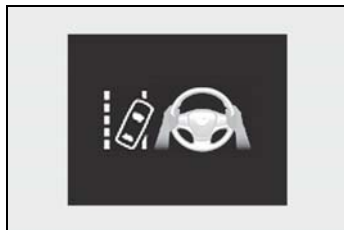

- When the system determines that the driver is driving without holding the steering wheel while the system is operating

If the driver continues to keep their hands off of the steering wheel, the buzzer sounds, the driver is warned and the function is temporarily canceled. This warning also operates in the same way when the driver continuously operates the steering wheel only a small amount.

The buzzer also sounds even if the alert type is set to .

Depending on the vehicle condition and road conditions, the warning may not

operate. Also, if the system determines that the vehicle is driving around a curve, warnings will occur earlier than during straight-lane driving.

- When the system determines that the driver is driving without holding the steering wheel while the steering wheel assist of the steering assist function is operating.

If the driver continues to keep their hands off of the steering wheel and the steering wheel assist is operating, the buzzer sounds and the driver is warned. Each time the buzzer sounds, the continuing time of the buzzer becomes longer.

The buzzer also sounds even if the alert type is set to .

■ Vehicle sway warning function

When the system determines that the vehicle is swaying while the vehicle sway warning function is operating, a buzzer sounds and a warning message urging the driver to rest and the symbol shown in the illustration are simultaneously displayed on the multi-information display.

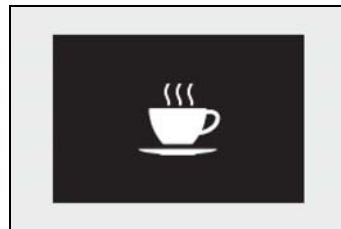

Depending on the vehicle and road conditions, the warning may not operate.

■ White (yellow) lines are only on one side of road

The LDA system will not operate for the side on which white (yellow) lines could not be recognized.

■ Conditions in which functions may not operate properly

In the following situations, the camera sensor may not detect white (yellow) lines and various functions may not operate normally.

- There are shadows on the road that run parallel with, or cover, the white (yellow) lines.
- The vehicle is driven in an area without white (yellow) lines, such as in front of a tollgate or checkpoint, or at an intersection, etc.
- The white (yellow) lines are cracked, "Botts' dots", "Raised pavement marker" or stones are present.
- The white (yellow) lines cannot be seen or are difficult to see due to sand, etc.
- The vehicle is driven on a road surface that is wet due to rain, puddles, etc.
- The traffic lines are yellow (which may be more difficult to recognize than lines that are white).
- The white (yellow) lines cross over a curb, etc.
- The vehicle is driven on a bright surface, such as concrete.
- The vehicle is driven on a surface that is bright due to reflected light, etc.
- The vehicle is driven in an area where the brightness changes suddenly, such as at the entrances and exits of tunnels, etc.
- Light from the headlights of an oncoming vehicle, the sun, etc. enters the camera.
- The vehicle is driven where the road diverges, merges, etc.
- The vehicle is driven on a slope.
- The vehicle is driven on a road which tilts left or right, or a winding road.
- The vehicle is driven on an unpaved or rough road.
- The vehicle is driven around a sharp curve.
- The traffic lane is excessively narrow or wide.
- The vehicle is extremely tilted due to carrying heavy luggage or having improper tire pressure.
- The distance to the preceding vehicle is extremely short.
- The vehicle is moving up and down a large amount due to road conditions during driving (poor roads or road seams).
- The headlight lenses are dirty and emit a faint amount of light at night, or the beam axis has deviated.
- The vehicle is struck by a crosswind.
- The vehicle has just changed lanes or crossed an intersection.
- Snow tires, etc. are equipped.

■ Warning message

If the following warning message is displayed on the multi-information display and the LDA indicator illuminates in orange, follow the appropriate troubleshooting procedure.

Warning message	Details/Actions
"Lane Departure Alert Malfunction Visit Your Dealer"	The system may not be operating properly. →Have the vehicle inspected at your Lexus dealer.
"Front Camera Unavailable Remove Debris On Windshield"	Dirt, rain, condensation, ice, snow, etc. are present on the windshield in front of the camera sensor. →Turn the LDA system off, remove any dirt, rain, condensation, ice, snow, etc. from the windshield, and then turn the LDA system back on.

Warning message	Details/Actions
"Front Camera Unavailable"	The operation conditions of the camera sensor (temperature, etc.) are not met. →When the operation conditions of the camera sensor (temperature, etc.) are met, the LDA system will become available. Turn the LDA system off, wait for a little while, and then turn the LDA system back on.
"Lane Departure Alert Unavailable"	The LDA system is temporarily canceled due to a malfunction in a sensor other than the camera sensor. →Turn the LDA system off and follow the appropriate troubleshooting procedures for the warning message. Afterward, drive the vehicle for a short time, and then turn the LDA system back on.
"Lane Departure Alert Unavailable Below Approx 32MPH"	The LDA system cannot be used as the vehicle speed is less than approximately 32 mph (50 km/h). →Drive the vehicle at approximately 32 mph (50 km/h) or more.
"Lane Departure Alert Unavailable at Current Speed"	The LDA system cannot be used as the vehicle speed is too high. →Slow down.

If a different warning message is displayed, follow the instructions displayed on the screen.

■ Customization

The following settings can be changed.

Function	Setting details
Lane departure alert function	Adjust alert sensitivity
	Adjust alert type
Steering control function	Turn steering wheel assistance on and off
Vehicle sway warning function	Turn function on and off
	Adjust alert sensitivity

For how to change settings, refer to P.351

Dynamic radar cruise control with full-speed range

In vehicle-to-vehicle distance control mode, the vehicle automatically accelerates, decelerates and stops to match the speed changes of the preceding vehicle even if the accelerator pedal is not depressed. In constant speed control mode, the vehicle runs at a fixed speed.

Use the dynamic radar cruise control with full-speed range on freeways and highways.

- Vehicle-to-vehicle distance control mode (→P.178)
- Constant speed control mode (→P.182)

System Components

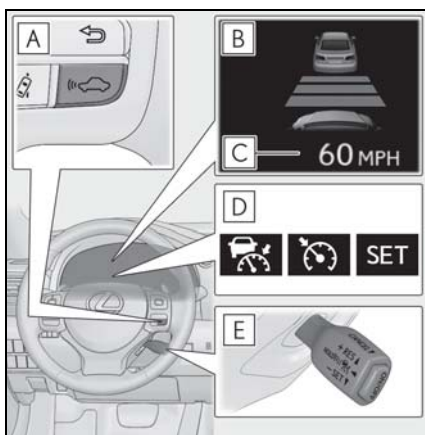

- A** Vehicle-to-vehicle distance switch
- B** Display
- C** Set speed
- D** Indicators

E Cruise control switch

! WARNING

■ Before using dynamic radar cruise control with full-speed range

- Driving safely is the sole responsibility of the driver. Do not rely solely on the system, and drive safely by always paying careful attention to your surroundings.
- The dynamic radar cruise control with full-speed range provides driving assistance to reduce the driver's burden. However, there are limitations to the assistance provided. Read the following conditions carefully. Do not overly rely on this system and always drive carefully.
 - When the sensor may not be correctly detecting the vehicle ahead: →P.184
 - Conditions under which the vehicle-to-vehicle distance control mode may not function correctly: →P.184
- Set the speed appropriately depending on the speed limit, traffic flow, road conditions, weather conditions, etc. The driver is responsible for checking the set speed.
- Even when the system is functioning normally, the condition of the preceding vehicle as detected by the system may differ from the condition observed by the driver. Therefore, the driver must always remain alert, assess the danger of each situation and drive safely. Relying on this system or assuming the system ensures safety while driving can lead to an accident, resulting in death or serious injury.
- Switch the dynamic radar cruise control with full-speed range off using the "ON/OFF" button when not in use.

**WARNING****■ Cautions regarding the driving assist systems**

Observe the following precautions, as there are limitations to the assistance provided by the system. Failure to do so may cause an accident resulting in death or serious injury.

● **Assisting the driver to measure following distance**

The dynamic radar cruise control with full-speed range is only intended to help the driver in determining the following distance between the driver's own vehicle and a designated vehicle traveling ahead. It is not a mechanism that allows careless or inattentive driving, and it is not a system that can assist the driver in low-visibility conditions. It is still necessary for driver to pay close attention to the vehicle's surroundings.

● **Assisting the driver to judge proper following distance**

The dynamic radar cruise control with full-speed range determines whether the following distance between the driver's own vehicle and a designated vehicle traveling ahead is within a set range. It is not capable of making any other type of judgement. Therefore, it is absolutely necessary for the driver to remain vigilant and to determine whether or not there is a possibility of danger in any given situation.

● **Assisting the driver to operate the vehicle**

The dynamic radar cruise control with full-speed range has limited capability to prevent or avoid a collision with a vehicle traveling ahead. Therefore, if there is ever any danger, the driver must take immediate and direct control of the vehicle and act appropriately in order to ensure the safety of all involved.

■ Situations unsuitable for dynamic radar cruise control with full-speed range

Do not use dynamic radar cruise control with full-speed range in any of the following situations.

Doing so may result in inappropriate speed control and could cause an accident resulting in death or serious injury.

- Roads where there are pedestrians, cyclists, etc.
- In heavy traffic
- On roads with sharp bends
- On winding roads
- On slippery roads, such as those covered with rain, ice or snow
- On steep downhill, or where there are sudden changes between sharp up and down gradients
Vehicle speed may exceed the set speed when driving down a steep hill.
- At entrances to freeways and highways
- When weather conditions are bad enough that they may prevent the sensors from detecting correctly (fog, snow, sandstorm, heavy rain, etc.)
- When there is rain, snow, etc. on the front surface of the radar sensor or camera sensor
- In traffic conditions that require frequent repeated acceleration and deceleration
- During emergency towing
- When an approach warning buzzer is heard often

Driving in vehicle-to-vehicle distance control mode

This mode employs a radar sensor to detect the presence of vehicles up to approximately 328 ft. (100 m) ahead, determines the current vehicle-to-vehicle following distance, and operates to maintain a suitable following distance from the vehicle ahead.

Note that vehicle-to-vehicle distance will close in when traveling on downhill slopes.

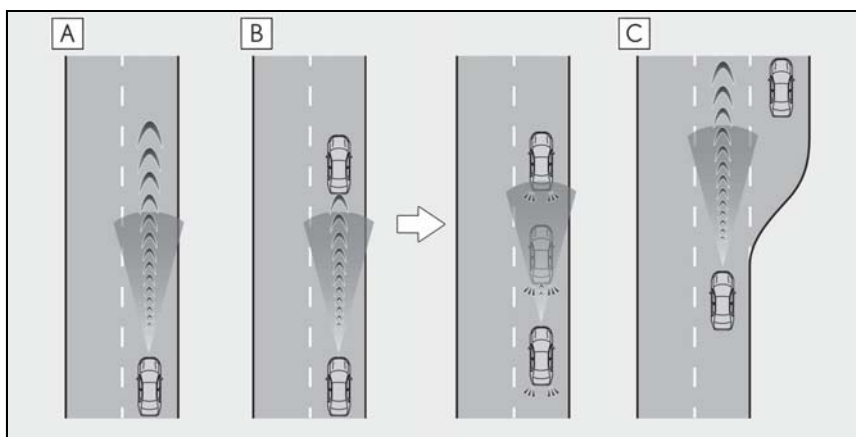

A Example of constant speed cruising
When there are no vehicles ahead

The vehicle travels at the speed set by the driver. The desired vehicle-to-vehicle distance can also be set by operating the vehicle-to-vehicle distance switch.

B Example of deceleration cruising and follow-up cruising

When a preceding vehicle driving slower than the set speed appears

When a vehicle is detected running ahead of you, the system automatically decelerates your vehicle. When a greater reduction in vehicle speed is necessary, the system applies the brakes (the stop lights will come on at this time). The system will respond to changes in the speed of the vehicle ahead in order to maintain the vehicle-to-vehicle distance set by the driver. Approach warning warns you when the system cannot decelerate sufficiently to prevent your vehicle from closing in on the vehicle ahead.

When the vehicle ahead of you stops, your vehicle will also stop (vehicle is stopped by system control). After the vehicle ahead starts off, pushing the cruise control lever up or depressing the accelerator pedal will resume follow-up cruising.

C Example of acceleration

When there are no longer any preceding vehicles driving slower than the set speed

The system accelerates until the set speed is reached. The system then returns to constant speed cruising.

Setting the vehicle speed (vehicle-to-vehicle distance control mode)

- 1 Press the "ON/OFF" button to activate the cruise control.

Dynamic radar cruise control indicator will come on and a message will be displayed on the multi-information display.

Press the button again to deactivate the cruise control.

If the "ON/OFF" button is pressed and held for 1.5 seconds or more, the system turns on in constant speed control mode. (→P.182)



- 2 Accelerate or decelerate, with accelerator pedal operation, to the desired vehicle speed (at or above approximately 30 mph [50 km/h]) and push the lever down to set the speed.

Cruise control "SET" indicator will come on.

The vehicle speed at the moment the lever is released becomes the set speed.

If the lever is operated while the vehicle speed is below approximately 30 mph (50 km/h) and a preceding vehicle is present, the set speed will be adjusted to approxi-

mately 30 mph (50 km/h).

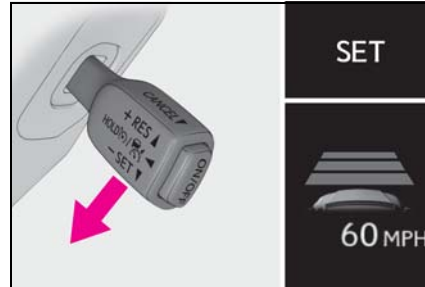

Adjusting the set speed

To change the set speed, operate the lever until the desired set speed is displayed.

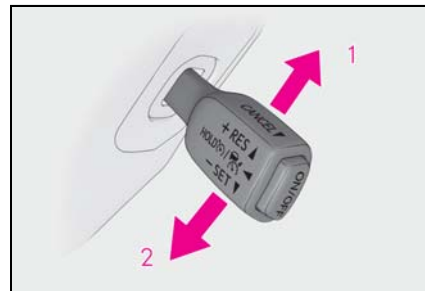

- 1 Increases the speed (Except when the vehicle has been stopped by system control in vehicle-to-vehicle distance control mode)
- 2 Decreases the speed

Fine adjustment: Momentarily move the lever in the desired direction.

Large adjustment: Hold the lever up or down to change the speed, and release when the desired speed is reached.

In the vehicle-to-vehicle distance control mode, the set speed will be increased or decreased as follows:

■ For the U.S. mainland and Hawaii

Fine adjustment: By 1 mph (1.6 km/h)^{*1} or 1

km/h (0.6 mph)^{*2} each time the lever is operated

Large adjustment: Increases or decreases in 1 mph (1.6 km/h)^{*1} or 1 km/h (0.6 mph)^{*2} increments for as long as the lever is held

■ For Canada, Guam and Puerto Rico

Fine adjustment: By 1 mph (1.6 km/h)^{*1} or 1 km/h (0.6 mph)^{*2} each time the lever is operated

Large adjustment: Increases or decreases in 5 mph (8 km/h)^{*1} or 5 km/h (3.1 mph)^{*2} increments for as long as the lever is held

In the constant speed control mode (→P.182), the set speed will be increased or decreased as follows:

Fine adjustment: By 1 mph (1.6 km/h)^{*1} or 1.6 km/h (1 mph)^{*2} each time the lever is operated

Large adjustment: The speed will continue to change while the lever is held.

*1: When the set speed is shown in "MPH"

*2: When the set speed is shown in "km/h"

Changing the vehicle-to-vehicle distance (vehicle-to-vehicle distance control mode)

Pressing the switch changes the vehicle-to-vehicle distance as follows:

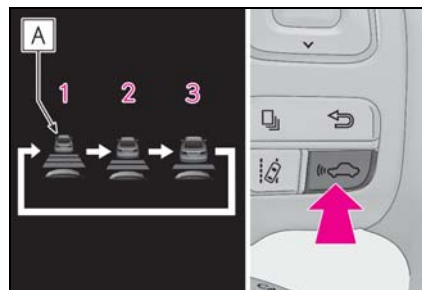

- 1 Long
- 2 Medium
- 3 Short

The vehicle-to-vehicle distance is set automatically to long mode when the engine switch is turned to IGNITION ON mode.

If a vehicle is running ahead of you, the preceding vehicle mark **A** will also be displayed.

Vehicle-to-vehicle distance settings (vehicle-to-vehicle distance control mode)

Select a distance from the table below. Note that the distances shown correspond to a vehicle speed of 50 mph (80 km/h). Vehicle-to-vehicle distance increases/decreases in accordance with vehicle speed. When the vehicle is stopped by system control, the vehicle stops at a certain vehicle-to-vehicle distance depending on the situation.

Distance options	Vehicle-to-vehicle distance
Long	Approximately 160 ft. (50 m)

Distance options	Vehicle-to-vehicle distance
Medium	Approximately 130 ft. (40 m)
Short	Approximately 100 ft. (30 m)

Resuming follow-up cruising when the vehicle has been stopped by system control (vehicle-to-vehicle distance control mode)

After the vehicle ahead of you starts off, push the lever up.

Your vehicle will also resume follow-up cruising if the accelerator pedal is depressed after the vehicle ahead of you starts off.

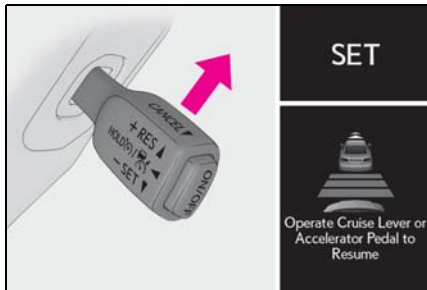

Canceling and resuming the speed control

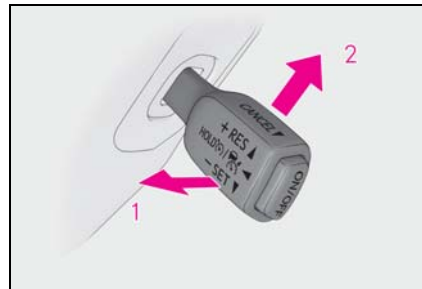

1 Pulling the lever toward you cancels the speed control.

The speed control is also canceled when the brake pedal is depressed. (When the vehicle has been stopped by system control, depressing the brake pedal does not cancel the setting.)

2 Pushing the lever up resumes the cruise control and returns vehicle speed to the set speed.

However, when a vehicle ahead is not detected, cruise control does not resume when the vehicle speed is approximately 25 mph (40 km/h) or less.

Approach warning (vehicle-to-vehicle distance control mode)

When your vehicle is too close to a vehicle ahead, and sufficient automatic deceleration via the cruise control is not possible, the display will flash and the buzzer will sound to alert the driver. An example of this would be if another driver cuts in front of you while you are following a vehicle. Depress the brake pedal to ensure an appropriate vehicle-to-vehicle distance.

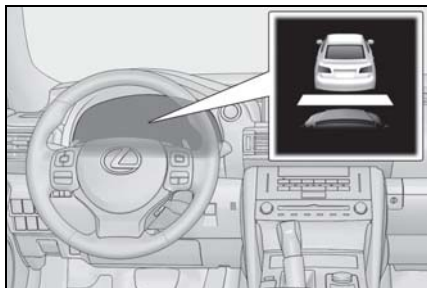

■ Warnings may not occur when

In the following instances, warnings may not occur even when the vehicle-to-vehicle distance is small.

- When the speed of the preceding vehicle matches or exceeds your vehicle speed
- When the preceding vehicle is traveling at an extremely slow speed
- Immediately after the cruise control speed was set
- When depressing the accelerator pedal

Selecting constant speed control mode

When constant speed control mode is selected, your vehicle will maintain a set speed without controlling the vehicle-to-vehicle distance. Select this mode only when vehicle-to-vehicle distance control mode does not function correctly due to a dirty radar sensor, etc.

- 1 With the cruise control off, press and hold the "ON/OFF" button for 1.5 seconds or more.

Immediately after the "ON/OFF" button is pressed, the dynamic radar cruise control

indicator will come on. Afterwards, it switches to the cruise control indicator.

Switching to constant speed control mode is only possible when operating the lever with the cruise control off.

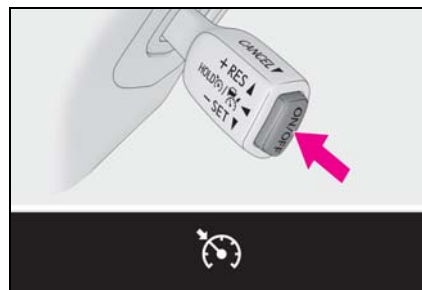

- 2 Accelerate or decelerate, with accelerator pedal operation, to the desired vehicle speed (at or above approximately 30 mph [50 km/h]) and push the lever down to set the speed.

Cruise control "SET" indicator will come on.

The vehicle speed at the moment the lever is released becomes the set speed.

Adjusting the speed setting: →P.179

Canceling and resuming the speed setting: →P.181

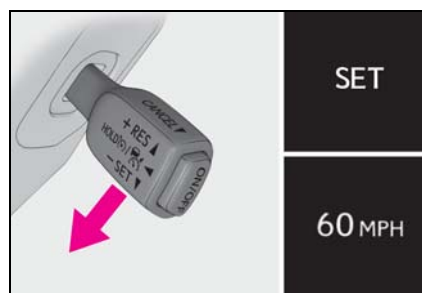

■ Dynamic radar cruise control with full-speed range can be set when

- The shift lever is in D.
- Range 4 or higher of D has been selected by using the paddle shift switch.
- Vehicle speed is at or above approxi-

mately 30 mph (50 km/h).

However, when a preceding vehicle is detected, the dynamic radar cruise control with full-speed range can be set even if the vehicle speed is below approximately 30 mph (50 km/h).

■ Accelerating after setting the vehicle speed

The vehicle can accelerate by operating the accelerator pedal. After accelerating, the set speed resumes. However, during vehicle-to-vehicle distance control mode, the vehicle speed may decrease below the set speed in order to maintain the distance to the preceding vehicle.

■ When the vehicle stops while follow-up cruising

- Pushing the lever up while the vehicle ahead stops will resume follow-up cruising if the vehicle ahead starts off within approximately 3 seconds after the lever is pushed up.
- If the vehicle ahead starts off within 3 seconds after your vehicle stops, follow-up cruising will be resumed.

■ Automatic cancelation of vehicle-to-vehicle distance control mode

Vehicle-to-vehicle distance control mode is automatically canceled in the following situations:

- Actual vehicle speed falls at or below approximately 25 mph (40 km/h) when there are no vehicles ahead.
- The preceding vehicle leaves the lane when your vehicle is following at a vehicle speed at or below approximately 25 mph (40 km/h). Otherwise, the sensor can not properly detect the vehicle. ("Radar Cruise Control Not Available No Preceding Vehicles" is displayed on the multi-information display)
- VSC is activated.
- TRAC is activated for a period of time.
- When the VSC or TRAC system is turned off.
- When snow mode is set.
- The sensor cannot detect correctly because it is covered in some way.

- Pre-collision braking is activated.
- The parking brake is operated.
- The vehicle is stopped by system control on a steep incline.
- The following are detected when the vehicle has been stopped by system control:
 - The driver is not wearing a seat belt.
 - The driver's door is opened.
 - The vehicle has been stopped for about 3 minutes.

If vehicle-to-vehicle distance control mode is automatically canceled for any reasons other than the above, there may be a malfunction in the system. Contact your Lexus dealer.

■ Automatic cancelation of constant speed control mode

Constant speed control mode is automatically canceled in the following situations:

- Actual vehicle speed is more than approximately 10 mph (16 km/h) below the set vehicle speed.
- Actual vehicle speed falls below approximately 25 mph (40 km/h).
- VSC is activated.
- TRAC is activated for a period of time.
- When the VSC or TRAC system is turned off.
- Pre-collision braking is activated.

If constant speed control mode is automatically canceled for any other reason, there may be a malfunction in the system. Contact your Lexus dealer.

■ Brake system operation sound

If the brakes are applied automatically while the vehicle is in vehicle-to-vehicle distance control mode, a brake system operation sound may be heard. This does not indicate a malfunction.

■ Warning messages and buzzers for dynamic radar cruise control with full-speed range

Warning messages and buzzers are used to indicate a system malfunction or to inform the driver of the need for caution while driving. If a warning message is shown on the

multi-information display, read the message and follow the instructions.

■ **When the sensor may not be correctly detecting the vehicle ahead**

In the case of the following and depending on the conditions, operate the brake pedal when deceleration of the system is insufficient or operate the accelerator pedal when acceleration is required.

As the sensor may not be able to correctly detect these types of vehicles, the approach warning (→P.181) may not be activated.

- Vehicles that cut in suddenly
- Vehicles traveling at low speeds
- Vehicles that are not moving in the same lane
- Vehicles with small rear ends (trailers with no load on board, etc.)

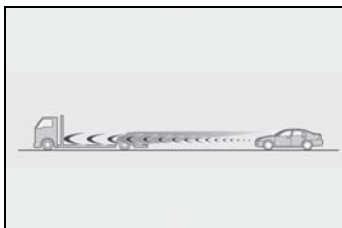

- Motorcycles traveling in the same lane
- When water or snow thrown up by the surrounding vehicles hinders the detecting of the sensor
- When your vehicle is pointing upwards (caused by a heavy load in the luggage compartment, etc.)

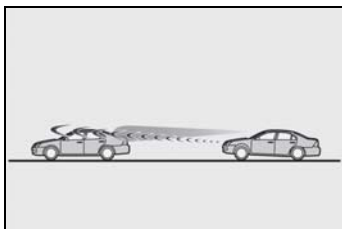

- Preceding vehicle has an extremely high ground clearance

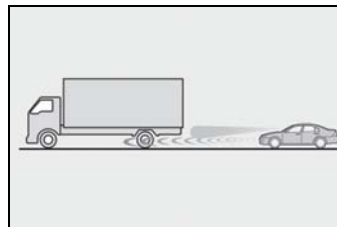

■ **Conditions under which the vehicle-to-vehicle distance control mode may not function correctly**

In the case of the following conditions, operate the brake pedal (or accelerator pedal, depending on the situation) as necessary.

As the sensor may not be able to correctly detect vehicles ahead, the system may not operate properly.

- When the road curves or when the lanes are narrow

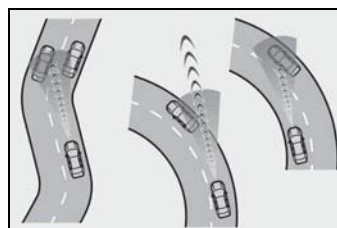

- When steering wheel operation or your position in the lane is unstable

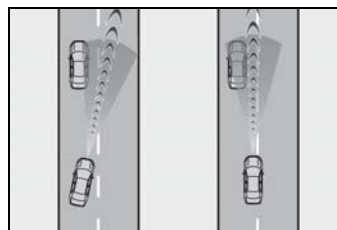

- When the vehicle ahead of you decelerates suddenly
- When driving on a road surrounded by a structure, such as in a tunnel or on a bridge
- While the vehicle speed is decreasing to the set speed after the vehicle accelerates by depressing the accelerator pedal

Intuitive parking assist*

*: If equipped

The distance from your vehicle to nearby obstacles when parallel parking or maneuvering into a garage is measured by the sensors and communicated via the multi-information display, Center Display and a buzzer. Always check the surrounding area when using this system.

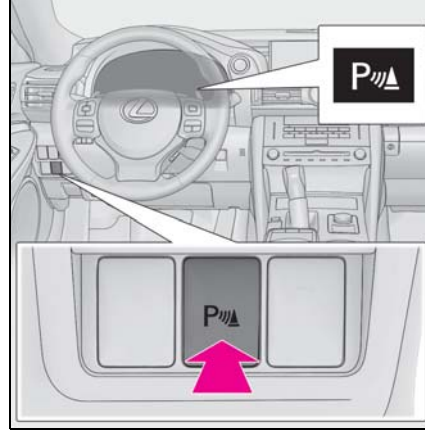

Types of sensors

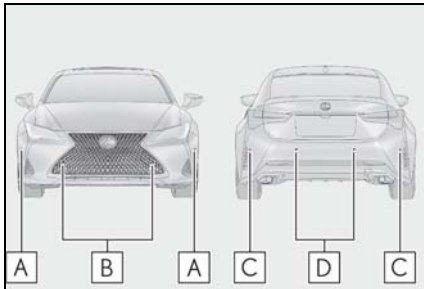

- A** Front corner sensors
- B** Front center sensors
- C** Rear corner sensors
- D** Rear center sensors

Intuitive parking assist switch

Turns the intuitive parking assist on/off
When on, the indicator light comes on to inform the driver that the system is operational.

Display

When the sensors detect an obstacle, a graphic is shown on the multi-information display and Center Display depending on the position and distance to the obstacle.

■ **Multi-information display**

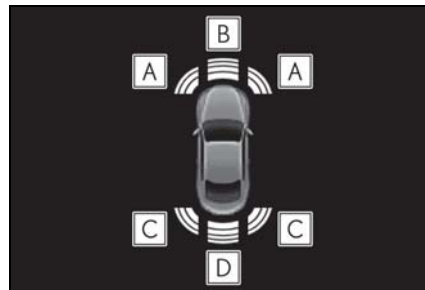

- A** Front corner sensor detection
- B** Front center sensor detection
- C** Rear corner sensor detection
- D** Rear center sensor detection

■ **Center Display**

A graphic is shown when the Lexus parking assist monitor is displayed (insert display).

A simplified image is displayed on the Center Display when an object is detected.

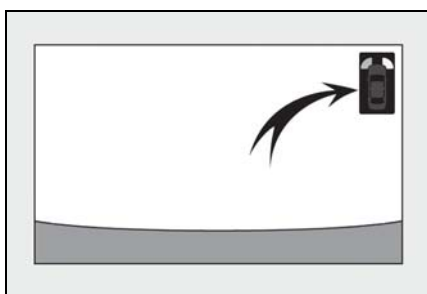

⚠ WARNING

■ When using the intuitive parking assist

Observe the following precautions. Failing to do so may result in the vehicle being unable to be driven safely and possibly cause an accident.

- Do not use the sensor at speeds in excess of 6 mph (10 km/h).
- The sensors' detection areas and reaction times are limited. When moving forward or reversing, check the areas surrounding the vehicle (especially the sides of the vehicle) for safety, and drive slowly, using the brake to control the vehicle's speed.
- Do not install accessories within the sensors' detection areas.
- The area directly under the bumpers is not detected.
Thin posts or objects lower than a sensor may not be detected when approached, even if they have been detected once.

■ When to disable the function

In the following situations, disable the function as it may operate even though there is no possibility of a collision.

- The vehicle is equipped with a fender pole, wireless antenna or fog lights.

- The front or rear bumper or a sensor receives a strong impact.
- A non-genuine Lexus suspension (lowered suspension, etc.) is installed.
- Towing eyelets are installed.
- A backlit license plate is installed.

■ When using intuitive parking assist

In the following situations, the system may not function correctly due to a sensor malfunction, etc. Have the vehicle checked by your Lexus dealer.

- The intuitive parking assist operation display flashes or shows continuously, and a buzzer sounds when no objects are detected.
- If the area around a sensor collides with something, or is subjected to strong impact.
- If the bumper or grille collides with something.
- If the display flashes or is displayed continuously and a buzzer does not sound, except when the mute function has been turned on.
- If a display error occurs, first check the sensor.
If the error occurs even when there is no ice, snow or mud on the sensor, it is likely that the sensor is malfunctioning.

■ Notes when washing the vehicle

Do not apply intensive bursts of water or steam to the sensor area.

Doing so may result in the sensor malfunctioning.

- When using a high pressure washer to wash the vehicle, do not spray the sensors directly, as doing so may cause a sensor to malfunction.
- When using steam to clean the vehicle, do not direct steam too close to the sensors as doing so may cause a sensor to malfunction.

■ The intuitive parking assist can be operated when

- Front center sensors:
 - The engine switch is in IGNITION ON mode.
 - The shift lever is in a position other than P or R.
 - The vehicle speed is less than about 6 mph (10 km/h).
- Front corner sensors:
 - The engine switch is in IGNITION ON mode.
 - The shift lever is in a position other than P.
 - The vehicle speed is less than about 6 mph (10 km/h).
(At any speed when the shift lever is in R)
- Rear corner and rear center sensors:
 - The engine switch is in IGNITION ON mode.
 - The shift lever is in R.

■ Muting the buzzer sound

- To mute the buzzer sound:

The buzzer can be temporarily muted by pressing "OK" of the meter control switches while an obstacle detection display is shown on the multi-information display.

- To cancel the mute:

Mute will be automatically canceled in the following situations.

- When the shift position is changed (except shifting from D to N, or N to D).
- When the vehicle speed has reached or exceeded 6 mph (10 km/h) with the shift position in D.
- When the intuitive parking assist is turned off once and turned on again.
- When the engine switch is turned off once and turned to IGNITION ON mode again.

■ If "Clean Parking Assist Sensor" is displayed on the multi-information display

A sensor may be covered with ice, snow, dirt, etc. Remove the ice, snow, dirt, etc., from the sensor to return the system to normal.

Also, due to ice forming on a sensor at low temperatures, a warning message may be

displayed or the sensor may not be able to detect an object. Once the ice melts, the system will return to normal.

■ Sensor detection information

- The following situations may occur during use.
 - The sensors may be able to only detect objects near the front and rear bumpers.
 - Depending on the shape of the object and other factors, the detection distance may shorten, or detection may be impossible.
 - There will be a short delay between object detection and display. Even at low speeds, there is a possibility that the object will come within the sensor's detection areas before the display is shown and the warning beep sounds.
 - It might be difficult to hear the buzzer due to the volume of the audio system or air flow noise of the air conditioning system.
 - It may be difficult to hear the buzzer if buzzers for other systems are sounding.

■ Conditions under which the function may not function correctly

Certain vehicle conditions and the surrounding environment may affect the ability of a sensor to correctly detect objects. Particular instances where this may occur are listed below.

- There is dirt, snow or ice on a sensor. (Cleaning the sensors will resolve this problem.)
- A sensor is frozen. (Thawing the area will resolve this problem.)
In especially cold weather, if a sensor is frozen the sensor display may be displayed abnormally, or objects, such as a wall, may not be detected.
- A sensor is covered in any way.
- When a sensor or the area around a sensor is extremely hot or cold.
- On an extremely bumpy road, on an incline, on gravel, or on grass.
- The vicinity of the vehicle is noisy due to vehicle horns, motorcycle engines, air brakes of large vehicles, or other loud noises producing ultrasonic waves.
- There is another vehicle equipped with

parking assist sensors in the vicinity.

- A sensor is coated with a sheet of spray or heavy rain.
- If a sensor is hit by a large amount of water, such as when driving on a flooded road.
- If the vehicle is significantly tilted.
- The vehicle is approaching a tall or curved curb.
- If objects draw too close to the sensor.

■ **Objects which may not be properly detected**

The shape of the object may prevent the sensor from detecting it. Pay particular

attention to the following objects:

- Wires, fences, ropes, etc.
- Cotton, snow and other materials that absorb sound waves
- Sharply-angled objects
- Low objects
- Tall objects with upper sections projecting outwards in the direction of your vehicle

People may not be detected if they are wearing certain types of clothing.

■ **Customization**



Settings can be changed. (→P.358)

Sensor detection display, obstacle distance



■ **Multi-information display and Center Display**

Sensors that detect an obstacle will illuminate continuously or blink.



- Approximate distance to object: 3.3 ft. (100 cm) to 1.6 ft. (50 cm) (Front center sensor)
Approximate distance to object: 4.9 ft. (150 cm) to 2.0 ft. (60 cm) (Rear center sensor)

Multi-information display	Insert display (Center Display)
 (continuous)	 (blinking slowly)



- Approximate distance to object: 1.6 ft. (50 cm) to 1.3 ft. (40 cm) (Front corner sensor/front center sensor)
Approximate distance to object: 2.0 ft. (60 cm) to 1.5 ft. (45 cm) (Rear corner sensor/rear center sensor)

Multi-information display	Insert display (Center Display)
 (continuous)	 (blinking)

- Approximate distance to object: 1.3 ft. (40 cm) to 1.0 ft. (30 cm) (Front corner sensor/front center sensor)
 Approximate distance to object: 1.5 ft. (45 cm) to 1.0 ft. (30 cm) (Rear corner sensor)
 Approximate distance to object: 1.5 ft. (45 cm) to 1.1 ft. (35 cm) (Rear center sensor)

Multi-information display	Insert display (Center Display)
 (continuous)	 (blinking rapidly)

- Approximate distance to object: Less than 1.0 ft. (30 cm) (Corner sensor/front center sensor)
 Approximate distance to object: Less than 1.1 ft. (35 cm) (Rear center sensor)

Multi-information display	Insert display (Center Display)
 (blinking)	 (continuous)

■ **Buzzer operation and distance to an obstacle**

A buzzer sounds when the sensors are operating.

- The buzzer beeps faster as the vehicle approaches an obstacle. When the vehicle comes within the following distance of the obstacle, the buzzer sounds continuously:
 - Front center sensors: Approximately 1.0 ft. (30 cm)
 - Corner sensors: Approximately 1.0 ft. (30 cm)
 - Rear center sensors: Approximately 1.1ft. (35 cm)
- When 2 or more obstacles are

detected simultaneously, the buzzer system responds to the nearest obstacle. If one or both come within the above distances, the beep will repeat a long tone, followed by fast beeps.

Detection range of the sensors

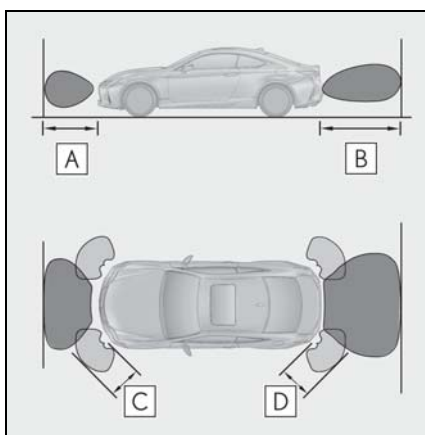

A Approximately 3.3 ft. (100 cm)

B Approximately 4.9 ft. (150 cm)

C Approximately 1.6 ft. (50 cm)

D Approximately 2.0 ft. (60 cm)

The diagram shows the detection range of the sensors. Note that the sensors cannot detect obstacles that are extremely close to the vehicle.

The range of the sensors may change depending on the shape of the object, etc.

Setting up intuitive parking assist

You can change the warning beep volume and Center Display operating conditions.

- 1** Press the "MENU" button on the Remote Touch. (→P.210)
- 2** Select "Setup" on the "Menu" screen.
- 3** Select "Vehicle" on the "Setup" screen.
- 4** Select "LEXUS Park Assist" on the vehicle settings screen.

- 5** Select the desired button.

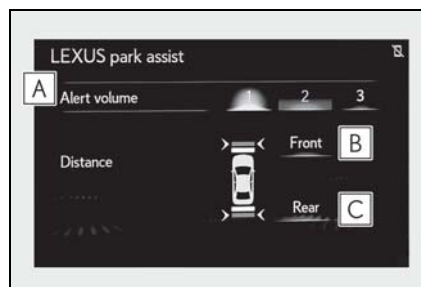

A The alert volume can be adjusted.

B Front center sensor display and tone indication can be set.

C Rear center sensor display and tone indication can be set.

BSM (Blind Spot Monitor)*

*: If equipped

The Blind Spot Monitor is a system that uses rear side radar sensors installed on the inner side of the rear bumper on the left and right side to assist the driver in confirming safety when changing lanes.

Summary of the Blind Spot Monitor

The Blind Spot Monitor is a system that has 2 functions:

- The BSM (Blind Spot Monitor) function
Assists the driver in making a decision when changing lanes
- The RCTA (Rear Cross Traffic Alert) function
Assists the driver when backing up

These functions use same sensors.

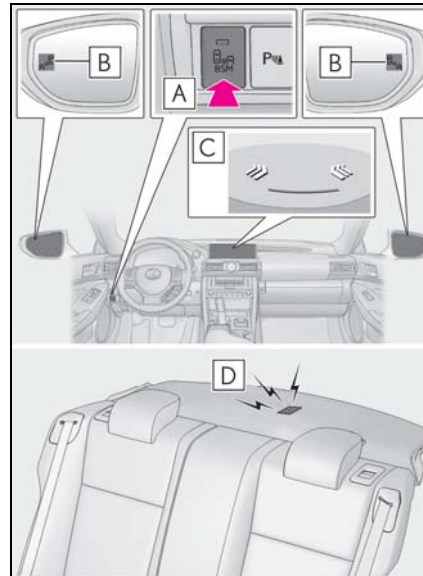
**A** BSM main switch

This switch is for both the BSM function and RCTA function. Pressing the switch turns the system on or off. When the switch is turned on, the indicator on the switch illuminates.

B Outside rear view mirror indicators

BSM function:

When a vehicle is detected in a blind spot of the outside rear view mirrors or approaching rapidly from behind into a blind spot, the outside rear view mirror indicator on the detected side will illuminate. If the turn signal lever is operated toward the detected side, the outside rear view mirror indicator will flash.

RCTA function:

When a vehicle approaching from the right or left at the rear of the vehicle is detected, both outside rear view mirror indicators will flash.

C Center Display

If a vehicle approaching from the right or left at the rear of the vehicle is detected, the RCTA icon (→P.196) for the detected

side will be displayed on the Center Display.

This illustration shows an example of a vehicle approaching from both sides of the vehicle.

D RCTA buzzer (RCTA function only)

If a vehicle approaching from the right or left at the rear of the vehicle is detected, a buzzer will sound. The buzzer also sounds for approximately 1 second immediately after the BSM main switch is operated to turn the system on.

■ Outside rear view mirror indicator visibility

In strong sunlight, the outside rear view mirror indicator may be difficult to see.

■ Hearing the RCTA buzzer

The RCTA buzzer may be difficult to hear over loud noises, such as if the audio system volume is high.

■ When “Blind Spot Monitor Unavailable” is shown on the multi-information display

Ice, snow, mud, etc., may be attached to the rear bumper around the sensors. (→P.192) The system should return to normal operation after removing the ice, snow, mud, etc. from the rear bumper. Additionally, the sensors may not operate normally when driving in extremely hot or cold environments.

■ When there is a malfunction in the Blind Spot Monitor

If a system malfunction is detected due to any of the following, a warning message will be displayed: (→P.303)

- A sensor is malfunctioning
- A sensor is dirty or covered with snow or a sticker
- The outside temperature is extremely high or low
- Sensor voltage is abnormal
- A sensor is misaligned

! WARNING

■ Handling the radar sensor

Blind Spot Monitor sensors are installed behind the left and right sides of the rear bumper respectively. Observe the following to ensure the Blind Spot Monitor can function correctly.

- Keep the sensors and the surrounding areas on the rear bumper clean at all times.
If a sensor or its surrounding area on the rear bumper is dirty or covered with snow, the Blind Spot Monitor may not operate and a warning message (→P.303) will be displayed. In this situation, clear off the dirt or snow and drive the vehicle with the operation conditions of the BSM function (→P.194) satisfied for approximately 10 minutes. If the warning message does not disappear, have the vehicle inspected by your Lexus dealer.

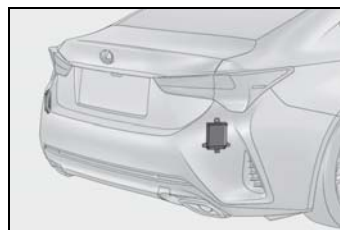

- Do not subject a sensor or its surrounding area on the rear bumper to a strong impact.
If a sensor is moved even slightly off position, the system may malfunction and vehicles may not be detected correctly.
In the following situations, have your vehicle inspected by your Lexus dealer.
 - A sensor or its surrounding area is subject to a strong impact.
 - If the surrounding area of a sensor is scratched or dented, or part of them has become disconnected.
- Do not disassemble the sensor.

**WARNING**

- Do not attach stickers to the sensor or surrounding area on the rear bumper.
- Do not modify the sensor or surrounding area on the rear bumper.
- Do not paint the rear bumper any color other than an official Lexus color.

■ Cautions regarding the use of the function

The driver is solely responsible for safe driving. Always drive safely, taking care to observe your surroundings.

The BSM function is a supplementary function which alerts the driver that a vehicle is in a blind spot of the outside rear view mirrors or is approaching rapidly from behind into a blind spot. Do not overly rely on the BSM function. As the function cannot judge if it is safe to change lanes, over reliance could lead to an accident resulting in death or serious injury.

As the system may not function correctly under certain conditions, the driver's own visual confirmation of safety is necessary.

The RCTA function is only a supplementary function which alerts the driver that a vehicle is approaching from the right or left at the rear of the vehicle. As the RCTA function may not function correctly under certain conditions, the driver's own visual confirmation of safety is necessary. Over reliance on this function may lead to an accident resulting death or serious injury.

BSM function

The BSM function uses radar sensors to detect the following vehicles traveling in adjacent lanes and advises the driver of the presence of such vehicles via the indicators on the outside rear view mirrors.

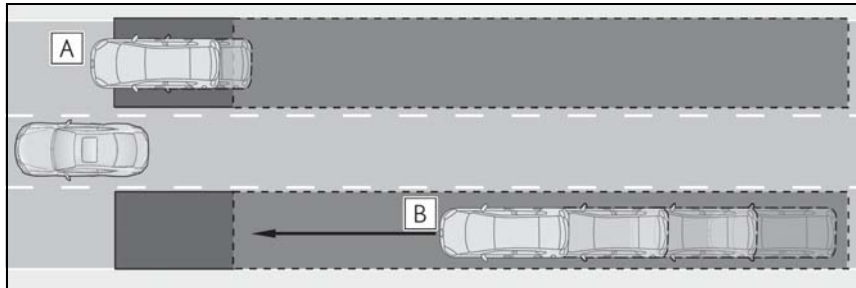

- A** Vehicles that are traveling in areas that are not visible using the outside rear view mirrors (the blind spots)
- B** Vehicles that are approaching rapidly from behind in areas that are not visible using the outside rear view mirrors (the blind spots)

BSM function detection areas

The areas that vehicles can be detected in are outlined below.

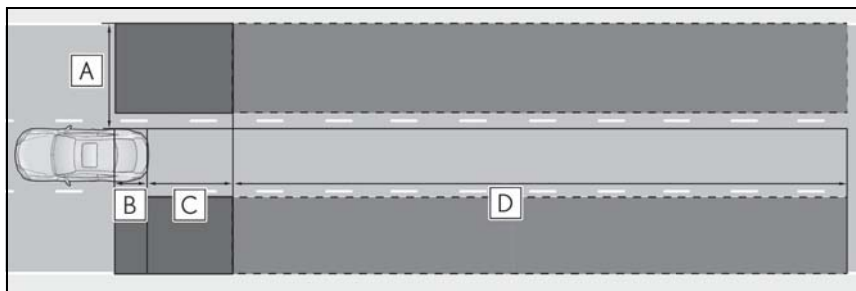

The range of each detection area is:

- A** Approximately 1.6 ft. (0.5 m) to 11.5 ft. (3.5 m) from either side of the vehicle ^{*1}
- B** Approximately 3.3 ft. (1 m) forward of the rear bumper
- C** Approximately 9.8 ft. (3 m) from the rear bumper
- D** Approximately 9.8 ft. (3 m) to 197 ft. (60 m) from the rear bumper ^{*2}

^{*1}: The area between the side of the vehicle and 1.6 ft. (0.5 m) from the side of the vehicle cannot be detected.

^{*2}: The greater the difference in speed between your vehicle and the detected vehicle is, the farther away the vehicle will be detected, causing the outside rear view mirror indicator to illuminate or flash.

■ The BSM function is operational when
The BSM function is operational when all of

the following conditions are met:

- The BSM main switch is on.
- The shift lever is in a position other than R.

- The vehicle speed is greater than approximately 10 mph (16 km/h).

■ The BSM function will detect a vehicle when

The BSM function will detect a vehicle present in the detection area in the following situations:

- A vehicle in an adjacent lane overtakes your vehicle.
- You overtake a vehicle in an adjacent lane slowly.
- Another vehicle enters the detection area when it changes lanes.

■ Conditions under which the BSM function will not detect a vehicle

The BSM function is not designed to detect the following types of vehicles and/or objects:

- Small motorcycles, bicycles, pedestrians, etc.*
- Vehicles traveling in the opposite direction
- Guardrails, walls, signs, parked vehicles and similar stationary objects*
- Following vehicles that are in the same lane*
- Vehicles traveling 2 lanes away from your vehicle*
- Vehicles which are being overtaken rapidly by your vehicle*

*: Depending on the conditions, detection of a vehicle and/or object may occur.

■ Conditions under which the BSM function may not function correctly

- The BSM function may not detect vehicles correctly in the following situations:
 - When the sensor is misaligned due to a strong impact to the sensor or its surrounding area
 - When mud, snow, ice, a sticker, etc. is covering the sensor or surrounding area on the rear bumper
 - When driving on a road surface that is wet with standing water during bad weather, such as heavy rain, snow, or fog

- When multiple vehicles are approaching with only a small gap between each vehicle
- When the distance between your vehicle and a following vehicle is short
- When there is a significant difference in speed between your vehicle and the vehicle that enters the detection area
- When the difference in speed between your vehicle and another vehicle is changing
- When a vehicle enters a detection area traveling at about the same speed as your vehicle
- As your vehicle starts from a stop, a vehicle remains in the detection area
- When driving up and down consecutive steep inclines, such as hills, dips in the road, etc.
- When driving on roads with sharp bends, consecutive curves, or uneven surfaces
- When vehicle lanes are wide, or when driving on the edge of a lane, and the vehicle in an adjacent lane is far away from your vehicle
- When a bicycle carrier or other accessory is installed to the rear of the vehicle
- When there is a significant difference in height between your vehicle and the vehicle that enters the detection area
- Immediately after the BSM main switch is turned on
- Instances of the BSM function unnecessarily detecting a vehicle and/or object may increase in the following situations:
 - When the sensor is misaligned due to a strong impact to the sensor or its surrounding area
 - When the distance between your vehicle and a guardrail, wall, etc. that enters the detection area is short
 - When driving up and down consecutive steep inclines, such as hills, dips in the road, etc.
 - When vehicle lanes are narrow, or when driving on the edge of a lane, and a vehicle traveling in a lane other than the adjacent lanes enters the detection area
 - When driving on roads with sharp bends, consecutive curves, or uneven surfaces
 - When the tires are slipping or spinning
 - When the distance between your vehicle and a following vehicle is short
 - When a bicycle carrier or other acces-

sory is installed to the rear of the vehicle

RCTA function

■ Operation of the RCTA function

The RCTA function uses radar sensors to detect vehicles approaching from the right or left at the rear of the vehicle and alerts the driver of the presence of such vehicles by flashing the outside rear view mirror indicators and sounding a buzzer.

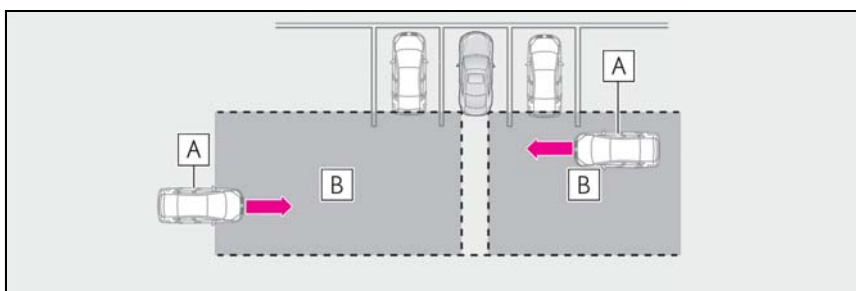

A Approaching vehicles

B Detection areas of approaching vehicles

■ RCTA icon display

When a vehicle approaching from the right or left at the rear of the vehicle is detected, the following will be displayed on the Center Display.

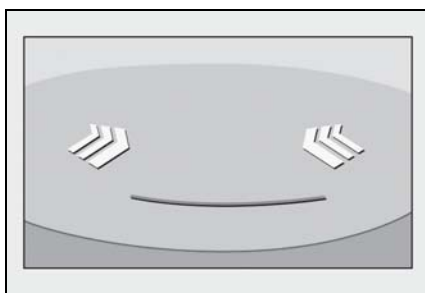

This illustration shows an example of a vehicle approaching from both sides of the vehicle.

 : The RCTA function is malfunctioning (→P.192)

RCTA function detection areas

The areas that vehicles can be detected in are outlined below.

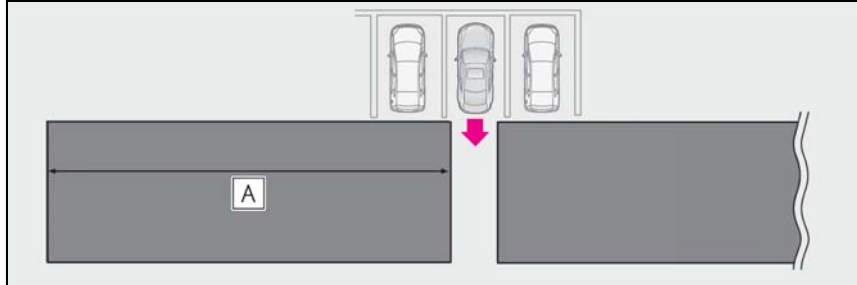

The buzzer can alert the driver of faster vehicles approaching from farther away.

Example:

Approaching vehicle	Speed	A Approximate alert distance
Fast	18 mph (28 km/h)	65 ft. (20 m)
Slow	5 mph (8 km/h)	18 ft. (5.5 m)

■ **The RCTA function is operational when**

The RCTA function operates when all of the following conditions are met:

- The BSM main switch is on.
- The shift lever is in R.
- The vehicle speed is less than approximately 5 mph (8 km/h).
- The approaching vehicle speed is between approximately 5 mph (8 km/h) and 18 mph (28 km/h).

■ **Conditions under which the RCTA function will not detect a vehicle**

The RCTA function is not designed to detect the following types of vehicles and/or objects:

- Vehicles approaching from directly behind
- Vehicles backing up in a parking space next to your vehicle
- Vehicles that the sensors cannot detect due to obstructions

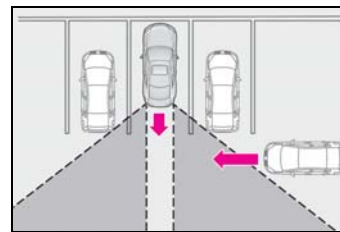

- Guardrails, walls, signs, parked vehicles and similar stationary objects*
- Small motorcycles, bicycles, pedestrians, etc.*
- Vehicles moving away from your vehicle
- Vehicles approaching from the parking spaces next to your vehicle*

*: Depending on the conditions, detection of a vehicle and/or object may occur.

■ **Conditions under which the RCTA function may not function correctly**

- The RCTA function may not detect vehicles correctly in the following situations:
 - When the sensor is misaligned due to a strong impact to the sensor or its surrounding area
 - When mud, snow, ice, a sticker, etc. is covering the sensor or surrounding area

- on the rear bumper
- When driving on a road surface that is wet with standing water during bad weather, such as heavy rain, snow, or fog
- When multiple vehicles are approaching with only a small gap between each vehicle
- When a vehicle is approaching at high speed
- When backing up on a slope with a sharp change in grade

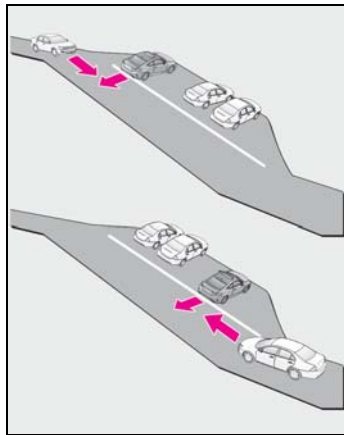

- When backing out of a shallow angle parking spot

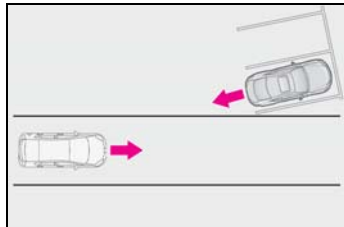

- Immediately after the BSM main switch is turned on
- Immediately after the engine is started with the BSM main switch on
- When the sensors cannot detect a vehicle due to obstructions

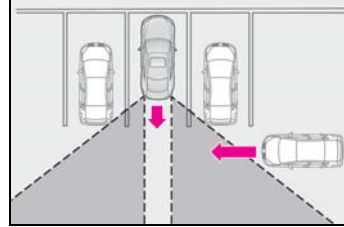

- Instances of the RCTA function unnecessarily detecting a vehicle and/or object may increase in the following situations:
 - When a vehicle passes by the side of your vehicle
 - When the parking space faces a street and vehicles are being driven on the street

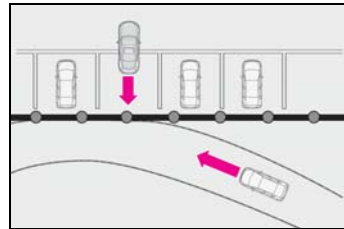

- When the distance between your vehicle and metal objects, such as a guardrail, wall, sign, or parked vehicle, which may reflect electrical waves toward the rear of the vehicle, is short

Driving mode select switch

The driving modes can be selected to suit driving condition.

Selecting a drive mode

- ▶ Vehicles without Adaptive Variable Suspension System

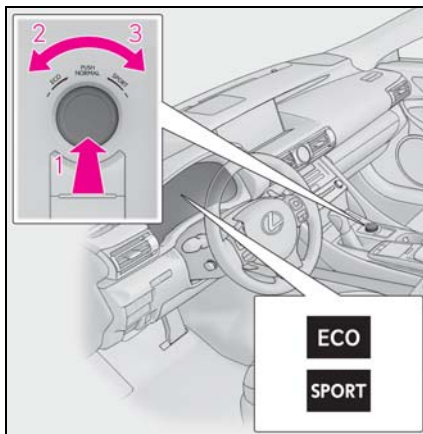

1 Normal mode

Provides an optimal balance of fuel economy, quietness, and dynamic performance. Suitable for city driving.

Press the switch to change the driving mode to normal mode when Eco drive mode or sport mode is selected.

2 Eco drive mode

Helps the driver accelerate in an eco-friendly manner and improve fuel economy through moderate throttle characteristics and by controlling the operation of the air conditioning system (heating/cooling).

When not in Eco drive mode, if the driving mode select switch is turned to the left, the Eco drive mode indicator will come on.

3 Sport mode

Controls the transmission and engine to provide quick, powerful acceleration. This mode also changes the steering feel, making it suitable for when agile driving response is desired, such as when driving on roads with many curves.

When not in sport mode, if the driving mode select switch is turned to the right, the "SPORT" indicator will come on.

- ▶ Vehicles with Adaptive Variable Suspension System

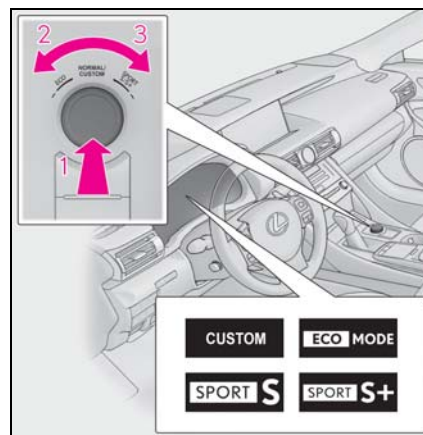

1 Normal mode/Custom mode

Normal mode and custom mode are selected by pressing the driving mode select switch. Each time the switch is pressed, the driving mode changes between normal mode and custom mode. When custom mode is selected, the "CUSTOM" indicator will be illuminated.

When Eco drive mode or sport mode is selected, pressing the switch changes the driving mode to normal mode.

- Normal mode

Provides an optimal balance of fuel economy, quietness, and dynamic performance. Suitable for city driving.

- Custom mode

Allows you to drive with the following functions set to your preferred settings.

Custom mode settings can only be changed on the drive mode customization display of the Center Display. (→P.212)

Function	Setting
Powertrain	Normal
	Power
	Eco
Chassis	Normal
	Sport
Air conditioning system	Normal
	Eco

2 Eco drive mode

Helps the driver accelerate in an eco-friendly manner and improve fuel economy through moderate throttle characteristics and by controlling the operation of the air conditioning system (heating/cooling).

When not in Eco drive mode, if the driving mode select switch is turned to the left, the Eco drive mode indicator will come on.

3 Sport mode

- SPORT S mode

Controls the transmission and engine to provide quick, powerful acceleration. Also, gear shift timing is controlled to suit sporty driving, making this mode is suitable for when agile driving response is desired, such as when driving on roads with many curves.

When not in SPORT S mode, if the driving mode select switch is turned to the right, the "SPORT S" indicator will come on.

- SPORT S+ mode

Provides earlier downshift timing than SPORT S mode in order to maintain a high engine speed and provides faster gear changes. This mode also changes the

steering feel, suspension control and VDIM control, making it suitable for powerful sporty driving.

When in SPORT S mode, if the driving mode select switch is turned to the right, the "SPORT S+" indicator will come on.

■ **Operation of the air conditioning system in Eco drive mode**

Eco drive mode controls the heating/cooling operations and fan speed of the air conditioning system to enhance fuel efficiency (→P.215). To improve air conditioning performance, adjust the fan speed or turn off Eco drive mode.

■ **Automatic deactivation of sport mode and custom mode**

If the engine switch is turned off after driving in sport mode or custom mode, the drive mode will be changed to normal mode.

■ **Driving mode pop-up display (vehicles with a 10.3-inch display)**

When the driving mode is changed, the selected driving mode will be temporarily displayed on the side display. (→P.212)

Driving assist systems

To keep driving safety and performance, the following systems operate automatically in response to various driving situations. Be aware, however, that these systems are supplementary and should not be relied upon too heavily when operating the vehicle.

Summary of the driving assist systems

■ ABS (Anti-lock Brake System)

Helps to prevent wheel lock when the brakes are applied suddenly, or if the brakes are applied while driving on a slippery road surface

■ Brake assist

Generates an increased level of braking force after the brake pedal is depressed when the system detects a panic stop situation

■ VSC (Vehicle Stability Control)

Helps the driver to control skidding when swerving suddenly or turning on slippery road surfaces

■ Enhanced VSC (Enhanced Vehicle Stability Control)

Provides cooperative control of the ABS, TRAC, VSC and EPS. Helps to maintain directional stability when swerving on slippery road surfaces by controlling steering performance.

■ TRAC (Traction Control)

Helps to maintain drive power and prevent the drive wheels from spinning when starting the vehicle or accelerating on slippery roads

■ Hill-start assist control

Helps to reduce the backward movement of the vehicle when starting on an uphill

■ VGRS (Variable Gear Ratio Steering) (if equipped)

Adjusts the front wheel turning angle in accordance with the vehicle speed and steering wheel movement

■ DRS (Dynamic Rear Steering) (if equipped)

Contributes to the turning characteristics and responsiveness of the vehicle by adjusting the rear wheel angle of the vehicle in accordance with steering wheel movement.

■ EPS (Electric Power Steering)

Employs an electric motor to reduce the amount of effort needed to turn the steering wheel

■ Adaptive Variable Suspension System (if equipped)

By independently controlling the damping force of the shock absorbers for each of the 4 wheels according to the road and driving conditions, this system combines riding comfort with superior vehicle stability, and helps good vehicle posture.

■ **LDH (Lexus Dynamic Handling system) (if equipped)**

Provides integrated control of the VGRS, DRS and EPS. Contributes to turning characteristics at low speeds, responsiveness at medium speeds and safety at high speeds by controlling the steering angle of the front and rear wheels in accordance with the steering wheel operation and vehicle speed.

■ **VDIM (Vehicle Dynamics Integrated Management)**

Provides integrated control of the ABS, brake assist, TRAC, VSC, hill-start assist control, EPS and VGRS systems

Helps to maintain vehicle stability when swerving on slippery road surfaces by controlling the brakes, engine output, steering assist, and steering ratio

■ **When the TRAC/VSC systems are operating**

The slip indicator light will flash while the TRAC/VSC systems are operating.

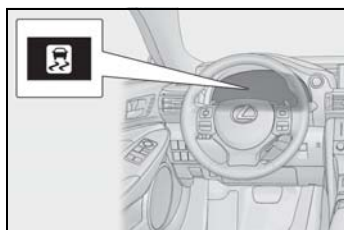

■ **Disabling the TRAC system**

If the vehicle gets stuck in mud, dirt or snow, the TRAC system may reduce power from the engine to the wheels. Pressing the  switch to turn the system off may make it easier for you to rock the vehicle in order to free it.

To turn the TRAC system off, quickly press

and release the  switch.

The "Traction Control Turned Off" will be shown on the multi-information display.

Press the  switch again to turn the system back on.

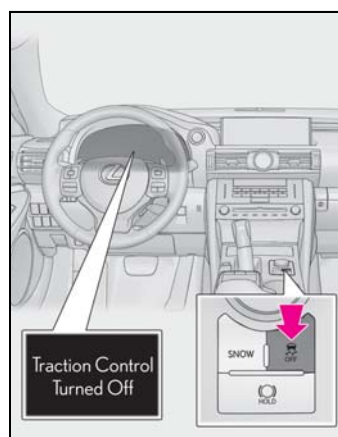

■ **Turning off both TRAC and VSC systems**

To turn the TRAC and VSC systems off, press and hold the  switch for more than 3 seconds while the vehicle is stopped.

The VSC OFF indicator light will come on and the "Traction Control Turned Off" will be shown on the multi-information display.*

Press the  switch again to turn the systems back on.

*: On vehicles with PCS (Pre-Collision System), pre-collision brake assist, pre-collision braking, and steering control (performed through cooperative control of PCS and LDH) (if equipped) will also be disabled. The Pre-Collision System warning light will come on and a message will be displayed on the multi-information display. (→P.168)

■ **When the message is displayed on the multi-information display showing that TRAC has been disabled even if the**



switch has not been pressed

TRAC is temporary deactivated. If the information continues to show, contact your Lexus dealer.

■ **Operating conditions of hill-start assist control**

When the following four conditions are met, the hill-start assist control will operate:

- The shift lever is in a position other than P or N (when starting off forward/backward on an upward incline).
- The vehicle is stopped.
- The accelerator pedal is not depressed.
- The parking brake is not engaged.
- Engine switch is turned to IGNITION ON mode

■ **Automatic system cancelation of hill-start assist control**

The hill-start assist control will turn off in any of the following situations:

- The shift lever is moved to P or N.
- The accelerator pedal is depressed.
- The parking brake is engaged.
- 2 seconds at maximum elapsed after the brake pedal is released
- Engine switch is turned to off

■ **VGRS is disabled when**

VGRS may stop operating in the following situations.

In this event, the steering wheel may move from its straight forward position, but it will return when the system restarts.

- When the steering wheel is operated for an extended period of time while the vehicle is stopped or is moving very slowly (on vehicles with LDH, DRS is disabled together with VGRS)
- When the steering wheel has been held fully to the left or right

The center position of the steering wheel may change when VGRS is disabled. How-

ever, the position will return to normal after VGRS is reactivated.

■ **When the battery is disconnected (vehicles with VGRS)**

The steering wheel may move from its straight forward position, but this will be corrected automatically when driving.

■ **Sounds and vibrations caused by the ABS, brake assist, VSC, TRAC, hill-start assist control and VGRS systems**

- A sound may be heard from the engine compartment when the brake pedal is depressed repeatedly, when the engine is started or just after the vehicle begins to move. This sound does not indicate that a malfunction has occurred in any of these systems.
- Any of the following conditions may occur when the above systems are operating. None of these indicates that a malfunction has occurred.
 - Vibrations may be felt through the vehicle body and steering.
 - A motor sound may be heard also after the vehicle comes to a stop.
 - The brake pedal may pulsate slightly after the ABS is activated.
 - The brake pedal may move down slightly after the ABS is activated.

■ **EPS, VGRS and DRS operation sound**

When the steering wheel is operated, a motor sound (whirring sound) may be heard. This does not indicate a malfunction.

■ **Automatic reactivation of TRAC/VSC systems**

After turning the TRAC and VSC systems off, the systems will be automatically re-enabled in the following situations:

- When the engine switch is turned off
- If only the TRAC system is turned off, the TRAC will turn on when vehicle speed increases

If both the TRAC and VSC systems are turned off, automatic re-enabling will not occur when vehicle speed increases.

■ **Reduced effectiveness of the EPS system**

The effectiveness of the EPS system is reduced to prevent the system from overheating when there is frequent steering input over an extended period of time. The steering wheel may feel heavy as a result. Should this occur, refrain from excessive steering input or stop the vehicle and turn the engine off. The EPS system should return to normal within 10 minutes.

 **WARNING**

■ **The ABS does not operate effectively when**

- The limits of tire gripping performance have been exceeded (such as excessively worn tires on a snow covered road).
- The vehicle hydroplanes while driving at high speed on wet or slick roads.

■ **Stopping distance when the ABS is operating may exceed that of normal conditions**

The ABS is not designed to shorten the vehicle's stopping distance. Always maintain a safe distance from the vehicle in front of you, especially in the following situations:

- When driving on dirt, gravel or snow-covered roads
- When driving with tire chains
- When driving over bumps in the road
- When driving over roads with potholes or uneven surfaces

■ **TRAC/VSC may not operate effectively when**

Directional control and power may not be achievable while driving on slippery road surfaces, even if the TRAC/VSC system is operating. Drive the vehicle carefully in conditions where stability and power may be lost.

■ **Hill-start assist control does not operate effectively when**

- Do not overly rely on hill-start assist control. Hill-start assist control may not operate effectively on steep inclines and roads covered with ice.
- Unlike the parking brake, hill-start assist control is not intended to hold the vehicle stationary for an extended period of time. Do not attempt to use hill-start assist control to hold the vehicle on an incline, as doing so may lead to an accident.

■ **When the TRAC/VSC is activated**

The slip indicator light flashes. Always drive carefully. Reckless driving may cause an accident. Exercise particular care when the indicator light flashes.

■ **When the TRAC/VSC systems are turned off**

Be especially careful and drive at a speed appropriate to the road conditions. As these are the systems to help ensure vehicle stability and driving force, do not turn the TRAC/VSC systems off unless necessary.

■ **Replacing tires**

Make sure that all tires are of the specified size, brand, tread pattern and total load capacity. In addition, make sure that the tires are inflated to the recommended tire inflation pressure level.

The ABS, TRAC and VSC systems will not function correctly if different tires are installed on the vehicle. Contact your Lexus dealer for further information when replacing tires or wheels.

■ **Handling of tires and the suspension**

Using tires with any kind of problem or modifying the suspension will affect the driving assist systems, and may cause a system to malfunction.

Winter driving tips

Carry out the necessary preparations and inspections before driving the vehicle in winter. Always drive the vehicle in a manner appropriate to the prevailing weather conditions.

Preparation for winter

- Use fluids that are appropriate to the prevailing outside temperatures.
 - Engine oil
 - Engine coolant
 - Washer fluid
- Have a service technician inspect the condition of the battery.
- Have the vehicle fitted with four snow tires or purchase a set of tire chains for the rear tires.*

Ensure that all tires are the specified size and brand, and that chains match the size of the tires.

* : Tire chains cannot be mounted on vehicles with front and rear tires of differing sizes and vehicles with LDH and 19-inch tires.

⚠ WARNING

■ Driving with snow tires

Observe the following precautions to reduce the risk of accidents. Failure to do so may result in a loss of vehicle control and cause death or serious injury.

- Use tires of the specified size.
- Maintain the recommended level of air pressure.

● Do not drive in excess of 75 mph (120 km/h), regardless of the type of snow tires being used.

● Use snow tires on all, not just some wheels.

■ Driving with tire chains

Observe the following precautions to reduce the risk of accidents. Failure to do so may result in the vehicle being unable to be driven safely, and may cause death or serious injury.

● Do not drive in excess of the speed limit specified for the tire chains being used, or 30 mph (50 km/h), whichever is lower.

● Avoid driving on bumpy road surfaces or over potholes.

● Avoid sudden acceleration, abrupt steering, sudden braking and shifting operations that cause sudden engine braking.

● Slow down sufficiently before entering a curve to ensure that vehicle control is maintained.

● Do not use LDA (Lane Departure Alert with steering control) system.

⚠ NOTICE

■ Repairing or replacing snow tires

Request repairs or replacement of snow tires from Lexus dealers or legitimate tire retailers. This is because the removal and attachment of snow tires affects the operation of the tire pressure warning valves and transmitters.

Before driving the vehicle

Perform the following according to the driving conditions:

- Do not try to forcibly open a window or move a wiper that is frozen. Pour

warm water over the frozen area to melt the ice. Wipe away the water immediately to prevent it from freezing.

- To ensure proper operation of the climate control system fan, remove any snow that has accumulated on the air inlet vents in front of the windshield.
- Check for and remove any excess ice or snow that may have accumulated on the exterior lights, vehicle's roof, chassis, around the tires or on the brakes.
- Remove any snow or mud from the bottom of your shoes before getting in the vehicle.

When driving the vehicle

Accelerate the vehicle slowly, keep a safe distance between you and the vehicle ahead, and drive at a reduced speed suitable to road conditions.

When parking the vehicle

- Park the vehicle and move the shift lever to P without setting the parking brake. The parking brake may freeze up, preventing it from being released. If the vehicle is parked without setting the parking brake, make sure to block the wheels. Failure to do so may be dangerous because it may cause the vehicle to move unexpectedly, possibly leading to an accident.

When the parking brake is in automatic

mode, release the parking brake after shifting the shift lever to P. (→P.137)

- If the vehicle is parked without setting the parking brake, confirm that the shift lever cannot be moved out of P*.

*: The shift lever will be locked if it is attempted to be shifted from P to any other position without depressing the brake pedal. If the shift lever can be shifted from P, there may be a problem with the shift lock system. Have the vehicle inspected by your Lexus dealer immediately.

Selecting tire chains

- ▶ Vehicles with front and rear tires of the same size except for vehicles with LDH and 19-inch tires

Use the correct tire chain size when mounting the tire chains.

Chain size is regulated for each tire size.

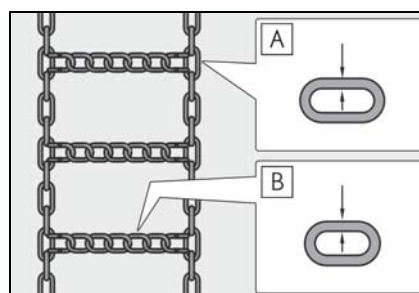

A Side chain (0.12 in. [3 mm] in diameter)

B Cross chain (0.16 in. [4 mm] in diameter)

- ▶ Vehicles with front and rear tires of differing sizes and vehicles with LDH and 19-inch tires

Tire chains cannot be mounted.

Snow tires should be used instead.

Regulations on the use of tire chains

Regulations regarding the use of tire chains vary depending on location and type of road. Always check local regulations before installing chains.

■ Tire chain installation

Observe the following precautions when installing and removing chains:

- Install and remove tire chains in a safe location.
- Install tire chains on the rear tires. Do not install tire chains on the front tires.
- Install tire chains on rear tires as tightly as possible. Retighten chains after driving 1/4—1/2 mile (0.5—1.0 km).
- Install tire chains following the instructions provided with the tire chains.



NOTICE

■ Fitting tire chains

The tire pressure warning valves and transmitters may not function correctly when tire chains are fitted.

Interior features

5

- 5-1. Remote Touch/Display**
 - Remote Touch..... 210
 - Center Display..... 212
- 5-2. Using the air conditioning system**
 - Automatic air conditioning system
..... 215
 - Heated steering wheel/seat heaters/seat ventilators..... 223
- 5-3. Using the interior lights**
 - Interior lights list..... 225
- 5-4. Using the storage features**
 - List of storage features..... 227
 - Trunk features..... 229
- 5-5. Using the other interior features**
 - Other interior features 230
 - Garage door opener..... 232
 - Compass..... 237

Remote Touch

The Remote Touch can be used to operate the Center Display.

For details on the Remote touch, refer to “NAVIGATION AND MULTIMEDIA SYSTEM OWNER’S MANUAL”.

Remote Touch operation

■ Switches

► Vehicles with a 10.3-inch display

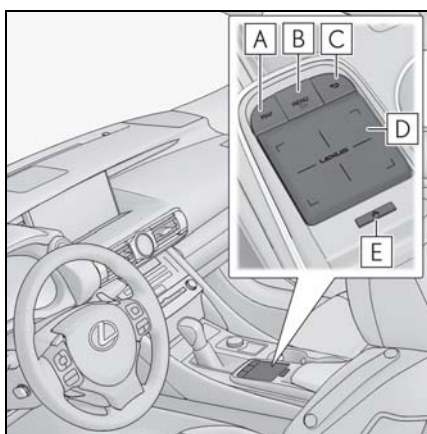

A “MAP” button

Press this button to display the vehicle’s current position.

B “MENU” button

Press this button to display the menu screen.

C Back button

Press this button to display the previous screen.

D Touchpad

Slide your finger on the touchpad and move the pointer to select a function, letter

and screen button.

Press the touchpad to enter the selected function, letter or screen button. Certain finger movements on the touchpad can perform functions, such as changing map scalings and scrolling list screens.

E Sub function button

When  is displayed on the screen, a function screen assigned to the screen can be displayed.

► Vehicles with a 7-inch display

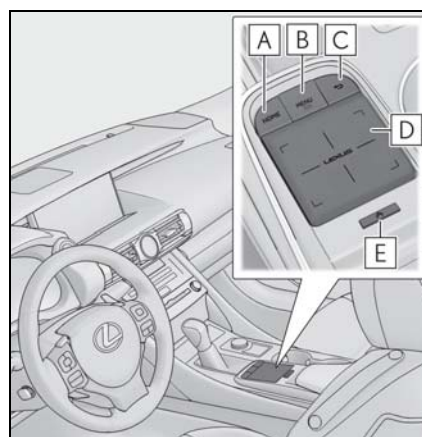

A “HOME” button

Press this button to display the “Home” screen.

B “MENU” button

Press this button to display the menu screen.

C Back button

Press this button to display the previous screen.

D Touchpad

Slide your finger on the touchpad and move the pointer to select a function, letter and screen button.

Press the touchpad to enter the selected function, letter or screen button. Certain

finger movements on the touchpad can perform functions, such as scrolling list screens.

E Sub function button

When  is displayed on the screen, a function screen assigned to the screen can be displayed.

■ Using the touchpad

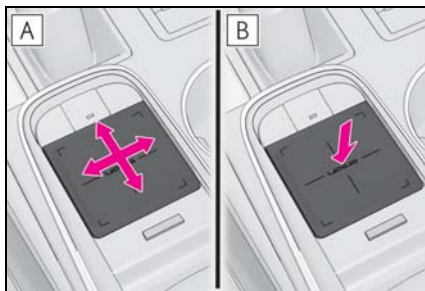

A Select: Touch the touchpad to select the desired button on the screen.

B Enter: Buttons on the screen can be selected by either depressing or double tapping the touchpad. Once a button has been selected, the screen will change.

■ Touch operation

Operations are performed by touching the touchpad with your finger.

● Trace

Trace the pad surface while maintaining contact with the touchpad. Moving the cursor and the pointer.

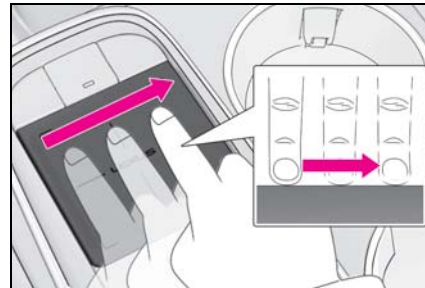

● Double tap

Tap the touchpad twice, quickly. Select the button on the screen.

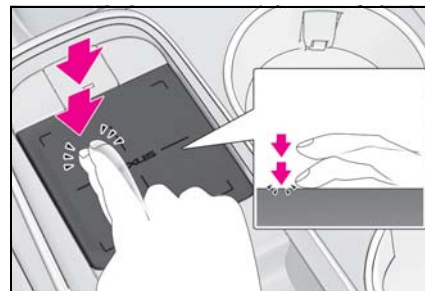

● Flick

Quick and short movement along the touchpad with your finger. Move the list screen.

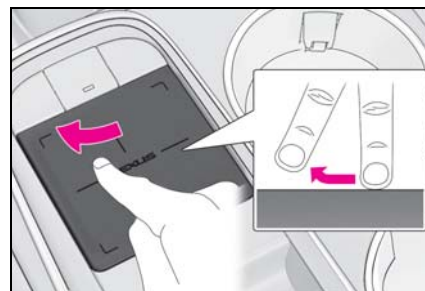

● Pinch in/Pinch out

Slide fingers toward each other or apart on the touchpad. Change the scale of the map.

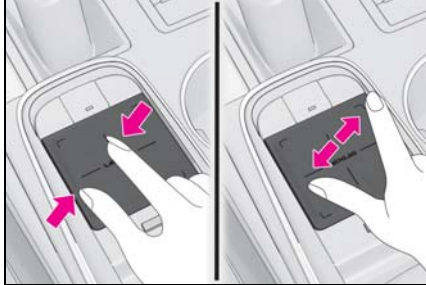

 NOTICE

■ **To prevent damage to the Remote Touch**

Observe the following precautions. Failure to do so may cause damage to the Remote Touch.

- Do not allow food, liquid, stickers or lit cigarettes to contact the Remote Touch.
- Do not subject the Remote Touch to excessive pressure or strong impact.
- Do not push the touchpad with a strong force or use a sharp pointed object to operate the pad.

Center Display

Center Display overview

■ Menu screen

Press the "MENU" button on the Remote Touch to display the menu screen.



The displays shown in the illustrations are used for example only and may differ from the actual vehicle.







▶ Vehicles with a 10.3-inch display





▶ Vehicles with a 7-inch display



Switch	Function
	Select to display the "Destination" screen. *1
	Select to display the audio control screen. *1

Switch	Function
	Select to display the hands-free control screen. ^{*1}
	Select to display the "Apps" screen. ^{*1,2}
 /  / 	When an Apple CarPlay/Android Auto connection is established and this button displays "Apple CarPlay"/"Android Auto", select to display the Apple CarPlay/Android Auto screen. ^{*1,2}
	Select to display the information screen. ^{*1} (→P.79)

Switch	Function
	Select to display the setup screen. ^{*1}
	Select to display the air conditioning control screen. (→P.216)
	Select to adjust the contrast and brightness of the screens, turn the screen off, etc. ^{*1,2}

^{*1}: Refer to the "NAVIGATION AND MULTIMEDIA SYSTEM OWNER'S MANUAL".

^{*2}: This function is not available on some models.

■ **Split-screen display (Vehicles with a 10.3-inch display)**

Different information can be displayed on the left and right sides of the screen. For example, air conditioning system screen can be displayed and operated while the fuel consumption information screen is being displayed. The large screen on the left of the display is called the main display, and the small screen to the right is called the side display.

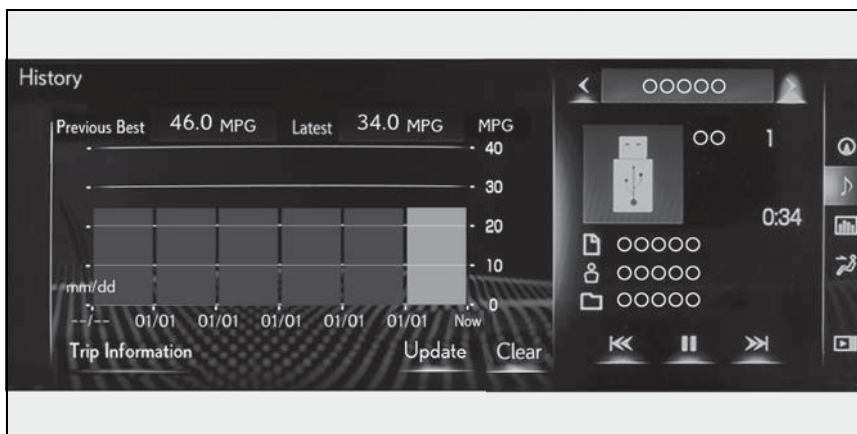

■ **Main display (Vehicles with a 10.3-inch display)**

For details about the functions and operation of the main display, refer to the respective section and "NAVIGATION AND MULTIMEDIA SYSTEM OWNER'S MANUAL".

■ **Side display (Vehicles with a 10.3-inch display)**

The following functions can be displayed and operated on the side display.

Select **<** or **>** to display the desired screen.

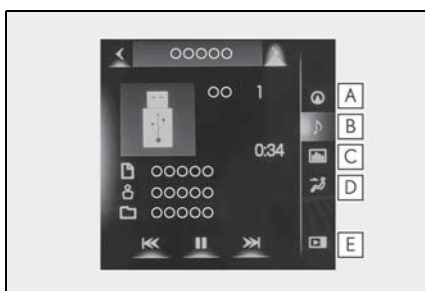

- A** Navigation system*
- B** Audio*
- C** Vehicle information (→P.80)

- D** Air conditioning system (→P.218)

- E** Show/hide the side display*

*: Refer to the "NAVIGATION AND MULTIMEDIA SYSTEM OWNER'S MANUAL".

■ **Screen display during low temperatures**

When the ambient temperature is extremely low, screen response may be delayed even if the Remote Touch is operated.

Automatic air conditioning system

Air outlets and fan speed are automatically adjusted according to the temperature setting.

Press the "MENU" button on the Remote Touch, then select "Climate" to display the air conditioning control screen. (→P.212)

The air conditioning system can be displayed and operated on the side display.

Air conditioning controls

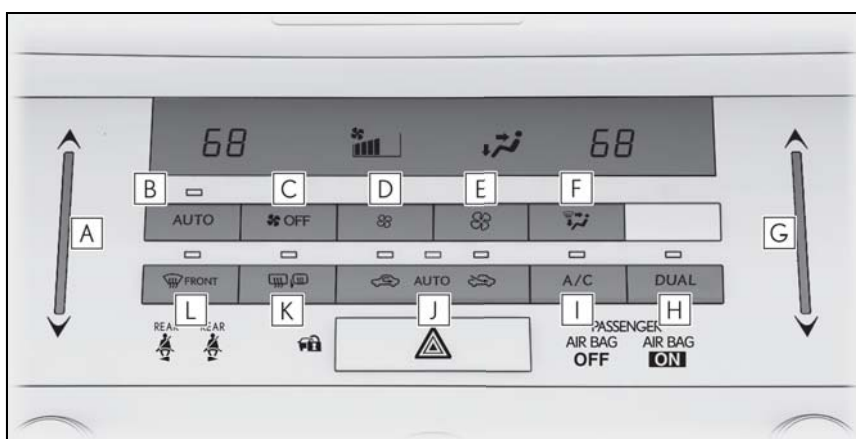

- A** Left-hand side temperature control switch
- B** Automatic mode switch
- C** Off switch
- D** Fan speed down switch
- E** Fan speed up switch
- F** Air flow mode switch
- G** Right-hand side temperature control switch
- H** DUAL mode switch
- I** A/C switch
- J** Outside/recirculated air mode switch
- K** Rear window defogger and outside rear view mirror defoggers switch
- L** Windshield defogger switch

■ **Adjusting the temperature setting**

To adjust the temperature setting, touch and slide your finger up or down on the sensor.

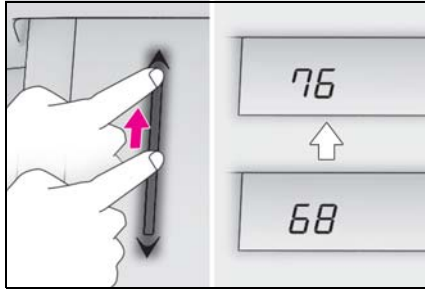

The temperature setting can also be adjusted by touching on the sensor.

When the temperature setting is changed, a buzzer sounds.

If **A/C** is not pressed, the system will blow ambient temperature air or heated air.

■ **Fan speed setting**

Press **⊞** to increase the fan speed.

Press **⊞** to decrease the fan speed.

■ **Change the airflow mode**

To change the airflow, press **↻**.

The air outlets used are switched each time the button is pressed.

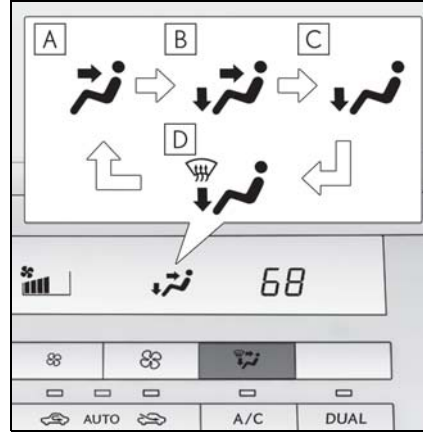

- A** Air flows to the upper body.
- B** Air flows to the upper body and feet.
- C** Air flows to the feet.
- D** Air flows to the feet and the windshield defogger operates.

■ **Other functions**

- Switching between outside air and recirculated air modes (→P.218)
- Defogging the windshield (→P.219)
- Defogging the rear window and outside rear view mirrors (→P.219)

Air conditioning control screen

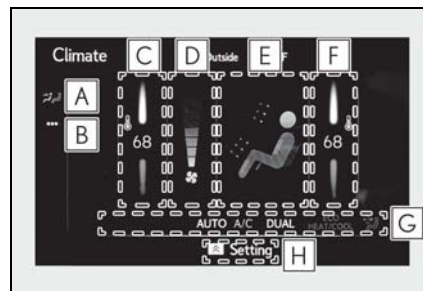

- A** Display the air conditioning control screen

- B** Display the option control screen (→P.217)
- C** Adjust the left-hand side temperature setting
- D** Adjust the fan speed setting
- E** Select the air flow mode
- F** Adjust the right-hand side temperature setting
- G** Function on/off indicators

When the function is on, the indicator illuminates on the control screen.

- H** Display the sub function menu (→P.217)

Using the Remote Touch, select the button on the screen and activate it by pressing on or double tapping the Remote Touch Pad.

■ **Option control screen**

Select **...** on the air conditioning control screen to display the option control screen. The functions can be switched on and off.

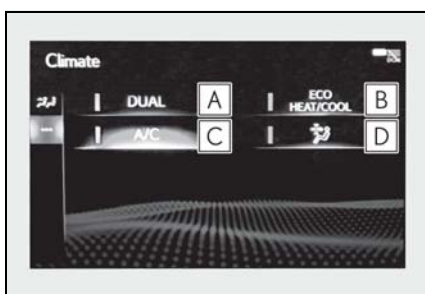

- A** Adjusting the temperature for driver and passenger seats separately ("DUAL" mode) (→P.218)
- B** Select to set eco mode on/off (→P.220)
- C** Set cooling and dehumidification function on/off

If the "A/C" indicator is turned off, the system will blow ambient temperature air or heated air.

- D** Removing pollen from the air (Micro dust and pollen filter) (→P.219)

■ **Sub function menu**

When the sub function button on the Remote Touch is pressed, the following functions can be switched on and off.



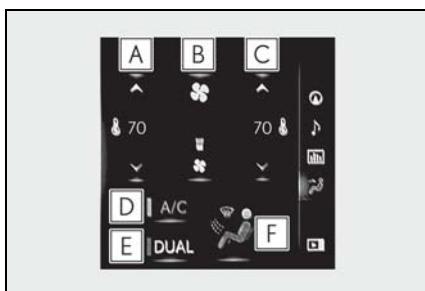

- A** Set automatic mode on/off (→P.218)
 - B** Turn the fan off
 - C** Set cooling and dehumidification function on/off
- If the "A/C" indicator is turned off, the system will blow ambient temperature air or heated air.
- D** Adjust the temperature for driver and passenger seats separately ("DUAL" mode) (→P.218)
 - E** Select to set eco mode on/off (→P.220)

■ Side display (vehicle with a navigation system)



- A** Adjust the left-hand side temperature setting
 - B** Adjust the fan speed setting
 - C** Adjust the right-hand side temperature setting
 - D** Set cooling and dehumidification function on/off
- If the "A/C" indicator is turned off, the system will blow ambient temperature air or heated air.
- E** Adjust the temperature for the driver's and front passenger's seats separately ("DUAL" mode) (→P.218)
 - F** Select the air flow mode

Using automatic mode

- 1** Press , or select "AUTO" on the air conditioning control screen.
- 2** Press  to switch to automatic air intake mode.
The air conditioning system automatically switches between outside air and recirculated air modes.
- 3** Adjust the temperature setting.

- 4** To stop the operation, press  or select "Off" on the sub function menu.

■ Automatic mode indicator

If the fan speed setting or air flow modes are operated, the automatic mode indicator goes off. However, automatic mode for functions other than that operated is maintained.

■ Adjusting the temperature for driver and passenger seats separately ("DUAL" mode)

To turn on the "DUAL" mode, perform any of the following procedures:

- Press .
- Select "DUAL" on the air conditioning control screen.
- Adjust the passenger's side temperature setting.



The indicator comes on when the "DUAL" mode is on.

While in "DUAL" mode, the temperature of the rear air outlets is set at the right-hand side temperature setting.

Other functions

■ Switching between outside air and recirculated air modes

Press .

The mode switches among  (recirculated air mode), automatic and  (outside air mode) modes each time the button is pressed.

When the system is switched to automatic mode, the air conditioning system operates

automatically.

The indicator above the selected button comes on.

■ Micro dust and pollen filter

Pollen is removed from the air and the air flows to the upper part of the body.

Select  on the option control screen.

When the micro dust and pollen filter is on,  is displayed on the air conditioning control screen.

In order to prevent the windshield from fogging up when the outside air is cold, the dehumidification function may operate.

Pollen is filtered even if the micro dust and pollen filter is turned off.

■ Defogging the windshield

Defoggers are used to defog the windshield and side windows.

Press .

Set the outside/recirculated air mode button to outside air mode if the recirculated air mode is used. (It may switch automatically.)

To defog the windshield and the side windows early, turn the air flow and temperature up.

To return to the previous mode, press  again when the windshield is defogged.

■ Defogging the rear window and outside rear view mirrors

Defoggers are used to defog the rear window, and to remove raindrops, dew and frost from the outside rear view mirrors.

Press .

The defoggers will automatically turn off after a period of time.

■ Windshield wiper de-icer (if equipped)

This feature is used to prevent ice from building up on the windshield and wiper blades.

Turns on/off.

The indicator comes on when the windshield wiper de-icer is on.

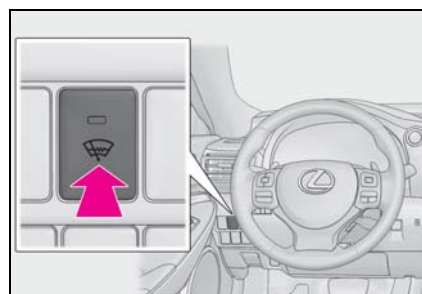

The windshield de-icer will automatically turn off after a period of time.

■ Registering air conditioning settings to electronic keys (vehicles with driving position memory)

- Unlocking the vehicle using an electronic key and turning the engine switch to IGNITION ON mode will recall that key's registered air conditioning settings.
- When the engine switch is turned off, the current air conditioning settings will automatically be registered to the electronic key that was used to unlock the vehicle.
- The system may not operate correctly if more than one electronic key is in the vicinity or if the smart access system with push-button start is used to unlock a passenger door.
- The doors that can recall the air conditioning setting* when unlocked using the smart access system with push-button start can be changed. For details, contact

your Lexus dealer.

- * The doors that can recall the driving position memory are changed at the same time.

■ Using automatic mode

Fan speed is adjusted automatically according to the temperature setting and the ambient conditions.

Therefore, the fan may stop for a while until warm or cool air is ready to flow immediately after  is pressed or "AUTO" is selected.

■ Using the voice command system

Air conditioning system can be operated using voice commands. For details, refer to the "NAVIGATION AND MULTIMEDIA SYSTEM OWNER'S MANUAL".

■ Fogging up of the windows

The windows will easily fog up when the humidity in the vehicle is high. Turning  ("A/C") on will dehumidify the air from the outlets and defog the windshield effectively.

- If you turn  ("A/C") off, the windows may fog up more easily.
- The windows may fog up if the recirculated air mode is used.

■ When driving on dusty roads

Close all windows. If dust thrown up by the vehicle is still drawn into the vehicle after closing the windows, it is recommended that the air intake mode be set to outside air mode and the fan speed to any setting except off.

■ Outside/recirculated air mode

- Setting to the recirculated air mode temporarily is recommended in preventing dirty air from entering the vehicle interior and helping to cool the vehicle when the outside air temperature is high.
- Outside/recirculated air mode may automatically switch depending on the temperature setting or the inside temperature.

■ When the outside temperature exceeds 75°F (24°C) and the air conditioning system is on

- In order to reduce the air conditioning power consumption, the air conditioning system may switch to recirculated air mode automatically. This may also reduce fuel consumption.
- Recirculated air mode is selected as a default mode when the engine switch is turned to IGNITION ON mode.
- It is possible to switch to outside air mode at any time by pressing



■ Automatic mode for air intake control

In automatic mode, the system detects exhaust gas and other pollutants and automatically switches between outside air and recirculated air modes.

When the dehumidification function is off, and the fan is operating, turning automatic mode on will activate the dehumidification function.

■ Operation of the air conditioning system in Eco drive mode

In Eco drive mode, the air conditioning system is controlled as follows to prioritize fuel efficiency:

- Engine speed and compressor operation controlled to restrict heating/cooling capacity
- Fan speed restricted when automatic mode is selected

To improve air conditioning performance, perform the following operations:

- Adjust the fan speed
- Turn off Eco drive mode

■ When the outside temperature falls to nearly 32°F (0°C)

The dehumidification function may not operate even when  is pressed or "A/C" is selected.

■ Ventilation and air conditioning odors

- To let fresh air in, set the air conditioning system to the outside air mode.

- During use, various odors from inside and outside the vehicle may enter into and accumulate in the air conditioning system. This may then cause odor to be emitted from the vents.
- To reduce potential odors from occurring:
 - It is recommended that the air conditioning system be set to outside air mode prior to turning the vehicle off.
 - The start timing of the blower may be delayed for a short period of time immediately after the air conditioning system is started in automatic mode.

■ **Air conditioning filter**

→P.275

■ **Air conditioning system refrigerant**

- A label regarding the refrigerant of the air conditioning system is attached to the hood at the location shown in the following illustration.

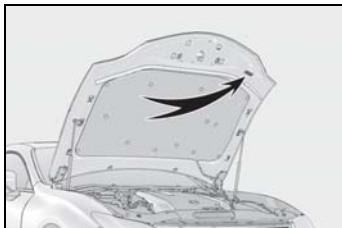

- The meaning of each symbol on the label are as follows:

	Caution
	Air conditioning system
	Air conditioning system lubricant type
	Requires registered technician to service air conditioning system
	Flammable refrigerant

■ **Customization**

Some functions can be customized. (→P.351)

WARNING

■ **To prevent the windshield from fogging up**

- Do not use  during cool air operation in extremely humid weather. The difference between the temperature of the outside air and that of the windshield can cause the outer surface of the windshield to fog up, blocking your vision.
- Do not place anything on the instrument panel which may cover the air outlets. Otherwise, air flow may be obstructed, preventing the windshield defoggers from defogging.

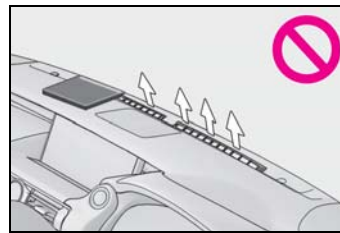

■ **To prevent burns**

- Do not touch the rear view mirror surfaces when the outside rear view mirror defoggers are on.
- Do not touch the glass at lower part of the windshield or to the side of the front pillars when the windshield wiper de-icer is on.

NOTICE

■ **To prevent battery discharge**

Do not leave the air conditioning system on longer than necessary when the engine is stopped.

 NOTICE

■ When repairing/replacing parts of the air conditioning system

Have repair/replacement performed by your Lexus dealer.

When a part of the air conditioning system, such as the evaporator, is to be replaced, it must be replaced with a new one.

Air outlets

■ Location of air outlets

The air outlets and air volume changes according to the selected airflow mode.

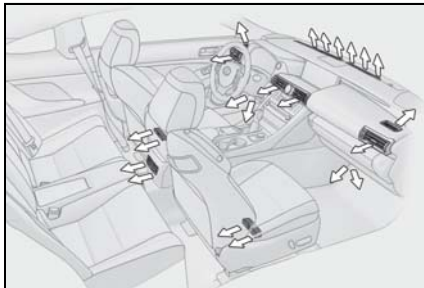

■ Adjusting the position of and opening and closing the air outlets

► Front

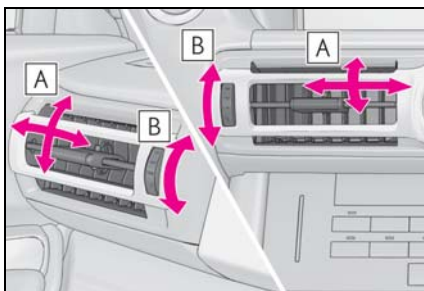

A Direct air flow to the left or right, up or down

B Turn the knob to open or close the

vent

► Rear

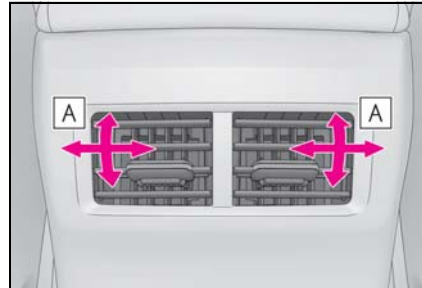

A Direct air flow to the left or right, up or down

To close the vent, move the knob to the most outside position.

Heated steering wheel^{*} / seat heaters^{*} / seat ventilators^{*}

*: If equipped

Heated steering wheel and seat heaters heat the side grips of the steering wheel and seats, respectively. Seat ventilators maintain good ventilation using a fan built into the seat.

⚠ WARNING

■ To prevent minor burn injuries

Care should be taken if anyone in the following categories comes in contact with the steering wheel or seats when the heater is on:

- Babies, small children, the elderly, the sick and the physically challenged
- Persons with sensitive skin
- Persons who are fatigued
- Persons who have taken alcohol or drugs that induce sleep (sleeping drugs, cold remedies, etc.)

⚠ NOTICE

■ To prevent damage to the seat heaters and seat ventilators

Do not put heavy objects that have an uneven surface on the seat and do not stick sharp objects (needles, nails, etc.) into the seat.

■ To prevent battery discharge

Do not use the functions when the engine is off.

Heated steering wheel

Turn the heated steering wheel on/off

The indicator light **A** comes on when the

heated steering wheel is operating.

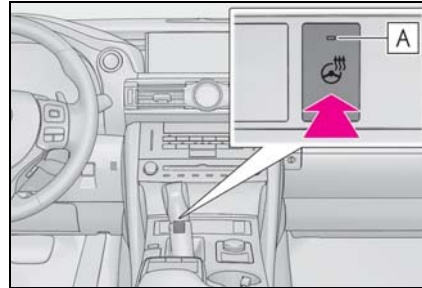

■ Operation condition

The engine switch is in IGNITION ON mode.

■ Timer function

The heated steering wheel will automatically turn off after about 30 minutes.

Seat heaters

▶ Vehicles without seat ventilators

Each time the switch is pressed, the intensity of the seat heater changes and the level indicator lights (amber)

A light as follows:

Hi (3 segments lit) → Mid (2 segments lit) → Lo (1 segment lit) → Off

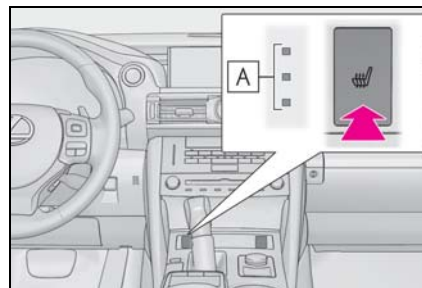

▶ Vehicles with seat ventilators

Each time the switch is pressed, the intensity of the seat heater changes and the level indicator lights (amber)

A light as follows:

Hi (3 segments lit)→Mid (2 segments lit)→Lo (1 segment lit)→Off

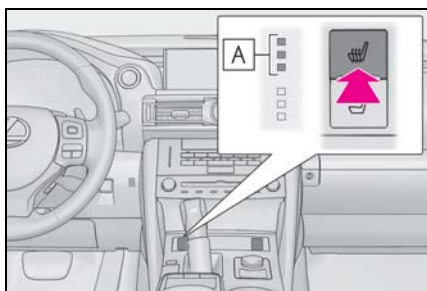

■ Operation condition

The engine switch is in IGNITION ON mode.

■ Seat heater timer control

To enable seat heater timer control, press and hold the driver and front passenger seat heater switches at the same time when the vehicle is stopped until a buzzer sounds once. If a seat heater is turned on while seat heater timer control is enabled, the intensity of the seat heater will automatically change from Hi→Mid→Lo.

The timing of the change in seat heater intensity differs depending on the temperature inside the cabin, etc. when the seat heater is operating.

To disable seat heater timer control, press and hold the driver and front passenger seat heater switches at the same time until a buzzer sounds twice.



WARNING

■ To prevent overheating and minor burn injuries

Observe the following precautions when using the seat heaters.

- Do not cover the seat with a blanket or cushion when using the seat heater.
- Do not use seat heater more than necessary.

Seat ventilators

Each time the switch is pressed, the intensity of the seat ventilator changes and the level indicator lights (green)

A light as follows:

Hi (3 segments lit)→Mid (2 segments lit)→Lo (1 segment lit)→Off

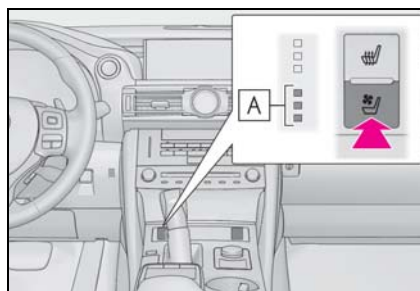

■ Operation condition

The engine switch is in IGNITION ON mode.

■ Seat ventilator

The seat ventilators provide ventilation only, and do not have a heating/cooling function.

Interior lights list

Location of the interior lights

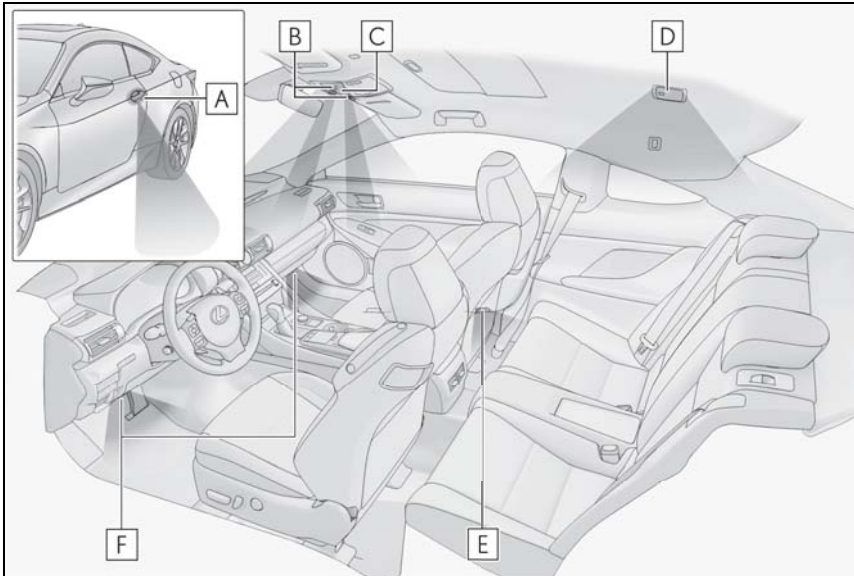

- A** Outer foot lights
- B** Personal lights (→P.226)
- C** Front interior light (→P.225)
- D** Rear interior light (→P.225)
- E** Door courtesy lights
- F** Footwell lights

Operating the interior lights

■ Front

Turns the light on/off (touch the light)

The rear interior light turns on/off together with the front interior light.

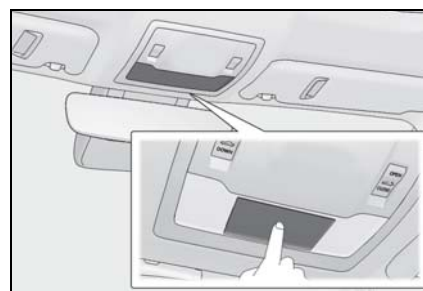

Turns the door position on/off

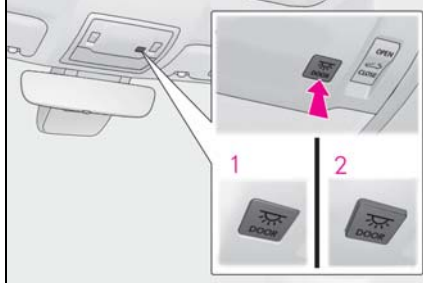

1 On

2 Off

■ Rear

Turns the light on/off

If the front interior light is off, the rear light can be turned on/off separately.

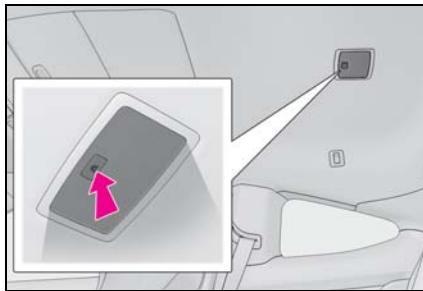

Operating the personal lights

Turns the lights on/off (touch the lights)

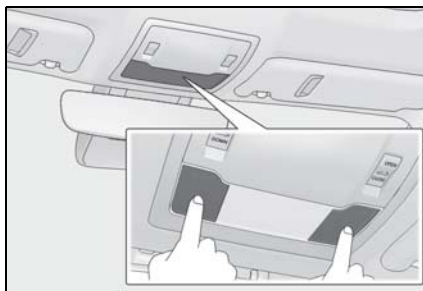

■ Illuminated entry system

The lights automatically turn on/off according to engine switch mode, the presence of the electronic key, whether the doors are

locked/unlocked, and whether the doors are opened/closed.

■ To prevent the battery from being discharged

If the interior lights remain on when the engine switch is turned off, the lights will go off automatically after 20 minutes.

■ When front interior light or personal lights do not respond as normal

- When water, dirt, etc., have adhered to the lens surface
- When operated with a wet hand
- When wearing gloves, etc.

■ Customization

Some functions can be customized. (→P.351)

⚠ NOTICE

■ Removing light lenses

Never remove the lens for the front interior light and personal lights. Otherwise, the lights will be damaged.

■ To prevent battery discharge

Do not leave the lights on longer than necessary when the engine is off.

List of storage features

Location of the storage features

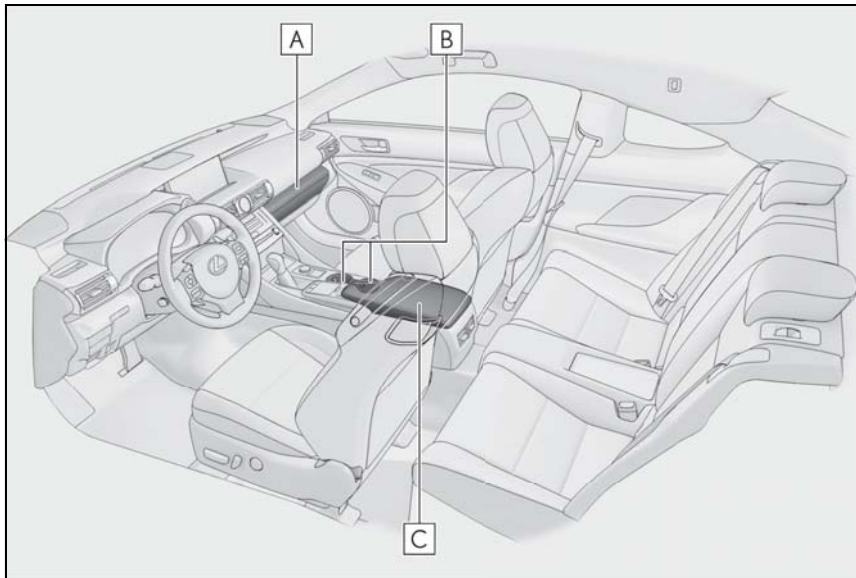

- A** Glove box (→P.227)
- B** Cup holders (→P.228)
- C** Console box (→P.228)

WARNING

■ Items that should not be left in the storage spaces

Do not leave glasses, lighters or spray cans in the storage spaces, as this may cause the following when cabin temperature becomes high:

- Glasses may be deformed by heat or cracked if they come into contact with other stored items.
- Lighters or spray cans may explode. If they come into contact with other stored items, the lighter may catch fire or the spray can may release gas, causing a fire hazard.

Glove box

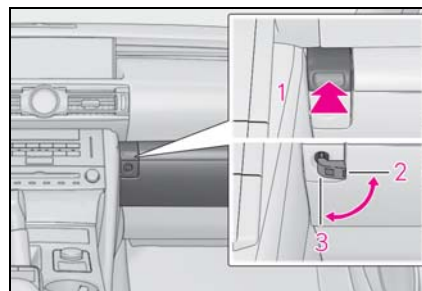

- 1** Open (press the button)
- 2** Unlock with the mechanical key
- 3** Lock with the mechanical key

■ Glove box light

The glove box light turns on when the engine switch is in ACCESSORY or IGNITION ON mode.

■ Trunk opener main switch

The trunk opener main switch is located in the glove box. (→P.94)

■ Removing the partition

The insert inside the glove box can be removed.

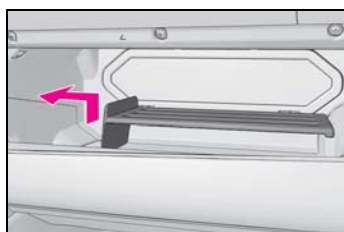

⚠ WARNING

■ Caution while driving

Keep the glove box closed. In the event of sudden braking or sudden swerving, an accident may occur due to an occupant being struck by the open glove box or the items stored inside.

Cup holders

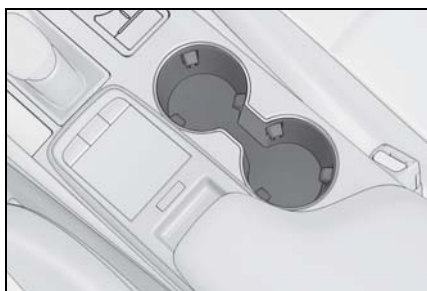

⚠ WARNING

■ Items unsuitable for the cup holder

Do not place anything other than cups or aluminum cans in the cup holders.

Other items may be thrown out of the holders in the event of an accident or sudden braking, causing injury. If possible, cover hot drinks to prevent burns.

Console box

Push the knob.

Lift by hand to fully open the console box.

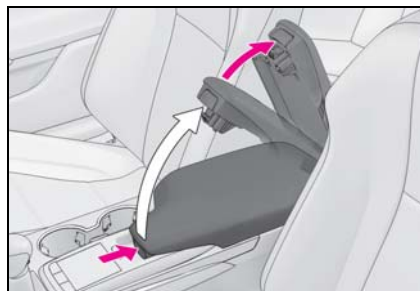

⚠ WARNING

■ Caution while driving

Keep the console box closed.

Injuries may result in the event of an accident or sudden braking.

Trunk features

Cargo hooks

Raise the hooks when needed.

The cargo hooks are provided for securing loose items.

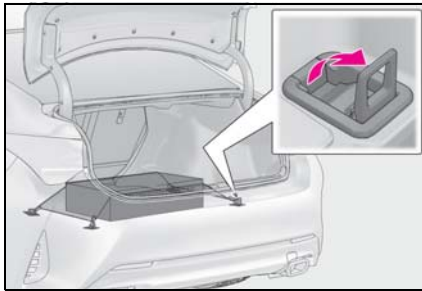

WARNING

■ When the cargo net is not in use

To avoid injury, always return the cargo hooks on the floor to their stowed positions.

First-aid kit storage belt

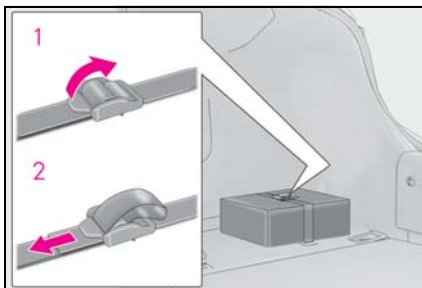

- 1 Loosen the belt
- 2 Tighten the belt

Other interior features

Assist grips

An assist grip installed on the ceiling can be used to support your body while sitting on the seat.

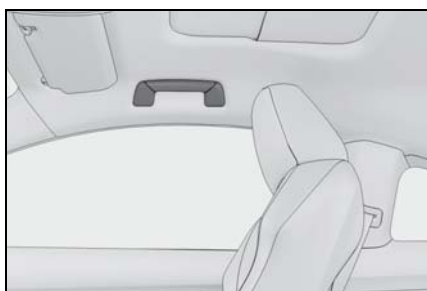

⚠ WARNING

■ Assist grip

Do not use the assist grip when getting in or out of the vehicle or rising from your seat.

⚠ NOTICE

■ To prevent damage to the assist grip

Do not put a heavy load on the assist grip.

Coat hooks

To use the coat hook, push it in.

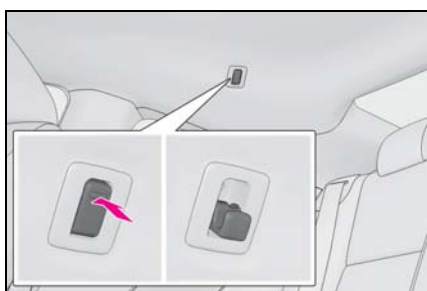

⚠ WARNING

■ Items that cannot be hung on the coat hook

Do not hang coat hangers or other hard or sharp objects on the hook. If the SRS curtain shield airbags deploy, these items may become projectiles, causing death or serious injury.

Clock

The GPS clock's time is automatically adjusted by utilizing GPS time information. For details, refer to "NAVIGATION AND MULTIMEDIA SYSTEM OWNER'S MANUAL".

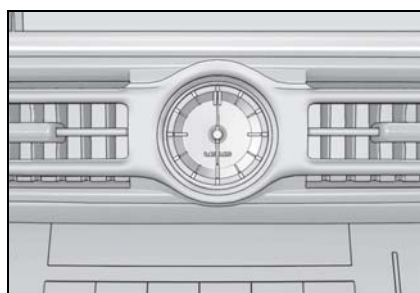

Power outlet

Please use as a power supply for electronic goods that use less than 12 VDC/10 A (power consumption of 120 W).

Open the lid.

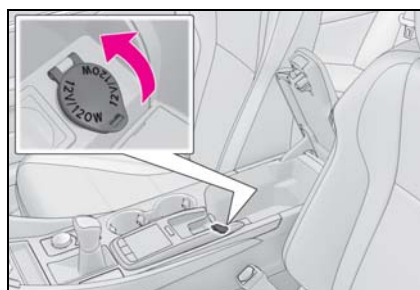

■ **The power outlet can be used when**

The engine switch is in ACCESSORY or IGNITION ON mode.

■ **Using the power outlet**

- The shape of the console box rim allows power cables to be passed through when the console box lid is closed.

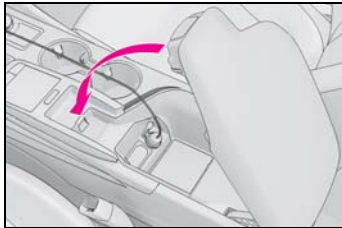

■ **When turning the engine switch off**

Disconnect electrical devices with charging functions, such as mobile battery packs. If such devices are left connected, the engine switch may not be turned off normally.

 **NOTICE**

■ **To avoid damaging the power outlet**

Close the power outlet lid when the power outlet is not in use.

Foreign objects or liquids that enter the power outlet may cause a short circuit.

■ **To prevent the battery from being discharged**

Do not use the power outlet longer than necessary when the engine is off.

Sun visors

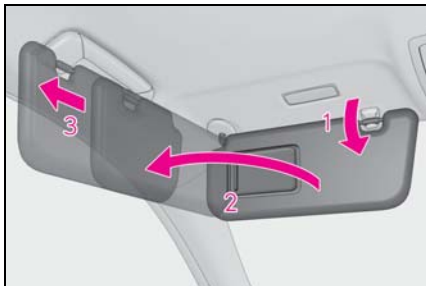

- 1 To set the visor in the forward position, flip it down.
- 2 To set the visor in the side position, flip down, unhook, and swing it to the side.
- 3 To use the side extender, place the visor in the side position, then slide it backward.

Vanity mirrors

Slide the cover to open.

The light turns on when the cover is opened.

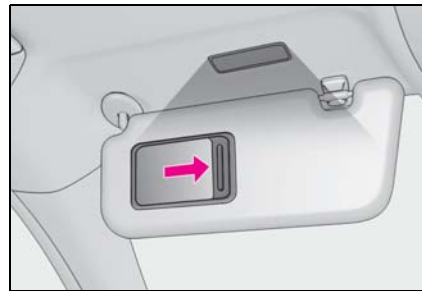

■ **To prevent battery discharge**

If the vanity lights remain on when the engine switch is turned off, the lights will go off automatically after 20 minutes.

 **NOTICE**

■ **To prevent the battery from being discharged**

Do not leave the lights on longer than necessary when the engine is off.

Garage door opener

The garage door opener can be programmed to operate garage doors, gates, entry doors, door locks, home lighting systems, security systems, and other devices.

System components

The HomeLink[®] wireless control system in your vehicle has 3 buttons which can be programmed to operate 3 different devices. Refer to the programming methods on the following pages to determine the method which is appropriate for the device.

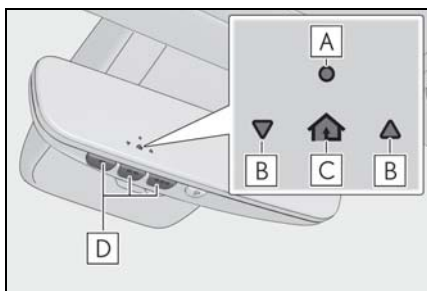

- A** HomeLink[®] indicator light
- B** Garage door operation indicators
- C** HomeLink[®] icon
- D** Buttons

Codes stored in the HomeLink[®] memory

- The registered codes are not erased even if the battery cable is disconnected.
- If learning failed when registering a different code to a HomeLink[®] button that already has a code registered to it, the

already registered code will not be erased.

When support is necessary

Visit on the web at www.homelink.com/lexus or call 1-800-355-3515.

WARNING

When programming a garage door or other remote control device

The garage door or other device may operate, so ensure people and objects are out of danger to prevent potential harm.

Conforming to federal safety standards

Do not use the HomeLink[®] compatible transceiver with any garage door opener or device that lacks safety stop and reverse features as required by federal safety standards.

This includes any garage door that cannot detect an interfering object. A door or device without these features increases the risk of death or serious injury.

When operating or programming HomeLink[®]

Never allow a child to operate or play with the HomeLink[®] buttons.

Programming the HomeLink[®]

Before programming HomeLink[®]

- During programming, it is possible that garage doors, gates, or other devices may operate. For this reason, make sure that people and objects are clear of the garage door or other devices to prevent injury or other potential harm.

- It is recommended that a new battery be placed in the remote control transmitter for more accurate programming.
- Garage door opener motors manufactured after 1995 may be equipped with rolling code protection. If this is the case, you may need a stepladder or other sturdy, safe device to reach the “Learn” or “Smart” button on the garage door opener motor.

■ Programming HomeLink®

Steps **1** through **3** must be performed within 60 seconds, otherwise the indicator light will stop flashing and programming will not be able to be completed.

- 1** Press and release the HomeLink® button you want to program and check that the HomeLink® indicator light flashes (orange).
- 2** Point the remote control transmitter for the device at the rear view mirror, 1 to 3 in. (25 to 75 mm) from the HomeLink® buttons.

Keep the HomeLink® indicator light in view while programming.



3 Program a device.

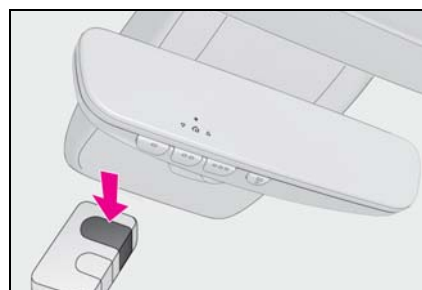

- ▶ Programming a device other than an entry gate (for U.S.A. owners)

Press and hold the handheld transmitter button until the HomeLink® indicator light changes from slowly flashing orange to rapidly flashing green (rolling code) or continuously lit green (fixed code), then release the button.

- ▶ Programming an entry gate (for U.S.A. owners)/Programming a device in the Canadian market

Press and release the remote control transmitter button at 2 second intervals, repeatedly, until the HomeLink® indicator light changes from slowly flashing (orange) to rapidly flashing (green) (rolling code) or continuously lit (green) (fixed code).

- 4** Test the HomeLink® operation by pressing the newly programmed button and observing the indicator light:

- Indicator light illuminates: Programming of a fixed code device has completed. The garage door or other device should operate when a HomeLink® button is pressed and released.

- Indicator light flashes rapidly: The garage door opener motor or other device is equipped with a rolling code. To complete programming, firmly press and hold the HomeLink[®] button for 2 seconds then release it.
- If the garage door or other device does not operate, proceed to “Programming a rolling code system”.

5 Repeat the steps above to program another device for any of the remaining HomeLink[®] buttons.

■ **Programming a rolling code system**

2 or more people may be necessary to complete rolling code programming.

1 Locate the “Learn” or “Smart” button on the garage door opener motor in the garage.

This button can usually be found where the hanging antenna wire is attached to the unit. The name and color of the button may vary by manufacturer. Refer to the owner’s manual supplied with the garage door opener motor for details.

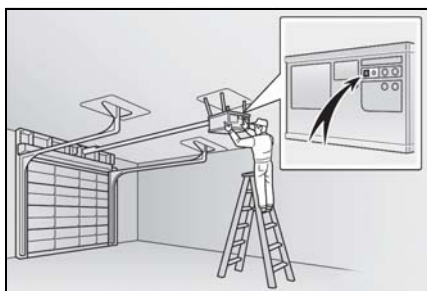

2 Press and release the “Learn” or “Smart” button.

Perform 3 within 30 seconds after performing 2.

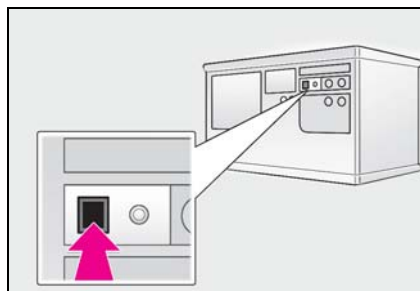

3 Press and hold the desired HomeLink[®] button (inside the vehicle) for 2 seconds and release it. Repeat this sequence (press/hold/release) up to 3 times to complete programming.

If the garage door opener motor operates when the HomeLink[®] button is pressed, the garage door opener motor recognizes the HomeLink[®] signal.

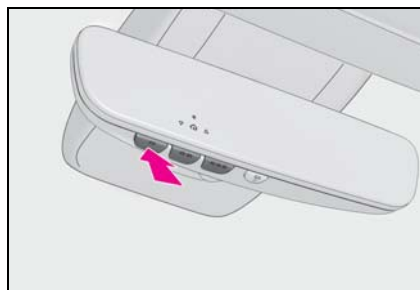

■ **Enabling 2-way communication with a garage door (only available for compatible devices)**

When enabled, 2-way communication allows you to check the status of the opening and closing of a garage door through indicators in your vehicle.

2-way communication is only available if the garage door opener motor used is a compatible device. (To check

device compatibility, refer to www.homelink.com.)

- 1 Within 5 seconds after programming the garage door opener has been completed, if the garage door opener motor is trained to HomeLink[®], both garage door operation indicators will flash rapidly (green) and the light on the garage door opener motor will blink twice, indicating that 2-way communication is enabled.

If the indicators do not flash, perform **2** and **3** within the first 10 presses of the HomeLink[®] button after programming has been completed.

- 2 Press a programmed HomeLink[®] button to operate a garage door.
- 3 Within 1 minute of pressing the HomeLink[®] button, after the garage door operation has stopped, press the “Learn” or “Smart” button on the garage door opener motor. Within 5 seconds of the establishment of 2-way communication with the garage door opener, both garage door operation indicators in the vehicle will flash rapidly (green) and the light on the garage door opener motor will blink twice, indicating that 2-way communication is enabled.

■ Reprogramming a single HomeLink[®] button

When the following procedure is performed, buttons which already have devices registered to them can be overwritten:

- 1 With one hand, press and hold the desired HomeLink[®] button.
- 2 When the HomeLink[®] indicator starts flashing (orange), continue to hold the HomeLink[®] button and perform “Programming HomeLink[®]” **1** (it takes 20 seconds for the HomeLink[®] indicator to start flashing).

■ Before programming

- Install a new battery in the transmitter.
- The battery side of the transmitter must be pointed away from the HomeLink[®].

Operating HomeLink[®]

Press the appropriate HomeLink[®] button. The HomeLink[®] indicator light should turn on.

The status of the opening and closing of a garage door is shown by the indicators.

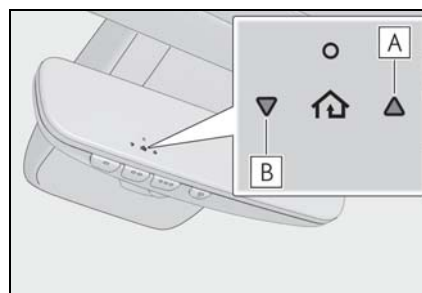

A Opening

B Closing



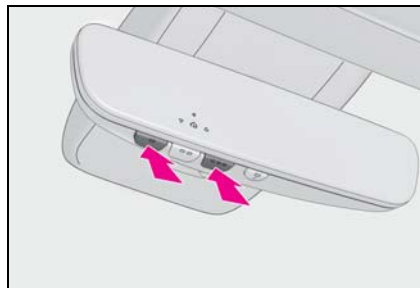

This function is only available if the garage door opener motor used is a compatible device. (To check device compatibility, refer to www.homelink.com.)

Color	Status
Orange (flashing)	Currently opening/closing
Green	Opening/closing has completed
Red (flashing)	Feedback signals cannot be received



The indicators can operate within approximately 820 ft. (250 m) of the garage door. However, if there are obstructions between the garage door and the vehicle, such as houses and trees, feedback signals from the garage door may not be received.

To recall the previous door operation status, press and release either Home-

Link[®] buttons  and  or  and  simultaneously. The last recorded status will be displayed for 3 seconds.

Erasing the entire HomeLink[®] memory (all three codes)

Press and hold the 2 outside buttons for 10 seconds until the HomeLink[®] indicator light changes from continuously lit (orange) to rapidly flashing (green).

If you sell your vehicle, be sure to erase the programs stored in the HomeLink[®] memory.

Compass*

*: If equipped

The compass on the inside rear view mirror indicates the direction in which the vehicle is heading.

Operation and displays

To turn the compass on or off, press and hold the switch for 3 seconds.

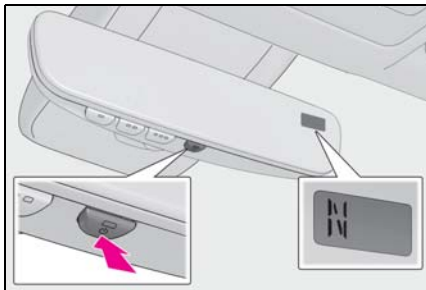

Directions are displayed as follows:

Display	Direction
"N"	North
"NE"	Northeast
"E"	East
"SE"	Southeast
"S"	South
"SW"	Southwest
"W"	West
"NW"	Northwest

Conditions unfavorable to correct operation

The compass may not show the correct direction in the following conditions:

- The vehicle is stopped immediately after turning.

- The vehicle is on an inclined surface.
- The vehicle is in a place where the earth's magnetic field is subject to interference by artificial magnetic fields (underground car park/parking lot, under a steel tower, between buildings, roof car park/parking lot, near an intersection, near a large vehicle, etc.).
- The vehicle has become magnetized. (There is a magnet or metal object near the inside rear view mirror.)
- The battery has been disconnected.
- A door is open.

WARNING

While driving the vehicle

Do not adjust the display. Adjust the display only when the vehicle is stopped.

NOTICE

To avoid compass malfunctions

Do not place magnets or any metal objects near the inside rear view mirror. Doing this may cause the compass sensor to malfunction.

To ensure normal operation of the compass

- Do not perform circling calibration of the compass in a place where the earth's magnetic field is subject to interference by artificial magnetic fields.
- During calibration, do not operate electric systems (moon roof, power windows, etc.) as they may interfere with the calibration.

Calibrating the compass

■ Deviation

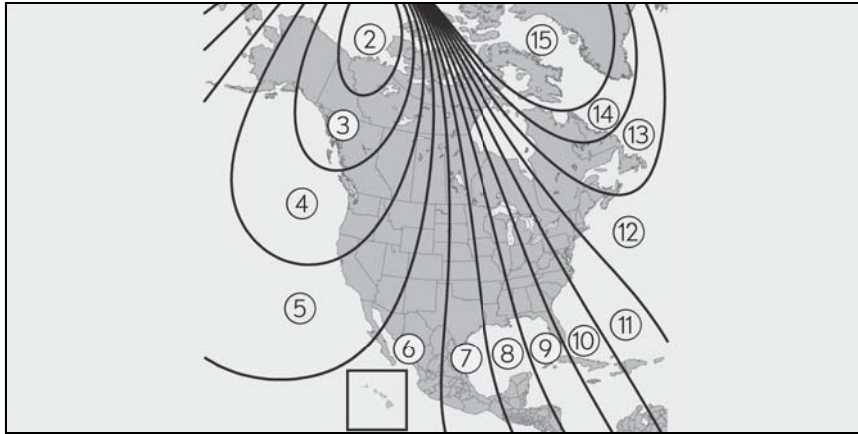

The direction display deviates from the true direction determined by the earth's magnetic field. The amount of deviation varies according to the geographic position of the vehicle.

If you cross over a map boundary shown in illustration, the compass will deviate. To obtain higher precision or perfect calibration, refer to the following.

■ Deviation calibration

- 1 Stop the vehicle.
- 2 Press and hold the switch for 6 seconds.

A number (1 to 15) appears on the compass display.

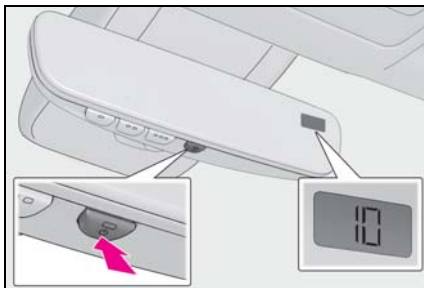

- 3 Press the switch and, referring to the map above, select the number of the zone where you are.

If the direction is displayed several seconds after adjustment, the calibration is complete.

■ Circling calibration

- 1 Stop the vehicle in a place where it is safe to drive in a circle.
- 2 Press and hold the switch for 9 seconds.

"C" appears on the compass display.

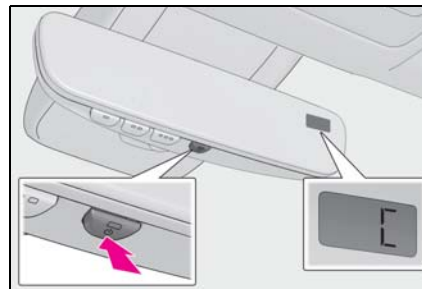

- 3 Drive the vehicle at 5 mph (8 km/h) or less in a circle until a direction is displayed.

If there is not enough space to drive in a circle, drive around the block until the direction is displayed.

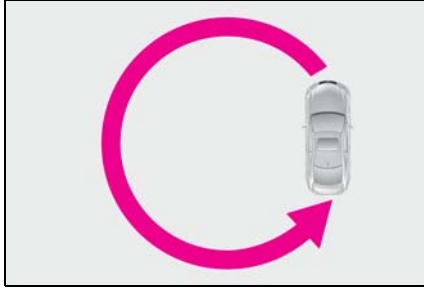

⚠ WARNING

■ **When doing the circling calibration**

Secure a wide space, and watch out for people and vehicles in the neighborhood. Do not violate any local traffic rules while performing circling calibration.

6-1. Maintenance and care

Cleaning and protecting the vehicle exterior **242**

Cleaning and protecting the vehicle interior **245**

6-2. Maintenance

Maintenance requirements **248**

General maintenance **249**

Emission inspection and maintenance (I/M) programs **252**

6-3. Do-it-yourself maintenance

Do-it-yourself service precautions **253**

Hood..... **255**

Positioning a floor jack..... **255**

Engine compartment..... **257**

Tires **265**

Tire inflation pressure..... **273**

Wheels..... **274**

Air conditioning filter..... **275**

Electronic key battery **277**

Checking and replacing fuses **278**

Headlight aim..... **280**

Light bulbs..... **281**

Cleaning and protecting the vehicle exterior

Perform cleaning in a manner appropriate to each component and its material.

Cleaning instructions

- Working from top to bottom, liberally apply water to the vehicle body, wheel wells and underside of the vehicle to remove any dirt and dust.
- Wash the vehicle body using a sponge or soft cloth, such as a chamois.
- For hard-to-remove marks, use car wash soap and rinse thoroughly with water.
- Wipe away any water.
- Wax the vehicle when the water-proof coating deteriorates.

If water does not bead on a clean surface, apply wax when the vehicle body is cool.

Black stainless steel window moldings (F SPORT models)

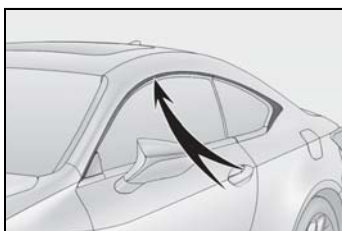

The stainless steel window moldings are made of black oxide coated stainless steel.

When cleaning the vehicle, do not scrub the moldings with an abrasive cleaner as their finish may be damaged or the color may change.

Self-restoring coat

The vehicle body has a self-restoring coating that is resistant to small surface scratches caused in a car wash etc.

- The coating lasts for 5 to 8 years from when the vehicle is delivered from the plant.
- The restoration time differs depending on the depth of the scratch and outside temperature.

The restoration time may become shorter when the coating is warmed by applying warm water.

- Deep scratches caused by keys, coins, etc. cannot be restored.
- Do not use wax that contains abrasives.

Automatic car washes

- Fold the mirrors before washing the vehicle. Start washing from the front of the vehicle. Make sure to extend the mirrors before driving.
- Brushes used in automatic car washes may scratch the vehicle surface, parts (wheel, etc.) and damage the paint.

High pressure car washes

As water may enter the cabin, do not bring the nozzle tip near the gaps around the doors or perimeter of the windows, or spray these areas continuously.

When using a car wash

If the door handle becomes wet while the electronic key is within the effective range, the door may lock and unlock repeatedly. In that case, follow the following correction procedures to wash the vehicle:

- Place the key in a position 6 ft. (2 m) or more separate from the vehicle while the vehicle is being washed. (Take care to ensure that the key is not stolen.)
- Set the electronic key to battery-saving mode to disable the smart access system with push-button start. (→P.95)

Wheels and wheel ornaments

- Remove any dirt immediately by using a neutral detergent.
- Wash detergent off with water immedi-

ately after use.

- To protect the paint from damage, make sure to observe the following precautions.
 - Do not use acidic, alkaline or abrasive detergent
 - Do not use hard brushes
 - Do not use detergent on the wheels when they are hot, such as after driving or parking in hot weather

■ Brake caliper coating (F SPORT models)

- When using detergent, use neutral detergent. Do not use hard brushes or abrasive cleaners, as they will damage the paint.
- Do not use detergent on the brake calipers when they are hot.
- Wash detergent off immediately after use.

■ Bumpers

Do not scrub with abrasive cleaners.

■ Side windows water-repellent coating (if equipped)

- The following precautions can extend the effectiveness of the water-repellent coating.
 - Remove any dirt, etc. from the side windows regularly.
 - Do not allow dirt and dust to accumulate on the windows for a long period. Clean the windows with a soft, damp cloth as soon as possible.
 - Do not use wax or glass cleaners that contain abrasives when cleaning the windows.
 - Do not use any metallic objects to remove condensation build up.
- When the water-repellent performance has become insufficient, the coating can be repaired. Contact your Lexus dealer.

■ Plated portions

If dirt cannot be removed, clean the parts as follows:

- Use a soft cloth dampened with an approximately 5% solution of neutral detergent and water to clean the dirt off.
- Wipe the surface with a dry, soft cloth to

remove any remaining moisture.

- To remove oily deposits, use alcohol wet wipes or a similar product.

⚠ WARNING

■ When washing the vehicle

Do not apply water to the inside of the engine compartment. Doing so may cause the electrical components, etc. to catch fire.

■ When cleaning the windshield (vehicles with rain-sensing windshield wipers)

Set the wipers to the intermittent windshield wipers. (→P.147)

If AUTO mode is selected, the wipers may operate unexpectedly in the following situations, and may result in hands being caught or other serious injuries and cause damage to the wiper blades.

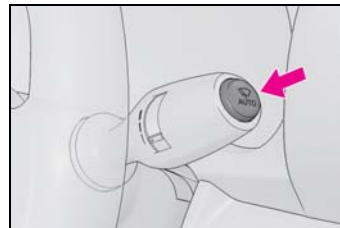

- When the upper part of the windshield where the raindrop sensor is located is touched by hand
- When a wet rag or similar is held close to the raindrop sensor
- If something bumps against the windshield
- If you directly touch the raindrop sensor body or if something bumps into the raindrop sensor

**WARNING****■ Precautions regarding the exhaust pipes**

As exhaust gases cause the exhaust pipes to become quite hot, do not touch the exhaust pipes while the engine is running or immediately after the engine is turned off.

When washing the vehicle, be careful not to touch the exhaust pipes until they have cooled sufficiently, as touching hot exhaust pipes can cause burns.

■ Precaution regarding the rear bumper with Blind Spot Monitor (if equipped)

If the paint of the rear bumper is chipped or scratched, the system may malfunction. If this occurs, consult your Lexus dealer.

**NOTICE****■ To prevent paint deterioration and corrosion on the body and components (aluminum wheels, etc.)**

- Wash the vehicle immediately in the following cases:
 - After driving near the sea coast
 - After driving on salted roads
 - If coal tar or tree sap is present on the paint surface
 - If dead insects, insect droppings or bird droppings are present on the paint surface
 - After driving in an area contaminated with soot, oily smoke, mine dust, iron powder or chemical substances
 - If the vehicle becomes heavily soiled with dust or mud
 - If liquids such as benzene and gasoline are spilled on the paint surface
- If the paint is chipped or scratched, have it repaired immediately.

- To prevent the wheels from corroding, remove any dirt and store in a place with low humidity when storing the wheels.

■ Cleaning the exterior lights

- Wash carefully. Do not use organic substances or scrub with a hard brush. This may damage the surfaces of the lights.
- Do not apply wax to the surfaces of the lights. Wax may cause damage to the lenses.

■ To prevent damage to the windshield wiper arms

When lifting the wiper arms away from the windshield, pull the driver side wiper arm upward first, and repeat for the passenger side. When returning the wipers to their original position, do so from the passenger side first.

■ When using an automatic car wash (vehicles with rain-sensing windshield wipers)

Set the wipers to the intermittent windshield wipers. (→P.147)

If AUTO mode is selected, the wipers may operate and the wiper blades may be damaged.

■ When using a high pressure car wash

- When washing the vehicle, do not spray the camera or its surrounding area directly with a high pressure washer. Shock applied from high pressure water may cause the device to not operate normally.
- Do not bring the nozzle tip close to boots (rubber or resin manufactured cover), connectors or the following parts. The parts may be damaged if they come into contact with high-pressure water.
 - Traction related parts
 - Suspension parts
 - Steering parts

**NOTICE**

- Brake parts
- Keep the cleaning nozzle at least 11.9 in. (30 cm) away from the vehicle body. Otherwise resin section, such as moldings and bumpers, may be deformed and damaged.

Also, do not continuously hold the nozzle in the same place.

- Do not spray the lower part of the windshield continuously.

If water enters the air conditioning system intake located near the lower part of the windshield, the air conditioning system may not operate correctly.

- Do not wash the underside of the vehicle using a high pressure car washer.

Cleaning and protecting the vehicle interior

Perform cleaning in a manner appropriate to each component and its material.

Protecting the vehicle interior

- Remove dirt and dust using a vacuum cleaner. Wipe dirty surfaces with a cloth dampened with lukewarm water.
- If dirt cannot be removed, wipe it off with a soft cloth dampened with neutral detergent diluted to approximately 1%.

Wring out any excess water from the cloth and thoroughly wipe off remaining traces of detergent and water.

Shampooing the carpets

There are several commercial foaming-type cleaners available. Use a sponge or brush to apply the foam. Rub in overlapping circles. Do not use water. Wipe dirty surfaces and let them dry. Excellent results are obtained by keeping the carpet as dry as possible.

Handling the seat belts

Clean with mild soap and lukewarm water using a cloth or sponge. Also check the belts periodically for excessive wear, fraying or cuts.

When cleaning the carpeted portions of the glove box, console box, etc.

If a strong adhesive tape is used, there is a possibility that the surface of the carpet could be damaged.

⚠ WARNING**■ Water in the vehicle**

- Do not splash or spill liquid in the vehicle.

Doing so may cause electrical components, etc. to malfunction or catch fire.

- Do not get any of the SRS components or wiring in the vehicle interior wet. (→P.28)

An electrical malfunction may cause the airbags to deploy or not function properly, resulting in death or serious injury.

■ Cleaning the interior (especially instrument panel)

Do not use polish wax or polish cleaner. The instrument panel may reflect off the windshield, obstructing the driver's view and leading to an accident, resulting in death or serious injury.

⚠ NOTICE**■ Cleaning detergents**

- Do not use the following liquids, as they may discolor the vehicle interior or cause streaks or damage to painted surfaces:
 - Center Display: Organic substances such as benzine or gasoline, alkaline solutions, and alcohol
 - Seats: Alkaline solutions, organic substances such as thinner or benzine, and alcohol
 - Other parts: Organic substances such as benzine or gasoline, alkaline or acidic solutions, dye, and bleach
- Do not use polish wax or polish cleaner. The instrument panel's or other interior part's painted surface may be damaged.

■ Preventing damage to leather surfaces

Observe the following precautions to avoid damage to and deterioration of leather surfaces:

- Remove any dust or dirt from leather surfaces immediately.
- Do not expose the vehicle to direct sunlight for extended periods of time. Park the vehicle in the shade, especially during summer.
- Do not place items made of vinyl, plastic, or containing wax on the upholstery, as they may stick to the leather surface if the vehicle interior heats up significantly.

■ Water on the floor

Do not wash the vehicle floor with water. Vehicle systems such as the audio system may be damaged if water comes into contact with electrical components such as the audio system above or under the floor of the vehicle. Water may also cause the body to rust.

■ When cleaning the inside of the windshield

Do not allow glass cleaner to contact the lens. Also, do not touch the lens. (→P.158)

■ Cleaning the inside of the rear window

- Do not use glass cleaner to clean the rear window, as this may cause damage to the rear window defogger heater wires or antenna. Use a cloth dampened with lukewarm water to gently wipe the window clean. Wipe the window in strokes running parallel to the heater wires or antenna.
- Be careful not to scratch or damage the heater wires or antenna.

Cleaning the leather areas

- Remove dirt and dust using a vac-

uum cleaner.

- Wipe off any excess dirt and dust with a soft cloth dampened with diluted detergent.

Use a diluted water solution of approximately 5% neutral wool detergent.

- Wring out any excess water from the cloth and thoroughly wipe off all remaining traces of detergent.
- Wipe the surface with a dry, soft cloth to remove any remaining moisture.

Allow the leather to dry in a shaded and ventilated area.

■ Caring for leather areas

Lexus recommends cleaning the interior of the vehicle at least twice a year to maintain the quality of the vehicle's interior.

Cleaning the synthetic leather areas

- Remove dirt and dust using a vacuum cleaner.
- Wipe it off with a soft cloth dampened with neutral detergent diluted to approximately 1%.
- Wring out any excess water from the cloth and thoroughly wipe off remaining traces of detergent and water.

Maintenance requirements

To ensure safe and economical driving, day-to-day care and regular maintenance are essential. It is the owner's responsibility to perform regular checks. Lexus recommends the maintenance below.

■ Repair and replacement

It is recommended that genuine Lexus parts be used for repairs to ensure performance of each system. If non-Lexus parts are used in replacement or if a repair shop other than a Lexus dealer performs repairs, confirm the warranty coverage.

■ Allow inspection and repairs to be performed by a Lexus dealer

- Lexus technicians are well-trained specialists and are kept up to date with the latest service information. They are well informed about the operations of all systems on your vehicle.
- Keep a copy of the repair order. It proves that the maintenance that has been performed is under warranty coverage. If any problem should arise while your vehicle is under warranty, your Lexus dealer will promptly take care of it.

⚠ WARNING

■ If your vehicle is not properly maintained

Improper maintenance could result in serious damage to the vehicle and possible death or serious injury.

■ Handling of the battery

- Engine exhaust, some of its constituents, and a wide variety of automobile components contain or emit chemicals known to the State of California to cause cancer and birth defects and other reproductive harm. Work in a well ventilated area.

- Oils, fuels and fluids contained in vehicles as well as waste produced by component wear contain or emit chemicals known to the State of California to cause cancer and birth defects or other reproductive harm. Avoid exposure and wash any affected area immediately.

- Battery posts, terminals and related accessories contain lead and lead compounds which are known to cause brain damage. Wash your hands after handling. (→P.263)

General maintenance

General maintenance should be performed on a daily basis. This can be done by yourself or by a Lexus dealer.

Scheduled maintenance



Scheduled maintenance should be performed at specified intervals according to the maintenance schedule.

For details about maintenance items and schedules, refer to the "Warranty and Service Guide", "Owner's Manual Supplement" or "Scheduled Maintenance".

■ Resetting the message indicating maintenance is required

After the required maintenance is performed according to the maintenance schedule, please reset the message.

To reset the message, follow the procedures described below:

- 1 Select  on the multi-information display. (→P.76)
- 2 Press the  or  meter control switch on the steering wheel to select "Vehicle Settings" then "Scheduled

Maintenance". (To confirm setting, press )

- 3 Select "Yes" and then press .
- 4 A message will be displayed on the multi-information display when the reset procedure has been completed.

Do-it-yourself maintenance

You can perform some maintenance procedures by yourself.

Please be aware that do-it-yourself maintenance may affect warranty coverage.

The use of Lexus repair manuals is recommended.

For details about warranty coverage, refer to the separate "Owner's Guide", "Warranty and Service Guide", "Owner's Manual Supplement" or "Warranty Booklet".

General maintenance

Listed below are the general maintenance items that should be performed at the intervals specified in the "Warranty and Service Guide" or "Owner's Manual Supplement". It is recommended that any problem you notice should be brought to the attention of your Lexus dealer or qualified service shop for advice.

WARNING

If the engine is running

Turn the engine off and ensure that there is adequate ventilation before performing maintenance checks.

Engine compartment

Items	Check points
Battery	Check the indicator (if equipped) and connections. (→P.263)
Brake fluid	Is the brake fluid at the correct level? (→P.262)
Engine/inter-cooler coolant	Is the engine/inter-cooler coolant at the correct level? (→P.260)
Engine oil	Is the engine oil at the correct level? (→P.258)
Exhaust system	There should not be any fumes or strange sounds.

Items	Check points
Radiator, condenser and inter-cooler radiator	The radiator, condenser and inter-cooler radiator should be free from foreign objects. (→P.262)
Washer fluid	Is there sufficient washer fluid? (→P.264)

Vehicle interior

Items	Check points
Accelerator pedal	<ul style="list-style-type: none"> The accelerator pedal should move smoothly (without uneven pedal effort or catching).
Automatic transmission "Park" mechanism	<ul style="list-style-type: none"> When parked on a slope and the shift lever is in P, is the vehicle securely stopped?
Brake pedal	<ul style="list-style-type: none"> Does the brake pedal move smoothly? Does the brake pedal have appropriate clearance from the floor? Does the brake pedal have the correct amount of free play?

Items	Check points
Brakes	<ul style="list-style-type: none"> The vehicle should not pull to one side when the brakes are applied. The brakes should work effectively. The brake pedal should not feel spongy. The brake pedal should not get too close to the floor when the brakes are applied.
Head restraints	<ul style="list-style-type: none"> Do the head restraints move smoothly and lock securely?
Indicators/buzzers	<ul style="list-style-type: none"> Do the indicators and buzzers function properly?
Lights	<ul style="list-style-type: none"> Do all the lights come on?
Parking brake	<ul style="list-style-type: none"> Does the parking brake pedal move smoothly? When parked on a slope and the parking brake is on, is the vehicle securely stopped?
Seat belts	<ul style="list-style-type: none"> Do the seat belts operate smoothly? The seat belts should not be damaged.

Items	Check points
Seats	<ul style="list-style-type: none"> • Do the seat controls operate properly?
Steering wheel	<ul style="list-style-type: none"> • Does the steering wheel rotate smoothly? • Does the steering wheel have the correct amount of free play? • There should not be any strange sounds coming from the steering wheel.

Vehicle exterior

Items	Check points
Doors/trunk	<ul style="list-style-type: none"> • Do the doors/trunk operate smoothly?
Engine hood	<ul style="list-style-type: none"> • Does the engine hood lock system work properly?
Fluid leaks	<ul style="list-style-type: none"> • There should not be any signs of fluid leakage after the vehicle has been parked.

Items	Check points
Tires	<ul style="list-style-type: none"> • Is the tire inflation pressure correct? • The tires should not be damaged or excessively worn. • Have the tires been rotated according to the maintenance schedule? • The wheel nuts should not be loose.
Windshield wipers	<ul style="list-style-type: none"> • The wiper blades should not show any signs of cracking, splitting, wear, contamination or deformation. • The wiper blades should clear the windshield without streaking or skipping.

Emission inspection and maintenance (I/M) programs

Some states have vehicle emission inspection programs which include OBD (On Board Diagnostics) checks. The OBD system monitors the operation of the emission control system.

If the malfunction indicator lamp comes on

The OBD system determines that a problem exists somewhere in the emission control system. Your vehicle may not pass the I/M test and may need to be repaired. Contact your Lexus dealer to service the vehicle.

Your vehicle may not pass the I/M test in the following situations:

- When the battery is disconnected or discharged

Readiness codes that are set during ordinary driving are erased. Also, depending on your driving habits, the readiness codes may not be completely set.

- When the fuel tank cap is loose

The malfunction indicator lamp comes on indicating a temporary malfunction and your vehicle may not pass the I/M test.

When the malfunction indicator lamp still remains on after several driving trips

The error code in the OBD system will not be cleared unless the vehicle is driven 40 or more times.

If your vehicle does not pass the I/M test

Contact your Lexus dealer to prepare the vehicle for re-testing.

Do-it-yourself service precautions

If you perform maintenance by yourself, be sure to follow the correct procedure as given in these sections.

Maintenance

Items	Parts and tools
Battery condition (→P.263)	<ul style="list-style-type: none"> • Warm water • Baking soda • Grease • Conventional wrench (for terminal clamp bolts)
Brake fluid level (→P.262)	<ul style="list-style-type: none"> • SAE J1703 or FMVSS No.116 DOT 3 brake fluid • SAE J1704 or FMVSS No.116 DOT 4 brake fluid • Rag or paper towel • Funnel (used only for adding brake fluid)

Items	Parts and tools
Engine/inter-cooler coolant level(→P.260)	<ul style="list-style-type: none"> • "Toyota Super Long Life Coolant" or a similar high quality ethylene glycol-based non-silicate, non-amine, non-nitrite and non-borate coolant with long-life hybrid organic acid technology • For the U.S.A.: "Toyota Super Long Life Coolant" is pre-mixed with 50% coolant and 50% deionized water. • For Canada: "Toyota Super Long Life Coolant" is pre-mixed with 55% coolant and 45% deionized water. • Funnel (used only for adding coolant)
Engine oil level (→P.258)	<ul style="list-style-type: none"> • "Toyota Genuine Motor Oil" or equivalent • Rag or paper towel • Funnel (used only for adding engine oil)
Fuses (→P.278)	<ul style="list-style-type: none"> • Fuse with same amperage rating as original

Items	Parts and tools
Light bulbs (→P.281)	<ul style="list-style-type: none"> • Bulb with same number and wattage rating as original • Phillips-head screwdriver • Flathead screwdriver • Wrench
Radiator, condenser and intercooler radiator (→P.262)	—
Tire inflation pressure (→P.273)	<ul style="list-style-type: none"> • Tire pressure gauge • Compressed air source
Washer fluid (→P.264)	<ul style="list-style-type: none"> • Water or washer fluid containing anti-freeze (for winter use) • Funnel (used only for adding water or washer fluid)

⚠ WARNING

The engine compartment contains many mechanisms and fluids that may move suddenly, become hot, or become electrically energized. To avoid death or serious injury, observe the following precautions.

■ **When working on the engine compartment**

- Keep hands, clothing and tools away from the moving fans and engine drive belt.
- Be careful not to touch the engine, radiator, exhaust manifold, etc. right after driving as they may be hot. Oil and other fluids may also be hot.

- Do not leave anything that may burn easily, such as paper and rags, in the engine compartment.
- Do not smoke, cause sparks or expose an open flame to fuel or the battery. Fuel and battery fumes are flammable.
- Be extremely cautious when working on the battery. It contains poisonous and corrosive sulfuric acid.

■ **When working near the electric cooling fans or radiator grille**

Be sure the engine switch is off.

With the engine switch in IGNITION ON mode, the electric cooling fans may automatically start to run if the air conditioning is on and/or the coolant temperature is high. (→P.262)

■ **Safety glasses**

Wear safety glasses to prevent flying or falling material, fluid spray, etc. from getting in your eyes.

⚠ NOTICE

■ **If you remove the air cleaner filter**

Driving with the air cleaner filter removed may cause excessive engine wear due to dirt in the air.

Hood

Opening the hood

- 1 Pull the hood lock release lever.
The hood will pop up slightly.

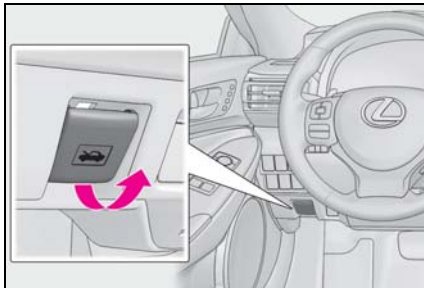

- 2 Pull up the auxiliary catch lever and lift the hood.

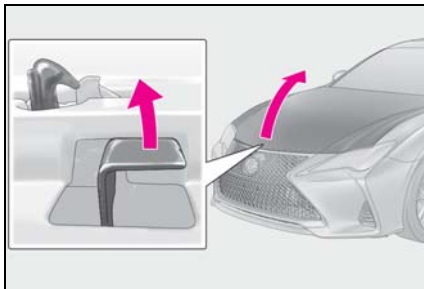

- If a symbol indicating the hood opens is shown on the multi-information display →P.90

⚠ WARNING

■ Pre-driving check

Check that the hood is fully closed and locked.

If the hood is not locked properly, it may open while the vehicle is in motion and cause an accident, which may result in death or serious injury.

Positioning a floor jack

When using a floor jack, follow the instructions in the manual provided with the jack and perform the operation safely.

When raising your vehicle with a floor jack, position the jack correctly. Improper placement may damage your vehicle or cause injury.

Location of the jack point

■ Front

- ▶ 2WD models

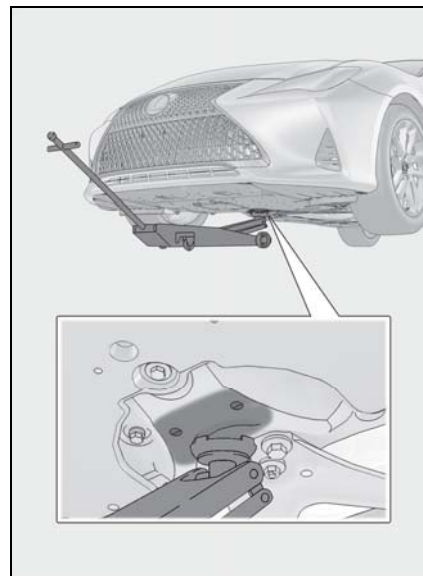

▶ AWD models

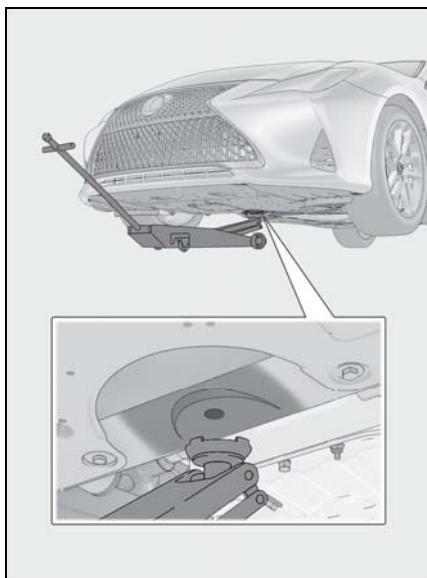

■ Rear

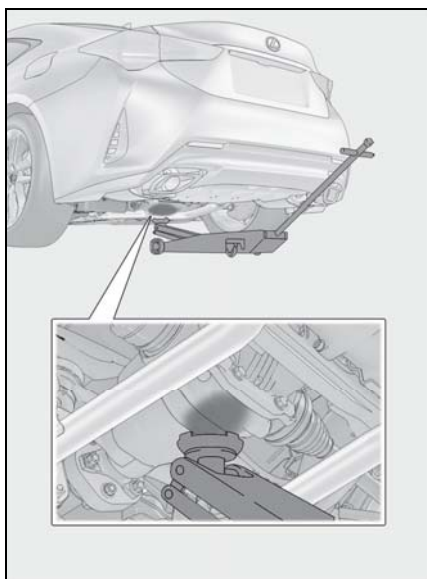

Engine compartment

Components

► RC350/RC300 AWD

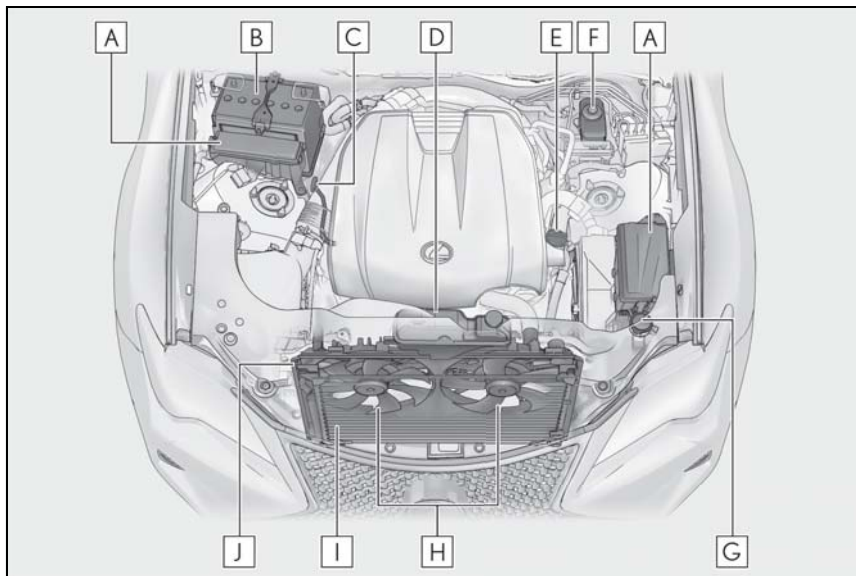

- A** Fuse boxes (→P.278)
- B** Battery (→P.263)
- C** Engine oil level dipstick (→P.258)
- D** Engine coolant reservoir (→P.260)
- E** Engine oil filler cap (→P.258)
- F** Brake fluid reservoir (→P.262)
- G** Washer fluid tank (→P.264)
- H** Electric cooling fans
- I** Condenser (→P.262)
- J** Radiator (→P.262)

► RC300

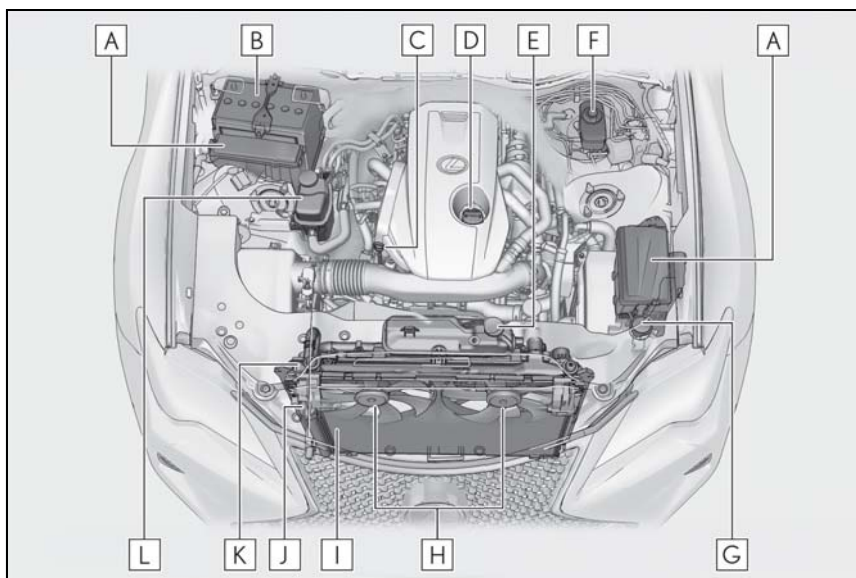

- A** Fuse boxes (→P.278)
- B** Battery (→P.263)
- C** Engine oil level dipstick (→P.258)
- D** Engine oil filler cap (→P.258)
- E** Engine coolant reservoir (→P.260)
- F** Brake fluid reservoir (→P.262)
- G** Washer fluid tank (→P.264)
- H** Electric cooling fans
- I** Condenser (→P.262)
- J** Intercooler radiator (→P.262)
- K** Radiator (→P.262)
- L** Intercooler coolant reservoir (→P.260)

Checking and adding the engine oil

With the engine at operating temperature and turned off, check the oil level on the dipstick.

■ **Checking the engine oil**

- 1** Park the vehicle on level ground. After warming up the engine and turning it off, wait more than 5 minutes for the oil to drain back into the bottom of the engine.

- 2** Holding a rag under the end, pull the dipstick out.

▶ RC350/RC300 AWD

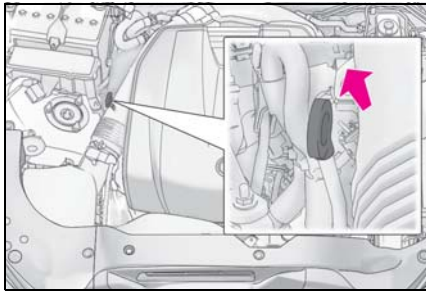

▶ RC300

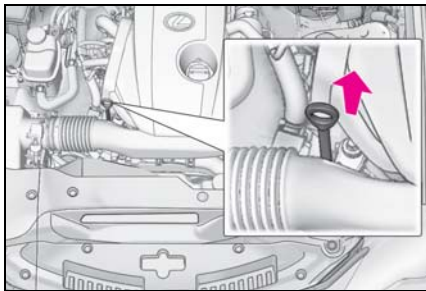

- 3** Wipe the dipstick clean.
4 Reinsert the dipstick fully.
5 Holding a rag under the end, pull the dipstick out and check the oil level.

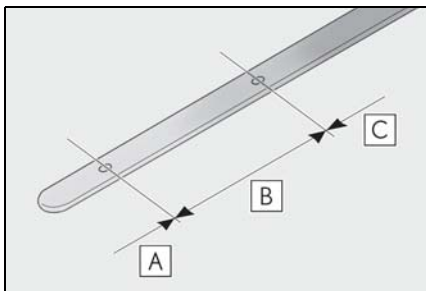

- A** Low
B Normal
C Excessive

The shape of the dipstick may differ depending on the type of vehicle or engine.

- 6** Wipe the dipstick and reinsert it fully.

■ Checking the oil type and preparing the item needed

Make sure to check the oil type and prepare the items needed before adding oil.

- Engine oil selection
→P.331
- Oil quantity (Low → Full)
1.6 qt. (1.5 L, 1.3 Imp. qt.)
- Item
Clean funnel

■ Adding engine oil

If the oil level is below or near the low level mark, add engine oil of the same type as that already in the engine.

▶ RC350/RC300 AWD

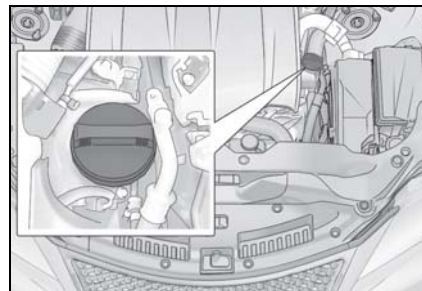

▶ RC300

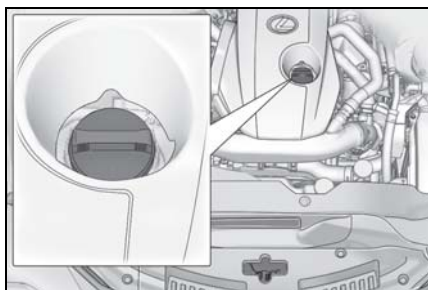

- 1 Remove the oil filler cap by turning it counterclockwise.
- 2 Add engine oil slowly, checking the dipstick.
- 3 Install the oil filler cap by turning it clockwise.





■ Engine oil consumption

A certain amount of engine oil will be consumed while driving. In the following situations, oil consumption may increase, and engine oil may need to be refilled in between oil maintenance intervals.

- When the engine is new, for example directly after purchasing the vehicle or after replacing the engine
- If low quality oil or oil of an inappropriate viscosity is used
- When driving at high engine speeds or with a heavy load, or when driving while accelerating or decelerating frequently
- When leaving the engine idling for a long time, or when driving frequently through heavy traffic

■ After changing the engine oil

The engine oil maintenance data should be reset. Perform the following procedures:

- 1 Select  on the multi-information display. (→P.76)
- 2 Press the  or  meter control switch on the steering wheel to select "Vehicle Settings" then "Oil Maintenance". (To confirm setting, press .)

- 3 Select "Yes" and then press .
- 4 A message is displayed on the multi-information display.

 WARNING

■ Used engine oil

- Used engine oil contains potentially harmful contaminants which may cause skin disorders such as inflammation and skin cancer, so care should be taken to avoid prolonged and repeated contact. To remove used engine oil from your skin, wash thoroughly with soap and water.
- Dispose of used oil and filters only in a safe and acceptable manner. Do not dispose of used oil and filters in household trash, in sewers or onto the ground. Call your Lexus dealer, service station or auto parts store for information concerning recycling or disposal.
- Do not leave used engine oil within the reach of children.

 NOTICE

■ To prevent serious engine damage

Check the oil level on a regular basis.

■ When replacing the engine oil

- Be careful not to spill engine oil on the vehicle components.
- Avoid overfilling, or the engine could be damaged.
- Check the oil level on the dipstick every time you refill the vehicle.
- Be sure the engine oil filler cap is properly tightened.

Checking the coolant

The coolant level is satisfactory if it is between the "FULL" and "LOW" lines

on the reservoir when the engine is cold.

■ Engine coolant reservoir

▶ RC350/RC300 AWD

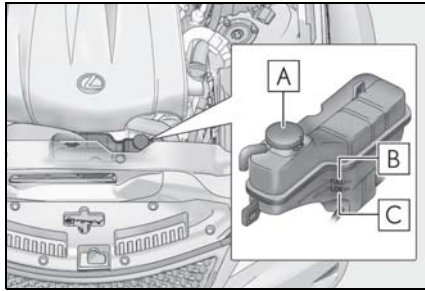

▶ RC300

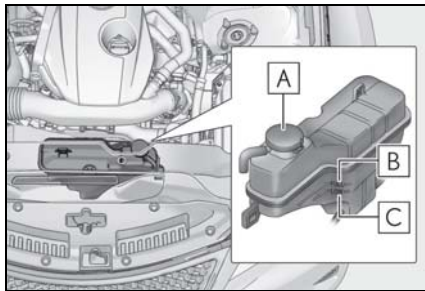

A Reservoir cap

B "FULL" line

C "LOW" line

If the level is on or below the "LOW" line, add coolant up to the "FULL" line. (→P.322)

■ Intercooler coolant reservoir (RC300)

The coolant level is satisfactory if it is between the "F" and "L" lines on the reservoir when the engine is cold.

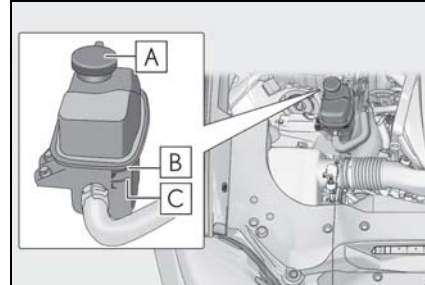

A Reservoir cap

B "F" line

C "L" line

If the level is on or below the "L" line, add coolant up to the "F" line. (→P.322)

■ Coolant selection

Only use "Toyota Super Long Life Coolant" or a similar high quality ethylene glycol based non-silicate, non-amine, non-nitrite, and non-borate coolant with long-life hybrid organic acid technology.

U.S.A.:

"Toyota Super Long Life Coolant" is a mixture of 50% coolant and 50% deionized water. (Minimum temperature: -31°F [-35°C])

Canada:

"Toyota Super Long Life Coolant" is a mixture of 55% coolant and 45% deionized water. (Minimum temperature: -44°F [-42°C])

For more details about coolant, contact your Lexus dealer.

■ If the coolant level drops within a short time of replenishing

Visually check the radiator, hoses, engine and intercooler coolant reservoir caps, drain cock and water pump.

If you cannot find a leak, have your Lexus dealer test the cap and check for leaks in the cooling system.

⚠ WARNING

■ **When the engine is hot**

Do not remove the engine coolant reservoir cap, intercooler coolant reservoir cap and coolant inlet cap. (→P.325)

The cooling system may be under pressure and may spray hot coolant if the cap is removed, causing serious injuries, such as burns.

⚠ NOTICE

■ **When adding coolant**

Coolant is neither plain water nor straight antifreeze. The correct mixture of water and antifreeze must be used to provide proper lubrication, corrosion protection and cooling. Be sure to read the antifreeze or coolant label.

■ **If you spill coolant**

Be sure to wash it off with water to prevent it from damaging parts or paint.

Checking the radiator, condenser and intercooler radiator (if equipped)

Check the radiator, condenser and intercooler radiator and clear away any foreign objects.

If any of the above parts are extremely dirty or you are not sure of their condition, have your vehicle inspected by your Lexus dealer.

⚠ WARNING

■ **When the engine is hot**

Do not touch the radiator, condenser or intercooler radiator as they may be hot and cause serious injuries, such as burns.

Checking and adding the brake fluid

■ **Checking fluid level**

The brake fluid level should be between the “MAX” and “MIN” lines on the tank.

▶ RC350/RC300 AWD

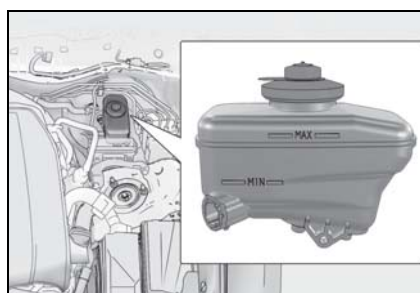

▶ RC300

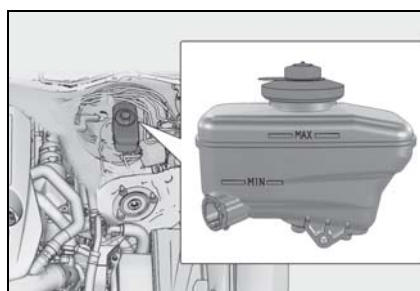

■ **Adding fluid**

Make sure to check the fluid type and prepare the necessary item.

- Fluid type
 - SAE J1703 or FMVSS No.116 DOT 3 brake fluid
 - SAE J1704 or FMVSS No.116 DOT 4 brake fluid
- Item
 - Clean funnel

■ Brake fluid can absorb moisture from the air

Excess moisture in the brake fluid can cause a dangerous loss of braking efficiency. Use only newly opened brake fluid.

⚠ WARNING

■ When filling the reservoir

Take care as brake fluid can harm your hands and eyes and damage painted surfaces. If fluid gets on your hands or in your eyes, flush the affected area with clean water immediately.

If you still experience discomfort, see a doctor.

⚠ NOTICE

■ If the fluid level is low or high

It is normal for the brake fluid level to go down slightly as the brake pads wear out or when the fluid level in the accumulator is high.

If the reservoir needs frequent refilling, there may be a serious problem.

Battery

Check the battery as follows.

■ Battery exterior

Make sure that the battery terminals are not corroded and that there are no loose connections, cracks, or loose clamps.

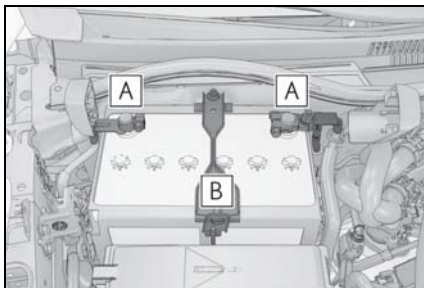

A Terminals

B Hold-down clamp

■ Before recharging

When recharging, the battery produces hydrogen gas which is flammable and explosive. Therefore, observe the following before recharging:

- If recharging with the battery installed on the vehicle, be sure to disconnect the ground cable.
- Make sure the power switch on the charger is off when connecting and disconnecting the charger cables to the battery.

■ After recharging/reconnecting the battery

The engine may not start. Follow the procedure below to initialize the system.

- 1 Shift the shift lever to P.
 - 2 Open and close either door.
 - 3 Restart the engine.
- Unlocking the doors using the smart access system with push-button start may not be possible immediately after reconnecting the battery. If this happens, use the wireless remote control or the mechanical key to lock/unlock the doors.
 - Start the engine with the engine switch in ACCESSORY mode. The engine may not start with the engine switch turned off. However, the engine will operate normally from the second attempt.
 - The engine switch mode is recorded by the vehicle. If the battery is disconnected and reconnected, the vehicle will return the engine switch mode to the status it was in before the battery was disconnected. Make sure to turn off the engine before disconnecting the battery. Take extra care when connecting the battery if the engine switch mode prior to the battery being disconnected is unknown.

If the system will not start even after multiple attempts, contact your Lexus dealer.

WARNING

■ Chemicals in the battery

Batteries contain poisonous and corrosive sulfuric acid and may produce hydrogen gas which is flammable and explosive. To reduce the risk of death or serious injury, take the following precautions while working on or near the battery:

- Do not cause sparks by touching the battery terminals with tools.
- Do not smoke or light a match near the battery.
- Avoid contact with eyes, skin and clothes.
- Never inhale or swallow electrolyte.
- Wear protective safety glasses when working near the battery.
- Keep children away from the battery.

■ Where to safely charge the battery

Always charge the battery in an open area. Do not charge the battery in a garage or closed room where there is insufficient ventilation.

■ How to recharge the battery

Only perform a slow charge (5 A or less). The battery may explode if charged at a quicker rate.

■ Emergency measures regarding electrolyte

- If electrolyte gets in your eyes

Flush your eyes with clean water for at least 15 minutes and get immediate medical attention. If possible, continue to apply water with a sponge or cloth while traveling to the nearest medical facility.

- If electrolyte gets on your skin

Wash the affected area thoroughly. If you feel pain or burning, get medical attention immediately.

- If electrolyte gets on your clothes

It can soak through clothing on to your skin. Immediately take off the clothing and follow the procedure above if necessary.

- If you accidentally swallow electrolyte

Drink a large quantity of water or milk. Get emergency medical attention immediately.

NOTICE

■ When recharging the battery

Never recharge the battery while the engine is running. Also, be sure all accessories are turned off.

Adding the washer fluid

If any washer does not work or the warning message appears on the multi-information display, the washer tank may be empty. Add washer fluid.

- ▶ RC350/RC300 AWD

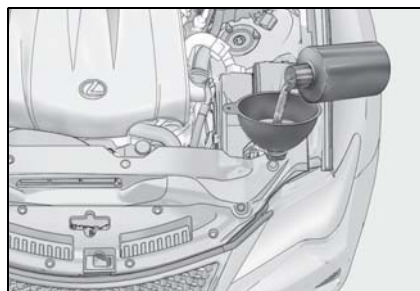

▶ RC300

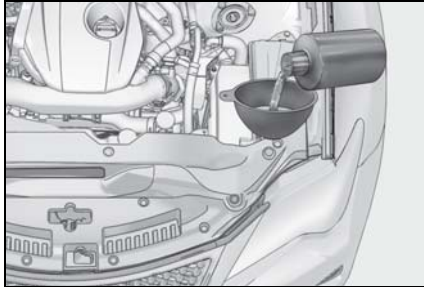

⚠ WARNING

■ **When adding washer fluid**

Do not add washer fluid when the engine is hot or running as washer fluid contains alcohol and may catch fire if spilled on the engine, etc.

⚠ NOTICE

■ **Do not use any fluid other than washer fluid**

Do not use soapy water or engine anti-freeze instead of washer fluid.

Doing so may cause streaking on the vehicle's painted surfaces, as well as damaging the pump leading to problems of the washer fluid not spraying.

■ **Diluting washer fluid**

Dilute washer fluid with water as necessary.

Refer to the freezing temperatures listed on the label of the washer fluid bottle.

Tires

Replace or rotate tires in accordance with maintenance schedules and treadwear.

Checking tires

Check if the treadwear indicators are showing on the tires. Also check the tires for uneven wear, such as excessive wear on one side of the tread.

Check the spare tire condition and pressure if not rotated.

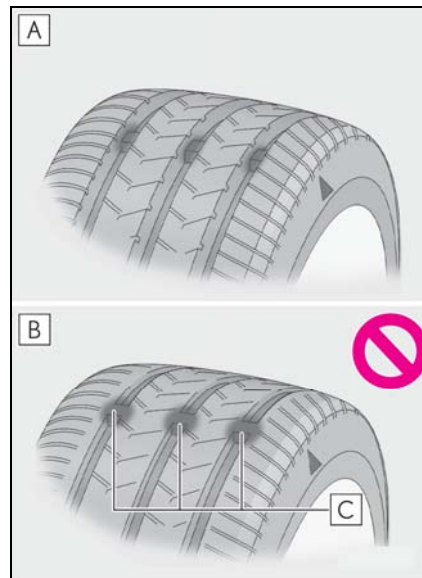

A New tread

B Worn tread

C Treadwear indicator

The location of treadwear indicators is shown by a "TWI" or "△" mark, etc., molded into the sidewall of each tire. Replace the tires if the treadwear indicators are showing on a tire.

■ When to replace your vehicle's tires

Tires should be replaced if:

- The treadwear indicators are showing on a tire.
- You have tire damage such as cuts, splits, cracks deep enough to expose the fabric, and bulges indicating internal damage
- A tire goes flat repeatedly or cannot be properly repaired due to the size or location of a cut or other damage

If you are not sure, consult your Lexus dealer.

■ Tire life

Any tire over 6 years old must be checked by a qualified technician even if it has seldom or never been used or damage is not obvious.

■ Low profile tires

Generally, low profile tires will wear more rapidly and tire grip performance will be reduced on snowy and/or icy roads when compared to standard tires. Be sure to use snow tires or tire chains on snowy and/or icy roads and drive carefully at a speed appropriate for road and weather conditions.

■ Maximum load of tire

Check that the maximum load of the replacement tire is greater than 1/2 of the Gross Axle Weight Ratings (GAWR) of either the front axle or the rear axle, whichever is greater.

For the GAWR, see the Certification Label. For the maximum load of the tire, see the load limit at maximum cold tire inflation pressure mentioned on the sidewall of the tire. (→P.341)

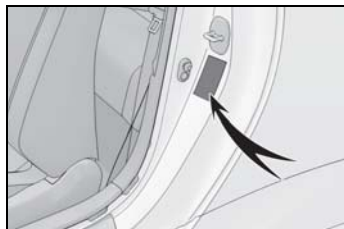

■ Tire types

- Summer tires

Summer tires are high-speed performance tires best suited to highway driving under dry conditions. Since summer tires do not have the same traction performance as snow tires, summer tires are inadequate for driving on snow-covered or icy roads. For driving on snow-covered roads or icy roads, the use of snow tires is recommended. When installing snow tires, be sure to replace all four tires.

- All season tires

All season tires are designed to provide better traction in snow and to be adequate for driving in most winter conditions as well as for use year-round. All season tires, however, do not have adequate traction performance compared with snow tires in heavy or loose snow. Also, all season tires fall short in acceleration and handling performance compared with summer tires in highway driving.

- Snow tires

For driving on snow-covered roads or icy roads, we recommend using snow tires. If you need snow tires, select tires of the same size, construction and load capacity as the originally installed tires. Since your vehicle has radial tires as original equipment, make sure your snow tires also have radial construction. Do not install studded tires without first checking local regulations for possible restrictions. Snow tires should be installed on all wheels. (→P.205)

■ If the tread on snow tires wears down below 0.16 in. (4 mm)

The effectiveness of the tires as snow tires is lost.

⚠ WARNING**■ When inspecting or replacing tires**

Observe the following precautions to prevent accidents. Failure to do so may cause damage to parts of the drivetrain as well as dangerous handling characteristics, which may lead to an accident resulting in death or serious injury.

- Do not mix tires of different makes, models or tread patterns. Also, do not mix tires of remarkably different treadwear.
- Do not use tire sizes other than those recommended by Lexus.
- Do not mix differently constructed tires (radial, bias-belted or bias-ply tires).
- Do not mix summer, all season and snow tires.
- Do not use tires that have been used on another vehicle. Do not use tires if you do not know how they were used previously.
- Do not tow if your vehicle has a compact spare tire installed.

⚠ NOTICE**■ Low profile tires**

Low profile tires may cause greater damage than usual to the tire wheel when sustaining impact from the road surface. Therefore, pay attention to the following:

- Be sure to use proper tire inflation pressure. If tires are under-inflated, they may be damaged more severely.
- Avoid potholes, uneven pavement, curbs and other road hazards. Failure to do so may lead to severe tire and wheel damage.

■ If tire inflation pressure of each tire becomes low while driving

Do not continue driving, or your tires and/or wheels may be ruined.

■ Driving on rough roads

Take particular care when driving on roads with loose surfaces or potholes. These conditions may cause losses in tire inflation pressure, reducing the cushioning ability of the tires. In addition, driving on rough roads may cause damage to the tires themselves, as well as the vehicle's wheels and body.

Tire rotation

- ▶ Vehicles with front and rear tires of the same size

Rotate the tires in the order shown.

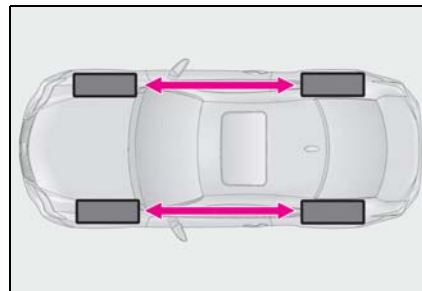

To equalize tire wear and extend tire life, Lexus recommends that tire rotation is carried out at the same interval as tire inspection.

Do not fail to initialize the tire pressure warning system after tire rotation.

- ▶ Vehicles with front and rear tires of differing sizes

Tires cannot be rotated.

■ When rotating the tires

Make sure that the engine switch is off. If the tires are rotated while the engine switch is in IGNITION ON mode, the tire position

information will not be updated. If this accidentally occurs, either turn the engine switch to off and then to IGNITION ON mode, or initialize the system after checking that the tire pressure is properly adjusted.

Tire pressure warning system

Your vehicle is equipped with a tire pressure warning system that uses tire pressure warning valves and transmitters to detect low tire inflation pressure before serious problems arise.

- The tire pressure detected by the tire pressure warning system can be displayed on the multi-information display. (→P.71)

The illustration used is intended as an example, and may differ from the image that is actually displayed on the multi-information display.

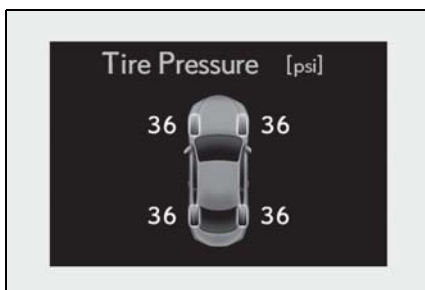

- If the tire pressure drops below a predetermined level, the driver is warned by a screen display and a warning light. (→P.300)

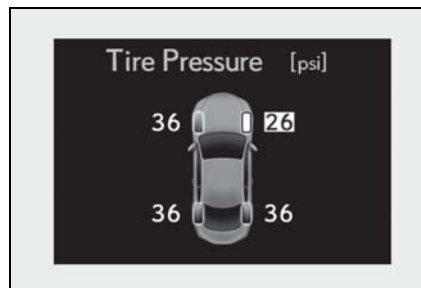

Routine tire inflation pressure checks

The tire pressure warning system does not replace routine tire inflation pressure checks. Make sure to check tire inflation pressure as part of your routine of daily vehicle checks.

Tire inflation pressure

- It may take a few minutes to display the tire inflation pressure after the engine switch is turned to IGNITION ON mode. It may also take a few minutes to display the tire inflation pressure after inflation pressure has been adjusted.
- Tire inflation pressure changes with temperature. The displayed values may also be different from the values measured using a tire pressure gauge.

Situations in which the tire pressure warning system may not operate properly

- In the following cases, the tire pressure warning system may not operate properly.
 - If non-genuine Lexus wheels are used.
 - A tire has been replaced with a tire that is not an OE (Original Equipment) tire.
 - A tire has been replaced with a tire that is not of the specified size.
 - Tire chains, etc. are equipped.
 - An auxiliary-supported run-flat tire is equipped.
 - If a window tint that affects the radio wave signals is installed.
 - If there is a lot of snow or ice on the vehicle, particularly around the wheels or wheel housings.
 - If the tire inflation pressure is extremely higher than the specified level.
 - If tires not equipped with tire pressure

- warning valves and transmitters are used.
- If the ID code on the tire pressure warning valves and transmitters is not registered in the tire pressure warning computer.
 - Performance may be affected in the following situations.
 - Near a TV tower, electric power plant, gas station, radio station, large display, airport or other facility that generates strong radio waves or electrical noise
 - When carrying a portable radio, cellular phone, cordless phone or other wireless communication device

If tire position information is not correctly displayed due to the radio wave conditions, the display may be corrected by driving and changing the radio wave conditions.

- When the vehicle is parked, the time taken for the warning to start or go off could be extended.
- When tire inflation pressure declines rapidly for example when a tire has burst, the warning may not function.

Installing tire pressure warning valves and transmitters

When replacing the tires or wheels, the tire pressure warning valve and transmitters must be installed to the wheels which will be installed to the vehicle.

When new tire pressure warning valves and transmitters are installed, new ID codes must be registered in the tire pressure warning computer and the tire pressure warning system must be initialized. (→P.271)

■ Replacing tires and wheels

If the ID code of the tire pressure warning valve and transmitter is not registered, the tire pressure warning system will not work properly. After driving for about 20 minutes, the tire pressure warning light blinks for 1 minute and stays on to indicate a sys-

tem malfunction.

NOTICE

- **Repairing or replacing tires, wheels, tire pressure warning valves, transmitters and tire valve caps**
- When removing or fitting the wheels, tires or the tire pressure warning valves and transmitters, contact your Lexus dealer as the tire pressure warning valves and transmitters may be damaged if not handled correctly.
- Make sure to install the tire valve caps. If the tire valve caps are not installed, water could enter the tire pressure warning valves and the tire pressure warning valves could be bound.
- When replacing tire valve caps, do not use tire valve caps other than those specified. The cap may become stuck.
- **To avoid damage to the tire pressure warning valves and transmitters**

When a tire is repaired with liquid sealants, the tire pressure warning valve and transmitter may not operate properly. If a liquid sealant is used, contact your Lexus dealer or other qualified service shop as soon as possible. After use of liquid sealant, make sure to replace the tire pressure warning valve and transmitter when repairing or replacing the tire. (→P.269)

Initializing the tire pressure warning system

- **The tire pressure warning system must be initialized in the following circumstances:**
- When rotating the tires.
- When the tire inflation pressure is changed such as when changing traveling speed or load weight.
- When changing the tire size.

When the tire pressure warning system is initialized, the current tire inflation pressure is set as the benchmark pressure.

■ How to initialize the tire pressure warning system

- 1 Park the vehicle in a safe place, turn the engine switch off and wait 20 minutes or more.

Initialization cannot be performed while the vehicle is moving.

- 2 Adjust the tire inflation pressure to the specified cold tire inflation pressure level.

Make sure to adjust the tire pressure to the specified cold tire inflation pressure level. The tire pressure warning system will operate based on this pressure level.

- 3 Start the engine. (→P.127)
- 4 Press and hold the tire pressure warning reset switch until the tire pressure warning light blinks slowly 3 times.

Then a message will be displayed on the multi-information display.

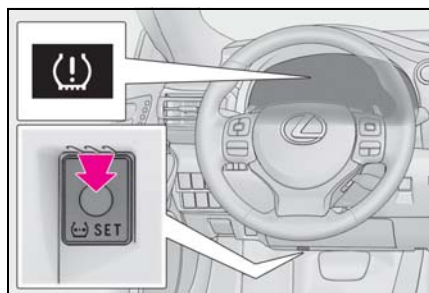

- 5 Drive straight (with occasional left and right turns) at approximately 25 mph (40 km/h) or more for approximately 10 to 30 minutes.

Initialization is complete when the position of each tire is determined and the inflation

pressure of each tire is displayed on the multi-information display.

■ Initialization procedure

- Make sure to carry out initialization after adjusting the tire inflation pressure. Also, make sure the tires are cold before carrying out initialization or tire inflation pressure adjustment.
- If you have accidentally turned the engine switch off during initialization, it is not necessary to press the reset switch again as initialization will restart automatically when the engine switch has been turned to IGNITION ON mode for the next time.
- If you accidentally press the reset switch when initialization is not necessary, adjust the tire inflation pressure to the specified level when the tires are cold, and conduct initialization again.

■ If the tire pressure warning system is not initialized properly

- In the following situations, initialization may take longer than usual to be completed or may not be possible. (Usually, the vehicle will need to be driven for approximately 10 to 30 minutes to complete initialization.) If initialization is not complete after driving approximately 30 minutes, continue driving for a while.
 - If the vehicle is driven on an unpaved road, it may take longer to complete initialization.
 - If the vehicle is backed up while performing initialization, data collected during initialization will be cleared and it will take longer than normal to complete.
 - If the vehicle is driven in heavy traffic or another situation where other vehicles are driven close by, it may take time for the system to recognize the tire pressure warning valve and transmitters of your vehicle over those of other vehicles.

If initialization is not complete after driving for approximately 1 hour, park the vehicle in a safe place for approximately 20 minutes and then drive the vehicle again.

- In the following situations, initialization will not be started or was not completed properly and the system will not operate

properly. Perform the initialization procedure again.

- If, when attempting to start initialization, the tire pressure warning light does not blink 3 times.
- If, when the vehicle has been driven for about 20 minutes after performing initialization, the tire pressure warning light blinks for approximately 1 minute and then illuminates.
- If initialization cannot be completed after performing the above procedure, contact your Lexus dealer.

! WARNING

■ When initializing the tire pressure warning system

Do not operate the tire pressure warning reset switch without first adjusting the tire inflation pressure to the specified level. Otherwise, the tire pressure warning light may not come on even if the tire inflation pressure is low, or it may come on when the tire inflation pressure is actually normal.

Registering ID codes

Every tire pressure warning valve and transmitter has a unique ID code. When replacing a tire pressure warning valve and transmitter, it is necessary to register the ID codes.

- 1 Park the vehicle in a safe place, turn the engine switch off, wait 20 minutes or more, and then start the engine.
- 2 Start the engine. (→P.127)
- 3 Press the tire pressure warning reset switch 3 times quickly.

The tire pressure warning light will blink slowly 3 times.

Sensor registration mode will be entered and ID codes registration will begin.

A message will be displayed on the multi-information display and “- -” will be displayed for the tire inflation pressure of each tire.

After this, the tire pressure warning light will blink for 1 minute and then illuminate.

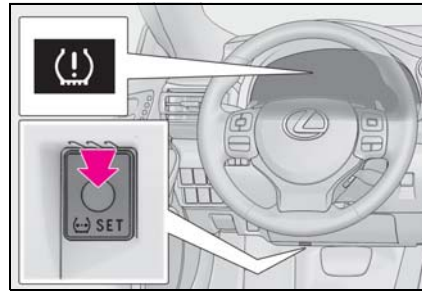

- 4 Wait approximately 2 minutes.

If the ID codes are already registered, the tire pressure warning light will turn off.

- ▶ If the tire pressure warning light turns off
- 5 Initialize the tire pressure warning system. (→P.269)
 - ▶ If the tire pressure warning light does not turn off
 - 5 Drive at approximately 25 mph (40 km/h) or more until the tire pressure warning light turns off.
 - 6 Initialize the tire pressure warning system. (→P.270)

■ When registering ID codes

- Before performing ID code registration, make sure that no wheels with tire pressure warning valve and transmitters installed are near the vehicle.
- Make sure to initialize the tire pressure warning system after registering the ID codes. If the system is initialized before registering the ID codes, the initialized values will be invalid.
- As the tires will be warm when registration is completed, make sure to allow the tires to cool before performing initializa-

tion.

■ Canceling ID code registration

- To cancel ID code registration after it has been started, turn the engine switch off before driving the vehicle. If the vehicle is driven after ID code registration is started, to cancel registration, perform the ID code registration start procedure again and turn the engine switch off before driving.
- If ID code registration has been canceled, the tire pressure warning light will blink for approximately 1 minute when the engine switch is turned to IGNITION ON mode and then illuminate. The tire pressure warning system will be operational when the tire pressure warning light turns off.
- If the warning light does not turn off even after several minutes have elapsed, ID code registration may not have been cancelled correctly. To cancel registration, perform the ID code registration start procedure again and then turn the engine switch off before driving.

■ If ID codes are not registered properly

- In the following situations, ID code registration may take longer than usual to be completed or may not be possible. (Usually, the vehicle will need to be driven for approximately 10 to 30 minutes to complete ID code registration.) If ID code registration is not complete after driving for approximately 30 minutes, continue driving for a while.
 - If the vehicle is driven on an unpaved road, it may take longer than normal to complete registration.
 - If the vehicle is backed up while performing registration, data collected during registration will be cleared, and it will take longer than normal to complete.
 - If the vehicle is driven in heavy traffic or another situation where other vehicles are driven close by, it may take time for the system to recognize the tire pressure warning valve and transmitters of your vehicle over those of other vehicles.
 - If a wheel with a tire pressure warning valve and transmitter installed is inside or near the vehicle, registration of the ID

codes for the installed wheels may not be possible.

If ID registration is not complete after driving for approximately 1 hour, park the vehicle in a safe place for approximately 20 minutes and then perform the ID code registration procedure again.

- In the following situations, ID code registration will not be started or was not completed properly and the system will not operate properly. Perform the ID code registration procedure again.
 - If, when attempting to start ID code registration, the tire pressure warning light does not blink slowly 3 times.
 - If, when the vehicle has been driven for about 20 minutes after performing ID code registration, the tire pressure warning light blinks for approximately 1 minute and then illuminates.
- If ID code registration cannot be completed after performing the above procedure, contact your Lexus dealer.

Tire inflation pressure**Checking the specified tire inflation pressure**

The recommended cold tire inflation pressure and tire size are displayed on the tire and loading information label. (→P.334)

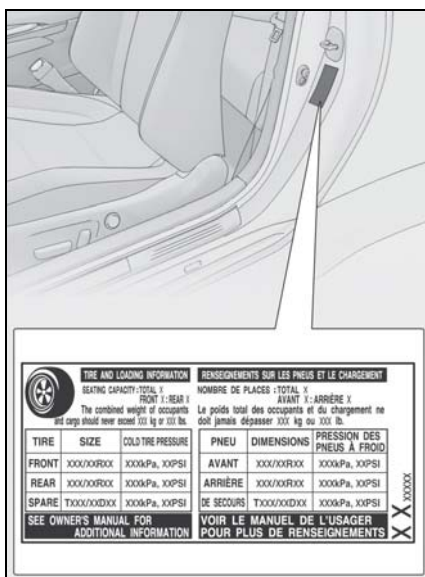
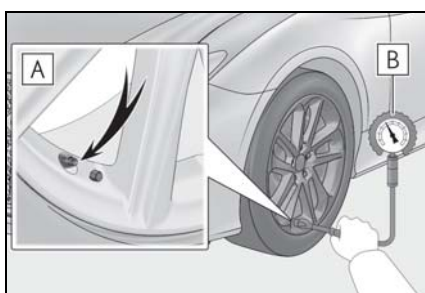
**Inspection and adjustment procedure**

- A** Tire valve
B Tire pressure gauge

- 1 Remove the tire valve cap.
- 2 Press the tip of the tire pressure gauge onto the tire valve.
- 3 Read the pressure using the gauge gradations.
- 4 If the tire inflation pressure is not at the recommended level, adjust the pressure.
If you add too much air, press the center of the valve to deflate.
- 5 After completing the tire inflation pressure measurement and adjustment, apply soapy water to the valve and check for leakage.
- 6 Put the tire valve cap back on.

■ Tire inflation pressure check interval

You should check tire inflation pressure every two weeks, or at least once a month. Do not forget to check the spare.

■ Effects of incorrect tire inflation pressure

Driving with incorrect tire inflation pressure may result in the following:

- Reduced fuel economy
- Reduced driving comfort and poor handling
- Reduced tire life due to wear
- Reduced safety
- Damage to the drivetrain

If a tire needs frequent inflating, have it checked by your Lexus dealer.

■ Instructions for checking tire inflation pressure

When checking tire inflation pressure, observe the following:

- Check only when the tires are cold.
If your vehicle has been parked for at least 3 hours or has not been driven for more than 1 mile or 1.5 km, you will get an accurate cold tire inflation pressure read-

ing.

- Always use a tire pressure gauge. It is difficult to judge if a tire is properly inflated based only on its appearance.
- It is normal for the tire inflation pressure to be higher after driving as heat is generated in the tire. Do not reduce tire inflation pressure after driving.
- Never exceed the vehicle capacity weight. Passengers and luggage weight should be placed so that the vehicle is balanced.

 **WARNING**

■ **Proper inflation is critical to save tire performance**

Keep your tires properly inflated. If the tires are not properly inflated, the following conditions may occur which could lead to an accident resulting in death or serious injury:

- Excessive wear
- Uneven wear
- Poor handling
- Possibility of blowouts resulting from overheated tires
- Air leaking from between tire and wheel
- Wheel deformation and/or tire damage
- Greater possibility of tire damage while driving (due to road hazards, expansion joints, sharp edges on the road, etc.)

 **NOTICE**

■ **When inspecting and adjusting tire inflation pressure**

Be sure to put the tire valve caps back on. If a valve cap is not installed, dirt or moisture may get into the valve and cause an air leak, resulting in decreased tire inflation pressure.

Wheels

If a wheel is bent, cracked or heavily corroded, it should be replaced. Otherwise, the tire may separate from the wheel or cause a loss of handling control.

Wheel selection

When replacing wheels, care should be taken to ensure that they are equivalent to those removed in load capacity, diameter, rim width and inset*.

Replacement wheels are available at your Lexus dealer.

*: Conventionally referred to as offset.

Lexus does not recommend using the following:

- Wheels of different sizes or types
- Used wheels
- Bent wheels that have been straightened

■ **When replacing wheels**

The wheels of your vehicle are equipped with tire pressure warning valves and transmitters that allow the tire pressure warning system to provide advance warning in the event of a loss in tire inflation pressure. Whenever wheels are replaced, tire pressure warning valves and transmitters must be installed. (→P.269)

 **WARNING**

■ **When replacing wheels**

- Do not use wheels that are a different size from those recommended in the Owner's Manual, as this may result in a loss of handling control.

⚠ WARNING

- Never use an inner tube in a leaking wheel which is designed for a tubeless tire. Doing so may result in an accident, causing death or serious injury.

⚠ NOTICE

■ **Replacing tire pressure warning valves and transmitters**

- Because tire repair or replacement may affect the tire pressure warning valves and transmitters, make sure to have tires serviced by your Lexus dealer or other qualified service shop. In addition, make sure to purchase your tire pressure warning valves and transmitters at your Lexus dealer.
- Ensure that only genuine Lexus wheels are used on your vehicle. Tire pressure warning valves and transmitters may not work properly with non-genuine wheels.

Aluminum wheel precautions

- Use only Lexus wheel nuts and wrenches designed for use with your aluminum wheels.
- When rotating, repairing or changing your tires, check that the wheel nuts are still tight after driving 1000 miles (1600 km).
- Be careful not to damage the aluminum wheels when using tire chains.
- Use only Lexus genuine balance weights or equivalent and a plastic or rubber hammer when balancing your wheels.

Air conditioning filter

The air conditioning filter must be changed regularly to maintain air conditioning efficiency.

Removing the air conditioning filter

- 1 Turn the engine switch off.
- 2 Open the glove box. Lift up the side with the stay, disconnect the stay tabs and remove the partition by pulling horizontally.

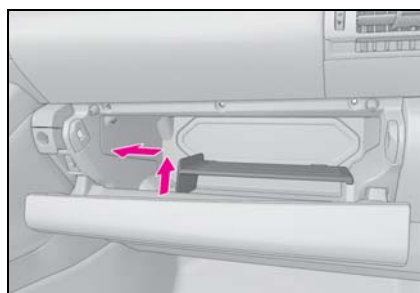

- 3 Press the tabs and remove the filter cover.

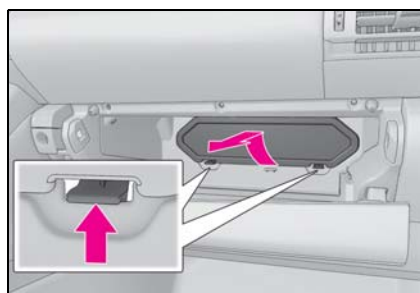

- 4 Press the tabs and remove the filter case.

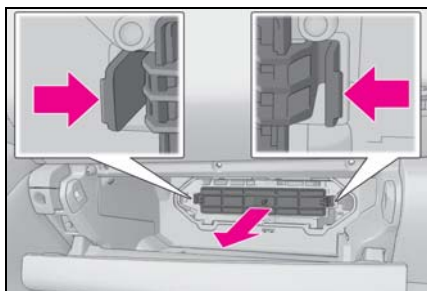

- 5 Remove the air conditioning filter from the filter case and replace it with a new one.

The “↑ UP” marks shown on the filter and the filter case should be pointing up.

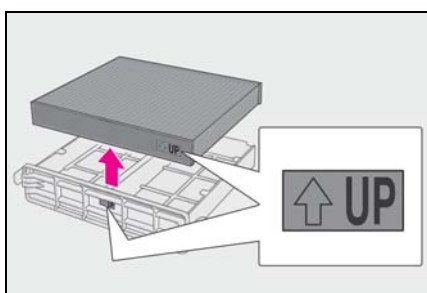

When an air conditioning odor comes out continuously, replace the air conditioning filter.

 NOTICE

When using the air conditioning system

Make sure that a filter is always installed. Using the air conditioning system without a filter may cause damage to the system.

■ **Checking interval**

Inspect and replace the air conditioning filter according to the maintenance schedule. In dusty areas or areas with heavy traffic flow, early replacement may be required. (For scheduled maintenance information, please refer to the “Owner’s Manual Supplement” or “Scheduled Maintenance.”)

■ **If air flow from the vents decreases dramatically**

The filter may be clogged. Check the filter and replace if necessary.

■ **Air conditioning filter with deodorizing function**

When fragrances are placed in your vehicle, the deodorizing effect may become significantly weakened in a short period.

Electronic key battery

Replace the battery with a new one if it is depleted.

As the key may be damaged if the following procedure is not performed properly, it is recommended that key battery replacement be performed by your Lexus dealer.

■ If the electronic key battery is depleted

The following symptoms may occur:

- The smart access system with push-button start and wireless remote control will not function properly.
- The operational range will be reduced.

■ When the card key battery needs to be replaced (if equipped)

The battery for the card key is available only at Lexus dealers. Your Lexus dealer can replace the battery for you.

Items to prepare

- Flathead screwdriver
- Small flathead screwdriver
- Lithium battery CR2032

■ Use a CR2032 lithium battery

- Batteries can be purchased at your Lexus dealer, local electrical appliance shops or camera stores.
- Replace only with the same or equivalent type recommended by the manufacturer.
- Dispose of used batteries according to local laws.

Replacing the battery

- 1 Take out the mechanical key.

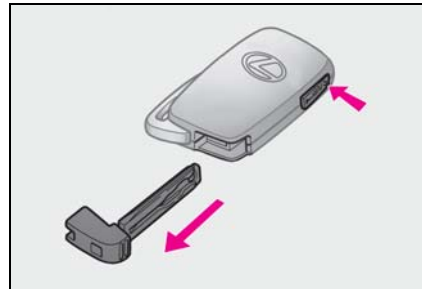

- 2 Remove the cover.

To prevent damage to the key, wrap the tip of the screwdriver with tape.

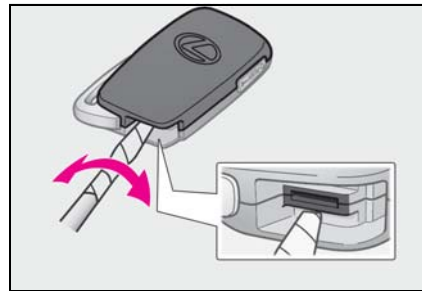

- 3 Remove the depleted battery.

Insert a new battery with the "+" terminal facing up.

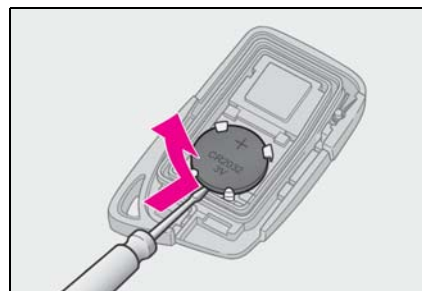

⚠ WARNING

■ Battery precautions

Observe the following precautions. Failure to do so may result in death or serious injury.

⚠ WARNING

- Do not swallow the battery. Doing so may cause chemical burns.
- A coin battery or button battery is used in the electronic key. If a battery is swallowed, it may cause severe chemical burns in as little as 2 hours and may result in death or serious injury.
- Keep away new and removed batteries from children.
- If the cover cannot be firmly closed, stop using the electronic key and stow the key in the place where children cannot reach, and then contact your Lexus dealer.
- If you accidentally swallow a battery or put a battery into a part of your body, get emergency medical attention immediately.
- **To prevent battery explosion or leakage of flammable liquid or gas**
- Replace the battery with a new battery of the same type. If a wrong type of battery is used, it may explode.
- Do not expose batteries to extremely low pressure due to high altitude or extremely high temperatures.
- Do not burn, break or cut a battery.

⚠ NOTICE

- **For normal operation after replacing the battery**
- Observe the following precautions to prevent accidents:
 - Always work with dry hands. Moisture may cause the battery to rust.
 - Do not touch or move any other component inside the remote control.
 - Do not bend either of the battery terminals.

Checking and replacing fuses

If any of the electrical components do not operate, a fuse may have blown. If this happens, check and replace the fuses as necessary.

Checking and replacing fuses

- 1 Turn the engine switch off.
- 2 Open the fuse box cover.
 - ▶ Engine compartment: type A fuse box

Push the tab in and lift the lid off.

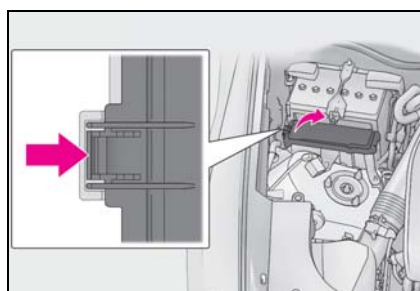

- ▶ Engine compartment: type B fuse box

Push the tab in and lift the lid off.

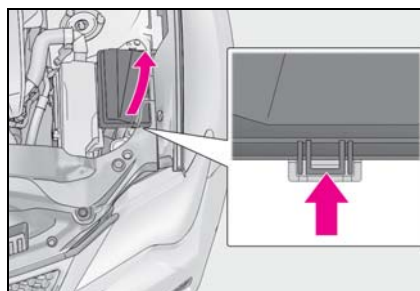

- ▶ Left side instrument panel

Remove the lid.

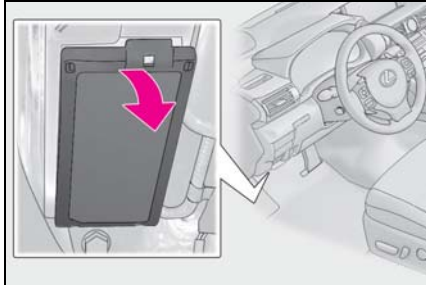

3 Remove the fuse with the pullout tool.

Only type A fuses can be removed using the pullout tool.

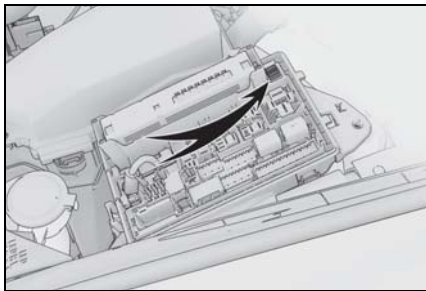

4 Check if the fuse is blown.

Type A and B:
Replace the blown fuse with a new fuse of an appropriate amperage rating. The amperage rating can be found on the fuse box lid.

Type C and D:
Contact your Lexus dealer.

► Type A

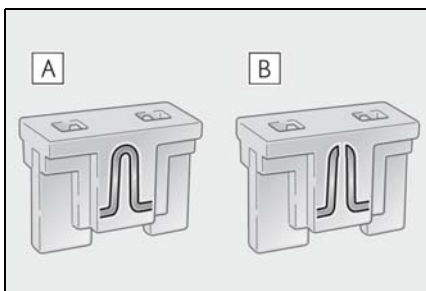

A Normal fuse
B Blown fuse

► Type B

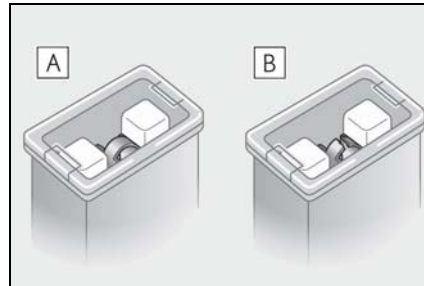

A Normal fuse
B Blown fuse

► Type C

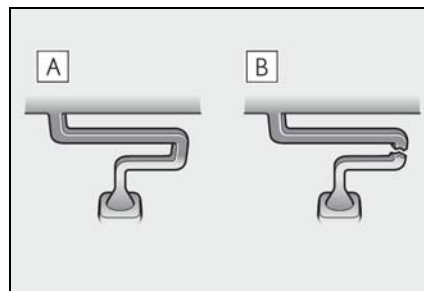

A Normal fuse
B Blown fuse

► Type D

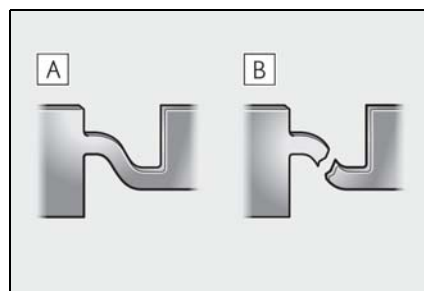

A Normal fuse
B Blown fuse

■ After a fuse is replaced

● If the lights do not turn on even after the

fuse has been replaced, a bulb may need replacement.

- If the replaced fuse blows again, have the vehicle inspected by your Lexus dealer.

■ **If there is an overload in a circuit**

The fuses are designed to blow, protecting the wiring harness from damage.

■ **When replacing light bulbs**

Lexus recommends that you use genuine Lexus products designed for this vehicle. Because certain bulbs are connected to circuits designed to prevent overload, non-genuine parts or parts not designed for this vehicle may be unusable.

⚠ WARNING

■ **To prevent system breakdowns and vehicle fire**

Observe the following precautions. Failure to do so may cause damage to the vehicle, and possibly a fire or injury.

- Never use a fuse of a higher amperage rating than that indicated, or use any other object in place of a fuse.
- Always use a genuine Lexus fuse or equivalent. Never replace a fuse with a wire, even as a temporary fix.
- Do not modify the fuses or fuse boxes.

⚠ NOTICE

■ **Before replacing fuses**

Have the cause of electrical overload determined and repaired by your Lexus dealer as soon as possible.

Headlight aim

Vertical movement adjusting bolts

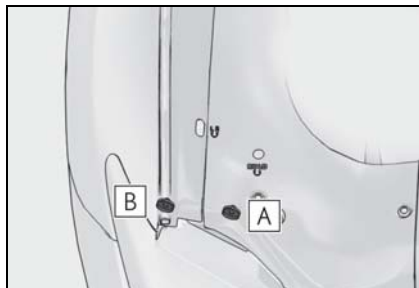

A Adjustment bolt A

B Adjustment bolt B

Before checking the headlight aim

- Make sure the vehicle has a full tank of gasoline and the area around the headlight is not deformed.
- Park the vehicle on level ground.
- Make sure the tire inflation pressure is at the specified level.
- Have someone sit in the driver's seat.
- Bounce the vehicle several times.

Adjusting the headlight aim

- 1 Using a Phillips-head screwdriver, turn bolt A in either direction.

Remember the turning direction and the

number of turns.

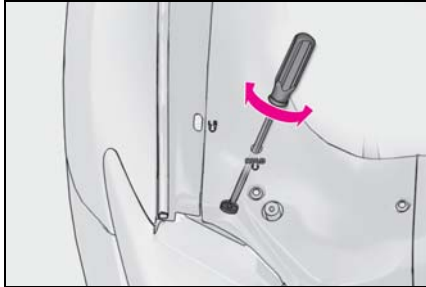

- 2** Turn bolt B the same number of turns and in the same direction as step 1.

If the headlight cannot be adjusted using this procedure, take the vehicle to your Lexus dealer to adjust the headlight aim.

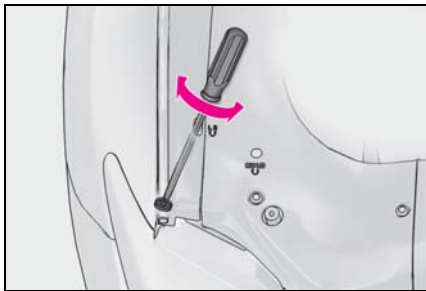

Light bulbs

You may replace the following bulbs by yourself. The difficulty level of replacement varies depending on the bulb. If necessary bulb replacement seems difficult to perform, contact your Lexus dealer.

For more information about replacing other light bulbs, contact your Lexus dealer.

Preparing for light bulb replacement

Check the wattage of the light bulb to be replaced. (→P.338)

Bulb locations

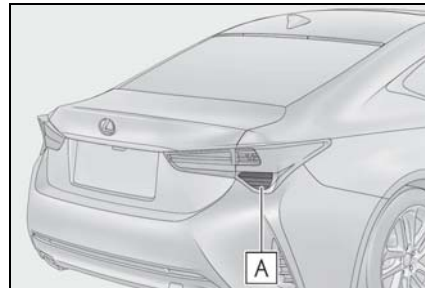

A Rear turn signal light

■ Bulbs that need to be replaced by your Lexus dealer

- Headlights
- Parking lights and daytime running lights
- Front turn signal lights
- Cornering lights
- Side marker lights

- Side turn signal lights
- Stop/tail lights
- Back-up light
- High mounted stoplight
- License plate lights

■ LED light bulbs

The lights other than the rear turn signal lights each consist of a number of LEDs. If any of the LEDs burn out, take your vehicle to your Lexus dealer to have the light replaced.

■ Condensation build-up on the inside of the lens

Temporary condensation build-up on the inside of the headlight lens does not indicate a malfunction. Contact your Lexus dealer for more information in the following situations:

- Large drops of water have built up on the inside of the lens.
- Water has built up inside the headlight.

■ When replacing light bulbs

→P.280

Replacing light bulbs

■ Rear turn signal lights

- 1 Open the trunk and apply protective tape to the peripheral of the taillight and the vehicle body around the taillight.

Use masking tape, etc. Do not use duct tape, as it may leave residue or damage the

paint when removed.

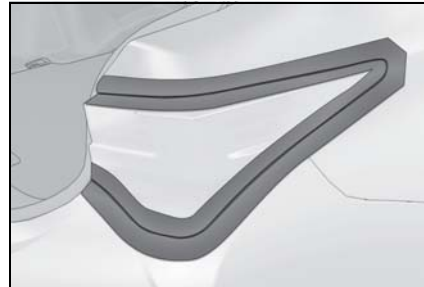

- 2 Using a flathead screwdriver, remove the cover.

To prevent scratching the vehicle, wrap the tip of the flathead screwdriver with a cloth, etc.

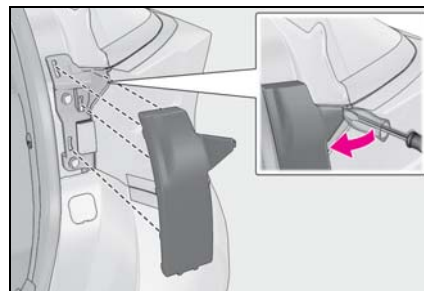

- 3 Remove the 2 screws.

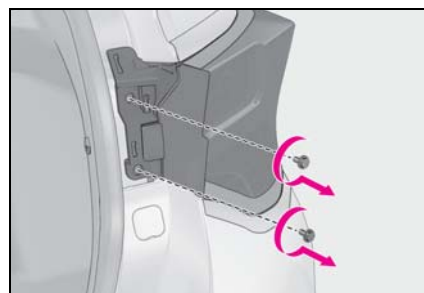

- 4** Pull the light unit toward the rear of the vehicle to remove it.

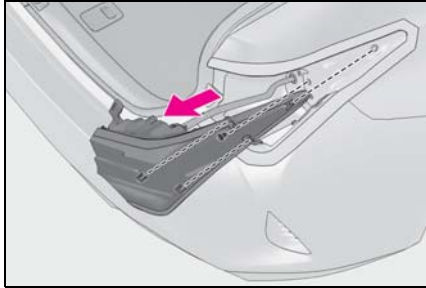

- 5** Turn the bulb base counterclockwise.

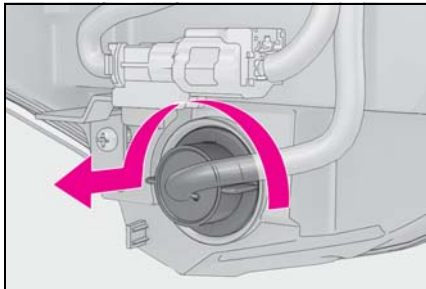

- 6** Remove the light bulb.

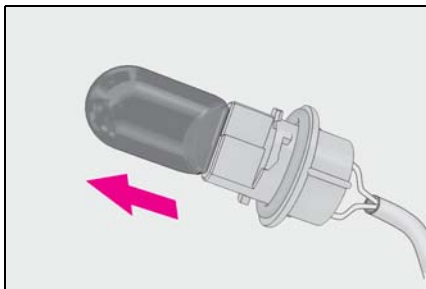

- 7** Install a new light bulb then install the bulb base to the light unit by inserting it and turning the bulb base clockwise.

After installing the light bulb, turn on the rear turn signal light to visually check that

there is no light leaking from the bulb base.

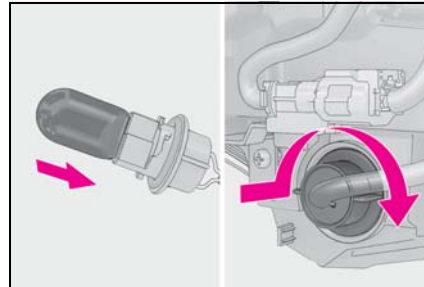

- 8** Align the tabs and push the light unit toward the front of the vehicle to install it.

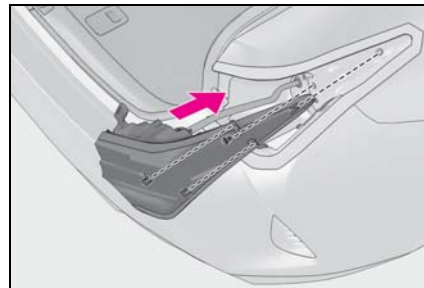

- 9** Install the 2 screws and cover.

- 10** Remove the protective tape.

⚠ WARNING

■ Replacing light bulbs

- Turn off the lights. Do not attempt to replace the bulb immediately after turning off the lights. The bulbs become very hot and may cause burns.
- Do not touch the glass portion of the light bulb with bare hands. When it is unavoidable to hold the glass portion, use and hold with a clean dry cloth to avoid getting moisture and oils on the bulb. Also, if the bulb is scratched or dropped, it may blow out or crack.

**WARNING**

- Fully install light bulbs and any parts used to secure them. Failure to do so may result in heat damage, fire, or water entering the light unit. This may damage the lights or cause condensation to build up on the lens.
- **To prevent damage or fire**
- Make sure bulbs are fully seated and locked.
- Check the wattage of the bulb before installing to prevent heat damage.

When trouble arises

7

7-1. Essential information

Emergency flashers.....286

If your vehicle has to be stopped in
an emergency.....286

If the vehicle is trapped in rising
water.....287

7-2. Steps to take in an emergency

If your vehicle needs to be towed
.....289

If you think something is wrong
.....293

Fuel pump shut off system294

If a warning light turns on or a
warning buzzer sounds295

If a warning message is displayed
.....303

If you have a flat tire.....307

If the engine will not start314

If you lose your keys.....316

If the fuel filler door cannot be
opened.....316

If the electronic key does not
operate properly317

If the vehicle battery is discharged
.....319

If your vehicle overheats322

If the vehicle becomes stuck
.....326

Emergency flashers

The emergency flashers are used to warn other drivers when the vehicle has to be stopped on the road due to a breakdown, etc.

Operating instructions

Press the switch to flash all of the turn signal lights.

To turn them off, press the switch once again.

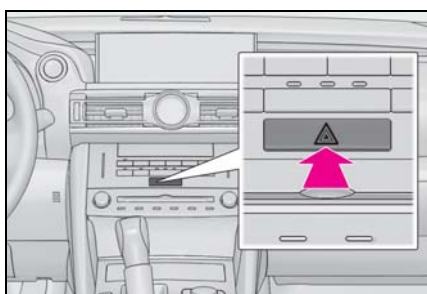

■ Emergency flashers

If the emergency flashers are used for a long time while the engine is not operating, the battery may discharge.

If your vehicle has to be stopped in an emergency

Only in an emergency, such as if it becomes impossible to stop the vehicle in the normal way, stop the vehicle using the following procedure:

Stopping the vehicle

- 1 Steadily step on the brake pedal with both feet and firmly depress it.

Do not pump the brake pedal repeatedly as this will increase the effort required to slow the vehicle.

- 2 Shift the shift lever to N.
 - ▶ If the shift lever is shifted to N
- 3 After slowing down, stop the vehicle in a safe place by the road.
- 4 Stop the engine.
 - ▶ If the shift lever cannot be shifted to N
- 3 Keep depressing the brake pedal with both feet to reduce vehicle speed as much as possible.
- 4 To stop the engine, press and hold the engine switch for 2 consecutive

seconds or more, or press it briefly 3 times or more in succession.

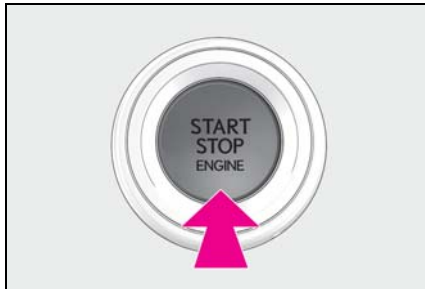

- 5** Stop the vehicle in a safe place by the road.

⚠ WARNING

■ If the engine has to be turned off while driving

Power assist for the brakes and steering wheel will be lost, making the brake pedal harder to depress and the steering wheel heavier to turn. Decelerate as much as possible before turning off the engine.

If the vehicle is trapped in rising water

In the event the vehicle is submerged in water, remain calm and perform the following.

- Remove the seat belt first.
- If the door can be opened, open the door and exit the vehicle.
- If the door can not be opened, open the window using the power window switch and exit the vehicle through the window.
- If the window can not be opened using the power window switch, remain calm, wait until the water level inside the vehicle rises to the point that the water pressure inside of the vehicle equals the water pressure outside of the vehicle, and then open the door and exit the vehicle.

⚠ WARNING

■ Using an emergency hammer* for emergency escape

The front side windows and rear window of this vehicle can be shattered by an emergency hammer* used for emergency escape. However, an emergency hammer* can not shatter the windshield as it is laminated glass.

*: Contact your Lexus dealer or after-market accessory manufacturer for further information about an emergency hammer.

**WARNING****■ Escaping the vehicle from the window**

There are cases where escaping the vehicle from the window is not possible due to seating position, passenger body type, etc.

When using an emergency hammer, consider your seat location and the size of the window opening to ensure that the opening is accessible and large enough to escape.

If your vehicle needs to be towed

If towing is necessary, we recommend having your vehicle towed by your Lexus dealer or commercial towing service, using a wheel-lift type truck or flatbed truck.

Use a safety chain system for all towing, and abide by all state/provincial and local laws.

If towing your vehicle with a wheel-lift type truck from the front, the vehicle's rear wheels and axles must be in good conditions. (→P.290)

If they are damaged, use a towing dolly or flatbed truck.

If towing your vehicle with a wheel-lift type truck, use a towing dolly. (→P.290, 289)

WARNING

Observe the following precautions. Failure to do so may result in death or serious injury.

When towing the vehicle

▶ 2WD models

Be sure to transport the vehicle with all four wheels raised off the ground. If the vehicle is towed with the tires contacting the ground, the drivetrain and related parts may be damaged or an accident may occur due to a change in direction of the vehicle.

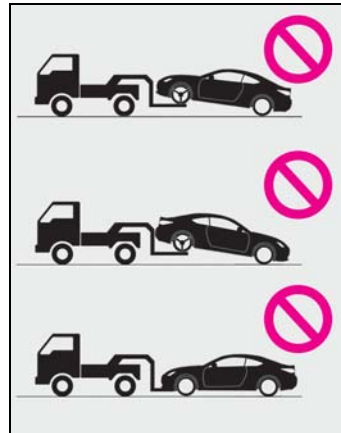

▶ AWD models

Be sure to transport the vehicle with all four wheels raised off the ground. If the vehicle is towed with the tires contacting the ground, the drivetrain or related parts may be damaged, the vehicle may fly off the truck.

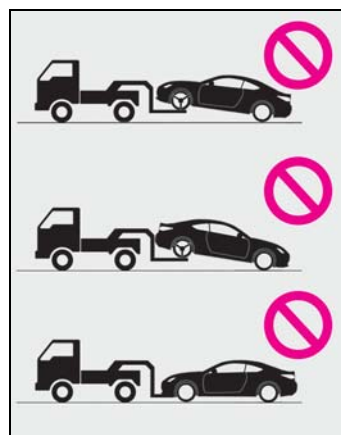

⚠ WARNING

■ **While towing**

- When towing using cables or chains, avoid sudden starts, etc. which place excessive stress on the towing eyelets, cables or chains. The towing eyelets, cables or chains may become damaged, broken debris may hit people, and cause serious damage.
- Do not turn the engine switch off. There is a possibility that the steering wheel is locked and cannot be operated.

■ **Installing towing eyelets to the vehicle**

Make sure that towing eyelets are installed securely. If not securely installed, towing eyelets may come loose during towing.

⚠ NOTICE

■ **To prevent damage to the vehicle when towing using a wheel-lift type truck**

- Do not tow the vehicle from the rear when the engine switch is off. The steering lock mechanism is not strong enough to hold the front wheels straight.
- When raising the vehicle, ensure adequate ground clearance for towing at the opposite end of the raised vehicle. Without adequate clearance, the vehicle could be damaged while being towed.

■ **To prevent damage to the vehicle when towing with a sling-type truck**

Do not tow with a sling-type truck, either from the front or rear.

■ **To prevent damage to the vehicle during emergency towing**

Do not secure cables or chains to the suspension components.

■ **Recreational towing (behind motor home, etc.)**

Never dinghy tow your vehicle to prevent causing serious damage to the AWD system and transmission. (→P.126)

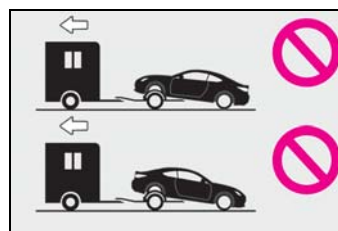

Situations when it is necessary to contact dealers before towing

The following may indicate a problem with your transmission. Contact your Lexus dealer or commercial towing service before towing.

- The engine is running but the vehicle does not move.
- The vehicle makes an abnormal sound.

Towing with a wheel-lift type truck

- ▶ From the front

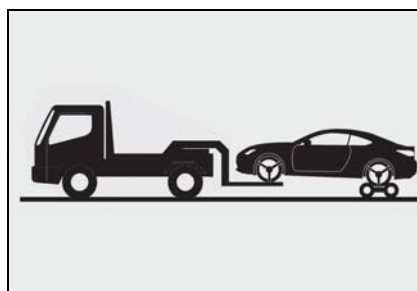

Use a towing dolly under the rear wheels.

- From the rear

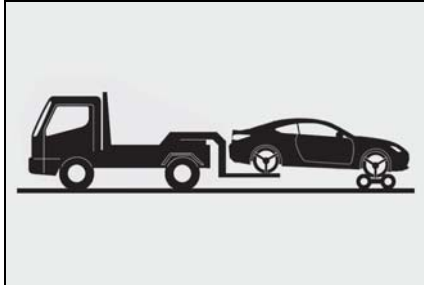

Use a towing dolly under the front wheels.



NOTICE

■ Towing with a sling-type truck

Do not tow with a sling-type truck to prevent body damage.

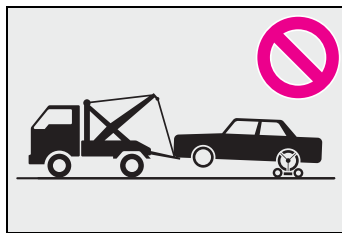

Using a flatbed truck

When using a flat-bed truck to transport the vehicle, use tire strapping belts. Refer to the owner's manual of the flat-bed truck for the tire strapping method.

In order to suppress vehicle movement during transportation, set the parking brake and turn the engine switch off.

Emergency towing

If a tow truck is not available in an emergency, your vehicle may be temporarily towed using cables or chains

secured to the emergency towing eyelets. This should only be attempted on hard surfaced roads for at most 50 miles (80 km) at under 18 mph (30 km/h).

A driver must be in the vehicle to steer and operate the brakes. The vehicle's wheels, drive train, axles, steering and brakes must be in good condition.

Emergency towing procedure

To have your vehicle towed by another vehicle, the towing eyelet must be installed to your vehicle. Install the towing eyelet using the following procedure.

- 1 Take out the wheel nut wrench, flat-head screwdriver and towing eyelet. (→P.307)
- 2 Remove the eyelet cover using a flathead screwdriver.

To protect the bodywork, place a rag between the screwdriver and the vehicle body as shown in the illustration.

- Except F SPORT models

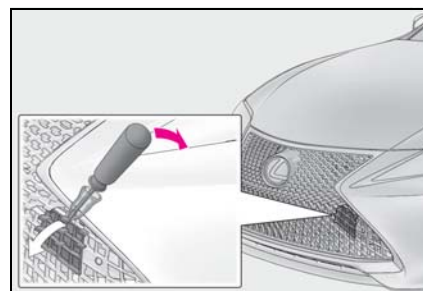

- F SPORT models

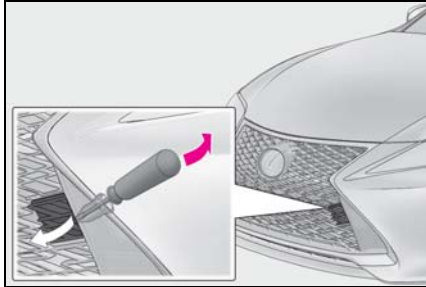

- 3** Insert the towing eyelet into the hole and tighten partially by hand.

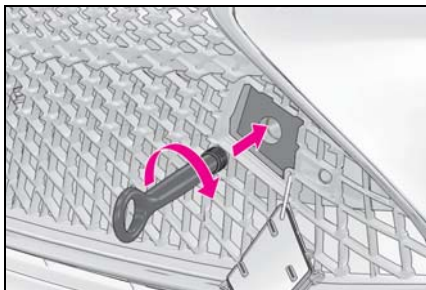

- 4** Tighten down the towing eyelet securely using a wheel nut wrench or hard metal bar.

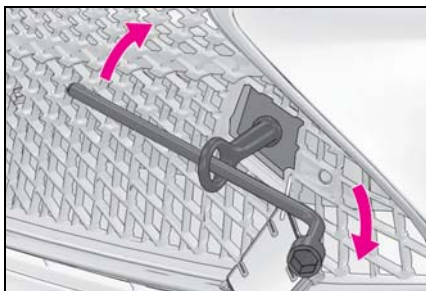

- 5** Securely attach cables or chains to the towing eyelet.
Take care not to damage the vehicle body.
- 6** Enter the vehicle being towed and start the engine.
If the engine does not start, turn the engine switch to ON.

- 7** Shift the shift lever to N and release the parking brake.

Turn automatic mode off. (→P.138)

When the shift lever cannot be shifted:
→P.132

■ **While towing**

If the engine is not running, the power assist for the brakes and steering will not function, making steering and braking more difficult.

■ **Wheel nut wrench**

Wheel nut wrench is installed in trunk.
(→P.307)

If you think something is wrong

If you notice any of the following symptoms, your vehicle probably needs adjustment or repair. Contact your Lexus dealer as soon as possible.

Visible symptoms

- Fluid leaks under the vehicle. (Water dripping from the air conditioning after use is normal.)
- Flat-looking tires or uneven tire wear
- Engine coolant temperature gauge continually points higher than normal.

Audible symptoms

- Changes in exhaust sound
- Excessive tire squeal when cornering
- Strange noises related to the suspension system
- Pinging or other noises related to the engine

Operational symptoms

- Engine missing, stumbling or running roughly
- Appreciable loss of power
- Vehicle pulls heavily to one side when braking

- Vehicle pulls heavily to one side when driving on a level road
- Loss of brake effectiveness, spongy feeling, pedal almost touches the floor

Fuel pump shut off system

To minimize the risk of fuel leakage when the engine stalls or when an airbag inflates upon collision, the fuel pump shut off system stops the supply of fuel to the engine.

Restarting the engine

Follow the procedure below to restart the engine after the system is activated.

- 1 Turn the engine switch to ACCESSORY mode or turn it off.
- 2 Restart the engine.

 NOTICE

■ **Before starting the engine**



Inspect the ground under the vehicle. If you find that fuel has leaked onto the ground, the fuel system has been damaged and is in need of repair. Do not restart the engine.

If a warning light turns on or a warning buzzer sounds

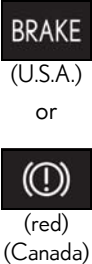

Calmly perform the following actions if any of the warning lights comes on or flashes. If a light comes on or flashes, but then goes off, this does not necessarily indicate a malfunction in the system. However, if this continues to occur, have the vehicle inspected by your Lexus dealer.

Actions to the warning lights or warning buzzers



■ Brake system warning light

Warning light	Details/Actions
 <p>BRAKE (U.S.A.) or  (red) (Canada)</p>	<p>Indicates that:</p> <ul style="list-style-type: none"> ● The brake fluid level is low; or ● The brake system is malfunctioning <p>→ Immediately stop the vehicle in a safe place and contact your Lexus dealer. Continuing to drive the vehicle may be dangerous.</p>

■ Brake system warning light

Warning light	Details/Actions
 <p> (yellow)</p>	<p>Indicates a malfunction in the parking brake system</p> <p>→ Have the vehicle inspected by your Lexus dealer immediately.</p>

■ High coolant temperature warning light* (warning buzzer)

Warning light	Details/Actions
 <p></p>	<p>Indicates that the engine coolant temperature is too high</p> <p>→ Immediately stop the vehicle in a safe place. Handling method (→P.322)</p>

*: This light illuminates on the multi-information display.

■ **Charging system warning light***

Warning light	Details/Actions
	Indicates a malfunction in the vehicle's charging system → Immediately stop the vehicle in a safe place and contact your Lexus dealer.



* : Except F SPORT models: This light illuminates on the multi-information display.
 F SPORT models: This light illuminates on the meter.

■ **Low engine oil pressure warning light* (warning buzzer)**

Warning light	Details/Actions
	Indicates that the engine oil pressure is too low → Immediately stop the vehicle in a safe place and contact your Lexus dealer.

* : This light illuminates on the multi-information display.



■ **Malfunction indicator lamp**

Warning light	Details/Actions
 (U.S.A.) or  (Canada)	Indicates a malfunction in: <ul style="list-style-type: none"> ● The electronic engine control system; ● The electronic throttle control system; or ● The electronic automatic transmission control system → Have the vehicle inspected by your Lexus dealer immediately.

■ **SRS warning light**

Warning light	Details/Actions
	Indicates a malfunction in: <ul style="list-style-type: none"> ● The SRS airbag system; ● The front passenger occupant classification system; or ● The seat belt pretensioner system → Have the vehicle inspected by your Lexus dealer immediately.

■ **ABS warning light**

Warning light	Details/Actions
 (U.S.A.) or  (Canada)	Indicates a malfunction in: <ul style="list-style-type: none"> ● The ABS; or ● The brake assist system → Have the vehicle inspected by your Lexus dealer immediately.

■ **Brake Override System warning light/Drive-Start Control warning light* (warning buzzer)**

Warning light	Details/Actions
	When a buzzer sounds: <ul style="list-style-type: none"> ● Brake Override System is malfunctioning; ● Drive-Start Control is operating; or ● Drive-Start Control is malfunctioning → Follow the instructions displayed on the multi-information display. When a buzzer does not sound: Brake Override System is operating → Release the accelerator pedal and depress the brake pedal.

*: This light illuminates on the multi-information display.

■ **Electric power steering system warning light (warning buzzer)**

Warning light	Details/Actions
	Indicates a malfunction in the EPS (Electric Power Steering) system → Have the vehicle inspected by your Lexus dealer immediately.

■ LDA (Lane Departure Alert) indicator

Warning light	Details/Actions
 <p>(orange)</p>	<p>If the LDA indicator is illuminated: Indicates a malfunction in the LDA (Lane Departure Alert with steering control) system. → Check the warning message displayed on the multi-information display. (→P.174)</p> <p>If the LDA indicator flashes: Indicates that the vehicle has deviated from the lane (while the LDA [Lane Departure Alert with steering control] system is operating) → Check the area around the vehicle and return the vehicle to between the lane lines.</p>

■ PCS warning light

Warning light	Details/Actions
 <p>(flashes or illuminates)</p>	<p>When a buzzer sounds simultaneously: Indicates a malfunction has occurred in the PCS (Pre-Collision System). → Have the vehicle inspected by your Lexus dealer immediately.</p> <p>When a buzzer does not sound: The PCS (Pre-Collision System) has become temporarily unavailable, corrective action may be necessary. → Follow the instructions displayed on the multi-information display. (→P.160, 305)</p> <p>If the PCS (Pre-Collision System) or VSC (Vehicle Stability Control) system is disabled, the PCS warning light will illuminate. → P.168</p>

■ Slip indicator

Warning light	Details/Actions
	<p>Indicates a malfunction in:</p> <ul style="list-style-type: none"> ● The VSC (Vehicle Stability Control) system; ● The TRAC (Traction Control) system; or ● The hill-start assist control system <p>The light will flash when the VSC or the TRAC system is operating. → Have the vehicle inspected by your Lexus dealer immediately.</p>

■ Open door warning light (warning buzzer)*

Warning light	Details/Actions
	Indicates that a door or the trunk is not fully closed → Check that both side doors and the trunk are closed.

*: Open door warning buzzer: →P.90

■ Low fuel level warning light

Warning light	Details/Actions
	Indicates that remaining fuel is approximately 2.6 gal. (10 L, 2.2 Imp. gal.) or less → Refuel the vehicle.

■ Driver's and front passenger's seat belt reminder light (warning buzzer)*

Warning light	Details/Actions
	Warns the driver and/or front passenger to fasten their seat belts → Fasten the seat belt. If the front passenger's seat is occupied, the front passenger's seat belt also needs to be fastened to make the warning light (warning buzzer) turn off.

*: Driver's seat belt warning buzzer:

The driver's seat belt warning buzzer sounds to alert the driver that his or her seat belt is not fastened. Once the engine switch is turned to IGNITION ON mode, the buzzer sounds. If the seat belt is still unfastened, the buzzer sounds intermittently for a certain period of time after the vehicle reaches a certain speed.

Front passenger's seat belt warning buzzer:

The front passenger's seat belt warning buzzer sounds to alert the front passenger that his or her seat belt is not fastened. If the seat belt is unfastened, the buzzer sounds intermittently for a certain period of time after the vehicle reaches a certain speed.

■ Rear passengers' seat belt reminder lights*¹ (warning buzzer)*²

Warning light	Details/Actions
	Warns the rear passengers to fasten their seat belts → Fasten the seat belt.

*¹: This light illuminates on the center panel.

*²: Rear passengers' seat belt warning buzzer:

The rear passengers' seat belt warning buzzer sounds to alert the rear passenger that his or her seat belt is not fastened. If the seat belt is unfastened, the buzzer sounds intermittently for a certain period of time, after the seat belt is fastened and unfastened and the vehicle reaches a certain speed.



■ Master warning light (warning buzzer)

Warning light	Details/Actions
	<p>A buzzer sounds and the warning light comes on and flashes to indicate that the master warning system has detected a malfunction. → P.303</p>

■ Tire pressure warning light

Warning light	Details/Actions
	<p>When the light comes on: Low tire inflation pressure such as</p> <ul style="list-style-type: none"> ● Natural causes (→P.301) ● Flat tire (→P.307) <p>→ Adjust the tire inflation pressure to the specified level. The light will turn off after a few minutes. In case the light does not turn off even if the tire inflation pressure is adjusted, have the system checked by your Lexus dealer.</p> <p>When the light comes on after blinking for 1 minute: Malfunction in the tire pressure warning system → Have the system checked by your Lexus dealer.</p>

■ Parking brake indicator (warning buzzer)

Warning light	Details/Actions
<p> (flashes) (U.S.A.)</p> <p>or</p> <p> (flashes) (Canada)</p>	<p>It is possible that the parking brake is not fully engaged or released → Operate the parking brake switch once again.</p> <p>This light comes on when the parking brake is not released. If the light turns off after the parking brake is fully released, the system is operating normally.</p>

■ Brake hold operated indicator (warning buzzer)

Warning light	Details/Actions
	Indicates a malfunction in the brake hold system → Have the vehicle inspected by your Lexus dealer immediately.

■ SRS warning light

This warning light system monitors the air-bag sensor assembly, front impact sensors, side impact sensors (door), side impact sensors (front), side impact sensors (rear), driver's seat position sensor, driver's seat belt buckle switch, front passenger occupant classification system, "AIR BAG ON" indicator light, "AIR BAG OFF" indicator light, front passenger's seat belt buckle switch, seat belt pretensioners, airbags, interconnecting wiring and power sources. (→P.29)

■ Front passenger detection sensor, seat belt reminder and warning buzzer

- If luggage is placed on the front passenger seat, the front passenger detection sensor may cause the warning light to flash and the warning buzzer to sound even if a passenger is not sitting in the seat.
- If a cushion is placed on the seat, the sensor may not detect a passenger, and the warning light may not operate properly.

■ If the malfunction indicator lamp comes on while driving

First check the following:

- Is the fuel tank empty?
If it is, fill the fuel tank immediately.
- Is the fuel tank cap loose?
If it is, tighten it securely.

The light will go off after several driving trips.

If the light does not go off even after several trips, contact your Lexus dealer as soon as possible.

■ Electric power steering system warning light (warning buzzer)

When the battery charge becomes insuffi-

cient or the voltage temporarily drops, the electric power steering system warning light may come on and the warning buzzer may sound.

■ When the tire pressure warning light comes on

Check the tire inflation pressure and adjust to the appropriate level. Pushing the tire pressure warning reset switch will not turn off the tire pressure warning light.

■ The tire pressure warning light may come on due to natural causes

The tire pressure warning light may come on due to natural causes such as natural air leaks and tire inflation pressure changes caused by temperature. In this case, adjusting the tire inflation pressure will turn off the warning light (after a few minutes).

■ When a tire is replaced with the spare tire

The spare tire is not equipped with a tire pressure warning valve and transmitter. If a tire goes flat, the tire pressure warning light will not turn off even though the flat tire has been replaced with the spare tire.

■ Conditions that the tire pressure warning system may not function properly

→P.268

■ If the tire pressure warning light frequently comes on after blinking for 1 minute

If the tire pressure warning light frequently comes on after blinking for 1 minute when the engine switch is turned to IGNITION ON mode, have it checked by your Lexus dealer.

■ Warning buzzer

In some cases, the buzzer may not be heard due to being in a noisy location or audio sound.

 **WARNING**

■ **If both the ABS and the brake system warning lights remain on**

Stop your vehicle in a safe place immediately and contact your Lexus dealer. The vehicle will become extremely unstable during braking, and the ABS system may fail, which could cause an accident resulting in death or serious injury.

■ **When the electric power steering system warning light comes on**

The steering wheel may become extremely heavy. When steering wheel operations are heavier than usual, grip the steering wheel firmly and operate it using more force than usual.

■ **If the tire pressure warning light comes on**

Be sure to observe the following precautions. Failure to do so could cause a loss of vehicle control and result in death or serious injury.

- Stop your vehicle in a safe place as soon as possible. Adjust the tire inflation pressure immediately.
- If the tire pressure warning light comes on even after tire inflation pressure adjustment, it is probable that you have a flat tire. Check the tires. If a tire is flat, change it with the spare tire and have the flat tire repaired by the nearest Lexus dealer.
- Avoid abrupt maneuvering and braking. If the vehicle tires deteriorate, you could lose control of the steering wheel or the brakes.

■ **If a blowout or sudden air leakage should occur**

The tire pressure warning system may not activate immediately.

■ **Maintenance of the tires**

Each tire, including the spare (if provided), should be checked monthly when cold and inflated to the inflation pressure recommended by the vehicle manufacturer on the vehicle placard or tire inflation pressure label (tire and load information label). (If your vehicle has tires of a different size than the size indicated on the vehicle placard or tire inflation pressure label [tire and load information label], you should determine the proper tire inflation pressure for those tires.)

As an added safety feature, your vehicle has been equipped with a tire pressure monitoring system (TPMS-tire pressure warning system) that illuminates a low tire pressure telltale (tire pressure warning light) when one or more of your tires is significantly under-inflated. Accordingly, when the low tire pressure telltale (tire pressure warning light) illuminates, you should stop and check your tires as soon as possible, and inflate them to the proper pressure. Driving on a significantly under-inflated tire causes the tire to overheat and can lead to tire failure. Under-inflation also reduces fuel efficiency and tire tread life, and may affect the vehicle's handling and stopping ability.

Please note that the TPMS (tire pressure warning system) is not a substitute for proper tire maintenance, and it is the driver's responsibility to maintain correct tire pressure, even if under-inflation has not reached the level to trigger illumination of the TPMS low tire pressure telltale (tire pressure warning light).

⚠ WARNING

Your vehicle has also been equipped with a TPMS (tire pressure warning system) malfunction indicator to indicate when the system is not operating properly. The TPMS (tire pressure warning system) malfunction indicator is combined with the low tire pressure telltale (tire pressure warning light). When the system detects a malfunction, the telltale will flash for approximately one minute and then remain continuously illuminated. This sequence will continue upon subsequent vehicle start-ups as long as the malfunction exists. When the malfunction indicator is illuminated, the system may not be able to detect or signal low tire pressure as intended.

TPMS (tire pressure warning system) malfunctions may occur for a variety of reasons, including the installation of replacement or alternate tires or wheels on the vehicle that prevent the TPMS (tire pressure warning system) from functioning properly. Always check the TPMS (tire pressure warning system) malfunction telltale after replacing one or more tires or wheels on your vehicle to ensure that the replacement or alternate tires and wheels allow the TPMS (tire pressure warning system) to continue to function properly.

⚠ NOTICE**■ To ensure the tire pressure warning system operates properly**

Do not install tires with different specifications or makers, as the tire pressure warning system may not operate properly.

If a warning message is displayed

The multi-information display shows warnings of system malfunctions, incorrectly performed operations, and messages that indicate a need for maintenance. When a message is shown, perform the correction procedure appropriate to the message.

▶ Except F SPORT models

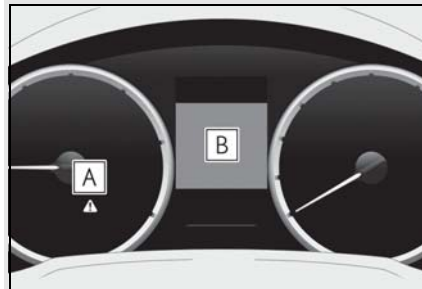
**A** Master warning light

The master warning light also comes on or flashes in order to indicate that a message is currently being displayed on the multi-information display.

B Multi-information display

Follow the instructions of the message on the multi-information display.

If any of the warning messages are shown again after the following actions have been performed, contact your Lexus dealer.

▶ F SPORT models (main meter in center position)

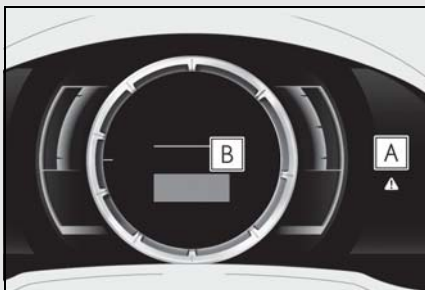

A Master warning light

The master warning light also comes on or flashes in order to indicate that a message is currently being displayed on the multi-information display.

B Multi-information display

Follow the instructions of the message on the multi-information display.
If any of the warning messages are shown again after the following actions have been performed, contact your Lexus dealer.

▶ F SPORT models (main meter moved to the right)

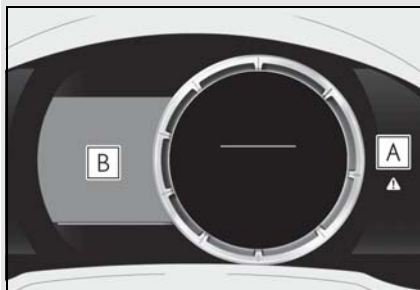

A Master warning light

The master warning light also comes on or flashes in order to indicate that a message is currently being displayed on the multi-information display.

B Multi-information display

Follow the instructions of the message on the multi-information display.
If any of the warning messages are shown again after the following actions have been performed, contact your Lexus dealer.

Messages and warnings

The warning lights and warning buzzers operate as follows depending on the content of the message. If a message indicates the need for inspection by a dealer, have the vehicle inspected by your Lexus dealer immediately.

	Warning buzzer *	Warning
Comes on	Sounds	Indicates an important situation, such as when a system related to driving is malfunctioning or that danger may result if the correction procedure is not performed
Flashes	Sounds	Indicates a situation, such as when damage to the vehicle or danger may result
Comes on	Does not sound	Indicates a condition, such as malfunction of electrical components, their condition, or indicates the need for maintenance
Flashes	Does not sound	Indicates a situation, such as when an operation has been performed incorrectly, or indicates how to perform an operation correctly

- In some situations, the master warning light and warning buzzer may not operate as specified. In this case, follow the instructions displayed in the warning message.
- If a warning light comes on or flashes at the same time that a warning message is displayed, take corrective action according to the warning light. (→P.295)

*: A buzzer sounds the first time a message is shown on the multi-information display.

■ Warning messages

The warning messages explained below may differ from the actual messages according to operation conditions and vehicle specifications.

■ Warning buzzer

In some cases, the buzzer may not be heard due to being in a noisy location or audio sound.

■ If "Engine Oil Level Low Add or Replace" is displayed

The engine oil level is low. Check the level of the engine oil, and add if necessary.

This message may appear if the vehicle is stopped on a slope. Move the vehicle to a level surface and check to see if the message disappears.

■ If a message that indicates the malfunction of front camera is displayed

The following systems may be suspended until the problem shown in the message is resolved. (→P.160, 298)

- PCS (Pre-Collision System)
- LDA (Lane Departure Alert with steering control)
- Automatic High Beam
- Dynamic radar cruise control with

full-speed range

■ If “Maintenance Required Soon” is displayed

Indicates that all maintenance according to the driven distance on the maintenance schedule* should be performed soon.

Comes on approximately 4500 miles (7200 km) after the message has been reset. If necessary, perform maintenance. Please reset the message after the maintenance is performed. (→P.248)

*: Refer to the separate “Scheduled Maintenance” or “Owner’s Manual Supplement” for the maintenance interval applicable to your vehicle.

■ If “Maintenance Required Visit Your Dealer” is displayed

Indicates that all maintenance is required to correspond to the driven distance on the maintenance schedule*.

Comes on approximately 5000 miles (8000 km) after the message has been reset. (The indicator will not work properly unless the message has been reset.) Perform the necessary maintenance. Please reset the message after the maintenance is performed. (→P.248)

*: Refer to the separate “Scheduled Maintenance” or “Owner’s Manual Supplement” for the maintenance interval applicable to your vehicle.

■ If “Oil Maintenance Required Soon” is displayed

Indicates that the engine oil is scheduled to be changed. (The indicator will not work properly unless the oil maintenance data has been reset.)

Check the engine oil, and change if necessary. After changing the engine oil, the oil change system should be reset. (→P.260)

■ If “Oil Maintenance Required” is displayed

Indicates that the engine oil should be changed. (After the engine oil is changed and the oil maintenance data has been reset.)

Check and change the engine oil, and oil filter by your Lexus dealer. After changing the engine oil, the oil change system should be reset. (→P.260)

■ If a message that indicates the need for visiting your Lexus dealer is displayed

The system or part shown on the multi-information display is malfunctioning. Have the vehicle inspected by your Lexus dealer immediately.

■ If “See Owner’s Manual” is displayed

● If the following messages are shown, following the instructions, accordingly.

- “Engine Coolant Temp High” (→P.322)

● If any of the following messages are shown on the multi-information display, it may indicate a malfunction. Have the vehicle inspected by your Lexus dealer immediately.

- “Braking Power Low”
- “Access System with Elec. Key Malfunction”

● If any of the following messages are shown on the multi-information display, it may indicate a malfunction. Immediately stop the vehicle and contact your Lexus dealer.

- “Oil Pressure Low”
- “Charging System Malfunction”

 NOTICE

■ “High Power Consumption Partial Limit On AC/Heater Operation” is frequently shown

There is a possible malfunction relating to the charging system or the battery may be deteriorating. Have the vehicle inspected by your Lexus dealer.

If you have a flat tire

Your vehicle is equipped with a spare tire. The flat tire can be replaced with the spare tire.

For details about tires: →P.265

⚠ WARNING**■ If you have a flat tire**

Do not continue driving with a flat tire. Driving even a short distance with a flat tire can damage the tire and the wheel beyond repair, which could result in an accident.

Before jacking up the vehicle

- Stop the vehicle in a safe place on a hard, flat surface.
- Set the parking brake.
- Shift the shift lever to P.
- Stop the engine.
- Turn on the emergency flashers. (→P.286)

Location of the spare tire, jack and tools

▶ Type A

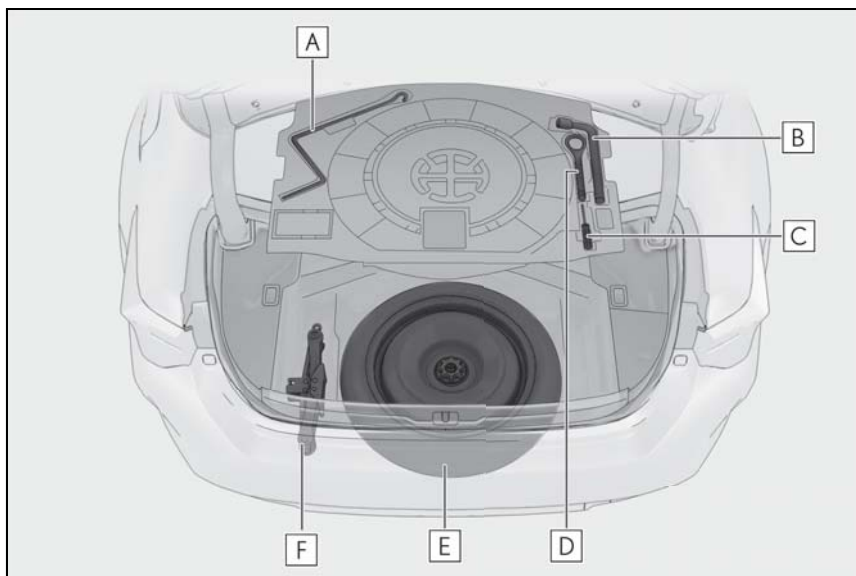

- A** Jack handle
- B** Wheel nut wrench
- C** Screwdriver
- D** Towing eyelet

E Spare tire

F Jack

► Type B

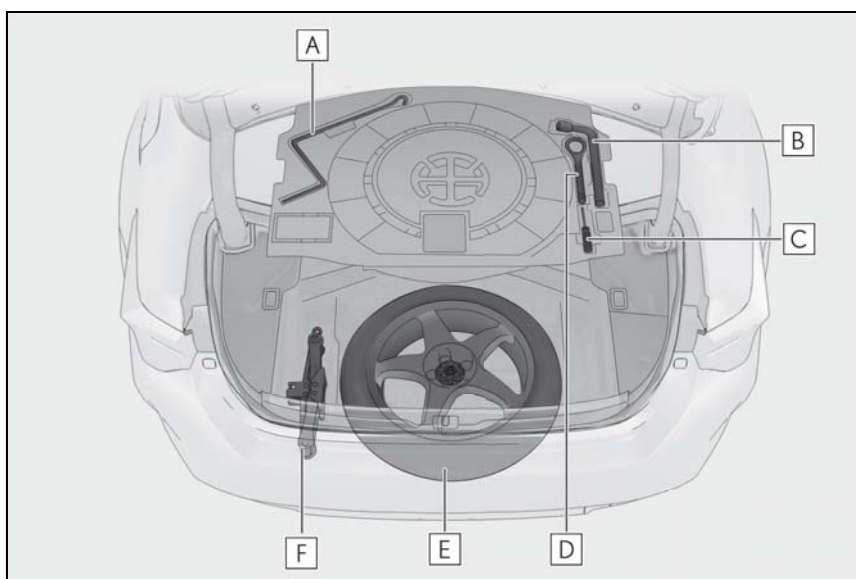

A Jack handle

B Wheel nut wrench

C Screwdriver

D Towing eyelet

E Spare tire

F Jack

⚠ WARNING

■ Using the tire jack

Observe the following precautions. Improper use of the tire jack may cause the vehicle to suddenly fall off the jack, leading to death or serious injury.

- Do not use the tire jack for any purpose other than replacing tires or installing and removing tire chains.

- Only use the tire jack that comes with this vehicle for replacing a flat tire. Do not use it on other vehicles, and do not use other tire jacks for replacing tires on this vehicle.
- Put the jack properly in its jack point.
- Do not put any part of your body under the vehicle while it is supported by the jack.
- Do not start the engine or drive the vehicle while the vehicle is supported by the jack.

⚠ WARNING

- Do not raise the vehicle while someone is inside.
- When raising the vehicle, do not put an object on or under the jack.
- Do not raise the vehicle to a height greater than that required to replace the tire.
- Use a jack stand if it is necessary to get under the vehicle.
- When lowering the vehicle, make sure that there is no-one near the vehicle. If there are people nearby, warn them vocally before lowering.

Taking out the jack

- 1** Hold the hook and lift up the luggage mat.

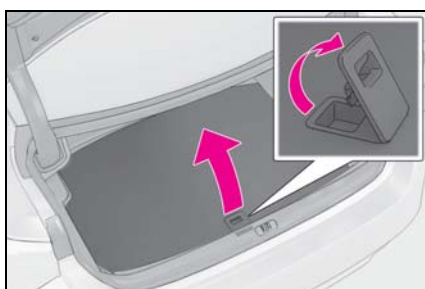

- 2** Secure the luggage mat using the hook.

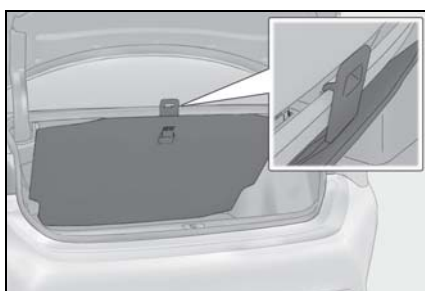

- 3** Remove the tool tray.

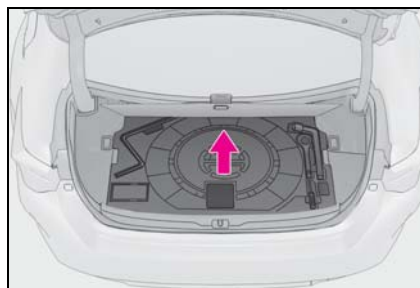

- 4** Take out the jack.

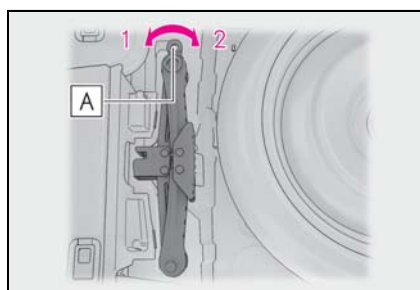

- 1** For tightening
- 2** For loosening

If the jack is too tightly installed to be removed by hand, insert a tool, such as the screwdriver included with the vehicle, into the hole of the jack (portion **A**) and loosen the jack.

⚠ NOTICE

■ **To prevent damage to luggage mat**

When closing the trunk lid, do not leave the luggage mat lever hooked on the edge of the trunk.

Taking out the spare tire

- 1** Secure the luggage mat using the hook. (→P.309)

- 2 Remove the tool tray.

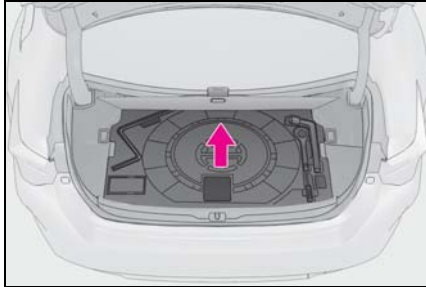

- 3 Loosen the center fastener that secures the spare tire.

If the center fastener cannot be turned by hand, use the wheel nut wrench that is stored in the trunk. (To secure the tire, tighten the center fastener by hand. Do not use the wrench or other tools.)

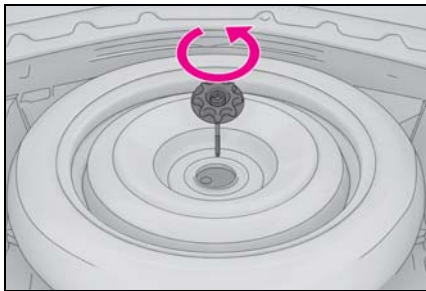

⚠ WARNING

■ When storing the spare tire

Be careful not to catch fingers or other body parts between the spare tire and the body of the vehicle.

Replacing a flat tire

- 1 Chock the tires.

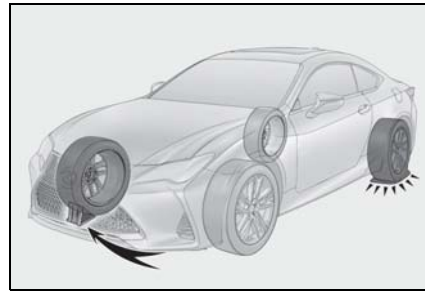

Flat tire	Wheel chock positions
Front left-hand side	Behind the rear right-hand side tire
Front right-hand side	Behind the rear left-hand side tire
Rear left-hand side	In front of the front right-hand side tire
Rear right-hand side	In front of the front left-hand side tire

- 2 Slightly loosen the wheel nuts (one turn).

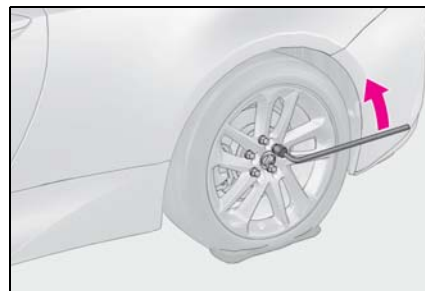

- 3 Turn the tire jack portion **A** by hand until the notch of the jack is in contact with the jack point.

The jack point guides are located under the rocker panel. They indicate the jack

point positions.

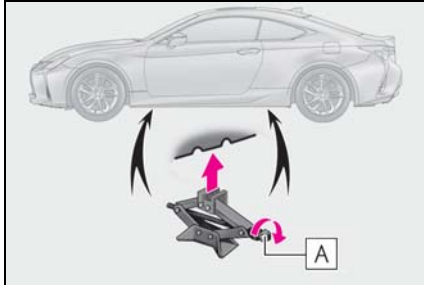

- 4** Raise the vehicle until the tire is slightly raised off the ground.



- 5** Remove all the wheel nuts and the tire.

When resting the tire on the ground, place the tire so that the wheel design faces up to avoid scratching the wheel surface.

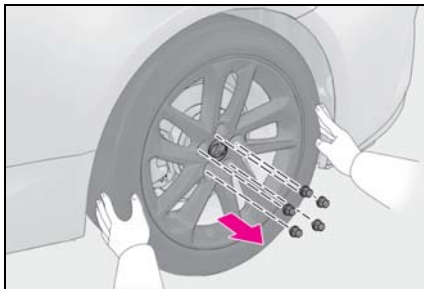

⚠ WARNING

■ Replacing a flat tire

- Do not touch the disc wheels or the area around the brakes immediately after the vehicle has been driven. After the vehicle has been driven the disc wheels and the area around the brakes will be extremely hot. Touching these areas with hands, feet or other body parts while changing a tire, etc. may result in burns.
- Failure to follow these precautions could cause the wheel nuts to loosen and the tire to fall off, resulting in death or serious injury.
- Never use oil or grease on the wheel bolts or wheel nuts. Oil and grease may cause the wheel nuts to be excessively tightened, leading to bolt or disc wheel damage. In addition, the oil or grease can cause the wheel nuts to loosen and the wheel may fall off, causing a serious accident. Remove any oil or grease from the wheel bolts or wheel nuts.
- Have the wheel nuts tightened with a torque wrench to 76 ft•lbf (103 N•m, 10.5 kgf•m) as soon as possible after changing wheels.
- Do not attach a heavily damaged wheel ornament, as it may fly off the wheel while the vehicle is moving.
- When installing a tire, only use wheel nuts that have been specifically designed for that wheel.
- If there are any cracks or deformations in the bolt screws, nut threads or bolt holes of the wheel, have the vehicle inspected by your Lexus dealer.

Installing the spare tire

- 1** Remove any dirt or foreign matter from the wheel contact surface.

If foreign matter is on the wheel contact surface, the wheel nuts may loosen while the vehicle is in motion, causing the tire to

come off.

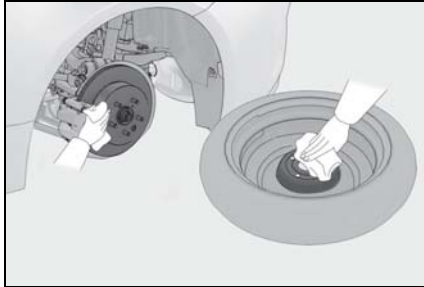

- 2** Install the spare tire and loosely tighten each wheel nut by hand by approximately the same amount.

When replacing an aluminum wheel with a steel wheel, tighten the wheel nuts until the tapered portion **A** comes into loose contact with the disc wheel seat **B**.

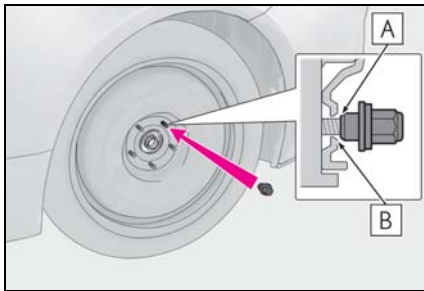

When replacing an aluminum wheel with an aluminum wheel, turn the wheel nuts until the washers **A** come into contact with the disc wheel **B**.

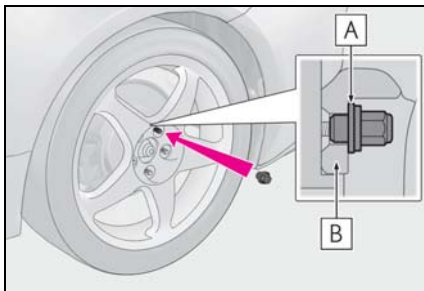

- 3** Lower the vehicle.

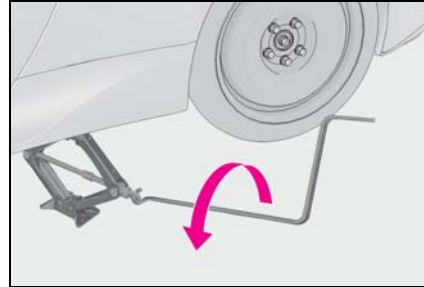

- 4** Firmly tighten each wheel nut two or three times in the order shown in the illustration.

Tightening torque:
76 ft•lbf (103 N•m, 10.5 kgf•m)

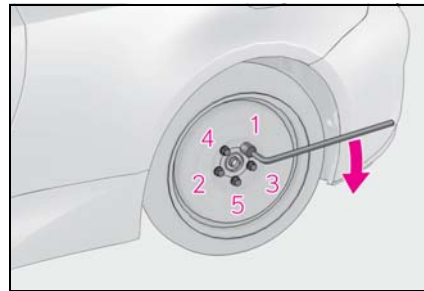

- 5** Stow the flat tire, tire jack and all tools.

■ **The spare tire**

- The spare tire is identified by the label "TEMPORARY USE ONLY" on the tire sidewall.
- Use the spare tire temporarily, and only in an emergency.
- Make sure to check the tire inflation pressure of the spare tire. (→P.334)

■ **When using the spare tire**

As the spare tire is not equipped with a tire pressure warning valve and transmitter, low inflation pressure of the spare tire will not be indicated by the tire pressure warning system. Also, if you replace the spare tire after the tire pressure warning light comes on, the light remains on.

■ When the spare tire is equipped

The vehicle becomes lower when driving with the spare tire compared to when driving with standard tires.

■ If you have a flat rear tire on a road covered with snow or ice (vehicles with front and rear tires of the same size except for vehicles with LDH and 19-inch tires)

Install the spare tire on one of the front wheels of the vehicle. Perform the following steps and fit tire chains to the rear tires:

- 1 Replace a front tire with the spare tire.
- 2 Replace the flat rear tire with the tire removed from the front of the vehicle.
- 3 Fit tire chains to the rear tires.



WARNING

■ When using the spare tire

- Remember that the spare tire provided is specifically designed for use with your vehicle. Do not use your spare tire on another vehicle.
- Do not use more than one spare tire simultaneously.
- Replace the spare tire with a standard tire as soon as possible.
- Avoid sudden acceleration, abrupt steering, sudden braking and shifting operations that cause sudden engine braking.

■ When the spare tire is attached

The vehicle speed may not be correctly detected, and the following systems may not operate correctly:

- ABS & Brake assist
- VSC
- TRAC
- Dynamic radar cruise control with full-speed range
- PCS
- EPS

- Adaptive Variable Suspension System (if equipped)
- LDA (Lane Departure Alert with steering control)
- VGRS (if equipped)
- LDH (Lexus Dynamic Handling system) (if equipped)
- DRS (Dynamic Rear Steering) (if equipped)
- VDIM (Vehicle Dynamics Integrated Management)
- Tire pressure warning system
- Lexus parking assist monitor
- Intuitive parking assist (if equipped)
- Navigation system (if equipped)

Also, not only can the following system not be utilized fully, but it may even negatively affect the drive-train components:

- AWD system (if equipped)

■ Speed limit when using the spare tire

Do not drive at speeds in excess of 50 mph (80 km/h) when a spare tire is installed on the vehicle.

The spare tire is not designed for driving at high speeds. Failure to observe this precaution may lead to an accident causing death or serious injury.

■ After using the tools and jack

Before driving, make sure all the tools and jack are securely in place in their storage location to reduce the possibility of personal injury during a collision or sudden braking.



NOTICE

■ **Driving with tire chains and the spare tire**

Do not fit tire chains to the spare tire. Tire chains may damage the vehicle body and adversely affect driving performance.

■ **When replacing the tires**

When removing or fitting the wheels, tires or the tire pressure warning valve and transmitter, contact your Lexus dealer as the tire pressure warning valve and transmitter may be damaged if not handled correctly.

If the engine will not start

If the engine will not start even though correct starting procedures are being followed (→P.127), consider each of the following points:

The engine will not start even though the starter motor operates normally.

One of the following may be the cause of the problem:

- There may not be sufficient fuel in the vehicle's tank.
Refuel the vehicle.
- The engine may be flooded.
Try to restart the engine again following correct starting procedures.
(→P.127)
- There may be a malfunction in the engine immobilizer system.
(→P.56)

The starter motor turns over slowly, the interior lights and headlights are dim, or the horn does not sound or sounds at a low volume.

One of the following may be the cause of the problem:

- The battery may be discharged.
(→P.319)
- The battery terminal connections may be loose or corroded.
(→P.263)

The starter motor does not turn over

The engine starting system may be malfunctioning due to an electrical problem such as electronic key battery depletion or a blown fuse. However, an interim measure is available to start the engine. (→P.315)

The starter motor does not turn over, the interior lights and headlights do not turn on, or the horn does not sound.

One of the following may be the cause of the problem:

- One or both of the battery terminals may be disconnected. (→P.263)
- The battery may be discharged. (→P.319)
- There may be a malfunction in the steering lock system.

Contact your Lexus dealer if the problem cannot be repaired, or if repair procedures are unknown.

Emergency start function

When the engine does not start, the following steps can be used as an interim measure to start the engine if the engine switch is functioning normally:

- 1 Set the parking brake.
- 2 Shift the shift lever to P.
- 3 Turn the engine switch to ACCESSORY mode.

- 4 Press and hold the engine switch for about 15 seconds while depressing the brake pedal firmly.

Even if the engine can be started using the above steps, the system may be malfunctioning. Have the vehicle inspected by your Lexus dealer.

If you lose your keys

New genuine mechanical keys can be made by your Lexus dealer using another mechanical key and the key number stamped on your key number plate.

Keep the plate in a safe place such as your wallet, not in the vehicle.

 NOTICE

■ **When an electronic key is lost**

If the electronic key remains lost, the risk of vehicle theft increases significantly. Visit your Lexus dealer immediately with all remaining electronic keys and the card key that were provided with your vehicle.

If the fuel filler door cannot be opened

If the fuel filler door cannot be opened by pressing the center of the rear edge of the fuel filler door with the doors unlocked, the following procedure can be used to open the fuel filler door.

Opening the fuel filler door

Remove the cover inside the trunk and pull the lever.

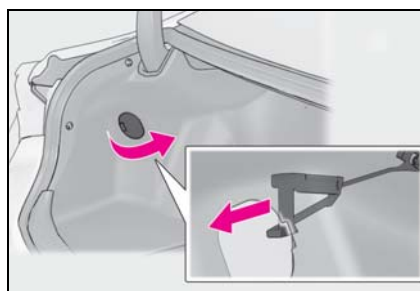

If the electronic key does not operate properly

If communication between the electronic key and vehicle is interrupted (→P.96) or the electronic key cannot be used because the battery is depleted, the smart access system with push-button start and wireless remote control cannot be used. In such cases, the doors and trunk can be opened and the engine can be started by following the procedure below.

■ When the electronic key does not work properly

- Make sure that the smart access system with push-button start has not been deactivated in the customization setting. If it is off, turn the function on.
- Check if battery-saving mode is set. If it is set, cancel the function. (→P.96)

⚠ NOTICE

■ In case of a smart access system with push-button start malfunction or other key-related problems

Take your vehicle with all the electronic keys provided with your vehicle, including the card key, to your Lexus dealer.

Locking and unlocking the doors and opening the trunk

■ Unlocking the door

Use the mechanical key (→P.84) in order to perform the following operations:

- 1 Insert the mechanical key while pulling on the driver's door handle.



- 2 Unlocking the door.

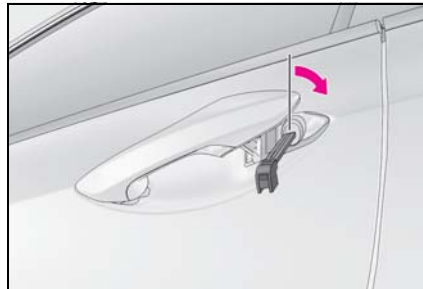

- 3 Remove the key, return the handle, and then pull the handle again.

■ Locking the door

- 1 Move the inside lock button to the lock position.

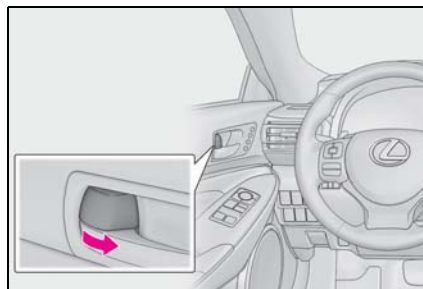

- 2 Close the door.

■ Opening the trunk

Turn the mechanical key clockwise to open. (→P.57)

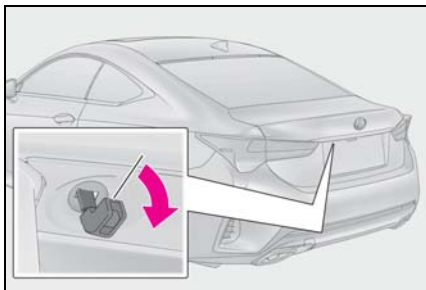

■ Key linked functions

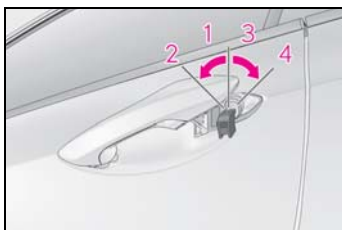

- 1 Locks both side door
- 2 Closes the windows and moon roof (if equipped) (turn and hold)*
- 3 Unlocks the door
- 4 Opens the windows and moon roof (if equipped) (turn and hold)*

Turning the key rearward unlocks the driver's door. Turning the key again unlocks the other door.

*: These settings must be customized at your Lexus dealer.

⚠ WARNING

■ **When using the mechanical key and operating the power windows or moon roof**

Operate the power window or moon roof after checking to make sure that there is no possibility of any passenger having any of their body parts caught in the window or moon roof. Also, do not allow children to operate the mechanical key. It is possible for children and other passengers to get caught in the power window or moon roof.

Starting the engine

- 1 Ensure that the shift lever is in P and depress the brake pedal.
- 2 Touch the Lexus emblem side of the electronic key to the engine switch.

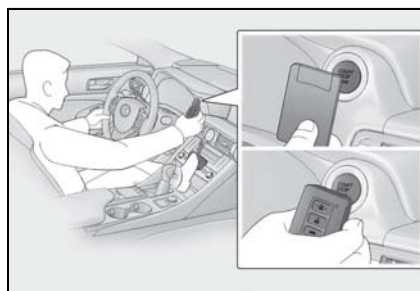

When the electronic key is detected, a buzzer sounds and the engine switch will turn to IGNITION ON mode.

When the smart access system with push-button start is deactivated in customization setting, the engine switch will turn to ACCESSORY mode.

- 3 Firmly depress the brake pedal and check that  is shown on the multi-information display.
- 4 Press the engine switch.

In the event that the engine still cannot be started, contact your Lexus dealer.

■ **Stopping the engine**

Shift the shift lever to P and press the engine switch as you normally do when stopping the engine.

■ **Electronic key battery**

As the above procedure is a temporary measure, it is recommended that the electronic key battery be replaced immediately when the battery is depleted. (→P.277)

■ **Alarm (For Canada)**

Using the mechanical key to lock the doors will not set the alarm system. If a door is unlocked using the mechanical

key when the alarm system is set, the alarm may be triggered.

■ Changing engine switch modes

Release the brake pedal and press the engine switch in step **3** above. The engine does not start and modes will be changed each time the switch is pressed. (→P.129)

If the vehicle battery is discharged

The following procedures may be used to start the engine if the vehicle's battery is discharged. You can also call your Lexus dealer or a qualified repair shop.

Restarting the engine

If you have a set of jumper (or booster) cables and a second vehicle with a 12-volt battery, you can jump start your vehicle by following the steps below.

- 1 Confirm that the electronic key is being carried.

When connecting the jumper (or booster) cables, depending on the situation, the alarm may activate and doors locked. (→P.58)

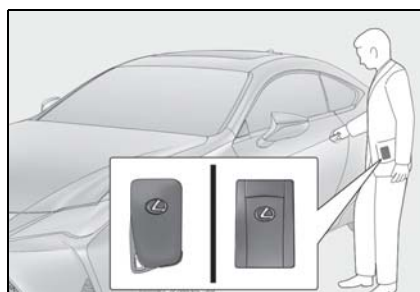

- 2 Open the hood. (→P.255)

- 3 Connect a positive jumper cable clamp to **A** on your vehicle and connect the clamp on the other end of the positive cable to **B** on the second vehicle. Then, connect a negative cable clamp to **C** on the second vehicle and connect the clamp at the other end of the negative cable to **D**.

- RC350/RC300 AWD

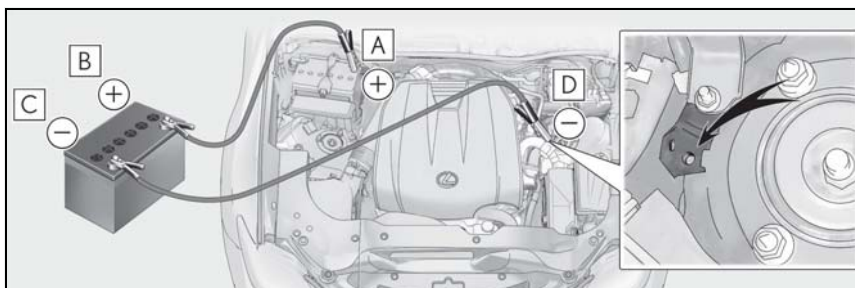

- A** Positive (+) battery terminal (your vehicle)
- B** Positive (+) battery terminal (second vehicle)
- C** Negative (-) battery terminal (second vehicle)
- D** Solid, stationary, unpainted metallic point away from the battery and any moving parts as shown in the illustration

● RC300

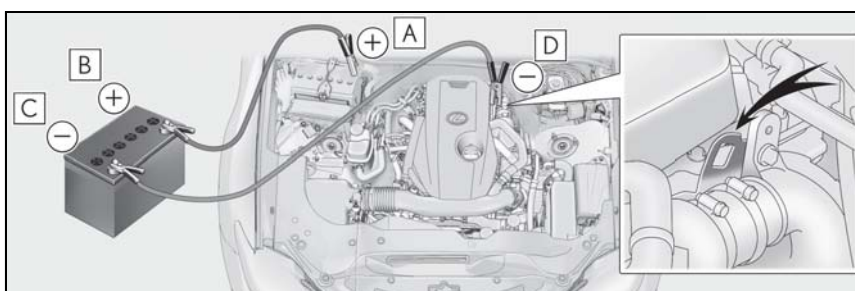

- A** Positive (+) battery terminal (your vehicle)
- B** Positive (+) battery terminal (second vehicle)
- C** Negative (-) battery terminal (second vehicle)
- D** Solid, stationary, unpainted metallic point away from the battery and any moving parts as shown in the illustration

- 4** Start the engine of the second vehicle. Increase the engine speed slightly and maintain at that level for approximately 5 minutes to recharge the battery of your vehicle.
- 5** Open and close any of the door of your vehicle with the engine switch off.
- 6** Maintain the engine speed of the second vehicle and start the engine of your vehicle by turning the engine switch to IGNITION ON mode.
- 7** Once the vehicle's engine has started, remove the jumper cables in the exact reverse order from which they were connected.

Once the engine starts, have the vehicle inspected at your Lexus dealer as soon as possible.

■ Starting the engine when the battery is discharged

The engine cannot be started by push-starting.

■ To prevent battery discharge

- Turn off the headlights and the audio system while the engine is off.
- Turn off any unnecessary electrical components when the vehicle is running at a low speed for an extended period, such as in heavy traffic.

■ Charging the battery

The electricity stored in the battery will discharge gradually even when the vehicle is not in use, due to natural discharge and the draining effects of certain electrical appliances. If the vehicle is left for a long time, the battery may discharge, and the engine may be unable to start. (The battery recharges automatically during driving.)

■ When recharging or replacing the battery

- In some cases, it may not be possible to unlock the doors using the smart access system with push-button start when the battery is discharged. Use the wireless remote control or the mechanical key to lock or unlock the doors.
- The engine may not start on the first attempt after the battery has recharged but will start normally after the second attempt. This is not a malfunction.
- The engine switch mode is memorized by the vehicle. When the battery is reconnected, the system will return to the mode it was in before the battery was discharged. Before disconnecting the battery, turn the engine switch off. If you are unsure what mode the engine switch was in before the battery discharged, be especially careful when reconnecting the battery.

⚠ WARNING

■ Avoiding battery fires or explosions

Observe the following precautions to prevent accidentally igniting the flammable gas that may be emitted from the battery:

- Make sure each jumper cable is connected to the correct terminal and that it is not unintentionally in contact with any other than the intended terminal.
- Do not allow the other end of the jumper cable connected to the "+" terminal to come into contact with any other parts or metal surfaces in the area, such as brackets or unpainted metal.
- Do not allow the + and - clamps of the jumper cables to come into contact with each other.
- Do not smoke, use matches, cigarette lighters or allow open flame near the battery.

■ Battery precautions

The battery contains poisonous and corrosive acidic electrolyte, while related parts contain lead and lead compounds. Observe the following precautions when handling the battery:

- When working with the battery, always wear safety glasses and take care not to allow any battery fluids (acid) to come into contact with skin, clothing or the vehicle body.
- Do not lean over the battery.
- In the event that battery fluid comes into contact with the skin or eyes, immediately wash the affected area with water and seek medical attention. Place a wet sponge or cloth over the affected area until medical attention can be received.
- Always wash your hands after handling the battery support, terminals, and other battery-related parts.

 **WARNING**

- Do not allow children near the battery.

 **NOTICE**

■ **When handling jumper cables**

When connecting the jumper cables, ensure that they do not become entangled in the cooling fans or engine drive belt.

If your vehicle overheats

The following may indicate that your vehicle is overheating.

- The engine coolant temperature gauge (→P.66) is in the red zone or a loss of engine power is experienced. (For example, the vehicle speed does not increase.)
- “Engine Coolant Temp High Stop in a Safe Place See Owner’s Manual” is shown on the multi-information display.
- Steam comes out from under the hood.

Correction procedures

- 1 Stop the vehicle in a safe place and turn off the air conditioning system, and then stop the engine.
 - 2 If you see steam:
Carefully lift the hood after the steam subsides.
If you do not see steam:
Carefully lift the hood.
 - 3 After the engine has cooled down sufficiently, inspect the hoses and radiator core (radiator) for any leaks.
- RC350/RC300 AWD

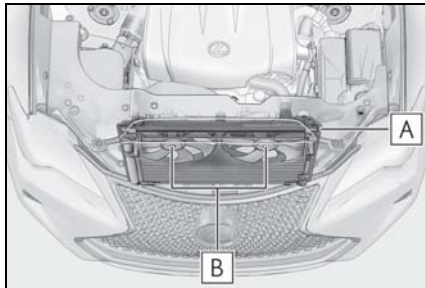

- A** Radiator
- B** Cooling fans

If a large amount of coolant leaks, immediately contact your Lexus dealer.

- RC300

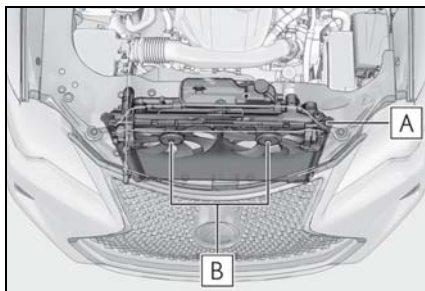

- A** Radiator
- B** Cooling fans

If a large amount of coolant leaks, immediately contact your Lexus dealer.

- 4 The coolant level is satisfactory if it is between the full ("FULL" or "F") and low ("LOW" or "L") lines on the reservoir.

- Engine (RC350/RC300 AWD)

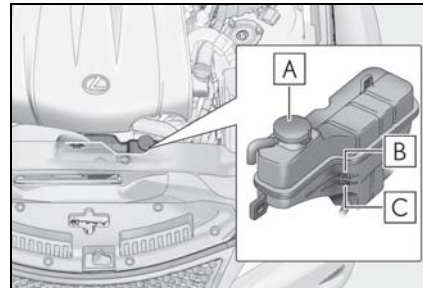

- A** Reservoir cap
- B** "FULL" or "F"
- C** "LOW" or "L"

- Engine (RC300)

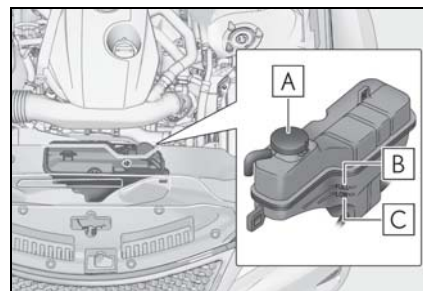

- A** Reservoir cap
- B** "FULL" or "F"
- C** "LOW" or "L"

- Intercooler (RC300)

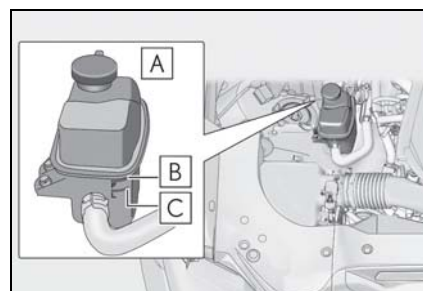

- A** Reservoir cap
- B** "FULL" or "F"
- C** "LOW" or "L"

5 Add coolant if necessary.

Water can be used in an emergency if coolant is unavailable.

- Engine (RC350/RC300 AWD)

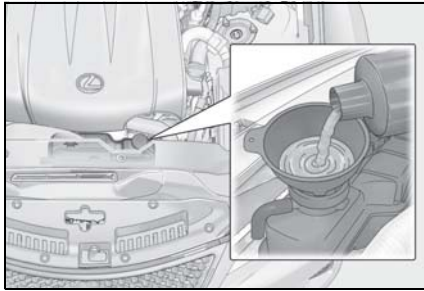

- Engine (RC300)

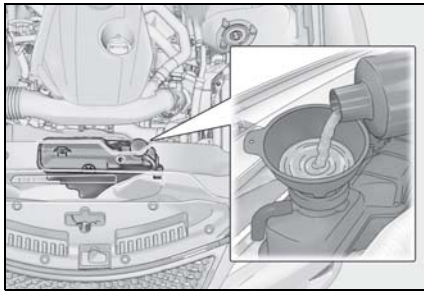

- Intercooler (RC300)

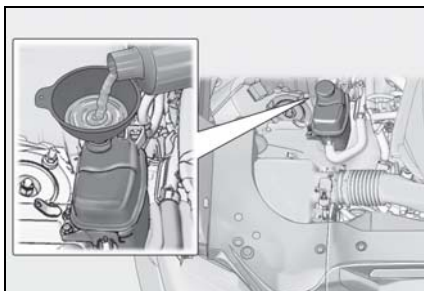

6 Start the engine and turn the air conditioning system on to check that the radiator cooling fans operate and to check for coolant leaks from the radiator or hoses.

The fans operate when the air conditioning system is turned on immediately after a cold start. Confirm that the fans are oper-

ating by checking the fan sound and air flow. If it is difficult to check these, turn the air conditioning system on and off repeatedly. (The fans may not operate in freezing temperatures.)

- 7** If the fans are not operating:
 Stop the engine immediately and contact your Lexus dealer.
 If the fans are operating:
 Have the vehicle inspected at the nearest Lexus dealer.

⚠ WARNING

■ When inspecting under the hood of your vehicle

Observe the following precautions. Failure to do so may result in serious injury such as burns.

- If steam is seen coming from under the hood, do not open the hood until the steam has subsided. The engine compartment may be very hot.
- Keep hands and clothing (especially a tie, a scarf or a muffler) away from the fans and belts. Failure to do so may cause the hands or clothing to be caught, resulting in serious injury.

⚠ WARNING

- RC350/RC300 AWD: While the engine and radiator are hot, do not loosen or remove the coolant reservoir cap or coolant inlet cap. (The coolant inlet cap is located under the engine cover.) High temperature steam or coolant could spray out.

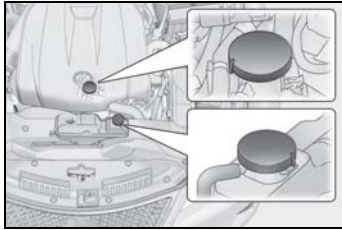

- RC300: While the engine and radiators are hot, do not loosen or remove the coolant reservoir cap, coolant inlet cap, or intercooler coolant reservoir cap. High temperature steam or coolant could spray out.

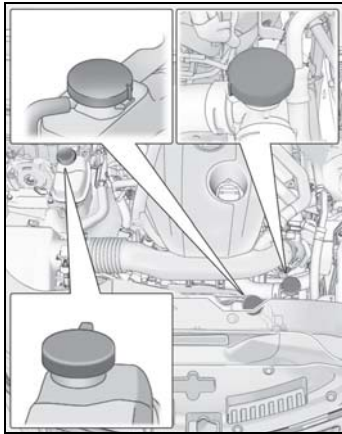

■ **To prevent damage to the cooling system**

Observe the following precautions:

- Avoid contaminating the coolant with foreign matter (such as sand or dust etc.).
- Do not use any coolant additive.

⚠ NOTICE

■ **When adding engine coolant**

Add coolant slowly after the engine has cooled down sufficiently. Adding coolant to a hot engine too quickly can cause damage to the engine.

If the vehicle becomes stuck

Carry out the following procedures if the tires spin or the vehicle becomes stuck in mud, dirt or snow:

Recovering procedure

- 1 Stop the engine. Set the parking brake and shift the shift lever to P.
- 2 Remove the mud, snow or sand from around the rear wheels.
- 3 Place wood, stones or some other material under the rear wheels to help provide traction.
- 4 Restart the engine.
- 5 Shift the shift lever to D or R and release the parking brake. Then, while exercising caution, depress the accelerator pedal.

When it is difficult to free the vehicle

Press the  switch to turn off TRAC.

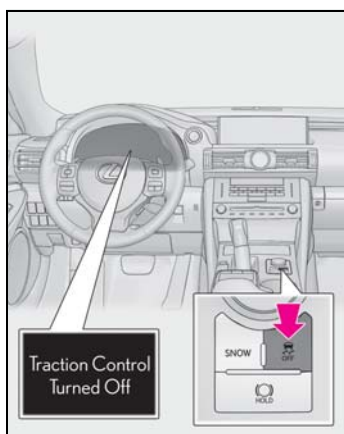

WARNING

When attempting to free a stuck vehicle

If you choose to push the vehicle back and forth to free it, make sure the surrounding area is clear to avoid striking other vehicles, objects or people. The vehicle may also lunge forward or lunge back suddenly as it becomes free. Use extreme caution.

When shifting the shift lever

Be careful not to shift the shift lever with the accelerator pedal depressed. This may lead to unexpected rapid acceleration of the vehicle that may cause an accident resulting in death or serious injury.

NOTICE

To avoid damaging the transmission and other components

- Avoid spinning the rear wheels and depressing the accelerator pedal more than necessary.
- If the vehicle remains stuck even after these procedures are performed, the vehicle may require towing to be freed.

Vehicle specifications

8

327

8-1. Specifications

Maintenance data (fuel, oil level,
etc.) 328

Fuel information 339

Tire information 341

8-2. Customization

Customizable features 351

8-3. Items to initialize

Items to initialize 361

8-4. Certifications

Certifications 362

8

Vehicle specifications

Maintenance data (fuel, oil level, etc.)

Dimensions and weight

Overall length	185.0 in. (4700 mm)	
Overall width	72.4 in. (1840 mm)	
Overall height ^{*1}	54.9 in. (1395 mm)	
Wheelbase	107.5 in. (2730 mm)	
Tread ^{*1}	Front	62.2 in. (1580 mm)
	Rear	63.0 in. (1600 mm) 61.8 in. (1570 mm) ^{*2}
Vehicle capacity weight (Occupants + luggage)	700 lb. (320 kg)	

^{*1}: Unladen vehicle

^{*2}: Vehicles with 265/35R19 tires

Seating capacity

Seating capacity	4 (Front 2, Rear 2)
------------------	---------------------

Vehicle identification

■ Vehicle identification number

The vehicle identification number (VIN) is the legal identifier for your vehicle. This is the primary identification number for your Lexus. It is used in registering the ownership of your vehicle.

This number is stamped on the top left of the instrument panel and in the engine compartment.

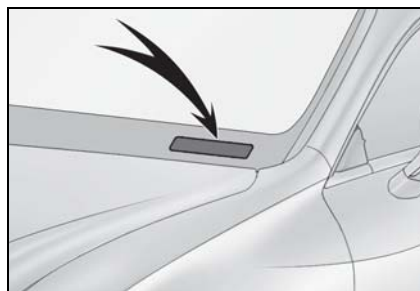

▶ RC350/RC300 AWD

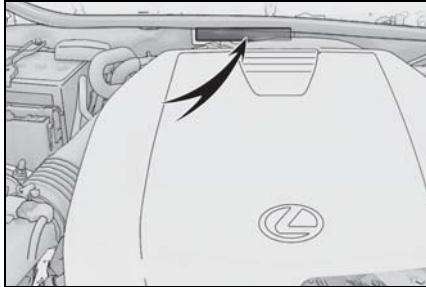

▶ RC300

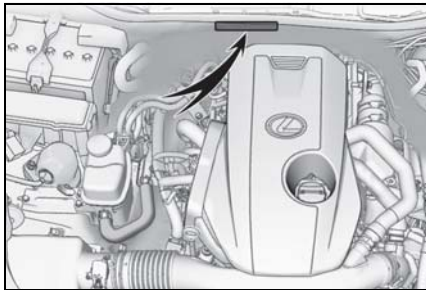

This number is also on the Certification Label.

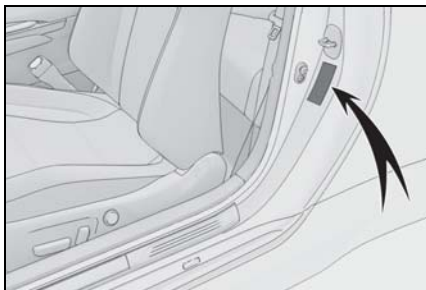

■ Engine number

The engine number is located as shown.

▶ RC350/RC300 AWD

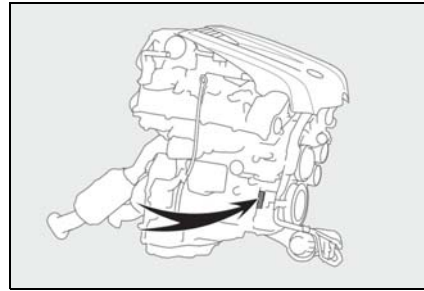

▶ RC300

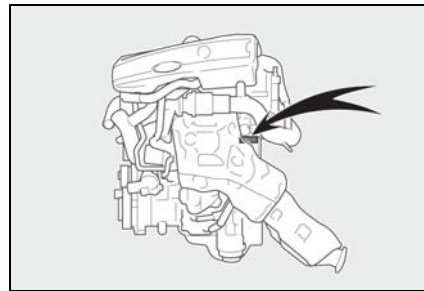

Engine

■ RC350/RC300 AWD

Model	3.5 L 6-cylinder (2GR-FKS) engine
Type	6-cylinder V type, 4-cycle, gasoline
Bore and stroke	3.70 x 3.27 in. (94.0 x 83.0 mm)

Displacement	210.9 cu. in. (3456 cm ³)
Drive belt tension	Automatic adjustment

■ **RC300**

Model	2.0 L 4-cylinder (8AR-FTS) engine
Type	4-cylinder in line, 4-cycle, gasoline (with turbocharger)
Bore and stroke	3.39 × 3.39 in. (86.0 × 86.0 mm)
Displacement	121.9 cu. in. (1998 cm ³)
Drive belt tension	Automatic adjustment

Fuel

Fuel type	Unleaded gasoline only
Octane Rating	91 (Research Octane Number 96) or higher
Fuel tank capacity (Reference)	17.5 gal. (66.4 L, 14.6 Imp. gal.)

Lubrication system

■ **Oil capacity (Drain and refill [Reference *])**

With filter	<ul style="list-style-type: none"> ▶ RC350 6.0 qt. (5.7 L, 5.0 Imp. qt.) ▶ RC350 AWD/RC300 AWD 6.8 qt. (6.4 L, 5.6 Imp. qt.) ▶ RC300 4.9 qt. (4.6 L, 4.0 Imp. qt.)
Without filter	<ul style="list-style-type: none"> ▶ RC350 5.8 qt. (5.5 L, 4.8 Imp. qt.) ▶ RC350 AWD/RC300 AWD 6.3 qt. (6.0 L, 5.3 Imp. qt.) ▶ RC300 4.5 qt. (4.3 L, 3.8 Imp. qt.)

* : The engine oil capacity is a reference quantity to be used when changing the engine oil. Warm up and turn off the engine, wait more than 5 minutes, and check the oil level on the dipstick.

■ **Engine oil selection**

“Toyota Genuine Motor Oil” is used in your Lexus vehicle. Use Lexus approved “Toyota Genuine Motor Oil” or equivalent to satisfy the following grade and viscosity.

Oil grade: ILSAC GF-5 multigrade engine oil

Recommended viscosity: SAE 0W-20

SAE 0W-20 is the best choice for good fuel economy and good starting in cold weather.

If SAE 0W-20 is not available, SAE 5W-20 oil may be used. However, it must be replaced with SAE 0W-20 at the next oil change.

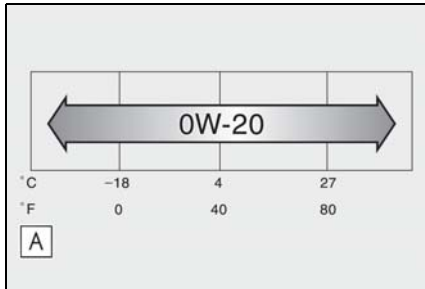

A Outside temperature

Oil viscosity (0W-20 is explained here as an example):

- The 0W in 0W-20 indicates the characteristic of the oil which allows cold startability. Oils with a lower value before the W allow for easier starting of the engine in cold weather.
- The 20 in 0W-20 indicates the viscosity characteristic of the oil when the oil is at high temperature. An oil with a higher viscosity (one with a

higher value) may be better suited if the vehicle is operated at high speeds, or under extreme load conditions.

How to read oil container label:

The International Lubricant Specification Advisory Committee (ILSAC) Certification Mark is added to some oil containers to help you select the oil you should use.



Cooling system

Capacity*	RC350/RC300 AWD	10.0 qt. (9.5 L, 8.4 Imp. qt.)
	RC300	<ul style="list-style-type: none"> ▶ Gasoline engine 8.5 qt. (8.0 L, 7.0 Imp. qt.) ▶ Intercooler 3.3 qt. (3.1 L, 2.7 Imp. qt.)
Coolant type	Use either of the following: <ul style="list-style-type: none"> • “Toyota Super Long Life Coolant” • Similar high-quality ethylene glycol-based non-silicate, non-amine, non-nitrite, and non-borate coolant with long-life hybrid organic acid technology Do not use plain water alone.	

* : The fluid capacity is a reference quantity.
 If replacement is necessary, contact your Lexus dealer.

Ignition system (spark plug)

■ Spark plug

	RC350/RC300 AWD	RC300
Make	DENSO FK20HBR8	NGK DILFR7K9G
Gap	0.031 in. (0.8 mm)	0.035 in. (0.9 mm)

NOTICE

■ Iridium-tipped spark plugs

Use only iridium-tipped spark plugs. Do not adjust the spark plug gap.

Electrical system (battery)

Open voltage at 68°F (20°C):	12.3 V or higher If the voltage is lower than the standard value, charge the battery. (Voltage is checked 20 minutes after the engine and all lights are turned off.)
Charging rates	5 A max.

Automatic transmission

Fluid capacity *	<ul style="list-style-type: none"> ▶ RC350 10.0 qt. (9.5 L, 8.4 Imp. qt.) ▶ RC350 AWD/RC300 AWD 10.6 qt. (10.0 L, 8.8 Imp. qt.) ▶ RC300 9.2 qt. (8.7 L, 7.7 Imp. qt.)
Fluid type	Toyota Genuine ATF WS

*: The fluid capacity is a reference quantity.
If replacement is necessary, contact your Lexus dealer.

 NOTICE

Transmission fluid type

Using transmission fluid other than the above type may cause abnormal noise or vibration, or damage the transmission of your vehicle.

Front differential (AWD models)

Oil capacity	0.74 qt. (0.70 L, 0.61 Imp. qt.)
Oil type and viscosity	Hypoid gear oil API GL-5 Above 0°F (-18°C): SAE90 Below 0°F (-18°C): SAE80W or SAE80W-90

Rear differential

▶ Vehicles without LSD (Limited Slip Differential)

Oil capacity	1.42 qt. (1.35 L, 1.19 Imp. qt.)
Oil type and viscosity	Toyota Genuine Differential Gear Oil LT 75W-85 GL-5 or equivalent *

▶ Vehicles with LSD (Limited Slip Differential)

Oil capacity	1.42 qt. (1.35 L, 1.19 Imp. qt.)
Oil type and viscosity	Toyota Genuine Differential Gear Oil LX 75W-85 GL-5 or equivalent *

*: Your Lexus vehicle is filled with "Toyota Genuine Differential Gear Oil" at the factory.

Use Lexus approved “Toyota Genuine Differential Gear Oil” or an equivalent oil of matching quality to satisfy the above specification. Please contact your Lexus dealer for further details.

Brakes

Pedal clearance *	▶ RC350 AWD/RC300 AWD 4.5 in. (115 mm) Min. ▶ RC350/RC300 4.1 in. (104 mm) Min.
Pedal free play	0.04—0.24 in. (1.0—6.0 mm)
Brake pad wear limit	0.04 in. (1.0 mm)
Parking brake lining wear limit	0.04 in. (1.0 mm)
Fluid type	SAE J1703 or FMVSS No.116 DOT 3, or SAE J1704 or FMVSS No.116 DOT 4 brake fluid

*: Minimum pedal clearance when depressed with a force of 112.4 lbf (500 N, 51.0 kgf) while the engine is running.

Steering

Free play	Less than 1.2 in. (30 mm)
-----------	---------------------------

Tires and wheels

▶ Type A

Tire size	235/45R18 94Y, T155/70D17 110M (spare)
Tire inflation pressure (Recommended cold tire inflation pressure)	Driving under normal conditions Front: 35 psi (240 kPa, 2.4 kgf/cm ² or bar) Rear: 35 psi (240 kPa, 2.4 kgf/cm ² or bar) Spare: 60 psi (420 kPa, 4.2 kgf/cm ² or bar) Driving at high speeds (above 100 mph [160 km/h]) (in countries where such speeds are permitted by law) Add 3 psi (20 kPa, 0.2 kgf/cm ² or bar) to the front tires, 6 psi (40 kPa, 0.4 kgf/cm ² or bar) to the rear tires. Never exceed the maximum cold tire inflation pressure indicated on the tire sidewall.

Wheel size	18 x 8J, 17 x 4T (spare)
Wheel nut torque	76 ft•lbf (103 N•m, 10.5 kgf•m)

► Type B

Tire size	235/45R18 94Y, T145/70D18 107M (spare)
Tire inflation pressure (Recommended cold tire inflation pressure)	<p>Driving under normal conditions</p> <p>Front: 35 psi (240 kPa, 2.4 kgf/cm² or bar)</p> <p>Rear: 35 psi (240 kPa, 2.4 kgf/cm² or bar)</p> <p>Spare: 60 psi (420 kPa, 4.2 kgf/cm² or bar)</p> <p>Driving at high speeds (above 100 mph [160 km/h]) (in countries where such speeds are permitted by law)</p> <p>Add 3 psi (20 kPa, 0.2 kgf/cm² or bar) to the front tires, 6 psi (40 kPa, 0.4 kgf/cm² or bar) to the rear tires. Never exceed the maximum cold tire inflation pressure indicated on the tire sidewall.</p>
Wheel size	18 x 8J, 18x 4T (spare)
Wheel nut torque	76 ft•lbf (103 N•m, 10.5 kgf•m)

► Type C

Tire size	P235/45R18 94V, T155/70D17 110M (spare)
Tire inflation pressure (Recommended cold tire inflation pressure)	<p>Driving under normal conditions</p> <p>Front: 35 psi (240 kPa, 2.4 kgf/cm² or bar)</p> <p>Rear: 35 psi (240 kPa, 2.4 kgf/cm² or bar)</p> <p>Spare: 60 psi (420 kPa, 4.2 kgf/cm² or bar)</p> <p>Driving at high speeds (above 100 mph [160 km/h]) (in countries where such speeds are permitted by law)</p> <p>Add 3 psi (20 kPa, 0.2 kgf/cm² or bar) to the front tires, 6 psi (40 kPa, 0.4 kgf/cm² or bar) to the rear tires. Never exceed the maximum cold tire inflation pressure indicated on the tire sidewall.</p>
Wheel size	18 x 8J, 17 x 4T (spare)
Wheel nut torque	76 ft•lbf (103 N•m, 10.5 kgf•m)

► Type D

Tire size	P235/45R18 94V, T145/70D18 107M (spare)
Tire inflation pressure (Recommended cold tire inflation pressure)	<p>Driving under normal conditions</p> <p>Front: 35 psi (240 kPa, 2.4 kgf/cm² or bar)</p> <p>Rear: 35 psi (240 kPa, 2.4 kgf/cm² or bar)</p> <p>Spare: 60 psi (420 kPa, 4.2 kgf/cm² or bar)</p> <p>Driving at high speeds (above 100 mph [160 km/h]) (in countries where such speeds are permitted by law)</p> <p>Add 3 psi (20 kPa, 0.2 kgf/cm² or bar) to the front tires, 6 psi (40 kPa, 0.4 kgf/cm² or bar) to the rear tires. Never exceed the maximum cold tire inflation pressure indicated on the tire sidewall.</p>
Wheel size	18 × 8J, 18 × 4T (spare)
Wheel nut torque	76 ft•lbf (103 N•m, 10.5 kgf•m)

► Type E

Tire size	235/40R19 96V, T155/70D17 110M (spare)
Tire inflation pressure (Recommended cold tire inflation pressure)	<p>Driving under normal conditions</p> <p>Front: 35 psi (240 kPa, 2.4 kgf/cm² or bar)</p> <p>Rear: 36 psi (250 kPa, 2.5 kgf/cm² or bar)</p> <p>Spare: 60 psi (420 kPa, 4.2 kgf/cm² or bar)</p> <p>Driving at high speeds (above 100 mph [160 km/h]) (in countries where such speeds are permitted by law)</p> <p>Add 6 psi (40 kPa, 0.4 kgf/cm² or bar) to the front tires, 8 psi (50 kPa, 0.5 kgf/cm² or bar) to the rear tires. Never exceed the maximum cold tire inflation pressure indicated on the tire sidewall.</p>
Wheel size	19 × 8J, 17 × 4T (spare)
Wheel nut torque	76 ft•lbf (103 N•m, 10.5 kgf•m)

► Type F

Tire size	235/40R19 96V, T145/70D18 107M (spare)
Tire inflation pressure (Recommended cold tire inflation pressure)	<p>Driving under normal conditions</p> <p>Front: 35 psi (240 kPa, 2.4 kgf/cm² or bar)</p> <p>Rear: 36 psi (250 kPa, 2.5 kgf/cm² or bar)</p> <p>Spare: 60 psi (420 kPa, 4.2 kgf/cm² or bar)</p> <p>Driving at high speeds (above 100 mph [160 km/h]) (in countries where such speeds are permitted by law)</p> <p>Add 6 psi (40 kPa, 0.4 kgf/cm² or bar) to the front tires, 8 psi (50 kPa, 0.5 kgf/cm² or bar) to the rear tires. Never exceed the maximum cold tire inflation pressure indicated on the tire sidewall.</p>
Wheel size	19 × 8J, 18 × 4T (spare)
Wheel nut torque	76 ft•lbf (103 N•m, 10.5 kgf•m)

► Type G

Tire size	<p>Front tires: 235/40R19 96Y XL</p> <p>Rear tires: 265/35R19 94Y</p> <p>Spare tire: T155/70D17 110M</p>
Tire inflation pressure (Recommended cold tire inflation pressure)	<p>Driving under normal conditions</p> <p>Front: 35 psi (240 kPa, 2.4 kgf/cm² or bar)</p> <p>Rear: 36 psi (250 kPa, 2.5 kgf/cm² or bar)</p> <p>Spare: 60 psi (420 kPa, 4.2 kgf/cm² or bar)</p> <p>Driving at high speeds (above 100 mph [160 km/h]) (in countries where such speeds are permitted by law)</p> <p>Add 6 psi (40 kPa, 0.4 kgf/cm² or bar) to the front tires. Never exceed the maximum cold tire inflation pressure indicated on the tire sidewall.</p>
Wheel size	<p>Front wheels: 19 × 8J</p> <p>Rear wheels: 19 × 9J</p> <p>Spare wheel: 17 × 4T</p>
Wheel nut torque	76 ft•lbf (103 N•m, 10.5 kgf•m)

► Type H

Tire size	Front tires: 235/40R19 96Y XL Rear tires: 265/35R19 94Y Spare tire: T145/70D18 107M
Tire inflation pressure (Recommended cold tire inflation pressure)	Driving under normal conditions Front: 35 psi (240 kPa, 2.4 kgf/cm ² or bar) Rear: 36 psi (250 kPa, 2.5 kgf/cm ² or bar) Spare: 60 psi (420 kPa, 4.2 kgf/cm ² or bar) Driving at high speeds (above 100 mph [160 km/h]) (in countries where such speeds are permitted by law) Add 6 psi (40 kPa, 0.4 kgf/cm ² or bar) to the front tires. Never exceed the maximum cold tire inflation pressure indicated on the tire sidewall.
Wheel size	Front wheels: 19 × 8J Rear wheels: 19 × 9J Spare wheel: 18 × 4T
Wheel nut torque	76 ft•lbf (103 N•m, 10.5 kgf•m)

Light bulbs

	Light bulbs	Bulb No.	W	Type
Exterior	Rear turn signal lights	—	21	A
Interior	Vanity lights	—	8	B
	Footwell lights	194	3.8	B
	Trunk light	—	5	B

A: Wedge base bulbs (amber)

B: Wedge base bulbs (clear)

Fuel information

You must only use unleaded gasoline.

Select premium unleaded gasoline with an octane rating of 91 (Research Octane Number 96) or higher required for optimum engine performance and fuel economy.

If the octane rating is less than 91, damage to the engine may occur and may void the vehicle warranty.

At minimum, the gasoline you use should meet the specifications of ASTM D4814 in the U.S.A..

Gasoline quality

In very few cases, driveability problems may be caused by the brand of gasoline you are using. If driveability problems persist, try changing the brand of gasoline. If this does not correct the problem, consult your Lexus dealer.

Recommendation of the use of gasoline containing detergent additives

- Lexus recommends the use of gasoline that contains detergent additives to avoid the build-up of engine deposits.
- All gasoline sold in the U.S.A. contains minimum detergent additives to clean and/or keep clean intake systems, per EPA's lowest additives concentration program.
- Lexus strongly recommends the use of Top Tier Detergent Gasoline. For more information on Top Tier Detergent Gasoline and a list of marketers, please go to the official website www.toptiergas.com.

Recommendation of the use of low emissions gasoline

Gasolines containing oxygenates such as ethers and ethanol, as well as reformulated

gasolines, are available in some cities. These fuels are typically acceptable for use, providing they meet other fuel requirements.

Lexus recommends these fuels, since the formulations allow for reduced vehicle emissions.

Non-recommendation of the use of blended gasoline

- Use only gasoline containing up to 15% ethanol. DO NOT use any flex-fuel or gasoline that could contain more than 15% ethanol, including from any pump labeled E30 (30% ethanol [A]), E50 (50% ethanol [B]), E85 (85% ethanol [C]) (which are only some examples of fuel containing more than 15% ethanol).

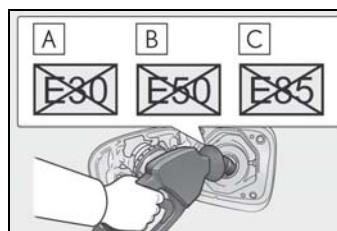

- If you use gasohol in your vehicle, be sure that it has an octane rating no lower than 91.
- Lexus does not recommend the use of gasoline containing methanol.

Non-recommendation of the use of gasoline containing MMT

Some gasoline contains an octane enhancing additive called MMT (Methylcyclopentadienyl Manganese Tricarbonyl).

Lexus does not recommend the use of gasoline that contains MMT. If fuel containing MMT is used, your emission control system may be adversely affected.

The malfunction indicator lamp on the instrument cluster may come on. If this happens, contact your Lexus dealer for service.

If your engine knocks

- Consult your Lexus dealer.
- You may occasionally notice light knocking for a short time while accelerating or

driving uphill. This is normal and there is no need for concern.

 NOTICE

■ **Notice on fuel quality**

- Do not use improper fuels. If improper fuels are used, the engine will be damaged.
- Do not use leaded gasoline. Leaded gasoline can cause damage to your vehicle's three-way catalytic converters causing the emission control system to malfunction.
- Do not use gasohol other than the type previously stated. Other gasohol may cause fuel system damage or vehicle performance problems.
- Using unleaded gasoline with an octane number or rating lower than the level previously stated may cause persistent heavy knocking. At worst, this may lead to engine damage and will void the vehicle warranty.

■ **When refueling with gasohol**

Take care not to spill gasohol. It can damage your vehicle's paint.

■ **Fuel-related poor driveability**

If poor driveability (poor hot starting, vaporization, engine knocking, etc.) is encountered after using a different type of fuel, discontinue the use of that type of fuel.

► Compact spare tire

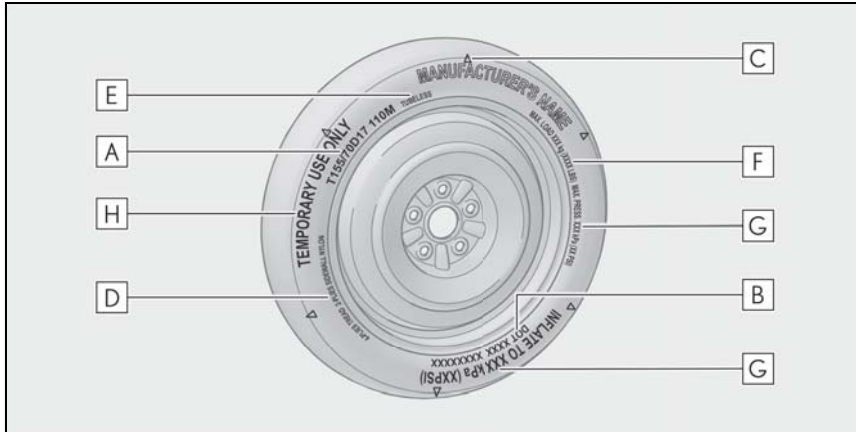

A Tire size (→P.343)

B DOT and Tire Identification Number (TIN) (→P.342)

C Location of treadwear indicators (→P.265)

D Tire ply composition and materials

Ply is a layer of rubber-coated parallel cords. Cords are the strands which form the plies in a tire.

E TUBELESS or TUBE TYPE

A tubeless tire does not have a tube and air is directly put into the tire. A tube type tire has a tube inside the tire and the tube maintains the air pressure.

F Load limit at maximum cold tire inflation pressure (→P.345)

G Maximum cold tire inflation pressure (→P.345)

This means the pressure to which a tire may be inflated.

H "TEMPORARY USE ONLY"

A compact spare tire is identified by the phrase "TEMPORARY USE ONLY" molded on its sidewall. This tire is designed for temporary emergency use only.

Typical DOT and Tire Identification Number (TIN)

► Type A

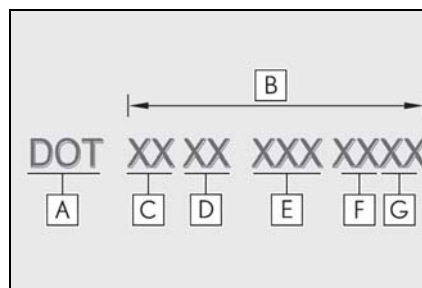

- A** DOT symbol*
- B** Tire Identification Number (TIN)
- C** Tire manufacturer's identification mark
- D** Tire size code
- E** Manufacturer's optional tire type code (3 or 4 letters)
- F** Manufacturing week
- G** Manufacturing year

*: The DOT symbol certifies that the tire conforms to applicable Federal Motor Vehicle Safety Standards.

► Type B

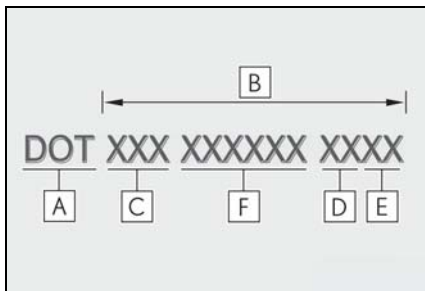

- A** DOT symbol*
- B** Tire Identification Number (TIN)
- C** Tire manufacturer's identification mark
- D** Manufacturing week
- E** Manufacturing year
- F** Manufacturer's code

*: The DOT symbol certifies that the tire conforms to applicable Federal Motor Vehicle Safety Standards.

Tire size

■ Typical tire size information

The illustration indicates typical tire size.

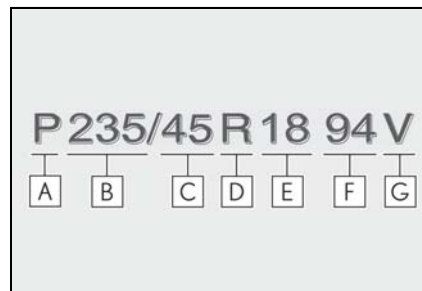

- A** Tire use (P = Passenger car, T = Temporary use)
- B** Section width (millimeters)
- C** Aspect ratio (tire height to section width)
- D** Tire construction code (R = Radial, D = Diagonal)
- E** Wheel diameter (inches)
- F** Load index (2 digits or 3 digits)
- G** Speed symbol (alphabet with one letter)

■ Tire dimensions

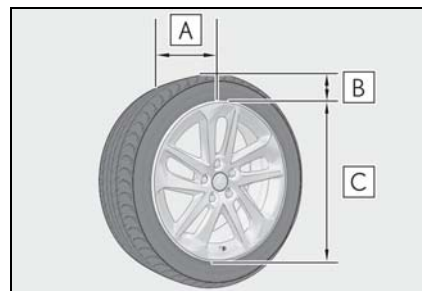

- A** Section width
- B** Tire height

C Wheel diameter

Tire section names

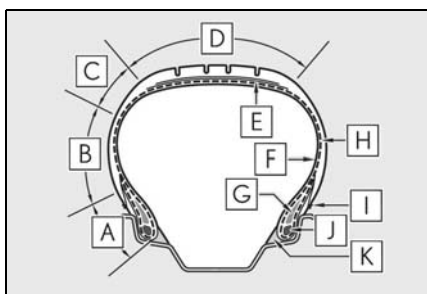

- A** Bead
- B** Sidewall
- C** Shoulder
- D** Tread
- E** Belt
- F** Inner liner
- G** Reinforcing rubber
- H** Carcass
- I** Rim lines
- J** Bead wires
- K** Chafer

Uniform Tire Quality Grading

This information has been prepared in accordance with regulations issued by the National Highway Traffic Safety Administration of the U.S. Department of Transportation.

It provides the purchasers and/or prospective purchasers of Lexus vehicles with information on uniform tire quality grading.

Your Lexus dealer will help answer any

questions you may have as you read this information.

■ **DOT quality grades**

All passenger vehicle tires must conform to Federal Safety Requirements in addition to these grades. Quality grades can be found where applicable on the tire sidewall between tread shoulder and maximum section width.

For example: Treadwear 200 Traction AA Temperature A

■ **Treadwear**

The treadwear grade is a comparative rating based on the wear rate of the tire when tested under controlled conditions on a specified government test course.

For example, a tire graded 150 would wear one and a half (1 - 1/2) times as well on the government course as a tire graded 100. The relative performance of tires depends upon the actual conditions of their use. Performance may differ significantly from the norm due to variations in driving habits, service practices and differences in road characteristics and climate.

■ **Traction AA, A, B, C**

The traction grades, from highest to lowest, are AA, A, B and C, and they represent the tire's ability to stop on wet pavement as measured under controlled conditions on specified government test surfaces of asphalt and concrete.

A tire marked C may have poor traction performance.

Warning: The traction grade assigned to this tire is based on braking (straight ahead) traction tests and does not include

cornering (turning) traction.

■ **Temperature A, B, C**

The temperature grades are A (the highest), B, and C, representing the tire’s resistance to the generation of heat and its ability to dissipate heat when tested under controlled conditions on a specified indoor laboratory test wheel.

Sustained high temperature can cause the material of the tire to degenerate and reduce tire life, and excessive temperature can lead to sudden tire failure.

Grade C corresponds to a level of performance which all passenger car tires must meet under the Federal Motor Vehicle Safety Standard No. 109.

Grades B and A represent higher levels of performance on the laboratory test wheel than the minimum required by law.

Warning: The temperature grades of a tire assume that it is properly inflated and not overloaded.

Excessive speed, underinflation, or excessive loading, either separately or in combination, can cause heat buildup and possible tire failure.

Glossary of tire terminology

Tire related term	Meaning
Cold tire inflation pressure	Tire pressure when the vehicle has been parked for three hours or more, or has not been driven more than 1 mile or 1.5 km under that condition
Maximum inflation pressure	The maximum cold inflated pressure to which a tire may be inflated, shown on the sidewall of the tire
Recommended inflation pressure	Cold tire inflation pressure recommended by a manufacturer
Accessory weight	The combined weight (in excess of those standard items which may be replaced) of automatic transmission, power steering, power brakes, power windows, power seats, radio and heater, to the extent that these items are available as factory-installed equipment (whether installed or not)
Curb weight	The weight of a motor vehicle with standard equipment, including the maximum capacity of fuel, oil and coolant, and if so equipped, air conditioning and additional weight optional engine

Tire related term	Meaning
Maximum loaded vehicle weight	The sum of: (a) Curb weight (b) Accessory weight (c) Vehicle capacity weight (d) Production options weight
Normal occupant weight	150 lb. (68 kg) times the number of occupants specified in the second column of Table 1* that follows
Occupant distribution	Distribution of occupants in a vehicle as specified in the third column of Table 1* below
Production options weight	The combined weight of installed regular production options weighing over 5 lb. (2.3 kg) in excess of the standard items which they replace, not previously considered in curb weight or accessory weight, including heavy duty brakes, ride levelers, roof rack, heavy duty battery, and special trim
Rim	A metal support for a tire or a tire and tube assembly upon which the tire beads are seated
Rim diameter (Wheel diameter)	Nominal diameter of the bead seat
Rim size designation	Rim diameter and width
Rim type designation	The industry manufacturer's designation for a rim by style or code
Rim width	Nominal distance between rim flanges
Vehicle capacity weight (Total load capacity)	The rated cargo and luggage load plus 150 lb. (68 kg) times the vehicle's designated seating capacity
Vehicle maximum load on the tire	The load on an individual tire that is determined by distributing to each axle its share of the maximum loaded vehicle weight, and dividing by two
Vehicle normal load on the tire	The load on an individual tire that is determined by distributing to each axle its share of curb weight, accessory weight, and normal occupant weight (distributed in accordance with Table 1* below), and dividing by two
Weather side	The surface area of the rim not covered by the inflated tire

Tire related term	Meaning
Bead	The part of the tire that is made of steel wires, wrapped or reinforced by ply cords and that is shaped to fit the rim
Bead separation	A breakdown of the bond between components in the bead
Bias ply tire	A pneumatic tire in which the ply cords that extend to the beads are laid at alternate angles substantially less than 90 degrees to the centerline of the tread
Carcass	The tire structure, except tread and sidewall rubber which, when inflated, bears the load
Chunking	The breaking away of pieces of the tread or sidewall
Cord	The strands forming the plies in the tire
Cord separation	The parting of cords from adjacent rubber compounds
Cracking	Any parting within the tread, sidewall, or innerliner of the tire extending to cord material
CT	A pneumatic tire with an inverted flange tire and rim system in which the rim is designed with rim flanges pointed radially inward and the tire is designed to fit on the underside of the rim in a manner that encloses the rim flanges inside the air cavity of the tire
Extra load tire	A tire designed to operate at higher loads and at higher inflation pressures than the corresponding standard tire
Groove	The space between two adjacent tread ribs
Innerliner	The layer(s) forming the inside surface of a tubeless tire that contains the inflating medium within the tire
Innerliner separation	The parting of the innerliner from cord material in the carcass

Tire related term	Meaning
Intended outboard sidewall	(a) The sidewall that contains a whitewall, bears white lettering, or bears manufacturer, brand, and/or model name molding that is higher or deeper than the same molding on the other sidewall of the tire, or (b) The outward facing sidewall of an asymmetrical tire that has a particular side that must always face outward when mounted on a vehicle
Light truck (LT) tire	A tire designated by its manufacturer as primarily intended for use on lightweight trucks or multipurpose passenger vehicles
Load rating	The maximum load that a tire is rated to carry for a given inflation pressure
Maximum load rating	The load rating for a tire at the maximum permissible inflation pressure for that tire
Maximum permissible inflation pressure	The maximum cold inflation pressure to which a tire may be inflated
Measuring rim	The rim on which a tire is fitted for physical dimension requirements
Open splice	Any parting at any junction of tread, sidewall, or innerliner that extends to cord material
Outer diameter	The overall diameter of an inflated new tire
Overall width	The linear distance between the exteriors of the sidewalls of an inflated tire, including elevations due to labeling, decorations, or protective bands or ribs
Passenger car tire	A tire intended for use on passenger cars, multipurpose passenger vehicles, and trucks, that have a gross vehicle weight rating (GVWR) of 10,000 lb. or less.
Ply	A layer of rubber-coated parallel cords
Ply separation	A parting of rubber compound between adjacent plies
Pneumatic tire	A mechanical device made of rubber, chemicals, fabric and steel or other materials, that, when mounted on an automotive wheel, provides the traction and contains the gas or fluid that sustains the load

Tire related term	Meaning
Radial ply tire	A pneumatic tire in which the ply cords that extend to the beads are laid at substantially 90 degrees to the centerline of the tread
Reinforced tire	A tire designed to operate at higher loads and at higher inflation pressures than the corresponding standard tire
Section width	The linear distance between the exteriors of the sidewalls of an inflated tire, excluding elevations due to labeling, decoration, or protective bands
Sidewall	That portion of a tire between the tread and bead
Sidewall separation	The parting of the rubber compound from the cord material in the sidewall
Snow tire	A tire that attains a traction index equal to or greater than 110, compared to the ASTM E-1136 Standard Reference Test Tire, when using the snow traction test as described in ASTM F-1805-00, Standard Test Method for Single Wheel Driving Traction in a Straight Line on Snow-and Ice-Covered Surfaces, and which is marked with an Alpine Symbol () on at least one sidewall
Test rim	The rim on which a tire is fitted for testing, and may be any rim listed as appropriate for use with that tire
Tread	That portion of a tire that comes into contact with the road
Tread rib	A tread section running circumferentially around a tire
Tread separation	Pulling away of the tread from the tire carcass
Treadwear indicators (TWI)	The projections within the principal grooves designed to give a visual indication of the degrees of wear of the tread
Wheel-holding fixture	The fixture used to hold the wheel and tire assembly securely during testing

* : Table 1 - Occupant loading and distribution for vehicle normal load for various designated seating capacities

Designated seating capacity, Number of occupants	Vehicle normal load, Number of occupants	Occupant distribution in a normally loaded vehicle
2 through 4	2	2 in front
5 through 10	3	2 in front, 1 in second seat
11 through 15	5	2 in front, 1 in second seat, 1 in third seat, 1 in fourth seat
16 through 20	7	2 in front, 2 in second seat, 2 in third seat, 1 in fourth seat

Customizable features



Your vehicle includes a variety of electronic features that can be personalized to your preferences. The settings of these features can be changed by using the meter control switches, the Remote Touch or at your Lexus dealer.

Various setting can be changed. Refer to the list of settings that can be changed for details.

For details on the Remote Touch, refer to the "NAVIGATION AND MULTI-MEDIA SYSTEM OWNER'S MANUAL".

Customizing vehicle features

■ **Changing by using the meter control switches**

- 1 Press  or  to select .
- 2 Operate the switches to select a desired item.
- 3 Change the setting by referring to the message displayed on the screen.

■ **Changing by using the Remote Touch**

- 1 Press the "MENU" button on the Remote Touch.
- 2 Select "Setup" on the menu screen and select "Vehicle".
- 3 Select "Vehicle Customization", "LEXUS Park Assist" or "Drive Mode Customization".

■ **When customizing using the Remote Touch**

Stop the vehicle in a safe place, apply the parking brake, and shift the shift lever to P. Also, to prevent battery discharge, leave the engine running while customizing the features.

 **WARNING**

■ **During customization**

As the engine needs to be running during customization, ensure that the vehicle is parked in a place with adequate ventilation. In a closed area such as a garage, exhaust gases including harmful carbon monoxide (CO) may collect and enter the vehicle. This may lead to death or a serious health hazard.

 **NOTICE**

■ **During customization**

To prevent battery discharge, ensure that the engine is running while customizing features.

Customizable features

Some function settings are changed simultaneously with other functions being customized. Contact your Lexus dealer for further details.

- A** Settings that can be changed using the Remote Touch
- B** Settings that can be changed using the meter control switches
- C** Settings that can be changed by your Lexus dealer

Definition of symbols: ○ = Available, – = Not available

■ Gauges, meters and multi-information display (→P.62, 66, 71)

Function ^{*1}	Default setting	Customized setting	A	B	C
Language	English	French	○	○	–
		Spanish			
Units ^{*2}	miles (MPG US)	km (km/L)	○	○	–
		km (L/100 km)			
		miles (MPG Imperial)			
 Switch settings ^{*3}	Drive information 1	Desired status screen ^{*4}	–	○	–
Drive information 1	Current fuel consumption	Customizable items: →P.73	–	○	–
	Average fuel economy (after reset)				
Drive information 2	Distance (driving range)				
	Average vehicle speed (after reset)				
Drive information 3	Average fuel consumption (after refuel)				
	Elapsed time (after start)				
Pop-up display	On	Off	–	○	–
Accent color ^{*3}	Color 1	Color 2	○	○	–
Needle ^{*5}	Color 1	Color 2	–	○	–
		Color 3			

Function ^{*1}	Default setting	Customized setting	A	B	C
Rev indicator ^{*5}	5000 r/min.	Select to set the desired engine speed at which the Rev indicator will begin to be displayed.	-	○	-
		Off			
Rev peak ^{*5}	On	Off	-	○	-
Speed indicator ^{*5}	Off	On	-	○	-
Speed indicator settings ^{*5}	75 mph (120 km/h)	30 mph to 100 mph (50 km/h to 160km/h) ^{*6}	-	○	-
Eco Driving Indicator Light	On	Off	-	○	-
Clock ^{*7}	12-hour display	24-hour display	-	○	-

^{*1}: For details about each function: →P.76

^{*2}: The default setting varies according to country.

^{*3}: Except F SPORT models

^{*4}: Some status screens cannot be registered (indicated on the multi-information display)

^{*5}: F SPORT models

^{*6}: Always observe the legal speed limit when driving on public roads.

^{*7}: On multi-information display

■ Door lock (→P.88, 91, 317)

Function	Default setting	Customized setting	A	B	C
Unlocking using a mechanical key	Driver's door unlocked in one step, both side doors unlocked in two steps	Both side doors unlocked in one step	-	-	○
Automatic door lock	Shifting the shift lever to position other than P	Off			
		Vehicle speed is approximately 12 mph (20 km/h) or higher	○	-	○

Function	Default setting	Customized setting	A	B	C
Automatic door unlock	Shifting the shift lever to P	Off	○	-	○
		Driver's door is opened			
Locking/unlocking of the trunk when both side doors are locked/unlocked	On	Off	-	-	○

■ Smart access system with push-button start and wireless remote control (→P.88, 91)

Function	Default setting	Customized setting	A	B	C
Operation buzzer volume	5	Off	○	-	○
		1 to 7			
Operation signal (Emergency flashers)	On	Off	○	-	○
Time elapsed before automatic door lock function is activated if door is not opened after being unlocked	60 seconds	Off	○	-	○
		30 seconds			
		120 seconds			
Open door warning buzzer	On	Off	-	-	○
Welcome light illumination control	On	Off	○	-	○

■ Smart access system with push-button start (→P.88, 91, 95)

Function	Default setting	Customized setting	A	B	C
Smart access system with push-button start	On	Off	-	-	○
Smart door unlocking	Driver's door	Both side doors	○	-	○
Number of consecutive door lock operations	2 times	As many as desired	-	-	○

■ **Wireless remote control** (→P.84, 88, 91)

Function	Default setting	Customized setting	A	B	C
Wireless remote control	On	Off	-	-	○
Unlocking operation	Driver's door unlocked in one step, both side doors unlocked in two steps	Both side doors unlocked in one step	○	-	○
Trunk unlocking operation	Press and hold (short)	One short press	-	-	○
		Push twice			
		Press and hold (long)			
		Off			
Alarm (panic mode)	On	Off	-	-	○

■ **Driving position memory** * (→P.102)

Function	Default setting	Customized setting	A	B	C
Selecting the door linking driving position memory with door unlock operation	Driver's door	Both side doors	-	-	○

* : If equipped

■ **Power easy access system** (→P.102)

Function	Default setting	Customized setting	A	B	C
Driver's seat movement when exiting the vehicle	Full	Off	○	-	○
		Partial			
Steering wheel movement *	On	Off	-	-	○

* : If equipped

■ Power windows (→P.112)

Function	Default setting	Customized setting	A	B	C
Mechanical key linked operation	Off	On	-	-	○
Wireless remote control linked operation	Off	On (Open only)	-	-	○
Wireless remote control linked operation signal (buzzer)	On	Off	-	-	○

■ Moon roof* (→P.114)

Function	Default setting	Customized setting	A	B	C
Mechanical key linked operation	Off	On	-	-	○
Wireless remote control linked operation	Off	On (Open only)	-	-	○
Wireless remote control linked operation signal (buzzer)	On	Off	-	-	○

* : If equipped

■ Turn signal lever (→P.136)

Function	Default setting	Customized setting	A	B	C
The number of times the turn signal lights flash automatically when the turn signal lever is moved to the first position during a lane change* ¹	3	5	-	-	○
		7			
		Off* ²			
		Off* ³			

*¹: After flashing the turn signal lights when turning left or right while this function is off and the turn signal lever is moved to the first position in the direction of the flashing light, the turn signal lights can be selected to be flashing or off.

*²: The turn signal lights keep flashing if the turn signal lever is moved to the first position in the direction of flashing light.

*³: The turn signal lights will be off if the turn signal lever is moved to the first position in the direction of flashing light.

■ Automatic light control system (→P.142)

Function	Default setting	Customized setting	A	B	C
Light sensor sensitivity	Standard	-2 to 2	<input type="radio"/>	-	<input type="radio"/>
Time elapsed before head-lights automatically turn off after doors are closed	30 seconds	Off	<input type="radio"/>	-	<input type="radio"/>
		60 seconds			
		90 seconds			

■ Lights (→P.142)

Function	Default setting	Customized setting	A	B	C
Daytime running light system (except Canada)	On	Off	<input type="radio"/>	-	<input type="radio"/>

■ PCS (Pre-Collision System) (→P.162)

Function	Default setting	Customized setting	A	B	C
PCS (Pre-Collision System)	On	Off	-	<input type="radio"/>	-
Adjust alert timing	Middle	Far	-	<input type="radio"/>	-
		Near			

■ LDA (Lane Departure Alert with steering control) (→P.169)

Function	Default setting	Customized setting	A	B	C
Steering assist function	On	Off	-	<input type="radio"/>	-
Alert type	Steering wheel vibration	Buzzer	-	<input type="radio"/>	-
Alert sensitivity	Standard	High	-	<input type="radio"/>	-
Vehicle sway warning function	On	Off	-	<input type="radio"/>	-
Vehicle sway warning sensitivity	Standard	High	-	<input type="radio"/>	-
		Low			

■ Intuitive parking assist* (→P.185)

Function	Default setting	Customized setting	A	B	C
Detection distance of the front center sensor	Far	Near	<input type="radio"/>	-	<input type="radio"/>
Detection distance of the rear center sensor	Far	Near	<input type="radio"/>	-	<input type="radio"/>
Buzzer volume	2	1 to 3	<input type="radio"/>	-	<input type="radio"/>

* : If equipped

■ Driving mode select switch (→P.199)

Function	Default setting	Customized setting	A	B	C
Powertrain control in custom mode*	Normal	Power	<input type="radio"/>	-	-
		Eco			
Chassis control in custom mode*	Normal	Sport	<input type="radio"/>	-	-
Air conditioning operation in custom mode*	Normal	Eco	<input type="radio"/>	-	-

* : If equipped

■ Automatic air conditioning system (→P.215)

Function	Default setting	Customized setting	A	B	C
A/C auto switch operation	On	Off	<input type="radio"/>	-	<input type="radio"/>
Exhaust gas sensor sensitivity	Standard	-3 to 3	<input type="radio"/>	-	<input type="radio"/>

■ Seat heaters* (→P.223)

Function	Default setting	Customized setting	A	B	C
Seat heater timer control	Off	On	<input type="radio"/>	-	<input type="radio"/>

* : If equipped

■ Illumination (→P.225)

Function	Default setting	Customized setting	A	B	C
Time elapsed before the interior lights turn off	15 seconds	Off	○	-	○
		7.5 seconds			
		30 seconds			
Operation after the engine switch is turned off	On	Off	-	-	○
Operation when the doors are unlocked	On	Off	-	-	○
Operation when you approach the vehicle with the electronic key on your person	On	Off	-	-	○
Remote Touch pad light	On	Off	-	-	○
Time elapsed before the outer foot lights turn off	15 seconds	Off	○	-	○
		7.5 seconds			
		30 seconds			
Operation of the outer foot lights when you approach the vehicle with the electronic key on your person	On	Off	-	-	○
Operation of the outer foot lights when the doors are unlocked with the power door lock switch	On	Off	-	-	○
Operation of the outer foot lights when a door is opened	On	Off	-	-	○
Fading out of the outer foot lights when they turn off	Long	Short	-	-	○

■ Seat belt reminder (→P.299)

Function	Default setting	Customized setting	A	B	C
Vehicle speed linked seat belt reminder buzzer	On	Off	-	-	○

■ Vehicle customization

● When the smart access system with push-button start is off, the entry unlock

function cannot be customized.

- When the doors remain closed after unlocking the doors and the timer activated automatic door lock function activates, signals will be generated in accordance with the operation buzzer volume and operational signal (Emergency flashers) function settings.
- Some settings can be changed using a switch or the Center Display. If a setting is changed using a switch, the changed setting will not be reflected on the Center Display screen until the engine switch is turned off and then to IGNITION ON mode.

Items to initialize

The following items must be initialized for normal system operation after such cases as the battery being reconnected, or maintenance being performed on the vehicle:

List of items to initialize

Item	When to initialize	Reference
Message indicating maintenance is required	After the maintenance is performed	P.248
Engine oil maintenance data	After changing the engine oil	P.260
Tire pressure warning system	<ul style="list-style-type: none"> • When rotating the tires • When changing the tire inflation pressure by changing traveling speed or load weight, etc. 	P.270

Certifications

Immobilizer system

FCC ID: NI4TMIMB-3

This device complies with part 15 of the FCC Rules. Operation is subject to the following two conditions: (1) This device may not cause harmful interference, and (2) this device must accept any interference received, including interference that may cause undesired operation.

Changes or modifications not expressly approved by the party responsible for compliance could void the user's authority to operate the equipment.

This device complies with Industry Canada's licence-exempt RSSs. Operation is subject to the following two conditions: (1) This device may not cause interference; and (2) This device must accept any interference, including interference that may cause undesired operation of the device.

Le présent appareil est conforme aux CNR d'Industrie Canada applicables aux appareils radio exempts de licence. L'exploitation est autorisée aux deux conditions suivantes : 1) l'appareil ne doit pas produire de brouillage; 2) l'utilisateur de l'appareil doit accepter tout brouillage radioélectrique subi, même si le brouillage est susceptible d'en compromettre le fonctionnement.

Smart access system with push-button start

FCC ID: NI4TMLF12-4

This device complies with part 15 of the FCC Rules. Operation is subject to the following two conditions: (1) This device may not cause harmful interference, and (2) this device must accept any interference received, including interference that may cause undesired operation.

Changes or modifications not expressly approved by the party responsible for compliance could void the user's authority to operate the equipment.

This device complies with Industry Canada's licence-exempt RSSs. Operation is subject to the following two conditions: (1) This device may not cause interference; and (2) This device must accept any interference, including interference that may cause undesired operation of the device.

Le présent appareil est conforme aux CNR d'Industrie Canada applicables aux appareils radio exempts de licence. L'exploitation est autorisée aux deux conditions suivantes : 1) l'appareil ne doit pas produire de brouillage; 2) l'utilisateur de l'appareil doit accepter tout brouillage radioélectrique subi, même si le brouillage est susceptible d'en compromettre le fonctionnement.

FCC ID:HYQ23ABL
FCC ID:HYQ14FLB
FCC ID:HYQ14CBM

NOTE:

This device complies with part 15 of the FCC Rules. Operation is subject to the following two conditions: (1) This device may not cause harmful interference, and (2) this device must accept any interference received, including interference that may cause undesired operation.

FCC WARNING:

Changes or modifications not expressly approved by the party responsible for compliance could void the user's authority to operate the equipment.

NOTE:

This device contains licence-exempt transmitter(s)/receiver(s) that comply with Innovation, Science and Economic Development Canada's licence-exempt RSS(s).

Operation is subject to the following two conditions:

- (1) This device may not cause interference.
- (2) This device must accept any interference, including interference that may cause undesired operation of the device.

NOTE:

L'émetteur/récepteur exempt de licence contenu dans le présent appareil est conforme aux CNR d'Innovation, Sciences et Développement économique Canada applicables aux appareils radio exempts de licence.

L'exploitation est autorisée aux deux conditions suivantes :

- (1) L'appareil ne doit pas produire de brouillage;
- (2) L'appareil doit accepter tout brouillage radioélectrique subi, même si le brouillage est susceptible d'en compromettre le fonctionnement.

Millimeter wave radar sensor

FCC ID: HYQDNMWR008

NOTE:

This device complies with part 15 of the FCC Rules. Operation is subject to the following two conditions: (1) This device may not cause harmful interference, and (2) this device must accept any interference received, including interference that may cause undesired operation.

FCC WARNING:

Changes or modifications not expressly approved by the party responsible for compliance could void the user's authority to operate the equipment.

Radiofrequency radiation exposure Information:

This equipment complies with FCC radiation exposure limits set forth for an uncontrolled environment. This equipment should be installed and operated with minimum distance of 20 cm between the radiator (antenna) and your body. This transmitter must not be co-located or operating in conjunction with any other antenna or transmitter.

NOTE:

This device contains licence-exempt transmitter(s)/receiver(s) that comply with Innovation, Science and Economic Development Canada's licence-exempt RSS(s). Operation is subject to the following two conditions:

- (1) This device may not cause interference.
- (2) This device must accept any interference, including interference that may cause undesired operation of the device.

This equipment complies with ISED radiation exposure limits set forth for an uncontrolled environment and meets RSS-102 of the ISED radio frequency (RF) Exposure rules. This equipment should be installed and operated keeping the radiator at least 20 cm or more away from person's body.

NOTE:

L'émetteur/récepteur exempt de licence contenu dans le présent appareil est conforme aux CNR d'Innovation, Sciences et Développement économique Canada applicables aux appareils radio exempts de licence. L'exploitation est autorisée aux deux conditions suivantes :

- 1) L'appareil ne doit pas produire de brouillage;
- 2) L'appareil doit accepter tout brouillage radioélectrique subi, même si le brouillage est susceptible d'en compromettre le fonctionnement.

Cet équipement est conforme aux limites d'exposition aux rayonnements énoncées pour un environnement non contrôlé et respecte les règles d'exposition aux fréquences radioélectriques (RF) CNR-102 de l'ISDE. Cet équipement doit être installé et utilisé en gardant une distance de 20 cm ou plus entre le dispositif rayonnant et le corps.

Intuitive parking assist sensor

This device complies with Part 15 of the FCC Rules. Operation is subject to the following two conditions; (1) This device may not cause harmful interference, and (2) this device must accept any interference received, including interference that may cause undesired operation.

This ISM device complies with Canadian ICES-001.

Cet appareil ISM est conforme à la norme NMB-001 du Canada.

Blind Spot Monitor

FCC ID : OAYSRR3A

This device complies with part 15 of the FCC Rules. Operation is subject to the following two conditions:

- (1) This device may not cause harmful interference, and
- (2) this device must accept any interference received, including interference that may cause undesired operation.

FCC Warning

Changes or modifications not expressly approved by the party responsible for compliance could void the user's authority to operate the equipment.

This device contains licence-exempt transmitter(s)/receiver(s) that comply with Innovation, Science and Economic Development Canada's licence-exempt RSS(s). Operation is subject to the following two conditions:

1. This device may not cause interference.
2. This device must accept any interference, including interference that may cause undesired operation of the device.

Radiofrequency radiation exposure information:

This equipment complies with radiation exposure limits set forth for an uncontrolled environment. This equipment should be installed and operated with minimum distance of 20 cm between the radiator and your body.

L'émetteur/récepteur exempt de licence contenu dans le présent appareil est conforme aux CNR d'Innovation, Sciences et Développement économique Canada applicables aux appareils radio exempts de licence. L'exploitation est autorisée aux deux conditions suivantes:

1. L'appareil ne doit pas produire de brouillage;
2. L'appareil doit accepter tout brouillage radioélectrique subi, même si le brouillage est susceptible d'en compromettre le fonctionnement.

Informations sur l'exposition aux rayonnements radiofréquences:

Cet équipement est conforme aux limites d'exposition aux rayonnements définies pour un environnement non contrôlé. Cet équipement doit être installé et utilisé avec un minimum de 20 cm de distance entre la source de rayonnement et votre corps.

Garage door opener

This device complies with FCC rules part 15 and Innovation, Science, and Economic Development Canada RSS-210. Operation is subject to the following two conditions: (1) This device may not cause harmful interference, and (2) This device must accept any interference that may be received including interference that may cause undesired operation. **WARNING:** The transmitter has been tested and complies with FCC and ISSED rules. Changes or modifications not expressly approved by the party responsible for compliance could void the user's authority to operate the device.

This equipment complies with FCC and ISSED radiation exposure limits set forth for an uncontrolled environment. End Users must follow the specific operating instructions for satisfying RF exposure compliance. This transmitter must be at least 20 cm from the user and must not be co-located or operating in conjunction with any other antenna or transmitter.

This device complies with FCC rules part 15 and Innovation, Science, and Economic Development Canada RSS-210. Operation is subject to the following two conditions: (1) This device may not cause harmful interference, and (2) This device must accept any interference that may be received including interference that may cause undesired operation. **WARNING:** The transmitter has been tested and complies with FCC and ISSED rules. Changes or modifications not expressly approved by the party responsible for compliance could void the user's authority to operate the device.

This equipment complies with FCC and ISSED radiation exposure limits set forth for an uncontrolled environment. End Users must follow the specific operating instructions for satisfying RF exposure compliance. This transmitter must be at least 20 cm from the user and must not be co-located or operating in conjunction with any other antenna or transmitter.

Cet appareil est conforme aux règlements de la FCC, section 15, et au CNR-210 d'Innovation, Sciences et Développement économique Canada. Le fonctionnement est assujéti aux deux conditions suivantes : (1) cet appareil ne doit pas causer d'interférences nuisibles et (2) cet appareil doit accepter toute interférence reçue, y compris celle qui pourrait entraîner un dysfonctionnement. **MISE EN GARDE :** L'émetteur a subi des tests et est conforme aux règlements de la FCC et d'ISDE. Les changements ou modifications non approuvés explicitement par la partie responsable de la conformité pourraient rendre caduque l'autorisation de l'utilisateur de se servir du dispositif.

Cet appareil est conforme aux limites d'exposition aux radiations de la FCC et d'ISDE établies pour un environnement non contrôlé. Les utilisateurs finaux doivent respecter les instructions d'utilisation spécifiques pour satisfaire aux exigences de conformité aux expositions de RF. L'émetteur doit se trouver à 20 cm au minimum de l'utilisateur et ne doit pas être situé au même endroit que tout autre émetteur ou antenne ni fonctionner avec un autre émetteur ou antenne.

LEXUS Enform

FCC ID: JOYJ79
IC: 574B-J79

FCC/IC WARNING:

Changes or modifications not expressly approved by the manufacture could void the user's authority to operate the equipment.

This device complies with Part 15 of the FCC Rules and Industry Canada license-exempt RSS standards. Operation is subject to the following two conditions:

- (1) this device may not cause harmful interference, and
- (2) this device must accept any interference, including interference that may cause undesired operation of the device.

This equipment complies with IC RSS-102 radiation exposure limits set forth for uncontrolled environment.

The antennas used for this transmitter must be installed to provide a separation distance of least 20cm from all persons.

FCC/IC AVERTISSEMENT:

L'utilisateur est averti que les changements ou modifications non expressément approuvés par le fabricant pourraient annuler l'autorité de l'utilisateur à utiliser l'équipement.

Ce appareil est compatible avec la Partie 15 du règlement FCC et de la Licence de l'industrie canadienne et des normes exemptes de RSS. Opération soumise aux deux conditions suivantes :

- (1) ce appareil ne doit pas causer des interférences nuisibles, et
- (2) cet appareil doit accepté toutes les interférences, y compris les interférences qui peuvent entraîner un fonctionnement indésirable de l'appareil.

Cet appareil est compatible aux limites d'exposition aux radiation IC RSS-102 définies pour un environnement non contrôlé.

Les antennes utilisées pour cet émetteur doivent être installées à une distance d'au moins 20 cm de toutes les personnes.

Tire pressure warning system

FCC ID: PAXPMVE000

NOTE

This device complies with part 15 of the FCC Rules. Operation is subject to the following two conditions:
(1) This device may not cause harmful interference, and (2) this device must accept any interference received, including interference that may cause undesired operation.

FCC WARNING

Changes or modifications not expressly approved by the party responsible for compliance could void the user's authority to operate the equipment.

FCC ID: PAXPMVE100

NOTE

This device complies with part 15 of the FCC Rules. Operation is subject to the following two conditions:
(1) This device may not cause harmful interference, and (2) this device must accept any interference received, including interference that may cause undesired operation.

FCC WARNING

Changes or modifications not expressly approved by the party responsible for compliance could void the user's authority to operate the equipment.

NOTE

This device complies with Industry Canada licence-exempt RSS standard(s). Operation is subject to the following two conditions: (1) this device may not cause interference, and (2) this device must accept any interference, including interference that may cause undesired operation of the device.

NOTE

Le présent appareil est conforme aux CNR d'Industrie Canada applicables aux appareils radio exempts de licence. L'exploitation est autorisée aux deux conditions suivantes : (1) l'appareil ne doit pas produire de brouillage, et (2) l'utilisateur de l'appareil doit accepter tout brouillage radioélectrique subi, même si le brouillage est susceptible d'en compromettre le fonctionnement.

9-1. For owners

Reporting safety defects for U.S. owners 372

Seat belt instructions for Canadian owners (in French)..... 372

SRS airbag instructions for Canadian owners (in French)..... 374

Headlight aim instructions for Canadian owners (in French) 380

Reporting safety defects for U.S. owners

If you believe that your vehicle has a defect which could cause a crash or could cause injury or death, you should immediately inform the National Highway Traffic Safety Administration (NHTSA) in addition to notifying the Lexus Division of Toyota Motor Sales, U.S.A., Inc. (Toll-free: 1-800-25-LEXUS).

If NHTSA receives similar complaints, it may open an investigation, and if it finds that a safety defect exists in a group of vehicles, it may order a recall and remedy campaign. However, NHTSA cannot become involved in individual problems between you, your dealer, or Lexus Division of Toyota Motor Sales, U.S.A., Inc.

To contact NHTSA, you may call the Vehicle Safety Hotline toll-free at 1-888-327-4236 (TTY: 1-800-424-9153); go to <http://www.safercar.gov>; or write to: Administrator, NHTSA, 1200 New Jersey Ave. SE., Washington, DC 20590. You can also obtain other information about motor vehicle safety from <http://www.safercar.gov>.

Seat belt instructions for Canadian owners (in French)

The following is a French explanation of seat belt instructions extracted from the seat belt section in this manual.

See the seat belt section for more detailed seat belt instructions in English.

Utilisation correcte des ceintures de sécurité



- Déroulez la sangle diagonale de telle sorte qu'elle passe bien sur l'épaule, sans pour autant être en contact avec le cou ou glisser de l'épaule.
- Placez la sangle abdominale le plus bas possible sur les hanches.
- Réglez la position du dossier de siège. Asseyez-vous le dos droit et calez-vous bien dans le siège.
- Ne vrillez pas la ceinture de sécurité.

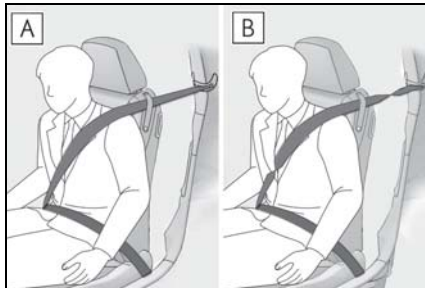

A Non vrillée

B Vrillée

Entretien et soin

■ Traitement des ceintures de sécurité

Nettoyez avec un chiffon ou une éponge humidifiés avec de l'eau savonneuse tiède. Vérifiez régulièrement que les ceintures ne sont pas usées, effilochées ou entaillées excessivement.

AVERTISSEMENT

■ Détérioration et usure des ceintures de sécurité

Inspectez le système de ceintures de sécurité régulièrement. Contrôlez l'absence de coupures, d'effilochages et de pièces desserrées. N'utilisez pas une ceinture de sécurité endommagée avant qu'elle ne soit remplacée. Une ceinture de sécurité endommagée ne permet pas de protéger un occupant de blessures graves ou mortelles.

SRS airbag instructions for Canadian owners (in French)

The following is a French explanation of SRS airbag instructions extracted from the SRS airbag section in this manual.

See the SRS airbag section for more detailed SRS airbag instructions in English.

Système de coussins gonflables SRS

■ Emplacement des coussins gonflables SRS

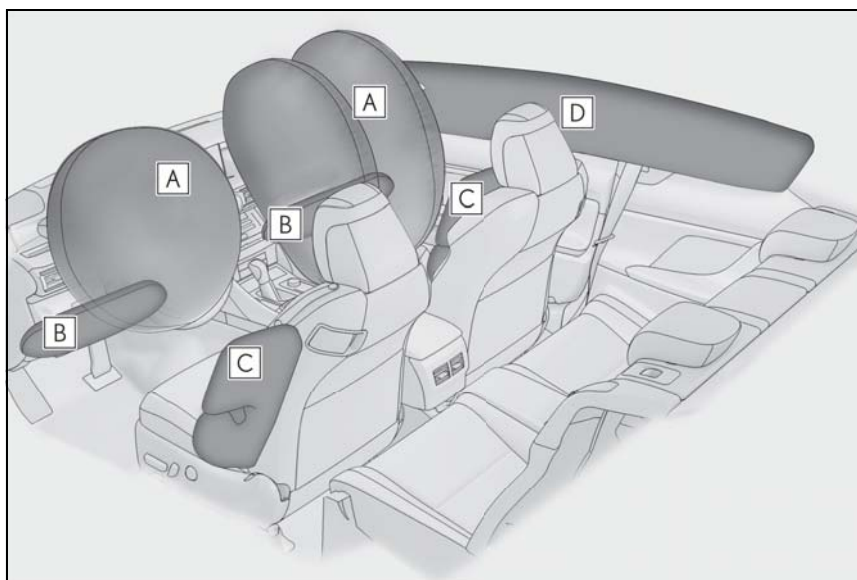

► Coussins gonflables frontaux SRS

A Coussin gonflable conducteur/coussin gonflable du passager avant SRS

Participe à la protection de la tête et du thorax du conducteur et du passager avant contre les chocs contre les éléments de l'habitacle

B Coussins gonflables de genoux SRS

Participent à la protection du conducteur et du passager avant

► Coussins gonflables latéraux et rideaux SRS

C Coussins gonflables latéraux SRS

Participent à la protection du torse des occupants de siège avant

D Coussins gonflables rideaux SRS

• Participent principalement à la protection de la tête des occupants des sièges latéraux

- Peut contribuer à empêcher les occupants d'être éjectés du véhicule en cas de tonneau

■ Composants du système de coussins gonflables SRS

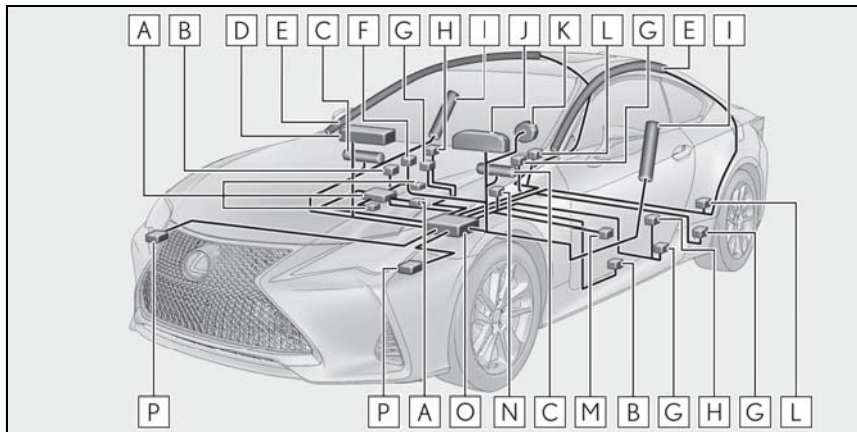

- A** Système de classification de l'occupant du siège passager avant (ECU et capteurs)
- B** Capteurs d'impact latéral (porte avant)
- C** Coussins gonflables de genoux
- D** Coussin gonflable passager avant
- E** Coussins gonflables rideaux
- F** Témoins indicateurs "AIR BAG ON" et "AIR BAG OFF"
- G** Prétensionneurs de ceintures de sécurité et limiteurs de force
- H** Capteurs d'impact latéral (avant)
- I** Coussins gonflables latéraux avant
- J** Témoin d'avertissement SRS
- K** Coussin gonflable conducteur
- L** Capteurs d'impact latéral (arrière)
- M** Capteur de position du siège conducteur
- N** Contact de boucle de ceinture de sécurité conducteur
- O** Ensemble de capteurs de coussins gonflables
- P** Capteurs d'impact avant

Votre véhicule est équipé de COUSSINS GONFLABLES INTELLIGENTS conçus selon les normes de sécurité américaines applicables aux véhicules à moteur (FMVSS208). L'ensemble de capteurs de coussins gonflables (ECU)

régule le déploiement des coussins gonflables sur la base des informations qu'il reçoit des capteurs, etc., indiqués ci-dessus dans le schéma illustrant les composants du système. Parmi ces informations figurent la gravité du choc et l'occupation du véhicule par les passagers. Le déploiement rapide des coussins gonflables est obtenu au moyen d'une réaction chimique dans les dispositifs pyrotechniques, qui produit un gaz inoffensif permettant d'amortir le mouvement des occupants.

**AVERTISSEMENT****■ Précautions relatives aux coussins gonflables SRS**

Respectez les précautions suivantes concernant les coussins gonflables SRS. Le non-respect de ces précautions peut occasionner des blessures graves, voire mortelles.

- Le conducteur et tous les passagers du véhicule doivent porter correctement leur ceinture de sécurité. Les coussins gonflables SRS sont des dispositifs supplémentaires à utiliser avec les ceintures de sécurité.
- Le coussin gonflable conducteur SRS se déploie avec une force considérable, pouvant occasionner des blessures graves, voire mortelles, si le conducteur se trouve très près du coussin gonflable. L'autorité fédérale chargée de la sécurité routière aux États-Unis (NHTSA) conseille: La zone à risque du coussin gonflable conducteur se situant dans les premiers 2 à 3 in. (50 à 75 mm) de déploiement, vous placer à 10 in. (250 mm) de votre coussin gonflable conducteur vous garantit une marge de sécurité suffisante. Cette distance est à mesurer entre le centre du volant et le sternum. Si vous êtes assis à moins de 10 in. (250 mm), vous pouvez changer votre position de conduite de plusieurs façons:
 - Reculez votre siège le plus possible, de manière à pouvoir encore atteindre confortablement les pédales.

- Inclinez légèrement le dossier du siège. Bien que les véhicules aient une conception différente, un grand nombre de conducteurs peuvent s'asseoir à une distance de 10 in. (250 mm), même avec le siège conducteur complètement avancé, simplement en inclinant un peu le dossier de siège. Si vous avez des difficultés à voir la route après avoir incliné le dossier de votre siège, utilisez un coussin ferme et antidérapant pour vous rehausser ou remontez le siège si votre véhicule est équipé de cette fonction.
- Si votre volant est réglable, inclinez-le vers le bas. Cela a pour effet d'orienter le coussin gonflable en direction de votre poitrine plutôt que de votre tête et de votre cou.

Réglez votre siège selon les recommandations de la NHTSA ci-dessus, tout en conservant le contrôle des pédales, du volant et la vue des commandes du tableau de bord.

⚠ AVERTISSEMENT

- Si vous attachez une rallonge de ceinture de sécurité aux boucles de ceinture de sécurité avant, sans l'attacher au pêne de la ceinture de sécurité, les coussins gonflables frontaux SRS déterminent que le conducteur et le passager avant ont attaché leur ceinture de sécurité, bien que la ceinture de sécurité ne soit pas attachée. Dans ce cas, les coussins gonflables frontaux SRS peuvent ne pas se déployer correctement en cas de collision, pouvant occasionner des blessures graves, voire mortelles. Veillez à porter la ceinture de sécurité avec la rallonge de ceinture de sécurité.

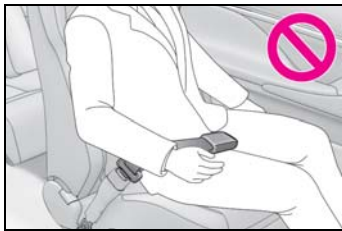

- Le coussin gonflable passager avant SRS se déploie également avec une force considérable, pouvant occasionner des blessures graves, voire mortelles, si le passager avant se trouve très près du coussin gonflable. Le siège du passager avant doit être éloigné le plus possible du coussin gonflable en réglant le dossier de siège de façon à ce que le passager avant soit assis bien droit dans le siège.

- Les nourrissons et les enfants qui ne sont pas correctement assis et/ou attachés peuvent être grièvement blessés ou tués par le déploiement d'un coussin gonflable. Un nourrisson ou un enfant trop petit pour utiliser une ceinture de sécurité doit être correctement attaché au moyen d'un siège de sécurité enfant. Lexus recommande vivement d'installer tous les nourrissons et enfants sur les sièges arrière du véhicule et de prévoir pour eux des systèmes de retenue adaptés. Les sièges arrière sont plus sûrs pour les nourrissons et les enfants que le siège du passager avant.
- N'installez jamais un siège de sécurité enfant type dos à la route sur le siège passager avant, même si le témoin indicateur "AIR BAG OFF" est allumé. En cas d'accident, la force engendrée par le déploiement rapide du coussin gonflable du passager avant peut blesser grièvement, voire tuer l'enfant si le siège de sécurité enfant type dos à la route est installé sur le siège du passager avant.
- Ne vous asseyez pas sur le bord du siège et ne vous appuyez pas contre la planche de bord.

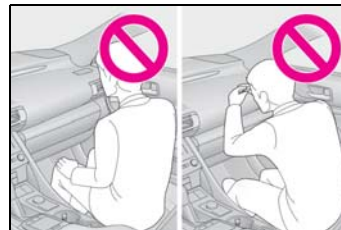

⚠ AVERTISSEMENT

- Ne laissez pas un enfant rester debout devant le coussin gonflable passager avant SRS ou s'asseoir sur les genoux du passager avant.

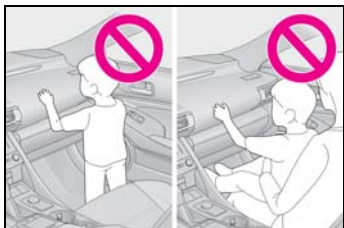

- Ne laissez pas les occupants des sièges avant voyager avec un objet sur les genoux.
- Ne vous appuyez pas contre la porte, le rail latéral de toit ou les montants avant, latéraux et arrière.



- Ne laissez personne s'agenouiller sur les sièges passagers en appui contre la porte ou sortir la tête ou les mains à l'extérieur du véhicule.



- Ne fixez rien et ne posez rien sur des emplacements tels que la planche de bord, la garniture du volant et la partie inférieure du tableau de bord. Ces éléments peuvent se transformer en projectiles lorsque les coussins gonflables conducteur, passager avant et genoux SRS se déploient.

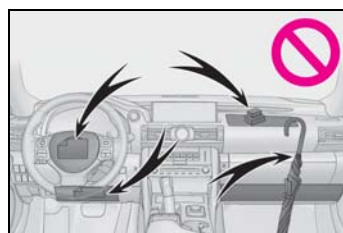

- Ne fixez rien aux portes, à la vitre du pare-brise, aux vitres latérales, aux montants avant et arrière, au rail latéral de toit et à la poignée de maintien.

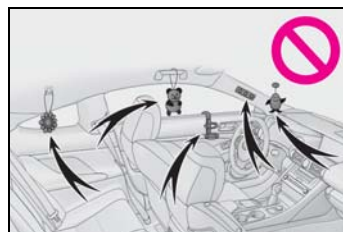

- Ne suspendez aucun cintre ou objet dur aux crochets à vêtements. Tous ces objets pourraient se transformer en projectiles et causer des blessures graves, voire mortelles en cas de déploiement des coussins gonflables rideaux SRS.
- Si un cache en vinyle est placé sur la zone où le coussin gonflable de genoux SRS se déploie, assurez-vous de le retirer.

**AVERTISSEMENT**

- N'utilisez aucun accessoire de siège recouvrant les zones de déploiement des coussins gonflables latéraux SRS, car il risque de gêner le déploiement des coussins gonflables. De tels accessoires peuvent empêcher les coussins gonflables latéraux de fonctionner correctement, désactiver le système ou entraîner le déploiement accidentel des coussins gonflables latéraux, occasionnant des blessures graves, voire mortelles.
- Évitez de faire subir des chocs ou des pressions excessives aux parties renfermant les composants de coussins gonflables SRS.
En effet, cela pourrait entraîner un dysfonctionnement des coussins gonflables SRS.
- Ne touchez aucun composant immédiatement après le déploiement (gonflage) des coussins gonflables SRS, car ils peuvent être chauds.
- Si vous avez des difficultés à respirer après le déploiement des coussins gonflables SRS, ouvrez une porte ou une vitre pour faire entrer de l'air frais, ou bien descendez du véhicule si cela ne présente pas de danger. Essayez tout résidu dès que possible afin d'éviter d'éventuelles irritations de la peau.
- Si les parties renfermant les coussins gonflables SRS, comme les garnitures du volant et des montants avant et arrière, sont endommagées ou craquelées, faites-les remplacer par votre concessionnaire Lexus.

- Ne placez rien sur le siège du passager avant, comme un coussin par exemple. Cela a pour conséquence de répartir le poids du passager sur toute la surface du siège, ce qui empêche le capteur de détecter correctement le poids du passager. En conséquence, les coussins gonflables frontaux SRS du passager avant risquent de ne pas se déployer en cas de collision.

Modification et mise au rebut des composants du système de coussins gonflables SRS

Ne mettez pas votre véhicule au rebut et ne procédez à aucune des modifications suivantes sans consulter votre concessionnaire Lexus. Les coussins gonflables SRS peuvent ne pas fonctionner correctement ou se déployer (se gonfler) accidentellement, provoquant la mort ou de graves blessures.

- Installation, dépose, démontage et réparation des coussins gonflables SRS
- Réparations, modifications, dépose ou remplacement du volant, du tableau de bord, de la planche de bord, des sièges ou de leur garnissage, des montants avant, latéraux et arrière ou des rails latéraux de toit
- Réparations ou modifications des ailes avant, du pare-chocs avant ou des flancs de l'habitacle
- Installation d'un protège-calandre (pare-buffle, pare-kangourou, etc.), de chasse-neige, de treuils ou d'un porte-bagages de toit
- Modifications du système de suspension du véhicule
- Installation d'appareils électroniques tels que les émetteurs/récepteurs radios mobiles et les lecteurs CD
- Modifications de votre véhicule pour une personne atteinte d'un handicap physique

Headlight aim instructions for Canadian owners (in French)

The following is a French explanation of headlight aim instructions from the headlight aim section in this manual.

Boulons de réglage du mouvement vertical

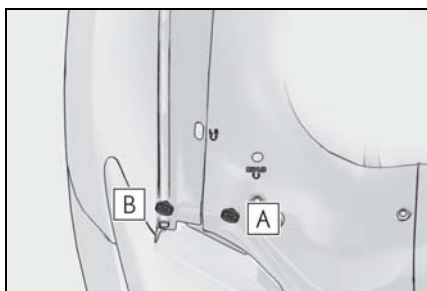

A Boulon de réglage A

B Boulon de réglage B

Avant de vérifier le réglage des phares

- Vérifiez que le réservoir de carburant du véhicule est plein et que la zone autour des phares n'est pas déformée.
- Stationnez le véhicule sur une surface plane.
- Assurez-vous que la pression de gonflage des pneus est au niveau recommandé.
- Faites asseoir quelqu'un dans le siège conducteur.

- Balancez le véhicule plusieurs fois.

Réglage du faisceau des phares

- 1 À l'aide d'un tournevis cruciforme, tournez le boulon A dans n'importe quel sens.

Mémorisez le sens dans lequel vous avez tourné et le nombre de tours.

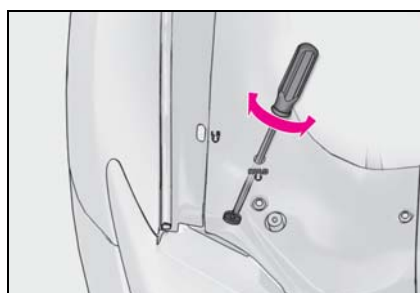

- 2 Tournez le boulon B du même nombre de tours dans le même sens qu'à l'étape 1.

Si vous n'arrivez pas à régler le phare en procédant de la sorte, confiez le véhicule à votre concessionnaire Lexus pour qu'il règle le faisceau des phares.

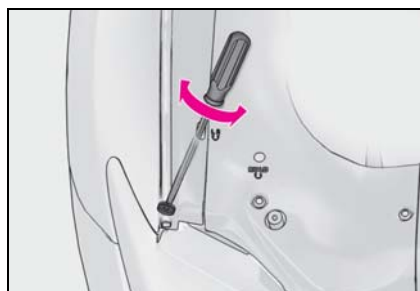

Index

381

What to do if... (Troubleshooting)

.....**382**

Alphabetical Index.....**385**

What to do if... (Troubleshooting)

If you have a problem, check the following before contacting your Lexus dealer.

The doors cannot be locked, unlocked, opened or closed



You lose your keys

- If you lose your mechanical keys, new genuine mechanical keys can be made by your Lexus dealer. (→P.316)
- If you lose your electronic keys, the risk of vehicle theft increases significantly. Contact your Lexus dealer immediately. (→P.316)



The electronic key does not operate properly

- Is the electronic key battery weak or depleted? (→P.277)



The doors cannot be locked or unlocked

- Is the engine switch in IGNITION ON mode?

When locking the doors, turn the engine switch off. (→P.129)

- Is the electronic key left inside the vehicle?

When locking the doors, make sure that you have the electronic key on your person.

- The function may not operate properly due to the condition of the radio wave. (→P.96)



The trunk lid is closed with the electronic key left inside

- The function to prevent the electronic key from being left inside the trunk will operate and you can open the trunk as usual. Take the key out from the trunk. (→P.93)

If you think something is wrong



The engine does not start

- Did you press the engine switch while firmly depressing the brake pedal? (→P.127)
- Is the shift lever in P? (→P.127)
- Is the electronic key anywhere detectable inside the vehicle? (→P.95)
- Is the steering wheel unlocked? (→P.127)
- Is the electronic key battery weak or depleted?

In this case, the engine can be started in a temporary way. (→P.318)

- Is the battery discharged? (→P.319)



The shift lever cannot be shifted from P even if you depress the brake pedal

- Is the engine switch in IGNITION

ON mode?

If you cannot release the shift lever by depressing the brake pedal with the engine switch in IGNITION ON mode. (→P.132)



The steering wheel cannot be turned after the engine is stopped

- It is locked automatically to prevent theft of the vehicle. (→P.127)



The windows do not open or close by operating the power window switches

- Is the window lock switch pressed?

The power window except for the one at the driver's seat cannot be operated if the window lock switch is pressed. (→P.113)



The engine switch is turned off automatically

- The auto power off function will be operated if the vehicle is left in ACCESSORY or IGNITION ON mode (the engine is not running) for a period of time. (→P.130)



A warning buzzer sounds during driving

- The seat belt reminder light is flashing

Are the driver and the front passenger wearing the seat belts? (→P.299)

- The parking brake indicator is on

Is the parking brake released? (→P.137)

Depending on the situation, other

types of warning buzzer may also sound. (→P.295, 303)



An alarm is activated and the horn sounds

- Did anyone inside the vehicle open a door during setting the alarm?

The sensor detects it and the alarm sounds. (→P.57)

Do one of the following to deactivate or stop the alarm:

- Unlock the doors.
- Open the trunk using the entry function or wireless remote control.
- Turn the engine switch to ACCESSORY or IGNITION ON mode, or start the engine.



A warning buzzer sounds when leaving the vehicle

- Is the message displayed on the multi-information display?

Check the message on the multi-information display. (→P.303)



A warning light turns on or a warning message is displayed

- When a warning light turns on or a warning message is displayed, refer to P.295, 303.

When a problem has occurred**If you have a flat tire**

- Stop the vehicle in a safe place and replace the flat tire with the spare tire. (→P.307)

**The vehicle becomes stuck**

- Try the procedure for when the vehicle becomes stuck in mud, dirt, or snow. (→P.326)

Alphabetical Index

A

A/C	
Air conditioning filter	275
Automatic air conditioning system.....	215
Micro dust and pollen filter	219
ABS (Anti-lock Brake System).....	201
Warning light.....	297
Active Sound Control (ASC)	141
Adaptive Variable Suspension System	201
Air conditioning filter	275
Air conditioning system	
Air conditioning filter	275
Automatic air conditioning system.....	215
Micro dust and pollen filter	219
Airbags	
Airbag operating conditions.....	30
Airbag precautions for your child.....	32
Correct driving posture	23
Curtain shield airbag operating condi- tions.....	30
Curtain shield airbag precautions	32
Front passenger occupant classification system	36
General airbag precautions	32
Locations of airbags.....	28
Modification and disposal of airbags	35
Side airbag operating conditions.....	30
Side airbag precautions	32
Side and curtain shield airbags operating conditions.....	30
Side and curtain shield airbags precau- tions.....	32
SRS airbags	28
SRS warning light	296
Alarm.....	57
Warning buzzer.....	295
Anchor brackets.....	41, 49
Antennas (smart access system with push-button start).....	95
Anti-lock Brake System (ABS).....	201
Warning light.....	297

Approach warning.....	181
ASC (Active Sound Control)	141
Assist grips	230
Audio system-linked display.....	76
Automatic air conditioning system	215
Automatic headlight leveling system ...	143
Automatic High Beam	144
Automatic light control system.....	142
Automatic transmission	131
M mode	134
Paddle shift switches	133, 134
Snow mode.....	133
Average fuel economy.....	73
Average vehicle speed	73

B

Back-up light	
Replacing light bulbs.....	282
Wattage.....	338
Battery	
Battery checking	263
If the battery is discharged	319
Preparing and checking before winter	205
Warning light	296
Blind Spot Monitor (BSM).....	191
Boost gauge.....	74
Brake	
Brake hold.....	139
Fluid.....	334
Parking brake	137
Warning light	295
Brake assist	201
Break-in tips.....	119
Brightness control	
Instrument panel light control.....	71
BSM (Blind Spot Monitor).....	191

C

Card key	84
----------------	----

Care	
Exterior	242
Interior	245
Seat belts.....	245
Wheels and wheel ornaments.....	242
Cargo capacity.....	125
Cargo hooks	229
Center Display	212
Chains	206
Child restraint system	
Child seats definition.....	40
Child seats installation.....	44, 47
Front passenger occupant classification system	36
Installing a CRS to the front passenger seat	42
Installing CRS with LATCH anchors.....	48
Installing CRS with top tether strap.....	50
Riding with children.....	40
Types of child restraint system installation method	41
Using an anchor bracket.....	49
Child safety	
Airbag precautions.....	32
Battery precautions	264, 321
Child restraint system.....	40, 41
Heated steering wheel or seat heater precautions.....	223
How your child should wear the seat belt	25
Installing child restraints	40
Moon roof precautions	116
Power window lock switch.....	113
Seat belt extender precautions	25
Seat belt precautions	40
Trunk precautions	91
Cleaning	
Exterior	242
Interior	245
Radar sensor.....	158
Seat belts.....	245
Wheels and wheel ornaments.....	242
Clock	66, 230
Clock settings	230
Coat hooks.....	230
Compass.....	237
Condenser	262
Console box	228
Consumption screen	79
Cooling system.....	260
Engine overheating.....	322
Cornering lights.....	143
Replacing light bulbs.....	282
Cruise control	
Dynamic radar cruise control with full-speed range	176
Cup holders	228
Current fuel consumption	73
Curtain shield airbags	28
Customizable features.....	351
D	
Daytime running light system	142
Daytime running lights	
Replacing light bulbs.....	282
Defogger	
Outside rear view mirrors.....	219
Rear window	219
Windshield.....	219
Differential	
Front differential oil.....	333
Rear differential oil.....	333
Dimension	328
Dinghy towing.....	126
Display	
Center Display	212
Drive information	73
LDA (Lane Departure Alert with steering control).....	171
Multi-information display	71
Warning messages.....	305
Distance until next engine oil change	70
Do-it-yourself maintenance	249
Door courtesy lights.....	225

Door lock
 Doors.....88
 Smart access system with push-button start.....95
 Wireless remote control.....86

Doors
 Automatic door locking and unlocking system90
 Door glasses.....112
 Door lock.....88
 Open door warning buzzer89, 90, 299
 Open door warning light299
 Outside rear view mirrors110

Drive distance.....73

Drive info 1/Drive info 2/Drive info 3....73

Drive information73

Driver's seat position memory
 Driving position memory.....102
 Memory recall function104
 Power easy access system.....102

Drive-start control119

Driving
 Break-in tips.....119
 Correct driving posture23
 Driving mode select switch199
 Procedures118
 Winter drive tips.....205

Driving assist system information display76

Driving information display.....73

Driving position memory.....102
 Memory recall function104
 Power easy access system.....102

Driving range.....73

DRS (Dynamic Rear Steering)201

Dynamic radar cruise control
 Warning message.....303

Dynamic radar cruise control with full-speed range.....176
 Warning message.....183

Dynamic Rear Steering (DRS).....201

E

Eco Driving Indicator.....74

Eco Driving Indicator Light.....74

EDR (Event data recorder).....6

Elapsed time73

Electric Power Steering (EPS)201
 Warning light297

Electronic key84
 Battery-saving function.....96
 If the electronic key does not operate properly317
 Replacing the battery.....277

Emergency flashers.....286

Emergency, in case of
 If a warning buzzer sounds.....295
 If a warning light turns on.....295
 If a warning message is displayed... 303
 If the battery is discharged.....319
 If the electronic key does not operate properly317
 If the engine will not start.....314
 If the fuel filler door cannot be opened316
 If the vehicle is trapped in rising water287
 If you have a flat tire307
 If you lose your keys316
 If you think something is wrong.....293
 If your vehicle becomes stuck.....326
 If your vehicle has to be stopped in an emergency.....286
 If your vehicle needs to be towed ... 289
 If your vehicle overheats322

Engine
 ACCESSORY mode.....129
 Compartment.....257
 Engine switch.....127
 Fuel pump shut off system.....294
 Hood.....255
 How to start the engine127
 Identification number329

If the engine will not start314
 If your vehicle has to be stopped in an emergency286
 Ignition switch (engine switch) 127
 Overheating..... 322
 Tachometer 66
Engine coolant
 Capacity.....332
 Checking.....260
 Preparing and checking before winter205
Engine coolant temperature gauge 66
Engine immobilizer system 56
Engine oil
 Capacity.....330
 Checking.....258
 Preparing and checking before winter205
 Warning light.....296
Engine oil maintenance data260
Engine oil pressure gauge74
Engine oil temperature gauge74
Engine switch 127
 Auto power off function 130
 Changing the engine switch modes..129
 If your vehicle has to be stopped in an emergency286
EPS (Electric Power Steering)201
 Warning light..... 297
Event data recorder (EDR).....6

F

First-aid kit storage belt 229
Flat tire
 Tire pressure warning system.....268
 Vehicles with a spare tire307
Floor mats.....22
Fluid
 Automatic transmission..... 333
 Brake..... 262, 334
 Washer 264
Footwell light 225

Front passenger occupant classification system 36
Front position lights
 Wattage..... 338
Front seats
 Adjustment.....99
 Cleaning.....245
 Correct driving posture23
 Driving position memory102
 Head restraints.....105
 Memory recall function.....104
 Power easy access system102
 Seat heaters223
 Seat position memory102
 Seat ventilators.....223
Front side marker light
 Light switch142
Front turn signal lights
 Replacing light bulbs.....282
 Turn signal lever136
 Wattage..... 338

Fuel
 Capacity..... 330
 Fuel gauge.....66
 Fuel pump shut off system.....294
 Information339
 Refueling.....155
 Type 330
 Warning light299

Fuel consumption
 Average fuel economy 73
 Current fuel consumption..... 73

Fuel filler door
 If the fuel filler door cannot be opened 316
 Refueling.....155
Fuel gauge..... 66
Fuel pump shut off system..... 294
Fuses..... 278

G

Garage door opener 232

Gauges 66
 Gear Position.....75
 G-force.....74
 Glove box.....227
 Glove box light.....228

H

Head restraints 105
 Headlight aim.....280
Headlights
 Automatic High Beam system.....144
 Light switch.....142
 Replacing light bulbs.....282
 Wattage.....338
 Heated steering wheel..... 223
Heaters
 Automatic air conditioning system.....215
 Heated steering wheel..... 223
 Outside rear view mirrors219
 Seat heaters.....223
High mounted stoplight
 Replacing light bulbs.....282
Hill-start assist control.....201
Hood
 Open255
Hooks
 Cargo hooks.....229
 Coat hooks.....230
 Retaining hooks (floor mat).....22
Horn.....109

I

I/M test 252
Identification
 Engine329
 Vehicle.....328
Ignition switch (engine switch)..... 127
 Auto power off function130
 Changing the engine switch modes..129
 If your vehicle has to be stopped in an
 emergency286

Illuminated entry system..... 226
Indicators 64
Initialization
 Items to initialize361
 Maintenance.....248, 260
 Power windows.....112
 Tire pressure warning system269
Inside rear view mirror109
Instrument panel light control71
Intercooler.....262
Intercooler coolant
 Capacity.....332
 Checking260
Interior lights.....225
 Front interior light225
 Rear interior light.....225
Intuitive parking assist
 Warning message.....187

J

Jack
 Positioning a floor jack.....255
 Vehicle-equipped jack307
Jack handle307
Jam protection function
 Moon roof115
 Power windows.....112

K

Keyless entry
 Smart access system with push-button
 start.....95
 Wireless remote control86
Keys
 Battery-saving function.....96
 Electronic key84
 Engine switch.....127
 If the electronic key does not operate
 properly317
 If you lose your keys316
 Key number plate84

Keyless entry.....88, 95
 Mechanical key.....84
 Replacing the battery.....277
 Warning buzzer.....95
 Wireless remote control.....86
Knee airbags 28

L

Lane Departure Alert with steering control (LDA)
 Operation.....169
 Warning messages174
Language (multi-information display) ...76
LDA (Lane Departure Alert with steering control)
 Operation.....169
 Warning messages174
LDA (Lane Departure Alert with steering control) switch 171
LDH (Lexus Dynamic Handling system)
 202
Lever
 Auxiliary catch lever.....255
 Hood lock release lever.....255
 Shift lever.....131
 Turn signal lever.....136
 Wiper lever.....147
Lexus Dynamic Handling system (LDH)
 202
Lexus Enform Safety Connect..... 52
Lexus Safety System +
 Automatic High Beam.....144
 LDA (Lane Departure Alert with steering control).....169
 PCS (Pre-Collision System).....162
License plate lights
 Light switch.....142
 Replacing light bulbs.....282
Light
 Wattage.....338
Light bulbs
 Replacing.....281

Lights
 Automatic High Beam system.....144
 Front interior lights225
 Headlight switch.....142
 Interior lights.....225
 Interior lights list.....225
 Personal lights226
 Rear interior lights225
 Replacing light bulbs.....282
 Trunk light.....93
 Turn signal lever136
 Vanity lights231
 Wattage.....338
Lock steering column..... 127

M

Maintenance
 Do-it-yourself maintenance253
 General maintenance249
 Maintenance date.....328
 Maintenance requirements248
Malfunction indicator lamp 296
Master warning light 300
Menu icons.....72
Meter
 Changing the main meter location.....69
 Clock.....66
 Indicators.....64
 Instrument panel light control.....71
 Meters.....66
 Multi-information display71
 Settings.....76
 Units.....75
 Warning lights.....295
 Warning messages.....303
Micro dust and pollen filter 219
Mirrors
 Inside rear view mirror.....109
 Outside rear view mirror defoggers .219
 Outside rear view mirrors.....110
 Vanity mirrors.....231

Moon roof	
Door lock linked moon roof operation	115
Jam protection function	115
Operation	114
Multi-information display	71
Audio system-linked display	76
Boost gauge	74
Drive information	73
Drive information 1/Drive information 2/Drive information 3	73
Driving assist system information display	76
Dynamic radar cruise control	176
Eco Driving Indicator	74
Engine oil pressure gauge	74
Engine oil temperature gauge	74
Gear Position	75
G-force	74
LDA (Lane Departure Alert with steering control)	171
Menu icons	72
Meter control switches	72
Navigation system-linked display	76
Settings	76
Tire pressure	75, 268
Units	75
Vehicle sway warning	75
Warning message display	76
Warning messages	303

N

Navigation system-linked display	76
Noise from under vehicle	5

O

"ODO TRIP" switch	70
Odometer	70
Odometer and trip meter display	
"ODO TRIP" switch	70

Oil	
Engine oil	330
Front differential oil	333
Rear differential oil	333
Opener	
Fuel filler door	155
Hood	255
Trunk	92
Outer foot lights	
Location	225
Outside rear view mirrors	
Adjustment	110
BSM (Blind Spot Monitor)	191
Folding	111
Linked mirror function when reversing	111
Mirror position memory	102
Outside rear view mirror defoggers	219
RCTA function	191
Outside temperature	66
Overheating	322

P

Paddle shift switches	133, 134
Panic mode	86
Parking brake	
Operation	137
Parking brake engaged warning buzzer	138
Warning light	300
Warning message	138
Parking lights	
Light switch	142
Replacing light bulbs	282
PCS (Pre-Collision System)	
Function	162
PCS OFF switch	164
Warning light	298
Warning message	303
Personal lights	225
Power control unit coolant	
Preparing and checking before winter	205

Power easy access system102
 Power outlet230
 Power steering (Electric power steering system).....201
 Warning light.....297
 Power windows
 Door lock linked window operation...113
 Jam protection function.....112
 Operation.....112
 Window lock switch113
 Pre-Collision System (PCS)
 Function.....162
 PCS OFF switch.....164
 Warning light.....298
 Warning message.....303

R

Radar cruise control (dynamic radar cruise control with full-speed range).....176
 Radiator262
 RCTA
 Function.....191
 Rear Cross Traffic Alert (RCTA)191
 Rear seats101
 Head restraints105
 Seat heaters223
 Seat ventilators.....223
 Rear side marker lights
 Light switch.....142
 Rear turn signal lights
 Turn signal lever.....136
 Wattage.....338
 Rear view mirror
 Inside rear view mirror.....109
 Outside rear view mirrors110
 Rear window defogger219
 Refueling
 Capacity330
 Fuel types.....330
 If the fuel filler door cannot be opened316
 Opening the fuel tank cap155

Remote Touch210
 Replacing
 Electronic key battery.....277
 Fuses.....278
 Light bulbs.....281
 Tires307
 Resetting the message indicating maintenance is required.....248
 Rev indicator69
 Rev peak.....69

S

Seat belt reminder light.....299
 Seat belts.....24
 Automatic Locking Retractor.....26
 Child restraint system installation..40, 41
 Cleaning and maintaining the seat belt245
 Emergency Locking Retractor26
 How to wear your seat belt25
 How your child should wear the seat belt25
 Pregnant women, proper seat belt use24
 Reminder light and buzzer299
 Seat belt extender.....25
 Seat belt pretensioners27
 SRS warning light.....296
 Seat heaters223
 Seat position memory.....102
 Seat ventilators223
 Seating capacity125
 Seats
 Adjustment.....99
 Cleaning.....245
 Driving position memory102
 Head restraints.....105
 Power easy access system102
 Properly sitting in the seat23
 Seat heaters223
 Seat position memory102
 Seat ventilators223

Seats, Front	
Child seats/child restraint system installation	40
Sensor	
Automatic headlight system.....	142
Automatic High Beam system.....	144
Inside rear view mirror.....	110
LDA (Lane Departure Alert with steering control).....	169
Radar sensor.....	158
Rain-sensing windshield wipers.....	153
Service reminder message	248
Shift lever	
Automatic transmission.....	131
Side airbags	28
Side marker lights	
Light switch.....	142
Replacing light bulbs.....	282
Side mirrors	
Adjustment.....	110
BSM (Blind Spot Monitor)	191
Folding	111
Linked mirror function when reversing.....	111
Mirror position memory.....	102
RCTA function.....	191
Side turn signal lights	
Replacing light bulbs.....	282
Turn signal lever	136
Wattage.....	338
Side windows	112
Smart access system with push-button start	
Antenna location.....	95
Entry functions.....	88
Starting the engine.....	127
Warning message.....	303
Snow mode	133
Snow tires	205
Spare tire.....	307
Storage location.....	307
Spark plug	332
Specifications	328
Speed indicator	68
Speed meter	
Speed indicator.....	68
Speedometer	66
Steering lock	
Column lock release.....	127
Steering lock system warning message	127
Steering wheel	
Adjustment.....	108
Heated steering wheel.....	223
Meter control switches	72
Power easy access system	102
Steering wheel position memory.....	102
Stop lights	
Replacing light bulbs.....	282
Wattage.....	338
Storage features	227
Stuck	
If the vehicle becomes stuck	326
Sun visors.....	231
Sunshade	
Roof.....	115
Switch	
ASC (Active Sound Control) dial.....	141
Meter control switches	72
Switches	
Activating the Automatic High Beam.....	144
Automatic High Beam system	144
Brake Hold switch.....	139
Door lock switches	90
Driving mode select switch	199
Driving position memory switches	102
Emergency flashers switch	286
Engine switch.....	127
Garage door opener switches.....	232
Heated steering wheel switch.....	223
Ignition switch.....	127
Instrument panel light control switches.....	71
Light switches	142
Moon roof switches.....	114
"ODO TRIP" switch	70

Outside rear view mirror switches..... 110
 Paddle shift switches..... 133, 134
 Parking brake switch 137
 PCS OFF switch.....164
 Power door lock switch.....90
 Power window switches.....112
 Rear window and outside rear view mirror defoggers switch.....215
 Seat heater switches 223
 Seat ventilator switches..... 223
 Snow mode switch133
 "SOS" button..... 52
 Tilt and telescopic steering control switch108
 Tire pressure warning reset switch ..270
 Trunk opener main switch 94
 Trunk opener switch..... 92
 VSC OFF switch.....202
 Window lock switch 113
 Windshield wiper and washer switch147
 Windshield wiper de-icer switch219

T

Tachometer..... 66
 Rev indicator 69
 Rev peak 69
Tail lights
 Light switch.....142
 Replacing light bulbs..... 282
 Wattage.....338
Theft deterrent system
 Alarm..... 57
 Engine immobilizer system 56
 Theft prevention labels..... 59
Tire inflation pressure
 Maintenance data..... 334
 Tire inflation pressure display function268
 Warning light..... 300
Tire information.....341
 Glossary.....345
 Size.....343

Tire identification number..... 342
 Uniform Tire Quality Grading.....344
Tire inflation pressure 75
Tire pressure display268
Tire pressure warning system
 Function 268
 Initializing.....269
 Installing tire pressure warning valves and transmitters.....269
 Registering ID codes271
 Warning light300
Tires
 Chains 206
 Checking265
 If you have a flat tire307
 Inflation pressure.....273
 Information341
 Replacing307
 Rotating tires 267
 Size.....334
 Snow tires 205
 Spare tire.....307
 Tire inflation pressure display function 268
 Tire pressure warning system 268
 Warning light300
Tools..... 307
Top tether strap.....41, 49
Total load capacity.....328
Towing
 Dinghy towing126
 Emergency towing..... 289
 Towing eyelet.....291
 Trailer towing.....126
TRAC (Traction Control)201
Traction Control (TRAC)201
Trailer towing126
Transmission
 Automatic transmission 131
 Driving mode select switch 199
 M mode134
 Paddle shift switches133, 134

Snow mode133

Trip meters 70

Trunk..... 91

 Smart access system with push-button start.....92

 Trunk features.....229

 Trunk grip.....93

 Trunk light.....93

 Trunk opener main switch.....94

 Trunk opener switch.....92

 Wireless remote control.....93

Trunk light..... 93

Turn signal lights

 Replacing light bulbs.....282

 Turn signal lever.....136

 Wattage.....338

V

Vanity lights.....231

Vanity mirrors.....231

Variable Gear Ratio Steering (VGRS)201

VDIM (Vehicle Dynamics Integrated Management).....202

Vehicle data recording.....5

Vehicle Dynamics Integrated Management (VDIM).....202

Vehicle identification number.....328

Vehicle Stability Control (VSC).....201

Vehicle sway warning display.....75

Ventilators (seat ventilators).....223

VGRS (Variable Gear Ratio Steering)201

VSC (Vehicle Stability Control).....201

W

Warning buzzer

 Open door warning.....299

Warning buzzers

 Approach warning.....181

 Brake hold.....301

 Brake Override System.....297

 Downshifting.....134, 135

 Drive-Start Control.....297

 Electric power steering.....297

 High coolant temperature.....295

 LDA (Lane Departure Alert with steering control).....169

 LDA (Lane Departure Alert).....298

 Low engine oil pressure.....296

 Open door.....89, 90

 Open window.....113

 Pre-collision braking.....163

 Seat belt.....299

Warning lights.....295

 ABS.....297

 Brake hold operated indicator.....301

 Brake Override System.....297

 Brake system.....295

 Charging system.....296

 Drive-Start Control.....297

 Electric power steering.....297

 High coolant temperature.....295

 LDA indicator.....298

 Low engine oil pressure.....296

 Low fuel level.....299

 Malfunction indicator lamp.....296

 Master warning light.....300

 Open door warning.....299

 Parking brake indicator.....300

 Pre-collision system.....298

 Seat belt reminder light.....299

 Slip indicator.....298

 SRS.....296

 Tire pressure.....300

Warning message display.....76

Warning messages.....303

Washer

 Checking.....264

 Preparing and checking before winter.....205

 Switch.....147

Washing and waxing.....242

Weight

 Cargo capacity.....125

Load limits	125
Weight	328
Wheels.....	274
Size.....	334
Window lock switch	113
Windows	
Power windows.....	112
Rear window defogger	219
Washer	147
Windshield wiper de-icer	219
Windshield wipers	147
Winter driving tips.....	205
Wireless remote control	
Battery-Saving Function	96
Locking/Unlocking	86
Replacing the battery.....	277

For information regarding the equipment listed below, refer to the “NAVIGATION AND MULTI-MEDIA SYSTEM OWNER’S MANUAL”.

- Navigation system
- Audio/visual system
- Lexus parking assist monitor





GAS STATION INFORMATION

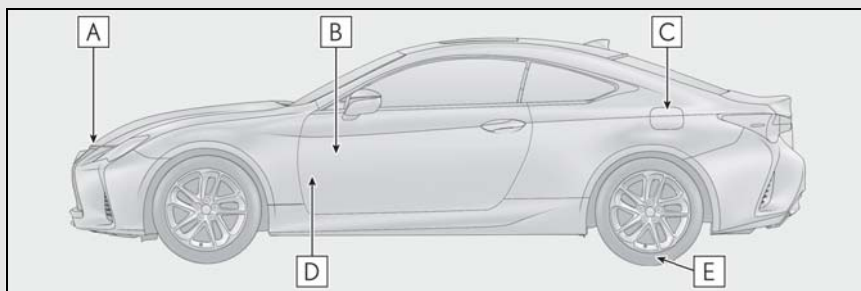

- A** Auxiliary catch lever (→P.255)
- B** Trunk opener (→P.92)
- C** Fuel filler door (→P.156)
- D** Hood lock release lever (→P.255)
- E** Tire inflation pressure (→P.334)

Fuel tank capacity (Reference)	17.5 gal. (66.3 L, 14.6 Imp. gal.)	
Fuel type	Unleaded gasoline only	P.330 P.339
Cold tire inflation pressure		P.334
Engine oil capacity (Drain and refill — reference)		P.330
Engine oil type		P.330