

Content

A-Z



OWNER'S MANUAL.

BMW X7.





WELCOME TO BMW.

Owner's Manual.

Thank you for choosing a BMW.

The more familiar you are with the vehicle, the better control you will have on the road. We therefore strongly suggest the following:

Read this Owner's Manual before starting off in your new BMW. Also use the Integrated Owner's Manual in the vehicle. It contains important notes on vehicle operation that will help you make full use of the technical features available in your BMW. The manual also contains information designed to enhance operating reliability and traffic safety, and to contribute to maintaining the value of your BMW.

At the time of production at the plant, the printed Owner's Manual is the most current resource. After a vehicle software update – such as a Remote Software Upgrade – the Integrated Owner's Manual for the vehicle will contain the latest information.

You can find supplementary information in the additional brochures in the onboard literature.

We wish you a safe and enjoyable ride.

TABLE OF CONTENTS

After a vehicle software update – such as a Remote Software Upgrade – the Integrated Owner's Manual for the vehicle will contain the latest information.

! NOTES

Information	6
-------------------	---

🔑 QUICK REFERENCE

Getting in	16
Set-up and use	19
On the road	22

👉 CONTROLS

Dashboard	30
Sensors of the vehicle	35
Operating state of the vehicle	40
BMW iDrive	44
BMW Remote Software Upgrade	63
Personal settings	67
Opening and closing	73
Seats, mirrors and steering wheel	104
Transporting children safely	123
Driving	130
Displays	145
Light and view	166
Safety	178
Driving stability control systems	216
Driver assistance systems	222
Parking	249
Driving comfort	279
Climate control	286
Interior equipment	304
Storage compartments	312
Cargo area	318

DRIVING TIPS

Things to remember when driving	328
Trailer and rear carrier	334
Saving fuel	342

MOBILITY

Refueling	346
Wheels and tires	348
Engine compartment	378
Operating fluids	381
Maintenance	388
Replacing components	391
Breakdown Assistance	395
Vehicle care	404

REFERENCE

Technical data	410
Appendix	413
Everything from A to Z	414

© 2024 Bayerische Motoren Werke

Aktiengesellschaft

Munich, Germany

Reprinting, including excerpts, only with the written consent of BMW AG, Munich.

US English ID8 II/24, -

Printed on environmentally friendly paper, bleached without chlorine, suitable for recycling.

Information

Using this Owner's Manual

Orientation

The fastest way to find information on a particular topic is by using the index.

For an overview of the vehicle, we recommend reading the Quick Reference Guide in the Owner's Manual.

Validity of the Owner's Manual

Production of the vehicle

At the time of production at the plant, the printed Owner's Manual is the most current resource. Due to updates after the editorial deadline, differences may exist between the printed Owner's Manual and the Integrated Owner's Manual in the vehicle.

Notes on updates can be found in the appendix of the printed Owner's Manual for the vehicle.

After a software update in the vehicle

After a vehicle software update such as via Remote Software Upgrade the Integrated Owner's Manual for the vehicle will contain the latest information.

Owner's Manual for Navigation, Entertainment, Communication

The Owner's Manual for Navigation, Entertainment, and Communication is available as a printed book from an authorized service center.

The topics are also discussed in the Integrated Owner's Manual in the vehicle.

Media at a glance

General information

The contents of the Owner's Manual are available in various media formats. The following Owner's Manual media formats are available:

- ▶ Printed Owner's Manual.
- ▶ Integrated Owner's Manual in the vehicle.

Printed Owner's Manual

The printed Owner's Manual shows all standard, country-specific, and optional equipment that is currently available, or may become available in the future, for specific models.

Integrated Owner's Manual in the vehicle

Principle

The Integrated Owner's Manual shows all standard, country-specific, and optional equipment that is currently available, or may become available in the future, for specific models. The Integrated Owner's Manual can be displayed on the control display.

Selecting the Owner's Manual

1. ■■ Apps menu
2. "All apps"
3. "Owner's Manual"
4. Select the desired method of accessing the contents.

Scrolling through the Owner's Manual

Swipe up or down until the next or previous contents are displayed.

Context help

General information

The Integrated Owner's Manual can be accessed from any menu. Depending on the selected function, either the associated description or the main menu of the Integrated Owner's Manual will be displayed.

Selecting context help from a menu

1. Press and hold the desired menu item.
2. "General help"

Selecting context help from a Check Control message

Directly from the Check Control message on the control display:

"Owner's Manual"

Supplementary Owner's Manuals

Also follow the Supplementary Owner's Manuals, which are included in addition to the on-board literature.

Additional sources of information

Authorized service center

An authorized service center, e.g., a BMW dealer or service center, will be happy to answer any questions you may have.

Internet

Vehicle information and general information on BMW such as on technology are available on the Internet: www.bmwusa.com.

BMW Driver's Guide app

The BMW Driver's Guide app shows all standard, country-specific, and optional equipment that is currently available, or may become

available in the future, for specific models. The app can be displayed on smartphones and tablets.



BMW Driver's Guide Web

The BMW Driver's Guide website shows all standard, country-specific, and optional equipment that is currently available, or may become available in the future, for specific models. The BMW Driver's Guide Web can be displayed in any current browser.

Icons and displays

Icons in the Owner's Manual

Icon Meaning

	Precautions that must be followed in order to avoid the possibility of injury to yourself and to others as well as serious damage to the vehicle.
	Measures that can be taken to help protect the environment.
"..."	Texts in vehicle used to select individual functions.
>...<	Verbal instructions to use with the voice activation system.
>>...<<	Responses generated by the voice activation system.

Action steps

Action steps to be carried out are presented as a numbered list. These steps must be carried out in the order shown.

1. First action step.
2. Second action step.

Bulletpoint lists

Items or actions without strict order or alternative options are shown as a bulletpoint list.

- ▷ First possibility.
- ▷ Second possibility.

Icons on vehicle parts

 This symbol on a vehicle component indicates that further information on the component is available in the Owner's Manual.

Vehicle features and options

This Owner's Manual shows all standard, country-specific, and optional equipment that is currently available, or may become available in the future, for specific models, i.e., model series. Therefore, this Owner's Manual also describes and illustrates equipment, systems and functions that are not available in a vehicle, for example due to the following situations:

- ▷ Selected optional equipment
- ▷ National-market version or national-market equipment
- ▷ Options for later release and software update

This also applies to safety functions and systems.

Before starting a journey, verify whether the described equipment or function is available in the vehicle. For information on whether a function is currently available in the vehicle or when the function can be installed in the vehicle, contact an authorized service center or another qualified service center or repair shop.

A claim for the availability of equipment, a system or a function in the vehicle cannot be derived based on the description in the Owner's Manual.

When using these functions and systems, the applicable laws and regulations must be observed.

For any equipment and models not described in this Owner's Manual, refer to the Supplementary Owner's Manuals.

An authorized service center is happy to answer any questions that you may have about the features and options applicable to the vehicle.

Status of the Owner's Manual

Basic information

The manufacturer of the vehicle pursues a policy of constant development to ensure that our vehicles continue to embody the highest quality and safety standards. In rare cases, therefore, the features described in this Owner's Manual may deviate from those in the vehicle.

Validity of the Owner's Manual

Production of the vehicle

At the time of production at the plant, the printed Owner's Manual is the most current resource. Due to updates after the editorial deadline, differences may exist between the printed Owner's Manual and the Integrated Owner's Manual in the vehicle.

Notes on updates can be found in the appendix of the printed Owner's Manual for the vehicle.

After a software update in the vehicle

After a vehicle software update such as via Remote Software Upgrade the Integrated Owner's Manual for the vehicle will contain the latest information.

For Your Own Safety

Intended use

Heed the following when using the vehicle:

- ▶ Owner's Manual.
- ▶ Information on the vehicle. Do not remove stickers.
- ▶ Technical vehicle data.
- ▶ The traffic, speed, and safety laws where the vehicle is driven.
- ▶ Vehicle documents and statutory documents.

Warranty

The vehicle is technically configured for the operating conditions and registration requirements applicable in the country of first delivery, also known as homologation. If the vehicle is to be operated in a different country it might be necessary to adapt the vehicle to potentially differing operating conditions and registration requirements. Noncompliance with homologation requirements in a certain country may affect warranty coverage. Please consult the New Vehicle Limited Warranty Booklet for further information on warranty matters.

Maintenance and repairs

Advanced technology, for instance the use of modern materials and high-performance electronics, requires suitable maintenance and repair work.

The vehicle manufacturer therefore recommends having necessary work performed by an authorized service center, e.g., a BMW dealer or service center. If a different repair shop is selected, BMW recommends selecting a workshop that performs the appropriate work such as maintenance and repair according to BMW specifications with properly trained personnel. In the Owner's Manual, such workshops are referred to as "another qualified service center or repair shop".

If work is not carried out properly, for instance maintenance and repair, there is a risk of subsequent damages and related safety risks.

Improperly performed work on the vehicle paintwork can lead to a failure or fault of com-

ponents, e.g., the radar sensors, and thereby result in a safety hazard.

Parts and accessories

BMW recommends the use of parts and accessory products approved by BMW.

Approved parts and accessories, and advice on their use and installation are available from an authorized service center.

BMW parts and accessories have been tested by BMW for their safety and suitability in BMW vehicles.

BMW warrants genuine BMW parts and accessories.

BMW does not evaluate whether each individual product from another manufacturer can be used with BMW vehicles without presenting a safety hazard, even if a country-specific official approval was issued. BMW does not evaluate whether these products are suitable for BMW vehicles under all usage conditions.

California Proposition 65 Warning

For vehicles sold in California, the law requires vehicle manufacturers to provide the following warning:

Warning

Engine exhaust and a wide variety of Automobile components and parts, including components found in the interior furnishings in a vehicle, contain or emit chemicals known to the State of California to cause cancer and birth defects and reproductive harm. In addition, certain fluids contained in vehicles and certain products of component wear contain or emit chemicals known to the State of California to cause cancer and birth defects or other reproductive harm. Battery posts, terminals and related accessories contain lead and lead compounds. Batteries also contain other chemicals known to the State of California to cause cancer. Wash your hands after handling. Used engine oil con-

tains chemicals that have caused cancer in laboratory animals. Always protect your skin by washing thoroughly with soap and water. For more information go to www.P65Warnings.ca.gov/passenger-vehicle.

Warning

Operating, servicing and maintaining a passenger vehicle or off-highway motor vehicle can expose you to chemicals including engine exhaust, carbon monoxide, phthalates, and lead, which are known to the State of California to cause cancer and birth defects or other reproductive harm. To minimize exposure, avoid breathing exhaust, do not idle the engine except as necessary, service the vehicle in a well-ventilated area and wear gloves or wash your hands frequently when servicing the vehicle. For more information go to www.P65Warnings.ca.gov/passenger-vehicle.

Service and warranty

We recommend that you read this publication thoroughly. The vehicle is covered by the following warranties:

- ▶ New Vehicle Limited Warranty.
- ▶ Rust Perforation Limited Warranty.
- ▶ Federal Emissions System Defect Warranty.
- ▶ Federal Emissions Performance Warranty.
- ▶ California Emission Control System Limited Warranty.

Detailed information about these warranties is listed in the New Vehicle Limited Warranty Booklet.

The vehicle has been specifically adapted and designed to meet the particular operating conditions and homologation requirements in your country and continental region in order to deliver the full driving pleasure while the vehicle is operated under those conditions. If you wish

to operate the vehicle in another country or region, you may be required to adapt the vehicle to meet different prevailing operating conditions and homologation requirements. You should also be aware of any applicable warranty limitations or exclusions for such country or region. In such case, please contact Customer Relations for further information.

Maintenance

Maintain the vehicle regularly to sustain the road safety, operational reliability and the New Vehicle Limited Warranty.

Specifications for maintenance measures:

- ▶ BMW maintenance system.
Maintenance, refer to page 388.
- ▶ Maintenance Booklet, available online and accessible via a QR code in the New Vehicle Limited Warranty Booklet.
- ▶ Warranty and Service Guide Booklet for Canadian models.

If the vehicle is not maintained or is improperly maintained, this could result in serious damage to the vehicle.

A failure to maintain the vehicle or improper maintenance may affect your warranty coverage. Please consult the New Vehicle Limited Warranty Booklet for further information on warranty matters.

Refer to section on engine oil change regarding recommended service intervals for oil changes.

Data memory

General information

Electronic control devices are installed in the vehicle. Electronic control units process data they receive from vehicle sensors, self-generate or exchange with each other. Some control units are necessary for the vehicle to function safely or provide assistance while driving,

for instance driver assistance systems. Furthermore, control units facilitate comfort or infotainment functions.

Information about stored or exchanged data can be requested from the manufacturer of the vehicle, in a separate booklet, for example.

Personal reference

Each vehicle is marked with a unique vehicle identification number. Depending on the country, the vehicle owner can be identified with the vehicle identification number, license plate and corresponding authorities. In addition, there are other ways to associate data collected from the vehicle with the driver or vehicle owner, e.g., the ConnectedDrive account used.

Operating data in the vehicle

Control units process data to operate the vehicle.

For example, this includes:

- ▶ Status messages for the vehicle and its individual components, e.g., wheel RPM, wheel speed, deceleration, lateral acceleration, engaged seat belt indicator.
- ▶ Ambient conditions, e.g., temperature, rain sensor signals.

The processed data is only processed in the vehicle itself while the vehicle is being operated. Data is not stored beyond the operating time.

Electronic components, e.g. control units and vehicle keys, contain components for storing technical information. Information about the vehicle condition, component usage, maintenance recommendations, events or faults can be stored temporarily or permanently.

This information generally documents the state of a component, a module, a system, or the surrounding area, for instance:

- ▶ Operating states of system components such as fill levels, tire pressure, battery status.
- ▶ Malfunctions and faults in important system components, for instance lights and brakes.
- ▶ Responses by the vehicle to special driving situations such as airbag deployment or engagement of the driving stability control systems.
- ▶ Information on vehicle-damaging events.

The data is required to perform the control unit functions. Furthermore, it also serves to detect and correct malfunctions, and helps the vehicle manufacturer to optimize vehicle functions.

The majority of this data is stored temporarily and is only processed within the vehicle itself. In some circumstances the vehicle may store some data for an additional but limited period of time.

When servicing, for instance during repairs, service processes, warranty cases, and quality assurance measures, this technical information can be read out from the vehicle together with the vehicle identification number.

An authorized service center or another qualified service center or repair shop can read out the information. The diagnostic socket required by law in the vehicle is used to read out data.

The data is collected, processed, and used by the relevant organizations in the service network. The data documents technical conditions of the vehicle, which can be used to determine vehicle maintenance status, and facilitate quality improvement.

Vehicle fault and event memories can be reset by an authorized service center or another qualified service center or repair shop when performing repair or servicing work.

Data entry and data transfer into the vehicle

General information

Depending on the vehicle equipment, comfort and individual settings can be stored in the vehicle and modified or reset at any time.

For example, this includes:

- ▶ Settings for the seat and steering wheel positions.
- ▶ Chassis and air conditioning settings.

If necessary, data can be transferred to the entertainment and communication system of the vehicle, for instance via smartphone.

This includes the following depending on the respective equipment:

- ▶ Multimedia data such as music, films or photos for playback in an integrated multimedia system.
- ▶ Address book data for use in conjunction with an integrated hands-free system or an integrated navigation system.
- ▶ Entered navigation destinations.
- ▶ Data on the use of Internet services.

This data can be stored locally in the vehicle or is found on a device that has been connected to the vehicle, e.g., a smartphone, USB stick or MP3 player. If this data is stored in the vehicle, it can be deleted at any time.

This data is only transmitted to third parties upon personal request as part of the use of online services. The transmission depends on the selected settings for the use of the services.

Incorporation of mobile devices

Depending on the vehicle equipment, mobile devices connected to the vehicle, for instance smartphones, can be controlled via the vehicle operating elements.

The sound and picture from the mobile devices can be played back and displayed through the multimedia system. Certain information is

transferred to the mobile devices at the same time. Depending on the type of incorporation, this includes, for instance, position data and other general vehicle information. This optimizes the way in which selected apps, for instance navigation or music playback, work.

There is no further interaction between the mobile device and the vehicle such as active access to vehicle data.

How the data will be processed further is determined by the provider of the particular app being used. The extent of the possible settings depends on the respective app and the operating system of the mobile device.

Services

General information

If the vehicle has a wireless network connection, it will enable data to be exchanged between the vehicle and other systems. The wireless network connection is realized via an in-vehicle transmitter and receiver unit or via personal mobile devices brought into the vehicle, for instance smartphones. This wireless network connection enables 'online functions' to be used. These include online services and apps supplied by the vehicle manufacturer or by other providers.

Services from the vehicle manufacturer

Where online services from the vehicle manufacturer are concerned, the corresponding functions are described in the appropriate place, for instance the Owner's Manual or manufacturer's web page. The relevant legal information pertaining to data protection may also be found on the manufacturer's website. Personal data may be used to perform online services. Data is exchanged over a secure connection, for instance with the IT systems of the vehicle manufacturer intended for this purpose.

Any collection, processing, and use of personal data above and beyond that needed to provide the services must always be based on a

legal permission, contractual arrangement or consent. It is also possible to activate or deactivate the data connection as a whole. This excludes functions and services required by law such as Assist systems.

Services from other providers

When using online services from other providers, these services are the responsibility of the relevant provider and subject to their data privacy conditions and terms of use. The vehicle manufacturer has no influence on the content exchanged during this process. Information on the way in which personal data is collected and used in relation to services from third parties, the scope of such data, and its purpose, can be obtained from the relevant service provider.

Event Data Recorder (EDR)

This vehicle is equipped with an event data recorder (EDR). The main purpose of an EDR is to record, in certain crash or near crash-like situations such as an air bag deployment or hitting a road obstacle, data that will assist in understanding how a vehicle's systems performed. The EDR is designed to record data related to the driving dynamics and safety systems for a short time: max. 30 seconds, typically less.

The EDR in this vehicle is designed to record the following data, for example:

- ▶ How various systems in the vehicle were operating.
- ▶ Whether or not the driver and passenger seat belts were fastened.
- ▶ How far, if at all, the driver was depressing the accelerator and/or brake pedal.
- ▶ How fast the vehicle was traveling.

This data can help provide a better understanding of the circumstances in which crashes and injuries occur.

EDR data is recorded by the vehicle only if a nontrivial crash situation occurs; no data is recorded by the EDR under normal driving conditions and no personal data, for instance name, gender, age, and crash location, are recorded.

However, other parties such as law enforcement could combine the EDR data with the type of personally identifying data routinely acquired during a crash investigation.

To read data recorded by an EDR, special equipment is required, and access to the vehicle or the EDR is needed. In addition to the vehicle manufacturer, other parties such as law enforcement that have the special equipment can read the information if they have access to the vehicle or the EDR.

Vehicle identification number

General information

Depending on the national-market equipment, the vehicle identification number is located in different positions in the vehicle. This chapter describes all possible positions for the series.

Engine compartment



The engraved vehicle identification number can be found in the engine compartment, on the right-hand side of the vehicle.

Right nameplate



The vehicle identification number can be found on the nameplate, on the right-hand side of the vehicle.

Left nameplate



The vehicle identification number can be found on the nameplate, on the left-hand side of the vehicle.

Windshield



The vehicle identification number can also be found behind the windshield.

iDrive

It is also possible to display the vehicle identification number via iDrive.

1. ■■ Apps menu
2. "All apps"
3. "Mobile devices"
4. "Settings"
5. "Vehicle ID (VIN):"

Reporting safety defects

For US customers

The following only applies to vehicles owned and operated in the US.

If you believe that the vehicle has a defect which could cause a crash or could cause injury or death, you should immediately inform the National Highway Traffic Safety Administration (NHTSA), in addition to notifying BMW of North America, LLC, P.O. Box 1227, Westwood, New Jersey 07675-1227, Telephone 1-800-831-1117.

If NHTSA receives similar complaints, it may open an investigation, and if it finds that a safety defect exists in a group of vehicles, it may order a recall and remedy campaign.

However, NHTSA cannot become involved in individual problems between you, your dealer, or BMW of North America, LLC.

To contact NHTSA, you may call the Vehicle Safety Hotline toll-free at 1-888-327-4236 (TTY: 1-800-424-9153); go to <http://www.safercar.gov>; or write to: Administrator, NHTSA, 1200 New Jersey Avenue, SE., Washington, DC 20590. You can also obtain other information about motor vehicle safety from <http://www.safercar.gov>.

For Canadian customers

Canadian customers who wish to report a safety-related defect to Transport Canada, De-

fect Investigations and Recalls, may call the toll-free hotline 1-800-333-0510. You can also obtain other information about motor vehicle safety from <http://www.tc.gc.ca/roadsafety>.

Getting in

Opening and closing

Vehicle key



Buttons on the vehicle key.

Icon	Meaning
	Unlock.
	Lock. Pre-conditioning.
	Open the cargo area.
	Panic mode. Pathway lighting.

Access to vehicle interior

Unlocking with the vehicle key

 Press the button on the vehicle key.

If only the driver's door and fuel filler flap have been unlocked due to the settings in place, press the button on the vehicle key again to unlock the other vehicle access points.

Locking with the vehicle key

1. Close the driver's door.
2.  Press the button on the vehicle key. All vehicle access points are locked.

Buttons for the central locking system

Overview

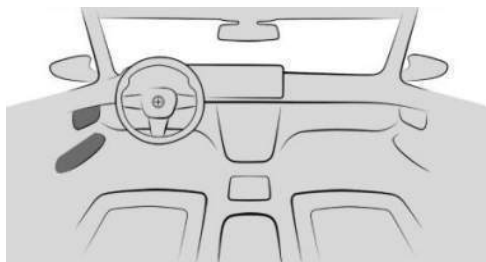

The central locking buttons are located on the front door.

 Lock.

 Unlock.

Locking the vehicle

 Press the button with the front doors closed.

The fuel filler flap remains unlocked.



Unlocking the vehicle

 Press the button.



Panic mode

You can trigger the alarm system if you find yourself in a dangerous situation.

- ▶  Press the button on the vehicle key and hold for at least 3 seconds.
- ▶  Briefly press the button on the vehicle key three times in succession.

To switch off the alarm: press any button.

Access to the cargo area

Opening the cargo area

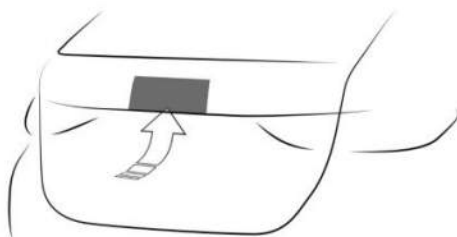

- ▶ Unlock the vehicle and then press the button on the cargo area.
- ▶  Press and hold the button on the vehicle key for approx. 1 second.
Depending on the setting, the doors may be unlocked.

Closing the cargo area

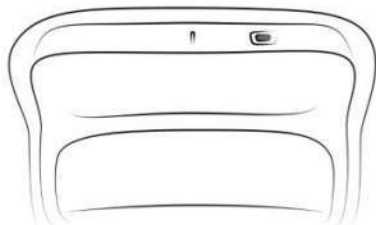

Press the button on the inside of the cargo area.

Displays, operating elements

In the vicinity of the steering wheel



- 1 Light switch
- 2 Turn signal, high-beam headlights
- 3 Instrument cluster
- 4 Wipers

Indicator/warning lights

The indicator/warning lights can illuminate in a variety of combinations and colors.

Several of the lights are checked for proper functioning and illuminate temporarily when drive-ready state is turned on.

Driver's door

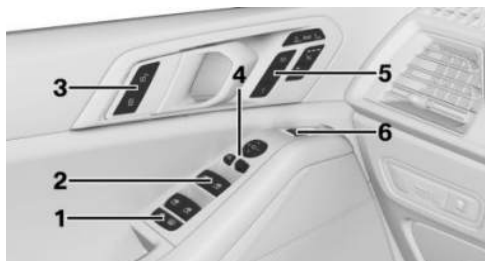

- 1 Safety switch
- 2 Power windows
- 3 Central locking system
- 4 Exterior mirrors

- 5 Seats, comfort features
- 6 Cargo area

Switch console



- 1 Selector lever
- 2 Controller
- 3 Parking brake, Automatic Hold
- 4 Driving Experience Control
- 5 Start/Stop button
- 6 Assistance systems

BMW iDrive

Principle

BMW iDrive is the vehicle's display and operating concept and includes a wide range of functions.

Buttons on the Controller

Button Function

HOME	Call up the main menu.
MEDIA	Call up the Media/Radio menu.
TEL	Go to Phone menu.

Button Function

MAP	Call up the navigation map.
NAV	Call up the destination input menu for navigation.
BACK	Go to previous menu.
OPTION	Call up the Options menu.

BMW Intelligent Personal Assistant

Principle

The BMW Intelligent Personal Assistant is a personal assistant that enables natural voice operation of various vehicle functions.

Activating the voice control system

-  Press the button on the steering wheel briefly.
- Say the command.

Canceling voice control

- ▶  Press the button on the steering wheel again.
- ▶ >Cancel<
- ▶ Slide the Controller to the right or left.
- ▶ Press the Controller.



Set-up and use

Seats, mirrors and steering wheel

Adjusting seats

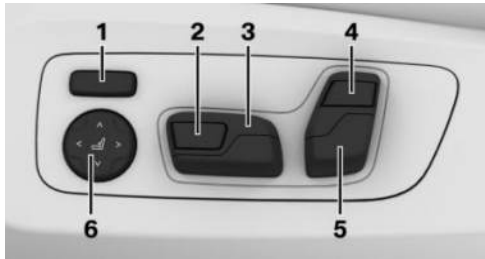

- 1 Backrest width
- 2 Thigh support
- 3 Longitudinal direction/height/seat tilt
- 4 Upper backrest
- 5 Backrest tilt/head restraint
- 6 Lumbar support

Adjusting the head restraint

Adjusting the height

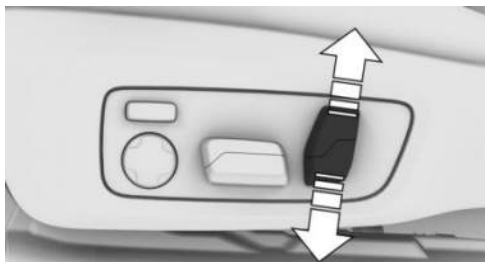

Press switch up or down.

Side extensions



Fold the side extensions forward to increase side support.

Adjusting the exterior mirrors



Icon	Meaning
	Fold the exterior mirror in and out.
	Adjust the exterior mirrors.
	Select exterior mirror, Automatic Curb Monitor.



Adjusting the steering wheel position

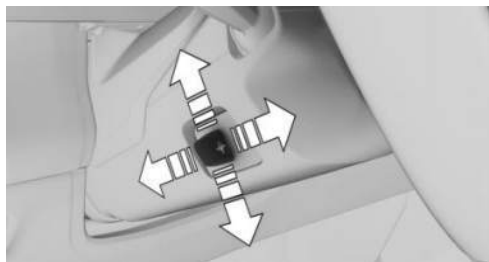

Press the switch to adjust the steering wheel forward/back position and height to the seat position.

Memory function

Principle

The following settings can be stored and, if necessary, retrieved using the memory function:

- ▶ Seat position.
- ▶ Exterior mirror adjustment.
- ▶ Steering wheel position.
- ▶ Height of the Head-up display.

Overview



The memory buttons are located on the front doors.

Storing settings

1. Set the desired position.
2. **SET** Press the button. The LED illuminates.
3. Press the desired memory button as long as the LED is illuminated. A signal sounds.

Calling up settings

Press the desired memory button 1 or 2.





Infotainment

Navigation destination input

1. Navigation menu
2. "Destination input"
 - A search box and entered information such as the search history are displayed.
3. Select the desired entry or the search box.
4. When selecting the search box, enter characters or choose one of the POI categories displayed.
 - If necessary, select **OK** to display more information, e.g. to preview a map.
 - If necessary, accept the suggested search keywords.
5. Select the desired entry.
6. "Start guidance"

Entertainment

Depending on vehicle variant, the center console or instrument panel provides the following operating elements:

Operating element	Function
	<p>Turn the volume button to adjust the volume.</p> <p>Press the volume button to turn off sound output. Pressing the button again restores the previous volume setting.</p>
	Change the entertainment source.
	Press once: changes the station/track.
	Press and hold: fast forward/rewind the track.

Using the mobile phone

General information

After the mobile phone is connected once to the vehicle, the mobile phone can be operated using iDrive and the steering wheel buttons.

Activate Bluetooth® on the mobile phone.

Connecting via Bluetooth®

-  Apps menu
- "All apps"
- "Mobile devices"
- "Connect new device"

Mobile phones in range are displayed on the control display.

- Select the desired mobile phone.
- Compare the control number displayed on the control display with the control number in the display of the mobile phone, and confirm that they match.
- If necessary, select the connection mode: "Use Bluetooth®"

The device is connected and displayed in the device list.

Accepting a call

Depending on the equipment, incoming calls can be answered in several ways.

- ▷ Via iDrive:



 "Accept"



- ▷ Press the button on the steering wheel.

- ▷ Use the knurled wheel on the steering wheel to select from the list in the instrument cluster: "Accept"

Dialing a number

-  Communication menu
- "More"
- "Dial number"
- Enter the numbers.
-  Select the icon. The connection is established via the mobile phone to which this function has been assigned.

On the road

Driving

Drive-ready state

Turning on the drive-ready state

1. Depress the brake pedal.

2.  On the center console, press the Start/Stop button.

Turning off drive-ready state

After stopping the vehicle:

1. While the vehicle is stationary, depress the brake and engage selector lever position P.
2. Set the parking brake.
3. Press the Start/Stop button.

The READY indicator goes out and a signal tone sounds.

The drive-ready state is switched off automatically if the driver's seat belt is not buckled when the driver's door is opened.

Auto Start/Stop function

The Auto Start/Stop function helps to conserve fuel. The system switches off the engine during a stop, for instance in traffic jam or at traffic lights. Drive-ready state remains switched on. The engine starts automatically under the following preconditions:

- ▷ By releasing the brake pedal.
- ▷ When Automatic Hold is activated: step on the accelerator pedal.

Steptronic transmission

Engaging selector lever position D, N, R, S

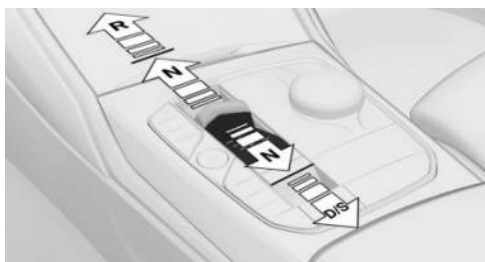

- ▷ D is drive.
- ▷ N Neutral.
- ▷ Reverse R.
- ▷ S Sport mode.

To prevent the vehicle from moving after engaging drive or reverse, maintain pressure on the brake pedal until you are ready to drive off.

Engage selector lever position R only when the vehicle is stationary.

Sport program: the gearshift behavior is designed for a sportier driving behavior.

Engaging selector lever position P

Engage selector lever position P only when the vehicle is stationary.



Press button P.



Parking brake

Setting the parking brake

-  Pull the switch.
The LED on the switch and the indicator light in the instrument cluster are illuminated.

Releasing the parking brake

-  With drive-ready state switched on:
Press the switch while stepping on the brake pedal or selector lever position P is set.

The LED and the indicator light go out.

The parking brake is released.

Parking

Make sure the parking brake is engaged.

Light and view

Turn signal, high-beam headlights, headlight flasher

Turn signal

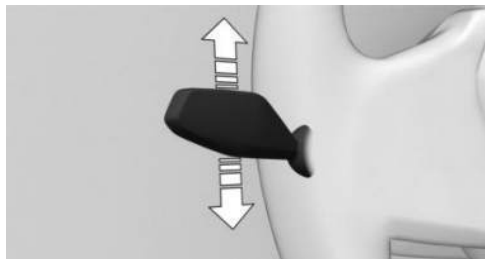

- ▶ Flashing: press the lever past the resistance point.
- ▶ One-touch signaling: lightly tap the lever up or down.
- ▶ Brief flashing: press the lever to the resistance point and hold it there for as long as you want the turn signal to flashing.

High-beam headlights, headlight flasher





Press the lever forward or pull it backward.







- ▶ High-beam headlights on, arrow 1.
The high-beam headlights illuminate when the low-beam headlights are switched on.
- ▶ High-beam headlights off/headlight flasher, arrow 2.

Lights and lighting

Buttons in the vehicle

Icon	Function
	Exterior lighting menu.
	Automatic headlight control. Low-beam headlights. Exterior lighting off.
	Exterior lighting off.

Functions via iDrive

Icon	Function
	Automatic headlight control.
	Low-beam headlights.
	Parking lights.
	Exterior lighting off.
	Left roadside parking light.
	Right roadside parking light.

Window wiper system

Turning on window wiper system

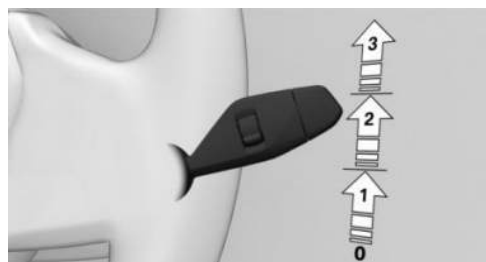

Press the lever up until the desired position is reached.

- ▷ Rest position of the wipers, position 0.
- ▷ Rain sensor mode, position 1.
- ▷ Normal wiper speed, position 2.
- ▷ Fast wiper speed, position 3.

Turning off the window wiper system and flick wipe

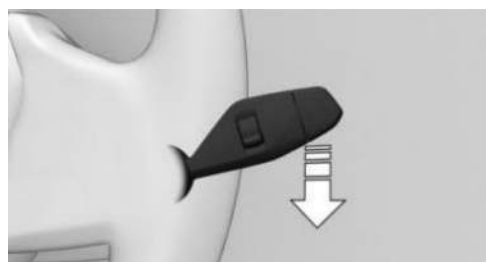

Press the lever down.

- ▷ Turning off: press the lever down until it reaches the 0 position.
- ▷ Flick wipe: press the lever down from the 0 position.

The lever automatically returns to its 0 position when released.



Activating/deactivating rain sensor

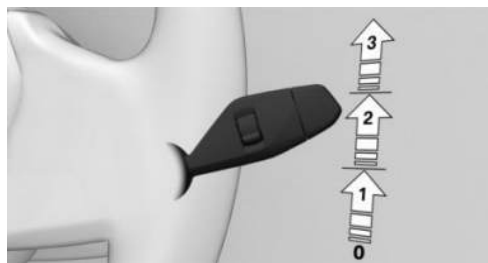

Enable: press lever up once from the 0 position, arrow 1.

Disable: press lever back into the 0 position.

Adjusting the rain sensor sensitivity

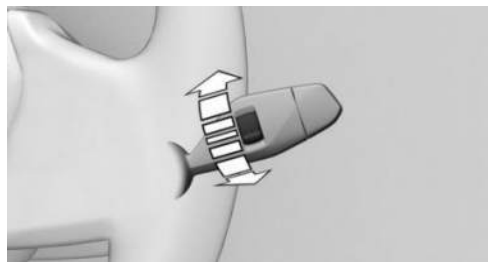

Turn the knurled wheel on the wiper lever.

Cleaning the windshield

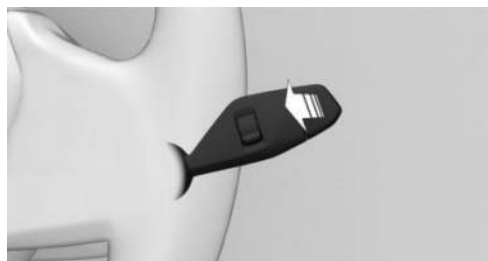

Pull the lever.

Rear wiper

Switching on the rear wiper

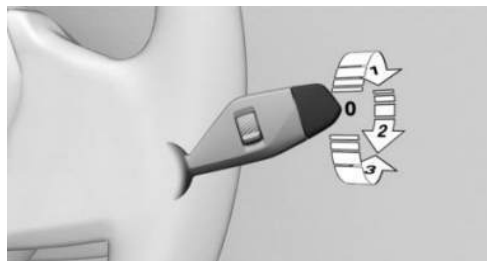

Turn the outer switch upward.

- ▷ Resting position of wiper, position 0.
- ▷ Intermittent operation, arrow 1. When reverse gear is engaged, the system switches to continuous operation.

Clean the rear window

Turn the outer switch in the desired direction.













- ▷ In rest position: Turn the switch downward, arrow 3. The switch returns to its rest position when released.
- ▷ In intermittent operation: turn the switch further, arrow 2. The switch automatically returns to its interval position when released.

Climate control

Climate control functions



Functions in the Climate menu

Icon	Function
	Turn the climate control system on/off.
AUTO	Automatic program.

Icon	Function
	Temperature.
	Air conditioning.
	Maximum cooling.
	Air recirculation mode.
	Automatic recirculated-air control.
	Fresh air.
	Air flow.
	Air distribution.
	SYNC program.
	Seat and armrest heating.
	Active seat ventilation.
	Steering wheel heating.

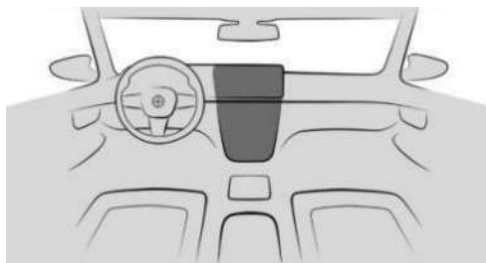



Buttons, automatic climate control





Icon	Function
	Defrost function.
	Rear window defroster.

Buttons, rear automatic climate control

- ▶ Second-row seating: the control panel for the rear climate control is located in the rear center console.
- ▶ Third-row seating: the control panel for the rear climate control is located in the headliner.

Icon	Function
	Automatic program.
	Temperature.
	Air conditioning.
	Maximum cooling.
	Air flow.



Icon	Function
	Air distribution.
	Seat and armrest heating.

Intermediate stop

Refueling

Fuel filler cap

1. To open the fuel filler flap, press on the rear edge, arrow. The fuel filler flap opens.



2. Open the fuel filler cap counterclockwise.

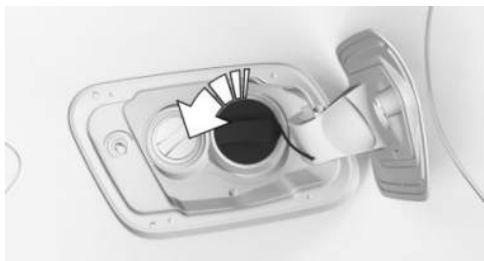

3. Place the fuel filler cap in the bracket on the fuel filler flap.



Wheels and tires

Tire pressure specifications

The tire inflation pressure specifications can be found in the tire inflation pressure table in the printed Owner's Manual.

After correcting the tire pressure

If equipped with a Tire Pressure Monitor, the corrected tire pressures are applied automatically. Make sure that the correct tire settings have been made. With tires that cannot be found in the tire pressure values on the control display, reset the Tire Pressure Monitor (TPM).

If equipped with a flat tire monitor, reinitialize the flat tire monitor.

Checking the tire pressure

Regularly check the tire inflation pressure and correct it as needed:

- ▷ At least twice a month.
- ▷ Before embarking on an extended trip.

Electronic oil measurement

Functional requirements

A current measured value is available after approx. 30 minutes of normal driving with the combustion engine running.

Displaying the engine oil level

1.  Apps menu
2. "Vehicle"
3. "Vehicle status"
4. "Engine oil level"

The engine oil level is displayed.

Adding engine oil

General information

Safely park the vehicle and switch off drive-ready state before adding engine oil.

Adding engine oil

1. Opening the hood.
2. Open the lid counterclockwise.



3. Add engine oil.
4. Close the lid.

Providing assistance

Hazard warning system

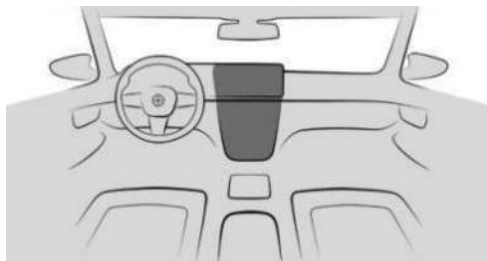

Hazard warning system button

ConnectedDrive

BMW Assistance

Contact BMW Assistance for information and support for all aspects of the vehicle.

1.  Apps menu
2. "All apps"
3. "BMW Assist"
4. If necessary, select the desired service.

A voice connection to the selected service is established.

BMW Teleservices

Teleservices are services that help to maintain vehicle mobility.

Teleservices can comprise the following services:

- ▷ BMW Roadside Assistance.
- ▷ BMW Accident Assistance.
- ▷ Teleservice Call.
- ▷ An authorized service center.

Dashboard

Vehicle features and options

This chapter describes model-specific equipment, systems, and functions that are currently



available, or may become available in the future, even if they are not present in the vehicle.

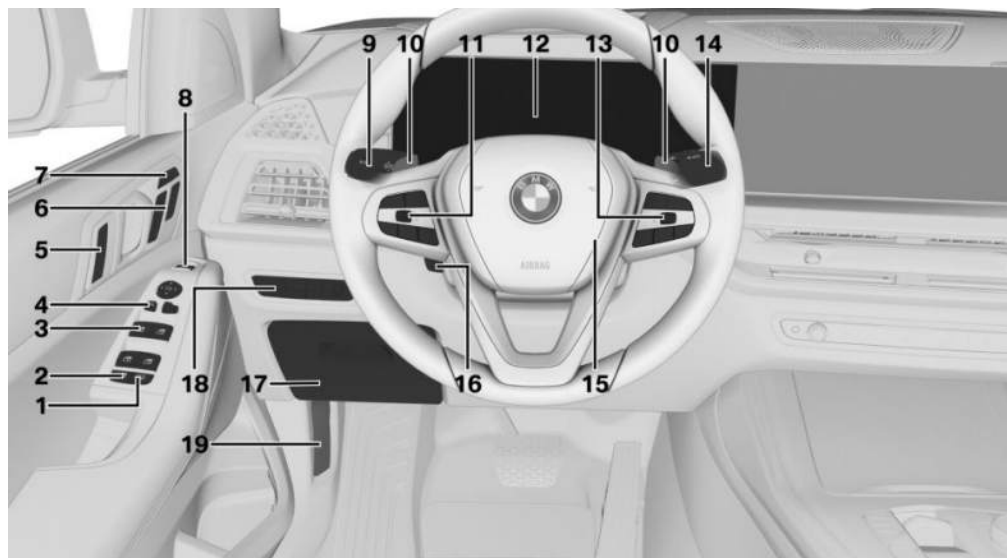

Additional information:

Vehicle equipment, refer to page 8.

























In the vicinity of the steering wheel



- 1  Roller sunblinds, rear side windows 97
- 2  Safety switch for the windows and roller sunblinds 98
- 3  Power windows 95
- 4 Exterior mirror adjustment button 119
- 5 Central locking system 90

-  Unlocking
-  Locking

- 6 Seating comfort features

-  Front passenger seat functionality [107](#)
-  Memory function [121](#)
-  Massage function [104](#)
- 7**  Operating the second seat row [111](#)
- 8**  Opening and closing cargo area [81](#)
- 9** Turn signal lever
-  Turn signal [166](#)
-  High-beam headlights, headlight flasher [166](#)
-  Automatic High Beam Assistant [167](#)
-  Trip data [160](#)
G-Meter [162](#)
- 10** Shift paddles
- 11** Steering wheel buttons, left
-  Turn speed control systems on/off [224](#)
-  Select speed control system [224](#)
-  Store speed [224](#)
-  Resume speed control systems with the stored setting.
-  Interrupt speed control systems.
-  Adjusting the speed [224](#)
- 12** Instrument cluster [145](#)
- 13** Steering wheel buttons, right
-  Displaying menu bar in instrument cluster [145](#)
-  Volume, see Owner's Manual for Navigation, Entertainment and Communication [6](#)
-  Voice activation system [53](#)
-  Selecting menu contents in instrument cluster [145](#)
Changing the station/track, see Owner's Manual for Navigation, Entertainment, Communication [6](#)
-  Telephone, see Owner's Manual for Navigation, Entertainment and Communication [6](#)
-  Knurled wheel for selecting configuration menus for instrument cluster and Head-up display [145](#)
Using infotainment selection lists in the instrument cluster [155](#)
- 14** Wiper lever
-  Wipers [174](#)
-  Rain sensor [175](#)
-  Cleaning the windshield [176](#)
-  Rear wiper in Canadian models [176](#)



Rear wiper 176



Clean the rear window 176



Horn, entire surface



Adjusting the steering wheel 121

17 Fold-out compartment 313

18 Lights



Exterior lighting menu 47



Driving lights automatic 169

Low-beam headlights 169

Adaptive lighting functions 172



Exterior lighting off 169

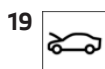

Unlocking the hood 379

In the vicinity of the center console

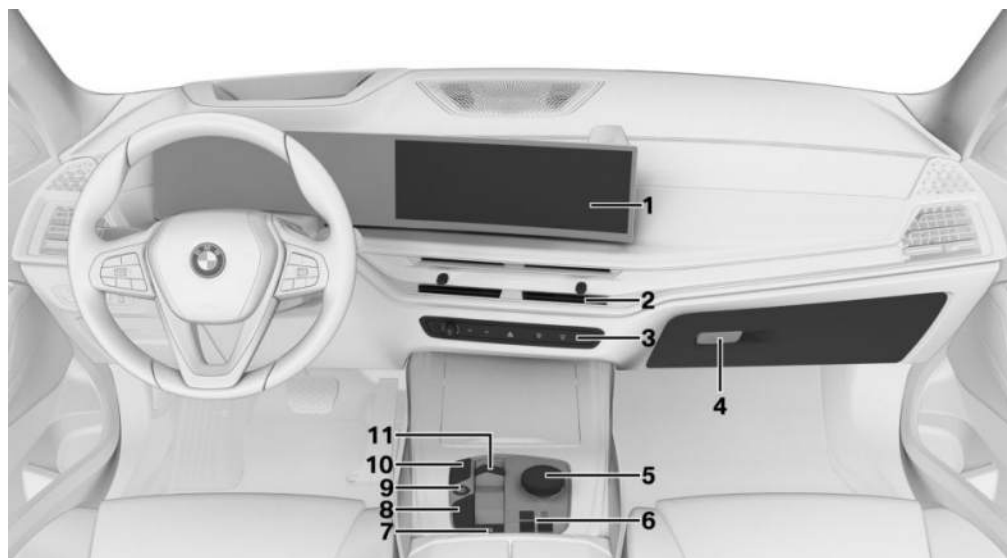

1 Control display 48

2 Ventilation 295

3  Hazard warning system 395















Climate control 286



Defrost function 293









Rear window defroster 293

- Radio/multimedia, see Owner's Manual for Navigation, Entertainment, and Communication [6](#)
-  Adjusting the volume
-  Station/title forward
-  Station/title back
- 4** Button for glove compartment [312](#)
- 5** Controller with buttons [50](#)
- 6**  Two-axle ride level control [279](#)
-  xOffroad package [282](#)
- 7**  Parking brake [140](#)
-  Automatic Hold [142](#)
- 8**  Driving Experience Control [138](#)
SPORT drive mode
-  COMFORT drive mode
-  ECO PRO drive mode
-  Hill Descent Control [219](#)
- 9**  Turning drive-ready state on/off [130](#)
- 10**  Auto Start/Stop function [131](#)
-  Parking assistance systems [249](#)
-  Dynamic Stability Control [216](#)
- 11** Selector lever [133](#)

In the vicinity of the headliner



- | | |
|--|---|
| <p>1  Emergency Call, SOS 398</p> | <p>5  Depending on the vehicle equipment: opening the rear sun protection 99</p> |
| <p>2  Glass sunroof 99</p> | <p> Depending on the vehicle equipment: closing the rear sun protection 99</p> |
| <p>3  Indicator light, front passenger airbag 180</p> | <p>6  Interior lights 172</p> |
| <p>4  Reading lights 173</p> | |

Sensors of the vehicle

Vehicle features and options

This chapter describes model-specific equipment, systems, and functions that are currently available, or may become available in the future, even if they are not present in the vehicle.

Additional information:

Vehicle equipment, refer to page 8.

Overview

Depending on the equipment, the following cameras and sensors are installed in the vehicle:

- ▶ Front camera.
- ▶ Camera behind the windshield.
- ▶ Top view cameras.
- ▶ Rearview camera.
- ▶ Front radar sensor.
- ▶ Radar sensors, side, front.
- ▶ Radar sensors, side, rear.
- ▶ Ultrasonic sensors in the front/rear bumpers.
- ▶ Ultrasonic sensors, side.

Cameras

Front camera



The front camera is located in the radiator grille.

Camera behind the windshield

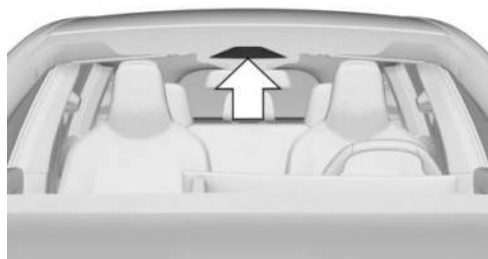

The camera behind the windshield is located near the interior mirror.

Top view cameras



One exterior mirror camera is located at the bottom of each exterior mirror housing.

Rearview camera

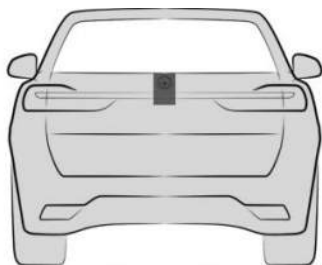

The rearview camera is located in the handle strip on the rear of the vehicle.

Functional requirement of the cameras

The areas of the cameras are clean and clear.

Additional information:

- ▷ Washing the vehicle, refer to page 404.
- ▷ Vehicle care, refer to page 405.

System limits of the cameras

The cameras may not work properly, e.g., show something that is incorrect, in the following situations:

- ▷ In heavy fog, wet conditions, or snowfall.
- ▷ On steep hills, in steep depressions or in tight curves.

- ▷ When the camera field of view is covered, for instance by a fogged up windshield or labels.
- ▷ If the camera lens is dirty or damaged.
- ▷ With exterior mirrors folded in.
- ▷ With open doors or open cargo area.
- ▷ When driving toward bright lights or strong reflections, e.g., setting sun.
- ▷ When it is dark outside.
- ▷ The camera has overheated due to excessive temperatures and temporarily turned off.
- ▷ During calibration of the camera immediately after vehicle delivery.

If applicable, a Check Control message will be displayed when the system limits are reached.

Radar sensors

Safety information

Warning

The vehicle radar sensors and thus also the driver assistance systems can be impaired by external influences, e.g., interference. There is a risk of accident, injury, or property damage. Watch the surrounding traffic situation closely, be ready to take over steering and braking at any time, and actively intervene where appropriate.

Front radar sensor



The front radar sensor is located in the front bumper.

Radar sensors, side, front



The radar sensors are located on the side of the front bumper.

Radar sensors, side, rear

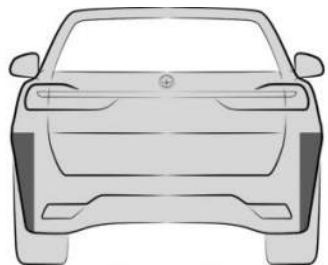

The radar sensors are located on the side of the rear bumper.

Functional requirement of the radar sensors

The areas of the radar sensors are clean and clear.

Additional information:

- ▶ Washing the vehicle, refer to page 404.
- ▶ Vehicle care, refer to page 405.

System limits of the radar sensors

The function of the radar sensors may be restricted or not available, for instance in the following situations:

- ▶ In case of dirty sensors.
- ▶ In case of iced-up sensors.
- ▶ If sensors are covered such as by labels, films or a license-plate carrier.
- ▶ If the sensor is not aligned correctly, for instance due to parking damage.
- ▶ If the radiation range of the sensors is covered, e.g., by protruding cargo.
- ▶ When the field of view of the sensors is covered, e.g., by garage walls, hedges, snow hills, vehicles or trailers.
- ▶ After improper paint work on the vehicle in the area of the sensors.
- ▶ On steep hilltops or in sharp dips in the road.

If applicable, a Check Control message will be displayed when the system limits are reached.

Ultrasonic sensors

Ultrasonic sensors, front

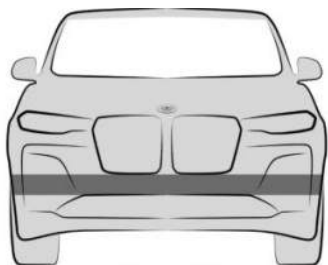

The ultrasonic sensors of the parking assistance systems are located in the front bumper.

Ultrasonic sensors, rear

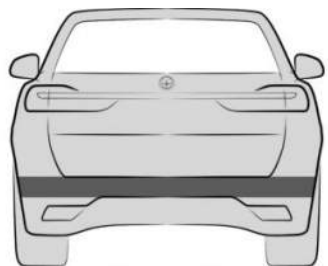

The ultrasonic sensors of the parking assistance systems are located in the rear bumper.

Ultrasonic sensors, side

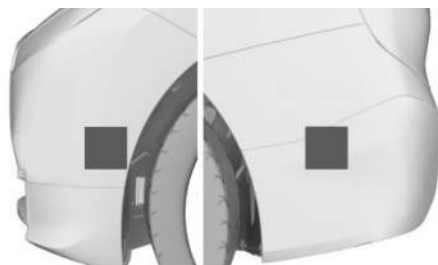

The ultrasonic sensors for the parking assistance systems are located on the sides of the front and rear bumpers.

Functional requirement of the ultrasonic sensors

The areas of the ultrasonic sensors are clean and clear.

Additional information:

- ▷ Washing the vehicle, refer to page 404.
- ▷ Vehicle care, refer to page 405.

System limits of the ultrasonic sensors

The detection of objects with ultrasonic measurements can run into physical limits, e.g., in the following situations:

- ▷ If the sensors are dirty or covered, e.g., by stickers.
- ▷ If the sensor is not aligned correctly, for instance due to parking damage.
- ▷ After improper paint work on the vehicle in the area of the sensors.
- ▷ For small children and animals.
- ▷ For persons with certain clothing, for instance jacket.
- ▷ With obstacles and persons at the edge of the lane.
- ▷ In case of external interference with the ultrasonics, for instance from passing vehicles, loud machines or other ultrasonic sources.
- ▷ Under certain weather conditions, e.g., high moisture, wet conditions, snowfall, cold, extreme heat, or strong wind.
- ▷ With tow bars and trailer hitches of other vehicles.
- ▷ With thin or wedge-shaped objects.
- ▷ With moving objects.
- ▷ With elevated, protruding objects such as ledges.
- ▷ With objects with corners, edges, and smooth surfaces.

- ▷ In the case of objects with fine surfaces or structures, e.g., wire mesh fences.
- ▷ For objects with porous surfaces.
- ▷ With small and low objects, for instance boxes.
- ▷ Low objects already displayed, for instance curbs, can be outside of the detection ranges of the sensors.
- ▷ With soft obstacles or obstacles covered in foam material.
- ▷ With plants and bushes.
- ▷ In automatic car washes.
- ▷ In the event of uneven floors, e.g. speed bumps.
- ▷ If there are large amounts of exhaust gas.
- ▷ Cargo that extends beyond the perimeter of the vehicle is not taken into account by the ultrasonic sensors.
- ▷ When the trailer hitch cover is not on straight.

If applicable, a Check Control message will be displayed when the system limits are reached.

Operating state of the vehicle

Vehicle features and options

This chapter describes model-specific equipment, systems, and functions that are currently available, or may become available in the future, even if they are not present in the vehicle.

Additional information:

Vehicle equipment, refer to page 8.

General information

Depending on the situation, the vehicle is in one of the three states:

- ▷ Idle state.
- ▷ Standby state.
- ▷ Drive-ready state.

Idle state

Principle

When the vehicle is in idle state, it is switched off.

General information

The vehicle is in idle state prior to opening from the outside and after exiting and locking.

Safety information

Warning

An unsecured vehicle can begin to move and possibly roll away. There is a risk of accident, injury, or property damage. Before leaving the vehicle, secure the vehicle against rolling away.

In order to ensure that the vehicle is secured against rolling away, follow the following:

- ▷ Set the parking brake.
- ▷ On uphill grades or on downhill slopes, turn the front wheels in the direction of the curb.
- ▷ On uphill grades or on downhill slopes, also secure the vehicle, for instance with a wheel chock.

Warning

Unattended children or animals in the vehicle can cause the vehicle to move and endanger themselves and traffic, for example, due to the following actions:

- ▷ Establishing standby.
- ▷ Releasing the parking brake.
- ▷ Opening and closing the doors or windows.
- ▷ Engaging selector lever position N.
- ▷ Using vehicle equipment.

There is a risk of accident, injury, and property damage. Do not leave children or animals unattended in the vehicle. Take the vehicle key with you when exiting and lock the vehicle.

Establishing the sleep mode automatically

The sleep mode is established automatically such as in the following situations:

- ▶ After several minutes, if no operation takes place on the vehicle.
- ▶ If the charge state of the vehicle battery is low.
- ▶ Depending on the configuration via iDrive: one or both front doors will be opened after driving when exiting the vehicle.

In some situations, the idle state is not set automatically, for instance during a phone call or when the low-beam headlights are switched on.

Establishing idle state when opening the front doors

After a trip, the sleep mode can be established by opening the front doors. For this purpose, all passengers must exit the vehicle.

1.  Apps menu
2. "Vehicle"
3. "Doors and windows"
4. "Lock/unlock"
5. "Turn off after opening door"

Establishing the sleep mode manually

To establish idle state in the vehicle after completion of trip:



Press and hold the volume button on the radio until the OFF indicator on the instrument cluster disappears.

Deep sleep mode

Principle

Deep sleep mode is activated to prevent the vehicle battery from discharging when the vehicle is stationary for several weeks.

In deep sleep mode, the vehicle functions are limited to the essentials.

General information

When the vehicle is shut down for longer than three months, some special measures are necessary. For more information, contact an authorized service center or another qualified service center or repair shop.

Activating deep sleep mode

1.  Apps menu
2. "Vehicle"
3. "System settings"
4. "Deep sleep mode"
5. Select the desired setting.

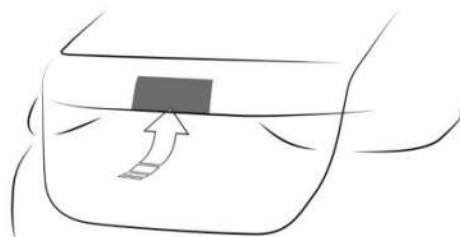

Press the button on the trunk to access the vehicle while in deep sleep mode. Deep sleep mode remains on in this case.

Deactivating deep sleep mode

- ▶ Turn off the function on the control display.
- ▶ Driving with the vehicle.

Standby state

Principle

When standby state is switched on, most functions can be used while the vehicle is stationary. Desired settings can be adjusted.

General information

The vehicle is in the standby state after the front doors are opened from the outside.

Manually setting to standby

General information

Standby can be switched back on after the vehicle is automatically set to idle state.

Using the volume button on the radio



Press the volume button on the radio. The control display and the instrument cluster illuminate.

Using the Start/Stop button



Press the Start/Stop button. The control display and the instrument cluster illuminate.

Display in the instrument cluster



OFF is displayed in the instrument cluster. Drive-ready state is turned off and standby state turned on.

Drive-ready state

Principle

Turning on drive-ready state corresponds to starting the engine.

General information

Some vehicle functions can only be used with the drive-ready state switched on.

Safety information

DANGER

If the exhaust pipe is blocked or ventilation is insufficient, harmful exhaust gases can penetrate the vehicle. The exhaust gases contain pollutants which are colorless and odorless. In enclosed areas, exhaust gases can also accumulate outside of the vehicle. There is a danger to life. Keep the exhaust pipe free and ensure sufficient ventilation.

Warning

An unsecured vehicle can begin to move and possibly roll away. There is a risk of accident, injury, or property damage. Before leaving the vehicle, secure the vehicle against rolling away.

In order to ensure that the vehicle is secured against rolling away, follow the following:

- ▷ Set the parking brake.
- ▷ On uphill grades or on downhill slopes, turn the front wheels in the direction of the curb.
- ▷ On uphill grades or on downhill slopes, also secure the vehicle, for instance with a wheel chock.

NOTICE

Repeatedly attempting to start the engine or repeatedly starting the vehicle in rapid succession can cause the starter to overheat. This also results in unburned or inadequately burned fuel, and can cause the catalytic converter to overheat. There is a risk of property damage. Avoid repeated starting of the vehicle, particularly repeated starting in rapid succession.

Turning on the drive-ready state

General information

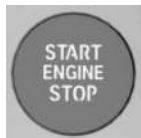

Drive-ready state is turned on using the Start/Stop button.

Turning on the drive-ready state

1. Depress the brake pedal.
2. Press the Start/Stop button.

The ignition is activated automatically for a brief time and is stopped as soon as the engine starts.

Most of the indicator lights and warning lights on the instrument cluster illuminate for different lengths of time.

Gasoline engine

Depending on the motorization, the full drive power may not be available for approximately 30 seconds after starting the engine. In this case, the vehicle will not accelerate as usual.

Additional information:

Power gauge, refer to page [156](#).

Display in the instrument cluster

The activated drive-ready state is indicated in the instrument cluster, depending on the equipment, by the display of information required for driving or the READY display.

Turning off drive-ready state

1. Engage selector lever position P with the vehicle stopped.
2. Set the parking brake.
3. Press the Start/Stop button.

The engine is switched off. The vehicle switches into standby state.

BMW iDrive

Vehicle features and options

This chapter describes model-specific equipment, systems, and functions that are currently available, or may become available in the future, even if they are not present in the vehicle.

Additional information:

Vehicle equipment, refer to page 8.

Display and operating concept

Principle

BMW iDrive is the vehicle's display and operating concept and includes a wide range of functions.

General information

Depending on vehicle equipment, the functions can be operated as follows:

- ▶ Via the control display.
- ▶ Via the Controller.
- ▶ Via the touchpad.
- ▶ Via the BMW Intelligent Personal Assistant.
- ▶ Via the gesture control.
- ▶ Via the operating elements on the steering wheel.

Additional information:

Instrument cluster, refer to page 145.

Safety information

Warning

Operating the integrated information systems and communication devices while driving can distract from surrounding traffic. It is possible to lose control of the vehicle. There is a risk of accident, injury, or property damage. Only use the systems or devices when the traffic situation allows. As warranted, stop and use the systems and devices while the vehicle is stationary.

Main menu

General information

The main menu is divided into different areas.

Overview

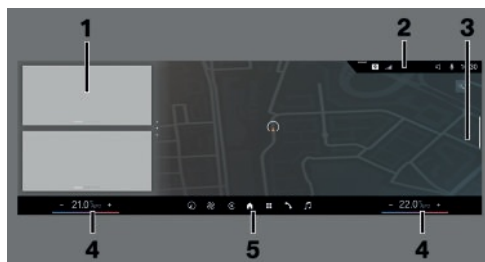

- 1 Widgets
- 2 Status information
- 3 Configuration bar for main display
- 4 Temperature setting
- 5 Menu bar

Menu bar

Apps menu

 Access to apps and vehicle functions. A filter can be selected. If necessary, change the filter to see the apps you want.

- ▷ "All apps": All apps and functions are displayed.
- ▷ "Infotainment": Only infotainment apps are displayed.
- ▷ "Vehicle": Only vehicle adjustment functions are displayed.
- ▷ "Recently used": The most recently used apps are displayed.

Media menu

 Access to entertainment system functions, e.g., radio stations or external device pairing.

Communication menu

 Access to telephone and message function as well as pairing and management of mobile devices, e.g., smartphones.

Navigation menu

 Access to navigation system, destination entry, and traffic information. Configurable map views and other functions such as points of interest.

Climate menu

 The Climate menu provides access to all climate control functions.

Apple CarPlay® menu

 Depending on national-market version with associated function: Access to Apple CarPlay. Apple CarPlay enables the secure use of certain functions of a compatible Apple iPhone via iDrive.

Android Auto® menu

 Depending on national-market version with associated function: Access to Android Auto. Android Auto enables the secure use of certain functions of a compatible Android smartphone via iDrive.

Widgets

Widgets show real-time information and dynamic content such as current media or paired smartphones. The widgets also serve as buttons and allow jumping to the relevant menu.

Main display



The main display shows real-time information and dynamic content such as the navigation map. This display also contains buttons and lets you jump to the desired menu.

Status information



General information

The status field can be found in the upper area of the control display. Status information is displayed in the form of icons. Depending on the equipment and national-market version, different icons are available.

Telephone status information

Icon	Meaning
	Active call.
	Signal strength.
	SIM card missing.

Entertainment status information

Icon	Meaning
	USB audio.
	Bluetooth audio.
	Smartphone audio.

Icon	Meaning
	Connected Music with Spotify.
	Time shift.
	Wi-Fi.
	Apple CarPlay.
	Android Auto.
	Satellite radio is switched on.

Status information messages

Icon	Meaning
	Number of notifications.
	Check Control message.
	Suppress private information.
	Do not disturb.
	Message.

Additional information:

Owner's Manual for Navigation, Entertainment, and Communication, refer to page 6.

Other status information

Icon	Meaning
	Sound output active.
	Sound output deactivated.
	Activation word active.
	BMW ID or driver profile.
	Destination guidance active.
	Go to quick access.
	Wireless charging active.
	Park Distance Control: sound active.
	Park Distance Control: sound deactivated.

Input and display

Letters and numbers

Letters and numbers can be entered using the controller, touchpad, control display, or voice control, depending on vehicle equipment.

Icon	Function
	Change between capital and lower-case letters.
	Enter a blank space.
	Switching between languages.
	Use voice control.
	Confirm entry.
	Shift the input area to the left or right.

Entry comparison

When entering data from a database such as contacts, the selection is gradually narrowed down for each character entered, with characters being added as necessary.

Activating/deactivating the functions

Some menu items are preceded by an icon. Selecting the menu item enables or disables the function.

Icon	Meaning
	Function is activated.
	Function is deactivated.

Enabling/disabling audible feedback

For some functions, audio confirmation is given, e.g., sounds are emitted when operating the control display.

- Apps menu
- "Vehicle"
- "System settings"

- "Sound"
- Select the desired setting.

Quick access

The quick link provides access to shortcuts, certain settings, and app recommendations.

Input	Operation
Show quick link.	Swipe from top to bottom on the control display. Slide the controller up. — Tap the icon on the status bar.
Hide quick link.	Swipe from the bottom up on the control display. Slide the controller down.

Activating/deactivating pop-ups

For some functions, pop-ups are displayed automatically on the control display. Some of these pop-ups can be activated or deactivated.

-  Apps menu
- "Vehicle"
- "System settings"
- "Pop-ups"
- Select the desired setting.

Shortcuts

General information

The iDrive functions can be stored on the shortcuts and called up directly, for instance radio stations, navigation destinations, phone numbers and menu entries.

Storing a function

- Select the desired function.
- Press and hold the desired function.
- "Add to shortcuts"

Shortcuts can only be created with an active BMW ID or a driver profile.

Executing a function

- Swipe from top to bottom on the control display.
- Tap the desired shortcut.

The function will work immediately. This means for instance that the connection is established when a phone number is selected.

Deleting shortcuts

- Swipe from top to bottom on the control display.
- Press and hold the desired shortcut.
- "Delete shortcut"

Direct access

General information

The vehicle has buttons that can be used to access menus for the respective function directly on the control display. Then continue the operation via iDrive.

Overview

Button Function



Go to the Exterior Lighting menu between the steering wheel and driver's door.

BMW Curved Display

Principle

The BMW Curved Display is a single-screen display in the instrument panel that is curved towards the driver. The BMW Curved Display comprises the instrument cluster on the driver's side and the control display.

General information

Follow instructions for cleaning the BMW Curved Display in the Care chapter.

Additional information:

Caring for special components, refer to page 407.

Overview



- 1 Instrument cluster 145
- 2 Control display 48

Control display

Principle

The iDrive functions are displayed on the control display.

Safety information

Warning

When driving, loose items or devices connected to the vehicle with a cable, i.e., mobile phones, may be thrown around the vehicle, e.g., in the event of an accident or when braking or performing evasive maneuvers. There is a risk of injury and risk of property damage. Secure loose objects or devices that are connected to the vehicle via a cable.

Warning

Objects in the area in front of a display can slip and damage the display. There is a risk of injury or risk of damage to property. Do not place objects in the area in front of a display.

Overview

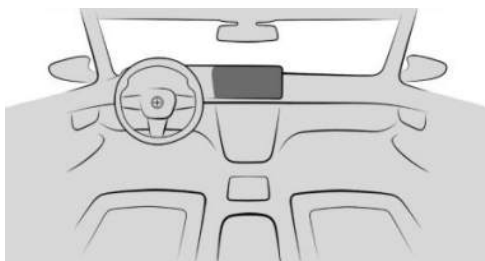

Control display.

Switching the control display on/off automatically

The control display is turned on automatically when the vehicle is unlocked or as soon as the control display is needed for operation.

In certain situations, the control display is switched off automatically, for instance if no operation is performed on the vehicle for several minutes.

Switching the control display on/off manually

1. Swipe from top to bottom on the control display.
 2. "Screen off"
- Tap the control display to turn it on again.

Setting the brightness

1.  Apps menu
2. "Vehicle"
3. "Displays"

4. "Control display"
5. "Brightness at night"
6. Make the desired setting.

Depending on the light conditions, the brightness control may not be clearly visible.

System limits

In the case of very high temperatures on the control display, for instance due to intense solar radiation, the brightness may be reduced down to complete deactivation. Once the temperature is reduced, for instance through shade or air conditioning system, the normal functions are restored.

Controller

Principle

The Controller can be used to select menu items and enter the settings. The buttons can be used to open the menus directly.

Overview

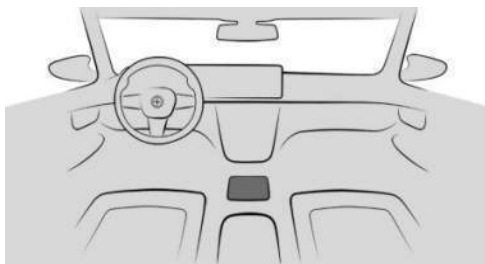

Controller

Buttons on the Controller

Button	Function
HOME	Call up the main menu.
MEDIA	Call up the Media/Radio menu.
TEL	Go to Phone menu.
MAP	Call up the navigation map.
NAV	Call up the destination input menu for navigation.
BACK	Go to previous menu.
OPTION	Call up the Options menu.

Operation

- ▶ Rotate the Controller to switch between menu options, for example.

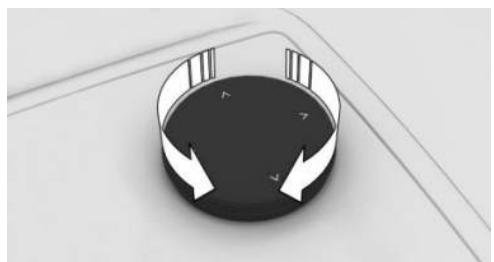

- ▶ Press the Controller to select a menu option, for example.

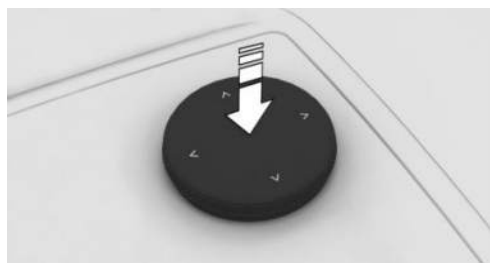

- ▶ Slide the Controller in four directions to switch between menus, for example.

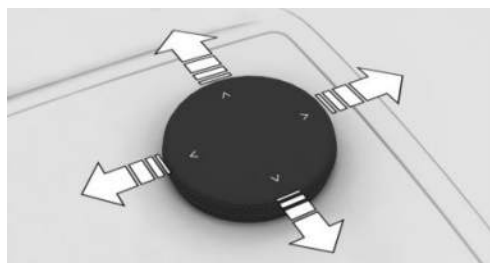

3. Tilt the Controller to the right.
4. Select the desired main display.

Selecting a widget

1. Use the Controller to select widgets.
2. If necessary, turn the Controller until the desired widget is selected.
3. Press the Controller.

Switching between menus

A new display opens after a menu item is selected.

- ▶ Slide the Controller to the left.
The current menu closes and the previous menu is displayed.
- ▶  Press the button.
The current menu closes and the previous menu is displayed.

Operating via the Controller

Opening the main menu

- ▶  Press the button.

The main menu is displayed.

Selecting menu items

1. Turn the Controller until the desired menu item is highlighted.
2. Press the Controller.

Adjusting the main display

The main display can be adjusted in the main menu.

1.  Press the button.
2. If necessary, tilt the Controller to select the main display.

Calling up the context menu

Depending on the menu item, a context menu with additional options can be displayed.

1. Select the desired menu item using the Controller.
2. Press and hold the Controller.
The menu consists of various areas, for instance:
 - ▶ "General help": Go to the Integrated Owner's Manual.
 - ▶ "Add to shortcuts": define menu item as shortcut.



Entering letters and numbers

Input

1. Turn the Controller: select letters or numbers.
2. **OK** : confirm entry.
Additional information:

Setting the system language, refer to page 55.

Deleting an entry

Icon	Function
	Press Controller: delete a letter or number.
	Hold the Controller down: delete all letters or numbers.

Using alphabetical lists

For alphabetical lists with more than 30 entries, the letters for which an entry exists can be displayed in a text box.

1. Turn the Controller to the left or right quickly.
2. Select the first letter of the desired entry.
The first entry of the selected letter is displayed in the list.

Operation via touchpad

General information

Depending on vehicle equipment, some iDrive functions can be operated with the controller touchpad.

The touchpad is located on the Controller. Touch the touchpad with your fingers. Do not use any objects.

Selecting functions

1.  Apps menu
2. "Vehicle"
3. "System settings"
4. "Touchpad"
5. Select the desired setting.

Entering letters and numbers

- ▶ Enter characters as they are displayed on the control display.
- ▶ Always enter associated characters such as accents or periods so that the letter can be clearly recognized.
- ▶ The set language determines what input is possible. Where necessary, enter special characters via the Controller.

Additional information:

Setting the system language, refer to page 55.

Entering special characters

Function	Operation
Delete a character.	Swipe to the left on the touchpad.
Enter a blank space.	Swipe to the right in the center of the touchpad.
Enter a hyphen.	Swipe to the right in the upper area of the touchpad.
Enter an underscore.	Swipe to the right in the lower area of the touchpad.

Using the map

The map in the navigation system can be moved via the touchpad.

Tap the map on the control display and then continue operation using the touchpad.

Function	Operation
Move map.	Swipe in the appropriate direction.
Display menu.	Tap once.

Using alphabetical lists

Alphabetical lists with more than 30 entries permit a direct jump to letters for which an entry exists.

Enter the first letter on the touchpad.

The first entry of the entered letter is displayed in the list.

Operation via control display

General information

Depending on the equipment version, the control display is equipped with a touchscreen.

You can tap on menu items and widgets. Touch the control display with your fingers. Do not use any objects.

Opening the main menu

 Tap on the icon.

The main menu is displayed.

Adjusting the main display

The main display can be adjusted in the main menu.

1.  Tap on the icon.
2. Swipe the configuration bar on the right side of the screen to the left.
3. Select the desired main display.

Sorting apps

To resort the app icons, press and hold the desired icon and move it to the desired location.

Switching between menus

A new display opens after a menu item is selected.

 Select the arrow symbol.

The current menu closes and the previous menu is displayed.

Calling up the context menu

Depending on the menu item, a context menu with additional options can be displayed.

Press and hold the desired menu item.

The menu consists of various areas, for instance:



- ▷ "General help": Go to the Integrated Owner's Manual.
- ▷ "Add to shortcuts": define menu item as shortcut.

Entering letters and numbers

Input

1. If necessary, tap the  icon or control display.
2. Enter desired letters and numbers.

Deleting an entry

Icon	Function
	Tap icon: delete a letter or a number.
	Press and hold the icon: delete all letters or numbers.

Using the map

The navigation map can be moved on the control display.

Function	Operation
Move map.	Swipe in the appropriate direction.
Enlarge/shrink map.	Drag in or out with the fingers.
Display menu.	Tap once.

Using alphabetical lists

For alphabetical lists with more than 30 entries, the letters for which an entry exists can be displayed in a text box.

1. Tap the letter in front of the list.
A letter box is displayed.
2. Tap the first letter of the desired entry.
The first entry of the selected letter is displayed in the list.

BMW Intelligent Personal Assistant

Principle

The BMW Intelligent Personal Assistant is a personal assistant that enables natural voice operation of various vehicle functions. The Personal Assistant makes it easier to operate the vehicle by providing proactive suggestions and automating habits.

General information

- ▶ BMW Intelligent Personal Assistant is available depending on national-market version.
- ▶ The system includes special microphones on the driver side and the front passenger side.
- ▶ Say the commands and numbers fluently as well as with normal volume, emphasis, and speed.
- ▶ >...< identifies commands that can be spoken.

Functional requirements

- ▶ A language that is supported by the Personal Assistant must be set via iDrive.
Setting the system language, refer to page 55.
- ▶ Always say commands in the configured system language.

For the full range of functions, you must activate, configure, or purchase the following functions:

- ▶ Online speech processing, refer to page 56.
- ▶ For all settings under Data protection, refer to page 67.
- ▶ Activation word, refer to page 54.
- ▶ BMW ID or a driver profile.
- ▶ Relevant ConnectedDrive services from the ConnectedDrive Store.
- ▶ Suggestions, refer to page 56.

Activating the voice control system

General information

There are various methods for activating the voice control feature:

- ▶  Press the button on the steering wheel briefly.
The microphone on the driver's side is active.
- ▶ Speaking the activation word.
The microphones on the driver's or front passenger's side are active with the following voice control, depending on where the activation word was spoken.

Then say the command. The activation word and the command can be spoken without pause in one sentence.

Microphone button on steering wheel

1.  Press button briefly.
2. Say the command.

Activation word

General information

Saying the activation word will start the Personal Assistant. The Personal Assistant listens.

Preset activation word

>Hello BMW<: The default activation word can be activated and deactivated.

1.  Apps menu
2. "Vehicle"
3. "System settings"
4. "Voice control"
5. "Personal Assistant (BMW)"
6. "Wake word"
7. ""Hello BMW""

Personal activation word

In addition to the preset activation word, a personal activation word can be set up with an active BMW ID or a driver profile. The personal activation word can also be changed or deleted.

The activation word should consist of multiple syllables to ensure good recognition.

>Hello<: The additional phrase is not necessary for the activation word and does not need to be spoken.

1.  Apps menu
2. "Vehicle"
3. "System settings"
4. "Voice control"
5. "Personal Assistant (BMW)"
6. "Wake word"
7. "Personal wake word"
8. "Set"
9. "Start recording"

Activation word from third-party providers

Depending on the national-market version, some third-party providers provide digital voice assistants such as Siri or Amazon Alexa.

To use Siri, the smartphone must be connected via Apple CarPlay.

Supported voice assistants can be used with a connected smartphone in the vehicle.

The activation word from connected third-party providers can be used in addition to your preset or personal activation word from BMW.

1.  Apps menu
2. "Vehicle"
3. "System settings"
4. "Voice control"
5. "Additional speech assistants"
6. Select the desired setting.

Canceling voice control

- ▶  Press the button on the steering wheel again.
- ▶ >Cancel<
- ▶ Slide the Controller to the right or left.
- ▶ Press the Controller.

Possible commands

General information

Commands can be used to give instructions or ask questions, with the Personal Assistant providing assistance.

For example, you can call contacts, navigate to an address, apply settings, or ask questions about a vehicle function. Most vehicle functions can be operated via voice commands, e.g., the Automatic Parking Assistant.

Most content on the control display can be spoken as commands, e.g., menu items or list entries.

Help for voice control

- ▶ ›Voice commands‹: have possible example commands suggested.
- ▶ ›General information on voice control‹: have information on the operating principle of the voice control announced.
- ▶ ›Help‹: have tips and example commands for voice control announced.
- ▶ Additional example commands for the current context are displayed in the widget of the BMW Intelligent Personal Assistant.

Sample commands

- ▶ ›Call John Smith‹
- ▶ ›Drive me to JFK airport‹
- ▶ ›Play a classical music station‹
- ▶ ›Is my tire pressure still OK?‹
- ▶ ›Activate the climate control‹
- ▶ ›Increase the ACC distance‹
- ▶ ›Sport mode‹

Additional example commands can be displayed on the control display.

1.  Apps menu
2. "All apps"
3. "Personal Assistant"
4. "Help"
5. "Example commands"

Sample commands for the current context are displayed in the BMW Intelligent Personal Assistant widget.

Additional information:

Adjust widgets, refer to page [52](#).

Menu items

The Personal Assistant can bring up menu items directly. Say the menu items as they are displayed on the control display. You do not

have to follow the order of the menu items when speaking them out loud.

1. Activate the voice control system.
2. ›Media‹
3. ›Presets‹

The stored stations are displayed on the control display.

Owner's Manual via voice operation

You can ask simple questions about vehicle functions and the operation of the vehicle.

The voice activation system and the feedback it provides do not replace the printed or Integrated Owner's Manual. The function is available depending on the national-market version. The speech recognition and quality of the feedback may vary.

Example command: ›How can the passenger airbag be deactivated?‹

The Personal Assistant returns feedback. When stationary, the section of the integrated Owner's Manual is displayed on the control display.

Settings

Setting the system language

1.  Apps menu
2. "Vehicle"
3. "System settings"
4. "Language"
5. Select the desired setting.

Setting the response length

You can set the Personal Assistant to use standard dialog or a short version. In case of the short version, the announcements by the Personal Assistant are played back in an abbreviated version.

1.  Apps menu
2. "Vehicle"



3. "System settings"
4. "Voice control"
5. "Personal Assistant (BMW)"
6. "Response length"
7. Select the desired setting.

Speaking during voice output

It is possible to answer during inquiries of the Personal Assistant. The function can be disabled if requests are often canceled unintentionally, for instance due to background noise or conversations in the vehicle.

1. Apps menu
2. "Vehicle"
3. "System settings"
4. "Voice control"
5. "Personal Assistant (BMW)"
6. "Speaking during voice output"

Suggestions

General information

The Personal Assistant provides helpful, individual suggestions.

Activating/deactivating suggestions

1. Apps menu
2. "Vehicle"
3. "System settings"
4. "Voice control"
5. "Personal Assistant (BMW)"
6. "Receive suggestions"

Adapting suggestions

Suggestions can be adapted, for example, by category or to output a signal tone.

1. Apps menu
2. "Vehicle"
3. "System settings"

4. "Voice control"
5. "Personal Assistant (BMW)"
6. Select the desired setting.

Online speech processing

Online speech processing improves the quality of the speech recognition and search results for points of interest. To use the functions, data is transmitted to a service provider via an encrypted connection and stored locally there. An active ConnectedDrive contract is required for online voice processing. ConnectedDrive is available depending on the national-market version. Online speech processing is not available in all languages.

1. Apps menu
2. "Vehicle"
3. "System settings"
4. "Voice control"
5. "Personal Assistant (BMW)"
6. "Online speech processing"

Configuring the visualization

How the Personal Assistant is visualized can be set.

1. Apps menu
2. "Vehicle"
3. "System settings"
4. "Voice control"
5. "Personal Assistant (BMW)"
6. "Visualization"

Voice control from third-party providers

Depending on vehicle equipment, third-party voice control can be enabled by pressing and holding the microphone button on the steering wheel.

1. Apps menu
2. "Vehicle"

3. "System settings"
4. "Voice control"
5. "Long press"
6. Select the desired setting.

Adjusting the volume



Turn the volume button during the voice guidance until the desired volume is set.

The volume remains constant even if the volume of other audio sources is changed.

Using the voice activation of the smartphone

Depending on the device, a smartphone connected to the vehicle can be used via voice control.

The device must be connected via Apple Car-Play or Android Auto.

1. Press and hold the  button on the steering wheel for approx. 3 seconds.
The voice activation of the smartphone is activated.
If activation is successful, a confirmation appears on the control display.
2. Press and hold the  button on the steering wheel to cancel voice control of the smartphone.

Amazon Alexa Car Integration

Principle

Amazon Alexa Car Integration is available depending on vehicle equipment and national-market version. Alexa is a digital assistant from Amazon. With Amazon Alexa Car Integration, Alexa can be used in the vehicle. For safety reasons, the use of some Alexa functions may be restricted while driving your vehicle.

Functional requirements

- ▷ A BMW ID or driver profile is activated.
- ▷ An active Amazon account must exist.

Activating Amazon Alexa Car Integration

Amazon Alexa Car Integration is activated in the vehicle and My BMW app if necessary.

Follow the instructions from the Amazon Alexa app to set it up in the vehicle.

1.  Apps menu
2. "All apps"
3. "Amazon Alexa"
4. Select the desired setting.

After setting it up, use Amazon Alexa in the vehicle as follows:

Say the activation word "Alexa" and the desired command.

Information about the active function is displayed on the control display. If the function is restricted, reconnect Bluetooth and Wi-Fi as necessary.

Automating routines

General information

The Personal Assistant can automate routines, for instance the automatic opening of windows in the same place. Rules are created for this purpose, which can be activated and deactivated at any time.

Activating/deactivating routines

1.  Apps menu
2. "All apps"
3. "Automate habits"
4. Select the desired setting.



System limits

- ▶ The Personal Assistant provides information about vehicle functions that may not be installed in the vehicle.
This also applies to safety functions and systems.
- ▶ Certain noises can be detected and may lead to problems. Keep the doors and windows closed.
- ▶ Noises from the front passenger or occupants can impair the system. Avoid making other noise in the vehicle while speaking.
- ▶ Major language dialects can cause problems with the speech recognition feature.
- ▶ A poor data connection affects the response time of the Personal Assistant and search function.

BMW Gesture Control

Principle

Several iDrive functions can be operated by hand motion using BMW Gesture Control.

Overview



The camera in the headliner detects gestures that are carried out in the area of the center console at the height of the control display.

The camera of the gesture control uses an invisible Class 1 laser.

Activate/deactivate gesture control

1. Apps menu
2. "Vehicle"
3. "System settings"
4. "Gesture control"
5. "Gesture control"

Settings



1. Apps menu
2. "Vehicle"
3. "System settings"
4. "Gesture control"
5. Select the desired setting.

Carrying out gestures

- ▶ Perform gestures underneath the interior mirror and next to the steering wheel.
- ▶ Execute gestures clearly.
- ▶ The gestures can also be executed from the front-passenger side.

Possible gestures

Gesture	Operation	Function
	Move extended index finger forward and backward in the direction of the control display.	Accept call. Select a highlighted entry in a list during voice control. Confirm pop-up.
	Swipe the hand in front of the control display in the direction of the passenger seat.	Reject call. Close pop-up. End voice control.
	Move extended index finger slowly in a clockwise circular movement. Gesture is detected after one circular movement.	Increase the volume.
	Move the extended index finger counter-clockwise in a circular movement. Gesture is detected after one circular movement.	Reduce the volume.
Depending on the equipment: 	Bring thumb and index finger together and move the hand to the right or left.	Turn vehicle in the Live Vehicle view. 3D view: rotate camera view. This gesture can only be executed while the vehicle is stationary.
	Move fist with thumb extended to the left back and forth.	Reverse Skip function. The previous title is played.
	Move fist with thumb extended to the right back and forth.	Forward Skip function. The next title is played.

Gesture	Operation	Function
	With the index and middle fingers extended, point into the direction of the control display.	Perform individually assignable gesture.
	Stretch out five fingers, form a fist and stretch five fingers out again.	Perform individually assignable gesture.

Assigning gesture individually

General information

Two gestures can be assigned individually and can be configured as shortcut for certain functions such as:

- ▶ Destination guidance to home address.
- ▶ Mute/Playback
- ▶ Control display on/off

Gesture shortcuts can only be created with an active BMW ID or a driver profile.

Configure gesture shortcut

The desired function can be selected directly in every menu and configured as shortcut.

1. Press and hold the desired menu item.
2. "Add to gesture shortcuts"
3. Select the desired gesture.

Select function

Some defined functions can be selected directly in the menu for gesture control.

1.  Apps menu
2. "Vehicle"
3. "System settings"
4. "Gesture control"

5. "Point two fingers at display" or "Show five-to-five fingers"
6. Select the desired setting.

System limits

Gesture recognition by the camera in the headliner can be disturbed by the following circumstances:

- ▶ The camera lens is covered.
- ▶ Objects are located on the interior mirror.
- ▶ The camera lens is dirty, clean camera lens.

Sensors and camera lenses, refer to page 405.

- ▶ The gesture is executed outside of the detection range.
- ▶ Wearing of gloves or jewelry.
- ▶ Smoking in the car's interior.

Connecting mobile devices to the vehicle

Principle

Various connection types are available for using mobile devices in the vehicle. The connection type to select depends on the mobile device and the desired function.

General information

Detailed information on the functions and connection types can be found in the following media in the Owner's Manual under the specified keyword:

- ▶ Integrated Owner's Manual in the vehicle.
- ▶ Printed Owner's Manual for navigation, communication and entertainment.

The following information sources can also be used:

- ▶ Driver's Guide app.
- ▶ Driver's Guide Web.

Safety information







Warning



Operating the integrated information systems and communication devices while driving can distract from surrounding traffic. It is possible to lose control of the vehicle. There is a risk

of accident, injury, or property damage. Only use the systems or devices when the traffic situation allows. As warranted, stop and use the systems and devices while the vehicle is stationary.

Overview

The following overview shows possible functions and the suitable connection types for them. The range of functions depends on the vehicle equipment and the mobile device.

Function	Connection type	Icon on the control display
Making calls via the hands-free system. Using phone functions via iDrive. Keyword: calling via Bluetooth.	Bluetooth. Keyword: Bluetooth connection.	
Playing music from a mobile device. Keyword: audio.	Bluetooth audio. Keyword: Bluetooth connection.	
Calling without a mobile phone. Keyword: calling with the Personal eSIM.	Personal eSIM. Keyword: Personal eSIM.	 
Data exchange between mobile device and vehicle.	Wi-Fi. Keyword: vehicle WLAN.	
Use Internet access via the personal hotspot.	Wi-Fi via personal hotspot. Keyword: personal hotspot.	

Function	Connection type	Icon on the control display
Using Apple CarPlay via iDrive and via voice control. Keyword: Apple CarPlay preparation.	Bluetooth and Wi-Fi. Keyword: Bluetooth connection and vehicle Wi-Fi.	
Using Android Auto via iDrive and via voice control. Keyword: Android Auto preparation.	Bluetooth and Wi-Fi. Keyword: Bluetooth connection and vehicle Wi-Fi.	
Playing music from a USB device. Keyword: audio.	USB. Keyword: USB connection. Additional information: USB port, refer to page 307 .	

BMW Remote Software Upgrade

Vehicle features and options

This chapter describes model-specific equipment, systems, and functions that are currently available, or may become available in the future, even if they are not present in the vehicle.

Additional information:

Vehicle equipment, refer to page 8.

BMW Remote Software Upgrade

Principle

Remote Software Upgrade can be used to update the entire software of the vehicle. This makes new functions, functional enhancements or quality improvements available.

General information

BMW recommends performing the Remote Software Upgrade as soon as it becomes available.

Safety information

Warning

Unattended children or animals in the vehicle can cause the vehicle to move and endanger themselves and traffic, for example, due to the following actions:

- ▷ Establishing standby.
- ▷ Releasing the parking brake.
- ▷ Opening and closing the doors or windows.
- ▷ Engaging selector lever position N.
- ▷ Using vehicle equipment.

There is a risk of accident, injury, and property damage. Do not leave children or animals unattended in the vehicle. Take the vehicle key with you when exiting and lock the vehicle.

Functional requirements

- ▷ Active ConnectedDrive contract.
- ▷ The integrated SIM card in the vehicle has been activated.
- ▷ Cellular network reception.
- ▷ Consent to transmit the corresponding data was given in the Data Protection menu.

Additional information:

Data protection, refer to page 67.

Search for an upgrade

Functional requirement

Standby must be turned on to search for a Remote Software Upgrade.

Automatic search

The vehicle regularly searches for updates in the background.

Manual search

1.  Apps menu
2. "All apps"
3. "System settings"
4. "Remote Software Upgrade"
5. "Search for upgrades"
6. Follow the instructions on the control display.

Download of an upgrade

Automatic download

If available, the data for a Remote Software Upgrade is automatically downloaded to the vehicle. No download consent is required.

Via My BMW App

If an upgrade is available, information on the new software version is displayed in the My BMW App.

The data for the upgrade can then be downloaded to a mobile device, for instance via an existing WLAN connection.

Data can then be sent from the mobile device to the vehicle.

This transmission method accelerates the download of the data, for instance in areas with limited mobile network availability.

1. Download the upgrade using the My BMW App on your smartphone.
2. Follow the instructions in the My BMW App.
3. Connect your smartphone to the vehicle via Bluetooth audio and Wi-Fi.

Data for the upgrade is sent from the mobile device to the vehicle both while driving and when stopped. Depending on the size of the upgrade, it may be necessary to drive your vehicle to complete the data transfer.

4. Follow the instructions on the control display.

Additional information:

Connecting mobile devices to the vehicle, see Owner's Manual for Navigation, Entertainment, Communication.

Information about the version

General information



The information about the version contains a description of the updates included in the Remote Software Upgrade. During the download

and after the installation has been successfully completed, the information about the version can be displayed on the control display.

This information is also available in the ConnectedDrive customer portal.

Displaying information





Display in the vehicle:

1.  Apps menu
2. "All apps"
3. "System settings"
4. "Remote Software Upgrade"
5.  Display currently installed version: "Installed version:"
 -  Display new available version: "Info on version"
6. Follow the instructions on the control display.

Display in the ConnectedDrive customer portal: www.bmw-connecteddrive.com.

Installing the upgrade

General information

-  Installation of the Remote Software Upgrade may result in the deletion of software changes, e.g., performance increases not made by the manufacturer of the vehicle.
-  Modifications to the electrical system of the vehicle, for instance to control units, that have not been made by the vehicle manufacturer can lead to an interruption of the installation.
-  The installation does not occur until the consent was given.
-  The installation may take around 20 to 30 minutes.
-  The installation cannot be terminated.

- ▶ The vehicle cannot be used during the installation.
- ▶ The vehicle can be exited during the installation.

Prerequisites for the installation

- ▶ Sufficiently charged battery.
- ▶ The outside temperature is above 14 °F/-10 °C.
- ▶ The vehicle is parked in a horizontal position.
- ▶ The hazard warning system is turned off.
- ▶ The selector lever position P is engaged.
- ▶ The engine is turned off and sufficiently cooled down.

If applicable, follow the notes for further prerequisites on the control display.

Your vehicle can establish some prerequisites automatically. Follow the instructions on the control display.

If the prerequisites are not met such as a sufficiently charged battery, the upgrade will not be offered for installation.

Pay attention to an offer for installation, e.g., after longer trips.

Preparing the vehicle

- ▶ Park the vehicle safely away from the public road.
- ▶ Cellular network reception must be ensured so that a fault message can be sent to the vehicle manufacturer, for instance if the installation is terminated.
- ▶ Close the windows.
- ▶ Close the glass sunroof.
- ▶ Close the trunk.
- ▶ Remove energy consuming devices such as a mobile phone.
- ▶ Disconnect any trailer or load carrier.
- ▶ The vehicle key must be located in the vehicle for the consent for installation.

- ▶ Switch off the exterior lighting.
- ▶ Remove the devices connected to the diagnostic socket.

Installing immediately

The upgrade can be installed immediately if all prerequisites have been met.

1.  Apps menu
2. "All apps"
3. "System settings"
4. "Remote Software Upgrade"
5. "Start upgrade now"
6. Follow the instructions on the control display.

Installing with timer

When the trip is completed, a timer can be used to install the upgrade automatically at a configured time such as during the night. A later installation may make sense to meet functional requirements, e.g., a sufficiently cooled down engine.

1.  Apps menu
2. "All apps"
3. "System settings"
4. "Remote Software Upgrade"
5. Select the desired settings.

The installation starts automatically when:

- ▶ All prerequisites for the installation have been established correctly.
- ▶ All prerequisites continue to be met at the time of installation.

The timer is turned off when the drive-ready state is turned on.

Installing via the My BMW App

Once all preparations are complete and all requirements are met, the upgrade installation can also be started using the My BMW App



when the vehicle is parked. The upgrade installation can be started remotely.

Follow instructions in the My BMW App.

Functional limitations

During the upgrade, the majority of functions is temporarily unavailable, for instance:

- ▷ Hazard warning system.
- ▷ Central locking system and, if necessary, Comfort Access.
- ▷ Parking lights.
- ▷ Horn.
- ▷ Alarm system.
- ▷ Emergency call.
- ▷ Power windows.
- ▷ Glass sunroof.
- ▷ Checking the fuel filler flap lock.
- ▷ Operate the tailgate or trunk lid.

The driver's door can be locked and unlocked from the outside using the integrated key.

After successful upgrade

The vehicle can be used again immediately.

Booked services such as Advanced Real Time Traffic Information or Remote Services are automatically reactivated during the next trip.

After an extended stationary period, charge the vehicle battery with an extended drive.

Malfunction

In the event of a malfunction, follow the instructions on the control display or in the My BMW App.

If the malfunction cannot be corrected, contact an authorized service center or another qualified service center or repair shop.

Validity of the Owner's Manual

Production of the vehicle

At the time of production at the plant, the printed Owner's Manual is the most current resource.

After a software update in the vehicle

After a vehicle software update such as via Remote Software Upgrade the Integrated Owner's Manual for the vehicle will contain the latest information.

Personal settings

Vehicle features and options

This chapter describes model-specific equipment, systems, and functions that are currently available, or may become available in the future, even if they are not present in the vehicle.

Additional information:

Vehicle equipment, refer to page 8.

Data protection

Data transfer

Principle

The vehicle offers different services, whose use requires a data transfer to BMW or a service provider.

General information

The data transfer can be deactivated for some services. When the data transfer is deactivated, the respective service cannot be used.

Settings

The data transfer can be configured in different stages or individually for separate services.

1.  Apps menu
2. "Vehicle"
3. "System settings"
4. "Data privacy"
5. Select the desired setting.

Deleting personal data in the vehicle

Principle

Depending on the usage, the vehicle stores personal data such as stored radio stations.

This personal data can be permanently deleted using iDrive.

General information

Depending on the equipment, the following data is deleted:

- ▶ BMW IDs or driver profiles.
- ▶ Stored radio stations.
- ▶ Stored shortcuts.
- ▶ Navigation, for instance stored destinations.
- ▶ Phone book.
- ▶ Online data, e.g., favorites, cookies.
- ▶ Office data, for instance voice memos.
- ▶ Login accounts.
- ▶ Digital key.

Altogether, the deletion of the data can take up to 15 minutes. In addition, the vehicle is removed from the My BMW App and Connected-Drive customer portal so that remote functions can no longer be used.

Functional requirements

- ▶ Data can only be deleted while stationary.
- ▶ The vehicle key must be in the vehicle.

Deleting data

The personal data in the vehicle will be deleted when the vehicle is reset to the factory settings.

Additional information:

Resetting vehicle data, refer to page 67.

Reset vehicle data

All individual settings can be reset to the factory settings when the drive-ready state is

switched off. Data can only be deleted while the vehicle is stationary. The vehicle key must be in the vehicle.

1.  Apps menu
2. "Vehicle"
3. "System settings"
4. "Reset vehicle data"
5. "Reset vehicle data"

If the synchronization of settings has been enabled for a BMW ID in the vehicle, the personal settings are kept in the BMW Cloud.

BMW ID/driver profiles

Principle

In ConnectedDrive countries, the BMW ID is the personal login for all relevant offers for the BMW brand. The BMW ID can be used in the vehicle to store and activate personal vehicle settings.

In non-ConnectedDrive countries, the personal vehicle settings can be stored in driver profiles.

If a vehicle is used by several people, each person can use their own BMW ID in the vehicle. If a BMW ID is activated, the settings stored for it are applied to the vehicle.

General information

The BMW ID must be registered once. A BMW ID can be registered via the My BMW App, in the ConnectedDrive Portal, or through an authorized service center.

A driver profile is created in the vehicle.

Many of the settings that are stored for a BMW ID in the vehicle can be synchronized with the BMW Cloud. This makes these settings available in any vehicle where the same BMW ID is used to log in.

The vehicle can store three BMW IDs or three driver profiles.

With driver recognition, a BMW ID or driver profile can be activated as soon as you unlock your vehicle. For this, a vehicle key or digital key must be linked with the BMW ID or driver profile. After unlocking, you can change the BMW ID or driver profile.

If no BMW ID or driver profile is activated when the vehicle is unlocked, the vehicle loads the guest profile.

Functional requirements

The vehicle must be stationary to create, change, delete, or edit a BMW ID.

Logging in the vehicle with a BMW ID and synchronization with the BMW Cloud are only possible when the vehicle has cellular network reception.

Welcome window

After unlocking the vehicle, a Welcome window is shown on the control display. The type of the welcome depends on the following prerequisites:

- ▶ The vehicle does not have a stored BMW ID or driver profile:
The welcome is neutral. An option to add a BMW ID or create a driver profile is offered.
- ▶ The vehicle key or the digital key has not been assigned to a BMW ID or a driver profile:
The welcome is neutral. The stored BMW IDs or the stored driver profiles are offered for selection. Additionally, it is possible to add a new BMW ID or create a new driver profile.
- ▶ A BMW ID or driver profile has been assigned to the vehicle key or digital key:
The welcome is personalized, the stored settings are activated. The BMW ID or the driver profile can be changed.

As soon as the drive-ready state is turned on or the control display is tapped outside of the Welcome window, the welcome will be hidden.

Adding the BMW ID

1.  Tap the BMW ID icon or the personal image on the status bar.
2. "Add BMW ID"
3. Scan the displayed QR code with your smartphone.
4. Observe the instructions on your smartphone.
 - ▶ If you have installed the My BMW App on your smartphone and saved your BMW ID, the BMW ID is automatically transferred to the vehicle.
 - ▶ If you do not have a BMW ID yet, you a new BMW ID can be registered.
5. Select the other settings you want to change, e.g., to configure driver recognition as desired.
 - ▶ To configure driver recognition, the corresponding vehicle key or digital key must be detected in the vehicle.

Driver recognition can be set or changed in the settings at a later time.
6. Change any additional settings as necessary.

Alternatively, the BMW ID can be registered by an authorized service center and added to the vehicle. The BMW ID must then be confirmed on the control display in the corresponding vehicle.

The vehicle is added to the user's My BMW App.

Confirming a BMW ID

If the BMW ID was created by an authorized service center and added to the vehicle, you must then confirm the BMW ID in the vehicle:

1. Select the BMW ID.
2. Scan the QR code shown.
3. Follow the instructions on your smartphone.

My BMW app

If a BMW ID has been added to a vehicle, the vehicle is automatically added to the My BMW App. This means that My BMW App functions can be used for this vehicle. To do so, the My BMW App must be used with the same BMW ID.

Alternatively, an authorized service center can add a vehicle to the My BMW App. In this case, the BMW ID must then be confirmed on the control display in the corresponding vehicle.

In rare cases, the use of My BMW App functions for this vehicle may be restricted. More information is shown on the control display.

Creating a driver profile

In countries where BMW ConnectedDrive is not available, driver profiles can be created.

1.  Tap the icon or personal picture in the status bar.
2. "Add driver profile"
3. Enter the name for the driver profile.
4. Select the desired setting:
 - "Transfer settings"

If the vehicle is in the guest profile, the settings of the guest profile will be applied.

Primary user

The primary user is the person who first adds their BMW ID to the vehicle and first adds the vehicle to their My BMW App. Alternatively, the primary user can be defined by an authorized service center.

The primary user has access to the following settings, for example:

- ▶ Removing BMW IDs saved to the vehicle.
- ▶ Transferring the primary user role to another BMW ID.
- ▶ Change vehicle-wide data protection settings.
- ▶ Create the main digital key.



Additional information:

BMW Digital Key, refer to page 86.

Automatic driver recognition

If driver recognition has been established, automatic activation of the BMW ID or driver profile is triggered by the following actions:

- ▶ By unlocking the vehicle using the button on the assigned vehicle key.
- ▶ By unlocking the vehicle with a door handle. The assigned vehicle key or the assigned digital key must be carried with you.
- ▶ By automatic unlocking when approaching the vehicle. The assigned vehicle key or the assigned digital key must be carried with you. Depending on the country, it may not be possible to recognize the digital key.

If there are several vehicle keys or digital keys in the vicinity of the vehicle, activation of the BMW ID or driver profile is done according to the following priority:

- ▶ The key that unlocks the vehicle triggers the activation of the assigned BMW ID or the assigned driver profile.
The guest profile is activated when the vehicle is unlocked using a key that is not assigned to a BMW ID or driver profile.
- ▶ If a vehicle key and a digital key are detected at the same time, the digital key triggers the activation of the assigned BMW ID or the assigned driver profile.
- ▶ If another key is detected on the driver's door after activating the BMW ID or the driver profile, the BMW ID or the driver profile of the last key detected is activated.
If no BMW ID and no driver profile are assigned to this key, the guest profile is activated.

Setting synchronization

If synchronization is switched on, settings from the following areas, for example, are continuously synchronized:

- ▶ BMW ID, e.g., profile picture.
- ▶ Navigation, e.g., recent destinations, home address, or map settings.
- ▶ Media, e.g., favorites or saved radio stations.
- ▶ iDrive, e.g., main menu configuration, language, or units.
- ▶ Personal Assistant, e.g., suggestions or activation word.
- ▶ Exterior lighting, e.g., one-touch signaling and home lights.

Settings from the following areas are only synchronized when you log in for the first time:

- ▶ Seating and climate comfort, e.g., driver's seat position or temperature setting.
- ▶ Data protection menu.

Selecting the BMW ID/driver profile

If the BMW ID or driver profile could not be recognized when unlocking the vehicle, select the BMW ID or driver profile on the welcome window.

The BMW ID or driver profile can be changed at any time via iDrive:

1.  Tap the icon or personal picture in the status bar.
2. ▶ "Change BMW ID"
▶ "Change driver profile"
3. Select the BMW ID or driver profile.
4. If necessary, enter the PIN.

The BMW ID or the driver profile are activated, the stored settings are loaded.

Guest profile

The guest profile can be activated and changed by anyone.

In the following cases the guest profile is automatically active:

- ▷ A BMW ID has not yet been added or a driver profile has not yet been created.
- ▷ No BMW ID or driver profile has been assigned to the vehicle key or the digital key that was used to unlock the vehicle.



The following limitations apply to the guest profile:

- ▷ Certain functions are not available, e.g., navigation functions or saving favorites.
- ▷ The guest profile cannot be renamed.
- ▷ It is not possible to assign a PIN to the guest profile.
- ▷ It is not possible to assign driver detection to the guest profile.
- ▷ In ConnectedDrive countries, the synchronization with the BMW Cloud is not possible.

The guest profile is selected on the Welcome screen or via iDrive:

1.  Tap the icon or personal picture in the status bar.
2. ▷ "Change BMW ID"
 - ▷ "Change driver profile"
3. "Continue as guest"

Deleting the BMW ID/driver profile

1.  Tap the icon or personal picture in the status bar.
2. ▷ "Manage BMW IDs"
 - ▷ "Change driver profile"
3.  Tap the icon of the desired BMW ID or the desired driver profile.

Removing a BMW ID from the vehicle causes the vehicle to be removed from the My BMW App. If the BMW ID has been synchronized with the BMW Cloud, the data stored in the BMW Cloud is retained after the BMW ID is deleted. If the currently active BMW ID is removed, the guest profile is activated.

Removing a vehicle from the My BMW App removes the corresponding BMW ID from the vehicle. If the BMW ID was synchronized with

the BMW Cloud, the BMW ID data stored in the BMW Cloud will be retained.

If the vehicle is removed from the primary user's My BMW App, it will also be removed from the My BMW App of the other users. The corresponding BMW IDs are removed from the vehicle.

If the vehicle is reset to factory settings, it is removed from each user's My BMW App, and all BMW IDs are removed from the vehicle.

Transfer of the vehicle key

A vehicle key that is assigned to a BMW ID or a driver profile can be used to view or change the stored personal settings.

Before a vehicle key is transferred to other persons, any assigned driver detection should be canceled. Changes to the driver detection can be made in the settings of the BMW ID or the driver profile.

The BMW Digital Key provides the option to transfer a digital key to permit other persons the use of your own vehicle.

Additional information:

BMW Digital Key, refer to page [86](#).

Settings

General information

Settings added when adding a BMW ID or creating a driver profile can be changed.

1.  Tap the icon or personal picture in the status bar.
2. "Settings"

The following settings are available for the BMW ID:

- ▷ The type of driver detection.
- ▷ The profile picture.
- ▷ The synchronization with the BMW Cloud.
- ▷ The personal salutation.

The following settings are available for the driver profile:

- ▷ The type of driver detection.
- ▷ The profile picture.
- ▷ The profile name.

Selecting a profile picture

The profile picture can be selected from the predefined profile pictures:

1.  Tap the icon or personal picture in the status bar.
2. "Settings"
3. "Manage profile picture"
4. "Select profile picture"

The personal profile picture for a BMW ID can be adopted from the profile in the My BMW App. This requires that the synchronization with the BMW Cloud is activated in the settings. After transferring the profile picture from the My BMW App, you can only select one of the predefined images if the profile picture in the My BMW App is deleted or synchronization is deactivated.

System limits

A clear driver detection via the vehicle key or the digital key may not always be possible in the following cases, for example:

- ▷ The driver changes, but the vehicle is not locked and unlocked.
- ▷ When multiple vehicle keys or multiple digital keys with an assigned BMW ID or driver profile are located in the outer area on the driver's side of the vehicle.
- ▷ When the vehicle was unlocked via the My BMW App.

The use of personal settings that are stored for a BMW ID in other vehicles is subject to technical limitations. For example, settings may be stored for a system that is not available, or available in a non-compatible version, in other vehicles.

Opening and closing

Vehicle features and options

This chapter describes model-specific equipment, systems, and functions that are currently available, or may become available in the future, even if they are not present in the vehicle.

Additional information:

Vehicle equipment, refer to page 8.

Vehicle key

General information

Two vehicle keys are included in the scope of delivery, each containing an integrated key.

Each vehicle key contains a replaceable battery.

Depending on the equipment and national-market version, various settings are possible for the button functions.

A BMW ID or a driver profile with personal settings can be assigned to a vehicle key.

To provide information on maintenance recommendations, the service data is stored in the vehicle key.

To prevent possible locking in of the vehicle key, take the vehicle key with you when exiting the vehicle.

Safety information

Warning

The vehicle key has a button cell battery. Batteries or button cell batteries can be swallowed and lead to serious or fatal injuries within two hours, for example due to internal burns or chemical burns. There is a risk of injury or danger to life. Keep the vehicle key and batteries out of reach of children. Imme-

diately seek medical help if there is any suspicion that a battery or button cell battery has been swallowed or is located in any part of the body.

Overview



Buttons on the vehicle key.

Icon	Meaning
	Unlock.
	Lock. Stationary climate control, refer to page 301.
	Open the cargo area.
	Panic mode. Pathway lighting, refer to page 171.

Additional vehicle keys

Additional vehicle keys are available from an authorized service center or another qualified service center or repair shop.

Loss of vehicle keys

A lost vehicle key can be disabled and replaced by an authorized service center or another qualified service center or repair shop.

If the lost vehicle key has an assigned BMW ID or driver profile, the connection to this vehicle key must be deleted. A new vehicle key can then be assigned to the BMW ID or driver profile.

Replacing the battery

NOTICE

Improper batteries in a battery-operated device can damage the device. There is a risk of property damage. Always replace the discharged battery with a battery with the same voltage, the same size and the same specification.

1. Press and hold the button, arrow 1, and push the cover, arrow 2, forward and remove it from the side.



2. Remove the battery housing from the vehicle key to the side.

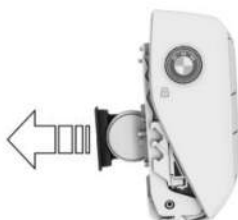

3. Remove the battery from the battery housing.



4. Insert a CR2032 3V battery with the positive side facing down.
5. Insert the battery housing into the vehicle key.

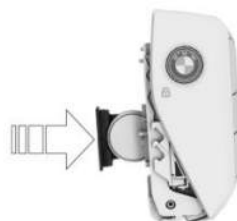

6. Insert the cover into the vehicle key.

 Have old batteries disposed of by an authorized service center or another qualified service center or repair shop, or take them to a collection point.

Integrated key

General information

The vehicle can be locked and unlocked manually using the integrated key.

Depending on the national-market version, the integrated key will fit in the glove compartment.

Safety information

Warning

For some national-market versions, unlocking from the inside is only possible with particular knowledge.

If persons or animals spend a lengthy time in the vehicle and are thereby exposed to extreme temperatures, there is a risk of injury or danger to life. Do not lock the vehicle from the outside when there are people or animals in it. Do not leave babies, toddlers or animals alone in the vehicle.

Removing the integrated key

1. Press and hold the button, arrow 1, and push the cover, arrow 2, forward and remove it from the side.



2. Slide out the integrated key at the open side of the vehicle key.



3. Remove the integrated key from the vehicle key.

Unlocking the vehicle manually

1. Pull and hold the driver's door handle outward with one hand.

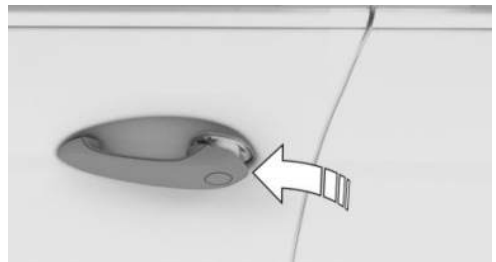

2. Guide one finger of your other hand from the back under the cover cap and push the cover cap out.

Use the thumb for counter support to prevent the cover cap from falling out of the door handle.



3. Remove the cover cap.
4. Unlock the door lock with the integrated key by turning it counterclockwise.



5. Open the driver's door.
6. Press the central locking button to unlock the other doors.

With the vehicle de-energized: pull the door opener of the other doors from the inside.

Locking the vehicle manually

General information

To avoid locking the vehicle key in the vehicle, do not place the vehicle key in the vehicle.

Overview

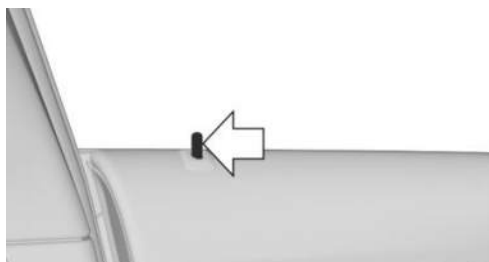

Lock button for manual locking of the doors.

Locking the vehicle

1. Close all doors.
2. Enter the vehicle on the front passenger's side and close the front passenger door.
3. Press the central locking button to unlock all doors.
If vehicle is de-energized: Press down the lock buttons on all doors except the front passenger door.
4. Exit the vehicle through the front passenger door.
5. Press down the lock button on the front passenger door and close the front passenger door.
6. Pull the door handles to make sure they are locked. If necessary, repeat the process.

Alarm system

If the vehicle is unlocked with the integrated key via the door lock, the activated alarm system will be triggered when the door is opened.

In this case, use the vehicle key emergency detection to switch off the alarm.

If the vehicle is locked with the integrated key via the door lock, the alarm system will not be activated.

Emergency detection of the vehicle key

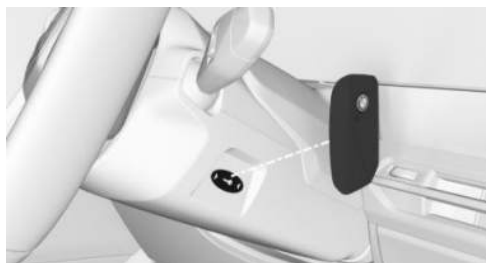

It is not possible to switch on the drive-ready state if the vehicle key has not been detected. Proceed as follows in this case:

1. Hold the rear of the vehicle key against the mark on the steering column. Pay attention to the display in the instrument cluster.
2. ▶ If the vehicle key is detected:
Turn on drive-ready state within 10 seconds.
- ▶ If the vehicle key is not detected:
Slightly change the position of the vehicle key and repeat the procedure.

Malfunction

A Check Control message is displayed where applicable.

Vehicle key detection by the vehicle may malfunction under the following circumstances:

- ▶ The battery of the vehicle key is discharged.
- ▶ Fault of the radio link from transmission towers or other equipment with high transmitting power.
- ▶ Shielding of the vehicle key due to metal objects.

Do not transport the vehicle key together with metal objects.

- ▷ Fault of the radio link from mobile phones or other electronic devices in direct proximity to the vehicle key.

Do not carry the vehicle key in close proximity to other electronic devices.

- ▷ Fault of radio transmission by a charging process of mobile devices, for instance charging of a mobile phone.
- ▷ The vehicle key is located in direct proximity of the wireless charging tray.

Place the vehicle key in a different location.

In the case of interference, the vehicle can also be unlocked and locked from the outside with the integrated key. Use the Emergency detection of the vehicle key to turn on drive-ready state.

Access to vehicle interior

Safety information

Warning

People or animals in the vehicle can lock the doors from the inside and lock themselves in. In this case, the vehicle cannot be opened from the outside. There is a risk of injury. Take the vehicle key with you so that the vehicle can be opened from the outside.

Warning

For some national-market versions, unlocking from the inside is only possible with particular knowledge.

If persons or animals spend a lengthy time in the vehicle and are thereby exposed to extreme temperatures, there is a risk of injury or danger to life. Do not lock the vehicle from the outside when there are people or animals

in it. Do not leave babies, toddlers or animals alone in the vehicle.

Warning

Unattended children or animals in the vehicle can cause the vehicle to move and endanger themselves and traffic, for example, due to the following actions:

- ▷ Establishing standby.
- ▷ Releasing the parking brake.
- ▷ Opening and closing the doors or windows.
- ▷ Engaging selector lever position N.
- ▷ Using vehicle equipment.

There is a risk of accident, injury, and property damage. Do not leave children or animals unattended in the vehicle. Take the vehicle key with you when exiting and lock the vehicle.

Actions during unlocking

Depending on the settings, the following functions are performed when unlocking the vehicle:

- ▷ Only the driver's door and the fuel filler flap will be unlocked or all access to the vehicle will be unlocked.
- ▷ The unlocking of the vehicle can be confirmed with a light signal or a sound signal.
- ▷ The welcome light can be turned on when the vehicle is being unlocked.

In addition, the following functions are executed:

- ▷ If a BMW ID or a driver profile was assigned to the vehicle key, this BMW ID or driver profile will be activated.
- ▷ The interior lights are switched on, unless they were manually switched off.
- ▷ Depending on vehicle equipment, folded-in exterior mirrors are folded out.

If the exterior mirrors were folded in using the button inside the vehicle, they will not fold out when the vehicle is unlocked.

- ▷ Anti-theft protection is switched off.
- ▷ The alarm system is switched off.

Additional information:

- ▷ Settings, refer to page 91.
- ▷ Welcome lights, refer to page 170.
- ▷ BMW ID/driver profiles, refer to page 68.

Actions during locking

Depending on the settings, the following functions are performed when locking the vehicle:

- ▷ The locking of the vehicle can be confirmed with a light signal or a sound signal.
- ▷ Depending on vehicle equipment, the exterior mirrors can be folded in automatically when locking. The exterior mirrors are not folded in when the hazard warning flashers are switched on.

The following functions are executed:

- ▷ All doors, the cargo area, and the fuel filler flap are locked.
- ▷ Anti-theft protection is switched on. This prevents the doors from being unlocked using the lock buttons or the door openers.
- ▷ The alarm system is switched on.

If the drive-ready state is still turned on when you lock the vehicle, the vehicle horn will honk twice. In this case, drive-ready state must be turned off using the Start/Stop button.

Additional information:

Settings, refer to page 91.

With the vehicle key

Unlocking the vehicle



Press the button on the vehicle key.

If only the driver's door and fuel filler flap have been unlocked due to the settings in place, press the button on the vehicle key again to unlock the other vehicle access points.

The lighting functions may depend on the ambient brightness.

Locking the vehicle

1. Close the driver's door.



2. Press the button on the vehicle key.

All vehicle access points are locked.

On the door handle

Principle

The vehicle can be accessed without operating the vehicle key.

The vehicle key is automatically detected near the vehicle.

General information

The function is available with Comfort Access.

Depending on national-market version, the vehicle can also be unlocked and locked via the door handle using a compatible smartphone and digital key.

Additional information:

BMW Digital Key, refer to page 86.

Functional requirements

- ▷ Carry the vehicle key with you, e.g., in your pants pocket.
- ▷ Bluetooth must be activated on the smartphone to unlock and lock using the digital key.
- ▷ To lock the vehicle, the vehicle key must be outside of the vehicle near the doors.
- ▷ After locking, approx. 2 seconds must elapse before unlocking is possible.

Unlock vehicle

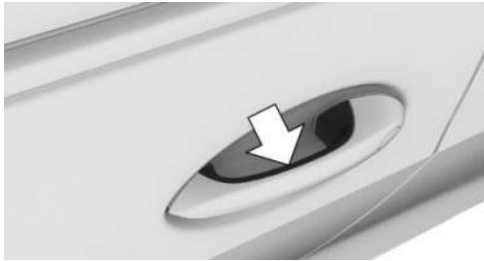

Fully grasp the handle of a front door.

Locking the vehicle

1. Close the driver's door.
2. With your finger, touch the grooved surface on a closed front door handle for approx. 1 second without gripping the door handle.

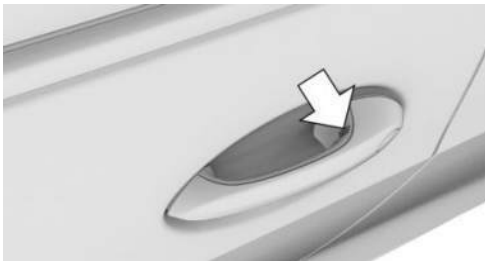

Malfunction

Wet or snowy conditions may disrupt the locking request detection on the door handles.

In the case of a malfunction, unlock and lock the vehicle using the buttons of the vehicle key or use the integrated key.

Touchless unlocking/locking of the vehicle

Principle

When the driver approaches the locked vehicle with the vehicle key, the vehicle is unlocked.

When the driver walks away from the unlocked vehicle with the vehicle key, the vehicle will be locked.

General information

The function is available with Comfort Access.

The vehicle will be unlocked when an authorized vehicle key is detected in the unlocking zone.

The unlocking zone is located within a radius of approx. 5 ft/1.50 m around the vehicle.

The vehicle will be locked when the vehicle key leaves the locking zone.

The locking zone is located within a radius of approx. 9 ft/2.7 m around the vehicle.

Depending on the national-market version, touchless unlocking and locking is also possible for compatible smartphones with a digital key. Enable Bluetooth on your smartphone to do so.

If the vehicle key is located in the unlocking zone for an extended period of time without movement, the vehicle will be locked automatically.

If someone is detected on a seat while locking the vehicle, the following restrictions apply:

- ▶ The vehicle will be locked but not secured against theft.
- ▶ The fuel filler flap remains unlocked.

Additional information:

BMW Digital Key, refer to page [86](#).

Actions during unlocking

If the settings specify that only the driver's door and the fuel filler flap will be unlocked, note the following:

The driver's door and fuel filler flap will only unlock when the driver is within the driver's door unlocking zone.

Settings, refer to page [91](#).

Functional requirements

- ▶ Carry the vehicle key with you, e.g., in your pants pocket.
- ▶ Automatic unlocking and locking must be activated in the settings.
- ▶ The drive-ready state must be turned off.
- ▶ If the vehicle has been in the idle state for several days, contactless unlocking/locking will only be available after the vehicle has been driven.

Additional information:

Settings, refer to page 91.

With the Key Card

Principle

The Key Card is a chip card on which the digital key is installed. The Key Card can be used to unlock and lock the vehicle.

Additional information:

Key Card, refer to page 85.

General information

The Key Card is available with Comfort Access.

Locking/unlocking the vehicle

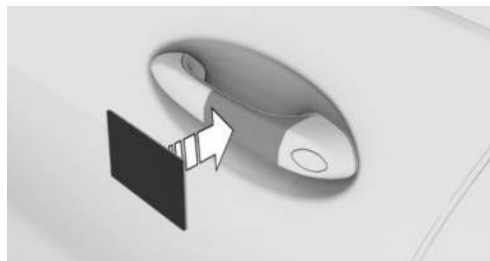

Hold the activated Key Card directly at the center of the driver's door handle.

When locking the vehicle with the Key Card, make sure that all doors and the cargo area are closed.

If the Key Card is not detected, slightly change the position of the Key Card and repeat the procedure.

With the BMW Digital Key

Principle

Depending on vehicle equipment and national-market version, a digital key can be installed on a compatible smartphone and used to unlock and lock the vehicle.

Additional information:

BMW Digital Key, refer to page 86.

Locking/unlocking the vehicle

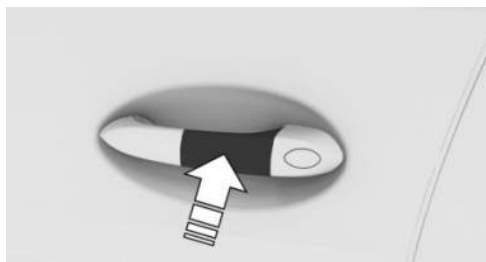

Hold the smartphone NFC antenna directly at the center of the driver's door handle. The position of the near field communication antenna depends on the smartphone model.

When locking the vehicle with the smartphone, make sure that all doors and the cargo area are closed.

Frequently Asked Questions

What precautions can be taken to be able to open a vehicle, despite accidentally locking in the vehicle key?

- ▶ The app's remote services offer the option to lock and unlock a vehicle.

This requires an active BMW ConnectedDrive contract, and the app must be installed on a smartphone.

- ▶ Unlocking the vehicle can be requested via the BMW ConnectedDrive Call Center.

An active BMW ConnectedDrive contract is required.

Access to the cargo area

General information

The cargo area will be opened to the configured opening height.

The tailgate consists of the upper and the lower tailgate. The lower tailgate opens downward to make loading the cargo area easier.

The opened lower tailgate can be loaded with up to 250 kg.

Safety information

Warning

Body parts can be jammed when operating the tailgate. There is a risk of injury. Make sure that the travel path of the tailgate is clear during opening and closing.

Warning

The tailgate swings back and up when it opens. There is a risk of injury or risk of damage to property. Make sure that the travel path of the tailgate is clear during opening and closing.

NOTICE

Foreign objects such as sand or icing between the bumper and tailgate may cause damage when operating the lower tailgate. There is a risk of property damage. If neces-

sary, remove foreign objects from the bumper and the lower tailgate before operating the lower tailgate.

Warning

Sharp-edged or pointed objects can hit the windows and heating elements while driving. There is a risk of injury or risk of property damage. Cover the edges and ensure that pointed objects do not hit the windows.

NOTICE

Manual operation of the tailgate in the wrong sequence can damage the tailgate. There is a risk of property damage. Close the lower tailgate first before closing the upper tailgate manually.

With the vehicle key

General information

To avoid locking the vehicle key in the vehicle, do not place the vehicle key in the cargo area.

Depending on vehicle equipment and national-market version, the following settings can be changed:

- ▶ Unlocking the cargo area with the vehicle key also unlocks the doors.
- ▶ Before unlocking the cargo area with the vehicle key, first unlock the vehicle.
- ▶ Only the upper tailgate can be opened, or the upper and lower tailgates together, using the vehicle key.
- ▶  The tailgate can be operated using the button on the vehicle key.

Functional requirements

To open the cargo area with the vehicle key, the trailer power socket must not be occupied.

Selector lever position P must be engaged to open the cargo area with the vehicle key.

You must enable the setting for opening with the vehicle key.

Additional information:

Settings, refer to page 91.

Opening the cargo area

▶  Press and hold the button on the vehicle key for approx. 1 second.

▶  Press and hold the button on the vehicle key for approx. 1 second.

If necessary, the lower tailgate will also open.

On the cargo area

General information

With Comfort Access, the cargo area can be accessed without activating the vehicle key.

The key is automatically detected near the vehicle.

Depending on the national-market version, compatible smartphones with a digital key are also detected automatically. In this case, the cargo area can be opened with a smartphone.

Additional information:

BMW Digital Key, refer to page 86.

Functional prerequisites

▶ Carry the vehicle key with you, e.g., in your pants pocket.

▶ Bluetooth must be activated on the smartphone to detect the digital key.

Opening the upper tailgate

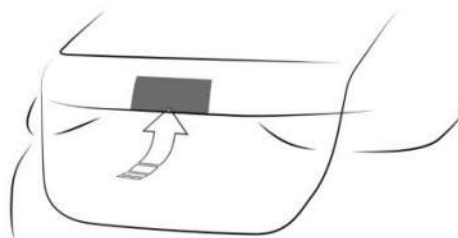

▶ Unlock the vehicle and then press the button on the cargo area.

▶ With Comfort Access: carry the vehicle key with you and press the button on the cargo area.

Locked doors are not unlocked.

Opening the lower tailgate

The upper tailgate must be open.

▶  Press the button on the lower tailgate.

Closing the upper tailgate

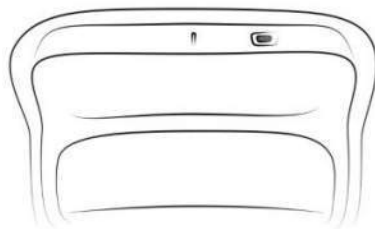

▶  Press the button on the inside of the upper tailgate.

▶  Press the button on the inside of the upper tailgate.

The vehicle is locked after closing the cargo area. To do so, the driver's door must be closed and the vehicle key must be outside of the vehicle near the cargo area.

The lower tailgate will be closed automatically with the upper tailgate.

Closing the lower tailgate

Make sure that there is no cargo on the lower tailgate.



Press the button on the lower tailgate.

Inside the vehicle

Functional prerequisites

To open the trunk using the button inside the vehicle, the trailer power socket must not be occupied.

The vehicle key or digital key must be located within the vehicle in order to close the trunk using the button inside the vehicle.

When the vehicle is locked, selector lever position P must be engaged before the trunk lid can be opened using the button inside the vehicle.

Opening the trunk



Press the button in the driver's door.

If necessary, the lower tailgate will also open.

Closing the cargo area



Pull and hold the button in the driver's door.

The lower tailgate will be closed automatically with the upper tailgate.

An acoustic signal sounds before the trunk is closed.

Interruption of the opening procedure

The opening procedure is interrupted in the following situations:

- ▷ When the vehicle starts moving.
- ▷ By pressing the button on the outside of the cargo area. Pressing it again closes the cargo area again.
- ▷ By pressing the button on the inside of the cargo area. Pressing it again closes the cargo area again.
- ▷ By pressing the button on the vehicle key. Pressing the button again continues the opening process.
- ▷ By pressing or pulling the button in the driver's door. Pressing again continues the opening procedure.

Interruption of the closing procedure

The closing procedure is interrupted in the following situations:

- ▷ If the vehicle drives off with a jerky movement.
- ▷ By pressing the button on the outside of the cargo area. Pressing it again opens the cargo area again.
- ▷ By pressing the button on the inside of the cargo area. Pressing it again opens the cargo area again.
- ▷ By pressing the button on the vehicle key. Pressing it again opens the cargo area again.
- ▷ By releasing the button in the driver's door. Pulling again and holding continues the closing motion.

Opening and closing the cargo area contactlessly

Principle

You can open the cargo area contactlessly when carrying the vehicle key on your person. With automatic tailgate activation, the cargo area can also be closed contactlessly.

Sensors detect specific foot movements near the center of the rear area, and the cargo area opens or closes.

General information

Function availability depends on vehicle equipment and national-market version.

If the vehicle key is within the sensor range, the cargo area may open or close inadvertently if you unintentionally move your foot or if a foot movement is detected.

The sensor has an approximate range of 5 ft/1.50 m extending from the rear area.

If contactless opening is used for the cargo area, the locked doors will not be unlocked.

Additional information:

BMW Digital Key, refer to page 86.

Safety information

Warning

With hands-free opening of the cargo area, there may be unintentional contact with vehicle parts, e.g., hot exhaust system. There is a risk of injury. When moving your foot, make sure you have a firm stance and do not touch the vehicle.

Functional requirements

- ▶ To close the cargo area contactlessly, the automatic tailgate must be installed.
- ▶ Selector lever position P must be engaged.
- ▶ Contactless opening and closing of the trunk must be activated in the settings.
- ▶ Bluetooth must be activated on the smartphone to open and close the cargo area contactlessly using the Digital Key.

Depending on vehicle equipment:

- ▶ No trailer hitches should be mounted.

Additional information:

Settings, refer to page 91.

Opening the cargo area

1. Stand in the middle behind the vehicle at approx. one arm's length away from the rear of the vehicle.
2. Wave a foot under the vehicle in the driving direction and immediately pull it back. With these movements, the leg must pass through the ranges of both sensors.



Before the cargo area opens, the hazard warning system flashes.

Moving a foot again will stop the opening procedure. The subsequent foot movement will close the cargo area again.

Closing the cargo area

Perform the foot movement for opening the cargo area.

The hazard warning system flashes and an acoustic signal sounds.

Moving a foot again will stop the closing process. The subsequent foot movement will open the cargo area again.

System limits

The detection of the foot movement may be limited due to the following external conditions:

- ▶ Ice, snow or slush on the rear of the vehicle.
- ▶ Dirt or road salt on the rear of the vehicle.

Movement in range of the sensors may cause the cargo area to open unintentionally, e.g., due to running water when cleaning the vehicle or from heavy rainfall, or due to the moving brushes in a car wash. To prevent such

unintended opening of the cargo area in such cases, keep the vehicle key at a sufficient distance from the rear of the vehicle.

Depending on vehicle equipment: Objects mounted on a trailer hitch cannot be detected if the trailer power socket is not plugged in.

Malfunction

Warning

With manual operation of a blocked tailgate, it can release itself unexpectedly from the blocking. There is a risk of injury or risk of damage to property. Do not operate the tailgate manually if it is blocked. Have the vehicle checked by an authorized service center or another qualified service center or repair shop.

In the event of an electrical malfunction in the automatic tailgate, operate the unlocked tailgate slowly with a smooth motion by hand.

To close the tailgate fully, press down lightly only. Closing occurs automatically.

Key Card

Principle

The Key Card allows the vehicle to be unlocked and locked, as well as started.

General information

Key Card availability depends on vehicle equipment and national-market version.

A digital key that has already been paired with the vehicle is installed on the Key Card. The digital key must be activated via iDrive.

Before leaving the vehicle, deactivate the Key Card or take the Key Card with you because the active Key Card can be used to start the vehicle. Always take the vehicle key with you to a service appointment.

Safety information

NOTICE

If the Key Card and a mobile device are in the wireless charging tray at the same time, the Key Card could become damaged. There is a risk of property damage. Do not place the Key Card in the wireless charging tray at the same time as a mobile device.

Activating/deactivating Key Card in the vehicle

General information

When the BMW Digital Key is activated for the vehicle, a digital key can be used instead of the vehicle key.

A deactivated Key Card remains in the list of paired digital keys.

Functional requirement

A vehicle key must be located in the vehicle to activate and deactivate the Key Card.

Activating Key Card

Tray with thermoelectric cooling and heating system for a cup holder:



Tray without thermoelectric cooling and heating system for a cup holder:



1. Open the cover of the smartphone tray.
2. Place Key Card in the center of the smartphone tray.
3. Follow instructions on the control display.

Deactivating Key Card

1. Apps menu
2. "Vehicle"
3. "Doors and windows"
4. "Digital Key"
5. "Key Card"
6. "Deactivate Key Card"

A deactivated Key Card remains in the list of paired digital keys.

Unlocking and locking the vehicle

The vehicle can be unlocked and locked with the activated Key Card.

Additional information:

Access to the vehicle interior, refer to page 77.

Turning on the drive-ready state

Tray with thermoelectric cooling and heating system for a cup holder:



Tray without thermoelectric cooling and heating system for a cup holder:



1. Open the cover of the smartphone tray.
2. Place activated Key Card in the center of the smartphone tray.

3. Press the Start/Stop button.

After drive-ready state is switched on, the Key Card can be removed from the tray.

Malfunction

The vehicle may not be able to detect the Key Card if there are objects between the smartphone tray and the Key Card, e.g., a wallet or smartphone case.

BMW Digital Key

Principle

BMW Digital Key lets you lock and unlock and start your vehicle using a digital key.

General information

BMW Digital Key availability and functionality depend on vehicle equipment and national-market version.

BMW Digital Key can be used with a compatible smartphone or other compatible mobile devices.

To unlock and start a vehicle with a compatible smartphone, this function must be offered by the smartphone manufacturer. The My BMW app can be used to check if the smartphone and vehicle are compatible and which functions are supported.

A BMW ID or a driver profile with individual settings can be assigned to a digital key.

When using a smartphone as a digital key, it is helpful to carry the deactivated Key Card in the vehicle. In situations where the vehicle is to be given to another person, they can be given the Key Card instead of the smartphone. To do so, the Key Card must be activated via iDrive.

Always take the vehicle key with you to a service appointment.

Additional information:

- ▶ BMW ID/driver profiles, refer to page 68.
- ▶ Key Card, refer to page 85.
- ▶ www.bmw.com/digitalkey

Functional requirements

- ▶ The smartphone is compatible with BMW Digital Key
- ▶ The vehicle is linked with the ConnectedDrive account of the vehicle owner.
- ▶ The rechargeable battery of the smartphone has a sufficient charge. The necessary minimum charge of the rechargeable battery depends on the smartphone.
- ▶ Bluetooth must be activated on the smartphone for contactless unlocking and locking using the digital key.

Enabling the main digital key

Vehicle owner's smartphone is enabled as a main digital key in the vehicle. The vehicle owner must prove his authorization for the vehicle for this purpose.

Proof of authorization can be started via the My BMW App or using the activation code in the corresponding smartphone function, e.g., the Wallet app.

Both vehicle keys must be located in the vehicle to be enabled.

Follow the activation instructions in the Digital Key menu, on the app, or on the control display.

Sharing digital keys

General information

Digital Key allows the sharing of digital keys with other people. This option is available via the smartphone that is enabled as main digital key. This function must be supported by the smartphone.

Forwarding authorization

To share the digital key, select the corresponding function on the smartphone, for instance in the Wallet app.

As soon as a digital key is shared with another person, the person will receive an invitation. When the invitation is accepted, the digital key on the recipient's smartphone will be activated.

Limiting the range of functions

Certain functions of the digital key can be limited before handing it over. For instance, if the digital key is passed on to a novice driver, the switch-off for driving stability control systems can be disabled and the engine power can be reduced. For more information, refer to the ConnectedDrive Portal and My BMW app.

Authentication

Depending on the recipient's smartphone model, an authentication may be required for security and safety reasons.

An authorized vehicle key, the main digital key or another method may be used for authentication. Follow the corresponding instructions on the smartphone or the control display.

Deleting digital keys

General information

Deleted digital keys will be removed from the list of enabled digital keys.

Deleted digital keys cannot be restored.

Deleting the main digital key

The main digital key can be deleted from the smartphone or via iDrive.

The deletion of the main digital key is completed immediately.

Deleting a shared key

Shared keys can be deleted using the smartphone with the master Digital Key, using the smartphone with the shared key to be deleted, or via iDrive.

The deletion via the smartphone using the main digital key will not be performed until the vehicle is used with a key other than the key to be deleted.

If the smartphone associated with a shared key or iDrive is used to delete a shared key, it will be deleted immediately.

Deletion via iDrive

To delete a digital key via iDrive, there must be an authorized vehicle key in the vehicle, or the master Digital Key must be in the smartphone tray.

1.  Apps menu
2. "Vehicle"

3. "Doors and windows"
4. "Digital Key"
5. If necessary, select the digital key.
6. Delete the Digital Key.

Resetting the function

To reset the BMW Digital Key function, an authorized vehicle key must be located in the vehicle.

When resetting the BMW Digital Key function, all digital keys including the main digital key will be deleted. The Key Card's digital key is retained and deactivated.

After the reset, the vehicle can no longer be unlocked, locked or started with a digital key.

The main digital key must be enabled again to be able to use BMW Digital Key again.

1.  Apps menu
2. "Vehicle"
3. "Doors and windows"
4. "Digital Key"
5. "Reset function"

Unlocking and locking the vehicle

The vehicle can be unlocked and locked as follows:

- ▷ Using the door handle.
- ▷ With Comfort Access: depending on the national-market version, the vehicle can be locked and unlocked with no-touch activation.

BMW Digital Key availability and functionality depend on vehicle equipment and national-market version.

Additional information:

Access to the vehicle interior, refer to page [77](#).

Turning on the drive-ready state

Using the smartphone tray

Tray with thermoelectric cooling and heating system for a cup holder:

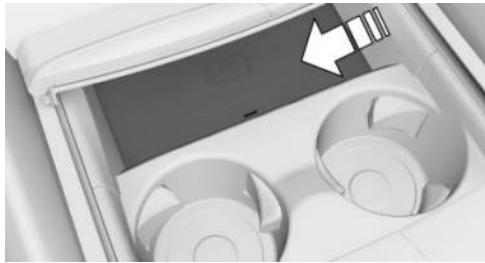

Tray without thermoelectric cooling and heating system for a cup holder:



1. Open the cover of the smartphone tray.
2. Place smartphone in the center of the smartphone tray.
Ensure that the display is facing up.
3. Close the cover of the smartphone tray.
4. Press the Start/Stop button to turn on drive-ready state.

Inside the vehicle

With Comfort Access, it is sufficient, depending on the country, for the smartphone with Bluetooth enabled to be located inside the vehicle. Press the Start/Stop button to turn on drive-ready state.

Sale of the smartphone

Delete all digital keys on the smartphone prior to selling the smartphone. This ensures that the smartphone can no longer be used for the vehicle.

Changing smartphones

To use a new smartphone as a master Digital Key, activate the new smartphone according to the instructions for the master Digital Key. The previous master key is deleted when the new smartphone is activated.

Sale of the vehicle

Prior to selling a vehicle, reset the Digital Key function or remove the vehicle from the ConnectedDrive account of the current vehicle owner.

When the vehicle is removed from the ConnectedDrive account, all digital keys for the vehicle will be deleted. The Key Card's digital key is retained and deactivated.

System limits

The interior motion sensor and tilt alarm sensor of the alarm system cannot be switched off with a digital key.

Additional information:

Alarm system, refer to page [93](#).

Malfunction

Digital key recognition by the vehicle may malfunction under the following circumstances:

- ▶ The smartphone is shielded from the sensors in the vehicle by a smartphone cover that is not suitable.
- ▶ Objects such as a chip card or the Key Card are located between the smartphone and the smartphone cover.

- ▶ Fault of the connection from transmission towers or other equipment with high transmitting power.
- ▶ Shielding of the smartphone due to buildings or metal objects.

Buttons for the central locking system

General information

The vehicle is automatically locked when driving off.

In the event of a severe accident, the vehicle is automatically unlocked. The hazard warning system and interior lights are illuminated.

Overview

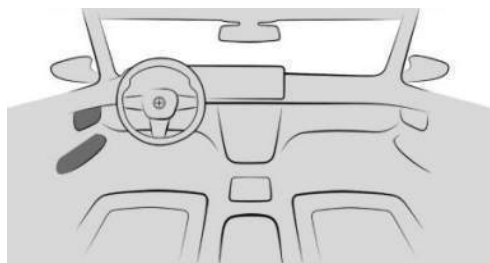

The central locking buttons are located on the front door.

Locking the vehicle



Press the button in the driver's door or front passengers door with the front doors closed.

The fuel filler flap remains unlocked.

The vehicle is not secured against theft when locking.

Unlocking the vehicle



Press the button in the driver's door or front passenger's door.

Opening the door

- ▶  Press the button to unlock all the doors.
Pull the door opener above the armrest.
- ▶ Front doors: pull the door opener on the door to open the door. The other doors remain locked.
- ▶ Back doors: pull twice on the door opener on the door to be opened; the first time unlocks the door, the second time opens it. The other doors remain locked.

Soft-close automatic function

Principle

The soft-close automatic function reduces effort and noise when closing vehicle doors.

The door can be pushed into the door lock without effort and the door will close automatically.

Safety information

Warning

Body parts can be jammed while operating the doors. There is a risk of injury. Make sure that the area of movement of the doors is clear while opening and closing.

Closing

To close the doors, push lightly.

The closing process is automatic.

Valet parking mode

Principle

In the valet parking mode, the control display is disabled.

E.g., this mode can be used when the vehicle is handed over for valet parking.

General information

Depending on the national-market version, the valet parking mode may not be available.

Valet Parking mode has the following restrictions:

- ▶ Vehicle settings cannot be changed via iDrive.
- ▶ Settings stored to a BMW ID or guest profile cannot be changed.
- ▶ Personal data cannot be displayed.
- ▶ The audio system is muted, with the possible volume of the audio system being limited.
- ▶ The integrated Universal Remote Control is deactivated.
- ▶ Dynamic Stability Control cannot be turned off.
- ▶ The availability of certain settings of the driving modes is limited.

Additional information:

BMW ID/driver profiles, refer to page [68](#).

Functional requirement

The driver has registered in the vehicle with a BMW ID.

Activating the valet parking mode

1.  Apps menu
2. "Vehicle"
3. "System settings"
4. "Valet parking mode"
5. If necessary, "PIN"

If the active BMW ID does not have an assigned PIN, this PIN must be set now. The PIN is needed to deactivate the valet parking mode.

6. If necessary, enter the PIN.
7. "Activate valet parking mode"

Deactivating valet parking mode

1. Select the desired BMW ID on the lock screen.
2. ▶ Enter the assigned PIN for the BMW ID.
If you have forgotten the PIN: enter the access data for the BMW ID.
 - ▶ If the selected BMW ID does not have an assigned PIN: enter the access data for the BMW ID.

Settings

General information

Depending on the equipment and national-market version, various settings for opening and closing are possible.

Unlocking and locking

Doors

1.  Apps menu
2. "Vehicle"
3. "Doors and windows"
4. "Lock/unlock"
5. "Unlock"
6. Select the desired setting:
 - ▶ "Driver's door only"
Only the driver's door and the fuel filler flap are unlocked. Pressing again unlocks the entire vehicle.
 - ▶ "All doors"
The entire vehicle is unlocked.



Touchless unlocking/locking

1. Apps menu
2. "Vehicle"
3. "Doors and windows"
4. "Comfort access"
5. Select the desired setting.

Automatic unlocking

1. Apps menu
2. "Vehicle"
3. "Doors and windows"
4. "Lock/unlock"
5. Select the desired setting:
 - ▷ "Unlock doors at end of trip"
 - ▷ "Unlock doors when in P"

If locked, the vehicle unlocks automatically when drive-ready state is turned off or selector lever position P is engaged.

Automatic locking

1. Apps menu
2. "Vehicle"
3. "Doors and windows"
4. "Lock/unlock"
5. "Lock after a short time"

The vehicle locks automatically after a short period of time if no door is opened after unlocking.

Confirmation signals from the vehicle

1. Apps menu
2. "Vehicle"
3. "Doors and windows"
4. "Lock/unlock"
5. Select the desired setting:
 - ▷ "Flash on lock/unlock"
Unlocking is signaled by flashing twice, locking by flashing once.
 - ▷ With alarm system:

"Sound on lock/unlock"

Unlocking is confirmed with two sound signals, locking is confirmed with one sound signal.

Folding mirrors in automatically

1. Apps menu
2. "Vehicle"
3. "Doors and windows"
4. "Lock/unlock"
5. "Fold mirrors on lock/unlock"

Cargo area

Upper or both tailgates

The button in the car's interior can be set up to open only the upper tailgate or the upper and lower tailgate together:

1. Apps menu
2. "Vehicle"
3. "Doors and windows"
4. "Tailgate"
5. Select the desired setting:

- ▷ "Upper tailgate"

Only the upper tailgate opens.

- ▷ "Both tailgates"

The upper and lower tailgate will be opened together.

To open the upper and lower tailgate at the same time, the upper tailgate must be closed when the button is pressed.

This setting is also valid for the touchless opening of the tailgate.

Tailgate and doors

Depending on the vehicle equipment and country version, this setting may not be offered.

1.  Apps menu
2. "Vehicle"
3. "Doors and windows"
4. "Tailgate"
5. Select the desired button.
6. Select the desired setting:
 - ▷ "Upper tailgate"
The upper tailgate is opened.
 - ▷ "Upper tailgate and door(s)"
The tailgate is opened and the doors unlocked.
 - ▷ "Both tailgates"
The upper and lower tailgate will be opened.
 - ▷ "Both tailgates and door(s)"
The upper and lower tailgate will be opened and the doors unlocked.



The following settings are available for the button on the vehicle key:

- ▷ "Tailgate will only open if vehicle is already unlocked"
The vehicle must be unlocked before the tailgate can be used with the vehicle key.
- ▷ "Lock tailgate button"
The operation of the tailgate via the vehicle key is disabled.

Adjusting the opening height

You can set how far the upper tailgate can be opened.

When adjusting the opening height, make sure the clearance above the tailgate is at least 4 in/10 cm.

1.  Apps menu
2. "Vehicle"
3. "Doors and windows"
4. "Tailgate"
5. "Opening height"
6. Monitor the tailgate and set the desired opening height.

Opening/closing the cargo area contactlessly

1.  Apps menu
2. "Vehicle"
3. "Doors and windows"
4. "Tailgate"
5. Select the desired setting.

Alarm system

Principle

The alarm system issues a visual and acoustic signal when someone attempts to open the locked vehicle incorrectly.

General information

When the vehicle is locked, the vehicle alarm system reacts to the following changes:

- ▷ Opening a door, the hood, or the cargo area.
- ▷ Movements in the vehicle interior.
- ▷ Changes in the vehicle inclination such as during attempts at stealing a wheel or when towing the vehicle.
- ▷ Disconnected battery voltage.

- ▶ Improper use of the socket for OBD on-board diagnostics.
- ▶ Locking the vehicle while a device is connected to the diagnostic socket.

The alarm system signals these changes visually and acoustically:

- ▶ Acoustic alarm:
Depending on local regulations, the acoustic alarm may be suppressed.
- ▶ Optical alarm:
By flashing of the hazard warning system and headlights, where required.

Do not modify the system to ensure function of the alarm system.

Turning the alarm system on/off

The alarm system is turned on as soon as the vehicle is locked from the outside.

The alarm system is not switched on if the vehicle is locked from a greater distance with the My BMW App or manually from the inside.

The alarm system is switched off as soon as the vehicle is unlocked.

Opening the doors with the alarm system switched on

The alarm system is triggered when a door is opened if the door was unlocked using the integrated key in the door lock.

Opening the cargo area with the alarm system switched on

The cargo area can be opened even when the alarm system is switched on.

After closing the cargo area, the cargo area will be locked and monitored again. The hazard warning system flashes once during closing.

Panic mode

You can trigger the alarm system if you find yourself in a dangerous situation.



- ▶ Press the button on the vehicle key and hold for at least 3 seconds.
- ▶ Briefly press the button on the vehicle key three times in succession.

To switch off the alarm: press any button.

Indicator light on the interior mirror



- ▶ The indicator light flashes briefly every 2 seconds:
The alarm system is switched on.
- ▶ The indicator light flashes for approx. 10 seconds, then flashes briefly every 2 seconds:
Interior motion sensor and tilt alarm sensor are not active, as doors, hood, or tailgate are not correctly closed. Correctly closed access points are secured.
When the remaining open access points are closed, the interior motion sensor and tilt alarm sensor will be turned on.
- ▶ The indicator light flashes even though all access points have been closed:
Alarm system error.
- ▶ The indicator light goes out after unlocking:
The vehicle has not been tampered with.
- ▶ The indicator light flashes after unlocking until drive-ready state is switched on, but no longer than approx. 5 minutes:
The alarm has been triggered.

Tilt alarm sensor

The inclination of the vehicle is monitored.

The alarm system responds in situations such as attempts to steal a wheel or when the vehicle is towed.

Interior motion sensor

The vehicle interior is monitored.

The alarm system triggers when movement is detected inside the vehicle.

The windows and the glass sunroof must be closed for the system to function properly.

Avoiding unintentional alarms

General information

The tilt alarm sensor and interior motion sensor can trigger an alarm, although no unauthorized action occurred.

Possible situations for an unwanted alarm:

- ▶ In car washes.
- ▶ In duplex garages.
- ▶ During transport on trains carrying vehicles, at sea or on a trailer.
- ▶ With animals in the vehicle.
- ▶ When the vehicle is locked after start of refueling.

The tilt alarm sensor and the interior motion sensor can be switched off in such situations.

Switching off the tilt alarm sensor and interior motion sensor



Press the button on the vehicle key within 30 seconds as soon as the vehicle is locked.

The indicator light illuminates for approx. 2 seconds and then continues to flash.

The tilt alarm sensor and interior motion sensor are switched off until the vehicle is locked again.

Ending the alarm

Unlock the vehicle.

If the vehicle is unlocked with the integrated key, the drive-ready state must subsequently be turned on via the emergency detection of the vehicle key.

Window

General information

When a window is frequently opened to the same position, this task can be performed by the BMW Intelligent Personal Assistant. This is useful if you frequently use the same parking garage, for example.

Additional information:

BMW Intelligent Personal Assistant, refer to page 53.

Safety information

Warning

When operating the windows, body parts and objects can be jammed. There is a risk of injury or risk of damage to property. Make sure that the travel path of the windows is clear while opening and closing.

With the vehicle key

Opening windows



Press and hold the button on the vehicle key after unlocking.

The windows open for as long as the button on the vehicle key is pressed.

Closing the windows



With Comfort Access: press and hold the button on the vehicle key after locking.

The windows close for as long as the button on the vehicle key is pressed.

Depending on the vehicle equipment, exterior mirrors are folded in unless they were folded in during locking. The exterior mirrors are not folded in when the hazard warning flashers are switched on.

On the door handle

Principle

The windows can be closed using the door handle without operating the vehicle key.

The vehicle key is automatically detected near the vehicle.

General information

The function is available with Comfort Access.

Depending on national-market version, the windows can also be closed via the door handle using a compatible smartphone and digital key.

Additional information:

BMW Digital Key, refer to page 86.

Functional prerequisites

- ▶ Carry the vehicle key with you, for instance in your pants pocket.
- ▶ Bluetooth must be activated on the smartphone to close the window(s) using the digital key.

Closing the windows

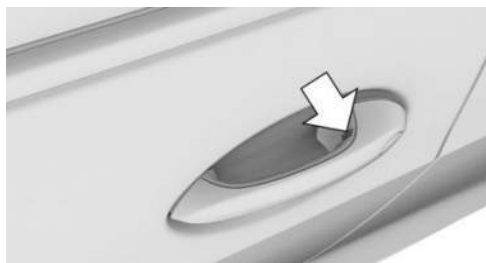

With your finger, touch and hold the grooved surface on a closed door handle without grasping the door handle.

In addition to locking, the windows and glass sunroof with sun protection will be closed.

Depending on the vehicle equipment, exterior mirrors are folded in unless they were folded in during locking. The exterior mirrors are not folded in when the hazard warning flashers are switched on.

Inside the vehicle

Overview

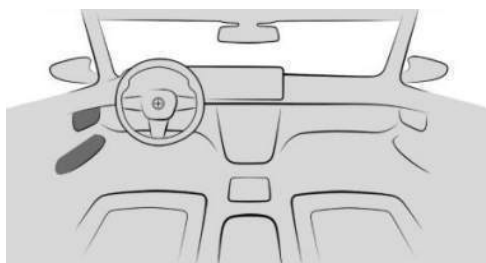



Power windows

Functional requirements



- ▶ Standby state is switched on.
- ▶ Drive-ready state is switched on.

The vehicle key or digital key must be inside the vehicle.

Opening windows

- ▷  Press the switch to the resistance point.
The window opens while the switch is being held.
- ▷  Press the switch beyond the resistance point.
The window opens automatically.
Pressing the switch again stops the motion.

Closing the windows

- ▷  Pull the switch to the resistance point.
The window closes while the switch is being held.
- ▷  Pull the switch beyond the resistance point.
The window closes automatically.
Pulling again stops the motion.

Anti-trap mechanism

Principle

The anti-trap mechanism prevents objects or body parts becoming jammed between the door frame and window while a window is being closed.

General information

If resistance or blockage is detected while a window is being closed, the closing will be interrupted.



Safety information

Warning

Accessories on the windows such as antennas can impact anti-trap mechanism. There is a risk of injury. Do not install accessories in the area of movement of the windows.

Closing without the anti-trap mechanism

In case of danger from the outside or if icing might prevent normal closing, proceed as follows:

1. Pull the  switch past the resistance point and hold it there.
The window closes with limited anti-trap mechanism. If the closing force exceeds a specific threshold, closing is interrupted.
2. Pull the  switch past the resistance point again within approx. 4 seconds and hold it there.
The window closes without the anti-trap mechanism.

Window roller sunblinds

General information

The safety switch in the driver's door can be used to prevent children, for instance from operating the roller sunblinds using the switches in the rear.

Overview

Driver's door

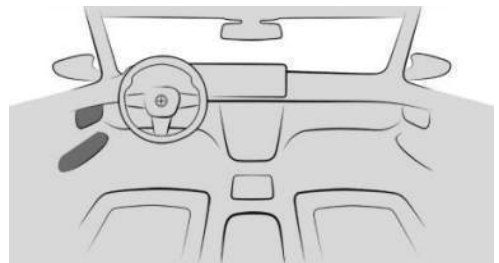

 Button for roller sunblinds.

Rear doors



 Buttons for the roller sunblinds.

Functional requirement

The affected window must be closed.

Operation

On the driver's door

 Press the button on the driver's door to open the roller sunblind if closed or to close the roller sunblind if open.

If the button on the driver's door is pressed again while moving, the roller sunblind moves in the opposite direction.

On the rear doors

 Press the button to open the closed roller sunblind or to close the open roller sunblind.

If the button is pressed again during the movement, the roller sunblind is moved in the opposite direction.

System limits

If you are no longer able to move the roller sunblinds after having activated them consecutively a number of times, the overheating protection mechanism is active. The system is disabled for a limited time to prevent overheating. Let the system cool down.

The side roller sunblinds cannot be moved at low interior temperatures.

Safety switch

Principle

The safety switch can be used to prevent children, for instance, from opening and closing the rear windows using the switches in the rear.

If an accident of a certain severity occurs, the safety function is switched off automatically.

Overview

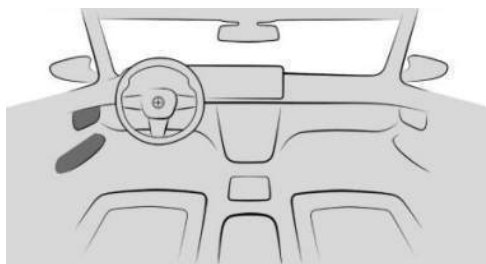

 The safety switch is located on the driver's door.

Turning the safety functions on/off

 Press the safety switch on the driver's door.

The LED in the button illuminates when the safety function is switched on.

Glass sunroof

Safety information

Warning

Body parts can be jammed when operating the glass sunroof. There is a risk of injury. Make sure that the area of movement of the glass sunroof is clear during opening and closing.

With the vehicle key

Opening glass sunroof



Press and hold the button on the vehicle key after unlocking.

The glass sunroof with sun protection will be opened for as long as the button on the vehicle key is pressed.

Closing glass sunroof



With Comfort Access: press and hold the button on the vehicle key in close range of the vehicle after locking.

The glass sunroof with sun protection will be closed for as long as the button on the vehicle key is pressed.

Depending on the vehicle equipment, exterior mirrors are folded in unless they were folded in while locking. The exterior mirrors are not folded in when the hazard warning flashers are switched on.

On the door handle

Principle

The glass sunroof can be closed using the door handle without operating the vehicle key. The vehicle key is automatically detected near the vehicle.

Functional prerequisites

- ▶ Carry the vehicle key with you, for instance in your pants pocket.
- ▶ Bluetooth must be activated on the smartphone to close the glass sunroof using the digital key.

Closing glass sunroof

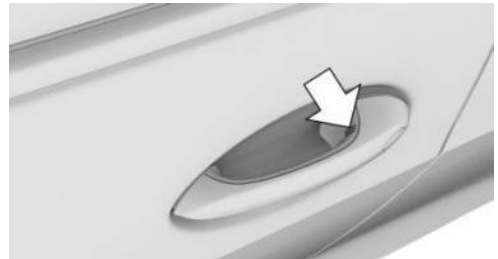

Touch the grooved surface on the external door handle of a closed front door with your finger and hold it there without grasping the door handle.

In addition to locking, the windows and glass sunroof with sun protection will be closed.

Depending on the vehicle equipment, exterior mirrors are folded in unless they were folded in while locking. The exterior mirrors are not folded in when the hazard warning flashers are switched on.

Inside the vehicle

Functional requirements

The glass sunroof and sun protection can be operated under the following conditions.

- ▶ Standby state is switched on.
- ▶ Drive-ready state is switched on.

The vehicle key must be inside the vehicle.

General information

The glass sunroof and the sun protection are operated using the same switch.

The rear sun protection is operated using separate buttons.

Overview

Button in the vehicle



Opening/closing the glass sunroof/front sun protection.

Lifting/closing glass sunroof



Push switch briefly upward.

- ▶ The closed glass sunroof tilts and the sun protection opens slightly.
- ▶ The opened glass sunroof closes until it is in the tilted position. The sun protection does not move.

- ▶ The tilted glass sunroof closes.

Opening/closing the glass sunroof and sun protection separately



- ▶ Slide switch back to the resistance point and hold. Holding down the switch opens the sun protection. If the sun protection is already

fully open, the glass sunroof opens.

- ▶ Slide switch forward to the resistance point and hold.

The glass sunroof closes while the switch is being held. If the glass sunroof is already closed or in the tilted position, the sun protection closes.

- ▶ Slide the switch back past the resistance point.

The sun protection opens automatically. If the sun protection is already fully open, the glass sunroof opens automatically.

Pressing the switch again stops the motion.

- ▶ Push the switch forward past the resistance point.

The glass sunroof closes automatically. If the glass sunroof is already closed or in the tilted position, the sun protection closes automatically.

Pressing the switch again stops the motion.

Opening/closing the glass sunroof and sun protection together



- ▶ Briefly press out the switch twice in succession toward the rear past the resistance point.

The glass sunroof and sun protection open together.

Pressing the switch again stops the motion.

- ▶ Briefly press out the switch twice in succession toward the front past the resistance point.

The glass sunroof and sun protection close together.

Pressing the switch again stops the motion.

Comfort position

In some models, the wind noises in the car's interior are lowest when the glass sunroof is not fully open. In these models, the automatic function initially only opens the glass sunroof up to this comfort position.

Operating the switch inside the vehicle again opens the glass sunroof completely.

Opening/closing the sun protection

On the headliner control panel

Overview

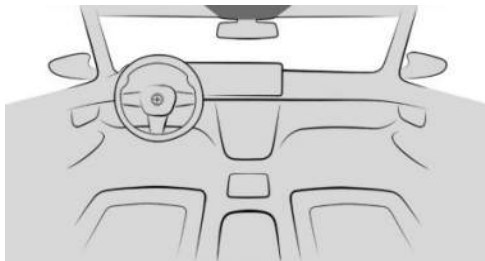

 Opening the rear sun protection.

 Closing the rear sun protection.

Operation

 Press the button to open the rear sun protection.

Press button again to stop the movement.

 Press the button to close the rear sun protection.

Press button again to stop the movement.

On the control panel in the rear doors

General information

When equipped with roller sunblinds in the rear side windows:

The rear and front sun protection can be opened and closed via the control panels in the rear doors.

Overview



 Button for the rear sun protection.

 Button for the front sun protection.

Operation

The front and rear sun protection cannot be operated with the switches in the rear when the safety function is switched on.

 Press the button to open the closed rear sun protection or to close the open rear sun protection.

Press button again to stop the movement.

When the button is pressed again, the rear sun protection will move in the opposite direction.

 Press the button to open the closed front sun protection or to close the open front sun protection.

Press button again to stop the movement.

When the button is pressed again, the front sun protection will move in the opposite direction.

Additional information:

Safety switch, refer to page 98.

On the control panel above the third seat row

Overview



 Button for the rear sun protection.

Operation

It is not possible to operate the rear sun protection via the switches in the rear if the safety function is switched on.

 Press the button to open the closed rear sun protection or to close the open rear sun protection.

Press button again to stop the movement.

When the button is pressed again, the rear sun protection will move in the opposite direction.

Additional information:

Safety switch, refer to page 98.

Anti-trap mechanism

Principle

The anti-trap mechanism prevents objects or body parts from becoming jammed between

the roof frame and glass sunroof while the glass sunroof is closing.

General information

If a resistance or blockage is detected while the glass sunroof is closing, the closing operation is interrupted once the roof reaches the half-open position, or it is stopped when closing from the tilted position.

Closing from the open position without the anti-trap mechanism

If an external hazard or ice prevents normal closure, proceed as follows:



1. Close all doors.
2. Switch on drive-ready state or stop a moving vehicle.
3. Push the switch forward past the resistance point and hold.

The glass sunroof closes with limited anti-trap mechanism. If the closing force exceeds a specific threshold, closing is interrupted.

4. Push the switch forward again past the resistance point and hold until the glass sunroof closes without the anti-trap mechanism. Make sure that the closing path is clear.

Closing from the lifted position without the anti-trap mechanism

In case of danger from the outside or if icing might prevent normal closing, proceed as follows:



1. Close all doors.
2. Switch on drive-ready state or stop a moving vehicle.
3. Push the switch forward past the resistance point and hold.

- ▶ If the glass sunroof is closed, it opens then closes again.
- ▶ If the glass sunroof is open, it first closes, then opens and closes again.
- ▶ The sun protection is initialized in the closed position.

Initialization is complete once the glass sunroof and the sun protection have opened then closed again.

Initializing after a power interruption

General information

After a power interruption during the opening or closing process, the glass sunroof can only be operated to a limited extent. Initializing the system can help in this case.

The system can be initialized under the following conditions:

- ▶ The vehicle is parked in a horizontal position.
- ▶ The vehicle will not be moved until the initialization is completed.
- ▶ The drive-ready state is established.
- ▶ The outside temperature is above 41 °F/5 °C.

During initialization, the glass sunroof closes without the anti-trap mechanism.

Make sure that the closing path is clear.

Initializing the system



Press the switch up and hold it until the initialization is complete:

Initialization begins within 15 seconds.

Seats, mirrors and steering wheel

Vehicle features and options

This chapter describes model-specific equipment, systems, and functions that are currently available, or may become available in the future, even if they are not present in the vehicle.

Additional information:

Vehicle equipment, refer to page 8.

Sitting safely

An ideal seat position that meets the needs of the occupants can make a vital contribution to relaxed, fatigue-free driving.

In the event of an accident, the correct seat position plays an important role. Follow the information in the following chapters.

Additional information:

- ▶ Seats, refer to page 104.
- ▶ Seat belts, refer to page 113.
- ▶ Head restraints, refer to page 115.
- ▶ Airbags, refer to page 178.

Seats, front

Safety information

Warning

Seat setting while driving can lead to unexpected movements of the seat. Vehicle control could be lost. There is a risk of accident, injury, or property damage. Only adjust the seat on the driver's side when the vehicle is stationary.

Warning

With a backrest inclined too far to the rear, the protective effect of the seat belt can no longer be ensured. There is a risk of sliding under the seat belt in an accident. There is a risk of injury or danger to life. Adjust the seat prior to starting the trip. Adjust the backrest so that it is in the most upright position as possible and do not adjust again while driving.

Warning

There is a danger of jamming when moving the seats. There is a risk of injury or risk of damage to property. Make sure that the travel path of the seat is clear prior to any adjustment.

Adjusting seats

General information

The current seat position can be stored using the memory function.

Overview

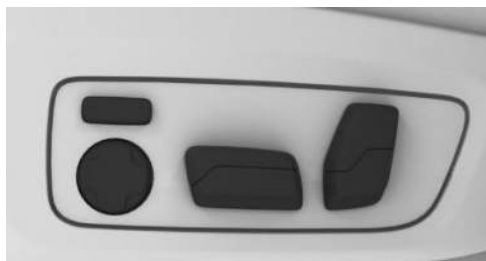

The switches for setting the seats are located on the front seats.

Setting the longitudinal direction

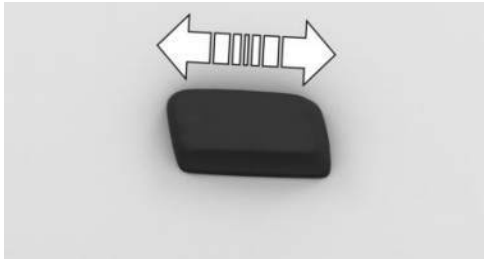

Press switch forward or backward.

Adjusting backrest tilt

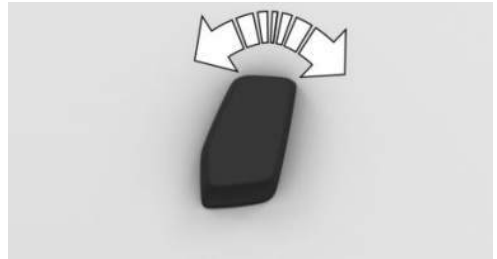

Tilt switch forward or backward.

Adjusting the height

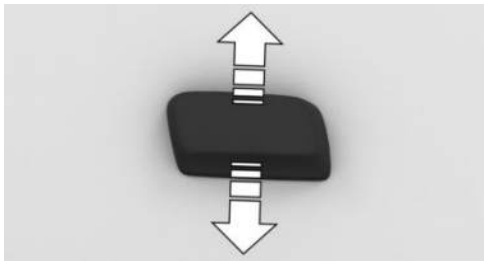

Press switch up or down.

Adjusting seat tilt

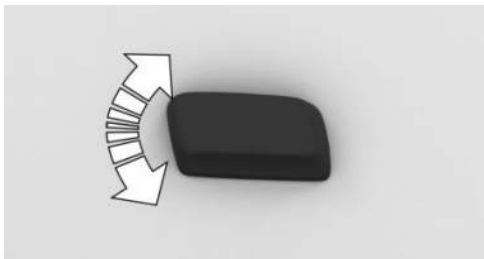

Tilt switch up or down.

Adjusting the seat position automatically

General information

The seat setting for the driver's seat is stored in the active BMW ID or in the active driver profile. If the BMW ID or the driver profile is reactivated at a later time, the saved position will be called up automatically.

Activate/deactivate the function

1.  Apps menu
2. "Vehicle"
3. "Seat comfort"
4. Select driver's seat.
5. "Use automatically"
6. Select the desired setting.

Thigh support

Sport seat

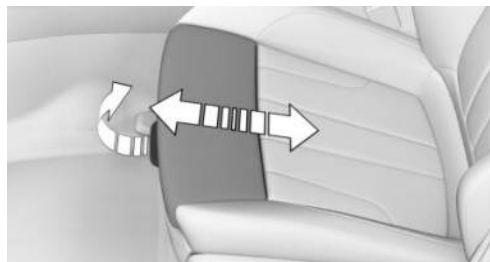

Pull the lever at the front of the seat and push the thigh support forward or back.

Multifunctional seat

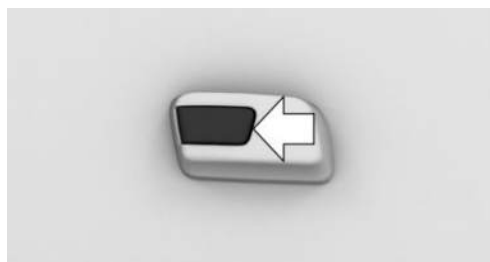

Push the switch in the front or back.

Lumbar support

Principle

The curvature of the seat backrest can be adjusted in a way that it supports the lumbar region of the spine. The lower back and the spine are supported for upright sitting position.

Adjusting the lumbar support



- ▶ Press the front/rear section of the button:
The curvature is increased/decreased.
- ▶ Press the upper/lower section of the button:

The curvature is shifted up/down.

Backrest width

Principle

Adjusting the backrest width may improve side support when cornering.

General information

The backrest width is changed by adjusting the side sections of the backrest.

When exiting the vehicle, the backrest width opens completely. The last set position is automatically applied before you start driving.

Adjusting the backrest width



- ▶ Press the front section of the button:
The backrest width decreases.
- ▶ Press the rear section of the button:
The backrest width increases.

Upper backrest

Principle

The upper backrest supports the back in the shoulder region. A correct setting leads to a relaxed seat position and reduces strain on the shoulder muscles.

General information

When exiting the vehicle, the upper backrest moves all the way back. The last set position is automatically applied before you start driving.

Adjusting the upper backrest



- ▶ Press the front section of the button:
The upper backrest is inclined forward.
- ▶ Press the rear section of the button:
The upper backrest is inclined backward.

Front passenger seat functionality

Principle

The front passenger seat can be adjusted with the switches of the driver's seat, for instance to increase the legroom in the rear.

If needed, the memory position for the front passenger seat can be stored.

Overview

Buttons in the vehicle

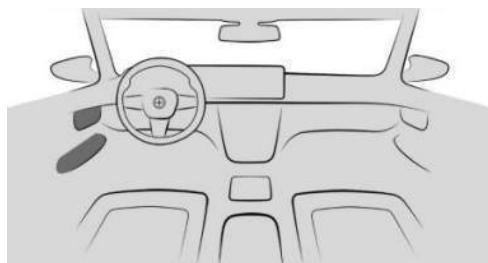

-  Front passenger seat functionality

Turning on

1.  Press the button. The LED illuminates.
2. Adjust the front passenger seat on the driver's seat.
3. If needed, store the memory position for the front passenger seat.

Turning off

-  Press the button. The LED goes out. The function deactivates itself automatically after some time.

Seat massage

Principle

The seat massage ensures relaxed muscles and better blood circulation in the lumbar region and can avoid fatigue.

Turning the seat massage on/off

1.  Apps menu
2. "Vehicle"
3. "Seat comfort"
4. Select desired seat.
5. "Massage"
6. "Massage"
7. If necessary, select the desired setting.

Calibrating the front seats

General information

As soon as the electric seat setting no longer functions precisely, a Check Control message is displayed on the control display.

To restore the accuracy of the electric seat setting, the front seats must be calibrated.

Safety information

Warning

There is a danger of jamming when moving the seats. There is a risk of injury or risk of damage to property. Make sure that the travel path of the seat is clear prior to any adjustment.

Calibrating the front seat

1. Press the longitudinal direction switch forward until the seat stops.
2. Press the switch forward again until the seat stops.

As soon as the message on the control display disappears, the calibration is complete. If the message remains active, repeat the calibration.

If the message is still shown after repeated calibration, have the vehicle checked by an authorized service center or another qualified service center or repair shop.

Rear seats

Second row of seats

General information

For the seats in the second row of seats, the backrest tilt can be adjusted, as can the longitudinal direction as needed.

The longitudinal direction of the middle section is adjusted together with the left rear seat.

Safety information

Warning

There is a danger of jamming when moving the seats. There is a risk of injury or risk of damage to property. Make sure that the travel path of the seat is clear prior to any adjustment.

Warning

There is a danger of jamming when folding down the center armrest in the rear. There is a risk of injury. Make sure that the area of movement of the center armrest is clear when folding down.

Warning

When folding back the second row of seats, there is a danger of jamming. There is a risk of injury or risk of damage to property. Make sure that the area of movement of the second row of seats is clear prior to folding down.

Warning

Seats in the second row of seats are not locked when they are folded down and they can move. There is a risk of injury and risk of property damage. Only fold the seats in the second row down while loading. When driving without a load, fold back and lock the seats in the second row before driving away.

Overview

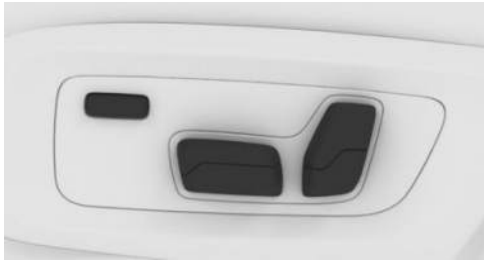

The seat setting switches are located on the seats.

Resetting to base position

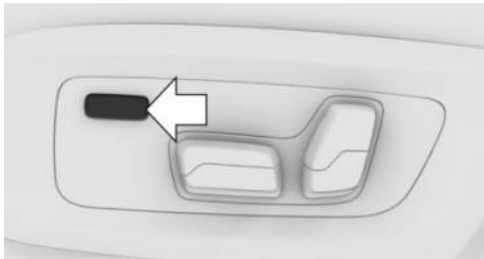

Press the button to reset to base position.
The process is canceled if the button is pressed again.

Longitudinal direction

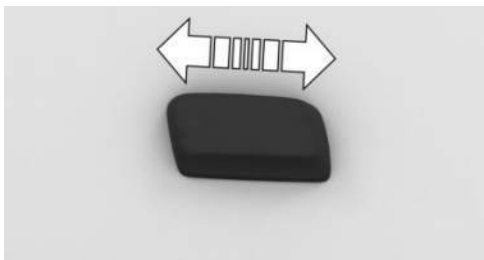

Press switch forward or backward.

Backrest tilt

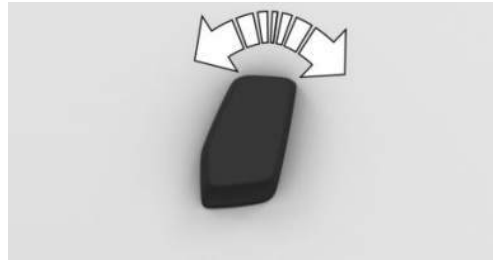

Tilt switch forward or backward.

Access to the third row of seats

Safety information

Warning

There is a danger of jamming when moving the seats. There is a risk of injury or risk of damage to property. Make sure that the travel path of the seat is clear prior to any adjustment.

Warning

If a rear seat backrest is not locked, unsecured cargo can be thrown about the car's interior; for instance, in the event of an accident, braking or an evasive maneuver. There is a risk of injury. Make sure that the rear seat backrest is locked after folding it back.

Folding down the rear seat backrest

With seven seats:

1. Fold middle section of the second seat row up as necessary.
2. Push the switch once forward or backward.



The seat automatically moves to the respective end position.

With six seats:

1. Pull lever up to the stop.



2. Fold backrest forward.

To make the entry to the rear easier, the seat will automatically move to the most forward position.

To avoid a collision, the position of the front seats may be adjusted automatically.

If the second row of seats is not locked, an acoustic signal will sound and a warning icon will be displayed in the instrument cluster.

6-seater

General information

The second seat row consists of two split seats with separate armrests.

Rear armrest

Safety information

Warning

Body parts may be pinched when moving the armrest. There is a risk of injury. Make sure that the area of movement is clear when moving the armrest.

Adjusting the height

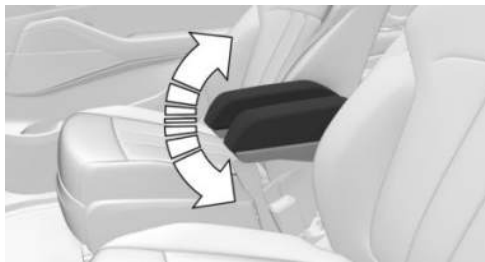

- ▶ Upward: pull the armrest into the desired position.
- ▶ Downward: pull the armrest to the top position and then push it all the way down.

After setting the height, move the armrest up or down slightly, making sure the armrest engages properly.

Setting the longitudinal direction



Slide the upper part of the armrest to the front or rear.

Operating the second seat row from the front seats

Principle

The second seat row can be operated from the front seats, e.g. to prepare the entry to the third seat row easier.

Overview

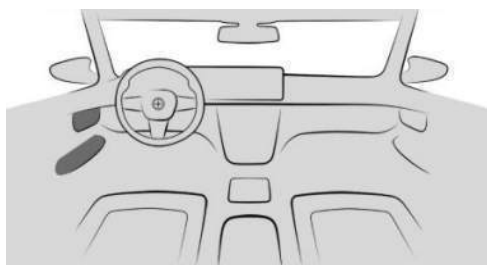

REAR  Comfort entry, 3rd seat row

Adjusting

REAR  Push the switch once forward or backward. The seat automatically moves to the respective end position.

Third row of seats

General information

The third row of seats consists of two divided seats.

Fold up the backrest

Safety information

Warning

There is a danger of jamming when moving the seats. There is a risk of injury or risk of damage to property. Make sure that the travel path of the seat is clear prior to any adjustment.

Warning

If a rear seat backrest is not locked, unsecured cargo can be thrown about the car's interior; for instance, in the event of an accident, braking or an evasive maneuver. There is a risk of injury. Make sure that the rear seat backrest is locked after folding it back.

From the rear

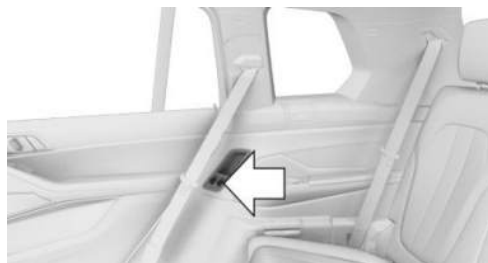

-  Press the switch.
 - ▶ Press the switch. The rear seat backrest automatically moves to the respective

end position. Pressing again stops the motion.

- ▶ Push the switch and hold it. The rear seat backrest moves as long as the switch is held down.

2. Fold the head restraint back.

Switch	Function
Front.	The left rear seat backrest sets itself upright.
Rear.	The right rear seat backrest sets itself upright.

From the cargo area



1.  Press the switch.

- ▶ Pull the switch. The rear seat backrest automatically moves to the respective end position. Pulling again stops the motion.
- ▶ Pull the switch and hold it. The rear seat backrest moves as long as the switch is pulled.

2. Fold the head restraint back.

Switch	Function
Top, rear.	The left rear seat backrest sets itself upright.
Bottom, rear.	The right rear seat backrest sets itself upright.

Folding down the rear seat backrest

From the rear



Pull the switch or hold it pulled. The rear seat backrest and the head restraint fold down.

From the cargo area



Press the switch or hold it pressed. The rear seat backrest and the head restraint fold down.

Exiting from the third row of seats

Depending on the equipment version, the second seat row can be folded down using the switch or the lever.

Additional information:

Access to the third row of seats, refer to page [109](#)

With seven seats: emergency unlocking rear seat backrest

General information

The two outer backrests of the second seat row can be folded down manually such as in the event of an electrical fault.

Unlocking from the second seat row



Pull the loop and fold the rear seat backrest forward.

Unlocking from the third seat row

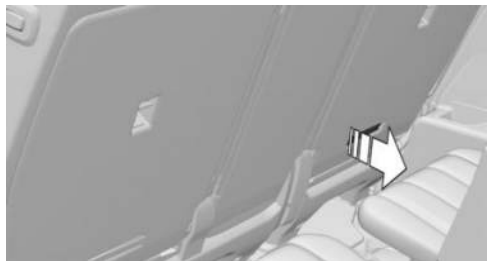

Pull the loop and fold the rear seat backrest forward.

Seat belts

General information

The vehicle is fitted with six or seven seat belts to ensure occupant safety. However, they can only offer protection when adjusted correctly.

Always make sure that seat belts are being worn by the occupants before driving off. The airbags supplement the seat belts as an additional safety device. The airbags do not replace seat belts.

All seat belt anchorage points are designed to achieve the best possible protective effect for the seat belts when used properly and with the correct seat settings.

The two outer seat belt buckles of the rear seats are intended for the persons sitting on the left and right.

The center seat belt buckle of the rear seats is intended for the person sitting in the middle.

Additional information:

Notes on sitting safely, refer to page [104](#).

Safety information

Warning

Use of a seat belt to buckle more than one person will potentially defeat the ability of the seat belt to serve its protective function. There is a risk of injury or danger to life. Do not strap in more than one person per single seat belt. Infants and children are not allowed on an occupant's lap, and must be transported and secured in designated child restraint systems.

Warning

The protective effect of safety gear, including seat belts, can be limited or lost when seat belts are fastened incorrectly. An incorrectly fastened seat belt can cause additional injuries, for instance in the event of an accident, braking or evasive maneuvers. There is a risk of injury or danger to life. Make sure that all occupants are wearing seat belts correctly.

Warning

With a rear seat backrest that is not locked, the protective effect of the middle seat belt is not guaranteed. There is a risk of injury or danger to life. If you are using the middle seat belt, lock the wider rear seat backrest.

Warning

The protective effect of safety gear, including seat belts, may not be fully operational or fail in the following situations:

- ▷ The seat belts or seat belt buckles are damaged, soiled, or changed in any other way.
- ▷ Seat belt tensioners or seat belt winders were modified.

Seat belts can be imperceptibly damaged in the event of an accident. There is a risk of injury or danger to life. Keep clean and do not modify: seat belts, seat belt buckles, seat belt tensioners, seat belt winders, and seat belt anchors. After an accident, have the seat belts checked by an authorized service center or another qualified service center or repair shop.

Correct use of seat belts

- ▶ Wear the seat belt tight to your body over your lap and shoulders, without twisting it.
- ▶ Wear the seat belt deep on your hips over your lap. The seat belt must not press on your stomach.
- ▶ Do not rub the seat belt against sharp edges, or guide it or jam it in across hard or fragile objects.
- ▶ Avoid thick clothing.
- ▶ Re-tighten the seat belt frequently upward around your upper body area.

Seat belt height adjustment

General information

The seat belt anchorage point in the second row of seats can be adjusted to the body size of the occupants with the seat belt height adjustment.

Adjusting

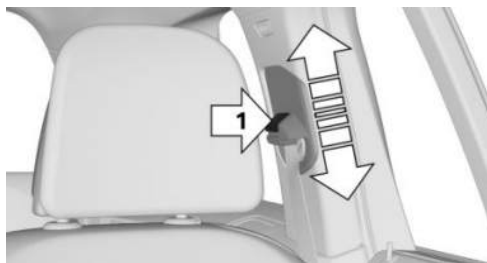

Press and hold the button, arrow 1, and push the seat belt height adjustment up or down.

After setting the height, make sure that the seat belt height adjustment engages correctly.

Buckling the seat belt

1. Guide the seat belt slowly over shoulder and hip to put it on.
2. Insert the buckle tongue into the seat belt buckle. The seat belt buckle must engage audibly.

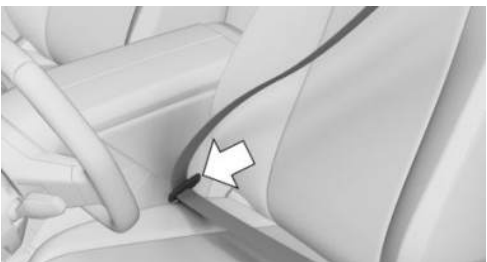

To ease accessibility to the seat belt buckle, an adjustable slider is available on the belt to help position the buckle when not in use.

Unbuckling the seat belt

1. Hold down the seat belt firmly.
2. Press the red button in the seat belt buckle.
3. Guide the seat belt back into the seat belt winder.

Seat belt reminder

General information

Make sure that the seat belts are positioned correctly.





The seat belt reminder becomes active in the following situations:

- ▶ When the seat belt on the driver's side or on the passenger's side is not fastened.
- ▶ When the seat belt is unfastened while driving.
- ▶ When objects are lying on a seat.

Display in the instrument cluster

The indicator light in the instrument cluster illuminates after turning on the drive-ready state when the seat belt reminder is active.

A Check Control message is displayed where applicable. Check whether the seat belt has been fastened correctly.

Icon	Meaning
	Seat belt on the driver's seat is not buckled.
	Seat belt on the passenger seat or another seat in the vehicle is not buckled.
	Seat belt is buckled on the corresponding seat.
	Seat belt is not buckled on the corresponding seat.

Rear Occupant Alert

Principle

At the end of a trip, the system informs the driver of the possible presence of occupants on the rear seats.

General information

If a door with access to the rear row seating is operated within 30 minutes before starting off, a message appears on the control display when the trip is completed and a signal tone sounds.

If the trip is continued within 30 minutes, the message is displayed again after the trip has been completed.

Activate/deactivate the function

1.  Apps menu
2. "System settings"
3. "Rear Occupant Alert"
4. Select the desired setting.

Safety mode

Depending on vehicle equipment, the driver and front passenger seat belt straps are automatically tightened once after driving off, if the seat belt is fastened.

If necessary, in critical driving situations, e.g., during emergency braking, the front seat belts are automatically pretensioned.

After a critical driving situation without an accident, the front seat belts are loosened again. If the belt tension does not loosen automatically, stop the vehicle and unbuckle the seat belt using the red button in the buckle. Fasten the seat belt before continuing to drive.

Front head restraints

Safety information

Warning

Removal or incorrect adjustment of head restraints can cause injuries in the head and neck area. There is a risk of injury.

- ▷ Before driving, install the removed head restraints on the occupied seats.
- ▷ Adjust the head restraint so its center supports the back of the head at as close to eye level as possible.
- ▷ Adjust the distance so that the head restraint is as close as possible to the back of the head. Adjust the distance via the backrest tilt as needed.
- ▷ For manually adjustable head restraints: After adjusting, make sure that the head restraint is correctly engaged.

Warning

Body parts can be jammed when moving the head restraint. There is a risk of injury. Make sure that the area of movement is clear when moving the head restraint.

Warning

Objects on the head restraint reduce the protective effect in the head and neck area. There is a risk of injury.

- ▷ Do not use seat or head restraint covers.
- ▷ Do not hang objects, for instance clothes hangers, directly on the head restraint.
- ▷ Only use accessories that have been determined to be safe for attachment to a head restraint.
- ▷ Do not use any accessories, for instance pillows, while driving.

Active head restraint

In the event of a rear-end collision with a certain severity, the active head restraint automatically reduces the distance from the head. Have the active head restraint checked and if necessary replaced in the case of damage or if it was exposed to an accident.

Adjusting the height

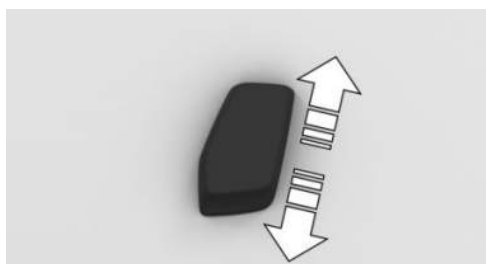

Press switch up or down.

Adjusting the distance



- ▷ Back: press the button and push the head restraint toward the rear.
- ▷ Forward: pull the head restraint toward the front.

Adjusting the side extensions



Fold the side extensions on the head restraint forward for increased side support in the resting position.

Removing the head restraints

The head restraints cannot be removed.

Rear head restraints

Safety information

Warning

Removal or incorrect adjustment of head restraints can cause injuries in the head and neck area. There is a risk of injury.

- ▷ Before driving, install the removed head restraints on the occupied seats.
- ▷ Adjust the head restraint so its center supports the back of the head at as close to eye level as possible.
- ▷ Adjust the distance so that the head restraint is as close as possible to the back of the head. Adjust the distance via the backrest tilt as needed.
- ▷ For manually adjustable head restraints: After adjusting, make sure that the head restraint is correctly engaged.

Warning

Body parts can be jammed when moving the head restraint. There is a risk of injury. Make sure that the area of movement is clear when moving the head restraint.

Warning

Objects on the head restraint reduce the protective effect in the head and neck area. There is a risk of injury.

- ▷ Do not use seat or head restraint covers.
- ▷ Do not hang objects, for instance clothes hangers, directly on the head restraint.

- ▷ Only use accessories that have been determined to be safe for attachment to a head restraint.
- ▷ Do not use any accessories, for instance pillows, while driving.

Folding down the head restraints

General information

The outer head restraints of the second seat row and the head restraints of the third seat row can be folded down to improve the rear field of vision. Only fold down the head restraint if no one will be sitting in the corresponding seat.

Second-row seating

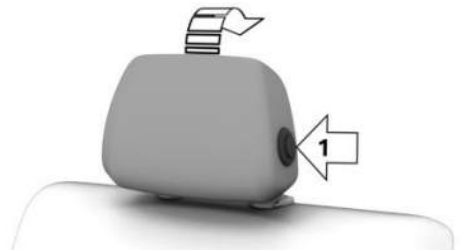

Press button, arrow 1, and fold the head restraint back.

To return the head restraint to its initial position, fold the head restraint forward as far as it will go. Make sure that the head restraint engages correctly.

Third row of seats



Pull the loop to fold the head restraint forward. To return the head restraint to its initial position, fold the head restraint back as far as it will go. Make sure that the head restraint engages correctly.

Adjusting the height



- ▶ To lower: press the button, arrow 1, and push the head restraint down.
- ▶ To raise: push the head restraint up.

Removing the head restraint

The head restraints cannot be removed.

Cushions for head restraints in rear

Only use the pillow when the vehicle is switched off.

1. Bring the head restraint to a sufficiently high position.
2. Attach the pillow and place the pillow band around the back of the head restraint, arrow 1.

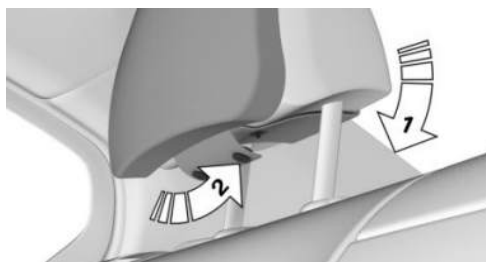

3. Close pushbuttons, arrow 2.

Cushions for head restraints in rear, 6-seater

Only use the pillow when the vehicle is switched off.

1. Pull the upper lug through the loop on the top of the head restraint.



2. Close both pushbuttons.

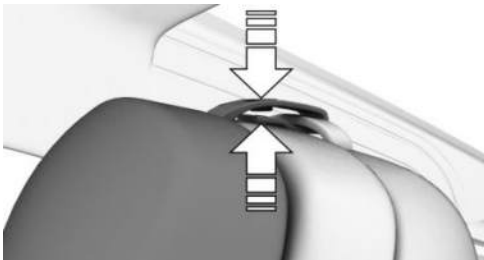

3. Move the head restraint into the topmost position.
4. Close the push-button on the lower lug and the pushbutton on the bottom of the head restraint.

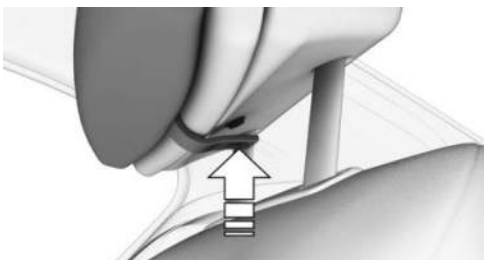

Exterior mirrors

General information

The front passenger's side exterior mirror is more curved than the driver's side mirror.

The exterior mirror adjustment is stored in the active BMW ID or in the active driver profile. If the BMW ID or the driver profile is reactivated at a later time, the stored position is called up automatically.

The current exterior mirror adjustment can be stored using the memory function.

Safety information

Warning

Objects in the mirror are closer than they appear. The distance to the road users behind could be incorrectly estimated, for instance while changing lanes. There is a risk of accident, injury, and property damage. Estimate the distance to the traffic behind by looking over your shoulder.

Overview





Icon	Meaning
	Fold the exterior mirror in and out.
	Adjust the exterior mirrors.
	Select exterior mirror, Automatic Curb Monitor.



Adjusting the exterior mirrors



Press the button.

The selected exterior mirror moves along with the button movement.

Selecting the exterior mirror



To change over to the other mirror:
Slide the switch.

Malfunction

In case of an electrical malfunction, adjust the exterior mirror by pressing on the edges of the mirror glass.

Folding in/folding out the exterior mirrors

NOTICE

Depending on the vehicle width, the vehicle can be damaged in car washes. There is a risk of property damage. Before washing, fold in the mirrors by hand or with the button.



Press the button.

Folding is possible at vehicle speeds of up to approx. 12 mph/20 km/h.

Folding the exterior mirrors in and out is helpful in the following situations:

- ▷ In car washes.
- ▷ On narrow roads.

Exterior mirrors that were folded in are folded out automatically at a speed of approx. 25 mph/40 km/h.

Automatic heating

Both exterior mirrors are automatically heated as needed and when the drive-ready state is switched on.

Automatic dimming

The exterior mirror on the driver's side is automatically dimmed. Photocells in the interior mirror are used to control this.

Automatic Curb Monitor

Principle

If reverse gear is engaged, the mirror glass on the passenger's side is tilted downward. This improves your view of the curb and other low-lying obstacles when parking, for instance.

Activating the Automatic Curb Monitor



1. Slide the switch to the driver's side mirror position.
2. Engage selector lever position R.

When the trailer power socket is occupied or trailer towing is activated, the Automatic Curb Monitor is deactivated.

Deactivating the Automatic Curb Monitor

Slide the switch to the front passenger's side exterior mirror position.

Interior mirror, automatic dimming feature

General information

The interior mirror is dimmed automatically. Photocells are used for control:

- ▷ In the mirror glass.
- ▷ On the rear of the mirror.

Overview



Functional requirements

- ▷ Keep the photocells clean.
- ▷ Do not cover the area between the interior mirror and the windshield.

Steering wheel

Safety information

Warning

Steering wheel adjustments while driving can lead to unexpected steering wheel movements. Vehicle control could be lost. There is a risk of accident, injury, or property damage. Adjust the steering wheel while the vehicle is stationary only.

Electric steering wheel adjustment

General information

The steering wheel adjustment is stored in the active BMW ID or in the active driver profile. If the BMW ID or the driver profile is reactivated at a later time, the stored position is called up automatically.

The current steering wheel position can be stored using the memory function.

To make it easier to enter and get out of the vehicle, the steering wheel moves temporarily into the upper position.

Adjusting the steering wheel position

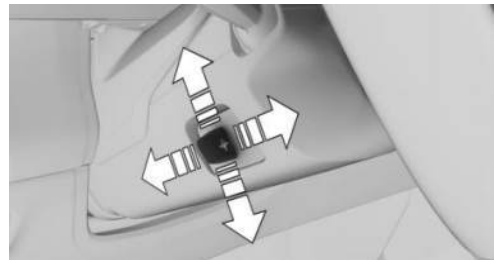

Press the switch to adjust the steering wheel forward/back position and height to the seat position.

Memory function

Principle

The following settings can be stored and, if necessary, retrieved using the memory function:

- ▷ Seat position.
- ▷ Exterior mirror adjustment.
- ▷ Steering wheel position.
- ▷ Height of the Head-up display.



General information

Two memory locations with different settings can be set for each driver profile.

The following settings are not stored:

- ▷ Backrest width.
- ▷ Lumbar support.

Safety information

Warning

Using the memory function while driving can lead to unexpected seat or steering wheel movements. Vehicle control could be lost. There is a risk of accident, injury, and property damage. Only retrieve the memory function when the vehicle is stationary.

Warning

There is a danger of jamming when moving the seats. There is a risk of injury or risk of damage to property. Make sure that the travel path of the seat is clear prior to any adjustment.

Overview



The memory buttons are located on the front doors.

Storing settings

1. Set the desired position.
2.  Press the button. The LED illuminates.
3. Press the desired memory button 1 or 2 while the LED is illuminated. A signal sounds.

Calling up settings

Press the desired memory button 1 or 2.

The stored position is called up.

The procedure stops when a seat setting switch or one of the memory buttons is pressed again.

The adjustment of the seat position on the driver's side is interrupted after a short time while driving.

Seat climate control

Various climate control functions are available for the seats.

Additional information:

Climate control, refer to page [286](#).

Transporting children safely

Vehicle features and options

This chapter describes model-specific equipment, systems, and functions that are currently available, or may become available in the future, even if they are not present in the vehicle.

Additional information:

Vehicle equipment, refer to page 8.

The right place for children

Safety information

Warning

Unattended children or animals in the vehicle can cause the vehicle to move and endanger themselves and traffic, for example, due to the following actions:

- ▷ Establishing standby.
- ▷ Releasing the parking brake.
- ▷ Opening and closing the doors or windows.
- ▷ Engaging selector lever position N.
- ▷ Using vehicle equipment.

There is a risk of accident, injury, and property damage. Do not leave children or animals unattended in the vehicle. Take the vehicle key with you when exiting and lock the vehicle.

Warning

A hot vehicle may result in death to persons, especially children, or animals. There is a risk of injury or danger to life. Do not leave people, especially children, or animals unattended in the vehicle.

Warning

Exposure to intense sunlight can cause child restraint systems and their components to become very hot. Persons may sustain burn injuries when touching the hot components. There is a risk of injury. Do not expose the child restraint system to direct sunlight or cover where necessary. If necessary, let the child restraint system cool down before transporting a child. Do not leave children unattended in the vehicle.

Children in the rear seat

General information

Accident research shows that the safest place for children is in the rear seat.

Children younger than 13 years of age or shorter than 5 ft/150 cm should be transported in the rear seat in suitable child restraint systems designed for the age, weight and size of the child. Children 13 years of age or older must wear a seat belt as soon as a suitable child restraint system can no longer be used due to their age, weight, or size.

Safety information

Warning

The seat belt cannot be fastened correctly on children shorter than 5 ft/150 cm without suitable additional child restraint systems. The protective effect of safety gear, including seat belts, can be limited or lost when seat belts are fastened incorrectly. An incorrectly fastened seat belt can cause additional injuries, for instance in the event of an accident, braking or evasive maneuvers. There is a risk of injury or danger to life. Secure children shorter than 5 ft/150 cm using suitable child restraint systems.

Children on the front passenger seat

General information

Before using a child restraint system on the front passenger seat, ensure that the front, knee, and side airbags on the passenger's side are deactivated.

Additional information:

For automatic deactivation of front passenger airbags, refer to page [180](#).

Safety information

Warning

Active front passenger airbags can injure a child in a child restraint system when the airbags are deployed. There is a risk of injury. Make sure that the front passenger airbags are deactivated and that the PASSENGER AIRBAG OFF indicator light illuminates.

Installing child restraint systems

General information

Pay attention to the specifications and the operating and safety information of the child restraint system manufacturer when selecting, installing, and using child restraint systems.

Safety information

Warning

The protective effect of child restraint systems and their fastening systems which have been damaged or exposed to an accident can be limited or lost. A child cannot be properly restrained in the event of an accident, braking or evasive maneuvers. There is a risk of injury or danger to life.

Do not use child restraint systems which have been damaged or exposed to an accident.

If attachment systems have been damaged or strained by an accident, have them checked and replaced by an authorized service center or another qualified service center or repair shop.

Warning

The stability of the child restraint system is limited or compromised with incorrect seat setting or improper installation of the child seat. There is a risk of injury or danger to life. Make sure that the child restraint system fits securely against the backrest. If possible, adjust the backrest tilt for all affected backrests and correctly adjust the seats. Make sure that seats and backrests are securely engaged or locked. If possible and necessary, adjust the height of the head restraints or remove them.

Before installation

Before installing child restraint systems, ensure that the rear seat backrests are locked.

Move the rear seats into the rearmost position to facilitate installation of the child restraint system.

Third row of seats

Before installing a child restraint system in the third row of seats, depending on the equipment, note the following:

- ▶ Roll up the cargo cover and remove the case.
- ▶ Remove the cargo area partition net.
- ▶ Bring seats and backrests of the second row of seats into the most forward position.
- ▶ Raise the head restraints of the third row of seats into the highest position.

Do not change the settings that have been made after this.

On the front passenger seat

Deactivating the airbags

Warning

Active front passenger airbags can injure a child in a child restraint system when the airbags are deployed. There is a risk of injury. Make sure that the front passenger airbags are deactivated and that the PASSENGER AIRBAG OFF indicator light illuminates.

Before installing a child restraint system in the front passenger seat, make sure that the front, knee and side airbags on the passenger's side are deactivated.

Additional information:

For automatic deactivation of front passenger airbags, refer to page [180](#).

Seat position and height

After installing a child restraint system, move the front passenger seat as far back as it will go and, if possible, bring it up to the highest position. This seat position and height ensure the best possible position for the belt and offers optimal protection in the event of an accident.

After mounting a universal child restraint system, adjust the tilt of the seat backrest so that the belt is not constrained.

If the upper attachment point of the seat belt is located in front of the seat belt guide of the child seat, move the front passenger seat carefully forward until the best possible seat belt guide position is reached.

Backrest width

Adjustable backrest width: Before installing a child restraint system on the front passenger seat, open the backrest width completely. Do not change the backrest width again and do not call up a memory position.

Child seat security



The seat belts in the rear and the front passenger seat belt can be permanently locked to fasten child restraint systems.

Locking the seat belt

1. Pull out the seat belt strap completely.
2. Secure the child restraint system with the seat belt.
3. Allow the seat belt strap to be pulled in and pull it tight against the child restraint system. The seat belt is disabled.

Unlocking the seat belt

1. Unbuckle the seat belt buckle.
2. Remove the child restraint system.
3. Allow the seat belt strap to be pulled in completely.

LATCH child restraint system

General information

LATCH: Lower Anchors and Tether for Children.

Pay attention to the specifications, operating tips and safety instructions from the child restraint system manufacturer when selecting, installing, and using LATCH child restraint systems.

Mounts for lower anchors

General information

The lower anchors may be used to attach the CRS to the vehicle seat up to a combined child and CRS weight of 65 lbs/30 kg when the child is restrained by the internal harnesses.

Safety information

Warning

If the lower anchors on child restraint system are not engaged correctly, the child restraint system will not be able to provide suitable protection. There is a risk of injury or danger

to life. Make sure that the lower anchors are correctly engaged and that the child restraint system fits securely against the backrest.

Warning

The mounts for the lower anchors and attachment points of the child restraint system are intended for attaching child restraint systems only. If other objects are attached, the mounts or attachment points can be damaged. There is a risk of injury or risk of damage to property. Only attach child restraint systems at the corresponding mounts for the lower anchors or attachment points.

Position

Icon	Meaning
	<p>The corresponding icon shows the mounts for the lower LATCH anchors.</p> <p>Seats equipped with lower anchors are marked with a pair (2) of LATCH icons.</p> <p>For vehicles equipped with a middle seat:</p> <p>It is not recommended to use the inner lower anchors of standard outer LATCH positions to fasten a child restraint system on the middle seat. Use the vehicle seat belt instead for the middle seat.</p>

Before attaching child restraint systems

Pull the seat belt away from the area of the child seat mountings.

Installing child restraint systems

1. Mount child restraint system, see manufacturer's information.
2. Make sure that the child restraint system mount is correctly engaged in the lower anchor on both sides.

With comfort rear seats: installation of child restraint systems

To facilitate installation, you may need to change additional settings:

1. Tilt the backrest slightly backward.
2. Mount child restraint system, see manufacturer's information.
3. Make sure that the child restraint system mount is correctly engaged in the lower anchor on both sides.
4. After installation, move the backrest back up slightly so that the child restraint system rests lightly against the backrest.

Child restraint systems with tether strap

General information

When attaching child restraint systems to the upper attachment points, observe the specifications and the operating and safety information of the child restraint system manufacturer.

Safety information

Warning

If the upper retaining strap is incorrectly used for the child restraint system, the protective effect is reduced. There is a risk of injury. Ensure that the upper retaining strap is guided to the upper attachment point without twisting and not over sharp edges.

Warning

If the rear seat backrest is not locked, the protective effect of the child restraint system is limited or nonexistent. In certain situations, for instance braking maneuvers or in case of an accident, the rear seat backrest can fold forward. There is a risk of injury or danger to life. Make sure that the rear seat backrests are locked.

Warning

The mounts for the lower anchors and attachment points of the child restraint system are intended for attaching child restraint systems only. If other objects are attached, the mounts or attachment points can be damaged. There is a risk of injury or risk of damage to property. Only attach child restraint systems at the corresponding mounts for the lower anchors or attachment points.

Attachment points for upper retaining strap

Icon	Meaning
	<p>The respective icon shows the attachment point for the upper retaining strap. Seats with an upper top tether are marked with this icon. It is located on the rear seat backrest, the rear shelf or the rear seat.</p>

Routing the retaining strap

With seven seats, or third row of seats with six seats:

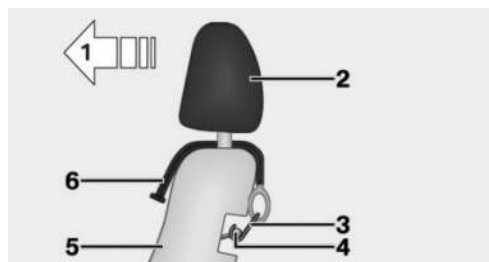

- 1 Driving direction
- 2 Head restraint
- 3 Hook for upper retaining strap
- 4 Attachment point
- 5 Seat backrest
- 6 Upper retaining strap

With six seats, second seat row:

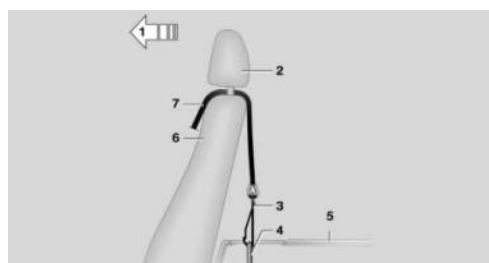

- 1 Driving direction
- 2 Head restraint
- 3 Hook for upper retaining strap
- 4 Attachment point
- 5 Floor
- 6 Seat backrest
- 7 Upper retaining strap

Attaching the upper retaining strap to the attachment point

1. Bring the seat of the second seat row into the base position.
Reset to base position, refer to page 109.
2. Raise the head restraint, if needed.

3. Guide the upper retaining strap between or along both sides of the supports for the head restraint to the attachment point.
Middle seat: raise the head restraint, if needed, press the button on the mounts for this purpose. Guide the upper retaining strap between or along both sides of the supports of the head restraint to the attachment point.
4. If there is a retaining strap, run it between the backrest and the cargo cover.
5. Attach the hook of the retaining strap to the attachment point.
6. Tighten the retaining strap.

Locking the doors and windows in the rear

General information

In certain situations it may be advisable to secure the rear doors and windows, for instance when transporting children.

Doors



Push the locking lever on the rear doors up.

The door can now be opened from the outside only.

After locking, make sure that the door cannot be opened from the inside.

Safety switch for rear

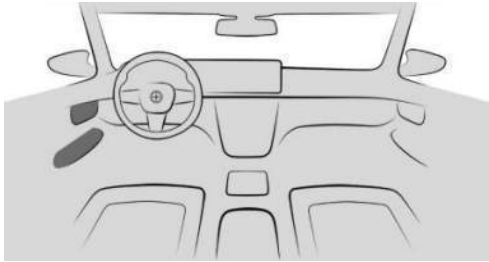

Press the button on the driver's door. Various functions are locked and cannot be operated in the rear such as the power windows.

Driving

Vehicle features and options

This chapter describes model-specific equipment, systems, and functions that are currently available, or may become available in the future, even if they are not present in the vehicle.

Additional information:

Vehicle equipment, refer to page 8.



The Start/Stop button is located on the center console.

Driving off

1. Turn on drive-ready state.
2. Apply gear position.
3. Driving off.

When stopping

Selector lever positions D, S, or R

On inclines, the system prevents rolling back against the set driving direction and provides drive-off support.

Driving off

Press the accelerator pedal to drive off.

The parking brake is released automatically.

Depending on the load and driving situation or when a trailer is used, the vehicle may roll back slightly.

Acoustic pedestrian protection

Depending on vehicle equipment and national-market version, Acoustic Pedestrian Protection generates a continuous driving noise in vehicles with electric or electrically assisted drives.

- ▶ With a stationary vehicle and drive-ready state turned on, as soon as the selector lever position P is exited.
- ▶ With electric driving up to approx. 20 mph/30 km/h.

A speaker system broadcasts the noise to the environment. As a result, other road users, for instance pedestrians or cyclists, can better perceive the vehicle.

Start/Stop button

Principle

Pressing the Start/Stop button turns drive-ready state on/off.

General information

Drive-ready state turns on when the brake pedal is pressed while pushing the Start/Stop button.

Pressing the Start/Stop button again turns drive-ready state back off and turns standby state back on.

Additional information:

- ▶ Drive-ready state, refer to page 42.
- ▶ Standby state, refer to page 41.

Overview

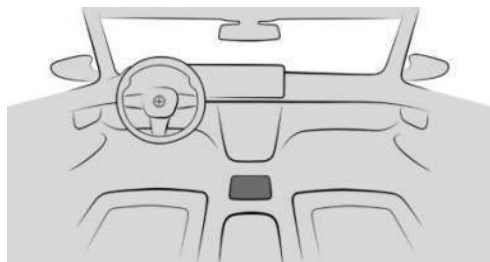

Auto Start/Stop function

Principle

The Auto Start/Stop function helps save fuel. The system switches off the engine during a stop, for instance in traffic jam or at traffic lights. Drive-ready state remains switched on. The engine starts automatically for driving off.

General information

The Auto Start/Stop function switches to standby whenever the engine is started using the Start/Stop button.

The function is activated at low speeds.

Engine stop

Functional requirements

The engine is switched off automatically when stopping under the following conditions:

- ▷ The selector lever is in selector lever position D.
- ▷ The brake pedal remains depressed while the vehicle is at a standstill or the vehicle is held by Automatic Hold.
- ▷ The driver's seat belt is buckled or the driver's door is closed.

Manual engine stop

If the engine was not switched off automatically when the vehicle stopped, the engine can be switched off manually:

- ▷ Depress the brake pedal forcefully again from the current pedal position.
- ▷ Engage selector lever position P.

When all functional preconditions are fulfilled, the engine switches off.

Air conditioning system when the engine is switched off

The air flow from the air conditioning system is reduced when the engine is switched off.

Display in the instrument cluster



The display in the instrument cluster indicates that the Auto Start/Stop function is ready for an automatic engine start.

Functional limitations

The engine does not switch off automatically in situations like the following:

- ▷ In case of a steep downhill grade.
- ▷ Brake pedal was not depressed hard enough.
- ▷ When the ambient temperature is high and automatic climate control is switched on.
- ▷ Vehicle interior has not yet been heated or cooled as desired.
- ▷ When window condensation is possible and automatic climate control is switched on.
- ▷ Engine or other components are not at operating temperature.
- ▷ Engine cooling is required.
- ▷ Vehicle battery is deeply discharged.
- ▷ At higher elevations.
- ▷ The hood is unlocked.
- ▷ For stop-and-go traffic.
- ▷ After driving in reverse.
- ▷ Without Mild Hybrid technology: Wheels are at a sharp angle or steering wheel is being turned.
- ▷ Hill Descent Control is activated.
- ▷ xOFFROAD driving mode is on.
- ▷ Selector lever position is S or R.

Starting the engine

Functional requirements

The engine starts automatically under the following preconditions:



- ▶ By releasing the brake pedal.
- ▶ When Automatic Hold is activated: step on the accelerator pedal.

Driving off

Accelerating as usual after starting the engine.

Safety mode

After the engine switches off automatically, it will not start again automatically if any one of the following conditions are met:

- ▶ The driver's seat belt is unbuckled and the driver's door is open.
- ▶ Hood was unlocked.

Some indicator lights illuminate for a varied length of time.

The engine can only be started using the Start/Stop button.

System limits

Even if driving off was not intended, the deactivated engine starts up automatically in the following situations:

- ▶ Vehicle interior is extremely hot when the cooling is on.
- ▶ Vehicle interior is extremely cold when the heating is on.
- ▶ When window condensation is possible and automatic climate control is switched on.
- ▶ Without mild hybrid technology:
In case of a steering operation.
- ▶ When changing the selector lever position from D or P to R.
- ▶ In case of seriously discharged vehicle battery.
- ▶ When starting an oil level measurement.

Deactivating the system manually

Principle

In certain driving situations, e.g., traffic jams, it may be helpful to deactivate Auto Start/Stop manually. The engine will then no longer switch off automatically.

If this function is deactivated while the engine is being stopped automatically, the engine will start.

Depending on vehicle equipment: Via button

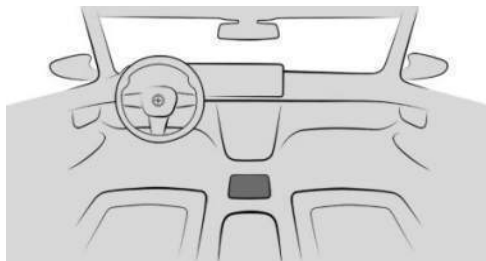

Press the button.

- ▶ LED is illuminated: Auto Start/Stop function is deactivated.
- ▶ LED off: Auto Start/Stop function is enabled.

Depending on vehicle equipment: Via iDrive

1. Apps menu
2. "Vehicle"
3. "Driving settings"
4. "Drivetrain and chassis"
5. "Auto Start/Stop"
6. Select the desired setting.

Via selector lever position

The Auto Start/Stop function is also disabled in selector lever position S.

Via the Driving Experience Control

The Auto Start/Stop function is also deactivated in SPORT driving mode of the Driving Experience Control.

Switching off the vehicle during an automatic engine stop

If the engine stops automatically, the vehicle can be parked safely, for example to leave it.

1. Press the Start/Stop button.
 - ▶ Drive-ready state is switched off.
 - ▶ Standby state is switched on.
 - ▶ Selector lever position P is engaged automatically.
2. Set the parking brake.

Automatic deactivation

In certain situations, the Auto Start/Stop function is deactivated automatically for safety reasons, for instance if no driver is detected.

Malfunction

The Auto Start/Stop function no longer switches off the engine automatically. A Check Control message is displayed. You may continue driving. Have the vehicle checked by an authorized service center or another qualified service center or repair shop.

Steptronic transmission

Principle

The Steptronic transmission is the vehicle's automatic transmission. With shift paddles, it offers the option of manual shifting if needed.

Safety information

Warning

An unsecured vehicle can begin to move and possibly roll away. There is a risk of accident, injury, and property damage. Before leaving your vehicle, secure it against rolling away, e.g., by applying the parking brake.

Selector lever positions

Gear position D

Selector lever position for normal driving. All gears for forward travel are activated automatically.

R reverse gear

Engage selector lever position R only when the vehicle is stationary.

N Neutral

The vehicle may be pushed or roll without drive, for instance in car washes, in selector lever position N.

Parking position P

General information

Selector lever position, for instance for parking the vehicle. The transmission blocks the drive in selector lever position P.

Engage selector lever position P only when the vehicle is stationary.

P is engaged automatically

Selector lever position P is engaged automatically in situations such as the following:



- ▶ After drive-ready state is switched off, if selector lever position R, D, or S is engaged.
- ▶ After standby is switched off, if selector lever position N is engaged.
- ▶ The driver's seat belt is unbuckled and the driver's door is opened while the vehicle is stationary and selector lever position D, S, or R is engaged.

Before exiting the vehicle, make sure that selector lever position P is engaged and the parking brake is engaged. Otherwise, the vehicle may begin to move.

Additional information:

Parking brake, refer to page 140.

Engaging selector lever positions

General information

To prevent the vehicle from creeping after you select a gear position or reverse gear, maintain pressure on the brake pedal until you are ready to drive off.

Functional requirements

Only when the drive-ready state is switched on and the brake pedal is depressed is it possible to change from selector lever position P to another selector lever position.

The selection lever position P cannot be changed until all technical prerequisites are met.

Engaging selector lever position D, N, R

1. Fasten driver's seat belt.
2. Tilt or pull the selector lever into the desired direction, past a resistance point, if needed.

The selector lever automatically returns to the center position when released.

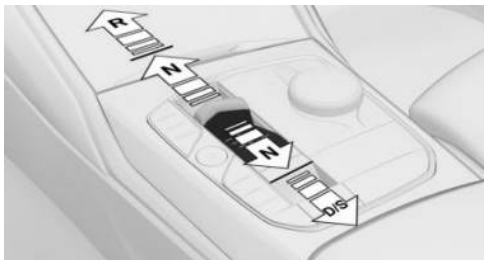

Engaging selector lever position P



Press the button.

The parking brake is applied and the transmission lock is engaged.



Press button P.

The transmission lock is engaged.

Rolling or pushing the vehicle

General information

In some situations, the vehicle is supposed to roll without its own drive for a short distance, for instance in a car wash or to be pushed.

Engaging selector lever position N

NOTICE

Selector lever position P is automatically engaged when standby state is switched off. The wheels are blocked. There is a risk of property damage. Do not switch off standby if the vehicle is meant to coast, e.g., in a car wash.

1. Switch on drive-ready state while pressing on the brake pedal.
2. If necessary, release the parking brake and switch off Automatic Hold.
3. Depress the brake pedal.
4. Engage selector lever position N.
5. Switch off drive-ready state.

In this way, standby state remains switched on, and a Check Control message is displayed.

The vehicle can roll.

Selector lever position P is engaged automatically after approximately 35 minutes.

If the system is not operational, you may not be able to change the selector lever position.

Electronically unlock the transmission lock, if needed.

Additional information:

Electronic unlocking of the transmission lock, refer to page [136](#).

Kickdown

Kickdown is used to achieve maximum driving performance.

Step on the accelerator pedal beyond the resistance point at the full throttle position.

S Sport mode

Principle

The shifting points and shifting times in the Sport program are designed for sportier handling. The transmission, for instance shifts up later and the shifting times are shorter.

Activating the Sport program



Pull the selector lever from selector lever position D to D/S.

The engaged gear is displayed in the instrument cluster, for instance S1.

The sport program of the transmission is activated.

Ending the Sport program

Pull the selector lever to D/S.

D is displayed in the instrument cluster.

Displays in the instrument cluster

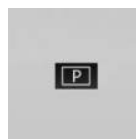

The selector lever position is displayed, for example P.

Electronic unlocking of the transmission lock

General information

Unlock the transmission lock electronically, e.g., to maneuver the vehicle out of a hazardous area in the event of a malfunction.

Before unlocking the transmission lock, secure the vehicle against rolling away, for instance with a wheel chock.

Engaging selector lever position N

1. Quickly press the Start/Stop button three times without pressing the brake.
2. Depress the brake pedal.
3. Press the selector lever to position N until position N is shown on the selector lever.
An appropriate Check Control message is displayed.
4. Maneuver the vehicle from the hazardous area and secure it against rolling away.

Shift paddles

Principle

The shift paddles on the steering wheel are used to change gears manually.

General information

Shifting

The vehicle only shifts at suitable RPM and road speeds.

Even in manual mode, the transmission shifts automatically in certain situations, e.g., when speed limits are reached.

Temporary manual mode

In selector lever position D, pulling a shift paddle switches into manual mode temporarily.

The engaged gear is also displayed in the instrument cluster, for instance D1.

After conservative driving in manual mode without acceleration or shifting via the shift paddles for a certain amount of time, the transmission switches back to automatic mode.

It is possible to switch into automatic mode:

- ▶ Pull and hold the right shift paddle until D is displayed in the instrument cluster.
- ▶ In addition to the pulled right shift paddle, pull the left shift paddle.

Continuous manual mode

In Sport program S, pulling a shift paddle switches to manual mode M permanently.

The engaged gear is displayed in the instrument cluster, for instance M1.

It is possible to switch into automatic mode:

- ▶ Pull and hold the right shift paddle until S is displayed on the instrument cluster.
- ▶ In addition to the pulled right shift paddle, pull the left shift paddle.
- ▶ Pull the selector lever to D/S.

When M2 is set manually while the vehicle is stationary, the transmission will no longer shift back to M1. This shift behavior is maintained until M1 is engaged manually or manual mode M is exited.

Shifting



- ▶ Upshifting: pull the right shift paddle.
- ▶ Downshifting: pull left shift paddle.

The selected gear is briefly displayed in the instrument cluster, followed by the current gear.

Advanced mode

General information

Depending on vehicle equipment, the Steptronic transmission offers an advanced mode with adapted shift characteristics.

- ▷ Automatic downshift to lowest possible gear.

If the left shift paddle is pulled and held, the Steptronic transmission automatically shifts down to the lowest possible gear.

- ▷ Avoid automatic upshifting in manual mode.

In manual mode, the Steptronic transmission does not shift up automatically when speed limits are reached.

- ▷ There is no downshifting for kickdown.

Enabling advanced mode

The advanced mode is enabled in manual mode when Dynamic Stability Control is disabled.

Depending on vehicle equipment, the advanced mode can also be enabled in manual mode as follows, for example:

- ▷ "SPORT PLUS": Driving mode is selected.
- ▷ Dynamic Traction Control is activated.

Launch Control

Principle

Launch Control enables optimum acceleration on roads with good traction under dry surrounding conditions.

General information

Using Launch Control causes premature component wear since this function represents a very heavy load for the vehicle.

Do not turn the steering wheel when driving off with Launch Control.

Do not use Launch Control when breaking in the vehicle.

Additional information:

Break-in, refer to page 328.

Functional requirement

Launch Control can be used when the engine is at operating temperature. The engine is at operating temperature after an uninterrupted trip of at least 6 miles/10 km.

Driving off with Launch Control

1. Turn on drive-ready state.
2. Activate drive mode: "SPORT".
3. Enabling the driving dynamics setting: "SPORT PLUS".
4. With the left foot, press down forcefully on the brake.
5. Engage forward gear.
6. Press the accelerator pedal all the way down and hold.
Launch Control information is displayed in the instrument cluster.
7. The starting engine speed adjusts. Wait briefly until the engine speed is constant. Keep the accelerator pedal in this position.
8. Release the brake within a few seconds of the Launch Control information illuminating.
The vehicle accelerates.
Upshifting is performed automatically as long as the Launch Control information is displayed and the accelerator pedal is not released.



Launch Control stays on as long as the Launch Control information is displayed and the accelerator pedal is not released.

Repeated use during a trip

After Launch Control has been used, the transmission must cool down for a short time before Launch Control can be used again. Launch Control adjusts to the surrounding conditions when used again.

After using Launch Control

To support driving stability, reactivate Dynamic Stability Control as soon as possible.

System limits

An experienced driver may be able to achieve better acceleration values in DSC OFF without Launch Control mode.

Steptronic Sport transmission: sprint function

Principle

Depending on the equipment, the Sprint function can be used for an upcoming acceleration process. The Sprint function prepares the drivetrain for the acceleration process.

General information

When the Sprint function is activated, the response characteristics of the vehicle will become more dynamic.

Activating

1. Keep the left shift paddle pulled until SPRINT is displayed in the instrument cluster.

- ▶ The transmission shifts down to the lowest possible gear and switches to manual operation M.
- ▶ A dynamic setting has been activated for the drivetrain.

2. Change gears manually.

Automatic deactivation

The Sprint function is ended automatically when driving moderately for a defined period of time.

Manual deactivation

- ▶ Keep the right shift paddle pulled until SPRINT is no longer displayed in the instrument cluster.
- ▶ In addition to the pulled right shift paddle, pull the left shift paddle.
- ▶ Press the selector lever from selector lever position S to D.

Driving Experience Control

Principle

The Driving Experience Control influences, among other things, the vehicle's driving dynamics.

The vehicle can be adjusted depending on the situation using various driving modes.

General information



The following systems may be affected, for instance:

- ▶ Drivetrain.
- ▶ Chassis.
- ▶ Steering.
- ▶ Display in the instrument cluster.
- ▶ Cruise control.

Overview

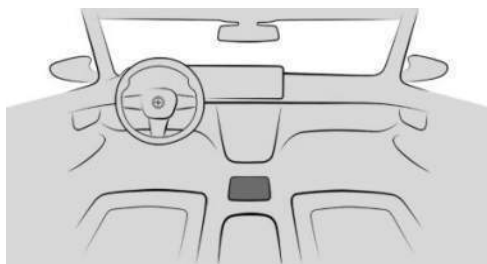
Buttons in the vehicle



Button	Driving mode
	SPORT SPORT PLUS SPORT INDIVIDUAL
	COMFORT
	ECO PRO ECO PRO INDIVIDUAL

Displays in the instrument cluster



The selected driving mode is displayed in the instrument cluster.

Activating/deactivating drive modes

Press the button for the desired drive mode repeatedly until the desired drive mode is displayed in the instrument cluster.

When changing the drive mode, the current drive mode is deactivated.

Driving modes in detail

COMFORT

The COMFORT driving mode is a balanced setting between sporty and consumption-optimized driving.

SPORT

The SPORT driving mode is a dynamic setting for more agility with an optimized suspension.

SPORT PLUS

The SPORT PLUS driving mode is a dynamic setting for maximum agility with an adjusted drive.

ECO PRO

In ECO PRO driving mode, consumption is optimized.

INDIVIDUAL configuration

General information

For some driving modes, there is another mode that can be adjusted individually.

The individual configuration set last is activated directly when the driving mode is called up again.

Configuring and resetting

E.g., ECO PRO INDIVIDUAL drive mode:

-  Apps menu
 - "Vehicle"
 - "Driving settings"
 - "Drivetrain and chassis"
 - "ECO PRO INDIVIDUAL"
 - Select the desired setting.
- Reset ECO PRO INDIVIDUAL to the standard settings:
"Reset to ECO PRO STANDARD"

Enabling INDIVIDUAL

Press the button for the desired driving mode several times.

My Programs

Principle

Various vehicle functions in the vehicle interior are adapted to each other in a program.

When a program is selected, for example, the interior lighting, climate control, and music selection are adjusted.

Safety information

Warning

People or animals in the vehicle can lock the doors from the inside and lock themselves in. In this case, the vehicle cannot be opened from the outside. There is a risk of injury. Take the vehicle key with you so that the vehicle can be opened from the outside.

Warning

For some national-market versions, unlocking from the inside is only possible with particular knowledge.

If persons or animals spend a lengthy time in the vehicle and are thereby exposed to extreme temperatures, there is a risk of injury or danger to life. Do not lock the vehicle from the outside when there are people or animals in it. Do not leave babies, toddlers or animals alone in the vehicle.

My Programs in detail

My Programs	Description
"REAR SEAT VIEW"	This program creates an atmosphere that encourages sleep for children in the rear.

Activating/deactivating My Programs

1.  Apps menu
2. "All apps"
3. "REAR SEAT VIEW"

Parking brake

Principle

The parking brake is used to prevent the vehicle from rolling away when it is parked.

Safety information

Warning

An unsecured vehicle can begin to move and possibly roll away. There is a risk of accident, injury, or property damage. Before leaving the vehicle, secure the vehicle against rolling away.

In order to ensure that the vehicle is secured against rolling away, follow the following:

- ▷ Set the parking brake.
- ▷ On uphill grades or on downhill slopes, turn the front wheels in the direction of the curb.
- ▷ On uphill grades or on downhill slopes, also secure the vehicle, for instance with a wheel chock.

Warning

Unattended children or animals in the vehicle can cause the vehicle to move and endanger themselves and traffic, for example, due to the following actions:

- ▷ Establishing standby.
- ▷ Releasing the parking brake.
- ▷ Opening and closing the doors or windows.
- ▷ Engaging selector lever position N.
- ▷ Using vehicle equipment.

There is a risk of accident, injury, and property damage. Do not leave children or animals unattended in the vehicle. Take the vehicle key with you when exiting and lock the vehicle.

Overview

Button in the vehicle

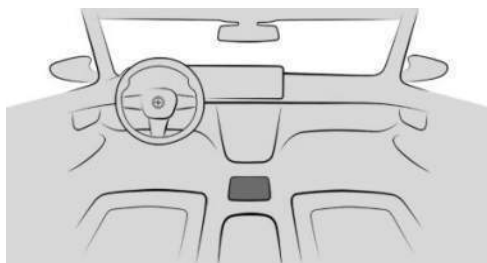

Parking brake

Setting the parking brake

With a stationary vehicle

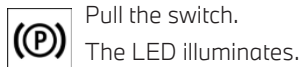

Pull the switch.

The LED illuminates.



The indicator light in the instrument cluster illuminates red.

The parking brake is set.

While driving

Use while driving serves as an emergency braking function.



Pull the switch and hold it. The vehicle brakes hard while the switch is being pulled.



The indicator light in the instrument cluster illuminates red, a signal sounds, and the brake lights illuminate.

A Check Control message is displayed.

The parking brake is engaged when the vehicle is stationary.

Engaging the parking brake automatically

In some situations, the parking brake is engaged automatically, e.g., through Automatic Hold.

Additionally, the system can be set to automatically engaging the parking brake when the drive-ready state is turned off.

1.  Apps menu
2. "Vehicle"
3. "Driving settings"
4. "Drivetrain and chassis"
5. "Parking brake"
6. Select the desired setting.

In selector lever position N, the parking brake will not be engaged automatically.

Releasing the parking brake

Releasing the parking brake manually

1. Turn on drive-ready state.

2.  Press the switch while stepping on the brake pedal or selector lever position P is set.

The LED and the indicator light go out.

The parking brake is released.

Releasing the parking brake automatically

The parking brake is released automatically when you drive off.

The LED and the indicator light go out.

Using the parking brake via iDrive

The parking brake can also be engaged or disengaged via iDrive. Additionally, further information is displayed.

1.  Apps menu
2. "Vehicle"
3. "Driving settings"
4. "Drivetrain and chassis"
5. "Parking brake"
6. Select the desired setting.

Malfunction

If the parking brake fails or malfunctions, secure the vehicle so that it does not roll away before you exit.

A Check Control message is displayed.

Secure the vehicle against rolling away, for instance with a wheel chock, after getting out of the vehicle.

After a power interruption

To reestablish parking brake operability after a power interruption, an initialization may be required.

1. Turn on standby state.

2.  Pull the switch while stepping on the brake pedal or selector lever position P is set and then push.

This process may take a few seconds. Some mechanical sounds associated with this process are normal.



The indicator light is no longer illuminated as soon as the parking brake is ready for operation again.

Automatic Hold

Principle

Automatic Hold assists the driver by automatically applying and releasing the brake, for example, in stop-and-go traffic.

The vehicle is automatically held in place when it is stationary.

On uphill grades the system prevents the vehicle from rolling back when driving off.

General information

The parking brake is automatically engaged under the following conditions:

- ▶ If drive-ready state is turned off.
- ▶ The driver's door is open for more than one second and no pedal is pressed during this time.
- ▶ If the parking brake is used to brake the vehicle to a stop while driving.

In selector lever position N, Automatic Hold is temporarily deactivated.

Safety information

Warning

An unsecured vehicle can begin to move and possibly roll away. There is a risk of accident, injury, or property damage. Before leaving the vehicle, secure the vehicle against rolling away.

In order to ensure that the vehicle is secured against rolling away, follow the following:

- ▷ Set the parking brake.
- ▷ On uphill grades or on downhill slopes, turn the front wheels in the direction of the curb.
- ▷ On uphill grades or on downhill slopes, also secure the vehicle, for instance with a wheel chock.

Warning

Unattended children or animals in the vehicle can cause the vehicle to move and endanger themselves and traffic, for example, due to the following actions:

- ▷ Establishing standby.
- ▷ Releasing the parking brake.
- ▷ Opening and closing the doors or windows.
- ▷ Engaging selector lever position N.
- ▷ Using vehicle equipment.

There is a risk of accident, injury, and property damage. Do not leave children or animals unattended in the vehicle. Take the vehicle key with you when exiting and lock the vehicle.

Overview

Button in the vehicle

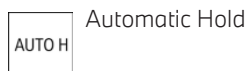
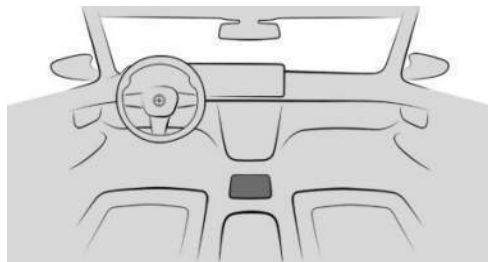

Activating Automatic Hold

1. Turn on drive-ready state.

2.  Press the button.
The LED illuminates.

 The indicator light illuminates green.
Automatic Hold is activated.

After every vehicle restart, the last selected setting is active.

Automatic Hold holding the vehicle

Automatic Hold is activated and the driver's door is closed.

 After stopping, the vehicle is automatically secured against rolling away as soon as the indicator light illuminates green.

Driving off

Press the accelerator pedal to drive off.

The brake is released automatically and the indicator light of the parking brake is no longer illuminated.



Automatic parking brake application

The parking brake is automatically set if drive-ready state is switched off while the vehicle is being held by Automatic Hold or if the vehicle is exited.



The indicator light changes from green to red.

The parking brake is not set automatically if the drive-ready state was switched off while the vehicle was coasting. Automatic Hold is temporarily deactivated in this case.

Deactivate Automatic Hold



Press the button.
The LED goes out.



The indicator light goes out.

Automatic Hold is switched off.

If the vehicle is being held by Automatic Hold, also press on the brake pedal when switching off.

Displays

Vehicle features and options

This chapter describes model-specific equipment, systems, and functions that are currently available, or may become available in the future, even if they are not present in the vehicle.

Additional information:

Vehicle equipment, refer to page [8](#).

Instrument cluster

Principle

The instrument cluster comprises various digital displays, e.g., a speedometer, time, range, temperature as well as indicator and warning lights.

General information

The layout of the instrument cluster adapts to the respective driving mode. The positions of some displays may vary, e.g., the selector lever display.

Some of the displays in the instrument cluster may differ from the illustrations in the Owner's Manual.

Safety information

Warning

If the driving information displays on the instrument cluster fail, e.g., the speedometer, do not use the vehicle. There is a risk of accident, injury, and property damage. Immediately park the vehicle in a safe manner.

Turning drive-ready state off and on again may correct the malfunction, allowing you to continue driving. If the malfunction cannot be corrected, have the vehicle checked by an au-

thorized service center or another qualified service center or repair shop.

Overview

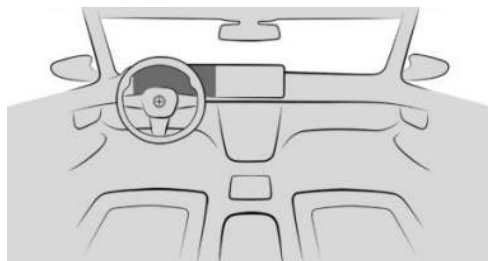

Instrument cluster

Display ranges on the instrument cluster

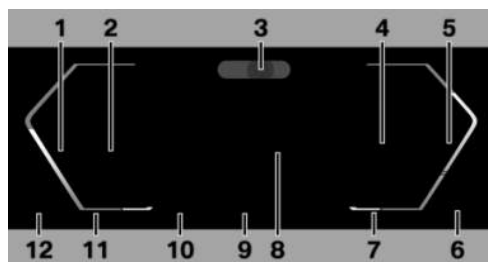



- 1 Speedometer
- 2 Driver assistance systems [222](#)
Parking assistance systems [249](#)
- 3 Driver Attention Camera [215](#)
- 4 Check Control [148](#)
Selector lever display [133](#)
Gear shift indicator [156](#)
Selection lists [155](#)
- 5 Power gauge [156](#)
Tachometer [157](#)
- 6 Engine temperature [158](#)

- 7 Outside temperature 158
- 8 Central display range 159
 - Shift lights 159
- 9 Drive mode 138
- 10 Speed Limit Info 222
 - Speed Limit Assistant 243
- 11 Time 162
- 12 Fuel gauge 163
 - Range 163

Additional information:

Indicator/warning lights, refer to page 149.

Operating elements on the steering wheel

Operating element	Function
	Display the menu bar on the instrument cluster.
	Press the corresponding arrow key to move the selection.
	Turn knurled wheel: scroll selection up or down. Press knurled wheel: confirm selection.

Configuring the layout

In COMFORT drive mode, the layout in the instrument cluster can be individually configured and displayed.

1.  Press the button on the steering wheel.
A menu bar is displayed in the instrument cluster.
2. "LAYOUT"

3. Select the menu using the arrow buttons on the steering wheel where applicable.
3. Select the desired setting using the knurled wheel on the steering wheel.

Settings

Specific displays can be configured individually, e.g., a second actual speed.

1.  Apps menu
2. "Vehicle"
3. "Displays"
4. "Instrument cluster"
5. Select the desired setting.

Live Vehicle

Principle

Live Vehicle is a virtual representation of your own vehicle with different information, e.g., vehicle status or energy flow indicators.

General information

Appropriate information is shown on the control display depending on the driving situation. Fault statuses are not taken into account.

Adaptive content

The following content is displayed in alternating order and, if necessary, depending on the selected drive mode:

- ▶ Vehicle status, refer to page 163.
- ▶ Current driving condition, refer to page 164.
- ▶ Sport displays, refer to page 164.
- ▶ Efficiency trainer, refer to page 344.
- ▶ Trip data, refer to page 160.
- ▶ xOFFROAD display, refer to page 282.



Static information

The following information may be shown permanently on the control display regardless of the driving situation and driving mode set.

- ▷ Vehicle status.
- ▷ Trip data.
- ▷ xVIEW display, refer to page 218.
- ▷ xOFFROAD display.

Adjusting the display

In the Live Vehicle menu, you can choose between an adaptive display and static content.

1.  Apps menu
2. "Vehicle"
3. "Live Vehicle"
4. "Content"
5. Select the desired setting.

BMW Head-up display

Principle

The Head-up display projects important information, e.g., speed, onto the windshield in the driver's field of view. Information can be recorded without you having to look away from the road.

The steering wheel buttons can be used to configure various views for the Head-up display. Additional settings can be changed on the control display, e.g., brightness or height.

General information

Follow instructions for cleaning the Head-up display in the Vehicle Care chapter.

Additional information:

Caring for special components, refer to page 407.

Overview

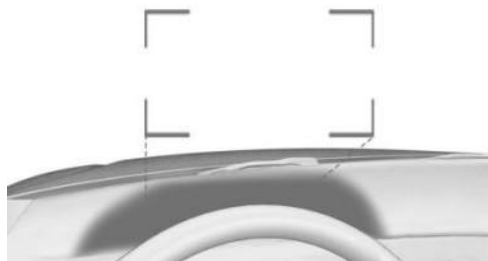

Head-up display views are projected onto the windshield through a protective glass. The protective glass is located between the steering wheel and windshield.

Displayable information

The following information is displayed on the Head-up display:

- ▷ Vehicle speed.
- ▷ Navigation instructions.
- ▷ Check Control messages.
- ▷ Sport displays.
- ▷ Shift lights.
- ▷ Efficiency trainer.
- ▷ Lists and messages.
- ▷ Driver assistance systems.

Some of this information is only displayed briefly as needed.

Configuring a view

The views for the Head-up display can be set independently of the display on the instrument cluster, e.g., a reduced view.

1.  Press the button on the steering wheel.
A menu bar is displayed in the instrument cluster.
2. "HEAD-UP"



Select the menu using the arrow buttons on the steering wheel where applicable.

3. Select the desired setting using the knurled wheel on the steering wheel.

Turning the Head-up display on/off

1. Apps menu
2. "Vehicle"
3. "Displays"
4. "Head-up display"
5. "Head-up display"

Settings

Individual settings can be entered for the Head-up display such as for the height, brightness or illustration. In addition, individual displays in the Head-up display can be set up separately such as for Driver Assistance.

1. Apps menu
2. "Vehicle"
3. "Displays"
4. "Head-up display"
5. Select the desired setting.

Visibility of the display

The visibility of the displays in the Head-up display is influenced by the following factors:

- ▷ Seat position.
- ▷ Objects on the Head-up display's protective glass.
- ▷ Dust or dirt on the Head-up display's protective glass.
- ▷ Windshield dirty on inside or outside.
- ▷ Sunglasses with certain polarization filters.
- ▷ Wet road.
- ▷ Unfavorable light conditions.

If the image is distorted, have the basic settings checked by an authorized service center or another qualified service center or repair shop.

Special windshield

The windshield is part of the system.

The shape and coating of the special windshield enable the system to function.

If damaged, have the special windshield replaced by an authorized service center or another qualified service center or repair shop.

Check Control

Principle

The Check Control system monitors functions in the vehicle and notifies you of faults in the monitored systems.

A Check Control message is displayed as a combination of indicator lights or warning lights and text messages on the instrument cluster and, if applicable, on the Head-up display. In addition, an acoustic signal may sound and a text message may appear on the control display.

Some Check Control messages are hidden automatically after approx. 20 seconds, but they will be stored. Stored Check Control messages can be displayed on the control display. Urgent Check Control messages are permanently displayed but may be hidden temporarily.

Hiding Check Control messages

Permanently displayed Check Control messages can be hidden temporarily. These messages are automatically displayed again after approx. 8 seconds.

◀ An arrow icon next to the Check Control message indicates whether the Check Control message can be hidden.



To hide Check Control messages, press the left arrow button on the steering wheel.

Displaying stored Check Control messages

Additional information such as the cause of a fault or the required action can be called up via Check Control.

Depending on the Check Control message, further help can be selected.

1.  Apps menu
2. "Vehicle"
3. "Vehicle status"
4. "Check Control"
5. Select the desired text message.

Display

A Check Control message is displayed in the instrument cluster as a text message with an icon.

For urgent messages, an added text is automatically displayed on the control display.

If several faults occur at once, the messages are displayed consecutively.

Certain messages displayed while driving are displayed again after drive-ready state is switched off.



Icons in the instrument cluster indicate an active or saved Check Control message.



Indicator lights and warning lights

Principle

The indicator lights and the warning lights on the instrument cluster show the status of some functions in the vehicle. The indicator lights and warning lights indicate faults in monitored systems.

General information

Indicator lights and warning lights can illuminate in a variety of combinations and colors.

Several of the lights are checked for proper functioning and illuminate temporarily when drive-ready state is turned on.

Red lights

Seat belt reminder



Seat belt on the driver's seat is not buckled.

Additional information:

Seat belt reminder, refer to page [115](#).

Airbag system



Warning light illuminates briefly: Indicates that the entire airbag system and seat belt tensioners are operational when drive-ready state is switched on.

Warning light does not illuminate or illuminates continuously: the airbag system or the seat belt tensioners may not be operational. Have the vehicle checked immediately by an authorized service center or another qualified service center or repair shop.

Additional information:

Airbags, refer to page [178](#).

Parking brake



The parking brake is set.

Additional information:

Parking brake, refer to page [140](#).

Brake system



The brake pads are worn or there is another issue with the brake system.



The braking assistance may not be operational. A higher pedal force may be required for braking.

Have the vehicle checked immediately by an authorized service center or another qualified service center or repair shop.

Emergency Stop Assistant



The Emergency Stop Assistant is triggered.

Additional information:

Emergency Stop Assistant, refer to page [206](#).

Risk of collision



Warning light illuminates or flashes in conjunction with an acoustic signal if there is risk of imminent collision.

Additional information:

Forward Collision Mitigation, refer to page [183](#).

Pedestrian Warning



Warning light illuminates: risk of collision with a person, e.g., a pedestrian or a cyclist. Increased awareness is required.

Warning light flashes and a signal sounds: risk of imminent collision with a person, e.g., a pedestrian or a cyclist. Immediately initiate braking or an evasive maneuver.

Additional information:

Warning function for pedestrians, refer to page [188](#).

Forward Collision Warning



Warning light illuminates: risk of collision, e.g., with a vehicle, is detected. Increased awareness is required.

Warning light flashes and a signal sounds: risk of imminent collision with a vehicle detected. Immediately initiate braking or an evasive maneuver.

Additional information:

Warning function in rear-end collision situations, refer to page [186](#).

Intersection Collision Warning: vehicle detected from the right



Warning light illuminates: risk of collision with vehicle crossing from the right detected. Increased awareness is required.

Warning light flashes and a signal sounds: risk of imminent collision with a crossing vehicle detected. Immediately initiate braking or an evasive maneuver.

Additional information:

Warning function at intersections, refer to page [190](#).

Intersection Collision Warning: vehicle detected from the left



Warning light illuminates: risk of collision with vehicle crossing from the left detected. Increased awareness is required.

Warning light flashes and a signal sounds: risk of imminent collision with a crossing vehicle detected. Immediately initiate braking or an evasive maneuver.

Additional information:



Warning function at intersections, refer to page [190](#).

Distance Control



Warning light flashes and acoustic signal sounds: Brake and evade as necessary.

Additional information:

Distance Control, refer to page [229](#).

Assisted Driving Mode



Warning light flashes and acoustic signal sounds:

The system is switched off or will be interrupted very soon.

Warning light illuminates and acoustic signal sounds:

The driver's line of sight is not directed at the surrounding traffic. System interruption is imminent. The system reduces the speed to a standstill if applicable. It is possible that the system will not execute any supporting steering movements.

Additional information:

Assisted Driving Mode, refer to page [235](#).

Assisted Driving Mode: Hands are not on steering wheel



Warning light illuminates and acoustic signal sounds:

The hands are not on the steering wheel or, depending on the vehicle equipment and national-market version, the driver's line of sight is not directed at the surrounding traffic. System interruption is imminent.

The system reduces the speed to a standstill if applicable.

It is possible that the system will not execute any supporting steering movements.

Immediately grasp the steering wheel with your hands and pay attention to the surrounding traffic.

Additional information:

Assisted Driving Mode, refer to page [235](#).

Yellow lights

Antilock Braking System



The system may not be operational. The Antilock Braking System is not available.



The ability to steer may be restricted during full braking.

Have the vehicle checked immediately by an authorized service center or another qualified service center or repair shop.

Additional information:

Antilock Braking System, refer to page [216](#).

Assisted Driving Mode



Warning light illuminates and acoustic signal sounds: A system interruption is imminent.

Warning light flashes: A lane boundary has been crossed.

Additional information:

Assisted Driving Mode, refer to page [235](#).

Assisted Driving Mode: Hands are not on steering wheel



Hands are not grasping the steering wheel. The system is still active.

Grab the steering wheel with your hands.

Additional information:

Assisted Driving Mode, refer to page [235](#).



Dynamic Stability Control



Warning light flashes: Dynamic Stability Control is regulating the driving and brake power. The vehicle is stabilized.

Reduce the vehicle speed and adjust your driving style to the road conditions.

Warning light illuminates: Dynamic Stability Control has malfunctioned or is initializing.

Driving stabilization is restricted or has failed.

If the warning light illuminates continuously, have the vehicle checked immediately by an authorized service center or another qualified service center or repair shop.

Additional information:

Dynamic Stability Control, refer to page [216](#).

The Dynamic Stability Control deactivated or the Dynamic Traction Control activated



Dynamic Stability Control is deactivated or Dynamic Traction Control is activated.

Additional information:

- ▷ Dynamic Stability Control, refer to page [216](#).
- ▷ Dynamic Traction Control, refer to page [218](#).

Flat tire monitor



Warning light illuminates: Flat tire or tire pressure loss has been detected.

Reduce your speed and stop cautiously. Avoid sudden braking and steering maneuvers.

Additional information:

Flat tire monitor, refer to page [370](#).

Tire pressure monitor



Warning light illuminates: Flat tire or tire pressure loss has been detected. Follow the information in the Check

Control message.

Warning light flashes then illuminates continuously: Flat tires or tire pressure losses cannot be detected.

- ▷ Fault caused by systems or devices with the same radio frequency: after leaving the area of the interference, the system automatically becomes active again.
- ▷ In the case of tires with special approval: the tire pressure monitor was unable to complete the reset. Reset the system again.
- ▷ Wheel without wheel electronics installed: Have it checked by an authorized service center or another qualified service center or repair shop as needed.
- ▷ Malfunction: have the vehicle checked by an authorized service center or another qualified service center or repair shop.

Additional information:

Tire pressure monitor, refer to page [362](#).

Steering system



The steering system may not be operational.

Have the vehicle checked by an authorized service center or another qualified service center or repair shop.

Additional information:

Integral Active Steering, refer to page [221](#).

Exhaust emissions



▷ The warning light illuminates:

The exhaust gas quality is declining, e.g., because the fuel filler cap is

fitted incorrectly. Have the vehicle checked as soon as possible.

- ▶ The warning light flashes under certain circumstances:

This indicates that there is excessive misfiring in the engine.

Reduce the vehicle speed and have the vehicle checked immediately; otherwise, serious engine misfiring within a brief period can seriously damage emission control components, in particular the catalytic converter.

Have the vehicle checked by an authorized service center or another qualified service center or repair shop.

Additional information:

Socket for OBD on-board diagnostics, refer to page [389](#).

Acoustic pedestrian protection



Acoustic pedestrian protection has malfunctioned. Increased caution when maneuvering.

If malfunctioning repeatedly, have the vehicle checked by an authorized service center or another qualified service center or repair shop.

Additional information:

Acoustic pedestrian protection, refer to page [130](#).

Green lights

Turn signal



Turn signal is on.

Unusually rapid flashing of the indicator light indicates that a turn signal bulb has failed.

Additional information:

Turn signal, refer to page [166](#).

Parking lights



Parking lights are switched on.

Additional information:

Parking lights, low-beam headlights, refer to page [169](#).

Low-beam headlights



Low-beam headlights are switched on.

Additional information:

Parking lights, low-beam headlights, refer to page [169](#).

Automatic High Beam Assistant



Low-beam headlights are switched on and the Automatic High Beam Assistant is activated.

High-beam headlights are switched on and off automatically depending on the traffic situation.

Additional information:

Automatic High Beam Assistant, refer to page [167](#).

Lane departure warning



Depending on vehicle equipment and national-market version:

Indicator light flashes: the system is performing a steering intervention.

Additional information:

Lane departure warning, refer to page [193](#).

Automatic Hold: vehicle is held automatically



Automatic Hold is ready to use. The vehicle is automatically held in place when it is stationary.

Additional information:

Automatic Hold, refer to page [142](#).

Automatic Hold: vehicle secured against rolling away



The vehicle is automatically secured against rolling away after stopping.

Additional information:

Automatic Hold, refer to page [142](#).

Cruise Control



The system is active.

Additional information:

Cruise control, refer to page [226](#).

Distance Control



Indicator light illuminates: Vehicle has been detected ahead of you. The vehicle icon goes out if no vehicle has been detected ahead of you.

Indicator light flashes: Preceding vehicle has driven off.

Additional information:

Distance Control, refer to page [229](#).

Speed Limit Assist



The detected speed limit can be applied with the SET button. As soon as the speed limit has been applied, a green checkmark is displayed.

Additional information:

Speed Limit Assistant, refer to page [243](#).

Assisted Driving Mode



The system supports the driver in keeping the vehicle within the lane.

Additional information:

Assisted Driving Mode, refer to page [235](#).

Lane Change Assistant: lane change in progress



Arrow icon for lane change green: the system carries out a lane change.

Additional information:

Lane Change Assistant, refer to page [239](#).

Lane Change Assistant: lane change not possible



Gray line for lane boundary on the appropriate side: system detected a lane change request. Lane change not currently possible.

Additional information:

Lane Change Assistant, refer to page [239](#).

Assisted Driving Mode Plus



The system is active.

Additional information:

Assisted Driving Mode Plus, refer to page [240](#).

Blue lights

High-beam headlights



High-beam headlights have been switched on.

Additional information:

- ▷ High-beam headlights, refer to page [166](#).
- ▷ Automatic High Beam Assistant, refer to page [167](#).

Gray lights

Seat belt reminder



Seat belt on the passenger seat or another seat in the vehicle is not buckled.

Additional information:

Seat belts, refer to page [113](#).

Cruise Control



The system is interrupted.

Additional information:

Cruise control, refer to page [226](#).

Distance Control



Indicator light is illuminated: the system is interrupted.

Indicator light flashes: Conditions are not adequate for the system to work. The system was deactivated but applies the brakes until you actively resume control by pressing on the brake pedal or accelerator pedal.

Additional information:

Distance Control, refer to page [229](#).

Assisted Driving Mode



The system is on standby and does not manipulate steering movements.

System activates automatically as soon as all function conditions are fulfilled.

Additional information:

Assisted Driving Mode, refer to page [235](#).

Assisted Driving Mode Plus



The system is interrupted and will activate automatically as soon as all functional requirements are met.

Additional information:

Assisted Driving Mode Plus, refer to page [240](#).

White lights

Cruise Control with Distance Control



No Distance Control because accelerator pedal is being pressed.

Additional information:

Distance Control, refer to page [229](#).

Assisted Driving Mode Plus



The system can be activated.

Additional information:

Assisted Driving Mode Plus, refer to page [240](#).

Selection lists

Principle



Lists can be displayed and, if necessary, used for certain functions in the instrument cluster or the Head-up display.

- ▷ Entertainment source.
- ▷ Current audio source.
- ▷ List of most recent telephone calls.

If necessary, the corresponding menu will open on the control display.

Displaying and using the list

The selection lists can be displayed and operated using the operating elements on the steering wheel.

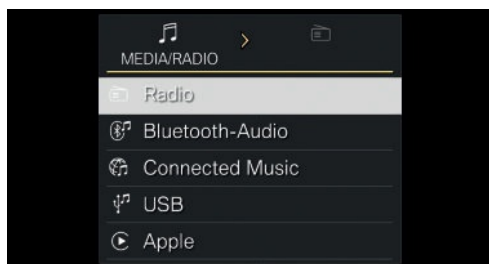

Operating elements	Function
	Turn the knurled wheel: display the entertainment list or scroll up or down in the list. Press knurled wheel: confirm selection.
	Press the corresponding arrow key to change the entertainment source.
	Show list of most recent telephone calls.

Display





Selection lists, e.g., entertainment sources, are displayed on the instrument cluster.

Example: selecting a radio station

-  Press the entertainment sources button.
-  To switch to the list of radio stations, tilt the knurled wheel to the right.
- Turn the knurled wheel to select a radio station.
- Press the knurled wheel to confirm the selected radio station.

Example: changing the entertainment source

-  Press the entertainment sources button.
-  To select an entertainment source, turn the knurled wheel.
- Press the knurled wheel to confirm the selected entertainment source.

Gear shift indicator

Principle

The shift point indicator recommends the gear that best suits the current driving situation. Using the optimal gear supports an efficient driving style.

General information

The gear shift indicator is active in manual mode M depending on vehicle equipment and national-market version.

Displays

Information on upshifting, downshifting, or engaged gear is displayed on the instrument cluster.

On vehicles without a gear shift indicator, the engaged gear is displayed.

Example	Description
M3	In continuous manual mode M: Optimal gear is engaged.
D3	With shift paddles: temporary manual mode.
S3	With shift paddles: Sport program.
2•3	Shift information.

Additional information:
Shift paddles, refer to page 136.

Power gauge

Principle

The power gauge indicates the currently drawn drive power as a percentage.

Enabling/disabling the power gauge

The power display or tachometer is shown depending on the driving mode selected or the individual configuration of the layout.

Display





Needle in range of arrow 1: display for energy recovery such as while decelerating CHARGE.

Needle in range of arrow 2: the drive power in percent, POWER.

Reduced drive power

The available power may be reduced due to certain factors. The power gauge is automatically adjusted accordingly.

In addition, the icons on the power gauge and tachometer indicate reduced drive power.

Icon	Description
	Blue icon: cold drivetrain. White icon: increased drive system temperature, for instance due to sustained or high power demand when driving on mountain roads.
	Depending on vehicle equipment and national-market version: Drive power limitation defined via the BMW Digital Key. With 8-cylinder engine: Power is reduced while the vehicle is broken in.
	System-related functional limitation. A Check Control message is displayed in addition where applicable.

Tachometer

General information

Always avoid RPM in the red warning field. In this range, the fuel supply is reduced to protect the engine.

Activating/deactivating the tachometer

The tachometer is displayed depending on the selected drive mode or the individually configured layout.

The tachometer display changes depending on the selected driving mode.

Reduced rotational speed range

The available rotational speed range may be reduced due certain factors such as a cold drive system. The tachometer display is auto-



matically adjusted depending on the available rotational speed range.

Icon	Description
	Power is reduced while the vehicle is broken in.

Standby state and drive-ready state



OFF is displayed in the instrument cluster. Drive-ready state is turned off and standby state turned on.



READY is displayed in the instrument cluster. The Auto Start/Stop function is ready for automatic engine start.

Additional information:

- ▶ Operating state of the vehicle, refer to page 40.
- ▶ Auto Start/Stop function, refer to page 131.

Engine temperature



▶ Cold engine: the needle is in the blue temperature range, close to the stop of the temperature display, and the word WARM-UP is displayed.

Drive at moderate RPM and vehicle speeds.

- ▶ Normal operating temperature: the needle is in the middle or in the left half of the temperature display.
- ▶ Hot engine: the needle is in the red temperature range. In addition, a Check Control message is displayed.

Additional information:

Coolant level, refer to page 385.

Display



▶ Cold engine: the needle is in the blue temperature range, close to the stop of the temperature display, and the word WARM-UP is displayed.

Drive at moderate RPM and vehicle speeds.

- ▶ Normal operating temperature: the needle is in the middle or in the left half of the temperature display.
- ▶ Hot engine: the needle is in the red temperature range. In addition, a Check Control message is displayed.

Additional information:

Coolant level, refer to page 385.

Indicator light in the instrument cluster



A red indicator light is displayed.

Outside temperature

General information

If the indicator drops to +37°F/+3°C or lower, a signal sounds.

A Check Control message is displayed.

There is an increased risk of ice on roads.

Safety information

Warning

Even at temperatures above +37 °F/+3 °C there is a risk of icy roads, for instance on bridges or shady sections of the road. There is a risk of accident, injury, and property damage. Modify your driving style to the weather conditions at low temperatures.

Shift lights

Principle

Shift lights indicate the suitable upshift point at which optimal acceleration can be achieved.

General information

The shift lights are active in manual mode M and can be displayed on the instrument cluster or on the Head-up display in combination with the tachometer.

Functional prerequisite

Manual mode M must be activated for the shift lights to appear.

Display



Successive fields illuminating yellow indicate an upcoming shift point.

- ▷ Shift when all fields illuminate red at the latest.
- ▷ When the maximum rotational speed is reached, the entire display flashes red and the fuel supply is interrupted in order to protect the engine.

Central display range

Displayable content

The following settings can be selected:

- ▷ Reduced display.
- ▷ Trip data, refer to page 160.
- ▷ Assisted View, refer to page 161.
- ▷ Navigation system route preview.
- ▷ Navigation system map view.
- ▷ G-Meter, refer to page 162.
- ▷ Entertainment.
- ▷ Augmented View.

Depending on vehicle equipment, Augmented View on the instrument cluster enables the visualization of driver assistance systems on the actual vehicle's surroundings.

Grey lines indicate the recommended minimum distance to the preceding vehicle when speed control systems are deactivated.

- ▷ Android Auto®.

Depending on vehicle equipment and national-market version, select functions of a compatible smartphone can also be displayed, e.g., map views.

Some contents for the central display range can also be configured as a view in the Head-up display.

Additional information:

Head-up display, refer to page 147.

Owner's Manual for Navigation, Entertainment, and Communication, refer to page 6.

Configuring the central display range

The content of the central display range on the instrument cluster can be configured individually, for instance the trip data display.

-  Press the button on the steering wheel.
A menu bar is displayed in the instrument cluster.
- "CONTENT"
Select the menu using the arrow buttons on the steering wheel where applicable.
- Select the desired setting using the knurled wheel on the steering wheel.

Trip data

Principle

The trip data display provides various information about the trip, e.g., average consumption or trip distance.

General information

The trip data can be displayed on the control display and in the instrument cluster.

Depending on the setting in the Live Vehicle menu, the trip data is shown on the control display.



The values can be displayed and reset depending on different intervals.

Display on the control display

General information

The following trip data is shown on the control display:

- ▶ Configured interval for displaying trip data.
- ▶  Average fuel consumption depending on the configured interval.

- ▶  Travel time depending on the configured interval.
- ▶  Distance traveled depending on the configured interval.
- ▶  Distance traveled in Coasting mode.

Displaying trip data continuously

-  Apps menu
- "Vehicle"
- "Live Vehicle"
- "Content"
- "Trip data"

Display in the instrument cluster

Information on consumption and distance covered can be displayed in the instrument cluster.

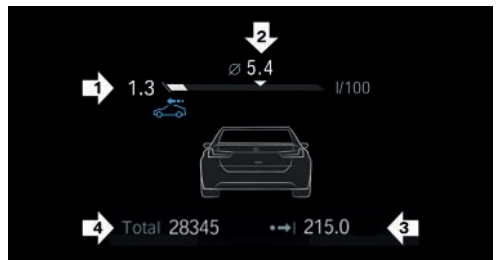

- ▶ Current consumption, arrow 1.
- ▶ Average consumption, arrow 2.
- ▶ Distance traveled depending on the configured interval, arrow 3.
 The icon is displayed when the vehicle is in Coasting mode.
- ▶ Total mileage, arrow 4.

Current consumption

The current fuel consumption display allows you to check the current fuel consumption, e.g., to drive economically and in an environmentally-friendly manner.

Mild hybrid technology: Depending on vehicle equipment, the fuel supply is interrupted

and the engine continues to run when driving slowly or even when the vehicle is stationary. In this case, the internal combustion engine is operated electrically.

Average consumption

The average fuel consumption is displayed depending on how the intervals for displaying trip data are configured.

Adjusting the display of the trip data

The intervals for the display of the trip data in the instrument cluster and on the control display are adjustable.

1.  Apps menu
2. "Vehicle"
3. "System settings"
4. "Time period for trip data"
5. "Values"
6. Select the desired setting:
 - ▷ "Since start of trip": the values are automatically reset approx. four hours after the vehicle has come to a standstill.
 - ▷ "Since last refuel": the values are automatically reset after refueling with a larger quantity of fuel.
 - ▷ "Since factory": the values since the time of the factory delivery are displayed.
 - ▷ "Since Individual": the values since the last manual reset are displayed. The values can be reset at any time.

Resetting average values manually

The following interval can be reset manually at any time:

"Since Individual ()"

Using the button on the left steering column switch:

1. Press the button.

The trip data is displayed.

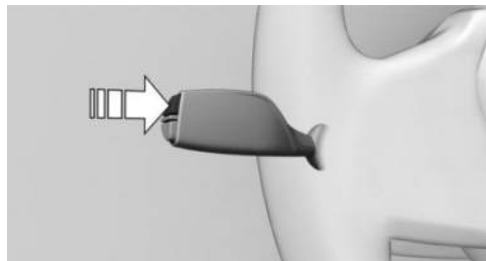

2. Press and hold the button until the values are reset.

Via iDrive:

1.  Apps menu
2. "Vehicle"
3. "System settings"
4. "Time period for trip data"
5. "Reset Individual"

The average values and counters are reset. Once the average values and counters have been reset, the following interval is automatically activated:

"Since Individual ()"

Assisted View

Principle

With Assisted View, information on driver assistance systems can be displayed on the instrument cluster with a vehicle animation.

Information on parking and maneuvering is displayed in the Assisted View whenever the parking assistance system is active.

Safety information

Warning

The system cannot serve as a substitute for the driver's personal judgment in assessing the traffic situation. Based on the limits of the system, it cannot independently react to all traffic situations. There is a risk of accident, injury, and property damage. Adjust driving style to traffic conditions. Watch the surrounding traffic situation closely, be ready to take over steering and braking at any time, and actively intervene where appropriate.

General

You can configure how Assisted View is displayed on the central display range.

Additional information:

Central display area, refer to page [159](#)

Display

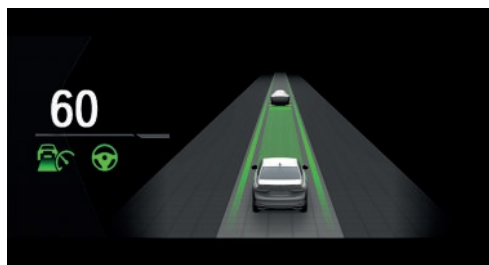

An example of active Driver Assistance: Indicator and warning lights for Distance Control and Assisted Driving Mode are displayed. At the same time, the Distance Control is animated in Assisted View.

System limits

The system's detection capability is limited.

Only objects that are detected by the system are taken into account.

Additional information:

- ▷ Cameras, refer to page [35](#).
- ▷ Radar sensors, refer to page [36](#).

G-Meter

General information

The G-Meter indicates the forces that are applied in longitudinal and transverse direction on the vehicle occupants while driving.

The display can be configured on the central display range of the instrument cluster.

The values are automatically reset whenever you start a new drive.

Additional information:

Central display area, refer to page [159](#)

Manually resetting G-Meter values

1. Display the G-Meter on the instrument cluster.
2.  Press and hold the knurled wheel on the steering wheel until the values are reset.

Date and time

Various settings can be applied for the date and time display such as the date format.

Depending on vehicle equipment and national-market version, the time zone can be set or automatic time zone enabled. With automatic time setting, the time, date and, if necessary, the time zone are updated automatically.

1.  Apps menu
2. "Vehicle"
3. "System settings"
4. "Date and time"
5. Select the desired settings.

Fuel gauge

Principle

The current fill level of the fuel tank is displayed.

General information

Vehicle inclination may cause the display to vary.

Additional information:

Refueling, refer to page 346.

Display



An arrow beside the fuel pump icon shows which side of the vehicle the fuel filler flap is on.

The current range is displayed as numerical value.

Indicator light in the instrument cluster



The yellow indicator light illuminates, once the fuel reserve is reached.

Range

Principle

The range indicates the distance that can still be covered with the current tank of fuel.

General information

The estimated range with remaining fuel is permanently displayed on the instrument cluster.

With a low remaining range, a Check Control message is briefly displayed. A low remaining range means that engine functions cannot always be ensured for sporty driving, e.g., when cornering at speed.

The Check Control message appears continuously below a range of approx. 30 miles/50 km.

Safety information

NOTICE

With a range below 30 miles/50 km, the engine may no longer have sufficient fuel. Engine functions are not ensured anymore. There is a risk of property damage. Refuel promptly.

Display



The current range is displayed as a numerical value next to the fuel gauge.

Setting the units of measurement

Depending on the national-market version, you can set the units of measurement for some values, for instance consumption, distances, and temperature.

1.  Apps menu
2. "Vehicle"
3. "System settings"
4. "Units"
5. Select the desired setting.

Vehicle status





General information

The status can be displayed and actions performed for several systems such as for Check Control.

Displaying vehicle status

1.  Apps menu
2. "Vehicle"
3. "Vehicle status"

Overview

Icon	Description
	"FLAT TIRE MONITOR": Status of the flat tire monitor, refer to page 370.
	"Tire Pressure Monitor": status of the Tire Pressure Monitor, refer to page 362.
	"Engine oil level": electronic oil measurement, refer to page 383.
	"Check Control": displaying stored Check Control messages, refer to page 148.
	"Service": display of the service notifications, refer to page 165.

Current driving condition

General information

The current driving condition is displayed dynamically while driving in the Live Vehicle menu on the control display.

The following states can be displayed:

- ▷ Driving.
- ▷ Coasting mode: "EFFICIENT COASTING"
- ▷ "CHARGING BATTERY"

With mild hybrid technology:

- ▷ Adaptive recuperation.

Depending on the situation, additional information on adaptive recuperation is displayed.

- ▷ Efficient rolling with engine switched off.

Additional information:

- ▷ Adaptive recuperation, refer to page 342.
- ▷ Coasting, refer to page 343.

Functional requirements

- ▷ COMFORT or ECO PRO driving mode is selected.
- ▷ For Live Vehicle, select the following setting: "Adaptive content".

Display

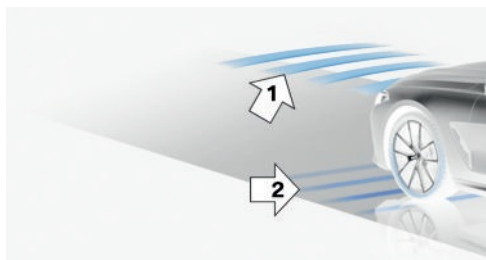

An example:

The adaptive recuperation is active, arrow 1.

The vehicle battery is charged when the vehicle decelerates, arrow 2.

Sport displays

Principle

The Sport displays especially support a sporty driving style.

Functional requirements

- ▷ SPORT driving mode is selected.
- ▷ The following setting is selected for Live Vehicle: "Adaptive content"

Display

The sport displays are displayed in the Live Vehicle menu on the control display.

The following information is displayed:

- ▷ Torque.
- ▷ Power.
- ▷ Boost pressure.
- ▷ Engine oil temperature.

Service

Principle

The service notifications indicate recommended maintenance work.

General information

After turning on, the next service appointment or the distance remaining until the next servicing is displayed briefly on the instrument cluster.

A service advisor can read out the maintenance work from the vehicle key.

Display

More information may be displayed on the control display.

1.  Apps menu
2. "Vehicle"
3. "Vehicle status"
4. "Service"

Maintenance measures as well as legally mandated inspections are displayed.

5. Select the desired entry.

Entering appointment dates

Dates for mandatory vehicle inspections can be entered.

Make sure that the vehicle's date and time are set correctly.

1.  Apps menu
2. "Vehicle"
3. "Vehicle status"
4. "Service"
5. "Vehicle inspection"
6. "Date:"
7. Select the desired setting.

Light and view

Vehicle features and options

This chapter describes model-specific equipment, systems, and functions that are currently available, or may become available in the future, even if they are not present in the vehicle.

Additional information:

Vehicle equipment, refer to page 8.

Turn signal

Turn signal in exterior mirror

When driving and during operation of the turn signals or hazard warning system, do not fold in the exterior mirrors so that the turn signal lamps on the exterior mirror are easy to see.

Flashing

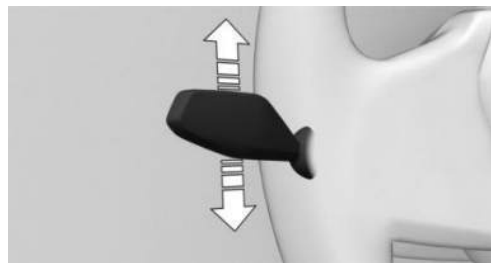

Press the lever past the resistance point.

One-touch signaling

Lightly tap the lever up or down.

The one-touch signaling duration can be adjusted.

1.  Apps menu
2. "Vehicle"
3. "Exterior lighting"

4. If necessary, "Additional settings"
5. "One-touch turn signal"
6. Select the desired setting.

Brief flashing

Press the lever to the resistance point and hold it there for as long as you want the turn signal to flash.

High-beam headlights, headlight flasher

Press the lever forward or pull it backward.



- ▶ High-beam headlights on, arrow 1.
The high-beam headlights illuminate when the low-beam headlights are switched on.
- ▶ High-beam headlights off/headlight flasher, arrow 2.



The indicator light in the instrument cluster illuminates when the high-beam headlights are turned on.

Automatic High Beam Assistant

Principle

The Automatic High Beam Assistant detects other road users early on and automatically switches the high-beam headlights on or off depending on the traffic situation.

General information

The Automatic High Beam Assistant ensures that the high-beam headlights are switched on, whenever the traffic situation allows. In the low speed range, the high-beam headlights are not switched on by the system.

The system responds to light from oncoming traffic and traffic driving ahead of you, and to ambient lighting, for instance in towns and cities.

The high-beam headlights can be switched on and off manually at any time.

Functional requirements

- ▷ Automatic headlight control is activated.
- ▷ Low-beam headlights are switched on.

Activating Automatic High Beam Assistant

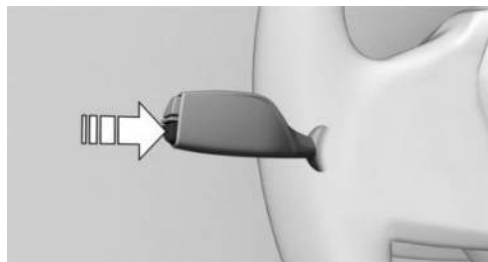

Press the button on the turn signal lever.



The indicator light in the instrument cluster is illuminated when the low-beam headlights are switched on.

The headlights are automatically changed between low-beam headlights and high-beam headlights.



The blue indicator light in the instrument cluster illuminates when the system switches on the high-beam headlights.

Interruption of the journey with activated Automatic High Beam Assistant: the Automatic High Beam Assistant remains activated when continuing the journey.

The Automatic High Beam Assistant is deactivated when manually switching the high-beam headlights on and off.

To reactivate the Automatic High Beam Assistant, press the button on the turn signal lever.

Deactivating Automatic High Beam Assistant

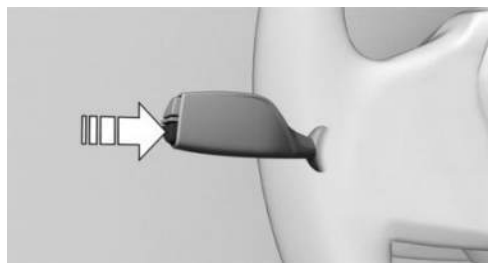

Press the button on the turn signal lever.

Sensitivity of the Automatic High Beam Assistant

General information

The sensitivity of the Automatic High Beam Assistant can be adjusted.

Safety information

Warning

If adjustments have been made or the sensitivity has been modified, oncoming traffic may be momentarily blinded. There is a risk of accident, injury, and property damage. If adjustments have been made and the sensitivity has been modified, make sure that oncoming traffic is not momentarily blinded. Switch off the high-beam headlights manually if required.

Functional requirements

- ▷ Setting at standstill only.
- ▷ Drive-ready state is switched on.
- ▷ Light is turned off.

Increasing sensitivity

Push the turn signal lever to the front for approximately 10 seconds.

A Check Control message is displayed. The system responds more sensitively.

Resetting the sensitivity

Push the turn signal lever to the front again for approx. 10 seconds or switch off the drive-ready state.

The sensitivity of the Automatic High Beam Assistant is reset to the factory settings.

System limits

The Automatic High Beam Assistant cannot replace the driver's personal judgment of when to use the high-beam headlights. When appropriate, dim the high beams manually.

The system may not be fully operational in the following situations, and driver intervention may be necessary:

- ▷ In very unfavorable weather conditions such as fog or heavy precipitation.
- ▷ When detecting poorly-lit road users such as pedestrians, cyclists, horseback riders and wagons; when driving close to train or ship traffic; or at animal crossings.
- ▷ In tight curves, on hilltops or in depressions, in crossing traffic or half-observed oncoming traffic on highways.
- ▷ In poorly-lit towns and cities or in the presence of highly reflective signs.
- ▷ When the windshield in the area in front of the interior mirror is fogged up, dirty or covered with stickers, etc.

Exterior lighting





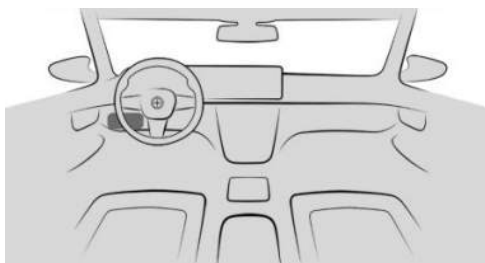

Overview

Buttons in the vehicle





Icon	Function
	Exterior lighting menu.
	Automatic headlight control. Low-beam headlights. Exterior lighting off.
	Exterior lighting off.

Functions via iDrive

Icon	Function
	Automatic headlight control.
	Low-beam headlights.
	Parking lights.
	Exterior lighting off.
	Left roadside parking light.
	Right roadside parking light.

Buttons on the vehicle key

Icon	Function
	Interior lighting.
	Parts of the exterior lighting.
	Pathway lighting.

Driving lights automatic

Principle

The low-beam headlights are switched on and off automatically depending on the ambient brightness, for example in tunnels, in twilight or if there is precipitation.

General information

A blue sky with the sun low on the horizon can cause the lights to be turned on.

If the low-beam headlights are switched on manually, the automatic headlight control is deactivated.

Activate automatic headlight control

 Press the button on the light switch.

The LED in the button illuminates.

 The indicator light in the instrument cluster is illuminated when the low-beam headlights are switched on.

System limits

The automatic headlight control cannot replace your personal judgment of lighting conditions.

For example, the sensors are unable to detect fog or hazy weather. In these situations, turn the lights on manually.

Parking lights, low-beam headlights and roadside parking lights

General information

If the driver's door is opened when the drive-ready state is switched off, the exterior lighting is automatically switched off after a period of time.

Parking lights

General information

The parking lights can only be turned on at low speeds.

Turning on parking lights

-  Apps menu
- "Vehicle"

3. "Exterior lighting"
4. "Parking light"

 The indicator light in the instrument cluster illuminates.

The vehicle is illuminated on all sides.

Do not use the parking lights for extended periods; otherwise, they might drain the vehicle battery and it would then be impossible to switch on drive-ready state.

Turning off parking lights

The following options are available to turn off the parking lights:

▷  Press the button on the light switch.

▷  Press and hold the button on the light switch.

▷ Turn off light via iDrive.

▷ Turn on drive-ready state.

After the drive-ready state is switched on, the automatic headlight control will be activated.

Low-beam headlights

Turning on low-beam headlights

 Press the button on the light switch.

The low-beam headlights illuminate when drive-ready state is switched on.

 The indicator light in the instrument cluster illuminates.

Press the button again to switch on the low-beam headlights when the standby state is switched on.

Turning off low-beam headlights

Depending on the national-market version, the low-beam headlights can be turned off in the low speed range:

▷  Press the button on the light switch.

▷  Press and hold the button on the light switch.

▷ Turn off light via iDrive.

Roadside parking lights

When the vehicle is parked, a one-sided roadside parking light can be switched on.

1.  Apps menu
2. "Vehicle"
3. "Exterior lighting"
4. "Left roadside park. light" or "Right roadside park. light"

Welcome lights

Principle

The welcome light turns on automatically for a limited period of time when approaching or unlocking the vehicle.

General information

Depending on the equipment, the exterior lighting of the vehicle can be set individually.

Activating/deactivating welcome light

1.  Apps menu
2. "Vehicle"
3. "Exterior lighting"
4. If necessary, "Additional settings"
5. Depending on the equipment, select the following setting:

- ▷ "Welcome and goodbye"
When unlocking the vehicle, individual lighting functions are turned on.
- ▷ "BMW Iconic Glow"
The radiator grille lighting can only be adjusted when the vehicle is stationary and the drive-ready state is switched off.

Turning on the welcome light

- ▷ Automatically on approach.
- ▷ During unlocking.



- ▷ Press the button on the vehicle key with the vehicle locked.

Depending on the settings, the interior lighting and parts of the exterior lighting will be turned on.

The function is not available for the first 10 seconds after locking.

Welcome Light Carpet

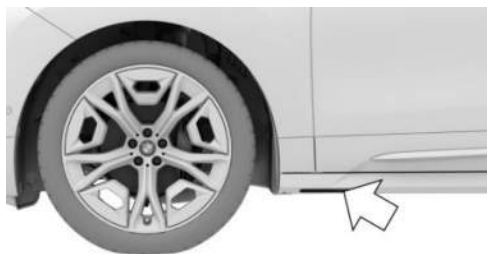

The light source is located in the position indicated.

Keep the light source clean and unobstructed.

Pathway lighting

Principle

For the pathway lighting, the exterior lighting turns on for a certain period of time after leav-

ing the vehicle in order to illuminate the area surrounding the vehicle.

Switching pathway lighting on

- ▷ After switching off the drive-ready state, briefly push the turn signal lever forward.



- ▷ Press and hold the button on the vehicle key for approx. 1 second.

Setting the duration

1.  Apps menu
2. "Vehicle"
3. "Exterior lighting"
4. If necessary, "Additional settings"
5. "Pathway lighting"
6. Select the desired setting.

Daytime driving lights

General information

The daytime driving lights illuminate when drive-ready state is switched on.

Activating/deactivating daytime driving lights

In some countries, daytime driving lights are mandatory, so it may not be possible to deactivate the daytime driving lights in front.

1.  Apps menu
2. "Vehicle"
3. "Exterior lighting"
4. If necessary, "Additional settings"
5. Depending on vehicle equipment or national-market version:
 - ▷ "Daytime driving lights"
 - ▷ "Rear daytime driving lights"
 - ▷ "BMW Iconic Glow"

Adaptive lighting functions

Principle

Adaptive lighting functions enable dynamic illumination of the road.

General information

The adaptive lighting functions may consist of one system or multiple systems, depending on the equipment version:

- ▷ Cornering light.

Activating the adaptive lighting functions



Press the button on the light switch.

The LED in the button illuminates.

The adaptive lighting functions are active when the drive-ready state is switched on.

Cornering light

Principle

In tight curves, for instance on mountainous roads or when turning, an additional cornering light is switched on that illuminates the inside of the curve when the vehicle is moving below a certain speed.

General information

The cornering light is automatically switched on depending on the steering-wheel angle or, where applicable, the use of turn signals.

When driving in reverse, the cornering lights may be automatically switched on regardless of the steering-wheel angle.

Adaptive headlight range control

The adaptive headlight range control feature balances out acceleration and braking processes as well as the vehicle load conditions in order to avoid blinding oncoming traffic.

Instrument lighting

Functional requirement

The brightness can only be adjusted in darkness and with turned on parking lights or low-beam headlights.

Setting the brightness

1.  Apps menu
2. "Vehicle"
3. "Interior lighting"
4. "Cockpit brightness at night"
5. Select the desired setting.

Interior lighting

General information

Depending on the equipment version, interior lights, footwell lights, entry lights, ambient lighting, and speaker lighting are automatically controlled.

Overview

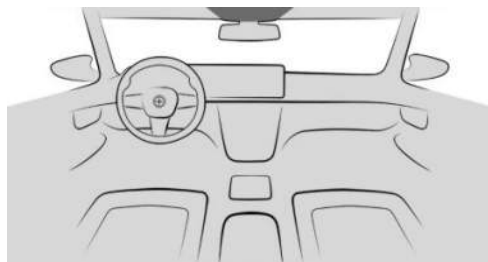



Reading lights



Interior lights

Turning interior lights on/off

Using the button:





Press the button.

To switch off permanently: press the button and hold for approx. 3 seconds.

The interior lights in the rear of the vehicle can be switched on and off independently. The button is located in the rear headliner.

Via iDrive:

1.  Apps menu
2. "Vehicle"
3. "Interior lighting"
4. "Reading light"
5.  Tap on the icon.

Turning reading lights on/off

Using the button:



Press the button.

Depending on the vehicle equipment, the reading lights are located next to the interior lights in the front and rear.

Via iDrive:

1.  Apps menu
2. "Vehicle"
3. "Interior lighting"
4. "Reading light"
5. Tap the desired seat.

Ambient light

General information

Depending on the equipment version, lighting can be adjusted for some lights in the car's interior.

Activating/deactivating ambient light

1.  Apps menu
2. "Vehicle"
3. "Interior lighting"
4. If necessary, "Ambience"
5. "Ambient lighting"

Turning ambient light on/off

The ambient light is switched on when the vehicle is unlocked, and switched off when the vehicle is locked.

If the ambient light was deactivated via iDrive, it will not be turned on when the vehicle is unlocked.

Selecting the color

1.  Apps menu
2. "Vehicle"
3. "Interior lighting"
4. If necessary, "Ambience"
5. "Color"
6. Select the desired setting.

Setting the brightness

1.  Apps menu
2. "Vehicle"
3. "Interior lighting"
4. If necessary, "Ambience"
5. "Brightness"
6. Select the desired setting.



Dynamic light

Certain situations, for example incoming calls or obstacles detected when opening doors, are indicated by light effects. If the ambient light is disabled, the light effects are still displayed.

1. Apps menu
2. "Vehicle"
3. "Interior lighting"
4. If necessary, "Ambience"
5. "Lighting effects"
6. Select the desired setting.

Reduced for night drive

Some lights of the interior lighting are reduced when the vehicle is driven in the dark.

1. Apps menu
2. "Vehicle"
3. "Interior lighting"
4. If necessary, "Ambience"
5. "Reduced for night driving"

Panoramic glass sunroof, lighting

If the panoramic glass sunroof is opened or the sun protection is closed, the lighting in the area concerned is switched off.

Speaker lighting

Principle

Some speakers in the vehicle are illuminated.

General information

When the speakers are muted, the speaker lighting is turned off. When the ambient lighting effects are enabled, the speakers illuminate white.

Turning speaker lighting on/off

The speaker lighting is switched on when the vehicle is unlocked, and switched off when the vehicle is locked.

Window wiper system

Safety information

Warning

If the wipers start moving in the folded away state, body parts can be jammed or damage may occur to parts of the vehicle. There is a risk of injury or risk of damage to property. Make sure that the vehicle is switched off when the wipers are in the folded-away state and the wipers are folded in when switching on.

NOTICE

The wiper blades can wear out or become damaged prematurely when wiping on a dry window for a longer period of time. The wiper motor can overheat. There is a risk of property damage. Do not use the wipers when the window is dry.

NOTICE

If the wipers are frozen to the windshield, the wiper blades can be torn off and the wiper motor can overheat when switching on. There is a risk of property damage. Defrost the windshield prior to switching the wipers on.

Turning on window wiper system

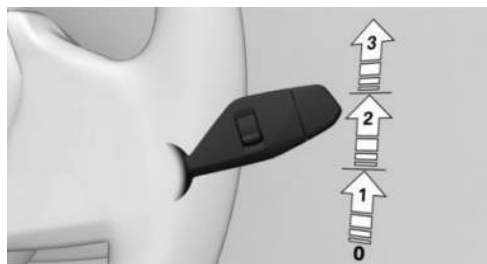

Press the lever up until the desired position is reached.

- ▶ Rest position of the wipers, position 0.
- ▶ Rain sensor mode, position 1.
- ▶ Normal wiper speed, position 2.
- ▶ Fast wiper speed, position 3.

When the journey is interrupted with the window wiper system turned on: when the journey continues, the wipers resume at their previous speed.

Turning off the window wiper system and flick wipe

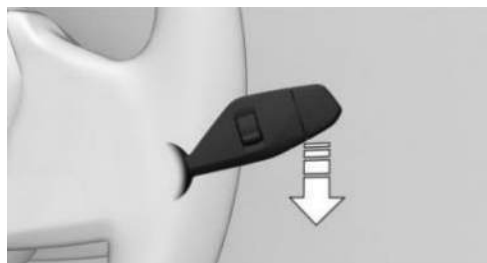

Press the lever down.

- ▶ Turning off: press the lever down until it reaches the 0 position.
- ▶ Flick wipe: press the lever down from the 0 position.

The lever automatically returns to its 0 position when released.

Rain sensor

Principle

The rain sensor automatically controls the wiper operation depending on the intensity of the rainfall.

General information

The sensor is located on the windshield, directly in front of the interior mirror.

Safety information

NOTICE

If the rain sensor is activated, the wipers can accidentally start moving in car washes. There is a risk of property damage. Deactivate the rain sensor in car washes.

Activating rain sensor

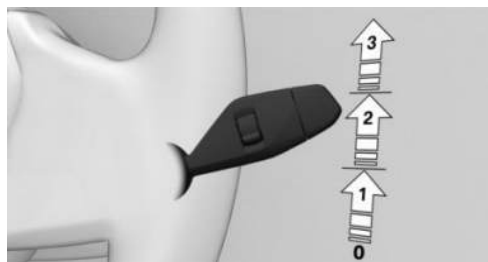

Press lever up once from the 0 position, arrow 1.

Wiping operation is started.

The LED in the wiper lever is illuminated.

In frosty conditions, wiping operation may not start.

Deactivating rain sensor

Press lever back into the 0 position.

Adjusting the rain sensor sensitivity

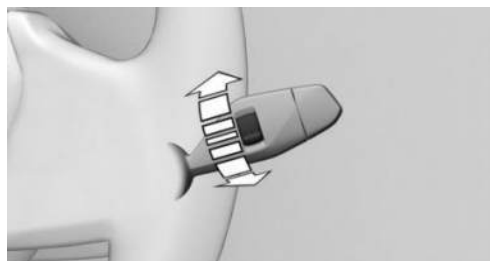

Turn the knurled wheel to adjust the sensitivity of the rain sensor.

- ▷ Upward: high rain sensor sensitivity.
- ▷ Downward: low rain sensor sensitivity.

Window washer system

Safety information

Warning

The washer fluid can freeze onto the window at low temperatures and obstruct the view. There is a risk of accident. Only use the window washer system when the washer fluid will not freeze. Use washer fluid with anti-freeze, if needed.

NOTICE

When the washer fluid reservoir is empty, the washer pump cannot work as intended. There is a risk of property damage. Do not use the washer system when the washer fluid reservoir is empty.

Cleaning the windshield

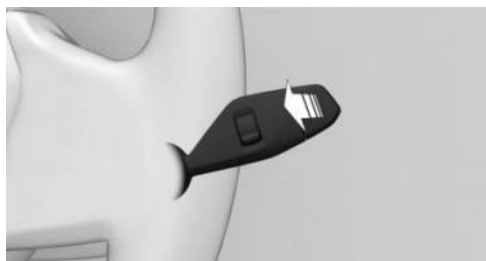

Pull the lever.

The washer fluid is sprayed on the windshield, and the wipers are turned on briefly.

Windshield washer nozzles

The windshield washer nozzles are automatically heated while standby state is switched on.

Rear wiper

Switching on the rear wiper

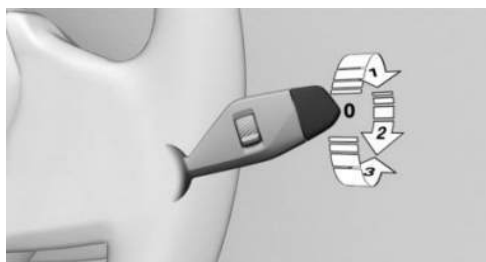

Turn the outer switch upward.

- ▷ Resting position of wiper, position 0.
- ▷ Intermittent operation, arrow 1. When reverse gear is engaged, the system switches to continuous operation.

Clean the rear window

Turn the outer switch in the desired direction.

- ▷ In rest position: Turn the switch downward, arrow 3. The switch returns to its rest position when released.
- ▷ In intermittent operation: turn the switch further, arrow 2. The switch automatically returns to its interval position when released.

The function is deactivated if the washer fluid reservoir fill level is low.

Fold-out position of the wipers

Principle

In the fold-out position, the wipers can be folded out from the windshield, which is important, for instance, when changing the wiper blades or for folding away under frosty conditions.

Safety information

Warning

If the wipers start moving in the folded away state, body parts can be jammed or damage may occur to parts of the vehicle. There is a risk of injury or risk of damage to property. Make sure that the vehicle is switched off when the wipers are in the folded-away state and the wipers are folded in when switching on.

NOTICE

If the wipers are frozen to the windshield, the wiper blades can be torn off and the wiper motor can overheat when switching on. There is a risk of property damage. Defrost the windshield prior to switching the wipers on.

Folding out the wipers

1. Turn on standby state.
2. Press and hold the wiper lever down until the wipers stop in a nearly vertical position.

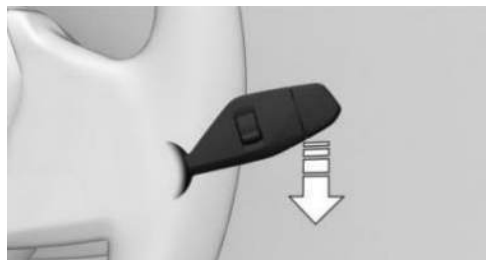

3. Fold the wipers all the way out from the windshield.



Folding in the wipers

1. Fold the wipers back in onto the windshield.
2. Switch on standby state and press and hold the wiper lever down again.

Wipers return to their rest position and are ready again for operation.

Safety

Vehicle features and options

This chapter describes model-specific equipment, systems, and functions that are currently

available, or may become available in the future, even if they are not present in the vehicle.

Additional information:

Vehicle equipment, refer to page 8.

Airbags

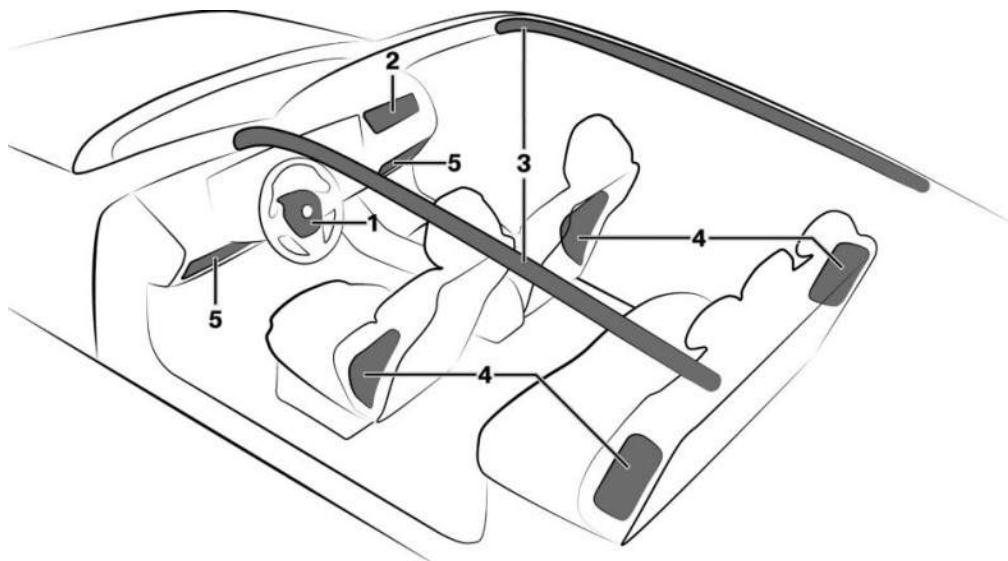

- 1 Front airbag, driver
- 2 Front airbag, front passenger
- 3 Head airbag
- 4 Side airbag
- 5 Knee airbag

Front airbags

The front airbag helps protect the driver and front passenger in the event of a frontal impact in which the seat belts alone would not provide adequate protection.

Side airbag

In the event of a side collision, the side airbag protects the side of the body in the chest and lap area.

Depending on the national-market version:

In the event of a side collision, the side airbag in the rear protects the chest and lap area on

the side of the bodies of the occupants in the outer rear seats.

Head airbag

In the event of a side collision, the head airbag protects the head.

Ejection Mitigation

The head airbag system is designed as an ejection mitigation countermeasure to reduce the likelihood of ejections of vehicle occupants through side windows during rollovers or side collision events.

Knee airbag

Depending on the national-market version:

The knee airbag protects the legs in the event of a frontal impact.

Protective effect

General information

Airbags are not deployed in every impact situation, e.g., in less severe accidents.

Information on optimum protective effect of the airbags

Warning

If the seat position is incorrect, the seat belts are fastened incorrectly or the deployment area of the airbags is impaired, the airbag system cannot provide protection as intended and may cause additional injuries due to deployment. There is a risk of injury or danger to life. Follow the information on achieving the optimum protective effect of the airbag system.

- ▷ Keep a distance from the airbags.
- ▷ Fasten the seat belts correctly.
- ▷ Always grasp the steering wheel on the steering wheel rim. Hold your hands at the

3 o'clock and 9 o'clock positions to keep the risk of injury to your hands or arms as low as possible when the airbag is deployed.

- ▷ Adjust seat and steering wheel so that hands can be crossed over the steering wheel. Select the settings so that the shoulder rests against the backrest when crossing the hands and the upper body is as far back as possible while still maintaining a comfortable grip on the steering wheel.
- ▷ Make sure that the front passenger is sitting correctly, i.e., with their feet and legs in the footwell, not resting on the dashboard.
- ▷ Make sure that occupants keep their heads away from the side airbag.
- ▷ There should be no additional persons, animals or objects between an airbag and a person.
- ▷ Dashboard and windshield on the passenger's side must stay clear - do not attach adhesive film or coverings and do not attach brackets or cables, for instance for navigation devices or mobile phones.
- ▷ Do not bond the airbag cover panels with adhesive, do not cover them or modify them in any way.
- ▷ Do not use the cover of the front airbag on the passenger's side as a storage area.
- ▷ Keep storage compartments near the airbags closed, e.g., glove compartment or center armrest.
- ▷ Do not place slip covers, seat cushions, or other objects on the front seats unless they are specifically designed for seats with integrated airbags.
- ▷ Do not hang pieces of clothing such as jackets over the backrests.
- ▷ Do not modify individual components or wiring. This also applies to steering wheel covers, the dashboard, and the seats.
- ▷ Do not disassemble the airbag system.

Even when you follow all instructions very closely, injury from contact with the airbags cannot be fully ruled out in certain situations.

The ignition and inflation noise may lead to short-term and, in most cases, temporary hearing impairment in sensitive occupants.

Vehicle modifications for a person with disabilities may affect the air bag system; contact BMW Customer Relations for further information.

Warnings and information on the airbags are also found on the sun visors.

Operational readiness of the airbag system

Safety information

Warning

Individual components can be hot after deployment of the airbag system. There is a risk of injury. Do not touch individual components.

Warning

Improperly executed work can lead to failure, malfunction or unintentional deployment of the airbag system. In the case of a malfunction, the airbag system might not deploy as intended despite the accident severity. There is a risk of injury or danger to life. Have the airbag system checked, repaired, disassembled, and scrapped by an authorized service center or another qualified service center or repair shop.

Display in the instrument cluster



When drive-ready state is turned on, the warning light in the instrument cluster illuminates briefly, thereby indicating the operational readiness of the entire airbag system and the seat belt tensioners.

Malfunction



- ▶ Warning light does not illuminate when drive-ready state is turned on.
- ▶ The warning light illuminates continuously.

The airbag system or the seat belt tensioners may not be operational. Have the vehicle checked immediately by an authorized service center or another qualified service center or repair shop.

Setting the front seat positions

The power that deploys the driver's/front passenger airbags depends on the position of the driver's/front passenger seat.

To maintain the accuracy of this function, calibrate the electrical front seats as soon as a respective message appears on the control display.

Additional information:

Seats, refer to page [104](#).

Automatic deactivation of the front passenger airbags

Principle

The system reads if the front passenger seat is occupied by measuring the human body's resistance.

The front passenger airbags are activated or deactivated.

General information

Before transporting a child on the front passenger seat, refer to the safety information and instructions for children on the front passenger seat, see Children.

Safety information

Warning

To ensure the front passenger airbag function, the system must be able to detect whether a person is sitting in the front passenger seat. The entire seat surface must be used for this purpose. There is a risk of injury or danger to life. Make sure that the front passenger keeps his or her feet in the footwell.

Functional requirements

To enable accurate recognition of the occupied seat surface:

- ▶ Do not attach covers, cushions, ball mats or other items to the front passenger seat unless they are specifically determined to be safe for use on the front passenger seat.
- ▶ Do not place objects under the seat that can press against the seat from below.
- ▶ Do not place any electronic devices on the front passenger seat if a child restraint system is to be installed on it.
- ▶ No moisture in or on the seat.

Indicator light for the front passenger airbags

The indicator light for the front-seat passenger airbag in the headliner indicates the operating state of the front-seat passenger airbag.

The light indicates whether the airbags are either activated or deactivated.

After drive-ready state is switched on, the light shortly illuminates and then indicates whether the airbags are either activated or deactivated.

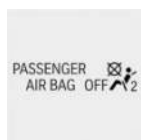

- ▶ The indicator light illuminates when a child is properly seated in a child restraint system or when the seat is empty. The airbags on the

passenger's side are not activated.

- ▶ The indicator light does not illuminate when, for instance, a correctly seated person of sufficient size is detected on the seat. The airbags on the passenger's side are activated.

Fault of the automatic deactivation system

When transporting older children and adults, the front passenger airbags may be deactivated in certain seat positions. In this case, the indicator light for the front passenger airbags illuminates.

In this case, change the seat position so that the front passenger airbags are activated and the indicator light goes out.

If it is not possible to activate the airbags, have the person sit in the rear seat.

Detected child restraint systems

The system generally detects children seated in a child restraint system, particularly in child restraint systems required by NHTSA at the point in time when the vehicle was manufactured. After installing a child restraint system, make sure that the indicator light for the front passenger airbags illuminates. This indicates that the child restraint system has been detected and the front passenger airbags are not activated.

Collision warning systems

General information

Depending on the equipment, the vehicle has different systems that can help prevent the risk of imminent collision.

- ▶ Forward Collision Mitigation with brake intervention, refer to page [183](#).
- ▶ Exit warning, refer to page [192](#).



- ▷ Lane departure warning, refer to page 193.
- ▷ Active Blind Spot Detection, refer to page 197.
- ▷ Side collision mitigation, refer to page 200.
- ▷ Rear-end collision preparation, refer to page 201.
- ▷ Traffic Light And Sign Warning, refer to page 202.
- ▷ Wrong way warning, refer to page 204.
- ▷ No Turn on Red function, refer to page 205.
- ▷ Emergency Stop Assistant, refer to page 206.

Safety information

Warning

The system cannot serve as a substitute for the driver's personal judgment in assessing the traffic situation. Based on the limits of the system, it cannot independently react to all traffic situations. There is a risk of accident, injury, and property damage. Adjust driving style to traffic conditions. Watch the surrounding traffic situation closely, be ready to take over steering and braking at any time, and actively intervene where appropriate.

Warning

Indicators and warnings cannot serve as a substitute for the driver's personal judgment. Due to its limits, the system may not issue warnings or responses, or these may be issued late or in a manner that is not consistent with their normal use. There is a risk of accident, injury, and property damage. Adjust driving style to traffic conditions. Watch surrounding traffic closely and actively intervene where appropriate.

Sensors

Depending on vehicle equipment, the Intelligent Safety systems are controlled by the following sensors:

- ▷ Camera behind the windshield.
- ▷ Front radar sensor.
- ▷ Radar sensors, side, front.
- ▷ Radar sensors, side, rear.

Additional information:

Sensors of the vehicle, refer to page 35.

Turning on/turning off collision warning systems

Depending on national-market version, some of the systems are automatically activated whenever you start driving.

The following functions are adjustable.

1.  Apps menu
2. "Vehicle"
3. "Driving settings"
4. "Driver Assistance"
5. "Safety and warnings"
6. Select the desired settings.

Resetting the settings

The settings of the collision warning systems can be reset to the default settings at vehicle outbound delivery.

1.  Apps menu
2. "Vehicle"
3. "Driving settings"
4. "Driver Assistance"
5. "Safety and warnings"
6. "Reset to recommended settings"

System limits

Safety information

Warning

Because of system limitations, this system may either not respond, or respond too late, incorrectly, or without cause. There is a risk of accident, injury, and property damage. Actively intervene as warranted. Refer to the information in this Owner's Manual regarding the scope of the system's operation and limitations.

Detection capability

The system's detection capability is limited.

The system only takes into account objects that are located in the detection range of the installed sensors and are detected by the system.

Depending on the vehicle equipment, the area is monitored by cameras or radar sensors.

Thus, a system response might not come or might come late.

System limits of the sensors

Additional information:

Sensors of the vehicle, refer to page 35.

Forward Collision Mitigation with brake intervention

Principle

The Forward Collision Mitigation can help prevent accidents. If an accident cannot be avoided, the system can help reduce the severity of the accident.

The system can issue a warning of a possible risk of collision and activate the brakes independently, if needed.

General information

Depending on the equipment version, the Forward Collision Mitigation system includes the following functions:

- ▶ Warning function in rear-end collision situations, refer to page 186.
- ▶ Warning function for oncoming traffic, refer to page 187.
- ▶ Warning function for turning with oncoming traffic, refer to page 188.
- ▶ Warning function for pedestrians, refer to page 188.
- ▶ Warning function at intersections, refer to page 190.
- ▶ Evasion Assistant, refer to page 191.

Safety information

Warning

The system cannot serve as a substitute for the driver's personal judgment in assessing the traffic situation. Based on the limits of the system, it cannot independently react to all traffic situations. There is a risk of accident, injury, and property damage. Adjust driving style to traffic conditions. Watch the surrounding traffic situation closely, be ready to take over steering and braking at any time, and actively intervene where appropriate.

Warning

Indicators and warnings cannot serve as a substitute for the driver's personal judgment. Due to its limits, the system may not issue warnings or responses, or these may be issued late or in a manner that is not consistent with their normal use. There is a risk of accident, injury, and property damage. Adjust driving style to traffic conditions. Watch surrounding traffic closely and actively intervene where appropriate.

Sensors

Depending on the equipment, the system is controlled by the following sensors:

- ▷ Camera behind the windshield.
- ▷ Front radar sensor.
- ▷ Radar sensors, side, front.

Additional information:

Sensors of the vehicle, refer to page [35](#).

Speed range

The system issues a warning of a possible risk of collision at speeds above approx. 3 mph/5 km/h.

If the vehicle speed exceeds approx. 155 mph/250 km/h, the system is deactivated temporarily.

Some functions are deactivated earlier.

The system is enabled as soon as the speed drops below these values again.

Turning the Forward Collision Mitigation on/off

Turning on the system automatically

Depending on the national-market version, the system is automatically active after every departure.

Turning on system manually

The system is activated by setting the warning time.

Additional information:

Setting the warning time, refer to page [184](#).

Turning system off manually

Depending on national-market version, the adjustment can only be made when the vehicle is at a standstill or in a very low speed range.

If necessary, the switch-off must be confirmed successively on the control display.

1.  Apps menu
2. "Vehicle"
3. "Driving settings"
4. "Driver Assistance"
5. "Safety and warnings"
6. "Forward Collision Mitigation"
7. "Off"

Setting the warning time





1.  Apps menu
2. "Vehicle"
3. "Driving settings"
4. "Driver Assistance"
5. "Safety and warnings"
6. "Forward Collision Mitigation"
7. Select the desired setting.

The more sensitive the warning time is set to be, the more warnings will be displayed. The system can therefore also issue more early or unfounded warnings and reactions.

The system checks for visual impairments. Depending on the vehicle equipment, the Driver Attention Camera in the instrument cluster captures the driver's field of vision. Visibility and field of vision also affect the timing of the warnings.

Display in the instrument cluster

The following indicator lights and warning lights are shown on the instrument cluster and, depending on vehicle equipment, on the Head-up display:

Icon	Meaning
	Risk of collision with a person, e.g., a pedestrian.
	Risk of collision, for instance with an oncoming or a vehicle driving ahead.
	Risk of collision, e.g., with a vehicle crossing from the right.
	Risk of collision, e.g., with a vehicle crossing from the left.
	General risk of collision.

The corresponding indicator lights and warning lights may display differently if the system detects multiple objects.

Warning function

The Forward Collision Mitigation warns on different warning levels, depending on the respective hazardous situation.

In the event of a prewarning, a warning light illuminates red. In the event of an acute warning, a warning light flashes red and a warning tone sounds.

In the event of a system warning, the driver must intervene immediately and in accordance with the situation.

- ▶ Red warning light illuminates:
A hazardous situation has been detected. Increased awareness is required.
- ▶ Red warning light flashes:
There is a risk of collision. Intervene immediately.
- ▶ A warning signal sounds:
There is a risk of collision. Intervene immediately.
- ▶ Automatic brake intervention:

Depending on the equipment and situation in case of risk of imminent collision, the system can also intervene with an automatic brake intervention and automatically decelerate the vehicle, if necessary, to a complete stop.

When the brake pedal is depressed quickly and hard, the maximum brake power of the vehicle is used.

Automatic brake intervention

In case of a risk of collision, the system can assist with an automatic brake intervention, if necessary.

When the vehicle is traveling at a low speed, the vehicle may come to a complete stop.

During automatic brake intervention, Dynamic Stability Control activates automatically.

A brake intervention can be canceled by depressing the accelerator pedal with sufficient force, releasing the brake pedal, or by actively steering.

Depending on the equipment and situation, the brake intervention can occur up to approx. 155 mph/250 km/h.

At speeds above approx. 130 mph/210 km/h, only a brief brake intervention will occur.

System limits

Safety information

Warning

Because of system limitations, this system may either not respond, or respond too late, incorrectly, or without cause. There is a risk of accident, injury, and property damage. Actively intervene as warranted. Refer to the information in this Owner's Manual regarding the scope of the system's operation and limitations.

Detection capability

The system's detection capability is limited.

The system only takes into account objects that are located in the detection range of the installed sensors and are detected by the system.

Depending on the vehicle equipment, the area is monitored by cameras or radar sensors.

Thus, a system response might not come or might come late.

System limits of the sensors

Additional information:

Sensors of the vehicle, refer to page 35.

Functional limitations

The system may be limited in the following situations:

- ▶ In tight curves.
- ▶ With limitation of the driving stability control systems.
- ▶ Up to 10 seconds after turning on drive-ready state using the Start/Stop button.

Also, do not use Forward Collision Mitigation when towing.

Warning function in forward collision situations

Principle

The warning function in forward collision situations warns of a possible risk of collision and may brake independently.

In the event of an accident, the system helps by reducing impact speed.

General information

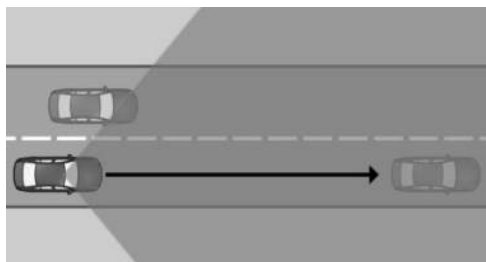

Sensors detect the traffic situation in their detection range.

The system issues a warning of a possible risk of collision with vehicles at speeds above approx. 3 mph/5 km/h. The timing of warnings may vary with the current driving situation.



The system considers the driver's vehicle handling when responding. If an active driving style is detected, warnings and brake interventions occur less frequently.

Safety information

Follow the safety information in Chapter "Forward Collision Mitigation".

Display in the instrument cluster

If there is a risk of collision with a detected vehicle, a warning light is displayed.

Icon	Meaning
	Forward Collision Warning with a detected vehicle.
	General risk of collision.

Warning function

The warning prompts the driver to intervene.

Additional information:

Forward Collision Mitigation, refer to page 183.

System limits

General information

Follow the system limits in the "Forward Collision Mitigation" chapter.

Detection range

The following situations may not be detected, or only detected with a delay, for instance:

- ▶ Vehicle driving slowly in front and being approached at high speed.
- ▶ Vehicles that suddenly swerve in front of you, or strongly decelerating vehicles.
- ▶ Vehicles with unusual rear designs.

Warning function for oncoming traffic

Principle

The warning function for oncoming traffic can warn of a possible risk of collision with oncoming vehicles and may brake independently.

In the event of an accident, the system helps by reducing impact speed.

General information

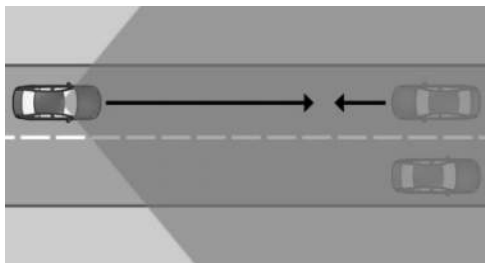

Sensors detect the traffic situation in their detection range.

The system issues a warning of a possible risk of collision with vehicles at speeds above ap-



prox. 3 mph/5 km/h. The timing of warnings may vary with the current driving situation.

Safety information

Follow the safety information in Chapter "Forward Collision Mitigation".

Display in the instrument cluster

If there is a risk of collision with a detected vehicle, a warning light is displayed.

Icon	Meaning
	Oncoming traffic warning when a vehicle is detected.
	General risk of collision.

Warning function

The warning prompts the driver to intervene.

In case of a possible risk of collision, a brake intervention is triggered.

Additional information:

Forward Collision Mitigation, refer to page [183](#).

System limits

General information

Follow the system limits in the "Forward Collision Mitigation" chapter.

Detection range

The following situations may not be detected, for instance:

- ▶ Oncoming vehicles at a very high speed.
- ▶ Vehicles with an unusual front view.

Warning function for turning with oncoming traffic

Principle

There is a risk of an accident with oncoming vehicles when turning across the oncoming lane. The system can issue a warning of a possible risk of collision and activate the brakes independently, if needed.

In the event of an accident, the system helps by reducing impact speed.

General information

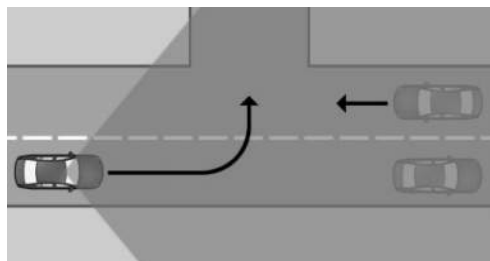

Sensors detect the traffic situation in their detection range.

The system issues a warning of a possible risk of collision with oncoming vehicles at speeds from approx. 3 mph/5 km/h. The timing of warnings may vary with the current driving situation.

Safety information

Follow the safety information in Chapter "Forward Collision Mitigation".

Display in the instrument cluster

If there is a risk of collision with a detected vehicle, a warning light is displayed.

Icon	Meaning
	Oncoming traffic warning when a vehicle is detected.
	General risk of collision.

Warning function

The warning prompts the driver to intervene.

Additional information:

Forward Collision Mitigation, refer to page 183.

System limits

General information

Follow the system limits in the "Forward Collision Mitigation" chapter.

Detection range

The following situations may not be detected, for instance:

- ▷ Oncoming vehicles at a very high speed.
- ▷ Vehicles that are hidden by other vehicles.
- ▷ Vehicles with an unusual front view.

Upper speed limit

The system is active when the own speed is below approx. 15 mph/25 km/h.

Warning function for pedestrians

Principle

At speeds that are common in towns and cities, the warning function warns the driver of a possible risk of collision with pedestrians and cyclists. The system may brake automatically.

In the event of an accident, the system helps by reducing impact speed.

General information

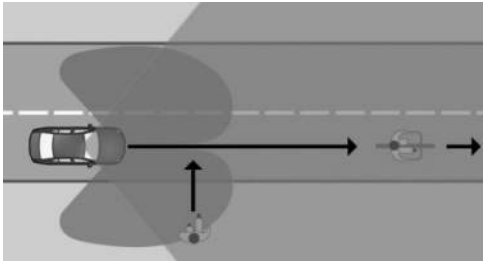

Sensors detect the traffic situation in their detection range when on a straight line.

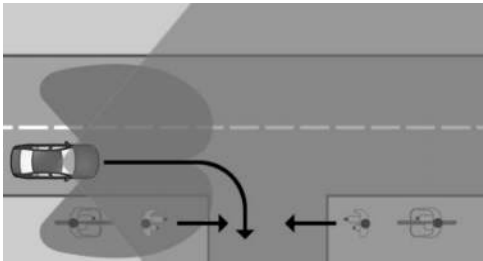

Sensors detect the traffic situation in their detection range when turning.



The system issues a warning of a possible risk of collision with pedestrians or cyclists at speeds above approx. 3 mph/5 km/h.

Safety information

Follow the safety information in Chapter "Forward Collision Mitigation".

Display in the instrument cluster

If there is a risk of collision with a detected pedestrian or cyclist, a warning light is displayed.

Icon	Meaning
	Risk of collision with a person, e.g., a pedestrian.
	General risk of collision.

Warning function

The warning prompts the driver to intervene.

Additional information:

Forward Collision Mitigation, refer to page 183.

System limits

General information

Follow the system limits in the "Forward Collision Mitigation" chapter.

Detection range

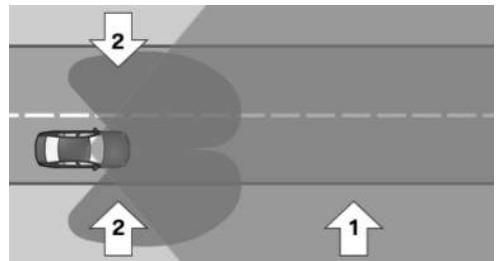

The detection range consists of the following parts:

- ▶ Area in front of the vehicle, arrow 1.
- ▶ With side radar sensors in front: side areas, arrows 2.

The following situations may not be detected, for instance:

- ▶ Partially covered pedestrians or bikes.
- ▶ Pedestrians that are not detected as such because of their contour or posture.
- ▶ Pedestrians who are too small for the sensors to detect.

Upper speed limit

Depending on the vehicle equipment, the system responds to pedestrians and cyclists when your vehicle speed is less than approx. 50 mph/80 km/h.

Warning function at intersections

Principle

At speeds that are common in towns and cities, the Intersection Collision Warning function can warn the driver of a possible risk of collision with crossing traffic at intersections and junctions. The system may brake automatically.

In the event of an accident, the system helps by reducing impact speed.

General information

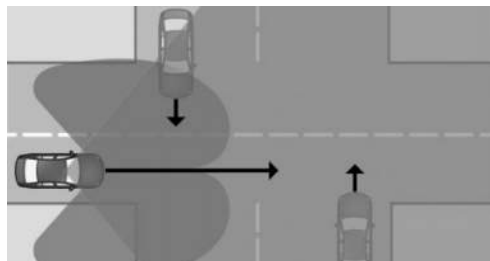

Sensors detect the traffic situation in their detection range.

Vehicles crossing your driving direction can be detected by the system as soon as these vehicles enter into detection range of the sensors.

At intersections and junctions, a warning is issued when a risk of collision with crossing traffic is detected.

The system issues a warning of a possible risk of collision with vehicles at speeds above approx. 3 mph/5 km/h.

The timing of warnings may vary with the current driving situation.

Safety information

Follow the safety information in Chapter "Forward Collision Mitigation".

Display in the instrument cluster

If there is a risk of collision with a detected vehicle, a warning light is displayed.

Icon	Meaning
	Risk of collision with vehicle crossing from the right.
	Risk of collision with vehicle crossing from the left.
	General risk of collision.

Warning function

The warning prompts the driver to intervene.

Additional information:

Forward Collision Mitigation, refer to page 183.

System limits

General information

Follow the system limits in the "Forward Collision Mitigation" chapter.

Detection range

The following situations may not be detected, for instance:

- ▶ Crossing vehicles when they are hidden, e.g. by buildings.
- ▶ Vehicles with an unusual side view.
- ▶ Vehicles in highly dynamic driving situations.

Upper speed limit

The system responds to crossing vehicles when the vehicle speed is below approx. 50 mph/80 km/h.

Evasion Assistant

Principle

The Evasion Assistant can help the driver perform evasive maneuvers in certain situations, e.g., when obstacles or pedestrians appear suddenly.

General information

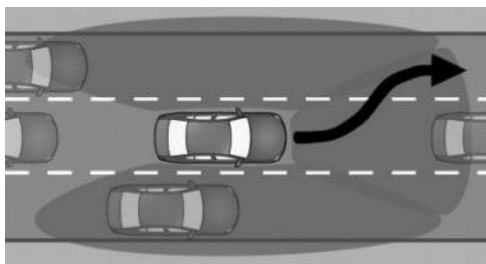

The system issues a warning and intervenes to support the driver if a lateral evasive maneuver is possible.

Sensors monitor and detect the clearance in front of the vehicle. Depending on the vehicle equipment, the areas next to the vehicle are also monitored.

If the system detects sufficient free space alongside the vehicle, it helps the driver perform an evasive maneuver safely.

Safety information

Follow the safety information in Chapter "Forward Collision Mitigation".

Functional requirements



- ▷ Forward Collision Mitigation is active.
- ▷ Sensors detect sufficient clearance around vehicle.

Speed range

The Evasion Assistant helps the driver when the vehicle speed is between approx. 19 mph/30 km/h to 100 mph/160 km/h.

Display in the instrument cluster

If there is a risk of collision with a detected vehicle or detected person, e.g., a pedestrian, a warning light is displayed.

Icon	Meaning
	Warning when a vehicle is detected.
	Risk of collision with a pedestrian.
	Risk of collision with unknown obstacle.

Warning function with evasion support

If the vehicle approaches another object at a high differential speed, a warning is displayed if there is an immediate risk of collision.

Intervene in case of a warning.

The system is designed to provide assistance during evasive maneuvers when there is a risk of collision.

A message in the instrument cluster and, depending on the equipment, in the Head-up display signals the evasion support.

System limits

General information

Follow the system limits in the "Forward Collision Mitigation" chapter.

Detection range

The following situations may not be detected, for instance:

- ▷ Vehicle driving slowly in front and being approached at high speed.
- ▷ Vehicles that suddenly swerve in front of you, or strongly decelerating vehicles.

- ▷ Vehicles with unusual rear designs.
- ▷ Two-wheeled vehicles ahead of you.
- ▷ Partially covered pedestrians or bikes.
- ▷ Pedestrians that are not detected as such because of their contour or posture.
- ▷ Pedestrians who are too small for the sensors to detect.

Functional limitation

The system is deactivated if the trailer power socket is occupied or trailer towing is activated, e.g., when using a trailer or rear bicycle rack.

Exit warning

Principle

The exit warning helps to avoid accidents. The system can warn the occupants when they are opening the doors and a risk of collision with approaching objects is detected.

General information

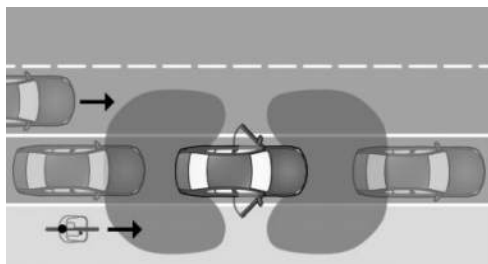

Two radar sensors in the rear bumper monitor the area behind the vehicle.

Depending on the vehicle equipment, the area around the vehicle in front of the vehicle is monitored as well. Two additional radar sensors are located in the front bumper.

The system monitors the vehicle's surroundings for a limited time after you get in or park. A possible risk of collision is indicated by various warning functions.

Safety information

Follow the safety information in the "Forward Collision Mitigation" chapter.

Sensors

The system is controlled by the following sensors:

- ▷ Radar sensors, side, rear.
- ▷ Depending on the equipment: radar sensors, side, front.

Turning the exit warning on/off

Turning on the system automatically

The exit warning activates automatically after departure if the function was switched on at the completion of the last trip.

Turning system off manually

1. **■ ■** Apps menu
2. "Vehicle"
3. "Driving settings"
4. "Driver Assistance"
5. "Safety and warnings"
6. "Exit warning"
7. "Off"

Adjusting the exit warning

1. **■ ■** Apps menu
2. "Vehicle"
3. "Driving settings"
4. "Driver Assistance"
5. "Safety and warnings"
6. "Exit warning"
7. Select the desired setting.

Turning the warning tone on/off

1. **■ ■** Apps menu
2. "Vehicle"

3. "Driving settings"
4. "Driver Assistance"
5. "Safety and warnings"
6. "Exit warning"
7. "Warning tone"

Displays

Warning light in exterior mirror



The warning light in the exterior mirror warns of a possible collision with a detected vehicle.

Ambient light

Depending on the equipment, warnings are also indicated by the ambient light in the interior.

Warning function

Prewarning

In the event of an advance warning, the warning light in the exterior mirror illuminates. Depending on the equipment, the ambient light also flashes.

An object was detected in the opening area. Increased awareness is required.

Acute warning

In the event of an acute warning, the warning light in the exterior mirror flashes, as does the ambient light, depending on vehicle equipment. In addition, a signal tone sounds.

There is a risk of collision when opening the doors.

System limits

General information

Follow the system limits in the "Collision warning systems" chapter.

Detection range

The following situations may not be detected, for instance:

- ▷ Fully or partially hidden objects.
- ▷ Stationary or very slow objects.
- ▷ Pedestrians.

Functional limitations

The system may be limited in the following situations:

- ▷ The speed of an approaching vehicle is too fast or too slow.
- ▷ In curves.
- ▷ In case of fully or partially hidden objects.

Lane Departure Warning with active return

Principle

The lane departure warning alerts when the vehicle is about to run off the road or exit the lane.

An automatic steering intervention helps to keep the vehicle in its lane.

General information

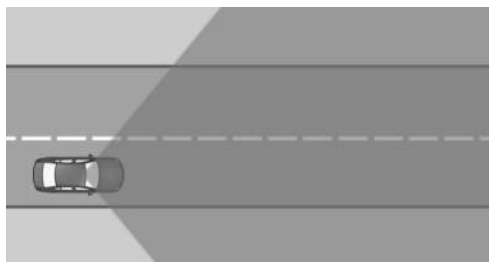

Sensors detect the traffic situation in their detection range.

The system issues a warning starting at a minimum speed. The minimum speed is country-specific and displayed on the control display.

Warnings are displayed in the instrument cluster. In addition, the steering wheel vibrates.

The system does not provide a warning if the turn signal is set in the respective direction before exiting the lane.

Safety information

Warning

The system cannot serve as a substitute for the driver's personal judgment in assessing road and traffic situations. There is a risk of accident. Adjust driving style to traffic conditions. Watch surrounding traffic closely and actively intervene where appropriate. Do not jerk the steering wheel in response to a warning.

Warning

Indicators and warnings cannot serve as a substitute for the driver's personal judgment. Due to its limits, the system may not issue warnings or responses, or these may be issued late or in a manner that is not consistent with their normal use. There is a risk of accident, injury, and property damage. Adjust

driving style to traffic conditions. Watch surrounding traffic closely and actively intervene where appropriate

Functional requirement

The camera must detect the lane boundaries for the lane departure warning to be active.

The areas of the sensors must be clean and clear.

Sensors

Depending on the equipment, the system is controlled by the following sensors:

- ▶ Camera behind the windshield.
- ▶ Front radar sensor.
- ▶ Radar sensor, side, front.

Turning the Lane Departure Warning on/off

Turning on the system automatically

Depending on the national-market version, the system is automatically active after every departure.

Turning on system manually

The system is activated by the selected warning setting.

Additional information:

Configuring the warning, refer to page [195](#).

Turning system off manually

Depending on vehicle equipment and national-market version, you must successively confirm the switch-off on the control display.

1.  Apps menu
2. "Vehicle"
3. "Driving settings"
4. "Driver Assistance"
5. "Safety and warnings"

6. "Lane Departure Warning"
7. "Off"

Setting Lane Departure Warning

Configuring the warning

1.  Apps menu
2. "Vehicle"
3. "Driving settings"
4. "Driver Assistance"
5. "Safety and warnings"
6. "Lane Departure Warning"
7. Select the desired setting.

▶ "Expanded"

If the system detects that your vehicle is about to leave your lane or cross a lane marking, a warning is issued. The system performs a steering intervention.

▶ "In dangerous situations"

Broken road lines: If the system detects that the vehicle is about to inadvertently cross a lane marking, or if the sensors detect an oncoming vehicle, a warning is issued and a steering intervention is performed.

Depending on national-market version, with continuous lane markings: If the system detects that your vehicle is about to inadvertently leave your lane or cross a lane marking, a warning is issued and a steering intervention is performed.

Setting the intensity of the steering wheel vibration

1.  Apps menu
2. "Vehicle"
3. "Driving settings"
4. "Driver Assistance"
5. "Feedback via steering wheel"

6. "Vibration intensity"
7. Select the desired setting.

The setting is applied to all collision warning systems.

Depending on the national-market version: turning steering intervention on/off

1.  Apps menu
2. "Vehicle"
3. "Driving settings"
4. "Driver Assistance"
5. "Safety and warnings"
6. "Lane Departure Warning"
7. "Steering intervention"

Depending on the national-market version, the steering intervention is automatically active after every driving off.

Display in the instrument cluster

Different system statuses are displayed on the instrument cluster, depending on vehicle equipment and national-market version.

Icon	Meaning
	Indicator light flashes green: System is performing a steering intervention.

Depending on vehicle equipment and national-market version, information for the system is displayed in the Assisted View of the instrument cluster.

Additional information:

Assisted View, refer to page 161.

Warning function

If you leave the lane

If you leave the lane and if a lane boundary has been detected, the steering wheel vibrates



in accordance with the steering wheel vibration setting.



In addition, the indicator light flashes green.

When the turn signal is switched on in the corresponding direction before changing the lane, a warning is not issued.

Steering intervention

Depending on the equipment and the national-market version: if a lane marking is crossed in the speed range up to 130 mph/210 km/h, the system intervenes with a brief active steering intervention in addition to vibrating. The system supports the driver in keeping the vehicle within the lane. The steering intervention can be noticed on the steering wheel and can be manually overridden at any time.



When steering intervention is active, the indicator light flashes green.

For instance, the steering intervention will be suppressed in the following situations:

- ▶ With hard accelerating or braking.
- ▶ When flashing.
- ▶ With hazard warning system switched on.
- ▶ In driving situation with high driving dynamics.
- ▶ While Dynamic Stability Control regulates driving stability.
- ▶ While Dynamic Stability Control is limited.
- ▶ Immediately following a steering intervention by the vehicle systems.

Warning signal

Depending on the national-market version: in the event of multiple active steering interventions by the system within 3 minutes without the driver's intervention at the steering wheel during the steering intervention itself, an acoustic warning will sound. A short warning signal will sound at the second steering inter-

vention. Beginning with the third steering intervention, a continuous warning will sound.

In addition, a Check Control message is displayed.

The warning signal and Check Control message advise to pay closer attention to the lane.

The extended warning tone stops when the steering wheel is moved manually.

With trailer towing

If the trailer power socket is occupied or trailer towing is activated, for instance during operation with trailer, no steering intervention takes place.

If using a rear carrier on the trailer hitch, this restriction does not apply when trailer towing is activated on the control display.

Additional information:

Driving with trailer or rear carrier, refer to page [336](#).

End of warning

For instance, the warning or an active steering intervention will be canceled in the following situations:

- ▶ Automatically after a few seconds.
- ▶ When returning to your own lane.
- ▶ With hard accelerating or braking.
- ▶ With hazard warning system switched on.
- ▶ When flashing.
- ▶ While Dynamic Stability Control regulates driving stability.
- ▶ Immediately following a steering intervention by the vehicle systems.
- ▶ With manual steering intervention.
- ▶ When another driver assistance system is activated, if applicable.
- ▶ No lane boundaries detected.
- ▶ When the system limits are reached.

System limits

General information

Follow the system limits in the "Collision warning systems" chapter.

Functional limitations

The system may be limited in the following situations:

- ▶ In the event of missing, worn, poorly visible, merging, diverging, or multiple lane boundaries such as in construction areas.
- ▶ With lane boundaries that are covered in snow, ice, dirt or water.
- ▶ In tight corners or on narrow roads.
- ▶ With lane boundaries that are covered by objects.
- ▶ When driving very close to the vehicle in front of you.
- ▶ Up to 10 seconds after turning on drive-ready state using the Start/Stop button.
- ▶ While Dynamic Stability Control regulates driving stability.
- ▶ While Dynamic Stability Control is limited.

A Check Control message may be displayed when the system is limited. A yellow warning light also illuminates, depending on national-market version.

Active Blind Spot Detection with active return

Principle

Active Blind Spot Detection detects vehicles in the blind spot or vehicles approaching from behind in the adjacent lane.

The warning light in the exterior mirror gives warnings at different levels.

An automatic steering intervention helps to keep the vehicle in its lane.

General information

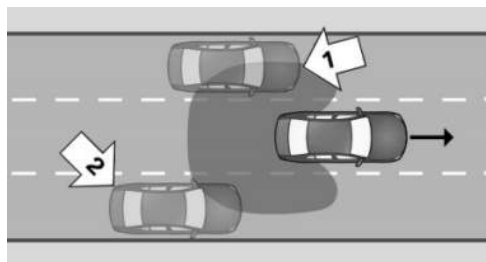

Radar sensors monitor the area behind and next to the vehicle when traveling faster than a minimum speed.

The minimum speed is country-specific and displayed in the Active Blind Spot Detection menu.

The system indicates whether there are vehicles in your blind spot, arrow 1, or approaching from behind in an adjacent lane, arrow 2. The warning light in the exterior mirror illuminates dimly.

The system will warn in the previously named situations prior to a lane change. The warning light in the exterior mirror flashes and the steering wheel vibrates.

When turning at a speed of up to approx. 12 mph/20 km/h, the steering wheel will not vibrate.

Safety information

Follow the safety information in the "Forward Collision Mitigation" chapter.

Sensors

The system is controlled by the following sensors:

- ▶ Camera behind the windshield.
- ▶ Radar sensors, side, rear.
- ▶ Depending on the equipment: radar sensors, side, front.

Functional requirement

The areas of the sensors must be clean and clear.

Turning Active Blind Spot Detection on/off

1. **■ ■** Apps menu
2. "Vehicle"
3. "Driving settings"
4. "Driver Assistance"
5. "Safety and warnings"
6. "Active Blind Spot Detection"
7. Select the desired setting.

Adjusting the Active Blind Spot Detection

Configuring the warning

1. **■ ■** Apps menu
2. "Vehicle"
3. "Driving settings"
4. "Driver Assistance"
5. "Safety and warnings"
6. "Active Blind Spot Detection"
7. Select the desired setting.

Setting the intensity of the steering wheel vibration

1. **■ ■** Apps menu
2. "Vehicle"
3. "Driving settings"
4. "Driver Assistance"
5. "Feedback via steering wheel"
6. "Vibration intensity"
7. Select the desired setting.

The setting is applied to all collision warning systems.

Depending on the national-market version: turning steering intervention on/off

1. **■ ■** Apps menu
2. "Vehicle"
3. "Driving settings"
4. "Driver Assistance"
5. "Safety and warnings"
6. "Active Blind Spot Detection"
7. "Steering intervention"

Warning function

Warning light in exterior mirror



The warning light in the exterior mirror warns of a possible collision with a detected vehicle.

Prewarning

The dimmed warning light in the exterior mirror indicates when vehicles are in your blind spot or approaching from the rear.

Acute warning

When an acute warning occurs, the steering wheel vibrates briefly. The warning light in the exterior mirror flashes brightly.

An acute warning is issued if the following conditions are met:

- ▷ Another vehicle is located in the critical area.
- ▷ Your own vehicle is approaching the other lane.
- ▷ Depending on the system setting when the turn signal is turned on.

The warning stops when the other vehicle has left the critical area.

Steering intervention

Depending on the national-market version: when there is no response to the vibration of the steering wheel at speeds of up to 130 mph/210 km/h and the lane marking is crossed, the system engages the active steering intervention. The steering intervention helps return the vehicle into the lane. The steering intervention can be noticed on the steering wheel and can be manually overridden at any time.

The steering intervention is carried out from a minimum speed. The minimum speed is displayed on the control display.

With trailer towing

No steering intervention is performed when the trailer power socket is occupied or trailer towing is activated. This system does not issue a pre-warning.

Depending on vehicle equipment and national-market version: An acute warning continues to be issued if there is a risk of collision.

The warning function may be restricted. Warnings can be displayed late or not at all, e.g., if the speed of the approaching vehicle is much higher than your own speed. An increased number of unwarranted warnings may occur. A Check Control message is displayed.

Warning light flashing

When the vehicle is unlocked, the warning light in the exterior mirror flashes for self-testing purposes.

System limits

General information

Follow the system limits in the "Collision warning systems" chapter.

Upper speed limit

If the vehicle speed exceeds approx. 155 mph/250 km/h, the system is deactivated temporarily.

If the vehicle speed falls below approx. 155 mph/250 km/h, the system is reactivated.

Displaying warnings

The number of warnings shown depends on how the settings are configured. However, there may also be an excess of unwarranted warnings of critical situations.

Functional limitations

The system may be limited in the following situations:

- ▷ When a vehicle is approaching at a speed much faster than your own.
- ▷ In tight corners or on narrow roads.
- ▷ The bumper is dirty, iced up or covered, for instance by stickers.

Depending on the national-market version, the steering intervention e.g. in the following situations:

- ▷ In the event of missing, worn, poorly visible, merging, diverging, or multiple lane boundaries such as in construction areas.
- ▷ With lane boundaries that are covered in snow, ice, dirt or water.
- ▷ With lane boundaries that are not white.
- ▷ With lane boundaries that are covered by objects.
- ▷ When driving very close to the vehicle in front of you.

- ▷ If the camera is impaired.
- ▷ Up to 10 seconds after turning on drive-ready state using the Start/Stop button.

A Check Control message may be displayed when the system is limited. A yellow warning light also illuminates, depending on national-market version.

Side collision mitigation

Principle

The side-collision warning helps to avoid an impending side collision.

General information

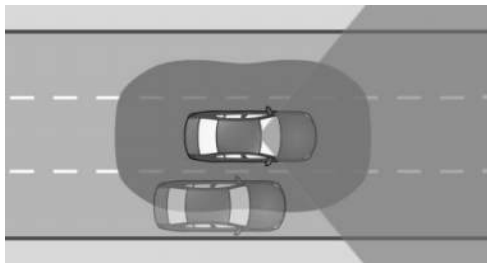

Radar sensors monitor the space next to the vehicle when traveling faster than a minimum speed and up to approx. 130 mph/210 km/h.

The minimum speed is country-specific and displayed on the control display.

If, for example, another vehicle is detected next to your vehicle and there is a risk of collision with this vehicle, the system helps avoid a collision. For this purpose, the system issues a warning with a flashing LED in the exterior mirror, a Check Control message and a vibrating steering wheel. If necessary, an active steering intervention is performed by the system.

Safety information

Follow the safety information in the "Forward Collision Mitigation" chapter.

Functional requirement

The camera behind the windshield determines the lane boundary positions.

The camera must detect the lane markings for the side collision mitigation with steering intervention to be active.

Sensors

The system is controlled by the following sensors:

- ▷ Camera behind the windshield.
- ▷ Radar sensors, side, front.
- ▷ Radar sensors, side, rear.

Turning the side collision warning on/off

1. Apps menu
2. "Vehicle"
3. "Driving settings"
4. "Driver Assistance"
5. "Safety and warnings"
6. "Side collision warning"
7. Select the desired setting.

Setting the intensity of the steering wheel vibration

1. Apps menu
2. "Vehicle"
3. "Driving settings"
4. "Driver Assistance"
5. "Feedback via steering wheel"
6. "Vibration intensity"
7. Select the desired setting.

The setting is applied to all collision warning systems.

Display in the instrument cluster

Depending on vehicle equipment and national-market version, information for the system is



displayed in the Assisted View of the instrument cluster.

Additional information:

Assisted View, refer to page 161.

Warning function

Warning light in exterior mirror



The warning light in the exterior mirror warns of a possible collision with a detected vehicle.

Acute warning

If there is a risk of collision, the warning light in the exterior mirror flashes and the steering wheel starts vibrating.

A Check Control message is displayed at the same time.

Steering intervention

Depending on the national-market version, if necessary, the system engages the active steering intervention to prevent a collision and maintain the vehicle within its own lane. The steering intervention can be noticed on the steering wheel and can be manually overridden at any time.

System limits

General information

Follow the system limits in the "Collision warning systems" chapter.

Functional limitations

The system may be limited in the following situations:

- ▶ In tight corners or on narrow roads.
- ▶ In the event of missing, worn, poorly visible, merging, diverging, or multiple lane boundaries such as in construction areas.
- ▶ With lane boundaries that are covered in snow, ice, dirt or water.
- ▶ With lane boundaries that are not white.
- ▶ With lane boundaries that are covered by objects.
- ▶ When driving very close to the vehicle in front of you.
- ▶ Up to 10 seconds after turning on drive-ready state using the Start/Stop button.

A Check Control message may be displayed when the system is limited.

The system is inactive when the trailer power socket is occupied or trailer towing is activated, e.g., when using a trailer or rear bicycle rack. A Check Control message is displayed.

Rear-end collision preparation

Principle

Depending on the equipment and national-market version, the rear-end collision preparation can react to vehicles approaching from behind.



General information

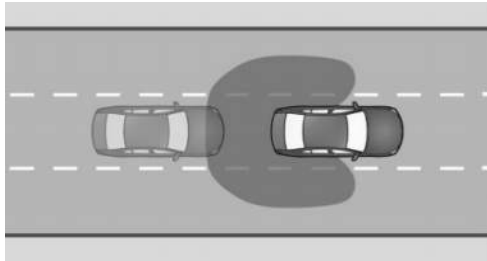

Radar sensors monitor the area behind the vehicle.

When a vehicle approaches from the rear at a certain speed, the system can react as follows:

- ▶ Where applicable, the hazard warning flashers will be switched on.
- ▶ Where applicable, the PreCrash functions are triggered.

Safety information

Follow the safety information in the "Forward Collision Mitigation" chapter.

Sensors

The system is controlled by the radar sensors on the sides and rear.

Turning rear-end collision preparation on/off

The system is automatically active when the vehicle is turned on.

The system is deactivated in the following situations:

- ▶ When driving in reverse.
- ▶ When the trailer power socket is occupied or trailer towing is activated, e.g., when using a trailer or rear bicycle rack.

System limits

General information

Follow the system limits in the "Collision warning systems" chapter.

Functional limitations

This function may be restricted if the speed of the approaching vehicle is much higher or similar to your own speed.

Traffic Light And Sign Warning

Principle

The Traffic Light And Sign Warning provides support in situations in which the right-of-way needs to be yielded based on road signs or traffic lights.

General information

The system evaluates traffic signs and traffic lights using a camera behind the windshield.

The navigation system directs information on the road layout to the system.

A warning is given if the right of way is about to be violated, e.g., in the following traffic situations:

- ▶ At an intersection.
- ▶ At a road entrance.
- ▶ On a highway entrance ramp.
- ▶ At a roundabout.
- ▶ With a red traffic light.

The system issues a warning as from a variable minimum speed and at speeds up to approx. 60 mph/100 km/h.

The following traffic signs are taken into account for the Traffic Light And Sign Warning:

Sign **Meaning**

Give way signs:
A pre-warning is issued for these road signs.



Stop signs:
A pre-warning is issued for these road signs.



When traffic lights are red, a pre-warning and an acute warning will be issued.

Safety information

Follow the safety information in the "Forward Collision Mitigation" chapter.

Functional requirement

The right-of-way situation ahead of the vehicle must be clearly controlled by traffic signs or light signal systems.

Sensors

The system is controlled by a camera behind the windshield.

Turning the Traffic Light And Sign Warning on/off

1.  Apps menu
2. "Vehicle"
3. "Driving settings"
4. "Driver Assistance"
5. "Safety and warnings"
6. "Traffic Light and Sign Warning"
7. Select the desired setting.

Setting the warning time

1.  Apps menu
2. "Vehicle"
3. "Driving settings"

4. "Driver Assistance"
5. "Safety and warnings"
6. "Traffic Light and Sign Warning"
7. Select the desired setting.

The selected setting is saved and adopted for the next journey.

Warning function

General information



The system issues a two-phase warning:

- ▷ Prewarning: visual warning by an icon in the instrument cluster.
- ▷ Acute warning: visual warning by an icon in the instrument cluster and an additional acoustic signal.

The timing of the warning varies with the actual driving situation and the warning time setting.

Prewarning

If there is a risk that a right of way is about to be violated, one of the following icons appears in the instrument cluster:

Icon	Meaning
	Give way.
	Stop.
	Red traffic light.

When a prewarning is issued, intervene as appropriate for the situation; for example, by braking.

Acute warning

If there is an acute risk that the right of way is about to be violated, an acoustic signal will



sound and one of the following icons will appear in the instrument cluster:

Icon	Meaning
------	---------



When an acute warning is issued, intervene as appropriate for the situation; for example, by braking.

Display in the Head-up display

Depending on the vehicle equipment, the warning is displayed simultaneously in the Head-up display and in the instrument cluster.

System limits

General information

Follow the system limits in the "Collision warning systems" chapter.

No warning

The system does not issue a warning in the following situations, for example:

- ▶ In right-of-way situations without right-of-way signs, stop signs, or red light signal systems.
- ▶ With intersections with relevant traffic lights that are illuminated yellow or green.

Functional limitations

The system may be limited in the following situations:

- ▶ If road signs or light signal systems are unclear.
- ▶ If traffic signs or light signal systems are fully or partially concealed or soiled.
- ▶ If traffic signs or light signal systems are difficult to read or rotated.
- ▶ If traffic signs or light signal systems are too small or too large.

- ▶ If the traffic signs do not correspond to the standard.
- ▶ When traffic signs are detected that apply to a junction or parallel street.
- ▶ In the presence of country-specific road signs or road layouts.
- ▶ With intersections with flashing light signal systems.
- ▶ Up to 10 seconds after turning on drive-ready state using the Start/Stop button.
- ▶ In the case of navigation data that is invalid, outdated or not available.
- ▶ In some regions, the system may not be available or only partially available.

Wrong way warning

Principle

The wrong way warning warns the driver of an upcoming wrong entry onto roads, for instance onto freeways, roundabouts and one-way streets.

General information

Depending on the equipment version, the system uses navigation data and traffic signs to check the traffic situation.

For example, the system takes the following traffic signs into account:

- ▶ No entrance.
- ▶ Roundabout.
- ▶ Directional arrows: mandatory bypass.

Safety information

Follow the safety information in the "Forward Collision Mitigation" chapter.

Functional requirement

The road layout ahead must be controlled clearly with traffic signs.

Sensors

The system is controlled by a camera behind the windshield.

Turning wrong way warning on/off

Depending on national-market version, the wrong way warning is automatically activated whenever you start driving.

Warning function



A warning is displayed and a signal tone sounds, for example when the vehicle is traveling in the wrong direction on a highway, roundabout or one-way street.

Warnings are displayed in the instrument cluster and, depending on the equipment, in the Head-up display.

System limits

General information

Follow the system limits in the "Collision warning systems" chapter.

No warning

For example, the system does not issue a warnings for road layouts without traffic signs.

Functional limitations

The function may be limited in the following situations, for instance, and will either output an incorrect wrong way warning or no warning at all:

- ▶ When the signage is not clear.
- ▶ If the traffic signs are fully or partially concealed or soiled.
- ▶ If the traffic signs are poorly legible or rotated.
- ▶ If the traffic signs are too small or too large.
- ▶ If the traffic signs do not correspond to the standard.

- ▶ When traffic signs are detected that apply to a junction or parallel street.
- ▶ In the presence of country-specific road signs or road layouts.
- ▶ Up to 10 seconds after turning on drive-ready state using the Start/Stop button.
- ▶ In the case of navigation data that is invalid, outdated or not available.
- ▶ It may not be possible to use the system in all regions.

No Turn on Red function

Principle

This function provides assistance to the driver at traffic lights where turning on red is prohibited.

To do so, this function analyzes traffic lights and traffic signs using the camera behind the windshield. In addition, the navigation system data is used.

Safety information

Follow the safety information in the "Forward Collision Mitigation" chapter.

Functional requirements

- ▶ The system detects the right-of-way situation ahead by analyzing traffic lights and traffic signs.
- ▶ Vehicle is less than approx. 164 ft/50 m from the traffic lights.
- ▶ Depending on vehicle equipment: the Traffic Light And Sign Warning is turned on.

Sensors

The system is controlled by a camera behind the windshield.



Display in the instrument cluster



If the driver approaches a red traffic light with a traffic sign that prohibits a turn on red, an indicator light is displayed on the instrument cluster.

The indicator light goes out automatically after you drive off at a speed greater than approx. 9 mph/15 km/h.

System limits

General information

Follow the system limits in the "Collision warning systems" chapter.

Functional limitations

The system may be limited in the following situations:

- ▶ If road signs or light signal systems are unclear.
- ▶ If traffic signs or light signal systems are fully or partially concealed or soiled.
- ▶ If traffic signs or light signal systems are difficult to read or rotated.
- ▶ If traffic signs or light signal systems are too small or too large.
- ▶ If the traffic signs do not correspond to the standard.
- ▶ With intersections with flashing light signal systems.
- ▶ In the case of navigation data that is invalid, outdated or not available.
- ▶ In some regions, this function may not be completely available or not available at all.

Emergency Stop Assistant

Principle

If the driver can no longer drive the vehicle safely, the Emergency Stop Assistant helps to bring the vehicle to a safe standstill.

General information

The Emergency Stop Assistant is triggered automatically.

When the system is triggered, the vehicle is brought to a standstill in its own lane by use of lane keeping.

Safety information

Warning

The system cannot serve as a substitute for the driver's personal judgment in assessing one's physical state. An increasing lack of alertness or fatigue may not be detected or not be detected in time. There is a risk of accident, injury, and property damage. Make sure that the driver is rested and alert. Adjust driving style to traffic conditions.

Functional requirements

- ▶ The Emergency Stop Assistant is activated via iDrive.
- ▶ The system is activated from a speed of approx. 43 mph/70 km/h.
- ▶ The Driver Attention Camera detects driver activity.

Triggering the Emergency Stop Assistant

If the system detects that the driver is no longer driving the vehicle safely or ignores warnings, the Emergency Stop Assistant is triggered automatically. The triggered system is displayed in the instrument cluster.

The Emergency Stop Assistant can also be triggered via voice input.

Additional information:

BMW Intelligent Personal Assistant, refer to page 53.

An immediate emergency call can be triggered on the control display.

The following is performed automatically when the Emergency Stop Assistant is triggered:

- ▶ A display is shown on the instrument cluster.
- ▶ The system takes over vehicle handling until the vehicle comes to a standstill.
- ▶ The hazard warning system is switched on.
- ▶ An emergency call is triggered when stationary, depending on vehicle equipment.

Activating/deactivating Emergency Stop Assistant

1.  Apps menu
2. "Vehicle"
3. "Driving settings"
4. "Driver Assistance"
5. "Safety and warnings"
6. "Emergency stop"
7. Select the desired setting.

Canceling Emergency Stop Assistant

The driver can cancel the Emergency Stop Assistant by actively taking control of the vehicle throughout the entire process.

For instance, the system will be canceled in the following situations:

- ▶ With strong countersteering.
- ▶ When flashing.
- ▶ If the accelerator pedal is pressed hard.
- ▶ When switching off the hazard warning system.

- ▶ If the system is interrupted on the control display.
- ▶ When changing the selector lever position if the vehicle was already stationary.

At standstill

As soon as the vehicle is stationary, the system will carry out the following settings:

- ▶ The vehicle is secured against rolling away.
- ▶ The interior lights are switched on.
- ▶ The central locking system is unlocked.

Display in the instrument cluster

Icon	Status
	Emergency Stop Assistant is triggered.



Emergency Stop Assistant is triggered.

System limits

The system cannot replace the roadworthy driving performance of a driver.

The Emergency Stop Assistant may be restricted in the following situations:

- ▶ When the Driver Attention Camera is covered by the steering wheel.
- ▶ With sunglasses with high protection from infrared light.

Cross Traffic Warning with Braking

Principle

At blind driveway exits or when driving out of perpendicular parking spaces, road users approaching from the side are detected sooner by the cross traffic warning than is possible from the driver's seat.

General information

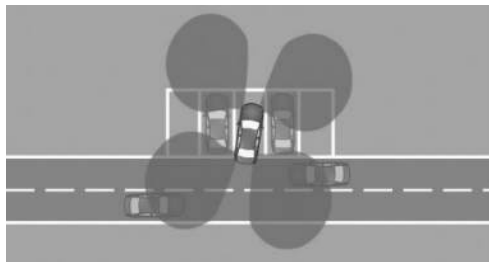

The area behind the vehicle is monitored by sensors.

Depending on the vehicle equipment, the area around the vehicle in front of the vehicle is monitored as well.

The system indicates approaching road users. If there is a collision risk when reversing, the system will provide assistance by performing an automatic brake intervention.

Follow the information in the "Parking assistance systems" chapter.

Safety information

Warning

The system cannot serve as a substitute for the driver's personal judgment in assessing the traffic situation. Based on the limits of the system, it cannot independently react to all traffic situations. There is a risk of accident, injury, and property damage. Adjust driving style to traffic conditions. Watch the surrounding traffic situation closely, be ready to take over steering and braking at any time, and actively intervene where appropriate.

Sensors

The system is controlled by the following sensors:

- ▷ Radar sensors, side, rear.
- ▷ Depending on the equipment: radar sensors, side, front.

Activating/deactivating Cross Traffic Warning

The system must be activated on the control display for the Cross Traffic Warning and brake intervention to switch on automatically.

1. **■ ■** Apps menu
2. "Vehicle"
3. "Driving settings"
4. "Driver Assistance"
5. "Parking"
6. Depending on the equipment, select the following setting:
 - ▷ "Rear warning"
 - ▷ "Front and rear warning"
 - ▷ "Brake intervention at rear"

Turning on the cross traffic warning automatically

The system must be activated on the control display. The system turns on automatically as soon as Park Distance Control or a camera view activates and you engage a gear position. If reverse gear is engaged, the rear system is switched on.

Depending on the equipment, the front system is turned on when a gear position is engaged.

Depending on the national-market version, the system is automatically active when the vehicle is started.

Turning off the cross traffic warning automatically

The system is automatically turned off in the following situations:

- ▷ When the speed exceeds walking speed.
- ▷ When a certain distance covered is exceeded.

Warning function

General information

The control display shows the corresponding view, an acoustic signal may sound as necessary, and the warning light in the exterior mirror flashes.

In case of a brake intervention, a message is displayed on the control display and close after a brief period of time.

Visual warning

Warning light in exterior mirror



The warning light in the exterior mirror flashes if the rear sensors detect other vehicles when the vehicle is reversing.

Display in the Park Distance Control view



In the Park Distance Control view, the respective boundary area flashes red if vehicles are detected by the sensors.

Display in camera image

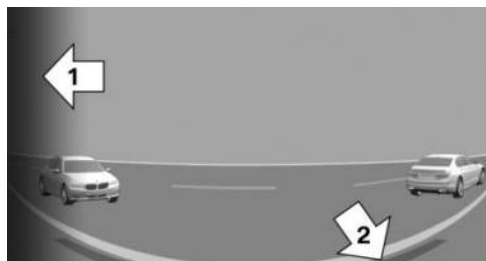

Depending on the direction of travel, the view to the front or back is displayed in the camera image.

The respective boundary area, arrow 1, in the camera image flashes red if vehicles are detected by the sensors.

Yellow lines, arrow 2, mark the bumper of your own vehicle.

Acoustic warning

In addition to the visual warning, a signal tone sounds if your own vehicle moves into the respective direction.

Depending on the national-market version, the signal tone will already sound when the gear position is engaged.

System limits

System limits of the sensors

Additional information:

Sensors of the vehicle, refer to page 35.

Functional limitations

The function can be limited, for instance in the following situations:

- ▷ In tight curves.
- ▷ Crossing objects are moving at a very slow or a very fast speed.
- ▷ Other objects that hide cross traffic are in the capture range of the sensors.
- ▷ If the trailer power socket is occupied or trailer towing is activated, the cross traffic warning is not available for the area behind the vehicle.

BMW Drive Recorder

Principle

The BMW Drive Recorder stores brief video recordings of the vehicle surroundings, e.g., to document surrounding traffic.

General information

Video recordings can be saved in different ways:

- ▷ Automatic storage of the recording.
The function makes it possible to document the accident or theft of the vehicle with the corresponding recording type set.
- ▷ Manual storage of the recording.
This function is used to document traffic situations with the configured recording type.

The assistance systems' cameras are used to record, e.g., Panorama View.

Additionally, the following parameters are stored for the trip:

- ▷ Date.
- ▷ Time.
- ▷ Vehicle speed.
- ▷ Global Positioning System coordinates.

Data protection

The permissibility of recording and using video recordings is contingent upon the statutory regulations of the country in which the system is to be used. The user is responsible for the use of the system and compliance with respective applicable regulations.

The manufacturer of the vehicle recommends confirming there are no statutory or regulatory constraints on use of the system in your state or country prior to the initial use. In addition, the laws with respect to use of the system should be verified in regular intervals, especially when borders are frequently crossed.

Other drivers of the vehicle must be informed about the system. In addition, information about the system is required when handing off the vehicle.

Functional requirements

- ▷ Standby state or drive-ready state is switched on.
- ▷ BMW Drive Recorder is activated.
- ▷ Privacy Policy was accepted.
- ▷ Recording type was selected.
- ▷ Recording time was selected.

Theft notification:

- ▷ The theft notification was activated in the Data Protection menu or in the Drive Recorder menu.
- ▷ Data transfer is activated.
- ▷ My BMW App is installed on the mobile device.
- ▷ My BMW App is linked with the Connected-Drive account.
- ▷ Privacy Policy was accepted.

Activating/deactivating the BMW Drive Recorder

The BMW Drive Recorder must be activated before the first use of the recording function.

1.  Apps menu
2. "All apps"
3. "Drive Recorder"
4. Accept Privacy Policy.
5. "Settings"
6. "Allow recording"
7. Select the desired setting.

Recording functions

Automatic recording

The recording is automatically stored when the vehicle sensors detect an accident or theft.

▷ In case of accident:

The system saves recordings up to 30 seconds before and after storage is triggered.

▷ In case of theft:

Depending on the selected recording duration, the system saves the recording after it has been triggered.

When the alarm system is triggered, a message is sent to the My BMW App.

After saving the recording, the reduced quality video can be downloaded to a mobile device.

If the vehicle accelerates rapidly, an automatic recording may be taken.

Manual recording

Using the button

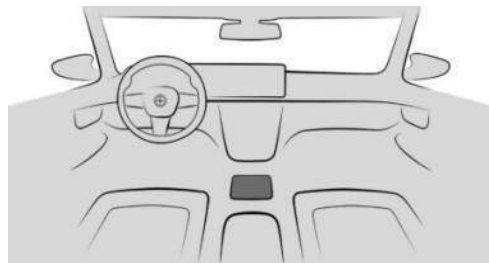

Press and hold this button.

Via iDrive

Start the recording:

1.  Apps menu
2. "All apps"
3. "Drive Recorder"
4. "Recording"
5. "Start recording"

Stop the recording: "Stop recording".

The system saves recordings up to 30 seconds before and after storage is triggered.

Recording playback and administration

Stored video recordings can be played back, exported and deleted.

For your own safety, the video recording is only displayed on the control display up to approx. 2 mph/3 km/h. In some national-market versions, the video recording is only displayed if the parking brake is engaged or if the selector lever is in the P position.

1.  Apps menu
2. "All apps"
3. "Drive Recorder"
4. "Recordings"

5. Select desired recording.
6. If necessary, select camera.

Settings

Recording type

1.  Apps menu
2. "All apps"
3. "Drive Recorder"
4. "Settings"
5. Select the desired setting.

Recording time

1.  Apps menu
2. "All apps"
3. "Drive Recorder"
4. "Settings"
5. Select the desired setting.

Recording on a mobile device

Principle

Depending on the equipment version, video recordings can be stored directly on a mobile device such as a smartphone or USB storage.

General information

The length of the video that can be stored depends on the available memory capacity on the mobile device.

Functional requirements

- ▶ Privacy Policy was accepted.
- ▶ BMW Drive Recorder is activated.

To transfer recordings to a mobile device:

- ▶ Depending on vehicle equipment, a mobile device is connected to the vehicle via Wi-Fi

and Bluetooth audio, or a USB storage device is connected.

- ▶ My BMW App is installed on the mobile device.
- ▶ My BMW App is linked with the Connected-Drive account.
- ▶ The My BMW App is permitted to access your photo library.

Recording

The recording can be started and stopped manually.

Start the recording:

1.  Apps menu
2. "All apps"
3. "Drive Recorder"
4. "Recording"
5. "Start recording"

Stop the recording: "Stop recording".

Cameras

Different cameras can be selected.

1.  Apps menu
2. "All apps"
3. "Drive Recorder"
4. "Settings"
5. "Cam. selection"
6. Select desired camera.

System limits

In the event of serious accidents, it may not be possible to store recordings if the damage on the vehicle is too great or the power supply was interrupted.

If you repeatedly overwrite a USB drive, it may not be possible to export recordings correctly.

The preferred file system for USB storage is NTFS. Other file systems may have limitations.

In case of theft, the recording is only stored automatically when the anti-theft warning system has been triggered.

If the internet connection is weak or cannot be established, theft alerts and video downloads may be restricted or not available.

The quality of the Wi-Fi connection affects whether recordings can be saved on your smartphone. This function may be restricted or not available if the connection is weak.

Active Protection

Principle

Active Protection prepares occupants and the vehicle for a possible accident in critical driving or collision situations.

General information

Depending on vehicle equipment and national-market version, Active Protection consists of various PreCrash functions.

The system is used to detect certain critical driving situations that might lead to an accident. This includes the following critical driving situations:

- ▷ Emergency braking.
- ▷ Severe understeering.
- ▷ Severe oversteering.

Certain functions of several systems can, within the system limits, lead to Active Protection triggering:

- ▷ Forward Collision Mitigation: automatic brake intervention.
- ▷ Forward Collision Mitigation: brake booster.
- ▷ Rear-end collision preparation: detection of impending rear-end collisions.

Safety information

Warning

The system cannot serve as a substitute for the driver's personal judgment. Due to the system limits, critical situations might not be detected reliably or in time. There is a risk of accident. Adjust driving style to traffic conditions. Watch surrounding traffic closely and actively intervene where appropriate

Function

Depending on the equipment and requirements, the following individual functions are active in accident-critical driving situations:

- ▷ Automatic closing of the windows.
 - The windows remain open with a small gap.
- ▷ The glass sunroof/panoramic glass sunroof closes automatically.
 - The sun protection is also closed.
- ▷ Automatic positioning of the backrest for the front passenger seat.

Systems can be returned to the desired settings following a critical driving situation without accident.

PostCrash iBrake

Principle

In certain accident situations, the PostCrash iBrake can automatically bring the vehicle to a standstill without intervention by the driver.

General information

The PostCrash iBrake can reduce the risk of a further collision and its consequences.



At standstill

After coming to a halt, the brake is released automatically.

Harder vehicle deceleration

In certain situations, it may be necessary to bring the vehicle to a stop more quickly than automatic braking with PostCrash iBrake.

To do this, quickly apply extra force to the brake. The brake pressure will then be higher than the brake pressure generated by automatic braking. Automatic braking with Post-Crash iBrake is canceled.

Abort automatic braking

It may be necessary to cancel PostCrash iBrake automatic braking in certain situations, e.g., when making an evasive maneuver.

Abort automatic braking:

- ▶ By depressing the brake pedal for slightly longer.
- ▶ By pressing the accelerator pedal for slightly longer.

Fatigue alert

Principle

The Fatigue Alert break recommendation feature can detect when the driver is fatigued or less alert during long, monotonous trips, for instance on highways. The system recommends a break.

Safety information

Warning

The system cannot serve as a substitute for the driver's personal judgment in assessing one's physical state. An increasing lack of alertness or fatigue may not be detected or not be detected in time. There is a risk of

accident, injury, and property damage. Make sure that the driver is rested and alert. Adjust driving style to traffic conditions.

Break recommendation

Function

After starting the trip, the system is trained to the driver, so that decreasing alertness or fatigue can be detected.

This procedure takes, for example, the following criteria into account:

- ▶ Personal driving style, for instance steering behavior.
- ▶ Driving conditions, for instance time, length of trip.
- ▶ Depending on the equipment: attention of the driver through the Driver Attention Camera.

The system is active starting at approx. 43 mph/70 km/h and can also display a break recommendation.

Setting break recommendation

The break recommendation can be switched on, off and adjusted via iDrive.

1.  Apps menu
2. "Vehicle"
3. "Driving settings"
4. "Driver Assistance"
5. "Safety and warnings"
6. "Fatigue Alert"
7. Select the desired setting.

Despite this function being off, some driver assistance systems may issue break recommendations.

Display

If the driver becomes less alert or fatigued, a message is displayed in the control display with the recommendation to take a break.

During the display, various settings can be selected.

The system is reset approx. 45 minutes after parking the vehicle. A break recommendation can only be displayed again after this time has elapsed.

System limits

The Fatigue Alert system may be limited. If the system is limited, either no warning may be issued or an unwarranted warning may be issued.

The break recommendation function may be limited in the following situations:

- ▶ If the time is set incorrectly.
- ▶ At a predominantly driven speed below approx. 43 mph/70 km/h.
- ▶ With a sporty driving style such as during rapid acceleration or when cornering fast.
- ▶ In active driving situations such as when changing lanes frequently.
- ▶ When the road condition is poor.
- ▶ In the event of strong side winds.

Driver Attention Camera

Principle

A camera in the instrument cluster monitors the driver's activity and, depending on the equipment, the driver's viewing direction.

General information

The assistance systems help drivers by analyzing whether they are paying attention, e.g., by evaluating their head position and eyes.

For full operability, make sure that the field of view of the Driver Attention Camera is not obstructed.

Overview



Depending on vehicle equipment, the instrument cluster may have some infrared light sources. Depending on the light conditions, these light sources can be visible when the vehicle is in standby mode.

System limits

The Driver Attention Camera may not be fully operational in the following situations:

- ▶ When the Driver Attention Camera is covered by the steering wheel.
- ▶ With sunglasses with high protection from infrared light.

Driving stability control systems

Vehicle features and options

This chapter describes model-specific equipment, systems, and functions that are currently available, or may become available in the future, even if they are not present in the vehicle.

Additional information:

Vehicle equipment, refer to page 8.

Antilock Braking System

Principle

The Antilock Braking System prevents locking of the wheels during the braking process.

You remain able to steer your vehicle even during full braking, which increases active driving safety.

General information

The Antilock Braking System is ready after each time drive-ready state is turned on.

Malfunction



The warning light on the instrument cluster illuminates.



A Check Control message is displayed.

- ▶ The Antilock Braking System is not available.
- ▶ Steerability is limited during full braking.

Have the vehicle checked immediately by an authorized service center or another qualified service center or repair shop.

Brake assistant

The brake assistant automatically applies maximum braking assistance when the brake pedal is depressed quickly. This reduces the braking distance to a minimum for full braking.

To make full use of braking assistance, do not reduce the pressure on the brake pedal during full braking.

Dynamic Stability Control

Principle

Dynamic Stability Control helps keep the vehicle on a steady course in critical driving situations. The drive power is reduced depending on the situation, and wheels can be braked individually.

General information

The system detects the following unstable driving conditions, for instance:

- ▶ Skidding, which can lead to oversteering.
- ▶ Loss of adhesion of the front wheels, which can lead to understeering.

Safety information

Warning

The system cannot serve as a substitute for the driver's personal judgment in assessing the traffic situation. Based on the limits of the system, it cannot independently react to all traffic situations. There is a risk of accident, injury, and property damage. Adjust driving style to traffic conditions. Watch the surrounding traffic situation closely, be ready

to take over steering and braking at any time, and actively intervene where appropriate.

Warning

When driving with a roof load, e.g., roof bars, the vehicle's center of gravity is higher. This increases the risk of the vehicle tipping in critical driving situations. There is a risk of accident, injury, or property damage. Drive with roof load only with activated Dynamic Stability Control.

Overview

Button in the vehicle

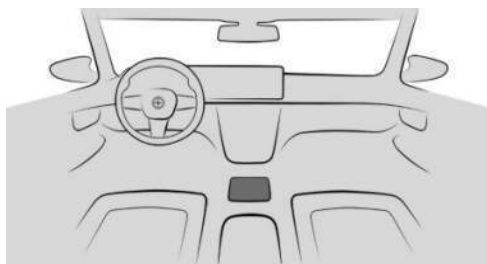

Dynamic Stability Control

Activating/deactivating Dynamic Stability Control



General information

Dynamic Stability Control is automatically activated whenever drive-ready state is switched on.

If Dynamic Stability Control is deactivated, driving stability is limited when accelerating and cornering.

To support driving stability, reactivate Dynamic Stability Control as soon as possible.

Activating/deactivating the system

-  Press the button to open the menu.
- "DSC OFF"
Dynamic Stability Control is deactivated.
-  Press the button again to reactivate Dynamic Stability Control.

Displays in the instrument cluster



View when Dynamic Stability Control is deactivated.



Indicator light illuminates: Dynamic Stability Control is deactivated.



Warning light flashes: Dynamic Stability Control is regulating the driving and brake power. The vehicle is stabilized.

Reduce speed and modify your driving style to the driving circumstances.



Warning light illuminates: Dynamic Stability Control has failed or is initializing. Driving stabilization is restricted or has failed.

If the warning light illuminates continuously, have the vehicle checked immediately by an authorized service center or another qualified service center or repair shop.

Automatic program change

Dynamic Stability Control can be activated automatically by Forward Collision Mitigation depending on the situation. Deactivate Forward Collision Mitigation as necessary.

Additional information:

Forward Collision Mitigation with brake intervention, refer to page [183](#).

Dynamic Traction Control

Principle

The Dynamic Traction Control is a variant of the Dynamic Stability Control where the drive power is optimized.

The system ensures maximum drive power on unusual road conditions, for instance unpaved snow covered roads or loose road surfaces, but with somewhat limited driving stability.

General information

The vehicle has maximum traction when Dynamic Traction Control is on. Driving stability is limited during acceleration and when cornering.

A brief activation of the Dynamic Traction Control may be useful in the following situations:

- ▶ When driving in slush or on uncleared, snow-covered roads.
- ▶ When driving off from deep snow or loose ground.
- ▶ When driving with snow chains.

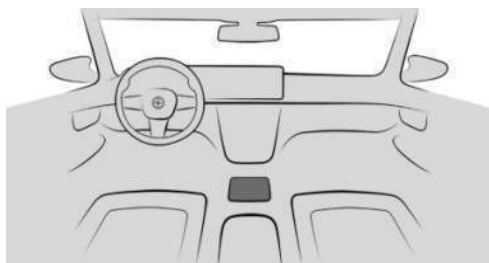

Overview

Button in the vehicle



Dynamic Stability Control

Activating/deactivating the Dynamic Traction Control

1.  Press the button to open the menu.
2. "Traction"
Dynamic Traction Control is activated and Dynamic Stability Control is deactivated.
3.  Press the button again to reactivate Dynamic Stability Control.

Displays in the instrument cluster



View when Dynamic Traction Control is activated.



Indicator light illuminates: Dynamic Traction Control is activated.

Automatic program change

In certain situations, Dynamic Stability Control is activated automatically:

- ▶ When the Distance Control is activated.
- ▶ In case of a brake intervention by Forward Collision Mitigation. Deactivate Forward Collision Mitigation as necessary.
- ▶ If the suspension control system fails.
- ▶ The vehicle has a flat tire.

Additional information:

Forward Collision Mitigation with brake intervention, refer to page 183.

BMW xDrive

Principle

BMW xDrive is the all-wheel-drive system of the vehicle. Concerted action by the BMW xDrive and other suspension control systems

such as Dynamic Stability Control further optimizes traction and driving dynamics.

General information

BMW xDrive variably distributes the drive forces to the front and rear axles as required by the driving situation and road conditions.

With the xOFFROAD package, the all-wheel-drive system is also adjusted to the respective xOFFROAD driving mode.

Display on the control display

In the Live Vehicle menu, information about BMW xDrive can be displayed under the following view:

"xVIEW"

The following information is displayed:

- ▶ Distribution of drive torque to the wheels.
- ▶ Indication of longitudinal inclination in percent.
- ▶ Indication of lateral inclination in percent.
- ▶ Graph of wheel angle.
- ▶ Level adjustment of the two-axle ride level control.
- ▶ With navigation system: elevation for the current position.

Additional information:

Live Vehicle, refer to page 146.

M sport differential

The M Sport differential provides for continuously variable locking of the rear axle differential, depending on the driving situation. This prevents spinning of a single rear wheel and thereby provides optimal traction in any driving situation.

The driver is responsible adapting his or her driving style to the situation.

Hill Descent Control

Principle

Hill Descent Control is a downhill control feature that adjusts the vehicle speed on steep downhill gradients, e.g., when driving on unpaved roads.

General information

When the system is active, the vehicle moves at the speed set by the driver, without the driver having to depress the brake pedal.

While Hill Descent Control is adjusting the speed, the system automatically distributes the brake power to the individual wheels. This improves driving stability and steerability. If necessary, the Antilock Braking System prevents the wheels from locking.

Hill Descent Control can be enabled at speeds below approx. 25 mph/40 km/h.

Speeds can be set between approx.

2 mph/3 km/h and approx. 20 mph/30 km/h.

When the vehicle is driving downhill, the system reduces the speed to the set value, within the physical limits.

Hill Descent Control provides assistance when driving in selector lever positions D, N, and R.

Overview

Button in the vehicle

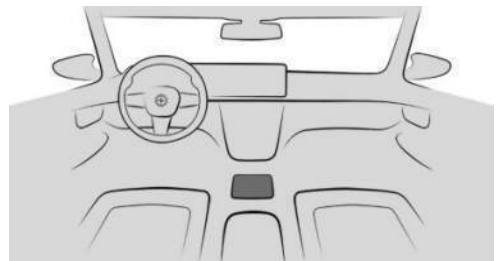

Hill Descent Control

Enabling/disabling Hill Descent Control

Activating the system



Press the button.

Speeds between approx. 2 mph/3 km/h and approx. 20 mph/30 km/h are adopted as the set speed.

20 mph/30 km/h are adopted as the set speed.

While Hill Descent Control is regulating the vehicle speed, the following functions are deactivated:

- ▶ Forward Collision Mitigation.
- ▶ Emergency braking function of Active Park Distance Control.

Additional information:

- ▶ Forward Collision Mitigation, refer to page 183.
- ▶ Active Park Distance Control, refer to page 264.

Deactivating the system



Press the button again.

The system is automatically deactivated above approx. 25 mph/40 km/h.

Display in the instrument cluster

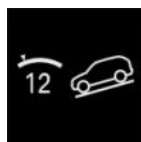

An icon and the selected set speed are displayed.

- ▶ Indicator green: Hill Descent Control is active. The system is actively braking the vehicle.
- ▶ Indicator gray: Hill Descent Control is on standby.

Display in the Head-up display

The status of Hill Descent Control can also be shown on the Head-up display.

Increasing or decreasing vehicle speed

Using the rocker button for cruise control

The set speed can be changed using the cruise control rocker button on the steering wheel.



- ▶ Press rocker button up: Speed increases gradually.
- ▶ Press rocker button up and hold: Speed increases while the rocker button is pressed.
- ▶ Press rocker button down: Speed decreases gradually.
- ▶ Press rocker button down and hold: Speed decreases while the rocker button is pressed.

Using the brake pedal

While Hill Descent Control is adjusting the speed, the target speed set can be reduced by depressing the brake pedal.

Malfunction

If a malfunction occurs, a Check Control message is displayed on the instrument cluster.

Servotronic

Principle

Servotronic is a speed-dependent steering support.

The system provides the steering force with more support at low speeds than at higher ones. This makes it easier to park, for instance, and makes steering firmer when driving at faster speeds.

Setting

The steering force adapts to the drive mode to convey a firm, sporty feel or a comfortable steering response.

Integral Active Steering

Principle

The Integral Active Steering increases the maneuverability of the vehicle and makes a more direct steering response possible. Driving stability is also increased at high speeds.

General information

Integral Active Steering combines variable sport steering with active rear-wheel steering. The rear-wheel steering acts to increase maneuverability at low speeds by turning the rear wheels slightly in the opposite direction to the front wheels.

At higher speeds, the rear wheels are turned in the same direction as the front wheels. For instance, this results in a harmonious lane change.

In critical driving situations, integral active steering can stabilize the vehicle by automatically steering the rear wheels, for example e.g. when oversteering.

Setting

The system offers several different settings.

With the Driving Experience Control driving modes, the system can be set to comfortable or dynamic.

Additional information:

Driving Experience Control, refer to page [138](#).

Using snow chains

In order to guarantee free movement of the wheels when operating with snow chains, rear-wheel steering must be turned off when snow chains are mounted.

Additional information:

Rear-wheel steering during operation with snow chains, refer to page [362](#).

Malfunction



The warning light on the instrument cluster illuminates.

A Check Control message is displayed.

The steering system may not be operational. Integral Active Steering assistance may no longer be provided.

- ▶ Larger steering movements are required at low speeds.
- ▶ The response of the vehicle is more sensitive in higher speed ranges.
- ▶ Proceed cautiously and practice anticipatory driving.

Have the vehicle checked by an authorized service center or another qualified service center or repair shop.

Driver assistance systems

Vehicle features and options

This chapter describes model-specific equipment, systems, and functions that are currently available, or may become available in the future, even if they are not present in the vehicle.

Additional information:

Vehicle equipment, refer to page 8.

Speed warning

Principle

The speed warning can be used to set a speed limit. A warning will be issued when this speed limit is exceeded.

General information

Another speed warning is given when the set speed limit is exceeded again after it has dropped by 3 mph/5 km/h.

Settings

The Speed Limit Warning can be activated or deactivated. In addition, the speed limit for the warning can be configured.

1.  Apps menu
2. "Vehicle"
3. "Driving settings"
4. "Driver Assistance"
5. "Safety and warnings"
6. "Speed warning"
7. Select the desired setting.

Speed Limit Info

Speed Limit Info

Principle

Speed Limit Info shows the currently valid speed limit in the instrument cluster and, if necessary, the Head-up display.

General information

The camera in the area of the interior mirror detects traffic signs at the edge of the road as well as overhead sign posts.

Traffic signs with extra icons are considered and compared with the vehicle's onboard data. The traffic sign will then be either displayed or ignored depending on the situation in the instrument cluster and the Head-up display.

The system may also show speed limits that apply to routes that are not signposted if the navigation system has current map data.

For Speed Limit Info to function correctly, current map data for the country in which the vehicle is operated must be downloaded.

For information on the current map version and map updates, see Map update in the Navigation system chapter.

Without map data, the system is subject to certain technical limitations. Traffic signs with speed limitations are detected and displayed only. Speed limits due to entering towns/cities, highway signs, etc., are not displayed. Speed limits with extra traffic signs are always displayed.

Speed limits for trailer towing will be displayed when the trailer power socket is occupied or trailer towing was activated via iDrive.

Depending on the equipment, an approved maximum speed can be set up for trailer tow-

ing, which will be taken into account for the display of speed limits.

Additional information:

- ▶ Owner's Manual for Navigation, Entertainment, and Communication, refer to page 6.
- ▶ Trailer towing, refer to page 334.

Safety information

Warning





The system cannot serve as a substitute for the driver's personal judgment in assessing the traffic situation. Based on the limits of the system, it cannot independently react to all traffic situations. There is a risk of accident, injury, and property damage. Adjust driving style to traffic conditions. Watch the surrounding traffic situation closely, be ready to take over steering and braking at any time, and actively intervene where appropriate.

Sensors

The system is controlled by a camera behind the windshield.

Display

Speed Limit Info

Icon	Description
	Current speed limit. Depending on the national-market version, it is possible to switch between the units of measurement.
	
	No data on current speed limit available.
	Speed Limit Info not available.

Warning signals

Depending on the settings, an acoustic signal sounds if the detected speed limit is exceeded or the speed limit changes. The display also flashes if the detected speed limit is exceeded.

Settings

Individual settings can be configured for Speed Limit Info, e.g., warnings issued if the speed is exceeded or the permissible maximum speed changes.

1.  Apps menu
2. "Vehicle"
3. "Driving settings"
4. "Driver Assistance"
5. "Driving"
6. "Speed Limit Assistant"
7. Select the desired setting.

System limits

System limits of the sensors

Additional information:

- ▶ Camera, refer to page 35.

Functional limitations

The system function may be limited and may provide incorrect information in the following situations:

- ▶ Traffic signs are fully or partially concealed by objects, stickers, or paint.
- ▶ Traffic signs do not comply with the standard.
- ▶ In areas that are not included in the navigation system map data.
- ▶ If navigation system map data is invalid, outdated, or unavailable.
- ▶ When roads deviate from the navigation such as due to changes in road layout.



- ▶ When driving very close to the vehicle in front of you.
- ▶ When passing buses or trucks with traffic signs applied to them.
- ▶ In case of electronic traffic signs.
- ▶ When traffic signs that are valid for a parallel road are detected.
- ▶ In the presence of country-specific road signs or road layouts.

Speed control systems

Principle

The speed control systems provide support when driving.

General information

Depending on the equipment, the speed control systems include the following individual systems.

- ▶ Cruise control, refer to page [226](#).
- ▶ Distance Control, refer to page [229](#).
- ▶ Assisted Driving Mode, refer to page [235](#).
- ▶ Assisted Driving Mode Plus, refer to page [240](#).

Depending on the equipment and national-market version, the individual systems are enhanced with additional functions.

Some functions can be operated via voice control.

Additional information:

BMW Intelligent Personal Assistant, refer to page [53](#).

Safety information

Warning

The system cannot serve as a substitute for the driver's personal judgment in assessing the traffic situation. Based on the limits of the system, it cannot independently react to all traffic situations. There is a risk of accident, injury, and property damage. Adjust driving style to traffic conditions. Watch the surrounding traffic situation closely, be ready to take over steering and braking at any time, and actively intervene where appropriate.



Overview



Buttons on the steering wheel

Button	Function
	Turn last active speed control system on/off.
	Select the desired speed control system.
	Store current speed. Speed Limit Assistant: accept suggested speed manually.
	Resume speed control systems with the stored setting.
	Interrupt speed control systems.
	Set speed.



Turning on/selecting speed control systems

-  Turn on: press the button.
-  Select: when the system is active, press the button repeatedly until the desired speed control system is displayed in the toolbar in the instrument cluster.

Icon	Speed control system
	Cruise control.
	Distance control.
	Assisted Driving Mode: Cruise Control with Distance Control, Steering Assistance with lane keeping.

The activated system is shown in green.

The system is shown in white when the system can be activated.

The system is grayed out if the system has failed or if the functional requirements are not met.

Interrupting speed control systems automatically

Depending on the system, speed control systems are interrupted automatically, for instance in the following situations:

- ▶ When moving from selector lever position D to P, N, or R.
- ▶ While Dynamic Stability Control regulates driving stability.
- ▶ While Dynamic Stability Control is disabled.

- ▶ While Dynamic Traction Control is activated.
- ▶ When performing a manual braking process.

Interrupting speed control systems manually

 Press the button.

Continuing speed control systems

 Press the button.

Turning off speed control systems automatically

The speed control systems turn off automatically when the drive-ready state is turned off.

Turning off speed control systems manually

 Press the button.
The speed control systems are turned off and the displays extinguish.

Adjusting speed values

 Repeatedly press the rocker button on the steering wheel up or down until the desired value is set.

- ▶ Each time the rocker button is pressed to the resistance point, the set speed increases or decreases by 1 mph/1 km/h.
- ▶ Each time the rocker button is pressed past the resistance point, the set speed changes by a maximum of 5 mph/10 km/h.

Display in the instrument cluster

Marking on speedometer



A mark for the set speed appears on the speedometer.

- ▶ Green marking: system is active.
- ▶ Gray marking: system is interrupted.
- ▶ No marking: system is switched off.

Notifications

In addition to the respective indicator lights, notifications are displayed for some functions.

The scope of notifications can be set.

1.  Apps menu
2. "Vehicle"
3. "Driving settings"
4. "Driver Assistance"
5. "Driving"
6. "Notifications"
7. Select the desired setting.

Cruise Control

Principle

With the Cruise Control, a set speed can be adjusted using the buttons on the steering wheel. The system maintains the set speed. The system accelerates and brakes automatically as needed.

General information

The system can be activated starting at 20 mph/30 km/h.

Depending on the vehicle setting, the Cruise Control settings can change under certain conditions. For instance, the acceleration can change depending on the driving mode.

Safety information

Warning

The system cannot serve as a substitute for the driver's personal judgment in assessing the traffic situation. Based on the limits of the system, it cannot independently react to all traffic situations. There is a risk of accident, injury, and property damage. Adjust driving style to traffic conditions. Watch the surrounding traffic situation closely, be ready to take over steering and braking at any time, and actively intervene where appropriate.

Warning

The use of the system can lead to an increased risk of accidents in the following situations, for instance:

- ▶ On winding roads.
- ▶ With high traffic volume.
- ▶ On slippery roads, in fog, snow, or wet conditions, or on a loose road surface.







There is a risk of accident, injury, and property damage. Only use the system if driving at constant speed is possible.

Warning

The set speed can be incorrectly adjusted or called up by mistake. There is a risk of accident, injury, and property damage. Adjust the set speed to the traffic conditions. Watch surrounding traffic closely and actively intervene where appropriate.

Overview

Buttons on the steering wheel

Button	Function
	Turn last active speed control system on/off.
	Select the desired speed control system.
	Store current speed. Speed Limit Assistant: accept suggested speed manually.
	Resume speed control systems with the stored setting.
	Interrupt speed control systems.
	Set speed.



Turning on the Cruise Control

In vehicles with distance control: change the mode of the Cruise Control to Cruise Control without distance control.

Additional information:

Distance Control, refer to page [229](#).

In vehicles without distance control: turn on the Cruise Control with the buttons on the steering wheel.

-  If necessary, press the button.
-  If necessary, press the button repeatedly until the Cruise Control is selected.

Cruise control is active. The current speed is maintained and stored as desired speed.

The indicator lights on the instrument cluster illuminate and the mark on the speedometer is set to the current speed.

The driving mode changes or Dynamic Stability Control activates when cruise control is switched on.

Turning the speed control system off/interrupting

The speed control system can be turned off or canceled automatically or manually.

Additional information:

Speed control systems, refer to page [224](#).

Adjusting the speed

Store/maintain speed

 Press the rocker button up or down once while the system is stopped.

When the system is switched on, the current speed is maintained and stored as the set speed.

The saved speed is shown on the speedometer.

When the Speed Limit Assistant is not active, the current speed can also be stored by pressing a button:

 Press the button.

Changing the speed

 Repeatedly press the rocker button up or down until the desired speed is set.
If active, the displayed speed is stored and the vehicle reaches the stored speed when the road is clear.

The maximum speed that can be set depends on the vehicle.



Press rocker button to resistance point and hold: The vehicle accelerates or decelerates without the accelerator pedal being pressed. After the rocker button is released, the vehicle maintains the final speed achieved. Pressing the switch beyond the resistance point causes the vehicle to accelerate more rapidly.

Continuing cruise control

At the stored speed

Warning

The set speed can be incorrectly adjusted or called up by mistake. There is a risk of accident, injury, and property damage. Adjust the set speed to the traffic conditions. Watch surrounding traffic closely and actively intervene where appropriate

An interrupted cruise control can be continued by calling up the stored speed. The difference between the current speed and the stored speed should be as little as possible.

 Press the button with the system interrupted.

Cruise control is continued with the stored values.

In the following cases, the stored speed value is deleted and cannot be called up again:

- ▶ When the system is switched off.
- ▶ When drive-ready state is switched off.

At the current speed

 Press the rocker button up or down to continue cruise control at the current speed.

Speed Limit Assistant: at the suggested speed

 When a speed is suggested, press the button to accept the Cruise Control at the suggested speed.

Displays in the instrument cluster

Marking on speedometer



- ▶ Green marking: system is active, the marking indicates the desired speed.
- ▶ Gray marking: system is interrupted, the marking indicates the stored speed.
- ▶ No marking: system is switched off.

Indicator light

Icon	Description
	Indicator light green: system is active.
	Gray indicator light: the system has been interrupted.



Indicator light green: system is active.



Gray indicator light: the system has been interrupted.

Displays in the Head-up display

Depending on the equipment, some system information can also be displayed in the Head-up display.

System limits

The set speed is also maintained downhill. The speed may not be maintained on uphill grades if the drive power is insufficient.

Depending on the driving mode, the vehicle may exceed or drop below the set desired speed in some situations; for instance, on downhill or uphill grades.

Do not use Cruise Control when towing.



Distance control

Principle

With the distance control, a distance to a vehicle driving ahead can be adjusted in addition to the Cruise Control.

General information

The system maintains the set speed on clear roads. The vehicle accelerates or brakes automatically.

If a vehicle is driving ahead of you, the system adjusts the speed of the vehicle so that the set distance to the vehicle ahead is maintained. The speed is adjusted as far as the given situation allows.

The distance can be adjusted at several levels. For safety reasons, it depends on the respective speed.

If the vehicle ahead of you brakes to a standstill and then drives off again within a brief period, the system is able to detect this within the given system limits.

Otherwise, drive off independently such as by stepping on the accelerator pedal or by pressing the button for the speed setting on the steering wheel.

Safety information

Warning

The system cannot serve as a substitute for the driver's personal judgment in assessing the traffic situation. Based on the limits of the system, it cannot independently react to all traffic situations. There is a risk of accident, injury, and property damage. Adjust driving style to traffic conditions. Watch the surrounding traffic situation closely, be ready to take over steering and braking at any time, and actively intervene where appropriate.

Warning

An unsecured vehicle can begin to move and possibly roll away. There is a risk of accident, injury, or property damage. Before leaving the vehicle, secure the vehicle against rolling away.

In order to ensure that the vehicle is secured against rolling away, follow the following:

- ▷ Set the parking brake.
- ▷ On uphill grades or on downhill slopes, turn the front wheels in the direction of the curb.
- ▷ On uphill grades or on downhill slopes, also secure the vehicle, for instance with a wheel chock.

Warning

The set speed can be incorrectly adjusted or called up by mistake. There is a risk of accident, injury, and property damage. Adjust the set speed to the traffic conditions. Watch surrounding traffic closely and actively intervene where appropriate.

Warning







Risk of accident is greater when there is a high speed differential to other vehicles, for instance in the following situations:

- ▷ When approaching a slowly moving vehicle at speed.
- ▷ Vehicle suddenly swerving into own lane.
- ▷ When approaching stationary vehicles at speed.

There is a risk of injury or danger to life. Watch surrounding traffic closely and actively intervene where appropriate.

Overview

Buttons on the steering wheel

Button	Function
	Turn last active speed control system on/off.
	Select the desired speed control system.
	Store current speed. Speed Limit Assistant: accept suggested speed manually.
	Resume speed control systems with the stored setting.
	Interrupt speed control systems.
	Set speed.

Sensors

The system is controlled by the following sensors:

- ▶ Camera behind the windshield.
- ▶ Front radar sensor.

Additional information:

Sensors of the vehicle, refer to page [35](#).

Application range



The system is best used on well-maintained roads.

The maximum speed that can be set is limited and depends, for example, on the vehicle and the vehicle equipment.

The system can also be activated when stationary.

Do not use Cruise Control and Distance Control when towing.

Turning on Cruise Control with Distance Control

1.  If necessary, press the button.
2.  If necessary, press the button repeatedly until distance control is selected.

Cruise Control with Distance Control is active. The current speed is maintained and stored as desired speed.

The selected distance to a vehicle driving ahead is maintained.

The indicator lights on the instrument cluster illuminate and the mark on the speedometer is set to the current speed.

The driving mode changes or Dynamic Stability Control activates when Distance Control is switched on.

Adjusting the speed

The speed can be set using the rocker button on the steering wheel.

Additional information:

Cruise control, refer to page [226](#).

Interrupting Cruise Control with Distance Control automatically

The system is stopped automatically in the following situations, for example:

- ▶ When performing a manual braking process.
- ▶ Selector lever position D is disengaged.
- ▶ While Dynamic Stability Control is disabled.
- ▶ While Dynamic Traction Control is activated.
- ▶ While Dynamic Stability Control regulates driving stability.
- ▶ Driver's seat belt and driver's door are opened.



- ▷ The system has not detected objects for an extended period, for instance on a road with very little traffic without curb or shoulder markings.
- ▷ The detection range of the radar is impaired, for instance by contamination or heavy precipitation.
- ▷ After a longer stationary period when the vehicle has been braked to a stop by the system.

Turning the speed control system off/interrupting

The speed control system can be turned off or canceled automatically or manually.

Additional information:

Speed control systems, refer to page 224.

Continuing cruise control while driving

Warning

The set speed can be incorrectly adjusted or called up by mistake. There is a risk of accident, injury, and property damage. Adjust the set speed to the traffic conditions. Watch surrounding traffic closely and actively intervene where appropriate

An interrupted cruise control can be continued by calling up the stored speed. The difference between the current speed and the stored speed should be as little as possible.

Additional information:

Cruise control, refer to page 226.

Continuing cruise control while vehicle is stationary

In certain situations, this system requires the driver to confirm their intention to drive off.

The displays show the following:





The mark on the speedometer illuminates gray.



The indicator light illuminates green.

Cruise control can be continued as follows:

- ▷ Pressing the accelerator pedal.
- ▷  Press the rocker button on the left side of the steering wheel.
- ▷  Press the button on the left side of the steering wheel.
- ▷  Press the button on the left side of the steering wheel.

Distance

Safety information

Warning

The system cannot serve as a substitute for the driver's personal judgment. Due to the system limits, deceleration can be late. There may be a risk of accidents or risk of damage to property. Be aware of the surrounding traffic situation at all times. Adjust the distance to the traffic and weather conditions and maintain the prescribed safety distance, possibly by braking.

Adjusting the distance

1.  Apps menu
2. "Vehicle"
3. "Driving settings"
4. "Driver Assistance"



5. "Driving"
6. "Distance control"
7. "Distance"
8. Select the desired setting.

Automatic adaptation of the distance

Depending on the equipment and national-market version: the system can be set so that the distance to the vehicle in front is automatically adjusted within the set distance. The system takes into account the traffic situation and ambient conditions, e.g. poor visibility.

1. Apps menu
2. "Vehicle"
3. "Driving settings"
4. "Driver Assistance"
5. "Driving"
6. "Distance control"
7. "Situational distance control"

Changing between Cruise Control with/without Distance Control

Safety information

Warning

The system does not react to traffic driving ahead of you, but instead maintains the stored speed. There is a risk of accident, injury, and property damage. Adjust the set speed to the traffic conditions and brake as needed.

Changing over the Cruise Control mode

Turning Cruise Control without distance control on or off:

1. Apps menu
2. "Vehicle"
3. "Driving settings"

4. "Driver Assistance"
5. "Driving"
6. "Distance control"
7. "Switch to Cruise Control"

The setting is reset when the vehicle is parked.

Displays in the instrument cluster

General information

Depending on the equipment version, the displays in the instrument cluster may vary.

Marking on speedometer



- ▶ Green marking: system is active, the marking indicates the desired speed.
- ▶ Gray marking: system is interrupted, the marking indicates the stored speed.
- ▶ No marking: system is switched off.

Indicator lights and warning lights

Icon	Description
	White indicator light: No Distance Control because accelerator pedal is being pressed.
	Indicator light illuminates green: Vehicle has been detected ahead of you. The vehicle icon goes out if no vehicle has been detected ahead of you. Indicator light flashes green: Preceding vehicle has driven off.

Icon	Description
	<p>Indicator light illuminates gray: The system is interrupted.</p> <p>Indicator light flashes gray: Conditions are not adequate for the system to work.</p> <p>The system was deactivated but applies the brakes until you actively resume control by pressing on the brake pedal or accelerator pedal.</p>
	<p>Warning light flashes red and acoustic signal sounds: Brake and make an evasive maneuver, if necessary.</p>



Assisted View

Depending on the equipment and national-market version, information for the system is displayed in the Assisted View in the central display area of the instrument cluster.

Additional information:

Assisted View, refer to page [161](#).

Displays in the Head-up display

Set speed

Depending on the equipment, some system information can also be displayed in the Head-up display.

Distance information



The icon is displayed when the distance from the vehicle traveling ahead is too short.

The distance information is active in the following situations:

- ▶ Cruise Control with Distance Control switched off.
- ▶ Display in the Head-up display selected.
Head-up display, refer to page [147](#).

- ▶ Distance too short.
- ▶ Speed greater than approx. 40 mph/70 km/h.

System limits

System limits of the sensors

Additional information:

- ▶ Cameras, refer to page [35](#).
- ▶ Radar sensors, refer to page [36](#).

Detection range

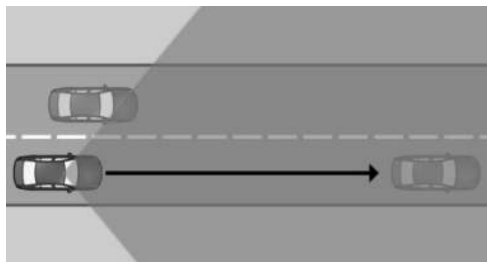

Sensors detect the traffic situation in their detection range.

The detection capability of the system and the automatic braking performance are limited.

For instance, two-wheeled vehicles may not be detected.

Deceleration

The system does not decelerate in the following situations:

- ▶ For pedestrians or similarly slow-moving road users.
- ▶ For cross traffic.
- ▶ For oncoming traffic.

Merging vehicles

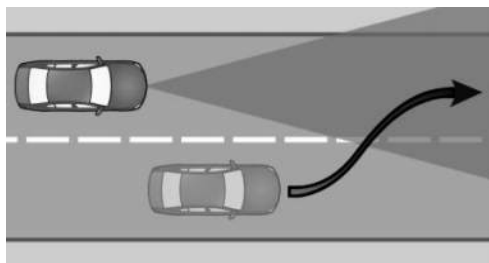

If a vehicle driving ahead of you suddenly merges into your lane, the system may not be able to automatically restore the selected distance. It may not be possible to restore the selected distance in certain situations, including if you are driving significantly faster than vehicles driving ahead of you, for instance when rapidly approaching a truck. When a vehicle driving ahead of you is reliably detected, the system requests that the driver intervene by braking and making an evasive maneuver, if needed.

Cornering



When the set speed is too high for a curve, the speed is reduced slightly. Because curves may not be anticipated in advance, drive into a curve at an appropriate speed.

The system has a limited detection range. Situations can arise in tight curves where a vehicle driving ahead will not be detected or will be detected very late.

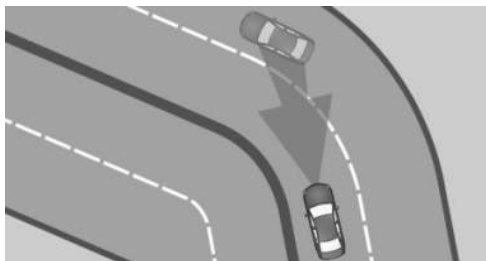

When you approach a curve the system may briefly report vehicles in the next lane due to the bend of the curve. If the system decelerates you may compensate for it by briefly accelerating. After releasing the accelerator pedal the system is reactivated and controls speed independently.

Driving off

In some situations, the vehicle cannot drive off automatically; for example:

- ▶ On steep uphill grades.
- ▶ In front of bumps in the road.
- ▶ With a heavy trailer.

In these cases, step on the accelerator pedal.

Weather

The following restrictions can occur under unfavorable weather or light conditions:

- ▶ Poorer vehicle detection.
- ▶ Short-term interruptions for vehicles that are already recognized.

Drive attentively, and react to the current surrounding traffic situation. If necessary, intervene actively, for instance by braking, steering or making an evasive maneuver.

Drive power

The set speed is also maintained downhill. The speed may not be maintained on uphill grades if the drive power is insufficient.

Depending on the driving mode, the vehicle may exceed or drop below the set desired



speed in some situations; for instance, on downhill or uphill grades.

Assisted Driving Mode

Principle

Assisted Driving Mode enhances Distance Control with Steering Assistance and lane keeping. The system assists the driver in keeping the vehicle within the lane. For this purpose, the system executes supporting steering movements, for instance when cornering.

General information

Depending on the speed, the system orients itself according to the lane boundaries or vehicles in front.

Sensors in the steering wheel detect whether the steering wheel is being touched.

Depending on the vehicle equipment and national-market version, the Driver Attention Camera in the instrument cluster monitors the driver's attention.

Safety information

Warning

The system cannot serve as a substitute for the driver's personal judgment in assessing the traffic situation. Based on the limits of the system, it cannot independently react to all traffic situations. There is a risk of accident, injury, and property damage. Adjust driving style to traffic conditions. Watch the surrounding traffic situation closely, be ready to take over steering and braking at any time, and actively intervene where appropriate.

The Cruise Control and Distance Control alerts also apply.

Additional information:

- ▷ Cruise control, refer to page 226.
- ▷ Distance Control, refer to page 229.

Overview

Buttons on the steering wheel

Button Function



Turn last active speed control system on/off.



Select the desired speed control system.



Store current speed.
Speed Limit Assistant: accept suggested speed manually.



Resume speed control systems with the stored setting.



Interrupt speed control systems.



Set speed.

Sensors

The system is controlled by the following sensors:

- ▷ Camera behind the windshield.
- ▷ Front radar sensor.
- ▷ Depending on the equipment: Radar sensors, side, front.
- ▷ Depending on the equipment: Radar sensors, side, rear.
- ▷ Sensors in steering wheel.
- ▷ Depending on the vehicle equipment and national-market version: Driver Attention Camera



Additional information:

- ▷ Sensors of the vehicle, refer to page 35.
- ▷ Driver Attention Camera, refer to page 215.

Functional requirements

- ▷ Depending on the equipment: speed below 130 mph/210 km/h or 110 mph/180 km/h.
- ▷ Sufficient lane width.
- ▷ Hands on the steering wheel rim.
- ▷ Sufficiently wide curve radius.
- ▷ Drive in the center of the lane.
- ▷ The sensor system calibration process is complete.
- ▷ Distance control is active.
- ▷ Seat belt on the driver's side fastened.
- ▷ Forward Collision Mitigation is active.
- ▷ Depending on the equipment: Side-collision warning is active.
- ▷ With trailer hitch: You must set on the control display that you are using a trailer or rear carrier, respectively.
Driving with trailer or rear carrier, refer to page 336.

Switching on Assisted Driving Mode

1.  If necessary, press the button.
2.  If necessary, press the button repeatedly until Assisted Driving Mode is selected.

 Indicator light illuminates gray.
The system is on standby and does not manipulate steering movements.

System activates automatically as soon as all function conditions are fulfilled.

 The indicator light illuminates green.
The system is active and helps to keep the vehicle in the lane.

When the system is switched on, the Forward Collision Mitigation and, depending on the equipment, the side-collision warning are active.

Stopping Assisted Driving Mode automatically

The system interrupts the supporting steering movements automatically, for example in the following situations:

- ▷ Depending on the equipment: at a speed above 130 mph/210 km/h or 110 mph/180 km/h.
- ▷ After releasing the steering wheel.
- ▷ With strong steering intervention.
- ▷ When leaving own lane.
- ▷ When the turn signal is switched on or, depending on the vehicle equipment, when the driver turns the steering wheel while the turn signal is switched on.
- ▷ When the lane is too narrow.
- ▷ If a lane boundary is not detected and there is no vehicle driving in front.
- ▷ The Cruise Control with Distance Control is interrupted.
- ▷ The seat belt on the driver's side is unfastened.

 Indicator light illuminates gray.
The system is on standby and does not manipulate steering movements.

System activates automatically as soon as all function conditions are fulfilled.



Displays in the instrument cluster

Icon	Description
	Indicator light illuminates gray: The system is ready.
	Indicator light illuminates green: The system is activated. The system supports the driver in keeping the vehicle within the lane.
	Warning light flashes yellow and steering wheel vibrates: A lane boundary has been crossed.
	Warning light illuminates yellow and acoustic signal sounds: System interruption is imminent.
	Warning light flashes red and acoustic signal sounds: The system is switched off or will be interrupted very soon.
	Warning light illuminates yellow: Hands are not grasping the steering wheel. The system is still active. Grab the steering wheel with your hands.
	Warning light illuminates red, acoustic signal sounds: The hands are not on the steering wheel or, depending on the vehicle equipment and national-market version, the driver's line of sight is not directed at the surrounding traffic. System interruption is imminent. The system reduces the speed to a standstill if applicable. It is possible that the system will not execute any supporting steering movements. Immediately grasp the steering wheel with your hands and pay attention to the surrounding traffic.

Depending on the vehicle equipment and national-market version, a Check Control message is displayed if the Driver Attention Camera detects that the driver is inattentive.

Depending on the equipment and national-market version, information for the system is displayed in the Assisted View in the central display area of the instrument cluster.

Additional information:

Assisted View, refer to page 161.

Displays on the steering wheel



Similar to the instrument cluster views, the two LEDs above the keypads illuminate.

The steering wheel displays can be turned on/off.

1. Apps menu
2. "Vehicle"
3. "Driving settings"
4. "Driver Assistance"
5. "Feedback via steering wheel"
6. "Light elements"
7. Select the desired setting.

Displays in the Head-up display

Depending on the equipment, the system information can also be displayed in the Head-up display.

Setting the intensity of the steering wheel vibration

1. Apps menu
2. "Vehicle"
3. "Driving settings"
4. "Driver Assistance"
5. "Feedback via steering wheel"
6. "Vibration intensity"
7. Select the desired setting.

This setting is applied to all collision warning systems.

System limits

General information

The system cannot be activated or meaningfully used in certain situations, e.g., when towing a trailer.

Safety information

Warning

Because of system limitations, this system may either not respond, or respond too late, incorrectly, or without cause. There is a risk of accident, injury, and property damage. Actively intervene as warranted. Refer to the information in this Owner's Manual regarding the scope of the system's operation and limitations.

The Cruise Control and Distance Control alerts also apply.

Additional information:

- ▷ Cruise control, refer to page 226.
- ▷ Distance Control, refer to page 229.

System limits of the sensors

Additional information:

- ▷ Cameras, refer to page 35.
- ▷ Radar sensors, refer to page 36.
- ▷ Driver Attention Camera, refer to page 215.

Hands on the steering wheel

The sensors cannot detect hand-steering wheel contact in the following situations:

- ▷ Driving with gloves.
- ▷ Protective covers on the steering wheel.

Weather

The following restrictions can occur under unfavorable weather or light conditions:

- ▷ Poorer recognition of vehicles and lane boundaries.
- ▷ Short-term interruptions in case of already detected vehicles and lane boundaries.

Drive attentively, and react to the current surrounding traffic situation. If necessary, intervene actively, for instance by braking, steering or making an evasive maneuver.

Lane Change Assistant

Principle

The Lane Change Assistant also assists when changing lanes on multi-lane roads.

General information

The system uses the Assisted Driving Mode sensors.

Safety information

Warning

The system cannot serve as a substitute for the driver's personal judgment in assessing the traffic situation. Based on the limits of the system, it cannot independently react to all traffic situations. There is a risk of accident, injury, and property damage. Adjust driving style to traffic conditions. Watch the surrounding traffic situation closely, be ready to take over steering and braking at any time, and actively intervene where appropriate.

Federal, state, or local laws may differ, and the use of this function may be prohibited or limited. Before use, check federal, state, and local laws.

The Assisted Driving Mode alerts also apply.

Additional information:

Assisted Driving Mode, refer to page [235](#).

Functional requirements

- ▷ The functional requirements for Assisted Driving Mode have been met. Assisted Driving Mode, refer to page [235](#).
- ▷ Driving on a road without pedestrians or cyclists and with physical barriers to oncoming traffic such as crash barriers.
- ▷ A vehicle has been detected at a sufficient distance behind your own vehicle since beginning the drive.
- ▷ Crossable lane boundaries are detected.
- ▷ Maximum speed approx. 110 mph/180 km/h.
- ▷ The minimum speed is country-specific.
- ▷ With trailer hitch: You must set on the control display that you are using a trailer or rear carrier, respectively. Driving with trailer or rear carrier, refer to page [336](#).

Turning on/turning off Lane Change Assistant

1.  Apps menu
2. "Vehicle"
3. "Driving settings"
4. "Driver Assistance"
5. "Driving"
6. "Assisted Driving"
7. ▷ "Lane Change Assistant": Turning the Lane Change Assistant on/off.
 - ▷ "Active Lane Change": Depending on vehicle equipment and national-market version, lane changes can be done automatically.

Changing lanes

1. Ensure that the traffic situation permits changing lanes.
2. Start the lane change.

- ▶ To initiate the lane change, press the turn signal lever in the desired direction to the resistance point.
- ▶ Depending on the vehicle equipment, the turn signal lever can also be pressed beyond the resistance point.
- ▶ Depending on vehicle equipment, after receiving a lane change suggestion, an automatic lane change can be initiated once the driver checks their field of vision to ensure that traffic permits the lane change. For this case, Lane Change Assistant must clearly recognize the driving situation and the Driver Attention Camera must clearly recognize the driver's line of sight.



After a short time, Lane Change Assistant initiates a lane change.

After the lane change, the system helps keep the vehicle in the new lane.

Canceling a lane change

The lane change can be canceled by steering movement into the opposite direction or by operating the turn signal in the opposite direction.

Displays in the instrument cluster

Icon	Description
	Steering wheel icon and lane change arrow icon are green: The system carries out a lane change.
	Steering wheel icon is green and line for lane marking on respective side is gray: The system detected the lane change request. Lane change not currently possible.

Depending on the equipment and national-market version, information for the system is

displayed in the Assisted View in the central display area of the instrument cluster.

Additional information:

Assisted View, refer to page 161.

System limits

The limits of the Assisted Driving Mode system apply.

The limits of the Driver Attention Camera system also apply to automatic lane changes.

Additional information:

- ▶ Assisted Driving Mode, refer to page 235.
- ▶ Driver Attention Camera, refer to page 215.

Assisted Driving Mode Plus

Principle

Assisted Driving Mode Plus provides assistance when driving on highways.

The system increases driving comfort in suitable driving situations.

Sensors in the steering wheel detect whether the steering wheel is being touched.

Different versions of this function are available depending on vehicle equipment and national-market version.

- ▶ Version for speeds up to approx. 40 mph/60 km/h, e.g., traffic jam.
- ▶ Version for speeds up to approx. 85 mph/135 km/h.

General information

For versions up to 85 mph/135 km/h, the following applies:

Assisted Driving Mode Plus will be active at the time of vehicle delivery and will only be available for a limited period. Information about the duration of availability for Assisted Driving Mode Plus will be available prior to and at the time of vehicle sale. Assisted Driving Mode Plus may be terminated earlier due to techni-



cal or legal requirements. Further information about the availability of Assisted Driving Mode Plus can be requested from an authorized service center.

Safety information

Warning

The system cannot serve as a substitute for the driver's personal judgment in assessing the traffic situation. Based on the limits of the system, it cannot independently react to all traffic situations. There is a risk of accident, injury, and property damage. Adjust driving style to traffic conditions. Watch the surrounding traffic situation closely, be ready to take over steering and braking at any time, and actively intervene where appropriate.

Warning

This system is only intended for use on roads with structural separation from oncoming traffic, e.g., highways. Because of the system limits, the system can also remain active on roads without structural separations and may not react as expected. There is a risk of accident, injury, and property damage. Deactivate the system if it is enabled on roads without structural separations.

Federal, state, or local laws may differ, and the use of this function may be prohibited or limited. Before use, check federal, state, and local laws.

The Assisted Driving Mode alerts also apply.

Additional information:

Assisted Driving Mode, refer to page [235](#).

Overview

Sensors

The system is controlled by the following sensors:

- ▶ Camera behind the windshield.
- ▶ Front radar sensor.
- ▶ Side radar sensors, front.
- ▶ Side radar sensors, rear.
- ▶ The sensors in the steering wheel.
- ▶ Driver Attention Camera.

The version up to 85 mph/135 km/h additionally uses the following sensors:

- ▶ Front camera.
- ▶ Exterior mirror cameras.
- ▶ Rearview camera.

Additional information:

Sensors of the vehicle, refer to page [35](#).

Functional requirements

The following functional requirements apply to Assisted Driving Mode Plus:

- ▶ Assisted Driving Mode Plus must be available in the country in which the vehicle is driven.
- ▶ The functional requirements for Assisted Driving Mode have been met.

Assisted Driving Mode is active and the LED displays on the steering wheel are switched on.

Assisted Driving Mode, refer to page [235](#).

- ▶ Driving on a highway-like road without pedestrians or cyclists and with physical barriers to oncoming traffic, e.g., guard rails.
- ▶ Lane boundaries are detected.
- ▶ Sufficient lane width.
- ▶ Sufficiently wide curve radius.
- ▶ The navigation system must clearly identify the road and vehicle position.

- ▶ This function must be available on the road on which the vehicle is driving.
- ▶ Antennas located in the roof must not be covered, e.g., by roof loads or snow.
- ▶ The Driver Attention Camera in the instrument cluster detects that the driver is paying attention to the surrounding traffic.
- ▶ With trailer hitch: You must set on the control display that you are using a trailer or rear carrier, respectively.
Driving with trailer or rear carrier, refer to page 336.

For the version up to 40 mph/60 km/h, the following additional functional requirements apply:

- ▶ A vehicle has been detected ahead of you.
- ▶ Speed below approx. 40 mph/60 km/h.

For the version up to 85 mph/135 km/h, the following additional functional requirements apply:

- ▶ Assisted Driving Mode Plus is enabled in the vehicle.
- ▶ The navigation data must be up to date.
- ▶ Vehicle speed is less than approx. 85 mph/135 km/h.
- ▶ The systems in the vehicle, e.g., the Attention Assistant and the Driver Attention Camera recognize that the driver is rested.

Switching Assisted Driving Mode Plus on/off

1.  Apps menu
2. "Vehicle"
3. "Driving settings"
4. "Driver Assistance"
5. "Driving"
6. "Assisted Driving"
7. "Assisted Driving Plus"

Assisted Driving Mode Plus is automatically offered when Assisted Driving Mode is active

and all functional requirements for Assisted Driving Mode Plus have been met.

Two green LED lights are illuminated on the steering wheel.



The indicator light in the instrument cluster is shown in green.

The system begins to assist the driver with vehicle control.

When the system is switched on, the following functions are enabled:

- ▶ Forward Collision Mitigation.
- ▶ Side collision mitigation.
- ▶ For the version up to 85 mph/135 km/h: Some speed control systems, e.g., adjusting speed to course of road.

Displays in the instrument cluster

Icon	Description
	Indicator light green: system is active.
	Indicator light gray: the system has been interrupted and will activate automatically as soon as all functional requirements are met.
	White indicator light: the system can be activated.

Depending on the equipment and national-market version, information for the system is displayed in the Assisted View in the central display area of the instrument cluster.

Additional information:

Assisted View, refer to page 161.

Displays on the steering wheel



The two LEDs above the keypads illuminate depending on the situation.

- ▷ Green: the system is active.
- ▷ Yellow: system will be interrupted.
Grab the steering wheel with your hands.
- ▷ Red: system will be deactivated.
Grab the steering wheel immediately with your hands.

Additional information:

Assisted Driving Mode, refer to page [235](#).

Displays in the Head-up display

Depending on the equipment, the system information can also be displayed in the Head-up display.

Navigation system displays

For the version up to 85 mph/135 km/h, roads on which Assisted Driving Mode Plus supports vehicle control can be displayed on the navigation system.

1.  Navigation menu
2. "Suggestions"
3. Select the desired setting.

System limits

The system limits of the following systems apply:

- ▷ Assisted Driving Mode.
- ▷ Driver Attention Camera.

- ▷ For version up to 85 mph/135 km/h: Fatigue Alert

- ▷ Sensors of the vehicle.

Additional information:

- ▷ Assisted Driving Mode, refer to page [235](#).
- ▷ Driver Attention Camera, refer to page [215](#).
- ▷ Fatigue alert, refer to page [214](#).
- ▷ Sensors of the vehicle, refer to page [35](#).

Speed Limit Assistant

Principle

Speed Limit Assistant supports driving at the speed limit. A suggested speed can be applied.

General information

When the systems in the vehicle, e.g., Speed Limit Info, detect a change of the speed limit, this new speed value can be applied for the following systems:

- ▷ Cruise control.
- ▷ Distance control.
- ▷ Assisted Driving Mode.
- ▷ Assisted Driving Mode Plus.

The speed value is suggested as the new desired speed to be applied. To apply the speed value, the corresponding system must be activated.

Depending on the equipment, destination system and national-market version, the value can be applied automatically.

Safety information

Warning

The system cannot serve as a substitute for the driver's personal judgment in assessing the traffic situation. Based on the limits of the system, it cannot independently react to

all traffic situations. There is a risk of accident, injury, and property damage. Adjust driving style to traffic conditions. Watch the surrounding traffic situation closely, be ready to take over steering and braking at any time, and actively intervene where appropriate.

Warning

The set speed can be incorrectly adjusted or called up by mistake. There is a risk of accident, injury, and property damage. Adjust the set speed to the traffic conditions. Watch surrounding traffic closely and actively intervene where appropriate



- ▶ "Adjust automatically": depending on the equipment, detected speed limits are applied automatically.
 - ▶ "Adjust manually": detected speed limits can be applied manually.
 - ▶ "Show current limit": current speed limits are displayed without being applied in the instrument cluster.
 - ▶ "Off": depending on the national-market version, Speed Limit Info and Speed Limit Assistant will be turned off.
- If necessary, other anticipatory comfort functions will be turned off.

Additional information:

Speed Limit Info, refer to page [222](#).

Overview

Buttons on the steering wheel



Button	Function
	Accept suggested speed manually.
	Set speed, refer to Cruise Control.

Turning Speed Limit Assistant on/off

1.  Apps menu
2. "Vehicle"
3. "Driving settings"
4. "Driver Assistance"
5. "Driving"
6. "Speed Limit Assistant"
7. "Speed limits"
8. Select the desired setting:

Displays in the instrument cluster

A message is displayed in the instrument cluster when the system and a speed control system are activated.

Icon	Function
	Detected change of a speed limit with immediate effect.
	Depending on the national-market version, it is possible to switch between the units of measurement.
	Indicator light illuminates green: the detected speed limit can be applied with the SET button. After it has been applied, a green checkmark is displayed.

Automatic adoption

"Adjust automatically": Distance Control automatically adopts any detected speed limits when driving on roads with barriers separating traffic in opposing directions.

It may not be possible to use this function when driving with a trailer.

SET After an automatic adoption, the button can be pressed to switch back to the last set value of the desired speed.

Manual adoption

A detected speed limit can be applied manually to the active speed control system.

SET When the SET icon is displayed, press the button.

Speed adjustment

Principle

It can be adjusted whether the speed limit is applied exactly or with a tolerance.

General information

A speed adaptation for all speed limits and an additional speed adaptation for speed limits up to 40 mph/60 km/h can be set up.

The additional speed adaptation for speed limits up to 40 mph/60 km/h can be activated or deactivated.

Setting the speed adjustment

1.  Apps menu
2. "Vehicle"
3. "Driving settings"
4. "Driver Assistance"
5. "Driving"
6. "Speed Limit Assistant"
7. Select the desired setting:
 - ▷ "Adjust speed limits": set the tolerance for speed adjustments, which applies to all speed limits.
 - ▷ "2nd adjustm. up to": activate or deactivate additional speed adaptation.
 - ▷ "Adjust speed limits": with activated additional speed adjustment, set the

tolerance for speed limits up to 40 mph/60 km/h.

System limits

Speed Limit Assistant is based on the Speed Limit Info system.

Consider the system limits of Speed Limit Info.

Cruise Control without Distance Control: for system related reasons, the speed limits cannot be applied automatically.

With trailer hitch: speed values to be adopted are limited to the value set on the control display for trailer operation.

Additional information:

- ▷ System limits of Speed Limit Info, refer to page 223.
- ▷ System limits of the sensors, refer to page 35.
- ▷ Driving with trailer or rear carrier, refer to page 336.

Adapting the speed to the route

Principle

The system can be configured so that with active distance control, the vehicle adapts the speed automatically to the route.

For instance, the speed will be reduced in the following situations as necessary:

- ▷ Before making turns.
- ▷ Before a roundabout.
- ▷ Before a curve.
- ▷ In front of an exit ramp on highways or highway-like roads.

Safety information

Warning

The system cannot serve as a substitute for the driver's personal judgment in assessing the traffic situation. Based on the limits of the system, it cannot independently react to all traffic situations. There is a risk of accident, injury, and property damage. Adjust driving style to traffic conditions. Watch the surrounding traffic situation closely, be ready to take over steering and braking at any time, and actively intervene where appropriate.

The Cruise Control, Distance Control, Assisted Driving Mode, and Speed Limit Assist alerts also apply.

Additional information:

- ▶ Cruise control, refer to page [226](#).
- ▶ Distance Control, refer to page [229](#).
- ▶ Assisted Driving Mode, refer to page [235](#).
- ▶ Speed Limit Assistant, refer to page [243](#).

Functional requirements

- ▶ Cruise Control and distance control are activated.
- ▶ Driving on a highway or highway-like road.
- ▶ With navigation system: guidance is activated.

The use of navigation software via Apple CarPlay or Android Auto may lead to functional limitations, for instance deviations with navigation instructions.

- ▶ The function must be available in the country in which the vehicle is driven.
- ▶ With trailer hitch: You must set on the control display that you are using a trailer or rear carrier, respectively.

Driving with trailer or rear carrier, refer to page [336](#).

Adapting speed automatically to route

1.  Apps menu
2. "Vehicle"
3. "Driving settings"
4. "Driver Assistance"
5. "Driving"
6. "Route and intersection assistant"
7. "Automatically adjust speed to route"

Adjusting the cornering speed

The cornering speed can be adjusted depending on national-market version.

1.  Apps menu
2. "Vehicle"
3. "Driving settings"
4. "Driver Assistance"
5. "Driving"
6. "Route and intersection assistant"
7. "Cornering speed"
8. Select the desired setting.

Displays in the instrument cluster

Depending on the equipment and national-market version, information for the system is displayed in the Assisted View in the central display area of the instrument cluster.

Additional information:

Assisted View, refer to page [161](#).

System limits

Depending on the national-market version or country in which the vehicle is currently being driven, the function may not be available.

The system does not react or reacts to a limited extent to the route ahead in the following situations:

- ▷ If the vehicle location cannot be clearly determined by the navigation system.
- ▷ On wintry roads.

Additionally, the limits for Cruise Control, Distance Control, Assisted Driving, and Speed Limit Assist systems apply.

Additional information:

- ▷ Cruise control, refer to page 226.
- ▷ Distance Control, refer to page 229.
- ▷ Assisted Driving Mode, refer to page 235.
- ▷ Speed Limit Assistant, refer to page 243.

Lane change with active guidance

Principle

Lane change with active guidance assists the driver when lane changes are necessary to reach a destination. A notice is also displayed on the instrument cluster. A slight jolt can also be felt on the steering wheel, depending on national-market version and settings.

General information

The system uses the Assisted Driving Mode sensors.

Safety information

Warning

The system cannot serve as a substitute for the driver's personal judgment in assessing the traffic situation. Based on the limits of the system, it cannot independently react to all traffic situations. There is a risk of accident, injury, and property damage. Adjust driving style to traffic conditions. Watch the surrounding traffic situation closely, be ready to take over steering and braking at any time, and actively intervene where appropriate.

The Cruise Control, Distance Control, and Assisted Driving alerts also apply.

Additional information:

- ▷ Cruise control, refer to page 226.
- ▷ Distance Control, refer to page 229.
- ▷ Assisted Driving Mode, refer to page 235.

Functional requirements

- ▷ Cruise Control and Distance Control are activated.
 - ▷ Driving on a highway or highway-like road.
 - ▷ A situation-dependent minimum speed has been reached.
 - ▷ The system detects a sufficiently large gap in traffic in the adjacent lane.
 - ▷ A crossable lane boundary on the side of the desired lane change is detected.
 - ▷ Destination guidance is active on the navigation system.
- The function is not available when using navigation software via Apple CarPlay or Android Auto.
- ▷ The function must be available in the country in which the vehicle is driven.
 - ▷ The Driver Attention Camera in the instrument cluster detects that the driver is paying attention to the surrounding traffic.
 - ▷ With trailer hitch: You must set on the control display that you are using a trailer or rear carrier, respectively.

Driving with trailer or rear carrier, refer to page 336.

Switching lane change on/off with active destination guidance

1.  Apps menu
2. "Vehicle"
3. "Driving settings"
4. "Driver Assistance"
5. "Driving"

- "Route and intersection assistant"
- "Lane Guiding with Navigation"

Switching the steering wheel jerk on/off

You can switch the steering wheel jerk assistance on/off.

- Apps menu
- "Vehicle"
- "Driving settings"
- "Driver Assistance"
- "Driving"
- "Route and intersection assistant"
- "Steering wheel impulse"

Changing lanes

If lane changes are necessary to reach a navigation destination, a corresponding notice is displayed on the instrument cluster. In addition, a slight jerk can be felt on the steering wheel.

To change lanes, follow the instructions on the instrument cluster.



- The system detects a suitable gap in the flow of traffic in the adjacent lane. A green checkmark is displayed on the lane change icon on the instrument cluster. The system prepares for the lane change.
- When a suitable gap is detected, the speed is adapted so that the vehicle remains level with the opening.
- A Check Control message indicates a lane change suggestion.
- When the traffic situation permits a lane change, the driver can steer the vehicle into the next lane.

For vehicles equipped with Lane Change Assistant: Once the Check Control message appears, the Lane Change Assistant can be

started by, e.g., operating the turn signal or looking toward the lane to check it.

- If necessary, the system automatically starts additional lane changes.

Display in the instrument cluster

Icon	Function
	Indicates a necessary lane change. The icon varies depending on the traffic situation.
	A green checkmark on the icon indicates that the function is active.
	A red cross on the icon indicates that the system cannot assist with the lane change.

Depending on vehicle equipment and national-market version, the traffic situation is displayed in Assisted View on the instrument cluster.

Additional information:

Assisted View, refer to page 161.

System limits

The limits of the Cruise Control, Distance Control, and Assisted Driving Mode systems and Driver Attention Camera apply.

Additional information:

- ▶ Cruise control, refer to page 226.
- ▶ Distance Control, refer to page 229.
- ▶ Assisted Driving Mode, refer to page 235.
- ▶ Driver Attention Camera, refer to page 215.

Parking

Vehicle features and options

This chapter describes model-specific equipment, systems, and functions that are currently available, or may become available in the future, even if they are not present in the vehicle.

Additional information:

Vehicle equipment, refer to page 8.

Parking assistance systems

General information

The parking assistance systems include different individual systems. The individual systems help the driver when parking, maneuvering, or reversing by providing various assistance functions, sensors, and camera views.

Additional information:

- ▶ Rearview camera, refer to page 254.
- ▶ Semi-automatic camera perspective, refer to page 255.
- ▶ Automatic camera perspective, refer to page 255.
- ▶ Side view, refer to page 256.
- ▶ 3D view, refer to page 256.
- ▶ Trailer hitch view, refer to page 257.
- ▶ Car wash view, refer to page 257.
- ▶ Panorama View, refer to page 258.
- ▶ Automatic activation of panorama view, refer to page 258.
- ▶ Door opening angle, refer to page 259.
- ▶ Remote 3D View, refer to page 260.
- ▶ Park Distance Control, refer to page 261.
- ▶ Active Park Distance Control, refer to page 264.
- ▶ Drive-off monitoring, refer to page 265.

- ▶ Automatic Parking Assistant, refer to page 266.
- ▶ Maneuver Assistant, refer to page 271.
- ▶ Remote Control Parking, refer to page 275.
- ▶ Back-up Assistant, refer to page 276.
- ▶ Trailer Assistant, refer to page 338.

Safety information

Warning

The system cannot serve as a substitute for the driver's personal judgment in assessing the traffic situation. Based on the limits of the system, it cannot independently react to all traffic situations. There is a risk of accident, injury, and property damage. Adjust driving style to traffic conditions. Watch the surrounding traffic situation closely, be ready to take over steering and braking at any time, and actively intervene where appropriate.

Overview

Button in the vehicle

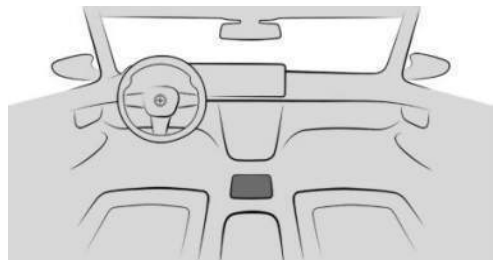

Park assistance button

Sensors

The parking assistance systems are controlled by the following sensors:

- ▶ Ultrasonic sensors in the front/rear bumpers.
- ▶ Ultrasonic sensors, side.
- ▶ Front camera.
- ▶ Top view cameras.
- ▶ Rearview camera.

Additional information:

Sensors of the vehicle, refer to page 35.

Operating concept

The camera-based individual systems are operated with the function bars on the control display. The camera views can be viewed by selecting the appropriate icon.

In the Parking menu, some parking assistance systems can be configured individually.

Some parking assistance systems can be started by voice control as needed, e.g., driving in/out of a parking space with the Automatic Parking Assistant.

Additional information:

BMW Intelligent Personal Assistant, refer to page 53.

Calling up Park menu

1.  Apps menu
2. "Vehicle"
3. "Driving settings"
4. "Driver Assistance"
5. "Parking"
6. Select the desired settings.

Display

Principle

With the Park Distance Control display and various camera views, the parking assistance

systems help you park, maneuver, and reverse your vehicle.

General information

Depending on the equipment, one or more cameras capture the area from different selectable perspectives.

Depending on the view, the vehicle's surroundings or a part of it is depicted.

Depending on the national-market version, either the automatic or the semi-automatic camera perspective is displayed.

Turning display on/off

General information

The parking assistance systems view switches off automatically when driving forwards or if a certain distance or speed is exceeded.

With reverse gear

When drive-ready state is switched on, the display is automatically switched on if selector lever position R is engaged.

With the Park Assist key



Press the button.

Via iDrive

1.  Apps menu
2. "Vehicle"
3. "Parking"

Display in the instrument cluster

The instrument cluster shows displays of some parking assistance systems such as Park Distance Control or Automatic Parking Assistant.

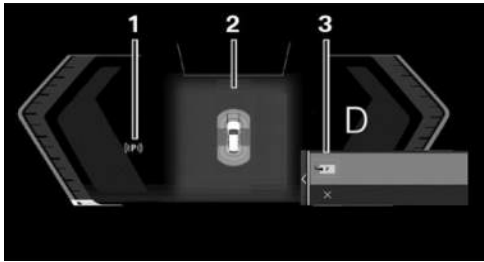

- 1 Status of parking assistance systems
- 2 Assisted View
- 3 Selection menu

Display on the control display

General information

Depending on vehicle equipment and on the activated parking assistance system, the control display will vary.

Assistance view

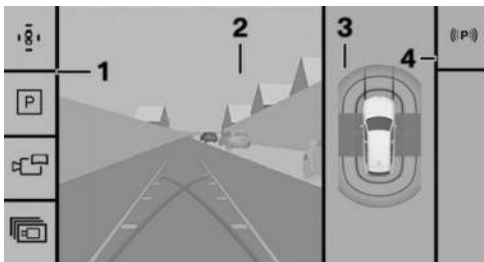

- 1 Toolbar, left
- 2 Camera image
- 3 Vehicle top view
- 4 Toolbar, right



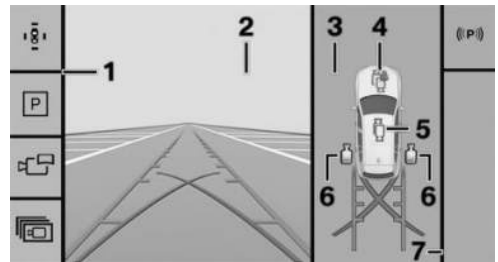



Parking view



- 1 Toolbar, left
- 2 Camera image
- 3 Selection window
- 4 Automatic camera perspective
- 5 Semi-automatic camera perspective
- 6 Side view
- 7 Toolbar, right

Toolbar, left

Different views and settings can be selected via the left toolbar depending on the equipment:

- ▷  "Parking view"
Depending on vehicle equipment, camera views or the Park Distance Control view are displayed.
- ▷  "Assist view"
A stylized top view of the vehicle is displayed.
- ▷  "Panorama view"
The cross traffic view is displayed.
- ▷  "More"
 - ▷  "3D view"
A three-dimensional view of the vehicle is displayed.
 - ▷  "Trailer coupling view"
The view shows the zoom onto the trailer hitch.
 - ▷  "Car wash view"

Your own lane can be displayed to make it easier to drive into a car wash.

- ▶  "Settings"
Settings can be entered in the Park menu.

Toolbar, right

The Parking Assistant functions are displayed in the right toolbar.





- ▶ Status of the parking assistance systems.
- ▶ Available parking methods of the Automatic Parking Assistant.
- ▶ Functions of the Back-up Assistant.
- ▶ Functions of the Maneuver Assistant.
- ▶ Trailer Assistant functions.
- ▶ Additional information in case of malfunctions.

Status of parking assistance systems

The status of parking assistance systems is indicated by icons on the toolbar on the right of the control display, in the status area on the instrument cluster, and on the Head-up display, depending on vehicle equipment. In addition to this icon, text also appears on the control display.

The following parking assistance systems are displayed:

- ▶ Automatic Parking Assistant.
- ▶ Maneuver Assistant.
- ▶ Back-up Assistant.
- ▶ Trailer Assistant.

Icon	Meaning
	No search for parking assistance system offers. No other parking assistance systems available. Parking assistance systems have failed.
	Search for parking assistance system offers is active.
	White: an available maneuver is selected but is not being performed. Functional requirements have not been met or the functions transfer has been completed. Green: parking assistance system is active. Functions are controlled depending on the system activated.
	Maneuver Assistant records the maneuver to be stored.

Additional displays

General information

Additional displays can be shown in the camera image of the display of the parking assistance systems, e.g., parking aid lines, to make parking and maneuvering easier.

Several additional displays can be active at the same time.

Turning additional displays on/off

1.  Apps menu
2. "Vehicle"
3. "Driving settings"
4. "Driver Assistance"
5. "Parking"
6. Select the desired setting.

Parking aid lines

Pathway lines



Pathway lines help you to estimate the space required when parking and maneuvering on level roads.

Lane lines are displayed in front of or behind the vehicle depending on the gear engaged.

The pathway lines are continuously adjusted to the steering movements depending on the steering-wheel angle.

Turning circle lines



Turning circle lines can only be superimposed on the camera image together with pathway lines.

The lines show the course of the smallest possible turning circle on a level road.

Only one turning circle line is displayed after the steering wheel is turned past a certain angle.

Using parking aid lines

1. Position the vehicle so that the red turning circle line leads to within the limits of the parking space.
2. Turn the steering wheel to the point where the green pathway line covers the corresponding turning circle line.

Obstacle marking

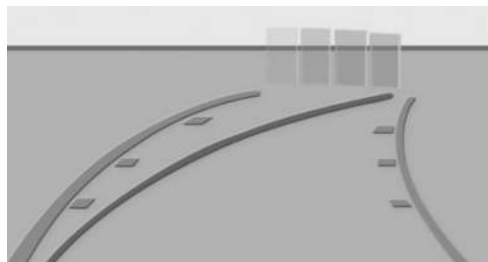

Obstacles are detected by the sensors.

The obstacles detected by the Park Distance Control are shown by marks in the camera image.

Colored gradients for the obstacle markings in green, yellow and red indicate the distances.

Functional limitations

The system can be used only to a limited extent in the following situations:

- ▶ With a door open.
- ▶ With open cargo area.
- ▶ With exterior mirrors folded in.

Areas with gray hatching with an icon in the camera image identify areas that are currently not shown such as an open door.

System limits

Safety information

Warning

Because of system limitations, this system may either not respond, or respond too late, incorrectly, or without cause. There is a risk of accident, injury, and property damage. Actively intervene as warranted. Refer to the information in this Owner's Manual regarding the scope of the system's operation and limitations.

System limits of the sensors

Additional information:

Sensors of the vehicle, refer to page 35.

Field of view

Because of the camera angle, the areas under the vehicle cannot be viewed by the cameras.

Detection of objects

Very low obstacles as well as high, protruding objects such as ledges may not be detected by the system.

Objects shown on the control display may be closer than they appear. Do not estimate the distance to the objects on the control display.

The camera's detection range can be limited by protruding cargo, a rear carrier, or a trailer.

Malfunction

A camera failure is displayed on the control display.

The malfunctioning camera's detection range is shown by the shaded area on the control display.

Rearview camera

Principle

The rearview camera helps when reverse parking and maneuvering. The area behind the vehicle is shown on the control display.

Additional views can be shown on the display, e.g., parking aid lines and obstacle markings.

General information

Follow the information in the "Parking assistance systems" chapter.

Functional requirements

- ▷ The cargo area is fully closed.
- ▷ The camera area is clean and clear.

Turning the rearview camera on/off

Turning the camera view on automatically

When drive-ready state is switched on, the rearview camera is automatically switched on if selector lever position R is engaged.

Turning the camera view off automatically

The rearview camera turns off automatically when driving forward or when a certain distance or speed is exceeded.

Turning the camera view on/off manually



1. Press the button.
2. Engage selector lever position R.
 -  Depending on vehicle equipment: The icon in the selection window is selected automatically.

To exit rearview camera view, select another camera view in the selection window or press the button again.

Deactivated rearview camera

When the rearview camera is deactivated, for instance when the cargo area is open, the camera image is displayed with gray shading.

Semi-automatic camera perspective



Principle

Depending on the parking direction and engaged selector lever position, a fixed camera perspective is displayed with the areas in front of or behind the vehicle.

General information

Follow the information in the "Parking assistance systems" chapter.

Turning the semi-automatic camera perspective on/off

1.  Press the button.
2.  Select the icon in the selection window.
To exit the fixed camera view, select another camera view in the selection window.

Automatic camera perspective

Principle

The automatic camera perspective shows a steering-dependent view in the respective driving direction.

This perspective adapts to the respective driving situation.

General information

As soon as obstacles are detected, the view changes to a fixed display of the area in front of or behind the bumper, or switches to side Park Distance Control as necessary.

When reverse gear is engaged, the automatic camera perspective is, if necessary, exited and the system uses a semi-automatic camera perspective to the rear. If necessary, select the automatic camera perspective when reverse gear is engaged. The automatic camera perspective will then be maintained for the current parking operation.

Follow the information in the "Parking assistance systems" chapter.

Turning the automatic camera perspective on/off



Turning the camera view on/off automatically

When the parking assistance systems' display is turned on, automatic camera perspective is selected automatically.

 The icon in the selection window is selected automatically.

To exit the steering-dependent camera view, select another camera view in the selection window.

Turning the camera view on/off manually

1.  Press the button.
2.  The icon in the selection window is selected automatically.

To exit the steering-dependent camera view, select another camera view in the selection window or press the button again.

Side protection

Principle

The side Park Distance Control is automatically displayed when the automatic camera perspective is turned on. The function shows obstacles located next to the vehicle.

General information

Follow the information in the "Parking assistance systems" chapter.

Display



To protect the sides of the vehicle, obstacle markings are displayed on the sides of the vehicle.

- ▶ No markings: no obstacles detected.
- ▶ Color marks: warning against detected obstacles.

System limits

The system only displays stationary obstacles that were previously detected by sensors while passing them.

The system does not detect whether an obstacle moves later on. For this reason, at standstill, the marks are not shown anymore in the display after a certain time. The area next to the vehicle must be newly captured.

Side view

Principle

Side view shows the vehicle's side surroundings, making it easier to position the vehicle at the curb or with other obstacles on the side.



The side view looks from rear to front and, in case of danger, focuses automatically on possible obstacles.

General information

Follow the information in the "Parking assistance systems" chapter.

Turning the side view on/off

The selection window lets you choose the side view for the left or right side of the vehicle.

1.  Press the button.
2.  Select the icon for the desired vehicle side in the selection window.

To exit the side view, select another camera view in the selection window.

3D view

Principle

With 3D view, a circle is displayed around the vehicle top view in the selection window.

Specified perspectives can be selected on the circle.

General information

The current perspective is marked with a camera icon.

Follow the information in the "Parking assistance systems" chapter.

Turning the 3D view on/off



1. Press the button.
2. "More"
3. "3D view"

To exit the 3D view, select another camera view on the left toolbar.

Trailer hitch view

Principle

To make it easier to attach a trailer, you can zoom in on the view of the trailer hitch.

General information

When zooming in, remember that the view may no longer show certain obstacles.

Follow the information in the "Parking assistance systems" chapter.

Turning the trailer hitch view on/off



1. Press the button.
2. "More"
3. "Trailer coupling view"

To exit the trailer hitch view, select another camera view in the left toolbar.

Display

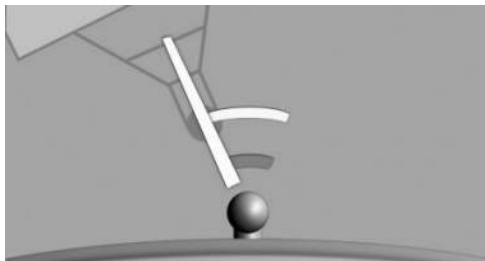

Two static circular segments help to estimate the distance of the trailer to the trailer hitch.

A docking line dependent on the steering-wheel angle helps with aiming for the trailer with the trailer hitch.

Car wash view

Principle

The car wash view assists when entering a car wash.

General information

Follow the information in the "Parking assistance systems" chapter.

Turning the car wash view on/off



1. Press the button.
2. "More"
3. "Car wash view"

To exit the car wash view, select a different camera view in the left toolbar.

Display

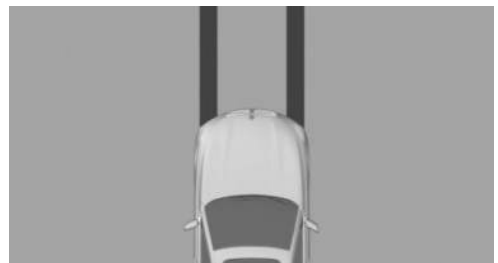

Your own lane is displayed for easier driving into a car wash.

This view can be used to position the vehicle correctly within the washing system guide rails.

In a car wash, the vehicle must be able to roll freely forward.

Additional information:

Rolling or pushing the vehicle, refer to page 134.

Panorama View

Principle

The panoramic view gives you an earlier view of crossing traffic at blind driveway exits and intersections.

General information

Road users concealed by obstacles to the left and right of the vehicle can only be detected relatively late from the driver's seat. To provide greater visibility, the front camera and, depending on vehicle equipment, rearview camera cover the side of the vehicle.

Depending on vehicle equipment, this function can turn on automatically when activation points are saved.

The camera image shows different levels of distortion in some areas and is thus not suitable for distance estimations.

Depending on vehicle equipment, the function can be used when driving forward or in reverse.

Follow the information in the "Parking assistance systems" chapter.

Sensors

The system is controlled by the following cameras:

- ▷ Rearview camera.
- ▷ Depending on the equipment: front camera.

Turning the panoramic view on/off

1.  Press the button.
2. "Panorama view"

To exit panorama view, select another camera view on the left toolbar.

Display



Yellow lines on the screen display identify the bumpers of your own vehicle.

When reverse gear is engaged, the reversing camera view is displayed. Depending on vehicle equipment, the front camera view is displayed when forward gear is engaged.

Automatic activation of panorama view

Principle

Positions at which panorama view should switch on automatically can be saved as activation points.

General information

Up to ten activation points can be stored.

The activation points can be used when driving forward and, depending on national-market version, when reversing.

Follow instructions in the Parking assistance systems chapter.

Functional requirements

- ▷ A GPS signal must be received.
- ▷ Depending on national-market version: A BMW ID or driver profile must be activated.

- ▶ The reversing camera and front camera must be installed.
- ▶ The direction of travel, selector lever position, and vehicle angle must correspond to a stored activation point.

Storing activation points

1. Drive your vehicle to the location where you want the system to turn on, then stop.



2. Press the button.

3. "Panorama view"

4. "Activation point"

The current position is displayed.

5. "Save activation point"

Activation points are saved with the following information, for example:

- ▶ With the city/town.
- ▶ With the city/town and the street.
- ▶ With the GPS coordinates.

You can rename the location and street information created automatically.

Using activation points

The use of activation points can be switched on and off.

1.  Apps menu
2. "Vehicle"
3. "Driving settings"
4. "Driver Assistance"
5. "Parking"
6. "GPS-based"

Editing activation points

You can rename or delete specific activation points or all of them.



1. Press the button.

2. "Panorama view"

3. "Manage points"

A list of all saved activation points is displayed.

4. Select the desired setting.

Door opening angle

Principle

Depending on vehicle equipment, the door opening angle display is shown automatically when stationary.

This display helps estimate how far the doors can be opened when parking.

If obstacle marking is activated, the parking view indicates fixed obstacles that obstruct the opening angles of the doors.

General information

Follow the information in the "Parking assistance systems" chapter.

Display



The maximum opening angle of the doors is displayed in selector lever position P.

System limits

The system does not provide a warning of approaching road users.

The vehicle's surroundings are distorted in the display for technical reasons.

Even if the door opening angle indicator on the control display does not overlap with any other objects, it is necessary to park carefully next to other objects.

Because of the perspective, higher, protruding objects may be closer than they appear on the control display.

Remote 3D View

Principle

The My BMW App and camera views in parking view such as automatic camera perspective enable you to display the vehicle's surroundings on a mobile device.

The function displays a snapshot of the situation.

General information

For reasons of data protection, the function can only be used three times within two hours.

Follow the information in the "Parking assistance systems" chapter.

Sensors

The system is controlled by the following cameras:

- ▶ Front camera.
- ▶ Top view cameras.
- ▶ Rearview camera.

Functional requirements

- ▶ Data transfer must be activated.

Data protection, refer to page 67.

- ▶ The My BMW App must be installed on the mobile end device.
- ▶ ConnectedDrive countries: a BMW ID with an existing ConnectedDrive account must be activated.
BMW ID/driver profiles, refer to page 68.

Activating/deactivating Remote 3D View

The function can be activated or deactivated individually or together with other functions.

1.  Apps menu
2. "Vehicle"
3. "System settings"
4. "Data privacy"
5. Select the desired setting.

After activation, Remote 3D View can be accessed using the My BMW App.

Functional limitations

The system may not be fully operational or may not be available in the following situations:

- ▶ With a door or the cargo area open. Dark fields in the display indicate areas that are not recorded by the system.
- ▶ With manually folded-in exterior mirrors.
- ▶ When other camera functions are being performed in the vehicle.
- ▶ The vehicle moves faster than walking speed.
- ▶ In case of missing or weak Internet connection.

Park Distance Control

Principle

Park Distance Control assists with parking. Acoustic and visual warnings signal obstacles in front of or behind the vehicle.

Obstacles that are detected by the side ultrasonic sensors can also be reported.

General information

The range of the system, depending on obstacles and environmental conditions, is approx. 6 ft/2 m.

An acoustic warning sounds in case of an impending collision at a distance to the object of approx. 27 in/70 cm.

For objects behind the vehicle, the acoustic warning is issued as early as a distance to the object of approx. 5 ft/1.50 m.

Follow the information in the "Parking assistance systems" chapter.

Safety information

Warning

The system cannot serve as a substitute for the driver's personal judgment in assessing the traffic situation. Based on the limits of the system, it cannot independently react to all traffic situations. There is a risk of accident, injury, and property damage. Adjust driving style to traffic conditions. Watch the surrounding traffic situation closely, be ready to take over steering and braking at any time, and actively intervene where appropriate.

Warning

Due to high speeds when the Park Distance Control is activated, the warning can be delayed due to physical circumstances. There is a risk of injury or risk of damage to property.

Avoid approaching an object too fast. Avoid driving off quickly while Park Distance Control is not yet active.

Sensors

The system is controlled by the following sensors:

- ▶ Ultrasonic sensors in the front/rear bumpers.
- ▶ Ultrasonic sensors, side.

Turning Park Distance Control on/off

Turning on the system automatically

The system switches on automatically in the following situations:

- ▶ When drive-ready state is switched on when selector lever position R is engaged.
- ▶ While approaching detected obstacles if the speed is lower than approx. 2.5 mph/4 km/h. The activation distance depends on the situation in question.

The automatic activation of detected obstacles can be activated or deactivated.

1.  Apps menu
2. "Vehicle"
3. "Driving settings"
4. "Driver Assistance"
5. "Parking"
6. "Automatic PDC activation"

Turning off the system automatically

When driving forward, the system turns off automatically as needed when a certain distance or speed is exceeded.

Turning the system on/off manually



Press the button.



- ▷ On: the LED illuminates.
- ▷ Off: the LED goes out.

If the system is manually switched on when the reverse gear is engaged, the rearview camera image is displayed.

Depending on the national-market version, the system cannot be turned off manually when the reverse gear is engaged.

Acoustic warning

General information

An intermittent tone indicates when the vehicle is approaching an object. E.g., when an object is detected at the rear left of the vehicle, a sound is heard from the rear left speaker.

The shorter the distance to the object, the shorter the intervals of the intermittent tones.

When the distance to a detected object is less than approx. 8 in/20 cm, a continuous tone is sounded.

When there are objects in front of and behind the vehicle at the same time, at a distance smaller than approx. 8 in/20 cm, an alternating continuous tone will sound between the front and rear speakers.

The intermittent tones and the continuous tone are turned off when selector lever position P is engaged.

Depending on national-market version, the intermittent tones are switched off after a short time when the vehicle is stationary.

If an object approaches when the vehicle is stationary, the acoustic signal is reactivated.

Adjusting the volume

The volume of the acoustic warning can be adjusted.

1. Apps menu
2. "Vehicle"
3. "Driving settings"

4. "Driver Assistance"
5. "Parking"
6. "PDC signal volume"
7. Set the desired value.

Depending on national-market version: Turn off acoustic warning

Depending on national-market version, the acoustic warning can be turned off while performing a parking maneuver.

Press the icon in the status field at the top of the control display.

When the Park Distance Control is switched on again, the acoustic warning is automatically switched on again.

Visual warning

General information

The approach to an object is displayed on the control display and in the instrument cluster as soon as the system is activated.

Objects that are farther away are already displayed before a signal sounds.

Depending on the view, pathway lines, turning circle lines and obstacle markings are shown for a better estimation of the space required.

Depending on vehicle equipment, the sensor detection range is shown by the shaded, ring-shaped area. Green, yellow, and red markings indicate when obstacles are detected within the detection range.

If vehicle is equipped with Cross Traffic Warning: A warning is also shown on the display for vehicles approaching from the side at the rear and front.

To protect the sides of the vehicle, obstacle markings are displayed on the sides of the vehicle.

Display

Depending on vehicle equipment, warnings may be displayed in front of, next to, and behind the vehicle.

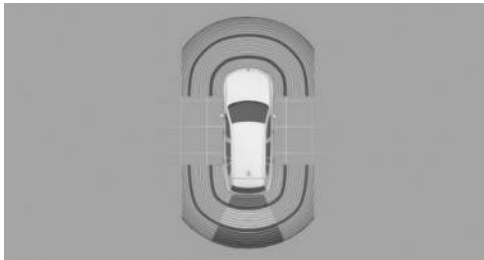

Example display of warnings behind the vehicle.



Example display of warnings next to the vehicle.

- ▷ Shaded area: Sensor detection range.
- ▷ Gray shaded area: No obstacles have been detected within the detection range.
- ▷ Colored marks in shaded area: Obstacles have been detected within the detection range.
- ▷ Shaded area interrupted: the area next to the vehicle has not yet been detected.

System limits

General information

The function for protecting the vehicle sides only shows stationary obstacles that were previously detected by the sensors when passing by.

The system does not detect whether an obstacle moves later on. When the vehicle is stationary, the gray shaded areas on the sides are hidden after a certain time. The area on the side of the vehicle must be newly captured.

Also follow the information on system limits in the "Parking assistance systems" chapter.

Trailer towing

The rear functions of Park Distance Control are switched off with a trailer attached or when the trailer socket is occupied.

Depending on vehicle equipment, the sensor detection range is shown by the shaded area on the control display.

Obstacles next to the vehicle are not displayed.

Depending on the national-market version, the rear functions of Park Distance Control remain switched on when trailer towing is enabled.



An icon is displayed on the control display.

Additional information:

Towing a trailer, refer to page [336](#).

Unwarranted warnings

Reaching the system limits can cause unwarranted warnings.

To prevent unwarranted warnings, for instance in car washes, turn off automatic Park Distance Control activation on obstacle detection.

Malfunction



An icon is displayed on the control display.

Depending on vehicle equipment: The sensor detection range may not be shown on the control display.

A Check Control message is displayed.

Park Distance Control malfunction. Have the vehicle checked by an authorized service center.

ter or another qualified service center or repair shop.

Active Park Distance Control

Principle

The Park Distance Control brake function initiates emergency braking if there is an acute risk of collision.

General information

Due to system limits, a collision cannot be prevented under all circumstances.

The function is available below walking speed when driving in reverse or rolling backward.

Pressing the accelerator pedal interrupts the brake intervention. Emergency braking is not performed.

After emergency braking to a stop, further creeping toward an obstacle is possible. Proceed with caution. To move forward, lightly press the accelerator pedal and release as needed.

If the accelerator pedal is depressed longer, the vehicle drives off. Manual braking is possible at any time.

Follow the information in the "Parking assistance systems" chapter.

Safety information

Warning

The system cannot serve as a substitute for the driver's personal judgment in assessing the traffic situation. Based on the limits of the system, it cannot independently react to all traffic situations. There is a risk of accident, injury, and property damage. Adjust driving style to traffic conditions. Watch the surrounding traffic situation closely, be ready

to take over steering and braking at any time, and actively intervene where appropriate.

Warning

When using the trailer hitch, the assistance system cannot react correctly because the sensors are concealed. There may be a risk of accidents or risk of damage to property. Do not use the driver assistance system while towing a trailer or when using the trailer hitch, e.g., for a rear bicycle rack.

Sensors

The system is controlled by the following sensors:

- ▷ Ultrasonic sensors in the rear bumpers.
- ▷ Ultrasonic sensors, side.

Deactivating Active Park Distance Control temporarily

After emergency braking, the function can be temporarily deactivated on the control display. A corresponding message is displayed.

1. "Configure"
2. "Deactivate temporarily"

During continued driving in this surrounding situation, no further emergency braking will occur.

The function is automatically reactivated when Park Distance Control is switched on again.

Settings

It is possible to set which areas on the vehicle will be protected by the system.

1.  Apps menu
2. "Vehicle"
3. "Driving settings"
4. "Driver Assistance"
5. "Parking"

6. "Active PDC emergency braking"
7. Select the desired setting.

Display



As soon as the system engages, an icon is displayed with a corresponding message.

System limits

General information

Follow the system limits in the "Parking assistance systems" chapter.

Functional limitations

The system cannot be used in the following situations, for example:

- ▶ While Hill Descent Control is regulating the vehicle speed, emergency braking is deactivated.
Hill Descent Control, refer to page 219.
- ▶ When driving with a trailer.

If applicable, turn off the system temporarily, if needed.

Drive-off monitoring

Principle

In case of a risk of collision, the start-up monitoring reduces the drive power when driving off.

General information

When obstacles are detected in close range in front of the vehicle, the acceleration will be reduced. If necessary, this permits timely manual braking.

When obstacles are detected behind the vehicle, the system will brake.

Follow the information in the "Parking assistance systems" chapter.

Safety information

Warning

The system cannot serve as a substitute for the driver's personal judgment in assessing the traffic situation. Based on the limits of the system, it cannot independently react to all traffic situations. There is a risk of accident, injury, and property damage. Adjust driving style to traffic conditions. Watch the surrounding traffic situation closely, be ready to take over steering and braking at any time, and actively intervene where appropriate.

Warning

When using the trailer hitch, the assistance system cannot react correctly because the sensors are concealed. There may be a risk of accidents or risk of damage to property. Do not use the driver assistance system while towing a trailer or when using the trailer hitch, e.g., for a rear bicycle rack.

Sensors

The system is controlled by the following sensors:

- ▶ Ultrasonic sensors in the front/rear bumpers.
- ▶ Ultrasonic sensors, side.

Functional requirements

- ▶ Selector lever position D or R is engaged when the vehicle is stationary.
- ▶ Obstacles in the immediate vicinity are detected in front of or behind the vehicle.

- ▷ The accelerator pedal is heavily applied, nearly to the end point.
- ▷ The accelerator pedal is immediately applied after engaging the selector lever position and obstacle detection.

Turning drive-off monitoring on/off

1.  Apps menu
2. "Vehicle"
3. "Driving settings"
4. "Driver Assistance"
5. "Parking"
6. "Drive off monitoring"
7. "Drive off monitoring"

A Check Control message is displayed where applicable.

Depending on the national-market version, the system is automatically turned on again at the next drive.

Canceling reduced drive power

The reduction of the drive power is canceled in the following situations:

- ▷ The accelerator pedal is released.
- ▷ After the accelerator pedal has been depressed completely twice.
- ▷ A specific distance has been traveled.

If the reduction in drive power is canceled by covering a certain distance, the drive power is released gradually.

Display



As soon as the system engages, an icon is displayed with a corresponding message.

System limits

General information

Follow the system limits in the "Parking assistance systems" chapter.

Trailer towing

The system is deactivated if the trailer power socket is occupied or trailer towing is activated, e.g., when using a trailer or rear bicycle rack.

Automatic Parking Assistant

Principle

Automatic Parking Assistant provides support when parallel parking and parking transverse to the road.

In addition, the system makes it easier to park out of parallel and perpendicular parking spaces.

The ultrasonic sensors measure both sides of the vehicle when driving slowly forward. Suitable parking spaces are calculated based on the objects detected, e.g., parking vehicles. The system status is displayed.

The system calculates the best possible parking line for driving in or out of parking spaces, and takes control of the vehicle while parking.

The operating principle and operation of the system is divided into the following steps:

- ▷ Parking space search.
- ▷ Turning on.
- ▷ Parking.
- ▷ Driving out of parking spaces.

The parking manoeuvre while parking is performed automatically.

When driving out of parallel parking spaces, the vehicle maneuvers automatically until it reaches a position where it can be driven out of the parking space without further steering movements.

When driving out of perpendicular parking spaces, the vehicle is maneuvered out of the parking space to enable continued driving in the desired direction.

The Automatic Parking Assistant Professional increases the comfort and range of uses of the Automatic Parking Assistant. In addition to the parking methods of the Automatic Parking Assistant, parking in parking spaces that are marked with lines is possible.

With Park Assist Professional, the parking maneuver can also be performed using Remote Control Parking on a smartphone.

Vehicle features and options

This system may not be available in the owned vehicle, e.g. due to the selected optional equipment, the national-market version or the option for later enabling and software updates. This also applies to individual functions of the system.

For information on whether a function is currently available in the vehicle or when the function can be installed in the vehicle, contact an authorized service center or another qualified service center or repair shop.

Additional information:

Vehicle equipment, refer to page 8.

General information

Follow the information in the "Parking assistance systems" chapter.

Safety information

Warning

The system cannot serve as a substitute for the driver's personal judgment in assessing the traffic situation. Based on the limits of the system, it cannot independently react to all traffic situations. There is a risk of accident, injury, and property damage. Adjust driving style to traffic conditions. Watch the

surrounding traffic situation closely, be ready to take over steering and braking at any time, and actively intervene where appropriate.

Warning

When using the trailer hitch, the assistance system cannot react correctly because the sensors are concealed. There may be a risk of accidents or risk of damage to property. Do not use the driver assistance system while towing a trailer or when using the trailer hitch, e.g., for a rear bicycle rack.

Warning

The system can steer the vehicle over or onto curbs. There is a risk of injury or risk of damage to property. Watch surrounding traffic closely and actively intervene where appropriate

Parking methods

Park Assist supports the following functions:

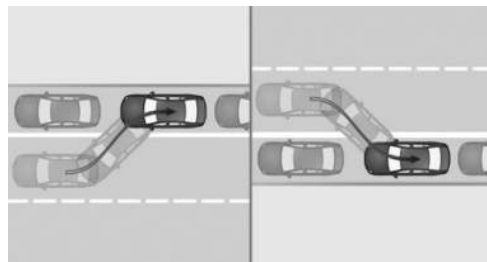

Parallel parking: reverse parking parallel to the road.

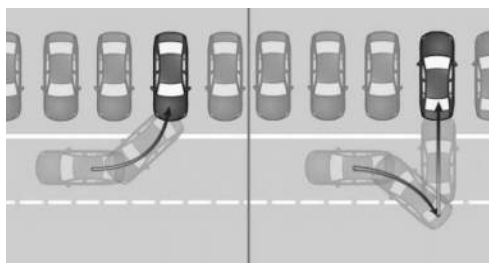

Perpendicular parking: reverse or forward parking perpendicular to the road.

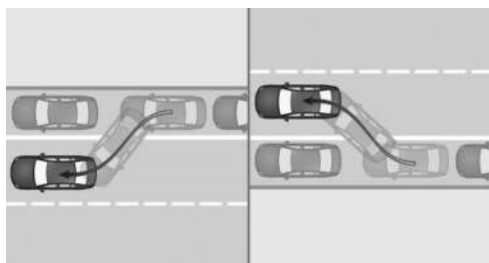

Driving out of parallel parking spaces.

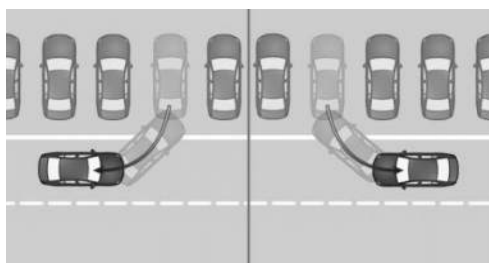

Driving out of perpendicular parking spaces.

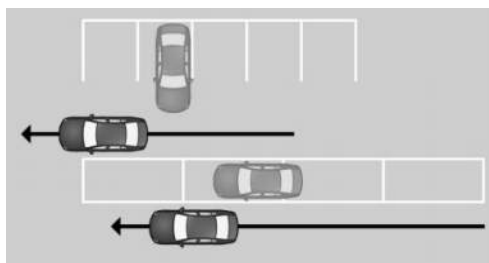

Park Assist Professional: Parking in parking spaces with parking lines.

Sensors

The Automatic Parking Assistant is controlled by the following sensors:

- ▷ Ultrasonic sensors in the front/rear bumpers.
- ▷ Ultrasonic sensors, side.

The Automatic Parking Assistant Professional is additionally controlled by the following cameras:

- ▷ Front camera.
- ▷ Top view cameras.
- ▷ Rearview camera.

Functional requirements

Measurement of parking spaces

- ▷ Maximum speed while driving forward approx. 22 mph/35 km/h.
- ▷ Maximum distance to row of parked vehicles: 5 ft/1.5 m.

Suitable parking space

Longitudinal parking:

- ▷ Minimum length of a detected object, e.g., a parking vehicle: approx. 3 ft/1 m.
- ▷ Minimum length of gap between two objects: own vehicle length plus approx. 2.6 ft/0.8 m.
- ▷ Minimum depth: approx. 5 ft/1.5 m.

Perpendicular parking:

- ▷ Minimum length of a detected object, e.g., a parking vehicle: approx. 3 ft/1 m.
- ▷ Minimum width of the gap: own vehicle width plus approx. 2.3 ft/0.7 m.
- ▷ Minimum depth: own vehicle length.

The depth of perpendicular parking spaces must be estimated by the driver. Due to technical limitations, the system is only able to approximate the depth of perpendicular parking spaces.

Parking lines for Park Assist Professional:

The parking space must be clearly marked with lines.

Parking operation

- ▷ Doors and cargo area are closed.
- ▷ Driver's seat belt is fastened.

Leaving parking spaces

- ▷ The vehicle was parked using the Automatic Parking Assistant, and an object has been detected in the area around the vehicle.
- ▷ The vehicle was manually parked in reverse, and objects have been detected in the immediate vicinity of the vehicle. The distance to a detected curb is at least 6 inches/15 cm.
- ▷ The parking space is at least 2.6 ft/0.8 m longer than the vehicle.

Displays





General information

The current status of parking assistance systems is shown on the right-hand toolbar, on the instrument cluster, and on the Head-up display, depending on vehicle equipment.

Different icons are shown on the control display for selecting the parking method.

The sequence of the displayed icons corresponds to the prioritized parking option.

The direction of the arrow changes for the icons for parking methods for driving out of a parking space.

Icon	Meaning
	Reverse lengthwise parking, right.
	Reverse lengthwise parking, left.
	Reverse perpendicular parking.
	Forward perpendicular parking.

Turning parking operation display on/off

When the Automatic Parking Assistant is active, the parking operation is displayed in the camera image on the control display.

1.  Apps menu
2. "Vehicle"
3. "Driving settings"
4. "Driver Assistance"
5. "Parking"
6. "Show assistance info"

Turning the signal tone on/off

The signal tone for suitable parking spaces can be turned on and off.

1.  Apps menu
2. "Vehicle"
3. "Driving settings"
4. "Driver Assistance"
5. "Parking"
6. "Sound when available"

Parking using the Automatic Parking Assistant

1. For the parking space search when driving past parked vehicles at a speed of up to approx. 22 mph/35 km/h and a distance of max. 5 ft/1.5 m.

 The parking space search is activated.

2. Press the  button or engage reverse gear.

The parking assistance systems view is displayed.

The status of the parking space search and possible parking spaces are displayed on the control display and in the instrument cluster.



3. On the control display: Select one of the parking maneuvers offered. You can switch to another parking maneuver as necessary. In the instrument cluster: select suggested parking method with the knurled wheel on the steering wheel.

 Green: the system takes control of the parking operation.

4. Follow the instructions on the control display or in the instrument cluster.

The speed can be reduced with the brake. Other interventions will cancel the system.

Depending on national-market version, an intermittent or continuous tone sounds for Park Distance Control.

At the end of the parking operation, selector lever position P is set.

The end of the parking operation is indicated on the control display and in the instrument cluster.

5. Adjust the parking position yourself, if needed.

Driving out of a parking space using the Automatic Parking Assistant

1. Turn on drive-ready state.



2. With the vehicle at a standstill, press button or engage reverse gear.

The parking assistance systems view is displayed.

3. On the control display: select the desired parking method.

In the instrument cluster: select suggested parking method with the knurled wheel on the steering wheel.

4. Follow the instructions on the control display or in the instrument cluster.

 Green: the system takes control of maneuvering.

The speed can be reduced with the brake. Other interventions will cancel the system. A message will be displayed at the end of the maneuver.

5. Make sure that the traffic situation permits driving out of parking space and driving off as usual.

The Automatic Parking Assistant is turned off automatically.

Canceling Automatic Parking Assistant manually

The Automatic Parking Assistant can be canceled manually at any time, e.g.:

- ▷ Step lightly on the accelerator pedal twice in succession.
- ▷ Step lightly on the accelerator pedal and move the steering wheel slightly at the same time.
- ▷ Depress the brake pedal and operate the selector lever at the same time.

The Automatic Parking Assistant is canceled without engaging selector lever position P. Driving can continue immediately.

Canceling Automatic Parking Assistant automatically

The system automatically cancels in situations such as the following:

- ▷ When the driver grasps the steering wheel or takes over steering.
- ▷ When operating the accelerator pedal or the selector lever.
- ▷ When setting the parking brake.
- ▷ When unfastening the driver's seat belt.
- ▷ With open cargo area.
- ▷ With open hood.
- ▷ With the doors open.
- ▷ During activation or intervention by driver assistance systems.

- ▷ When changing over to another function on the control display.
- ▷ When the view on the control display is overlaid with messages.
- ▷ On snow-covered or slippery road.
- ▷ On steep uphill or downhill grades.
- ▷ When there are obstacles that are hard to overcome such as curbs.
- ▷ When there are obstacles that suddenly appear.
- ▷ With insufficient distances, which are indicated by Park Distance Control.
- ▷ When a maximum number of parking attempts or the time taken for parking is exceeded.
- ▷ Automatic Parking Assistant: for parking spaces that are only marked with lines on the ground. The system orients itself according to objects.
- ▷ For special parking spaces, e.g., metered parking spaces with automatic locking mechanisms, or mechanical parking systems.

When the system is automatically aborted, selector lever position P is engaged.

A Check Control message is displayed where applicable.

Continuing the parking operation

If parking or leaving a parking space has been interrupted, the operation can be continued, if needed.

Turn the Automatic Parking Assistant on again and follow the instructions on the control display or in the instrument cluster.

System limits

General information

Follow the system limits in the "Parking assistance systems" chapter.

No parking assistance

The Automatic Parking Assistant does not offer assistance in the following situations:

- ▷ In tight curves.
- ▷ For diagonal parking spaces.
- ▷ When towing a trailer.

Functional limitations

The system may be limited in the following situations:

- ▷ On bumpy road surfaces such as gravel roads.
- ▷ On slippery ground.
- ▷ On steep uphill or downhill grades.
- ▷ With accumulations of leaves/snow in the parking space.
- ▷ In case of changes to an already-measured parking space.
- ▷ With ditches or edges, for instance an edge of a port.
- ▷ Parking spaces that are not suitable may be detected or suitable parking spaces may not be detected at all.

Malfunction

A Check Control message is displayed.

The Automatic Parking Assistant has malfunctioned. Have the vehicle checked by an authorized service center or another qualified service center or repair shop.

Maneuver Assistant

Principle

The Maneuver Assistant provides support for recurring parking and maneuvering situations. Parking and maneuvering operations can be recorded and then carried out automatically by the system.

Vehicle features and options

This system may not be available in the owned vehicle, e.g. due to the selected optional equipment, the national-market version or the option for later enabling and software updates. This also applies to individual functions of the system.

For information on whether a function is currently available in the vehicle or when the function can be installed in the vehicle, contact an authorized service center or another qualified service center or repair shop.

Additional information:

Vehicle equipment, refer to page 8.

General information

A recurring maneuver is driven manually and thereby recorded.

When the vehicle reaches the activation area for the distance covered by the stored maneuver, the maneuver can be activated on the control display or in the instrument cluster.

After the activation, the system takes control of the vehicle and carries out the maneuver automatically.

In addition, the parking maneuver can be performed using Remote Control Parking on a smartphone.

Follow the information in the "Parking assistance systems" chapter.

Safety information

Warning

The system cannot serve as a substitute for the driver's personal judgment in assessing the traffic situation. Based on the limits of the system, it cannot independently react to all traffic situations. There is a risk of accident, injury, and property damage. Adjust driving style to traffic conditions. Watch the surrounding traffic situation closely, be ready

to take over steering and braking at any time, and actively intervene where appropriate.

Warning

When using the trailer hitch, the assistance system cannot react correctly because the sensors are concealed. There may be a risk of accidents or risk of damage to property. Do not use the driver assistance system while towing a trailer or when using the trailer hitch, e.g., for a rear bicycle rack.

Warning

The system can steer the vehicle over or onto curbs. There is a risk of injury or risk of damage to property. Watch surrounding traffic closely and actively intervene where appropriate

Detection range

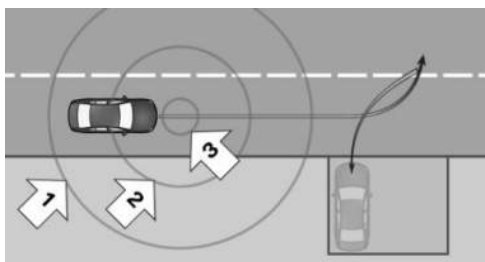

The detection range for a maneuver is divided into the following areas:

- ▶ Proximity range, arrow 1: the system will begin with the localization in the background within a range of approx. 26 ft/8 m around the distance covered of a stored maneuver.
- ▶  Close range, arrow 2: in a range of approx. 6 ft/2 m around the distance covered,

a stored maneuver can be displayed on the control display.

- ▶  Activation range, arrow 3: the stored maneuver on the control display can be activated within a range of approx. 3.5 ft/1 m. After the activation, the system takes control of the vehicle and carries out the maneuver automatically.

Sensors

The system is controlled by the following sensors and cameras:

- ▶ Ultrasonic sensors in the front/rear bumpers.
- ▶ Ultrasonic sensors, side.
- ▶ Front camera.
- ▶ Top view cameras.
- ▶ Rearview camera.

Recording maneuver

General information

Up to ten maneuvers can be recorded at different locations.

Up to four overlapping maneuvers can be recorded.

Identical maneuvers under different ambient conditions can be recorded such as light conditions.

For each maneuver, a maximum distance covered of 656 ft/200 m is possible.

In total, a distance covered of approx. 1,969 ft/600 m distributed to the ten possible maneuvers can be recorded.

Maneuvers with a distance covered of less than 20 ft/6 m cannot be recorded.

Recording maneuver

1. Drive the vehicle to the starting point from which a maneuver must be recorded and stop.



2.  Press the button.

The parking assistance systems view is displayed.

3.  "Record new path"
4. Drive the vehicle to the desired end position.



The maneuver is recorded.

When recording a route, do not drive faster than 9 mph/15 km/h.

While recording, the distance covered will be displayed.

When the maximum distance covered or the maximum speed is reached, a message will be displayed and a signal tone will sound.

5. With a stationary vehicle: "Save recording"
6. "Name:"
If necessary, enter the desired name for the recorded maneuver.
7. "Save recording"
Do not move the vehicle until the recording has been stored.

Performing stored maneuver

1. Drive the vehicle into the activation range and stop. The control display and instrument cluster indicate that a stored maneuver can be activated.
2.  : activate stored maneuver.

 Green: after activation, the system takes control of the vehicle and performs the maneuver automatically. If applicable, follow the instructions on the control display or in the instrument cluster.

The speed can be reduced with the brake. Other interventions will cancel the system.



At the end of the parking operation, selector lever position P is set.

Canceling the Maneuver Assistant manually

The vehicle can be controlled manually during an active maneuver by taking the following actions:

- ▷ Step lightly on the accelerator pedal twice in succession.
- ▷ Step lightly on the accelerator pedal and move the steering wheel slightly at the same time.
- ▷ Depress the brake pedal and operate the selector lever at the same time.

The Maneuver Assistant is canceled without engaging selector lever position P. Driving can continue immediately.

Canceling the Maneuver Assistant automatically

The system automatically cancels in situations such as the following:

- ▷ When the driver grasps the steering wheel or takes over steering.
- ▷ When operating the accelerator pedal or the selector lever.
- ▷ When the driver's seat belt is not fastened.
- ▷ With open cargo area.
- ▷ With open hood.
- ▷ With the doors open.
- ▷ During activation or intervention by driver assistance systems.
- ▷ When the system limits of the ultrasonic sensors and cameras are reached.
- ▷ When changing over to another function on the control display.
- ▷ When the view on the control display is overlaid with messages.
- ▷ In case of obstacles.

- ▷ On snow-covered or slippery road.
- ▷ When the lane is too narrow.
- ▷ On steep uphill or downhill grades.
- ▷ With trailer towing.

In the event of an automatic cancellation of the system, the vehicle is decelerated to a complete stop and selector lever position P is engaged.

An interrupted maneuver can be continued, if needed. Turn the Maneuver Assistant on again and follow the instructions on the control display or in the instrument cluster.

Editing stored maneuvers

Individual or all maneuvers can be deleted or renamed.

1.  Apps menu
2. "Vehicle"
3. "Driving settings"
4. "Driver Assistance"
5. "Parking"
6. "Recorded paths"
7. Select the desired setting.

System limits

General information

Follow the system limits in the "Parking assistance systems" chapter.

Functional limitations

The system does not provide support when towing a trailer.

System limits can cause functional limitations such as in the following situations:

- ▷ With poor GPS reception.
- ▷ On steep uphill or downhill grades.
- ▷ In case of recorded maneuvers where the system minimum distance to objects cannot be maintained.

- ▷ Greatly deviating conditions when storing and driving the distance covered, for instance other tires or changed ambient conditions like light conditions or weather.
- ▷ Delayed display of overlapping stored maneuvers when driving into the activation area.
- ▷ In multi-story parking garages, for recordings at different parking levels, or for recordings that run over several parking levels.

Remote Control Parking

Principle

With Remote Control Parking, the vehicle can be driven remotely when parking and maneuvering using the Maneuver Assistant and Park Assist Professional.

The maneuver is performed independently, outside the vehicle, using a smartphone. This makes it easy to get in and out of the vehicle.

When parking in a suitable spot, e.g., a garage, you can correct the parking position with Remote Control Parking by maneuvering slightly.

A maneuver that has already been started can be continued at any time with Remote Control Parking.

Vehicle features and options

This system may not be available in the owned vehicle, e.g. due to the selected optional equipment, the national-market version or the option for later enabling and software updates. This also applies to individual functions of the system.

For information on whether a function is currently available in the vehicle or when the function can be installed in the vehicle, contact an authorized service center or another qualified service center or repair shop.

Additional information:

Vehicle equipment, refer to page 8.

General information

Note the information in the Automatic Parking Assistant and Maneuver Assistant chapter.

Protect the smartphone against unauthorized use.

The low-beam headlights are switched on for the duration of the maneuver.

A parking maneuver offered by Park Assist Professional is only available for Remote Control Parking for a short time after exiting the vehicle.

Functional requirements

- ▷ All occupants have left the vehicle.
- ▷ Doors and cargo area are closed.
- ▷ The smartphone is compatible with Remote Control Parking.
- ▷ The My BMW App must be installed on a compatible smartphone.
- ▷ The My BMW App must be linked to a ConnectedDrive account.
- ▷ Bluetooth must be enabled on the smartphone.
- ▷ The distance between vehicle and smartphone is no greater than approx. 19 ft/6 m.
- ▷ A valid digital key must be set up for the vehicle, then recognized without issue.

Additional information:

BMW Digital Key, refer to page 86.

Parking with Remote Control Parking

1. Engage selector lever position P.
2. Leave the vehicle and close the doors and cargo area.
3. Open Remote Control Parking in the My BMW app and maneuver forward or backward, or select the desired parking method.
4. Follow the instructions on the smartphone.



Stop the vehicle manually if obstacles are present.

Depending on the option selected in the My BMW app, the vehicle is either parked at the end of the parking maneuver or you can take control of the vehicle again.

System limits

Due to ambient conditions, e.g., impaired Bluetooth connection transmission due to external faults, Remote Control Parking may be interrupted.

If the power supply of the vehicle battery is not sufficiently ensured, e.g., due to excessive discharge, Remote Control Parking may not be available. Follow the instructions in the My BMW App.

It may not be easy to maneuver into a parking space. This function is offered on the My BMW app but cannot be used due to ambient conditions.

Back-up assistant

Principle

The Back-up Assistant helps when reversing, e.g., when pulling out of tight or unclear parking or road situations.

Vehicle features and options

This system may not be available in the owned vehicle, e.g. due to the selected optional equipment, the national-market version or the option for later enabling and software updates. This also applies to individual functions of the system.

For information on whether a function is currently available in the vehicle or when the function can be installed in the vehicle, contact an authorized service center or another qualified service center or repair shop.

Additional information:

Vehicle equipment, refer to page 8.

General information

The vehicle stores the driving movements of the last distance covered. This stored distance can be driven in reverse with automated steering.

The system takes over the steering. The driver must control the speed using the accelerator and brake pedals.

Back-up Assistant: a maximum of 164 ft/50 m are stored.

Reversing Assistant Professional: a maximum of 656 ft/200 m are stored.

Follow the information in the "Parking assistance systems" chapter.

Safety information

Warning

The system cannot serve as a substitute for the driver's personal judgment in assessing the traffic situation. Based on the limits of the system, it cannot independently react to all traffic situations. There is a risk of accident, injury, and property damage. Adjust driving style to traffic conditions. Watch the surrounding traffic situation closely, be ready to take over steering and braking at any time, and actively intervene where appropriate.

Warning

When using the trailer hitch, the assistance system cannot react correctly because the sensors are concealed. There may be a risk of accidents or risk of damage to property. Do not use the driver assistance system while towing a trailer or when using the trailer hitch, e.g., for a rear bicycle rack.

Warning

The system can steer the vehicle over or onto curbs. There is a risk of injury or risk of damage to property. Watch surrounding traffic closely and actively intervene where appropriate

Functional requirements

- ▷ Drive forward without interruption to store the distance covered.
- ▷ To store the distance covered, do not drive faster than 22 mph/35 km/h.
- ▷ No trailer towing.
- ▷ Back-up Assistant Professional: sufficiently bright light conditions on the saved route.
- ▷ Back-up Assistant Professional: the cameras on the vehicle must be clean and clear.

Driving in reverse with automated steering

1. Turn on drive-ready state.



2.  With the vehicle at a standstill, press button or engage reverse gear.

The parking assistance systems view is displayed.

3.  "Start back-up Assistant"

The length of the distance covered is displayed on the control display and in the instrument cluster.

If applicable, follow the instructions on the control display or in the instrument cluster.

4. Take your hands off the steering wheel and carefully drive in reverse with the accelerator pedal and the brake.

 Green: the system takes control of steering.

When driving in reverse, observe the vehicle's surroundings.

In case of obstacles, stop immediately and take over control of the vehicle. Follow the instructions for Park Distance Control.

5. Right before the end of the stored distance covered, a signal tone will sound and a message is displayed.

Stop no later than when normal road traffic is reached and take control of the vehicle such as by shifting to forward gear.

Canceling the Back-up Assistant manually

The assisted reversing by the Back-up Assistant can be canceled manually:

- ▷  "Cancel"

- ▷  Press the button.



Canceling the Back-up Assistant automatically

The system automatically cancels in situations such as the following:

- ▷ When the driver grasps the steering wheel or takes over steering.
- ▷ When shifting from reverse gear to another selector lever position.
- ▷ During activation or intervention by driver assistance systems.
- ▷ After an extended period of time when the vehicle is stationary.
- ▷ When exiting the stored lane when reversing, for instance with maximum steering-wheel angle.
- ▷ When the view on the control display is overlaid with messages.
- ▷ In case of a slippery surface.
- ▷ When the vehicle is rolling such as on a slope.
- ▷ In case of changed ambient conditions.



- ▶ When the trailer power socket is occupied or when trailer towing is activated.
- ▶ If the vehicle speed exceeds approx. 6 mph/10 km/h.
- ▶ Reversing Assistant Professional: if sensor functionality is limited beyond approx. 164 ft/50 m.

System limits

- ▶ The maximum speed when reversing is limited to approx. 6 mph/10 km/h.
A warning is issued at a speed of approx. 4 mph/7 km/h.
If the maximum speed is exceeded, the function is interrupted.

Different influences can lead to side deviations when driving the stored distance covered in reverse. For example, this includes the following factors:

- ▶ Steering movements when the vehicle is stationary while storing the distance covered.
- ▶ The speed is not adapted to the distance covered.
- ▶ Certain road characteristics such as gradients, inclines or slippery road surface.
- ▶ Greatly deviating conditions when storing and driving the route, for instance other tires or changed ambient conditions like weather.
- ▶ Reversing Assistant Professional: for changed light conditions.

Also follow the information on system limits in the "Parking assistance systems" chapter.

Driving comfort

Vehicle features and options

This chapter describes model-specific equipment, systems, and functions that are currently available, or may become available in the future, even if they are not present in the vehicle.

Additional information:

Vehicle equipment, refer to page 8.

Executive Drive Pro

Principle

Executive Drive Pro is an actively controlled chassis. The system increases driving comfort and minimizes the roll tendency when cornering.

General information

For active control, this system uses the available information, for instance from the navigation system, the Driving style analysis and the camera-based look-ahead data.

This information influences the control of the following systems:

- ▶ Active roll stabilization.
- ▶ Integral Active Steering.

This further increases the agility and comfort of the vehicle.

The function may be restricted if the navigation data is invalid, outdated or not available, for example.

Depending on the equipment, the rear axle lock differential will be adjusted for the traction conditions as needed.

Active roll stabilization

Active roll stabilization provides increased driving comfort while improving vehicle agility and stability. Among other things, the system enables a more dynamic response to steering movements and reduces the body's tendency to roll when cornering quickly or making quick evasive maneuvers. This means that, e.g., the lateral head movements of the occupants are reduced.

Two-axle ride level control

Principle

The two-axle self-leveling suspension uses air springs to ensure the best possible driving comfort. Regardless of the load, the vehicle will be maintained at the configured vehicle level.

General information

The shock absorbers can be set from comfortable to sporty via the Driving Experience Control drive modes.

Depending on the driving situation, the vehicle level can be set to different levels:

- ▶ Entry height:
 - Lowest vehicle level setting.
 - When the vehicle is stationary, the following options are available for setting the entry height:
 - ▶ With the rocker button on the center console.
 - ▶ With the button in lower trunk lid
 - ▶ With the My BMW app.
 - The vehicle will be raised according to the selected drive mode when driving off.
- ▶ Sport level:

Lowest vehicle level, for driving at higher speeds.

▷ Normal level:

Standard level for normal roads and speeds.

▷ High level 1:

Raised vehicle level for easy terrain at reduced speed.

If necessary, the vehicle will be lowered at higher speeds.

▷ High level 2:

Highest vehicle level, for terrains with major uneven surfaces in the lowest speed range.

If necessary, the vehicle will be lowered at higher speeds.



Rocker button for level control.

Button on lower tailgate

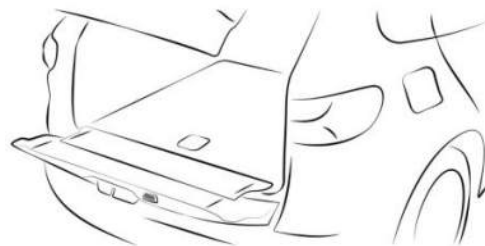

Button for self-leveling suspension.

Safety information

Warning

Adjusting the vehicle height may result in trapped body parts or damaged vehicle parts. There is a risk of injury or risk of damage to property. When adjusting the vehicle height, make sure that the areas of movement around the vehicle and at the wheel housing are free.

Functional requirement

All doors are closed.

Opening a door while raising or lowering the vehicle interrupts the process. The process continues after closing the door.

Overview

Rocker button in vehicle

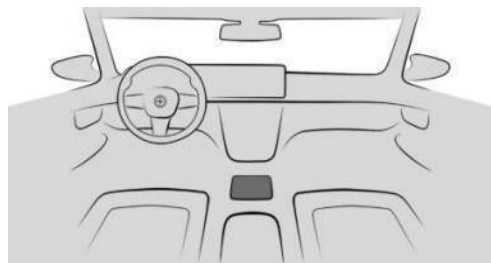

Activating/deactivating self-leveling suspension

The system can be deactivated, e.g., to change a wheel or for towing.

Push the rocker button forward or pull it backward, then hold for approx. 7 seconds.

When the rocker button is released, the LED indicates the system status.

- ▷ LED illuminates: the self-leveling suspension is activated.
- ▷ LED goes out: the self-leveling suspension is deactivated.

The self-leveling suspension is automatically activated after driving off at speeds above approx. 6 mph/10 km/h.

Setting the vehicle level manually



Press rocker button forward:

The vehicle is raised to the next highest vehicle level.

Press rocker button backward:

The vehicle will lower by one level.

LED display on rocker button

- ▶ LED illuminates: Current vehicle level displayed.
- ▶ LED flashes: adjustment procedure running. The vehicle raises or lowers itself.
- ▶ LED flashes rapidly: The selected vehicle level is not possible at this time.
- ▶ LED off: System is deactivated.
- ▶ All LEDs on rocker button flashing: System is initializing. The selected vehicle level will be adjusted as required after initialization.

Setting the vehicle level automatically

While driving

The vehicle will lower automatically in the following situations:

- ▶ When switching to SPORT drive mode.
- ▶ At higher speeds.

When a set vehicle level is exited due to the speed, the vehicle level will be adjusted according to the selected driving mode.

In the event of a flat tire

When a loss of tire inflation pressure is detected in a wheel, the pressure on this wheel is reduced automatically to increase the possible distance traveled. In this situation, only the normal level is available.

Adjusting vehicle level using button on lower tailgate

Principle

When the tailgate is open, the button on the tailgate can be used to lower the vehicle to entry height and raise it again for easier loading and unloading.

Setting the vehicle level



Press the button on the lower tailgate.

The vehicle is lowered to entry height.

Press the button again to raise the vehicle.

The flashing of the LED in the button indicates the level change.

During the raising procedure, the vehicle raises itself from the entry height to the level that was selected last or the normal level.

Canceling the adjustment procedure

Press the button again. The vehicle raises or lowers itself back to the starting level.

Lowering the vehicle level via the My BMW app

Principle

Using the My BMW App and a compatible Apple iPhone, the vehicle level can be set when stationary, e.g., to make loading or entry easier.



Setting the vehicle level

For safety reasons, lowering is only possible from the normal level or the Sport level.

1. Apply the parking brake and turn off drive-ready state using the Start/Stop button.
2. Closing the doors.
3. In the My BMW app, switch to the entry height menu and follow the instructions.

Additional information:

Owner's Manual for Navigation, Entertainment, and Communication, refer to page 6.

Canceling the adjustment procedure

If an adjustment procedure was started with the My BMW app, it can be canceled with the app.

Long stationary periods

During long stationary periods, the vehicle may lower itself. This is not a malfunction.

When the drive-ready state is switched on with the doors closed, the vehicle is raised to the normal level automatically.

Depending on the condition of the vehicle, raising to normal level may take several minutes.

System limits

- ▶ It may not possible to change the vehicle level during sporty driving.
- ▶ It may not be possible to change the vehicle level with articulated axles.
- ▶ It may only be possible to raise the vehicle level in the drive-ready state.
- ▶ If the vehicle battery charge is too low, the vehicle level cannot be changed.
- ▶ If the vehicle level is frequently changed in quick succession, the system switches off to prevent overheating and will be temporarily unavailable or operate at a delay. Let the system cool down, if needed.

- ▶ If the payload is increased, the highest driving level may be disabled or automatically exited in order to protect the system.
- ▶ When the trailer power socket is occupied, only the normal level is available.

Malfunction

A Check Control message is displayed.

In case of a malfunction, the vehicle will have changed handling characteristics or a noticeably reduced driving comfort.

Have the vehicle checked by an authorized service center or another qualified service center or repair shop.

xOFFROAD package

Principle

The xOFFROAD package assists the driver when driving on unpaved roads or when there is reduced traction.

General information

The system offers four different xOFFROAD driving modes for selection. When an xOFFROAD driving mode is switched on, individual systems in the vehicle are set to the best possible traction and driving stability.

xOFFROAD driving modes can be selected based on the ground conditions.

With two-axle ride level control, the vehicle level is set according to the corresponding xOFFROAD driving mode.

Observe the information in the chapter Driving tips for driving on poor roads.

Additional information:

Driving on poor roads, refer to page 328.



Overview

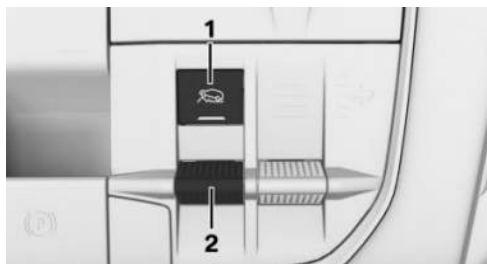

- 1 xOFFROAD: button
- 2 xOFFROAD: rocker switch

Activating xOFFROAD driving mode



Press the button.

or

Push the rocker switch forward or pull it backward.

The following functions are executed:

- ▶ The LED in the button illuminates.
- ▶ The following xOFFROAD driving mode is set: "xGRAVEL".

Additional information:

xOFFROAD driving modes in detail, refer to page [283](#).

Setting the xOFFROAD driving mode

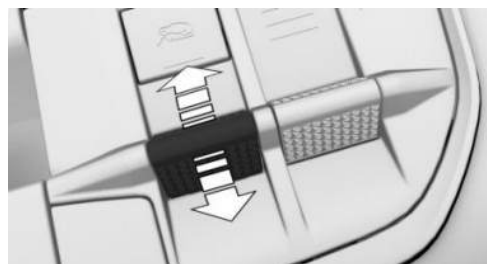

Repeatedly push the rocker switch forward or pull it back until the desired xOFFROAD driving mode is displayed on the instrument cluster.

Deactivating xOFFROAD driving mode



Press the button.

The LED in the button goes out.

The last driving mode that was set through the Driving Experience Control will be activated.

If a driving mode is selected via Driving Experience Control, xOFFROAD driving mode is automatically deactivated.

xOFFROAD driving modes in detail

When xOFFROAD driving modes are switched on, the following vehicle settings are applied:

- ▶ Auto Start/Stop function is switched off.
- ▶ The shift characteristics and response to the accelerator pedal are adapted.
- ▶ The all-wheel drive system is set for optimum traction.
- ▶ The response characteristics of the Antilock Braking System are adapted.
- ▶ The response characteristics of Dynamic Stability Control are adapted.

Additional vehicle settings are applied, depending on the xOFFROAD driving mode selected.

xOFFROAD driving mode	Settings
"xGRAVEL"	Setting for easy terrain. High level 1 of the two-axle self-leveling suspension is set.
"xSAND"	Setting for difficult terrain with loose ground. High level 1 of the two-axle self-leveling suspension is set. For maximum traction, disable Dynamic Stability Control. Deactivate Forward Collision Mitigation as necessary to prevent it from automatically activating Dynamic Stability Control.

xOFFROAD driving mode	Settings
"xROCKS"	Setting for difficult terrain with severe ground unevenness. High level 2 of the two-axle self-leveling suspension is set. For maximum traction, disable Dynamic Stability Control. Deactivate Forward Collision Mitigation as necessary to prevent it from automatically activating Dynamic Stability Control.
"xSNOW"	Setting for road smoothness. The transmission shift characteristics are set to smooth gear changes. The vehicle drives off in second gear as necessary. The accelerator pedal characteristics are optimized for gentle handling.

Additional information:

- ▷ Two-axle ride level control, refer to page [279](#).
- ▷ Forward Collision Mitigation, refer to page [183](#).

xOFFROAD display

Enabling an xOFFROAD driving mode automatically opens the xOFFROAD display in the Live Vehicle menu.

The following information is displayed:

- ▷ Distribution of drive torque to the wheels.
- ▷ Longitudinal inclination: specified in percent.
- ▷ Transverse inclination: specified in degrees.

- ▷ Graph of wheel angle.
- ▷ With navigation system: elevation for the current position.
- ▷ Level adjustment of the two-axle ride level control.

Additional information:

Live Vehicle, refer to page [146](#).

System limits

At higher speeds, the characteristics of the selected xOFFROAD driving mode are reduced.

BMW IconicSounds

Depending on vehicle equipment and national-market version, the vehicle drive sound can be adjusted using BMW IconicSounds.

1.  Apps menu
2. "Vehicle"
3. "Driving settings"
4. "Drivetrain and chassis"
5. "IconicSounds"
6. Select the desired setting.

Climate control

Vehicle features and options

This chapter describes model-specific equipment, systems, and functions that are currently available, or may become available in the future, even if they are not present in the vehicle.







Additional information:







Vehicle equipment, refer to page 8.

Climate control

Overview



Functions in the Climate menu

Icon	Function
	Turn the climate control system on/off.
	Automatic program.
	Temperature.
	Air conditioning.
	Maximum cooling.
	Air recirculation mode.
	Automatic recirculated-air control.

Icon	Function
	Fresh air.
	Air flow.
	Air distribution.
	SYNC program.
	Seat and armrest heating.
	Active seat ventilation.
	Steering wheel heating.

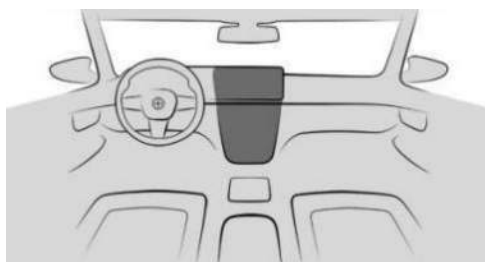





Buttons, automatic climate control



Icon	Function
	Defrost function.
	Rear window defroster.

Buttons, rear automatic climate control

- ▷ Second-row seating: the control panel for the rear climate control is located in the rear center console.
- ▷ Third-row seating: the control panel for the rear climate control is located in the headliner.

Icon	Function
	Automatic program.
	Temperature.
	Air conditioning.
	Maximum cooling.
	Air flow.
	Air distribution.
	Seat and armrest heating.

Calling up climate control functions

The Climate menu can be accessed via iDrive:



-  Tap the icon for the Climate menu on the menu bar.

Or:

1.  Apps menu
2. "Vehicle"
3. "Climate control"

Turning the air conditioning system on/off

The climate control system can be turned on or off via iDrive.

1.  Tap the icon for the Climate menu on the menu bar.
2.  Tap the power button.

The entire climate control system is turned on or off with the last settings applied.

When the air conditioning system is turned on, individual climate control functions can be turned off.

Settings

You can configure individual settings for climate control functions via iDrive, e.g.:

- ▷ Intensity of seat heating.
- ▷ Pre-ventilation.

1.  Tap the icon for the Climate menu on the menu bar.
2. "Individual settings" or "General settings"
3. Select the desired setting.

Turning rear automatic climate control on/off

Functional requirements

- ▷ Automatic climate control is turned on.
- ▷ Defrost function is deactivated.

Via iDrive

1.  Tap the icon for the Climate menu on the menu bar.
2. "Individual settings"
3. "Second row of seats"



4. "Rear climate control"
5. Select the desired setting.

The rear climate control can be activated with the default settings for temperature and the AUTO program:

"Activate with default settings"

Switching on using the button

Press one of the following buttons:

- ▷ Temperature.
- ▷ Maximum cooling.
- ▷ Automatic program.
- ▷ Upper side of the air flow, manual button.
- ▷ Air distribution, manual.

Switching off using the button



Second-row seating:

Press and hold the bottom of the button.

Locking the rear automatic climate control



1. Tap the icon for the Climate menu on the menu bar.
2. "Individual settings"
3. "Second row of seats"
4. "Lock rear climate control"

Automatic program

Principle

The automatic program ensures a comfortable climate, which can be modified with the desired temperature and individual settings.

The automatic program cools, ventilates or heats the vehicle interior automatically.

General information

Depending on the equipment, the automatic program provides the best possible settings for climate control functions depending on the outside temperature, interior temperature, sunlight, seat occupancy and the desired temperature setting:

- ▷ Air flow.
- ▷ Air distribution.
- ▷ Temperature.
- ▷ Seat and armrest heating.
- ▷ Active seat ventilation.
- ▷ Steering wheel heating.

The automatic program takes seat occupancy into account, regulating the climate in an energy-efficient manner that is tailored to the occupants.

At the same time, a condensation sensor controls the automatic program in order to prevent window condensation to the extent possible.

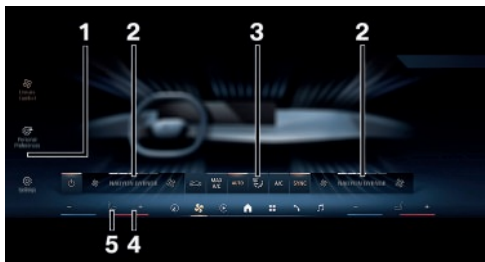

Overview



- 1 Settings
- 2 Air flow intensity
- 3 Climate control functions bar
- 4 Temperature
- 5 Seat heating
 - Steering wheel heating
 - Active seat ventilation

Turning the automatic program on/off

The AUTO program can be switched on or off via iDrive.

-  Tap the icon for the Climate menu on the menu bar.
-  Tap the AUTO program button.

Switching the rear climate control automatic program on/off

Via iDrive

-  Tap the icon for the Climate menu on the menu bar.
- "Individual settings"
- "Second row of seats"
- "Automatic climate"
- Select the desired setting.

Using the button

-  Press the button.
The LED of the button is illuminated when the automatic program is turned on.

Setting the intensity

When the automatic program is activated, the intensity of individual climate control functions, e.g., seat heating, is adjusted individually.

-  Tap the icon for the Climate menu on the menu bar.
- "Individual settings"
- Select the desired setting.

Each level has a specific control range of the intensity.

Based on the stored data models, the intensities are dynamically adjusted while driving. It is not necessary to manually change the desired intensity to lower or higher levels while driving.

The individually selected settings of the climate control functions are stored and automatically set up again such as after the vehicle is started again.

Display

The indicator on the menu bar provides information about the temperature difference between the configured desired temperature and current interior temperature.

- ▶ The red or blue bar next to the temperature display indicates the progress of heating or cooling.
- ▶ The desired interior temperature is reached as soon as the bar is no longer displayed.

Active climate control functions, e.g., seat heating, are indicated by the icons on the menu bar.

Temperature

Principle

The automatic climate control cools or heats to the configured temperature and then keeps the temperature constant.

General information

Do not rapidly switch between different temperature settings. Otherwise, the automatic climate control will not have sufficient time to adjust the set temperature.

Setting the temperature



You can set the desired temperature for driver and front passenger individually on the menu bar.

- ▷ + Raise the temperature.
- ▷ - Lower the temperature.

Setting the rear automatic climate control temperature

Via iDrive

1.  Tap the icon for the Climate menu on the menu bar.
2. "Individual settings"
3. "Second row of seats"
4. Set the desired temperature.

Using the button

-  Press the upper or lower button side to set the desired temperature.

Upper body temperature

General information

The air temperature in the upper body area can be adjusted.

This does not change the set interior temperature for the driver and front passenger.

Adjusting the upper body temperature

1.  Tap the icon for the Climate menu on the menu bar.
2. "Individual settings"
3. "Driver" or "Front passenger"
4. "Temp. adjustment upper body"
5. Increase or decrease temperature.

Air flow



Principle

The air flow generated by the blower can be adjusted as needed.

The air flow may be reduced to preserve the vehicle battery.

Adjusting the air flow

The air flow can be set via iDrive.

1.  Tap the icon for the Climate menu on the menu bar.
2.  Select the desired setting.

Automatic program:

- ▷ Tap the large air flow icon to increase the air flow.
- ▷ Tap the small air flow icon to reduce the air flow.

Manual mode:

- ▷ Tap up arrow: Increase air flow.
- ▷ Tap down arrow: Reduce air flow.

Adjusting the air volume of the rear climate control

Via iDrive



1. Tap the icon for the Climate menu on the menu bar.
2. "Individual settings"
3. "Second row of seats"
4. "Fan"
5. Select the desired setting.

Using the button



Pressing the upper or lower side of the button repeatedly: decrease or increase air flow.

The selected air flow is shown on the rear climate control display.

Air distribution settings

Principle

In manual mode, the air distribution can be adjusted as needed.

Adjusting the air distribution

The air distribution can be set via iDrive:



1. Tap the icon for the Climate menu on the menu bar.
2.  Tap the air distribution icon on the climate control functions bar.
3. Select the desired setting:
 - ▶ Aim the air flow downward, arrow 1.
 - ▶ Aim the air flow upward, arrow 2.
 - ▶ Aim the air flow at the windshield, arrow 3.

The selected air distribution is displayed.

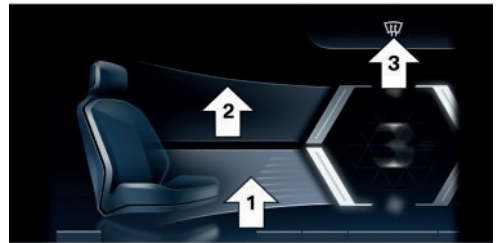

Adjusting the air distribution of the rear climate control



Pressing the upper or lower side of the button. Select the desired setting.

The selected air distribution is shown on the rear climate control display.

Air conditioning

Principle

With the climate control function, the air inside the vehicle is cooled and dehumidified, then warmed again depending on the temperature settings.

Functional requirement

Standby or drive-ready state is turned on.

Switching the cooling function on/off

The air conditioning can be switched on or off via iDrive:



1. Tap the icon for the Climate menu on the menu bar.



2. Tap the air conditioning button.

In recirculated-air mode, air conditioning is automatically switched on to dry the air and avoid window condensation.

Depending on the weather, the windshield and the side windows may fog up briefly when drive-ready state is switched on.

When using the cooling mode, condensation that will exit below the vehicle.

Maximum cooling

Principle

Maximum cooling lets you cool the vehicle interior quickly and effectively.

The lowest temperature and the maximum air flow are set automatically.

The function is automatically activated in the rear when the SYNC program is turned on.

Functional requirement

The following functional requirements must be met for maximum cooling:

- ▶ The outside temperature is higher than approx. 32°F / 0°C.
- ▶ Drive-ready state is switched on.

Turning maximum cooling on/off

Maximum cooling can be turned on or off via iDrive:

1.  Tap the icon for the Climate menu on the menu bar.

2.  Tap the maximum cooling button.

Air flows out of the air vents to the upper body area. Open the vents.

Rear automatic climate control:

-  Press the button.
The button LED illuminates when maximum cooling is turned on.

Air recirculation mode

Principle

You may react to unpleasant odors or pollutants in the immediate environment by temporarily suspending the supply of outside air. The system then recirculates the interior air.

In automatic recirculated-air control mode, outside air is fed in or the interior air recirculated depending on the outside air quality.

When the air recirculation is turned off, outside air is directed into the interior.

General information

If there is window condensation, turn off the air recirculation.

The interior filter cleans the incoming fresh air or the circulated interior air in recirculation mode.

Turning air recirculation on/off

Air recirculation mode can be switched on or off via iDrive:

1.  Tap the icon for the Climate menu on the menu bar.
2. The current operating mode is displayed on the climate control functions bar. Tap the button until the desired operating mode is set.

- ▶  Recirculating air.

- ▶  Fresh air.

- ▶  Automatic recirculated-air control.

In recirculated-air mode, the air conditioning turns on automatically to dry the air and prevent condensation.

Depending on vehicle equipment, the air recirculation turns off automatically after some time based on the ambient conditions in order to prevent condensation.

SYNC program

Principle

If SYNC program is activated, the settings on the driver's side are transferred to the passenger's side and to the rear.

If the SYNC program is deactivated, the following settings are made automatically in the automatic program depending on the seat occupancy:

- ▶ If the front passenger's seat is not occupied, the settings on the driver's side are applied.
- ▶ If the seats in the rear are unoccupied, the default settings are applied.



General information

The following settings can be transferred:

- ▶ Temperature.
- ▶ Air flow.
- ▶ Air distribution.
- ▶ Automatic program.

Turning the SYNC program on/off

The SYNC program can be switched on or off via iDrive:

1.  Tap the icon for the Climate menu on the menu bar.
2.  Tap the SYNC program button.

If the settings on the front passenger side or in the rear are changed, the program is automatically switched off.

Defrost function

Principle

With the defrost function, ice and condensation are quickly removed from the windshield and the front side windows.

The air flow and air temperature are automatically optimized for the removal of ice and condensation.

The air distribution is directed toward the windshield and front side windows.

If there is window condensation, turn on the automatic program to take advantage of the condensation sensor.

When the defrost function is turned on, the rear automatic climate control is deactivated to provide maximum performance.

Turning the defrost function on/off



Press the defrost button on the instrument panel.

The LED of the button is illuminated when the system is switched on.

Make sure that air is able to flow to the windshield and front side windows.

Rear window defroster

Principle

With the rear window defroster, ice and condensation are quickly removed from the rear window.

Functional requirement

Standby or drive-ready state is turned on.

Turning the rear window defroster on/off



Press the rear window heating button on the instrument panel.

The LED in the button illuminates when the rear window heating is turned on.

The rear window defroster switches off automatically after a certain period of time.

Seat and armrest heating

Principle

The system heats seats and armrests as needed.

General information

Seat heating can also be used without armrest heating. Deactivate the armrest heating as needed.

If the trip is continued within approx. 15 minutes after an intermediate stop, the functions are turned on automatically with the temperature that was last set.

Adjusting seat heating

Automatic program

When the automatic program is activated, the intensity of seat heating can be adjusted: As you drive, the heater output is automatically adjusted according to your set intensity.

Adjusting seat heating manually

The heater output level can be adjusted manually:

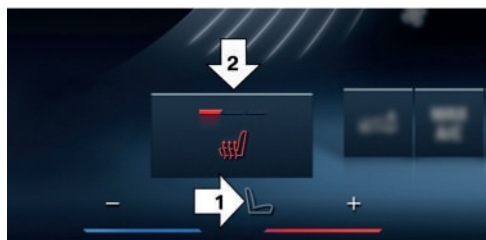

1. Tap the icon for seat climate control on the menu bar, arrow 1.



2. Press the seat heating button repeatedly until the desired level is selected, arrow 2.

If a consumption-optimized drive mode is selected, the heater output is reduced.

Turning the armrest heating on/off



1. Tap the icon for the Climate menu on the menu bar.
2. "Individual settings"
3. Select desired seat.
4. "Heat armrests and seat"

Turning the rear automatic climate control seat heating on/off



Press the button once for each temperature level.

The maximum temperature is reached when three LEDs are illuminated.

Active seat ventilation

Principle

The system cools the seat and backrest surfaces as necessary, ensuring a pleasant seat temperature.

Adjusting active seat ventilation

Automatic program

When the AUTO program is on, the intensity of seat ventilation can be adjusted. As you drive, the ventilation is automatically adjusted according to the set intensity.

Adjusting the active seat ventilation manually

The ventilation level can be adjusted manually:



1. Tap the seat climate control icon on the menu bar, arrow 1.
2.  Press the seat ventilation button repeatedly until the desired level is selected, arrow 2.

Steering wheel heating

Principle

The system heats the steering wheel as necessary.

Adjusting steering wheel heating

Automatic program

When the automatic program is activated, the intensity of steering wheel heating can be adjusted. As you drive, the heater output is automatically adjusted according to your set intensity.

Adjusting steering wheel heating manually

The heater output level can be adjusted manually:



1. Tap the icon for seat climate control on the menu bar, arrow 1.
2.  Press the steering wheel heating button repeatedly until the desired level is selected, arrow 2.

If a consumption-optimized drive mode is selected, the heater output is reduced.

Ventilation

Principle

The ventilation system offers individual adjustment ranges for direct/indirect ventilation in order to optimize the flow of air within the vehicle.

General information

Open the air vents and position them to ensure effective air conditioning.

The air flow heats or cools noticeably, depending on the set desired temperature.

Front ventilation



Setting the air flow direction and air volume at the vent.

- ▶ Changing the air flow direction: press the button in the desired air flow direction.
- ▶ Changing the air volume:
 - ▶ Turn the knob clockwise: increase the air volume.
 - ▶ Turn the knob counterclockwise to decrease the air volume.

Ventilation in the rear

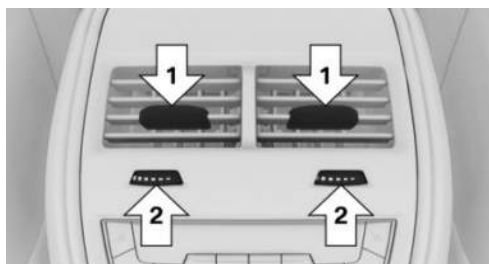

- ▶ Lever for changing the airflow direction, arrows 1.
- ▶ Knurled wheel for variable opening and closing of the air vents, arrows 2.

Ventilation in the rear, on the side

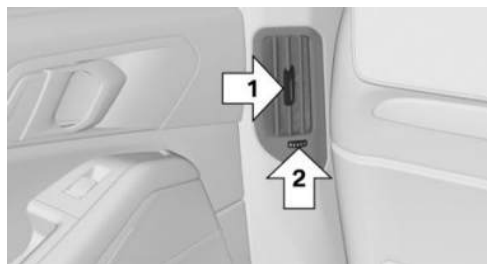

- ▶ Lever for changing the airflow direction, arrow 1.
- ▶ Knurled wheel for variable opening and closing of the air vents, arrow 2.

Setting the ventilation

Depending on the desired ventilation, align the air flow directly or indirectly toward the passengers.

Ventilation, third row of seats

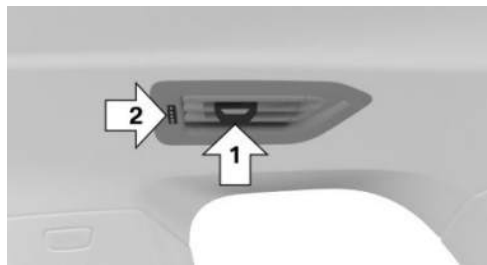

- ▶ Lever for changing the airflow direction, arrow 1.
- ▶ Knurled wheel for variable opening and closing of the air vents, arrow 2.

Air quality

General information

The air quality in the interior is improved by the following components:

- ▷ Emission tested passenger compartment.
- ▷ Interior filter.
- ▷ Air conditioning system to control the temperature, air flow and recirculated-air mode.
- ▷ Pre-ventilation.
- ▷ Ionizer.
- ▷ Fragrancing.

Interior filter

The interior filter cleans the incoming fresh air or the circulated interior air in recirculation mode.

Depending on the equipment:

- ▷ Dust and pollen is filtered out from the in-flowing air.
- ▷ Nano-particle emissions are reduced.
- ▷ Gaseous pollutants are filtered.
- ▷ Microbial particles, viruses and allergens are filtered.

The manufacturer of the vehicle recommends having the interior filter changed during vehicle maintenance.

Ambient air package

Principle

The Ambient Air Package cleans and scents the interior air with selected fragrances.

General information

Two different fragrances can be selected in the vehicle. A variety of other fragrances is possible by exchanging the fragrance cartridges.

The following criteria can influence the perception of scents in the vehicle interior:

- ▷ Automatic climate control settings.
- ▷ Temperature and moisture.

- ▷ Time of day and season.
- ▷ Physical condition of the vehicle occupants, for instance fatigue.

BMW recommends the use of genuine BMW fragrance cartridges.

The genuine BMW fragrance cartridges are not suitable for refilling. When a cartridge is empty, replace it with a new fragrance cartridge.

Safety information

Warning

Refilled genuine BMW fragrance cartridges can cause the emission of harmful substances, malfunctions, and damage to the system. There is a risk of injury or risk of damage to property. Do not refill genuine fragrance cartridges. When a cartridge is empty, replace it with a new fragrance cartridge.

Ionizer

Principle

The ionizer cleans the car's interior air of suspended particles and improves the air quality.

Switching the ionizer on/off



1.  Tap the icon for the Climate menu on the menu bar.
2. "General settings"
3. "Air quality"
4. "Ionization"

Fragrancing

General information

Fragrancing is done at intervals in order to avoid a habituation effect.

Two fragrance cartridges in the vehicle allow switching between the fragrances.

The fragrance cartridges are located in the glove compartment.

To ensure a pleasant fragrance inside of the vehicle when starting the trip, fragrancing can occur prior to the trip. The system is automatically switched on with the pre-ventilation if fragrancing was switched on at the completion of the last trip.

Functional requirements

- ▶ The fragrance cartridges are sufficiently filled.
- ▶ The interior temperature is between 41 °F/+5 °C and 104 °F/+40 °C.
- ▶ Open the air vents to allow the fragrance to flow out.

Selecting the fragrance

The car's interior is fragranced depending on the selected fragrance.

Two different fragrances can be selected in the vehicle.

1.  Tap the icon for the Climate menu on the menu bar.
2. "General settings"
3. "Air quality"
4. "Fragrance"
5. Select the desired fragrance.

Switching fragrancing on/off, adjusting intensity

1.  Tap the icon for the Climate menu on the menu bar.
2. "General settings"
3. "Air quality"
4. "Fragrance"
5. "Intensity"
6. Select the desired setting.

Display

The illustrations on the control display show the actual fill level of the fragrance cartridges.

1.  Tap the icon for the Climate menu on the menu bar.
2. "General settings"
3. "Air quality"

When an empty fragrance cartridge is indicated, the cartridge still contains a fluid carrying the fragrance. However, it is not sufficient for fragrancing.

When the fragrance cartridges are empty, a Check Control message is displayed once.

Inserting fragrance cartridges

The fragrance cartridges are located in the glove compartment.

1. Open the glove compartment.
Front passenger side glove compartment, refer to page 312.
2. Press on the bottom of the cartridge holder.
The cartridge holder slides down.

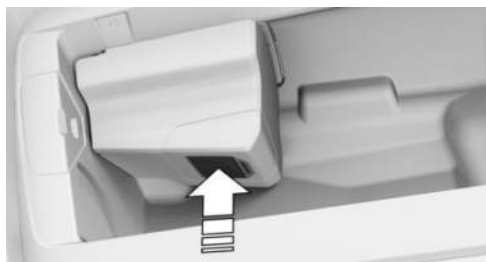

- Remove the cover of the new fragrance cartridge. Hold the cover on the top to slide it from the fragrance cartridge.



- Insert the removed cover on the rear of the fragrance cartridge.

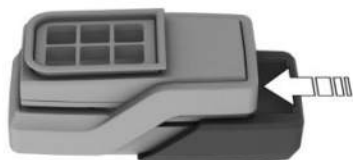

- Position fragrance cartridge such that the chip faces away from the cartridge holder.

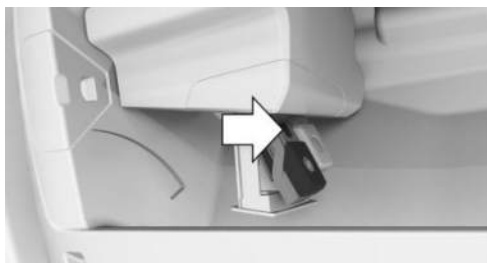

- Slide the fragrance cartridge into the cartridge holder at a slight angle without applying pressure. The fragrance cartridge

is correctly positioned when the cartridge holder can be closed.

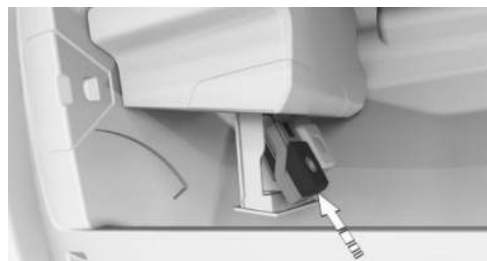

- Push the cartridge holder up, until it engages.
Make sure that no objects press against the cartridge holder from below, otherwise the function of the ambient air package could be impacted.
- Close the glove compartment.

Removing fragrance cartridges

The fragrance cartridges are located in the glove compartment.

- Open the glove compartment.
Front passenger side glove compartment, refer to page [312](#).
- Press on the bottom of the cartridge holder.
The cartridge holder slides down.

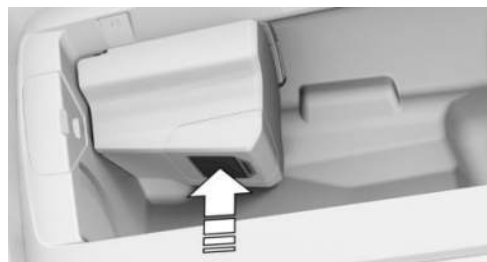

- Pull desired fragrance cartridge from the holder.
Fragrance cartridge, arrow 1: first fragrance indicated on the control display.

Fragrance cartridge, arrow 2: second fragrance indicated on the control display.

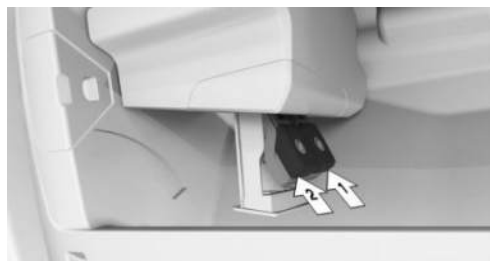

4. Pull desired fragrance cartridge from the holder.

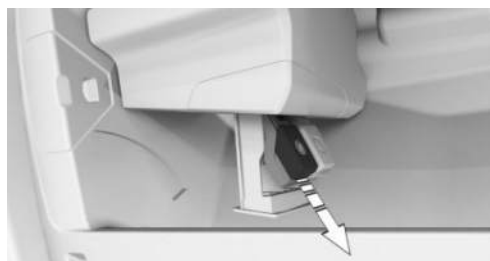

Recycling



Empty fragrance cartridges can be taken to an authorized service center or another qualified service center or repair shop for recycling.

Pre-ventilation

Principle

The car's interior can be cooled or heated before driving off with the pre-ventilation. Depending on set temperature and ambient temperature, the car's interior is ventilated or possibly heated using the residual engine heat.

General information

The system can be switched on and off directly or via a preset departure time.

The activation time is determined based on the outside temperature. The system promptly switches on before the selected departure time.

The system switches off automatically after a certain period of time. The system continues to run for some time after being switched off.

Functional requirements

- ▶ The vehicle is in idle state or standby state.
- ▶ The vehicle battery is sufficiently charged.

If pre-ventilation is switched on, the vehicle battery will be discharged. Thus, limit the maximum activation time to save the vehicle battery. The system will be available again after the engine is started or after a short trip.
- ▶ Time and date are set correctly.
- ▶ The ventilation air vents are open.

Switching pre-ventilation on/off



1. Tap the icon for the Climate menu on the menu bar.
2. "General settings"
3. "Pre-ventilation"
4. Select the desired setting.

Departure time

General information

Different departure times can be set to ensure a comfortable interior temperature in the vehicle at the time of departure.

- ▶ One-time departure time: the time can be set.

The system is switched on once.
- ▶ Departure time with weekday: time and day of the week can be set.

On the desired weekdays, the system will be switched on before the set departure time.

The departure time is preselected in two steps:

- ▶ Set departure times.
- ▶ Activate departure times.

A minimum of 10 minutes should pass between setting and activating the departure time and the planned departure time to allow a sufficient period of time for the air conditioning.

Setting the departure time



1. Tap the icon for the Climate menu on the menu bar.
2. "General settings"
3. "Pre-ventilation"
4. "Departure plan"
5. Select the desired departure time.
6. Set the desired departure time.
7. Select day of the week, if needed.

Activating the departure time



1. Tap the icon for the Climate menu on the menu bar.
2. "General settings"
3. "Pre-ventilation"
4. "Departure plan"
5. Activate the desired departure time.

Display on the instrument cluster

Icon	Description
	Icon illuminates: a departure time is activated. Icon flashes: pre-ventilation is switched on.

Activating with My BMW App

Depending on vehicle equipment, the My BMW App with remote functionality can be used to turn on precooling at a preset departure time or immediately.

Pre-conditioning through Remote Engine Start

Principle

Pre-conditioning cools or heats the car's interior prior to start of the trip to a comfortable temperature. The system automatically cools, vents, and heats depending on the interior, external, and set temperature. Snow and ice may be removed more easily.

The system starts the engine automatically and allows it to run for a limited period of time.

Safety information

DANGER

If the exhaust pipe is blocked or ventilation is insufficient, harmful exhaust gases can pollute the area in and around the vehicle or penetrate the vehicle. The exhaust gases contain pollutants which are colorless and odorless. In enclosed areas or areas with insufficient ventilation, exhaust gases can also accumulate outside of the vehicle. There is a danger to life. Keep the exhaust pipe free and ensure sufficient ventilation. Do not switch on pre-conditioning in enclosed areas or areas with insufficient ventilation, e.g. in enclosed garages.

Warning

When stationary climate control is in operation, high temperatures can occur underneath the body, for instance caused by the exhaust system. If combustible materials such as



leaves or grass come in contact with hot parts of the exhaust system, these materials can ignite. There is a risk of fire. Make sure that no combustible materials can come in contact with hot vehicle parts during stationary climate control operation, e.g. leaves, grass, gas, gasoline, oil or other combustible objects.

Functional requirements

- ▷ The vehicle is in idle state or standby state.
- ▷ Battery is sufficiently charged.
- ▷ The fuel tank capacity is sufficient.
- ▷ Hood is closed.
- ▷ Make sure that the vehicle's date and time are set correctly.
- ▷ Air vents are opened.

Enabling the automatic engine start function

The automatic engine start must be enabled before using the system. Otherwise, the engine cannot switch on automatically to climatize the car's interior.



1. Tap the icon for the Climate menu on the menu bar.
2. "General settings"
3. "Pre-conditioning"
4. "Remote Engine Start"
5. "Start engine for climate cont."
6. Confirm the disclaimer.

Turning on/turning off the pre-conditioning

General information

The system switches off automatically after max. 15 minutes for safety reasons.

The system can be switched on a maximum of two times in a row.

The system will be available again as soon as the drive-ready state is activated and deactivated again.

Switching on via iDrive



1. Tap the icon for the Climate menu on the menu bar.
2. "General settings"
3. "Pre-conditioning"
4. "Start now"

Switching on/off via vehicle key

The system can be switched on and off using the vehicle key.



Press the button on the vehicle key three times within 1 second.

After operating the vehicle key, it takes approx. 3 seconds for the engine to switch on.

To switch off the system, press the button again three times.

Turning off with the Start/Stop button

This system can be turned off directly by pushing the Start/Stop button without depressing the brake pedal.

Air conditioning for departure time

General information

Scheduled departure times can be set up in the system to ensure a comfortable interior temperature in the vehicle at the time of departure.

- ▷ One-time departure time: the time of the scheduled departure can be set.

The system is switched on once.

- ▶ Departure time with weekday: time and day of the week of the scheduled departure can be set.

The departure time is preselected in two steps:

- ▶ Set departure times.
- ▶ Activate departure times.

The system is activated automatically a few minutes before the set departure time. The system remains switched on for a short time after the set departure time.

For safety reasons, the air conditioning can only be activated once for the departure time.

The system will be available again as soon as the drive-ready state is activated and deactivated again.

Observe the information about the intended use of the vehicle.

Additional information:

For Your Own Safety, refer to page 8.

Setting the departure time



1. Tap the icon for the Climate menu on the menu bar.
2. "General settings"
3. "Pre-conditioning"
4. "Departure plan"
5. Set the departure time.
6. Select day of the week, if needed.

Activating the departure time



1. Tap the icon for the Climate menu on the menu bar.
2. "General settings"
3. "Pre-conditioning"
4. "Departure plan"
5. Activate the desired departure time.

Display

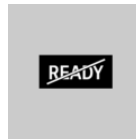

In the instrument cluster:

The engine runs for the purpose of operating the pre-conditioning. The vehicle is not ready to drive.

Icon	Description
	Icon on the instrument panel. Icon illuminates: a departure time is activated. Icon flashes: pre-conditioning is switched on.

Confirmation signals from the vehicle

The activation of the system is confirmed by flashing twice.

The parking lights are switched on as long as the system is switched on.

Interior equipment

Vehicle features and options

This chapter describes model-specific equipment, systems, and functions that are currently available, or may become available in the future, even if they are not present in the vehicle.

Additional information:

Vehicle equipment, refer to page 8.

Integrated universal remote control

Principle

The integrated universal remote control in the interior mirror can operate remote-controlled systems such as garage door openers, alarm systems or locking systems.

General information

The integrated universal remote control replaces up to three different hand-held transmitters. To operate the remote control, the buttons on the interior mirror must be programmed with the desired functions.

Before selling the vehicle, delete the stored functions for the sake of security.

If possible, do not install the antenna of the remote-controlled system near metal objects to ensure the best possible operation.

Safety information

Warning

The operation of remote-controlled systems with the integrated universal remote control such as the garage door may result in injury, for example, body parts becoming jammed in a garage door. There is a risk of injury or risk

of damage to property. Make sure that the travel path of the respective system is clear during programming and operation. Also follow the safety information for the hand-held transmitter.

Compatibility



If this icon is printed on the packaging or in the operating instructions of the remote-controlled system, the system is generally compatible with the integrated universal remote control.

Additional questions are answered by:

- ▶ An authorized service center or another qualified service center or repair shop.
- ▶ www.homelink.com on the Internet.

HomeLink is a registered trademark of Gentex Corporation.

For any additional questions, contact an authorized service center or another qualified service center or repair shop.

Operating elements on the interior mirror



- ▶ Buttons, arrow 1.
- ▶ LED, arrow 2.
- ▶ Hand-held transmitter of the remote-controlled system, arrow 3.

Programming the integrated universal remote control

Functional requirement

The battery of the hand-held transmitter must be fully charged at the time of programming to ensure an optimal range of the integrated universal remote control.

Programming individual buttons

1. Park the vehicle within range of the remote-controlled system.
2. Turn on standby state.
3. Select desired button on the interior mirror:
 - ▶ Program available button:
Press the button.
 - ▶ Program already assigned button:
Press and hold the button for approx. 20 seconds.

The LED on the interior mirror will slowly begin flashing orange.

4. Hold the hand-held transmitter for the remote-controlled system approx. 1 to 12 in/2.5 to 30 cm away from the buttons on the interior mirror.
The required distance depends on the hand-held transmitter.
5. Press and hold the button on the hand-held transmitter.
Canada: if programming with the hand-held transmitter was interrupted, hold down the interior mirror button and repeatedly press and release the hand-held transmitter button for 2 seconds.
6. The LED can illuminate in different ways:
 - ▶ The LED illuminates green: programming completed.
Release button.
 - ▶ The LED flashes green rapidly: the hand-held transmitter was detected but programming is not complete.

Press and hold the button on the interior mirror for approx. 2 seconds. Perform this procedure three times.

If the integrated universal remote control remains nonoperational, continue with the special features for rolling code radio systems.

- ▶ LED does not illuminate green after 60 seconds: programming not completed.
Repeat steps 3 to 5.

Special feature of the rolling code wireless system

For systems with a rolling code radio system, the integrated universal remote control and the system also have to be synchronized.

Refer to information on synchronization in the operating instructions of the remote-controlled system.

1. Program the desired button on the interior mirror.
2. Locate and press the synchronizing button on the remote-controlled system such as on the garage door.

You have approx. 30 seconds for the next step.

Synchronizing is easier with the aid of a second person.

3. Press and hold the programmed button on the interior mirror for approx. 3 seconds.
If necessary, repeat this step up to three times in order to end synchronization. Once synchronization is complete, the programmed function will be carried out.

Operation

After programming, the remote-controlled system can be operated with the button on the interior mirror.

Press and hold the desired button of the remote-controlled system within range until the function is triggered.

The LED on the interior mirror is continuously illuminated green during the transmission of the radio signal.

Deleting a button assignment

The button assignment cannot be deleted individually.

Press and hold the two outer buttons on the interior mirror simultaneously for approximately 10 seconds until the LED flashes green rapidly.

All stored button assignments will be deleted.

Sun visor

Glare shield

Fold the sun visor down or up.

Glare shield from the side

Folding the sun visor out

1. Fold the sun visor down.
2. Detach it from the holder and swing it toward the side window.
3. Shift it back to the desired position.

Folding the sun visor in

Proceed in the reverse order to close the sun visor.

Vanity mirror

A vanity mirror is located in the sun visor behind a cover.

Sockets

Principle

The socket can be used for electronic devices when the standby or drive-ready state is switched on.

General information

The total load of all sockets must not exceed 140 watts at 12 volts.

Do not damage the socket by using unsuitable connectors.

Safety information

Warning

Devices and cables in the unfolding area of the airbags such as portable navigation devices can hinder the unfolding of the airbag or be thrown around in the car's interior while unfolding. There is a risk of injury and risk of property damage. Make sure that devices and cables are not in the airbag's area of unfolding.

Warning

Battery chargers that charge the vehicle battery via sockets or cigarette lighters in the vehicle may overload or damage the 12 V electrical system. There is a risk of injury or risk of damage to property. Only connect battery chargers for the vehicle battery to the jump-start terminals in the engine compartment.

Warning

If metal objects fall or are plugged into electronic interfaces, e.g., sockets or USB ports, these objects can cause a short circuit and destroy the interface. There is a risk of injury and risk of property damage. Make sure to

prevent metal objects from falling or being plugged into electronic interfaces. Insert the cigarette lighter or socket cover again after using the socket.

Front center console



Press on the cover.



A socket is located between the cup holders in one of the marked positions. Detach the cover.

Rear center console

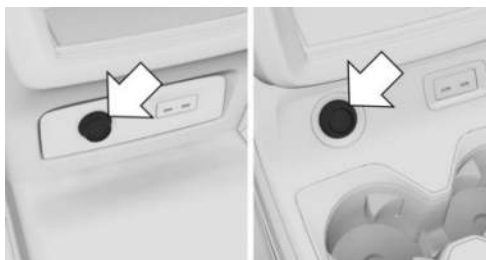

A socket is located in the center console at one of the marked positions.

Detach the cover.

In the cargo area

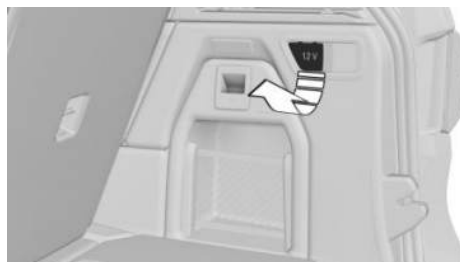

A socket is located on the right side in the cargo area. Unfold the cover.

USB port

General information

Follow the information regarding the connection of mobile devices to the USB port in the section on USB connections.

Additional information:

USB connection, see Owner's Manual for Navigation, Entertainment, Communication;

Safety information

Warning

If metal objects fall or are plugged into electronic interfaces, e.g., sockets or USB ports, these objects can cause a short circuit and destroy the interface. There is a risk of injury and risk of property damage. Make sure to prevent metal objects from falling or being plugged into electronic interfaces. Insert the cigarette lighter or socket cover again after using the socket.

In the center armrest



A USB port is located in the center armrest.

Properties:

- ▷ USB port Type C.
- ▷ For charging mobile devices.
- ▷ Charge current: max. 3 A.

In the center console

NOTICE

Objects in the storage compartment, e.g., large USB connectors, may block or damage the cover when it is being opened or closed. There is a risk of property damage. Make sure that the area of movement of the cover is clear while opening and closing it.



Press on the cover.



A USB port is located in the center console at one of the marked positions.

Properties:

- ▷ USB port Type A.
- ▷ For charging mobile devices and for data transfer.
- ▷ Charge current: max. 1.5 A.

Second row of seats

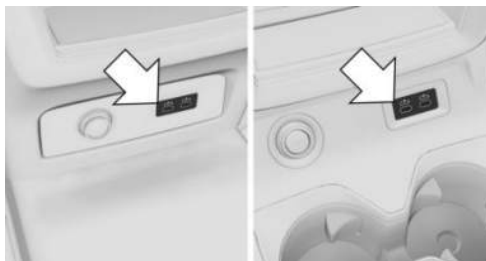

Two USB ports are located in the center console in the rear at one of the marked positions.

Properties:

- ▷ USB port Type C.
- ▷ For charging mobile devices.
- ▷ Charge current: max. 3 A.

Third row of seats



One USB port each is located in the side trim panel in the rear. Unfold the cover.

Properties:

- ▶ USB port Type C.
- ▶ For charging mobile devices.
- ▶ Charge current: max. 3 A.

Travel & Comfort system

General information

The front seat backrests have mounts and various connection options:

- ▶ Mounts for attaching optional accessories, e.g., universal holders for tablets or coat hangers.
- ▶ USB ports.

Properties of the USB ports:

- ▶ USB port Type C.
- ▶ For charging mobile devices.
- ▶ Charge current: maximum 3 A / 45 W per seat.

For more information, contact an authorized service center or another qualified service center or repair shop.

Overview



The mounts for attaching optional accessories are located behind the marked covers, as are the USB ports.

Attaching optional accessories

1. Slide the cover all the way to the side.

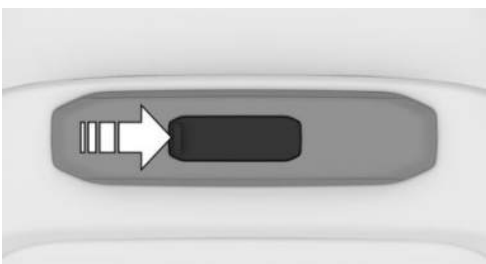

2. Mount the optional accessories, refer to Assembly Instructions.

Wireless charging tray

Principle

The wireless charging tray is used to wirelessly charge Qi-certified smartphones.

General information

When inserting the smartphone to be charged, make sure that there is nothing between the smartphone to be charged and the wireless charging tray.

 The charging process is shown by the charge indicator on the control display.

Safety information

Warning

When charging a Qi-compatible device in the wireless charging tray, any metal objects on the tray together with the device can become very hot. Storage media or electronic cards, e.g., chip cards, cards with magnetic strips, or cards for transmitting signals, may not function correctly when placed together on the tray with the device. There is a risk of injury and risk of property damage. When charging mobile devices, make sure there are no objects on the tray together with the device.

Overview

Tray across in the center console:

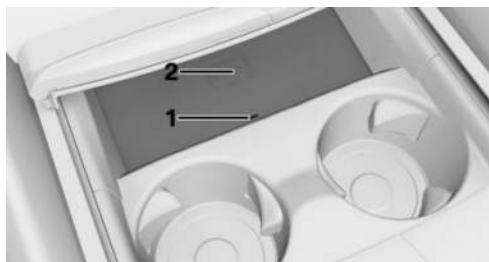

- 1 LED
- 2 Storage area

Tray on the left in the center console:

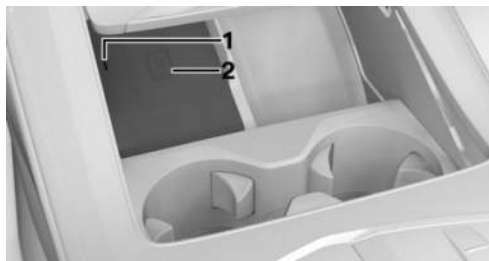

- 1 LED
- 2 Storage area

Functional requirements

- ▷ The smartphone to be charged must be Qi-certified.
- ▷ Standby state is switched on.
- ▷ Smartphone must not exceed maximum dimensions of approx. 6.0 x 3.1 x 0.7 in/154.5 x 80 x 18 mm.
- ▷ Protective sleeves and covers must be suitable for wireless charging.
- ▷ The smartphone to be charged is located in the center of the tray. The smartphone display is facing up.

Inserting a smartphone

1. Open the tray cover.
2. Place the smartphone in the middle of the tray, with the display facing up.
3. Close the tray cover.

LED displays

Color	Meaning
Blue	Smartphone is charging. The blue LED continues to illuminate when the Qi-capable smartphone is fully charged.
Orange	Smartphone is not charging. Temperature on the smartphone may be too high, or foreign object may be in charging tray.
Red	Smartphone is not charging. Contact an authorized service center or another qualified service center or repair shop.



Forgotten warning

General information

A warning may be issued if a Qi-certified smartphone was forgotten in the wireless charging tray when leaving the vehicle.

The forgotten warning is displayed in the instrument cluster.

Enable/Disable Forgotten Warning

1. Apps menu
2. "Vehicle"
3. "System settings"
4. "Wireless charging tray"
5. "Mobile phone reminder"

System limits

The charge current may be reduced or charging may be temporarily interrupted in the wireless charging tray in the following situations:

- ▷ Due to excessive temperatures on the tray and smartphone.
- ▷ If there are objects between the smartphone and wireless charging tray.
- ▷ If storage media or electronic cards, e.g., chip cards, cards with magnetic stripes, or cards for signal transmission, are located between the smartphone and wireless charging tray.
- ▷ Due to protective sleeves and covers that exceed a thickness of 0.07 in/2 mm
- ▷ Due to protective sleeves and covers made of unsuitable material, e.g., with magnetic parts.
- ▷ Due to add-on parts for the smartphone, e.g., holders.
- ▷ By configuring the smartphone settings, e.g., for charging. Follow the instructions given on the control display and smartphone, as applicable.

Storage compartments

Vehicle features and options

This chapter describes model-specific equipment, systems, and functions that are currently available, or may become available in the future, even if they are not present in the vehicle.

Additional information:

Vehicle equipment, refer to page 8.

Safety information

Warning

When driving, loose items or devices connected to the vehicle with a cable, i.e., mobile phones, may be thrown around the vehicle, e.g., in the event of an accident or when braking or performing evasive maneuvers. There is a risk of injury and risk of property damage. Secure loose objects or devices that are connected to the vehicle via a cable.

Warning

Open flaps of the storage compartments, e.g., glove compartment or center armrest, protrude into the interior when folded open and may be in the way of an airbag that deploys. In addition, objects in the open storage compartment can be thrown into the vehicle interior during the trip, for instance, in the event of an accident or when braking or making an evasive maneuver. There is a risk of injury. Always close storage compartments immediately after use.

Warning

Anti-slip pads such as anti-slip mats can damage the dashboard. Attached objects could come loose. There is a risk of injury or risk of damage to property. Do not use anti-slip pads.

Glove compartment

Opening the glove compartment



Pull the handle.

Closing the glove compartment

Fold the lid closed.

Locking the glove compartment

The glove compartment can be locked with an integrated key. This prevents access to the glove compartment.

After the glove compartment has been locked, the vehicle key can be given to someone without the integrated key, for example, when the car is being parked by a parking attendant.

Additional information:

Integrated key, refer to page 73.

Fold-out compartment

Opening the fold-out compartment



Press the button and open the cover.

Storage compartments in the doors

General information

There are storage compartments in the doors.

Safety information

Warning

Breakable objects such as glass bottles or glasses can break in the event of an accident, braking or an evasive maneuver. Broken glass can be scattered in the car's interior. There is a risk of injury and risk of property damage. Do not use any breakable objects while driving. Only stow breakable objects in closed storage compartments.

Storage tray in center console

Opening the storage compartment



Press on the cover.

Closing the storage compartment

Pull the cover on the handle back.

Front center armrest

General information

A storage compartment is located in the center armrest between the seats.

Opening the center armrest

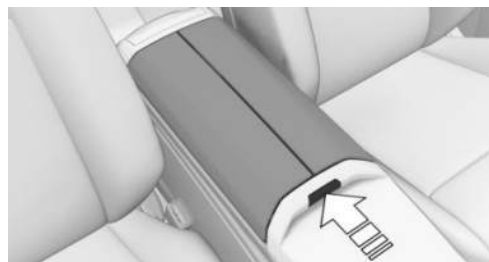

Press the button.

Closing the center armrest

Press both lids down until they engage.

Rear center armrest

General information

A storage compartment is located in the center armrest between the seats.

Folding down the center armrest

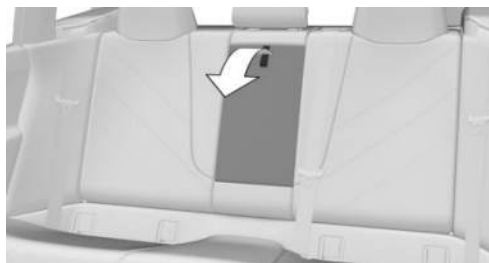

Fold the center armrest forward.

Opening the center armrest

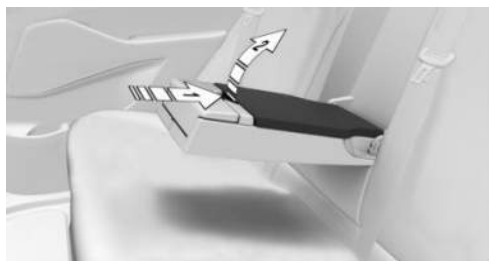

Press the button, arrow 1, and fold the lid up, arrow 2.

Closing the center armrest

Press the lid down until it engages.

Front cup holder

Safety information

Warning

Unsuitable containers in the cup holders may damage the cup holders or be thrown about the car's interior in the event of an accident, an evasive maneuver, or forceful braking. Spilled liquids can distract from the surrounding traffic conditions, lead to an accident and damage vehicle components. Hot drinks can damage the cup holder or lead to scalding. There is a risk of injury or risk of damage to property. Do not force objects into the cup holder. Make sure that drink containers are secured firmly in the cup holder. Use lightweight, shatterproof, and sealable containers. Clean up spilled liquids immediately. Do not transport hot beverages.

Opening the cup holder



Press on the cover.



Two cup holders are located in the center console.

Closing the cup holder

Pull the cover on the handle back.

Maintaining the drink temperature

General information

Depending on vehicle equipment, drinks can be kept cool or warm.

Safety information

Warning

Contact with the hot metal insert of the thermoelectric cooling and heating system for a cup holder can cause burn injuries. There is a risk of injury. Do not touch the metal insert when the thermoelectric cooling and heating system for a cup holder is switched on.

NOTICE

When the thermoelectric cooling and heating system for a cup holder is switched on and the cover is closed, the thermoelectric cooling and heating system for a cup holder can overheat. There is a risk of property damage. Switch the thermoelectric cooling and heating system for a cup holder off before closing the cover.

NOTICE

Temperature sensitive items may be damaged by the hot metal insert of the thermoelectric cooling and heating system for a cup holder. There is a risk of property damage. Use suitable containers only.

Switching on the thermal cup holder



Press the button for keeping cool or warm once each.

- ▷ Blue LED illuminates: keep drinks cool.
- ▷ Red LED illuminates: keep drinks warm.

Switching off the thermoelectric cooling and heating system for a cup holder



Press the button repeatedly until the LEDs turn off.

Rear cup holder

Safety information

Warning

Unsuitable containers in the cup holders may damage the cup holders or be thrown about the car's interior in the event of an accident, an evasive maneuver, or forceful braking. Spilled liquids can distract from the surrounding traffic conditions, lead to an accident and damage vehicle components. Hot drinks can damage the cup holder or lead to scalding. There is a risk of injury or risk of damage to property. Do not force objects into the cup holder. Make sure that drink containers are secured firmly in the cup holder. Use lightweight, shatterproof, and sealable con-

tainers. Clean up spilled liquids immediately. Do not transport hot beverages.

NOTICE

With an open cup holder, the center armrest cannot be folded back up. There is a risk of property damage. Press back the covers before the center armrest is folded up.

Second row of seats

General information

The cup holder can be adjusted for three different container sizes.

Opening the cup holder

1. Fold down the center armrest.
2. Press the button and fold out the cup holder fully.

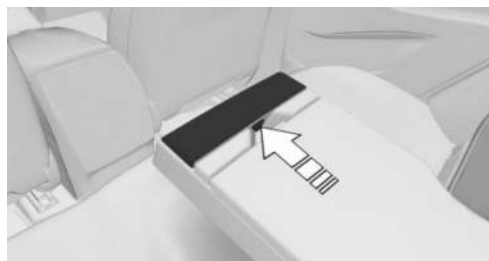

Downsizing the cup holder

To make it smaller, the cup holder can be folded at 2 levels.

Enlarging the cup holder

To make a smaller cup holder bigger, first fold it in completely. Then fold the cup holder out again fully.

Closing the cup holder

Fold in the cup holder fully, until it engages.

With six seats



Two cup holders are located in the center console.

Third row of seats



The cup holders are located in the left and right side trim panels in the rear.

Coat hooks

General information

The coat hooks are located in the grab handles and on the door pillar in the rear.

Safety information

Warning

Clothing articles on the coat hooks can obstruct the view while driving. There is a risk of accident. When suspending clothing articles from the coat hooks, ensure that they will not obstruct the driver's view.

 **Warning**

Improper use of the coat hooks can lead to a risk of objects flying about during braking and evasive maneuvers. There is a risk of injury and risk of property damage. Only hang light-weight objects, for instance clothing articles, from the coat hooks.

Cargo area

Vehicle features and options

This chapter describes model-specific equipment, systems, and functions that are currently available, or may become available in the future, even if they are not present in the vehicle.

Additional information:

Vehicle equipment, refer to page 8.

Loading

Safety information

Warning

High gross vehicle weight can overheat the tires, damage them internally and cause a sudden tire pressure loss. Driving characteristics may be negatively impacted, reducing directional stability, lengthening the braking distances and changing the steering response. There is a risk of accident, injury, and property damage. Pay attention to the permitted load-carrying capacity of the tires and never exceed the permitted gross vehicle weight.

Warning

When driving, loose items or devices connected to the vehicle with a cable, i.e., mobile phones, may be thrown around the vehicle, e.g., in the event of an accident or when braking or performing evasive maneuvers. There is a risk of injury and risk of property damage. Secure loose objects or devices that are connected to the vehicle via a cable.

Warning

Improperly stowed objects can slip and be thrown into the car's interior, for instance in the event of an accident, braking or an evasive maneuver. Vehicle occupants can be hit and injured. There is a risk of injury and risk of property damage. Stow and secure objects and cargo properly.

NOTICE

Fluids in the cargo area can cause damage. There is a risk of property damage. Make sure that no fluids leak in the cargo area.

Steps for determining correct load limit

1. Locate the statement "The combined weight of occupants and cargo should never exceed XXX kg or XXX lbs" on the vehicle's placard.
2. Determine the combined weight of the driver and passengers that will be riding in the vehicle.
3. Subtract the combined weight of the driver and passengers from XXX kg or XXX lbs.
4. The resulting figure equals the available amount of cargo and luggage load capacity. For example, if the "XXX" amount equals 1,400 lbs and there will be five 150 lbs passengers in the vehicle, the amount of available cargo and luggage load capacity is 650 lbs (1,400 - 750 (5 x 150) = 650 lbs).
5. Determine the combined weight of luggage and cargo being loaded on the vehicle. That weight may not safely exceed the

available cargo and luggage load capacity calculated in Step 4.

6. If the vehicle will be towing a trailer, load from your trailer will be transferred to the vehicle. Consult this manual to determine how this reduces the available cargo and luggage load capacity of the vehicle.

Payload

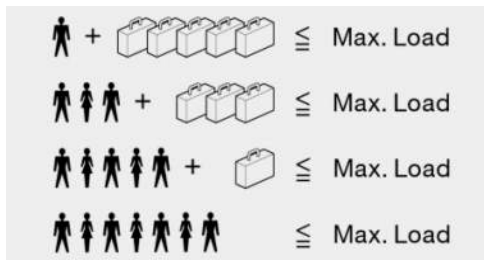

The maximum payload is the sum of the weight of the occupants and the cargo.

The greater the weight of the occupants, the less cargo that can be transported.

Stowing and securing cargo

- ▷ Cover sharp edges and corners on the cargo.
- ▷ Do not stack cargo above the upper edge of the backrests.
- ▷ If necessary, fold down the rear backrests to stow large cargo.
- ▷ Fasten the aids for securing the load to the lashing eyes in the cargo area.
- ▷ Depending on vehicle equipment, use the cargo area partition net to protect occupants. Make sure that objects cannot penetrate the cargo area partition net.
- ▷ Small and light cargo: secure with tensioning straps or tension bands or with a luggage compartment net.
- ▷ Larger and heavy cargo: secure with cargo straps.

- ▷ Heavy cargo: stow as far forward as possible, directly behind and at the bottom of the rear seat backrests.
- ▷ Very heavy cargo: stow as far forward as possible, directly behind and at the bottom of the rear seat backrests. When the rear seat is not occupied, secure each of the outer seat belts in the opposite buckle.

Lashing eyes in the cargo area

General information

Attach auxiliary materials to secure the cargo such as lashing straps, tensioning straps, draw straps, or cargo nets to the lashing eyes.

Overview



The lashing eyes are located in the cargo area. The front lashing eyes are located under covers. Fold down the seats in the third row to use the front lashing eyes.

Net

Smaller objects can be stowed in the net on the left or right side.

Storage compartment on the right side

General information

A storage compartment is available on the right side of the cargo area.

Opening the storage compartment



Unlock the cover of the right side trim panel, arrow 1, and fold open, arrow 2.

Storage compartment on the left side

General information

A storage compartment is located on the left side in the cargo area.

Opening the storage compartment

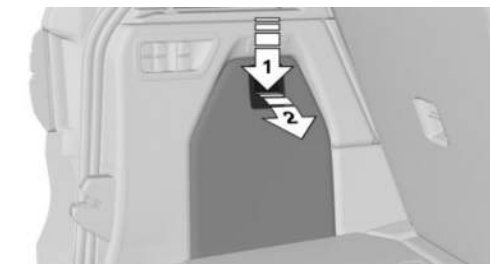

Unlock the cover of the left side trim panel, arrow 1, and fold open, arrow 2.

Cargo floor panel

General information

There are storage compartments beneath the cargo floor panel.

Opening the storage compartment

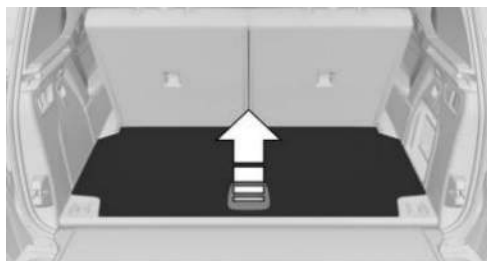

Fold up the cargo floor panel.

Enlarging the cargo area

Principle

The cargo area can be enlarged by folding down the rear seat backrests.

General information

With seven seats:

The rear seat backrest of the second seat row is divided at a ratio of 40–20–40. The side rear seat backrests and the center section can be folded down separately.

With six seats:

The second row of seats consists of two divided seats. The rear seat backrests can be folded down separately.

Depending on the vehicle equipment, the rear seat backrests can be folded down from the rear or from the cargo area.

Safety information

Warning

Vehicle parts can be damaged or body parts jammed when folding down the rear seat backrest. There is a risk of injury or risk of property damage. Make sure that the area of movement of the rear seat backrest including head restraint is clear when folding down.

Warning

If a rear seat backrest is not locked, unsecured cargo can be thrown about the car's interior; for instance, in the event of an accident, braking or an evasive maneuver. There is a risk of injury. Make sure that the rear seat backrest is locked after folding it back.

Warning

The stability of the child restraint system is limited or compromised with incorrect seat setting or improper installation of the child seat. There is a risk of injury or danger to life. Make sure that the child restraint system fits securely against the backrest. If possible, adjust the backrest tilt for all affected backrests and correctly adjust the seats. Make sure that seats and backrests are securely engaged or locked. If possible and necessary, adjust the height of the head restraints or remove them.

Folding down the rear seat backrest

From the rear





Pull the switch and fold the rear seat backrest forward.

From the cargo area



Overview



Switch in the cargo area

Switch	Function
	Fold down the rear seat backrest.
	Maximum comfort.
	Maximum space.

Folding down the rear seat backrest

- ▷  Press the switch. The rear seat backrest automatically moves to the respective end position. Pressing again stops the motion.
- ▷  Push the switch and hold it. The rear seat backrest moves as long as the switch is held down.

Switch	Function
Top, front.	The left and middle rear seat backrests fold forward. In the case of equipment with six seats: The left seat backrest folds forward.
Bottom, front.	The right seat backrest folds forward.
Top, rear.	The left seat backrest in the third row of seats folds forward.
Bottom, rear.	The right seat backrest in the third row of seats folds forward.

Maximum comfort

 Press the switch.

All rear seat backrests move into upright position. The seats of the second seat row are brought into the base position.

Maximum space

 Press the switch.

The rear seat backrests of the second and third seat row are folded down.
In the case of equipment with six seats:
The seats and rear seat backrests of the second seat row move into the rearmost position.

The rear seat backrests of the third seat row are folded down.

Folding back the rear seat backrest

From the rear

Press the corresponding switch. The rear seat backrest sets itself upright.

From the cargo area

Pull the corresponding switch. The rear seat backrest sets itself upright.

Folding down middle section



Fold down the center armrest and pull on the loop.

Cargo cover

Safety information

Warning

When driving, loose items or devices connected to the vehicle with a cable, i.e., mobile phones, may be thrown around the vehicle, e.g., in the event of an accident or when braking or performing evasive maneuvers. There is a risk of injury and risk of property damage. Secure loose objects or devices that are connected to the vehicle via a cable.

Warning

Body parts can become trapped when the folding cargo cover is operated. There is a risk of injury. When operating the folding cargo cover, make sure that the travel path of the cover is clear.

Warning

A cargo cover that snaps back quickly can jam body parts or cause damage. There is a risk of injury or risk of damage to property. Do not let the cargo cover snap back into place.

Warning

An incorrectly inserted cargo cover can be thrown about the car's interior such as in the event of an accident or a braking or evasive maneuver. There is a risk of injury and risk of property damage. Make sure the cargo cover is securely engaged in the brackets.

Roller cover for the luggage compartment behind the second row of seats

Remove from the storage under the cargo area floor

1. Remove side covers.
Side covers, refer to page 320.
2. Fold up the cargo area floor.
3. Raise the roller cover for the luggage compartment slightly.
4. Slide the roller cover for the luggage compartment as far to the right as possible.
5. Raise the left roller cover for the luggage compartment and guide it past the trim panel.

Inserting the roller cover for luggage compartment

1. Fold the rear seat backrest of the third row of seats forward.
Fold the rear seat backrest forward, refer to page 112.
2. If necessary, remove the cargo cover behind the third row of seats.
3. Closing the lower tailgate.
4. Remove covers from brackets.



5. Remove the roller cover for the luggage compartment from the recess under the cargo area floor.
6. Insert the roller cover for the luggage compartment into the brackets from the top, arrows.

Make sure that the roller cover for the luggage compartment is positioned correctly in the brackets and that the clasps click into the locked position.

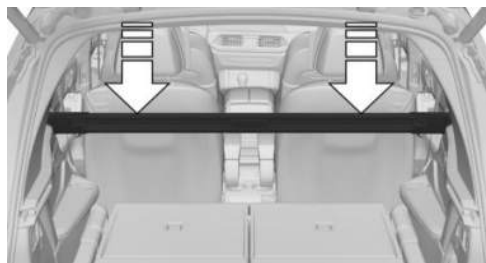

The roller cover for the luggage compartment was inserted correctly when a green color coding is visible on the release buttons. If a green color coding is not visible, proceed as follows:

- ▶ Remove the roller cover for the luggage compartment and insert it again.
- ▶ Push the release button back until the green color coding is visible.

Closing the roller cover for luggage compartment



Pull out the roller cover for the luggage compartment, arrow 1, and hook both sides into the brackets, arrows 2.

Removing the roller cover for luggage compartment

1. Press the release button, arrow 1, on both sides and pull the roller cover for the luggage compartment out to the top, arrow 2.



2. Insert the covers on the brackets.

Stowing the roller cover for luggage compartment

1. Remove side covers.
Side covers, refer to page 320.
2. Fold up the cargo area floor.

3. Stow the roller cover for the luggage compartment as far to the right as possible and lower it on the left side.



4. Close the cargo area floor.
5. Closing the side covers.

Cargo cover behind third seat row

Inserting the cargo cover

1. Remove the cargo cover from the recess under the cargo area floor.
2. Slide the cargo cover forward in the side guides, arrow. Make sure that the cargo cover is positioned correctly in the brackets and that the clasps click into the locked position.

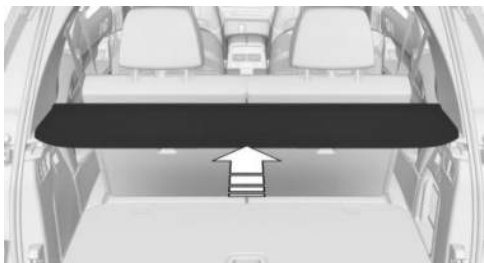

Closing the cargo cover

Fold cargo cover back.

Removing the cargo cover

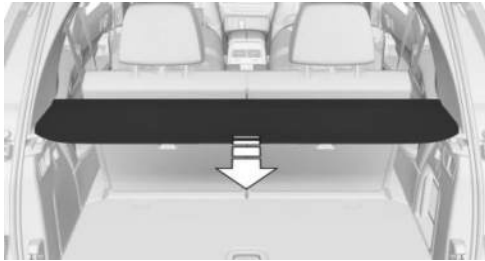

Pull the cargo cover out toward the rear, arrow.

Stowing the cargo cover

1. Remove the side cover on the left or right. Side covers, refer to page [320](#).
2. Fold up the cargo area floor.
3. Fold the rear part of the cargo cover forward.
4. Turn the cargo cover and stow it in the recess.

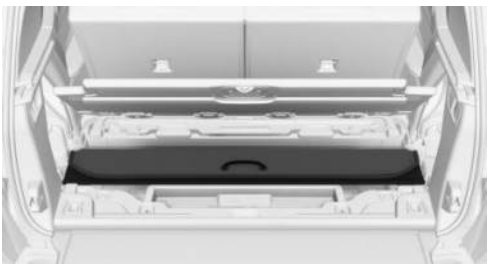

5. Close the cargo area floor completely.
6. Close the side cover.

Cargo area partition net

General information

The cargo area partition net can be installed in two different positions in the vehicle.

With the rear seat backrest folded down

When the rear seat backrest is folded down, install the cargo area partition net behind the front seats.

1. Fold down the rear seat backrests. Enlarging the cargo area, refer to page [320](#).
2. Open the front cover caps up on the roof frame until they engage.



3. Insert each of the two top retaining pins of the cargo area partition net into the receptacles until they reach the stop, arrow 1, and push them forward.

Make sure that the lower hooks with the opening point toward the rear of the vehicle.

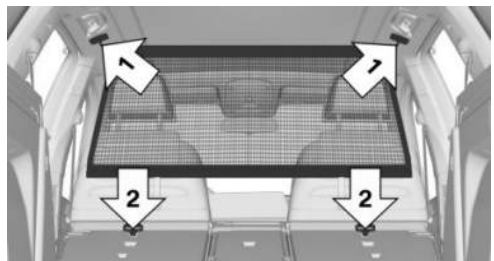

4. Using the two bottom hooks, attach the partition net to the two front loops on the folded down rear seat backrest, arrows 2. Loosen both tensioning belts on the bottom of the partition net as necessary.
5. After loading, pull both partition net tensioning belts tight.

With the rear seat backrest upright

When the rear seat backrest is upright, install the cargo area partition net behind the 2nd row of seats.

1. Remove the cargo cover.
2. Open the rear cover caps up on the roof frame until they engage.



3. Insert each of the two top retaining pins of the cargo area partition net into the receptacles until they reach the stop, arrow 1, and push them forward.

Make sure that the lower hooks with the opening point toward the rear of the vehicle.

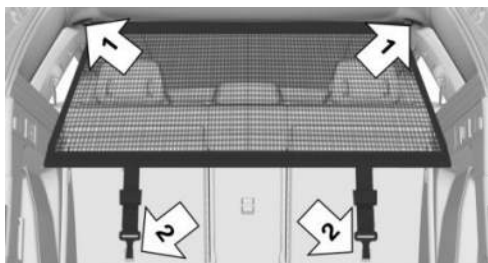

4. Hook the cargo area partition net with the lower two hooks into the two loops on the rear seat backrest, arrows 2.
5. Pull both tensioning belts tight on the bottom of the partition net.

Stowing the partition net

The cargo area partition net can be stowed under the cargo floor panel.

1. Remove the cargo area partition net.
2. Roll up the cargo area partition net and pack it with the hook and loop tape.
3. Fold up the cargo area floor.
4. Stow the cargo area partition net in the recess.



5. Push the cargo floor panel downward.

Things to remember when driving

Vehicle features and options

This chapter describes model-specific equipment, systems, and functions that are currently available, or may become available in the future, even if they are not present in the vehicle.

Additional information:

Vehicle equipment, refer to page 8.

Break-in procedures

General information

Moving parts need to work together smoothly.

The following instructions will help you to achieve a long vehicle life and good efficiency.

During break-in, do not use the Launch Control.

Safety information

Warning

Due to new parts and components, safety and driver assistance systems can react with a delay. There is a risk of accident, injury, and property damage. After installing new parts or with a new vehicle, drive conservatively and intervene early if necessary. Observe the break-in procedures of the respective parts and components.

Engine, transmission, and axle drive

Up to 1,200 miles/2,000 km

Do not exceed the maximum engine and road speed:

▶ 4,500 rpm and 100 mph/160 km/h.

Avoid full throttle or kickdown under all circumstances.

From 1,200 miles/2,000 km

The engine and vehicle speed can gradually be increased.

Tires

Tire traction is not optimal due to manufacturing circumstances when tires are brand new.

Drive conservatively for the first 200 miles/300 km.

Brake system

Brake disks and brake pads must be broken in to avoid possible brake noise. Drive cautiously for the first approx. 300 miles/500 km.

Following part replacement

Observe the break-in procedures again if components mentioned above are replaced.

Driving on poor roads

Principle

Because of its greater ground clearance, the vehicle can be driven on a variety of road types and qualities.

All-wheel drive can help improve drive power.

Safety information

NOTICE

Objects in unpaved areas, for instance stones or branches, can damage the vehicle. There is a risk of property damage. Do not drive on unpaved terrain.

When driving on poor roads

For your own safety, for the safety of passengers and of the vehicle, note the following points:

- ▶ Familiarize yourself with the vehicle before driving.
- ▶ Do not take risks when driving.
- ▶ Adjust the speed to the road surface conditions. The steeper and more uneven the road, the slower the speed should be.
- ▶ When driving on steep uphill or downhill grades: add engine oil and coolant up to near the maximum mark.
- ▶ Do not allow the vehicle body or underbody to come into contact with the ground.
- ▶ When wheels continue to spin, depress the accelerator pedal sufficiently so that driving stability control systems can distribute the driving power to the wheels.

After a trip on poor roads

After a trip on poor roads, check wheels and tires for damage to maintain driving safety. Clear heavy soiling from the body.

After the vehicle body or floor has come into contact with the ground, have the vehicle checked by an authorized service center or another qualified service center or repair shop.

General driving notes

Closing the tailgate

Safety information

Warning

An open tailgate protrudes from the vehicle and can endanger occupants and other road users or damage the vehicle in the event of an accident, braking or evasive maneuvers. In addition, exhaust gas or water may enter the vehicle interior. There is a risk of injury or risk of damage to property. Do not drive with the tailgate open.

Driving with the tailgate open

If the vehicle still needs to be driven with the tailgate open:

- ▶ Close all windows and the glass sunroof.
- ▶ Greatly increase the blower output.
- ▶ Drive moderately.
- ▶ Fasten the tailgate, e.g., with a tensioning belt.

Hot exhaust system

Warning

High temperatures can occur underneath the body, for instance caused by the exhaust system, while driving. Contact with the exhaust system can cause burns. There is a risk of injury. Do not touch the exhaust system, including the exhaust pipe, when hot.

Warning

If combustible materials such as leaves or grass come in contact with hot parts of the exhaust system, these materials can ignite. There is a risk of fire and an injury hazard.

Do not remove the heat shields installed and never apply undercoating to them. Make sure that no combustible materials can come in contact with hot vehicle parts while driving, in Neutral or during parking.

Exhaust gas particulate filter

Principle

The exhaust gas particulate filter collects soot particles. The soot particles are burned at high temperatures to clean the exhaust gas particulate filter as necessary.

General information

Depending on vehicle equipment and national-market version, the vehicle is equipped with an exhaust particulate filter. For more information on the exhaust particulate filter, contact an authorized service center or another qualified service center or repair shop.

The following may occur when cleaning for several minutes:

- ▶ Temporarily, the engine may run less smoothly.
- ▶ A somewhat higher RPM is necessary to reach usual power development.
- ▶ Fuel consumption may be higher. The higher fuel consumption is included as mean value in the display for the current consumption.
- ▶ A slight smoke formation coming from the exhaust system, even after the engine is switched off.
- ▶ Noises such as those caused by the radiator fan running, even several minutes after the engine is switched off.

Overrun of the radiator fan for several minutes is normal even after short trips.

Condensation detected in drive system

Various driving profiles ensure that the drive system functions properly. A driving style with consistently low loads can negatively affect overall functionality, e.g., condensation forming in the drive system. Occasionally running the engine longer with higher loads can counteract this.

If condensation has formed in the drive system, a corresponding Check Control message appears. In this case, on the next drive outside of town, proceed as follows for approx. 30 minutes:

- ▶ Depending on vehicle equipment, engage selector lever position S or L.
- ▶ Deactivate the speed control system.
- ▶ Activate SPORT driving mode via Driving Experience Control.
- ▶ If possible, drive at varying speeds.

Additional information:

- ▶ Engaging selector lever position: Steptronic transmission, refer to page 133.
- ▶ Driving Experience Control, refer to page 138.

Vehicle laminated glass

The vehicle laminated glass provides complete protection against the harmful effects of ultraviolet radiation on the skin.

Mobile communications in the vehicle

Warning

Vehicle electronics and mobile communication devices can influence one another. There is radiation due to the transmission operations of mobile communication devices. There is a risk of injury or risk of damage to property. If possible, only use mobile communication devices, e.g., mobile phones, when connected directly to an external antenna or

Personal eSIM in order to prevent mutual interference and to deflect radiation from the vehicle interior.

Aquaplaning

On wet or slushy roads, a wedge of water can form between the tires and road surface.

This phenomenon is referred to as aquaplaning. It is characterized by a partial or complete loss of contact between the tires and the road surface, ultimately undermining your ability to steer and brake the vehicle.

Driving through water

General information

When driving through water, follow the following:

With pre-heating:

- ▶ Deactivate Auto Start/Stop function.
- ▶ Drive through calm water only.
- ▶ Drive through water only up to a maximum height of 9.8 inches/25 cm.
- ▶ Drive through water at a maximum of walking speed, up to 3 mph/5 km/h.

Without pre-heating:

- ▶ Deactivate Auto Start/Stop function.
- ▶ Drive through calm water only.
- ▶ Drive through water only up to a maximum height of 19.6 inches/50 cm.
- ▶ Drive through water at a maximum of walking speed, up to 3 mph/5 km/h.

Additional information:

Auto Start/Stop function, refer to page 131.

Safety information

NOTICE

When driving too quickly through deep water, the water can penetrate the engine compartment, the electrical system, or the transmission. There is a risk of property damage. When driving through water, do not exceed the maximum indicated water level and the maximum speed for driving through water.

Braking safely

General information

The vehicle is equipped with an Antilock Braking System as a standard feature.

Perform full braking when appropriate. To achieve the best possible braking assistance, do not reduce the pressure on the brake pedal during full braking. Steering is still responsive. You can still avoid any obstacles with a minimum of steering movement.

Sounds from the hydraulic circuits indicate that the Antilock Braking System is regulating.

Objects in the travel path of the pedals

Warning

Objects in the driver's footwell can limit the pedal travel or block a depressed pedal. There is a risk of accident. Stow objects in the vehicle such that they are secured and cannot enter into the driver's footwell. Use floor mats that are suitable for the vehicle and can be safely attached to the floor. Do not use loose floor mats and do not layer several floor mats. Make sure that there is sufficient clearance for the pedals. Ensure that the floor mats are securely fastened again after they were removed, for instance for cleaning.

Pedal feel when driving off

After turning on drive-ready state from idle state, the pedal may feel unusual, e.g., the pedal travel path may feel short or long. After the brake pedal has been fully released, the pedal will feel as usual again.

Driving in wet conditions

In case of wet roads, exposure to road salt or in heavy rain, gently depress the brake pedal every few kilometers.

Ensure that this action does not endanger other road users.

The heat generated while braking dries brake disks and brake pads and protects them against corrosion.

In this way the brake power will be available when you need it.

Hills

General information

Drive long or steep downhill gradients in the gear that requires least braking effort. Otherwise, the brake system may overheat and reduce braking effect.

You can increase the engine braking effect by downshifting, going all the way to first gear, if needed.

Safety information

Warning

Light but constant pressure on the brake pedal can lead to high temperatures, brake wear, and even failure of the brake system. There is a risk of accident, injury, and property damage. Avoid placing excessive stress on the brake system.

Warning

In Neutral or with drive-ready state switched off, safety functions, for instance engine braking effect, braking assistance and steering assistance, may be restricted or not available. There is a risk of accident, injury, and property damage. Do not attempt to drive in Neutral or with drive-ready state switched off.

Brake disk corrosion

Corrosion on the brake disks and contamination on the brake pads are increased by the following circumstances:

- ▶ Low mileage.
- ▶ Extended stationary periods.
- ▶ Infrequent use of the brakes.
- ▶ Aggressive, acidic, or alkaline cleaning agents.

Corrosion buildup on the brake disks will cause a pulsating effect on the brakes when braking slowly - generally this cannot be corrected.

Condensation water under the parked vehicle

When using the automatic climate control, condensation water develops and collects underneath the vehicle.

Roof bars

General information

Installation only possible with roof rack.

Roof racks are available as optional accessories.

Safety information

Warning

When driving with a roof load, e.g., roof bars, the vehicle's center of gravity is higher. This increases the risk of the vehicle tipping in critical driving situations. There is a risk of accident, injury, or property damage. Drive with roof load only with activated Dynamic Stability Control.

Installation

Follow the assembly instructions for the roof bars.

Be sure that adequate clearance is maintained for tilting and opening the glass sunroof.

Loading

Because luggage racks raise the vehicle's center of gravity when loaded, they have a major effect on vehicle handling and steering response.

When loading and driving, note the following:

- ▶ Do not exceed the approved roof/axle weights and the approved gross vehicle weight.
- ▶ Distribute the roof load uniformly.
- ▶ The roof load should not extend past the loading area.
- ▶ Always place the heaviest pieces on the bottom.
- ▶ Secure the roof luggage firmly, for instance using luggage straps.
- ▶ Do not let objects project into the swiveling range of the tailgate.
- ▶ Drive carefully. Do not drive off or brake suddenly or take corners at speed.

Driving on racetracks

Warning

The vehicle is not designed for use in M Sport or motorsport-like competition. There is a risk of accident, injury, and property damage. Do not use the vehicle for M Sport or motorsport-like competitions.

Higher mechanical and thermal loads during racetrack operation lead to increased wear. Use of the vehicle in M Sport or motor sport type competition is an improper use of the vehicle and may affect your warranty coverage. Please consult the New Vehicle Limited Warranty Booklet for further information on warranty matters.

The vehicle manufacturer recommends using special sport tires, e.g., high-performance tires. Sport tires are designed for the specific requirements of driving on the racetrack. For more information on sport tires, contact an authorized service center or another qualified service center or repair shop.

Before and after driving on a racetrack, have the vehicle checked by an authorized service center or another qualified service center or repair shop.

Trailer and rear carrier

Vehicle features and options

This chapter describes model-specific equipment, systems, and functions that are currently available, or may become available in the future, even if they are not present in the vehicle.

Additional information:

Vehicle equipment, refer to page 8.

General information

The permissible trailer loads, axle weights, drawbar node weights, and the permissible gross vehicle weight are specified in the technical data.

When the trailer power socket is occupied or when driving off, the vehicle is automatically set to the normal level.

Before driving

Drawbar nose weight

The maximum payload of the towing vehicle is reduced by the weight of the trailer hitch and the drawbar nose weight. The drawbar nose weight increases the vehicle weight. Do not exceed the approved gross vehicle weight of the towing vehicle.

Loading

Distribute cargo as evenly as possible on the loading platform.

Stow the payload as low and close to the trailer axle as possible. A low center of gravity in the trailer increases the driving safety of the entire car-trailer combination.

Do not exceed the approved gross vehicle weight of the trailer and the permissible trailer

load of the vehicle. The smaller value applies in each case.

Tire pressure

Note the tire inflation pressure of the vehicle and trailer.

For the vehicle, the tire inflation pressure for higher loads applies.

For the trailer, the specifications of the manufacturer apply.

After correcting the tire inflation pressure or connecting or disconnecting a trailer, reinitialize the Flat Tire Monitor display or reset the Tire Pressure Monitor.

Additional information:

- ▶ Tire pressure specifications, refer to page 348.
- ▶ Tire pressure monitor, refer to page 362.
- ▶ Flat tire monitor, refer to page 370.

Exterior mirrors

Exterior mirrors, which bring both rear edges of the trailer into the driver's field of vision, are available as optional accessories from an authorized service center or another qualified service center or repair shop.

Electrical consumption

General information

Before start of the trip, check the function of the trailer tail lights.

Keep the activation times of the electrical components short during camper operation to save the vehicle battery power.

Trailer tail lights

The consumption of the trailer tail lights must not exceed the following values:

- ▷ Turn signals/brake lights: 54 watts per side.
- ▷ Rear lights: 100 watts in total.
- ▷ Reversing lights: 54 watts in total.

Mount for trailer hitch

General information

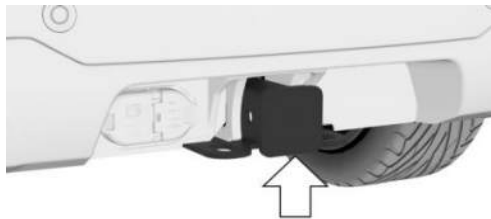

The mount for the trailer hitch is located on the rear of the vehicle.

Information on suitable trailer hitches is found on the underside of the mount, see arrow.

Follow the instructions for maintaining the trailer hitch mount.

Additional information:

Caring for special components, refer to page 407.

Safety information

Warning

While driving, high temperatures can occur underneath the vehicle body, for instance caused by the exhaust system. Contact with the hot components can cause burns. There is a risk of injury. Do not touch hot components. Do not perform work in the vicinity of hot components until after they have cooled down.

Removing the cover



Pull the cover out of the back of the mount, and stow it in the vehicle.

Trailer power socket



The trailer power socket is located to the left of the trailer hitch mount.

Loops for trailer safety chain

General information

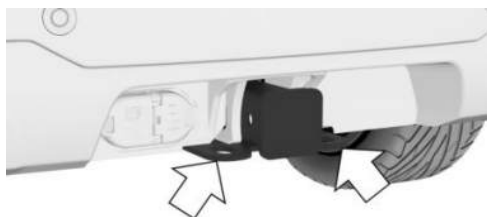

There are two loops on the mount for the trailer hitch for locking the trailer safety chain.

Safety information

Warning

If the trailer safety line or the trailer safety chain is not fastened correctly, the trailer may unintentionally come loose. There is a risk of accident. Before driving with a trailer, correctly couple the trailer safety line or the trailer safety chain to the eye of the trailer hitch.

Warning

If the trailer safety line or the trailer safety chain is not fastened correctly, the safety line or safety chain may get caught and cause damage to the vehicle or trailer. There is a risk of accident. Before driving with a trailer, correctly couple the trailer safety line or the trailer safety chain to the eye of the trailer hitch. Ensure that the safety line or safety chain can move freely and is not dragging on the ground.

- ▷ Driver assistance systems, refer to page 222.
- ▷ Driving stability control systems, refer to page 216.
- ▷ Cruise control, refer to page 226.

Safety information

Warning

Depending on the design and loading of trailers, they may begin swinging at speeds exceeding approx. 50 mph/80 km/h. There may be a risk of accidents or risk of damage to property.

Adapt your speed when driving with a trailer. Immediately brake in the case of swinging. Apply necessary steering corrections as carefully as possible.

Warning

The tire inflation pressure must be adjusted to the increased axle weight in trailer towing. Driving with too low tire inflation pressure can damage the tires. There may be a risk of accidents or risk of damage to property. Do not exceed a speed of 60 mph/100 km/h. Increase the tire pressure of the towing vehicle by 0.2 bar/3 psi. Note the maximum possible tire inflation pressure indicated on the tire.

Driving with trailer or rear carrier

General information

When driving with a trailer or rear carrier, some driver assistance systems may be restricted or not available. A Check Control message is displayed where applicable. The driving stability control systems, e.g., Antilock Braking System, are still available.

If necessary, select another driver assistance system that can be used while towing a trailer, e.g., Active Cruise Control.

Additional information:

Using a trailer or rear carrier

General information

When the trailer socket is occupied, a selection menu is shown on the control display. In the menu, specify whether you are driving your vehicle with a trailer or rear carrier.

Some driver assistance systems may have limited functionality or may malfunction when driving with a trailer or rear carrier, e.g., rear bicycle rack, and an unoccupied trailer power

socket. To avoid malfunctions, activate use of the trailer or rear carrier manually.

When the trailer socket is occupied or trailer towing is activated, some driver assistance systems may be restricted or not available. A Check Control message is displayed where applicable.

Safety information

Warning

If the control display is configured incorrectly, some driver assistance systems may have limited functionality or malfunction. There is a risk of accident. Make sure that the corresponding setting is enabled when using the trailer or rear carrier.

Activating/deactivating trailer towing manually

1.  Apps menu
2. "Vehicle"
3. "Driving settings"
4. "Driver Assistance"
5. "Trailer mode"
6. "Type"
7. Select whether you are driving with or without a trailer/rear carrier.

Maximum speed

General information

When towing a trailer, you can configure the maximum permitted speed for the vehicle-trailer combination. Depending on vehicle equipment, this setting is considered by speed limit systems.

Additional information:

- ▶ Speed Limit Info, refer to page [222](#).
- ▶ Speed Limit Assistant, refer to page [243](#).

Setting the maximum speed

1.  Apps menu
2. "Vehicle"
3. "Driving settings"
4. "Driver Assistance"
5. "Trailer mode"
6. "Maximum permitted speed"
7. Select the desired speed.

Uphill grades

General information

Trailer towing is permitted up to gradients of 12 %.

If higher trailer loads are approved at a later point in time, the gradient limit is 8%.

Driving off on uphill grades

The parking brake is automatically released when the accelerator pedal is activated.

In order to prevent rolling back when driving off, use the parking brake.

1. Pull  and release the switch shortly before starting. Press and release the
The parking brake is set.
2. Step on the accelerator pedal sufficiently to drive off.

Hills

A car-trailer combination has the tendency to swing more readily on hills.

Manually downshift to the next-lowest gear before driving on a hill and drive downhill slowly.

Trailer Assistant

Principle

The Trailer Assistant helps when reversing with a trailer.

When reversing, the steering of the front wheels is determined by entering the kink angle and adopted by the system.

Vehicle features and options

This system may not be available in the owned vehicle, e.g. due to the selected optional equipment, the national-market version or the option for later enabling and software updates. This also applies to individual functions of the system.

For information on whether a function is currently available in the vehicle or when the function can be installed in the vehicle, contact an authorized service center or another qualified service center or repair shop.

Additional information:

Vehicle equipment, refer to page 8.

General information

The kink angle determines the angle between the vehicle and trailer and thus the desired direction of travel of the car-trailer combination in reverse.

With the Trailer Assistant, the car-trailer combination is not guided by the steering wheel when reversing, but by continuous correction of the articulation angle on the control display.

The system takes over the steering. The driver must control the speed using the accelerator and brake pedals.

Follow the information in the "Parking assistance systems" chapter.

Additional information:

Parking assistance systems, refer to page 249.

Safety information

Warning

The system cannot serve as a substitute for the driver's personal judgment in assessing the traffic situation. Based on the limits of the system, it cannot independently react to all traffic situations. There is a risk of accident, injury, and property damage. Adjust driving style to traffic conditions. Watch the surrounding traffic situation closely, be ready to take over steering and braking at any time, and actively intervene where appropriate.

Warning

The system can steer the vehicle over or onto curbs. There is a risk of injury or risk of damage to property. Watch surrounding traffic closely and actively intervene where appropriate.

Functional requirements

- ▷ A trailer is attached and connected.
- ▷ The system is taught for the trailer to be used.
- ▷ Depending on vehicle equipment and national-market version, trailer towing is activated.
- ▷ The rearview camera is clean and clear.
- ▷ Vehicles with removable trailer hitch: Use suitable accessories approved by the vehicle manufacturer.

Teaching the Trailer Assistant

Whenever you hitch a trailer, the Trailer Assistant must be taught again.

A message on the control display prompts the driver to drive forward at low speed while also steering.

Turning operating tips on/off

The Trailer Assistant operating tips provide specific information for operating the system properly. The operating tips can be turned on/off.

1. Select the BMW ID or driver profile.
2.  Apps menu
3. "Vehicle"
4. "Driving settings"
5. "Driver Assistance"
6. "Parking"
7. "Operating tips for Trailer Assistant"

Reversing with the Trailer Assistant

1. Attach and connect trailer to vehicle.
2. Teaching the Trailer Assistant.
3. Depending on vehicle equipment and national-market version, activate trailer towing on the control display.



4.  With the vehicle at a standstill, press button or engage reverse gear.

Parking assistance systems displays are shown on the control display.

5. "Start Trailer Assistant"
The control display shows the rearview camera image with a view of the tow bar and a stylized view of the vehicle with trailer.
6. Confirm or turn off operating tips on the control display as necessary.
7. If necessary, shift into reverse gear.
8. Set the desired kink angle.
Follow the instructions on the control display.
9. Take your hands off the steering wheel and carefully drive in reverse with the accelerator pedal and the brake.

 Green: the system takes control of steering.

When driving in reverse, observe the vehicle's surroundings.

In case of obstacles, stop immediately and take over steering.

10. If necessary, adjust the kink angle while driving to correct the direction.
11. Engage selector lever position P when finished maneuvering.

Canceling the Trailer Assistant manually

Maneuvering of the car-trailer combination can be aborted manually:

"Cancel"

Canceling the Trailer Assistant automatically

The system automatically cancels in situations such as the following:

- ▶ When the driver grasps the steering wheel or takes over steering.
- ▶ When shifting from reverse gear to selector lever position D, the Trailer Assistant switches to standby mode.

If reverse gear is engaged again after a short distance, the function is active again.

- ▶ During activation or intervention by driver assistance systems.
- ▶ When the view on the control display is overlaid with messages.
- ▶ In case of a slippery surface.
- ▶ When the vehicle is rolling such as on a slope.
- ▶ In case of changed ambient conditions.
- ▶ If the vehicle speed exceeds approx. 6 mph/10 km/h.

Turning trailer protection brake on/off

Whenever the Trailer Assistant is canceled, the trailer protection brake is applied and the vehi-

cle is secured at a standstill. As a result, the car-trailer combination cannot continue to roll uncontrolled. The trailer protection brake can be switched on or off.

1.  Apps menu
2. "Vehicle"
3. "Driving settings"
4. "Driver Assistance"
5. "Parking"
6. "Trailer protection braking"

System limits

General information

The maximum speed is limited to approx. 6 mph/10 km/h.

A warning is given at a speed of approx. 4 mph/7 km/h.

If the maximum speed is exceeded, the function is interrupted.

Functional limitations

The system may be limited in the following situations:

- ▶ Trailers with fifthwheel steering are not supported.
- ▶ Accessories on tow bar, e.g., a rear bicycle rack.
- ▶ Tow bars and trailers with unusual shapes.
- ▶ Unsuitable removable trailer hitches.
- ▶ Rearview camera dirty or covered.

Additional information:

Cameras, refer to page 35.

Trailer stabilization control

Principle

Trailer stabilization control helps by absorbing the swinging movements of the trailer.

The system detects swinging and automatically brakes the vehicle quickly in order to leave the critical speed range and stabilize the car-trailer combination.

General information

If the trailer power socket is occupied but a trailer has not been hitched, this system can also activate in extreme driving situations, e.g., when using a rear bicycle rack with lighting.

Functional requirement

- ▶ A trailer is attached.
- ▶ The trailer power socket is occupied.
- ▶ Vehicle speed must be more than approx. 40 mph/65 km/h.

System limits

The system cannot intervene or not intervene in time in the following situations, for instance:

- ▶ If a trailer jackknives suddenly, for instance on slippery roads or loose surfaces.
- ▶ If a trailer with a high center of gravity tilts, before swinging is detected.
- ▶ If Dynamic Stability Control is deactivated or has malfunctioned.
- ▶ When the power consumption of a trailer is too low, for instance due to tail lights with LED technology, to be detected by the system.

Brake Controller

Trailer brakes only work if a brake controller is installed.

Trailer brakes will not work without the brake controller.

The vehicle manufacturer recommends having the brake controller installed by an authorized service center or another qualified service center or repair shop. Incorrect installation or pin-

ning of the connector can cause the trailer lights and brake system to fail.

For information on installing a brake controller, contact an authorized service center or another qualified service center or repair shop.

Rear carriers

Principle

Rear carriers, e.g., rear bicycle racks, are devices that are mounted on the vehicle in order to help transport cargo.

General information

Rear carriers recommended by the manufacturer of the vehicle are available as optional accessories.

Rear bicycle racks for a maximum of three bicycles can be used.

Only use rear carriers that are mounted directly on the mount for the trailer hitch.

Installation

Follow the assembly instructions for the rear carrier.

Loading

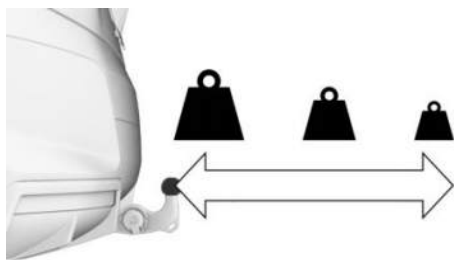

The permissible gross weight of the loaded rear carrier depends on how far its center of gravity is from the ball head.

- ▶ If the center of gravity is up to 11.8 inches/30 cm from the ball head, the gross

weight of the rear carrier must not exceed 165 lbs/75 kg.

- ▶ If the center of gravity is 23.5 inches/60 cm from the ball head, the gross weight of the rear carrier must not exceed 77 lbs/35 kg.
- ▶ Stow heavy cargo as close as possible to the ball head.
- ▶ Fasten cargo securely to the rear carrier, making sure it will not slip.

Before driving

Before starting your trip, make sure that the tail lights on the rear carrier are working.

The maximum power rating of the rear carrier tail lights should not exceed the maximum power rating of the trailer tail lights.

To prevent functional limitations and malfunctions affecting driver assistance systems, activate trailer towing.

Additional information:

- ▶ Electrical consumption, refer to page 334.
- ▶ Using a trailer or rear carrier, refer to page 336.

Driving with a rear carrier

When loaded, rear carriers move the vehicle's center of gravity, which affects how the vehicle handles and steers.

When loading and driving, note the following:

- ▶ Do not exceed the approved axle weight and the approved gross vehicle weight.
- ▶ Drive cautiously and avoid driving off and braking with jerky movements or fast cornering.

Saving fuel

Vehicle features and options

This chapter describes model-specific equipment, systems, and functions that are currently available, or may become available in the future, even if they are not present in the vehicle.

Additional information:

Vehicle equipment, refer to page [8](#).

Reducing fuel consumption

Principle

The vehicle contains advanced technologies for the reduction of consumption and emission values.

There are some actions you can take to change your fuel consumption and environmental impact:

- ▶ Remove unnecessary cargo from the vehicle.
- ▶ Remove add-on parts, e.g., a rear carrier, after use.
- ▶ Close the windows and glass sunroof while driving.
- ▶ Check the tire pressure regularly and increase it as necessary.
- ▶ Switch off the engine if the vehicle is to remain stationary for a longer period.
- ▶ Practice anticipatory driving and let the vehicle coast more often.
- ▶ Deactivate functions that are not required, e.g., rear window heating.
- ▶ Have the vehicle serviced regularly.

Adaptive recuperation

Principle

Adaptive recuperation supports an anticipatory and comfort-oriented driving style.

The system decides based on the situation if energy is recovered through recuperation or if the vehicle is to coast.

In vehicles with mild hybrid technology, the power of recuperation is adaptive, which causes the vehicle to decelerate to varying degrees when coasting.

General information

Various sensors analyze the current driving situation, e.g., the distance to the vehicle in front.

Adaptive recuperation is available depending on the equipment and national-market version.

Activating/deactivating adaptive recuperation

Adaptive recuperation is deactivated by activating SPORT driving mode.

Adaptive recuperation is activated when changing to another driving mode.

Adaptive recuperation can only be used in selector lever position D.

Display

Display in the instrument cluster

Adaptive recuperation can be displayed on the instrument cluster.

Additional information:

Power gauge, refer to page [156](#).

Display on the control display

The adaptive recuperation can be displayed on the control display.

Additional information:

Current driving condition, refer to page 164.

Coasting

Principle

The drive system allows the vehicle to roll freely with minimal deceleration in selector lever position D. This driving condition is referred to as coasting. This reduces fuel consumption.

Vehicles with mild hybrid technology do not consume fuel when coasting.

General information

An anticipatory driving style helps the driver to use the function often and supports the efficient effect of coasting.

Coasting is automatically adapted to the respective driving situation.

The coasting mode is displayed in the Live Vehicle menu as efficient coasting.

Additional information:

Current driving condition, refer to page 164.

Exemplary driving situations

If you can travel a certain distance without any foreseeable need to brake, it is beneficial to coast.

The following exemplary driving situations may be suitable:

- ▷ Rolling on a straight downhill route without obstacles.
- ▷ Coasting on a distance without obstacles.

Avoid late or strong braking.

Functional requirements

- ▷ Selector lever position D is engaged.
- ▷ Brake is not depressed.
- ▷ Accelerator pedal is not operated.
- ▷ Engine and transmission are at operating temperature.

The function is available in the speed range from approx. 16 mph/25 km/h to 100 mph/160 km/h.

Operation via shift paddles

Principle

Depending on the vehicle's equipment, the Coasting mode can be influenced with the shift paddles.

Activating/deactivating coasting via shift paddles

Long press the right shift paddle to activate.

To deactivate, actuate the left shift paddle.

System limits

Coasting cannot be used, or can only be used to a limited extent, in the following situations:

- ▷ While Active Cruise Control is active.
- ▷ Sensors are defective, dirty, or covered.
- ▷ Driving in the dynamic limit range and on steep uphill or downhill grades.
- ▷ Battery charge status temporarily too low or vehicle electrical system drawing excessive current.

Driving modes for efficient driving

Principle

When certain prerequisites are met the engine is automatically decoupled from the transmission in the D selector lever position. The ve-

hicle continues traveling in Neutral to reduce consumption. The D selector lever position remains engaged.

The achieved extended range is displayed in the instrument cluster as bonus range.

Overview

Button in the vehicle

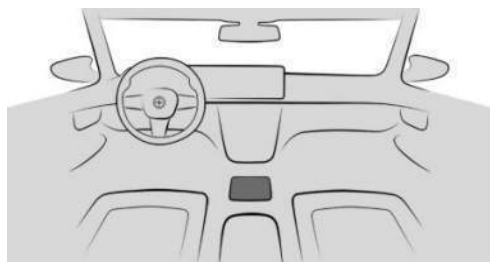

Configuring ECO PRO

1.  Press the button.
2. Select the desired setting.

Resetting the settings

1.  Press the button.
2. "Settings"
3. "Reset to ECO PRO STANDARD"

Efficiency trainer

Principle

The system provides assistance for an anticipatory and comfort-oriented driving style. For this purpose, map information and sensor data is used to analyze the current driving situation such as upcoming speed limits and vehicles

driving ahead. Based on this information, the driver receives notices for an efficient driving style early on. The efficiency of the driving style is evaluated in the control display and shown in three categories.

General information

The system has different displays to support the driver with an efficient driving style.

Functional requirements

- ▷ Selector lever position D is engaged.
- ▷ ECO PRO drive mode is activated.

Display

Power gauge

When ECO PRO driving mode is activated, the display switches to a special configuration.

Depending on the equipment, some system information can also be displayed in the Head-up display.

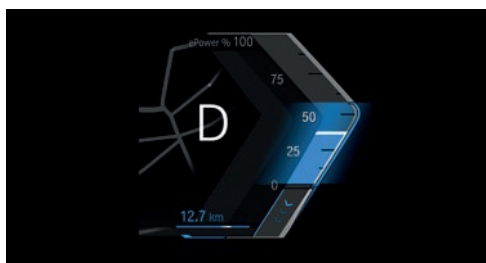

The efficient range of the power gauge is colored blue. Additionally, the bonus range will be displayed.

The efficient range is adjusted depending on the driving situation.

If the power gauge moves within the blue range, the current driving style is efficient. The display will change to gray if the driving style is inefficient.

Bonus range



A modified driving style helps you extend your driving range.

The range extension is displayed as the bonus range in the instrument cluster.

If the bonus range is shown in gray or is hidden, the current driving style is inefficient.

The display turns blue as soon as all conditions for efficient driving are met.

The intervals for resetting the bonus range depend on the settings of the trip data.

Display in case of inefficient driving style



When driving above the efficient range, an arrow will be displayed.

For instance, this is displayed for the following situations:

- ▶ Excessive acceleration.
- ▶ Excessive speed.

In addition, a notice to coast in advance is displayed.

System limits

For example, the function is not available in the following situations:

- ▶ While Active Cruise Control is active.
- ▶ With trailer towing.

Efficiency evaluation

General information

The efficiency of the driving style, e.g., acceleration, is evaluated on the control display and shown in three categories. The current trip is analyzed.

Functional requirement

This function is available in ECO PRO driving mode.

Calling up the efficiency evaluation

1.  Apps menu
2. "Vehicle"
3. "Live Vehicle"

Additional information:

Live Vehicle, refer to page [146](#)

Display on the control display

The display of the efficiency analysis shows the efficiency of the driving style.

The more efficient the driving style, the larger the area that is displayed in color and the faster the bonus range increases.

In contrast, a reduced area will be displayed with an inefficient driving style.

Refueling

Vehicle features and options

This chapter describes model-specific equipment, systems, and functions that are currently available, or may become available in the future, even if they are not present in the vehicle.

Additional information:

Vehicle equipment, refer to page [8](#).

Follow the following when refueling

General information

Follow the fuel recommendation prior to refueling.

When refueling, hook the fuel pump nozzle completely into the filler pipe. Lifting up the fuel pump nozzle while refueling causes:

- ▶ Premature switching off.
- ▶ Reduced return of the fuel vapors.

The fuel tank is full when the fuel pump nozzle clicks off the first time.

Make sure that the fuel cap is closed properly after refueling, otherwise the emissions warning light may illuminate.

Follow safety regulations posted at the filling station.

Additional information:

Fuel quality, refer to page [381](#).

Safety information

NOTICE

With a range below 30 miles/50 km, the engine may no longer have sufficient fuel. Engine functions are not ensured anymore. There is a risk of property damage. Refuel promptly.

NOTICE

Fuels are toxic and aggressive. Overfilling of the fuel tank can damage the fuel system. Painted surfaces may be damaged by contact with fuel. Escaping fuel can harm the environment. There is a risk of property damage. Avoid overfilling.

Fuel filler cap

General information

If the fuel filler cap is not fitted correctly, the emissions indicator light illuminates on the instrument cluster.

Additional information:

Indicator/warning lights, refer to page [149](#).

Safety information

Warning

The fuel filler cap's retaining strap can become pinched and crushed when the cap is closed. It will then not be possible to close the fuel filler cap correctly. Fuel or fuel vapors can escape. There is a risk of injury or risk of damage to property. Make sure that the

retaining strap does not become pinched or crushed when closing the fuel filler cap.

Opening

1. To open the fuel filler flap, press on the rear edge, arrow. The fuel filler flap opens.



2. Open the fuel filler cap counterclockwise.

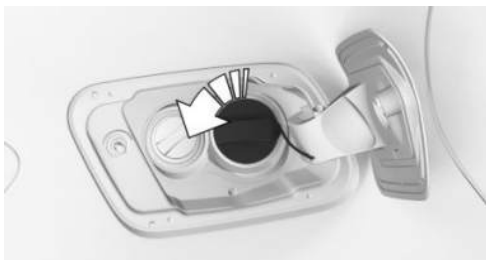

3. Place the fuel filler cap in the bracket on the fuel filler flap.



Closing

1. Fit the fuel filler cap and turn it clockwise until it clicks audibly.
2. Press on the fuel filler flap until it engages.

Emergency unlocking

It may be necessary in certain situations to unlock the fuel filler flap manually, for instance with an electrical malfunction.

Have the fuel filler flap unlocked by an authorized service center or another qualified service center or repair shop.

Wheels and tires

Vehicle features and options

This chapter describes model-specific equipment, systems, and functions that are currently available, or may become available in the future, even if they are not present in the vehicle.

Additional information:

Vehicle equipment, refer to page 8.

Tire pressure

General information

The tire condition and tire pressure influence the following:

- ▷ The service life of the tires.
- ▷ Driving safety.
- ▷ Driving comfort.
- ▷ Fuel consumption.

Safety information

Warning

A tire with too little or no tire inflation pressure may heat up significantly and sustain damage. This will have a negative impact on aspects of handling such as steering and braking response. There is a risk of accident, injury, and property damage. Regularly check the tire inflation pressure, and correct it as needed, for instance twice a month and before a long trip.

Tire pressure specifications

In the tire pressure table

The tire pressure table contains all tire inflation pressure specifications for given tire sizes

at ambient temperature. The tire inflation pressure specifications apply to the tire sizes approved by the vehicle manufacturer for the corresponding vehicle types.

To identify the correct tire inflation pressure, please note the following:

- ▷ Tire sizes of the vehicle.
- ▷ Maximum speed for driving.

On the control display

The current tire inflation pressure values and the intended tire inflation pressure values for the mounted tires can be displayed on the control display.

To ensure that they are displayed correctly, the tire sizes must be stored in the system and must have been set for the mounted tires.

The current tire inflation pressure value is located on each tire.

The reference tire inflation pressure value is located in the lower area of the control display.

Checking the tire pressure

General information

The tires heat up while driving. The tire pressure increases with the tire temperature.

Tires have a natural, consistent tire pressure loss.

The displays of inflation devices may under-read by up to 0.1 bar/2 psi.

Checking via tire inflation pressure specifications in tire pressure table

1. Determine the intended tire inflation pressure levels for the mounted tires.
2. Check the tire inflation pressure in all four tires, using a pressure gage, for example.

3. Correct the tire inflation pressure if the actual tire inflation pressure deviates from the intended tire inflation pressure.
4. Make sure that all valve caps are screwed onto the tire valves.

The tire inflation pressure specifications in the tire inflation pressure table only relate to cold tires or tires at the same temperature as the ambient temperature.

Only check the tire inflation pressure levels when the tires are cold, i.e.:

- ▶ A distance traveled of max. 1.25 miles/2 km has not been exceeded.
- ▶ If the vehicle has not moved again for at least two hours after a trip.

If equipped with an emergency wheel: check the tire pressure of the emergency wheel in the cargo area regularly and correct if necessary.

Checking using the tire inflation pressure specifications on the control display

1.  Apps menu
2. "Vehicle"
3. "Vehicle status"
4. "Tire Pressure Monitor"
5. Check whether the current tire inflation pressure levels deviate from the intended tire pressure value.
6. Correct the tire inflation pressure if the actual tire inflation pressure deviates from the intended tire inflation pressure.

The display of current tire pressure on the control display may be restricted when the vehicle is stationary. After a short drive, the tire pressure is updated.

After correcting the tire pressure

If equipped with a Tire Pressure Monitor, the corrected tire pressures are applied automatically. Make sure that the tire settings are correct. With tires that cannot be found in the tire

pressure values on the control display, reset the Tire Pressure Monitor (TPM).

If equipped with a flat tire monitor, reinitialize the flat tire monitor.

Tire inflation pressures up to 100 mph/160 km/h

For speeds of up to 100 mph/160 km/h and for optimum driving comfort, follow the tire inflation pressure specifications in the tire pressure table and adjust as necessary.



The tire inflation pressure specifications can also be found on the tire pressure label on the driver's door pillar.

Do not exceed a speed of 100 mph/160 km/h.

Tire pressure values up to 100 mph/160 km/h

X7 xDrive40i

Tire size	Pressure specifications in bar/PSI	
-----------	------------------------------------	--

Specifications in bar/PSI with cold tires

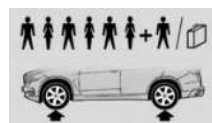

285/45 R 21 113 H XL A/S	2.4 / 35	2.8 / 41
285/45 R 21 113 H XL M+S		

Tire size	Pressure specifications in bar/PSI	
255/55 R 20 110 H XL M+S	2.6 / 38	3.1 / 45
Front: 275/40 R 22 107 Y XL	2.5 / 36	-
Rear: 315/35 R 22 111 Y XL	-	3.0 / 44
Front: HL 275/35 R 23 108 Y XL	2.5 / 36	-
Rear: HL 315/30 R 23 111 Y XL	-	3.0 / 44
F: 275/40 R 22 107 H XL M+S	2.5 / 36	-
R: 315/35 R 22 111 H XL M+S	-	3.0 / 44
Emergency wheel: T 155/80 R 19 114 M	Speed up to a max. of 50 mph / 80 km/h	
	4.2 / 60	

X7 M60i xDrive

Tire size	Pressure specifications in bar/PSI	
Specifications in bar/PSI with cold tires		
285/45 R 21 113 H XL A/S	2.4 / 35	2.8 / 41
285/45 R 21 113 H XL M+S		
255/55 R 20 110 H XL M+S	2.6 / 38	3.1 / 45

Tire size	Pressure specifications in bar/PSI	
Front: 275/40 R 22 107 Y XL	2.5 / 36	-
Rear: 315/35 R 22 111 Y XL	-	3.0 / 44
Front: HL 275/35 R 23 108 Y XL	2.5 / 36	-
Rear: HL 315/30 R 23 111 Y XL	-	3.0 / 44
F: 275/40 R 22 107 H XL M+S	2.5 / 36	-
R: 315/35 R 22 111 H XL M+S	-	3.0 / 44
Emergency wheel: T 155/80 R 19 114 M	Speed up to a max. of 50 mph / 80 km/h	
	4.2 / 60	

Tire pressures over 100 mph/160 km/h

Warning

When driving at speeds greater than 100 mph/160 km/h, incorrect tire pressures can negatively affect vehicle handling, e.g., safety or comfort while driving. The tires can become damaged, which may cause an accident. There is a risk of accident, injury, or property damage. To drive at maximum speeds, note the specified tire pressure for driving above 100 mph/160 km/h in the tire inflation pressure table, and adjust as necessary.

Tire pressure values over 100 mph/160 km/h

X7 xDrive40i

Tire size	Pressure specifications in bar/PSI	
Specifications in bar/PSI with cold tires		
285/45 R 21 113 H XL A/S	2.9 / 42	3.4 / 49
285/45 R 21 113 H XL M+S		
255/55 R 20 110 H XL M+S	2.9 / 42	3.4 / 49
Front: 275/40 R 22 107 Y XL	2.9 / 42	-
Rear: 315/35 R 22 111 Y XL	-	3.4 / 49
Front: HL 275/35 R 23 108 Y XL	2.9 / 42	-
Rear: HL 315/30 R 23 111 Y XL	-	3.4 / 49
F: 275/40 R 22 107 H XL M+S	2.9 / 42	-
R: 315/35 R 22 111 H XL M+S	-	3.4 / 49
Emergency wheel: T 155/80 R 19 114 M	Speed up to a max. of 50 mph / 80 km/h	
	4.2 / 60	

X7 M60i xDrive

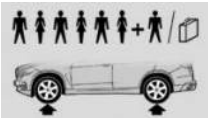
Tire size	Pressure specifications in bar/PSI	
Specifications in bar/PSI with cold tires		
285/45 R 21 113 H XL A/S	2.9 / 42	3.4 / 49
285/45 R 21 113 H XL M+S		
255/55 R 20 110 H XL M+S	2.9 / 42	3.4 / 49
Front: 275/40 R 22 107 Y XL	2.9 / 42	-
Rear: 315/35 R 22 111 Y XL	-	3.4 / 49
Front: HL 275/35 R 23 108 Y XL	2.9 / 42	-
Rear: HL 315/30 R 23 111 Y XL	-	3.4 / 49
F: 275/40 R 22 107 H XL M+S	2.9 / 42	-
R: 315/35 R 22 111 H XL M+S	-	3.4 / 49
Emergency wheel: T 155/80 R 19 114 M	Speed up to a max. of 50 mph / 80 km/h	
	4.2 / 60	

Tire marking

Tire size

245/45 R 18 96 Y

245: nominal width in mm

45: cross-sectional relationship in %

R: radial tire code

18: rim diameter in inches

96: load index

Y: speed code letter

ZR tires: reinforced radial tire for speeds exceeding 150 mph/240 km/h

Maximum tire load

Maximum tire load is the maximum permissible weight for which the tire is approved.

Locate the maximum tire load on the tire sidewall and the Gross Axle Weight Rating – GAWR – on the certification label on the driver door B-pillar. Divide the tire load by 1.1. It must be greater than one-half of the vehicle's Gross Axle Weight Rating – GAWR. Note, front vs. rear GAWR and tire loads, respectively.

Speed letter

Designation	Maximum speed
Q	up to 100 mph/160 km/h
R	up to 106 mph/170 km/h
S	up to 112 mph/180 km/h
T	up to 118 mph/190 km/h
H	up to 131 mph/210 km/h
V	up to 150 mph/240 km/h
W	up to 167 mph/270 km/h
Y	up to 186 mph/300 km/h
(Y)	above 186 mph/300 km/h

Tire Identification Number

DOT code: DOT xxxx xxx 0124

xxxx: manufacturer code for the tire brand

xxx: tire size and tire design

0124: tire age

Tires with DOT codes meet the guidelines of the U.S. Department of Transportation.

Tire age

Recommendation

Regardless of the tire tread depth, replace tires at least every 6 years.

Production date

You can find the tire production date on the tire sidewall.

Designation	Production date
DOT ... 0124	1st week of 2024

Uniform Tire Quality Grading

Quality grades can be found where applicable on the tire sidewall between tread shoulder and maximum section width.

E.g.: Treadwear 200; Traction AA; Temperature A

DOT Quality Grades

Treadwear

Traction AA A B C

Temperature A B C

All passenger vehicle tires must conform to Federal Safety Requirements in addition to these grades.

Treadwear

The treadwear grade is a comparative rating based on the wear rate of the tire when tested under controlled conditions on a specified government test course. E.g., a tire graded 150 would wear one and one-half, 1 g, times as well on the government course as a tire graded 100. The relative performance of tires depends upon the actual conditions of their use, however, and may depart significantly from the norm due to variations in driving habits, service

practices and differences in road characteristics and climate.

Traction

The traction grades, from highest to lowest, are AA, A, B, and C.

Those grades represent the tire's ability to stop on wet pavement as measured under controlled conditions on specified government test surfaces of asphalt and concrete. A tire marked C may have poor traction performance.

The traction grade assigned to this tire is based on straight-ahead braking traction tests, and does not include acceleration, cornering, hydroplaning, or peak traction characteristics.

Temperature

The temperature grades are A, the highest, B, and C, representing the tire's resistance to the generation of heat and its ability to dissipate heat when tested under controlled conditions on a specified indoor laboratory test wheel. Sustained high temperature can cause the material of the tire to degenerate and reduce tire life, and excessive temperature can lead to sudden tire failure. The grade C corresponds to a level of performance which all passenger car tires must meet under the Federal Motor Vehicle Safety Standard No. 109. Grades Band A represent higher levels of performance on the laboratory test wheel than the minimum required by law.

Warning

The temperature grade for this tire is established for a tire that is properly inflated and not overloaded. Excessive speed, underinflation, or excessive loading, either separately or in combination, can cause heat buildup and possible tire failure.

Runflat tires

Runflat tires, refer to page 357, are labeled with a circular icon containing the letters RSC marked on the tire sidewall.

M+S

Winter tires, as well as all-season tires with better winter performance than summer tires, can be identified by the M+S marking on the tire side wall.

Tire tread

Safety information

Warning

If the tire tread depth is too low, driving safety may be impaired in critical situations such as aquaplaning or slush on the road. There is a risk of accident, injury, and property damage. The tire tread depth may not fall below 0.12 in/3 mm for summer tires and 0.16 in/4 mm for winter and all-season tires, or observe the statutory regulations on minimum tread depth.

Minimum tread depth



The tire manufacturer's wear indicators are distributed over the tire circumference. These indicators have a height of min. 0.06 in/1.6 mm and serve as an indicator for tire tread wear.

The positions of the wear indicators are marked on the tire sidewall with TWI, Tread Wear Indicator.

Tire damage

General information

Check your tires regularly for damage, foreign objects lodged in the tread, and tread wear.

Indications of tire damage or another vehicle malfunction:

- ▷ Unusual vibrations.
- ▷ Unusual tire or running noises.
- ▷ Unusual vehicle handling such as a strong tendency to pull to the left or right.
- ▷ Uneven wear pattern, e.g., increased wear in the area of the tire shoulder.

Damage can be caused by the following situations, for instance:

- ▷ Driving over curbs.
- ▷ Road damage.
- ▷ Tire pressure too low.
- ▷ Vehicle overloading.
- ▷ Incorrect tire storage.

Safety information

Warning

Damaged tires can lose tire inflation pressure, which can lead to loss of vehicle control. There is a risk of accident, injury, and property damage. If tire damage is suspected while driving, immediately reduce speed and stop. Have wheels and tires checked. To do so, drive carefully to an authorized service center or another qualified service center or repair shop. Have the vehicle towed or transported as needed. Do not repair damaged tires, but have them replaced.

Warning

The wheels, tires and chassis components can become damaged when driving over curbs, road damage, or other obstacles. Larger wheels have a smaller tire cross-section. The smaller the tire cross-section, the higher the risk of tire damage. There is a risk of accident, injury, and property damage. If possible, avoid driving over curbs, road damage or other obstacles, or drive over them slowly and carefully.

Exchanging wheels and tires

Mounting and wheel balancing

Have the wheel mounted and balanced by an authorized service center or another qualified service center or repair shop.

Suitable wheels and tires

General information

Only certain wheel/tire combinations are suitable depending on vehicle and equipment. The vehicle manufacturer determines wheel/tire combinations on the basis of the following criteria:

- ▷ Tire size, e.g., tire width, aspect ratio.
- ▷ Wheel size, e.g., rim diameter, offset.

For more information on wheel/tire combinations and special equipment, contact an authorized service center or another qualified service center or repair shop.

Safety information

Warning

Wheels and tires that are not suitable for the vehicle can damage parts of the vehicle. There is a risk of accident, injury, and property damage. The vehicle manufacturer recommends that you use only wheels and tires that have been recommended for the vehicle type.

Warning

Mounted steel wheels can cause technical problems, for instance unexpected loosening of the lug bolts and damage to the brake disks. There is a risk of accident, injury, and property damage. Do not mount steel wheels.

Warning

Wheel/tire combinations that are not suitable for the vehicle can affect vehicle handling and a number of system functions, e.g., the Antilock Braking System or Dynamic Stability Control. There is a risk of accident, injury, and property damage. The manufacturer of the vehicle recommends that you use wheels and tires that have been recommended by the vehicle manufacturer for the vehicle type. Following tire damage, have the original wheel/tire combination remounted on the vehicle as soon as possible.

Warning

Unsuitable wheel studs such as single-section wheel studs may loosen or come off. The wheel may come loose while driving. There is a risk of accident, injury, and property damage. Use only two-section wheel studs that

are recommended by the manufacturer of the vehicle for the respective wheel type.

Recommended tire brands



Tire types are developed for each vehicle and optimized specifically for the individual requirements of that vehicle, e.g.:

- ▷ Vehicle handling.
- ▷ Comfort.
- ▷ Noise characteristics.

Specially developed tires are marked with a star on the tire sidewall. After replacing wheels and tires, the vehicle manufacturer recommends using star-marked tires again. The vehicle manufacturer recommends that you use tires of the same make and tread design.

New tires

Tire traction is not optimal due to manufacturing circumstances when tires are brand new.

Drive conservatively for the first 200 miles/300 km.

Retreaded tires

Warning

Retreaded tires can have different tire casing structures. With advanced age the service life can be limited. There is a risk of accident, injury, and property damage. The manufac-

turer of the vehicle does not recommend the use of retreaded tires.

Maximum speed

Safety information

Warning

If the maximum permissible speed of your mounted tires is exceeded, the tires may be damaged. There is a risk of accident, injury, and property damage. Do not exceed the maximum permissible speed of the tires.

Maximum speed of winter tires

If the maximum speed of the vehicle is higher than the maximum permissible speed of the winter tires, the maximum permissible speed must be indicated with a sign placed in the field of vision. The info label is available from an authorized service center or another qualified service center or repair shop.

Winter tires



Winter tires are recommended for operating on winter roads.

Winter tires can be identified by the mountain/snowflake icon and the letters M+S on the tire sidewall.

So-called all-season tires with M+S marking but without mountain and snowflake icon have better winter properties than summer tires.

As a rule, all-season tires do not perform the same as winter tires.

Changing runflat tires

When changing from runflat tires to standard tires, it must be ensured that the vehicle contains an emergency wheel or tire mobility kit. For more information, contact an authorized service center or another qualified service center or repair shop.

Wheel change between axles

Warning

A wheel change between the axles on vehicles with different tire sizes or rim sizes on the front and rear axles can cause damage to the tires and the vehicle. There is a risk of accident, injury, and property damage. Do not rotate the tires between the axles on vehicles with different tire sizes or rim sizes on the front and rear axles.

Different abrasion patterns can occur on the front and rear axles depending on individual driving conditions. The tires can be rotated in pairs between the axles to achieve even abrasion. For more information, contact an authorized service center or another qualified service center or repair shop. After changing, check the tire pressure and correct, if needed.

Storing tires

Tire pressure

Do not exceed the maximum tire inflation pressure indicated on the tire sidewall.

Storage

- ▶ Store wheels and tires in a cool, dry and dark place.
- ▶ Always protect tires against all contact with oil, grease, and solvents.

- ▷ Do not leave the tires in plastic bags.
- ▷ Remove dirt from wheels or tires.

Runflat tires

Principle

Runflat tires permit continued driving under limited conditions even in the event of a complete tire pressure loss.

General information

The wheels consist of tires that are self-supporting to a limited degree and may also include special rims.

The reinforcement of the sidewall allows the tire to remain drivable to a limited degree in the event of a tire pressure loss.

Follow the instructions for continued driving with a flat tire.

Safety information

Warning

The vehicle handles differently when a runflat tire has insufficient or no tire pressure; for instance, reduced directional stability when braking, braking distances are longer and the self-steering properties will change. There is a risk of accident, injury, or property damage. Drive moderately and do not exceed a speed of 50 mph/80 km/h.

Warning

Heavy trailers can start swinging when continuing to drive with a flat tire. There may be a risk of accidents or risk of damage to property. Do not exceed a speed of 35 mph/60 km/h when driving with a trailer and a flat tire. If the trailer swings or snakes, brake immediately and apply neces-

sary steering corrections as carefully as possible.

Warning

Vibrations or loud noises while driving can indicate the final failure of a tire. Tire components may come loose. There is a risk of accident, injury, or property damage. Reduce your speed and stop. Do not continue driving. Contact an authorized service center or another qualified service center or repair shop.

Identification



Runflat tires are labeled with a circular icon containing the letters RSC marked on the tire sidewall.

Repairing a flat tire

Safety precautions

- ▷ Park the vehicle on solid and non-slip ground at a safe distance from road traffic.
- ▷ Turn on the hazard warning system.
- ▷ Set the parking brake.
- ▷ Turn the steering wheel until the front wheels are in the straight-ahead position and engage the steering wheel lock.
- ▷ As soon as permitted by the traffic flow, have all vehicle occupants get out and

make sure that they remain outside the hazardous area such as behind a guardrail.

- ▶ If necessary, set up the hazard triangle or hazard warning lights at an appropriate distance.

Tire repair set

Principle

The tire repair set is used to temporarily seal minor tire damage so that it is possible to continue driving.

General information

- ▶ The filled in tire sealant closes the damage from the inside when it hardens.
- ▶ Follow the instructions for using the tire repair set, which are provided on the compressor and sealant bottle.
- ▶ The tire repair set may be insufficient if the tire damage measures more than approx. 0.16 in/4 mm.
- ▶ Do not remove foreign objects that have penetrated the tire. Remove foreign objects only when they are visibly protruding from the tire.
- ▶ The compressor can be used to check the tire inflation pressure.

Overview

Storage

Depending on vehicle equipment, the tire repair set is stored as follows:

- ▶ In the cargo area under the cargo area floor.
- ▶ In the cargo area on the left or right side.
- ▶ In the cargo area behind a side trim panel.

Sealant bottle and filler hose

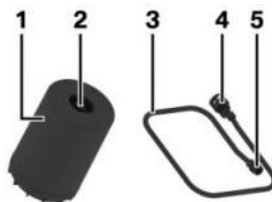

- 1 Sealant bottle
- 2 Sealant bottle outlet
- 3 Filler hose
- 4 Sealant bottle connection
- 5 Wheel valve connection

Compressor

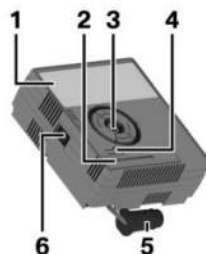

- 1 Compressor
- 2 Tire pressure display
- 3 Sealant bottle mount
- 4 Pressure reducing valve button
- 5 Connector for socket
- 6 Power switch

Safety precautions

- ▶ Park the vehicle as far away as possible from passing traffic and on solid ground.
- ▶ Turn on the hazard warning system.
- ▶ Set the parking brake.

- ▶ Turn the steering wheel until the front wheels are in the straight-ahead position and engage the steering wheel lock.
- ▶ As soon as permitted by the traffic flow, have all vehicle occupants get out and make sure that they remain outside the hazardous area such as behind a guardrail.
- ▶ If necessary, set up the hazard triangle or hazard warning lights at an appropriate distance.
- ▶ Remove the warning label for the maximum permissible speed from the sealant bottle and attach it in the visible area in the vehicle interior.

Preparing the tire repair set

1. Insert the sealant bottle into the mount on the housing of the compressor.



2. Turn the sealant bottle clockwise by 90° to the stop.

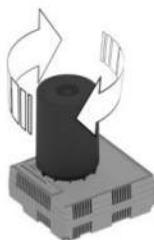

3. Connect the filler hose to the outlet of the sealant bottle and turn clockwise by 90° to the stop.



4. Unscrew the valve cap on the wheel.
5. Screw the filler hose connector clockwise onto the valve.

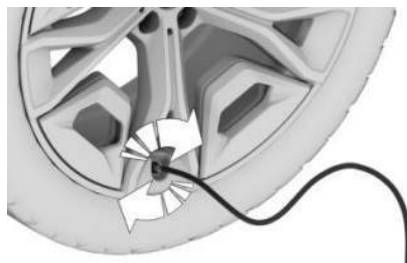

6. With the compressor switched off, insert the connector into the power socket in the vehicle interior.

Filling the tire with sealing compound

Safety information

DANGER

If the exhaust pipe is blocked or ventilation is insufficient, harmful exhaust gases can penetrate the vehicle. The exhaust gases contain pollutants which are colorless and odorless. In enclosed areas, exhaust gases can also accumulate outside of the vehicle. There is a danger to life. Keep the exhaust pipe free and ensure sufficient ventilation.

NOTICE

The compressor can overheat during extended operation. There is a risk of property damage. Do not run the compressor for more than 10 minutes.

Filling the tire with sealing compound

1. With standby state or drive-ready state on, turn on the compressor on the device.
Let the compressor run for max. 10 minutes to fill in the tire sealant and reach a tire pressure of 2.5 bar/36 psi.
While the tire is being filled with tire sealant, the tire pressure can briefly reach approx. 6 bar/87 psi. Do not turn off the compressor in this phase.
2. Turn off the compressor on the device.

Checking the tire pressure

Read the tire pressure on the tire pressure display of the compressor. The tire pressure must be at least 2.5 bar/36 psi.

Tire pressure too high

If the tire pressure is too high, reduce the tire pressure with the pressure reducing valve on the compressor.

Minimum tire inflation pressure is not reached

Do not continue driving unless a minimum tire pressure of 2.5 bar/36 psi is reached. Contact an authorized service center or another qualified service center or repair shop.

Minimum tire inflation pressure is reached

1. Pull the connector out of the socket in the vehicle interior.
2. Disconnect the filler hose from the sealant bottle and the valve on the wheel.

3. Screw the valve cap onto the valve.
4. Stow the tire repair set in the cargo area.
5. Immediately drive 6 miles/10 km to ensure that the tire sealant is evenly distributed in the tire.

Do not exceed the speed limit of 50 mph/80 km/h.

If possible, do not drive at speeds less than 12 mph/20 km/h.

Tire sealant may spray from the damaged area during the initial wheel rotations.

Adjusting the tire pressure

1. Stop at a suitable location.
2. Connect the filler hose directly to the compressor, then turn it clockwise 90° in the mount until it engages audibly.
3. Unscrew the valve cap on the wheel.
4. Screw the filler hose connector onto the valve.

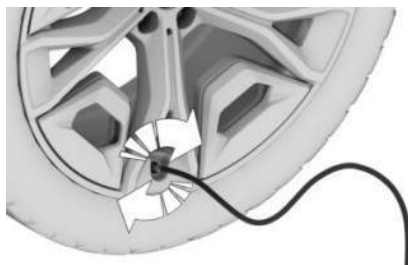

5. Insert the connector into the socket in the vehicle interior.
6. Read the tire pressure on the tire pressure display of the compressor.
Do not continue driving unless a minimum tire pressure of 1.3 bar/19 psi is displayed. Contact an authorized service center or another qualified service center or repair shop.
7. Correct the tire pressure to 2.5 bar/36 psi.
 - ▶ Increase tire pressure: with standby or drive-ready state turned on, turn on the

compressor and let it run for a maximum of 10 minutes.

- ▶ Reduce tire pressure: Press the pressure reducing valve button on the compressor.

Removing and stowing the tire repair set

1. Switch off the compressor.
2. Pull the connector out of the socket in the vehicle interior.
3. Disconnect the filler hose from the compressor and the valve on the wheel.
4. Screw the valve cap onto the valve.
5. Stow the tire repair set together with the filler hose in the cargo area.

Continuing the trip

Do not exceed the speed limit of 50 mph/80 km/h.

Do not exceed a maximum distance traveled of 125 miles/200 km.

Re-initialize the flat tire monitor or reset the Tire Pressure Monitor.

Replace the faulty tire and the sealant bottle from the tire repair set as soon as possible.

Additional information:

- ▶ Flat tire monitor, refer to page [370](#).
- ▶ Tire pressure monitor, refer to page [362](#).

System limits

If the tire cannot be made drivable, contact an authorized service center or another qualified service center or repair shop.

With Tire Pressure Monitor: Using sealant can damage the air pressure sensor. In this case, have the electronics checked and replaced at the next opportunity.

Snow chains

Safety information

Warning

Mounting snow chains on unsuitable tires can cause the snow chains to come into contact with vehicle parts. There is a risk of accident, injury, and property damage. Only fit snow chains on tires recommended by the vehicle manufacturer for use with snow chains.

Warning

Insufficiently tight snow chains may damage tires and vehicle components. There is a risk of accident, injury, and property damage. Make sure that the snow chains are always sufficiently tight. Re-tighten as needed according to the snow chain manufacturer's instructions.

Fine-link snow chains

The manufacturer of the vehicle recommends the use of fine-link snow chains. Certain types of fine-link snow chains have been tested by the manufacturer of the vehicle and recommended as road-safe and suitable.

For information on suitable snow chains, contact an authorized service center or another qualified service center or repair shop.

Use

Use is only permitted in pairs on rear wheels equipped with the tires of the following wheel/tire sizes:

Tire size	Wheel size	Rim offset (IS)
255/55 R20	8.5J x 20	35

Information on the wheel size and rim offset is located on the inside of the wheel.

The list can also include wheel/tire sizes that are only suitable for certain models.

Information on wheels and tires approved for the vehicle can be requested from an authorized service center or another qualified service center or repair shop.

Follow the snow chain manufacturer's instructions.

If vehicle is equipped with Tire Pressure Monitor: When using snow chains, do not reset the Tire Pressure Monitor, otherwise, incorrect values may be displayed.

If vehicle is equipped with flat tire monitor: When using snow chains, do not initialize the flat tire monitor, otherwise, incorrect values may be displayed.

When driving with snow chains, activate the Dynamic Traction Control briefly to optimize the drive power.

Maximum speed with snow chains

Do not exceed a speed of 30 mph/50 km/h when using snow chains.

Rear-wheel steering during operation with snow chains

General information

In order to guarantee free movement of the wheels when operating with snow chains, rear-wheel steering must be turned off when snow chains are mounted.

Rear-wheel steering is switched on again automatically when the permitted maximum speed for snow chains is exceeded: 30 mph/50 km/h.

The setting for equipped snow chains can only be used below 30 mph/50 km/h.

Safety information

Warning

When rear-wheel steering is switched on and snow chains are mounted, there can be contact between snow chains and the body. There is a risk of accident, injury, and property damage. With mounted snow chains, switch off the rear-wheel steering.

Switching off rear-wheel steering

The rear-wheel steering is switched off by specifying that snow chains are installed.

1.  Apps menu
2. "Vehicle"
3. "Driving settings"
4. "Drivetrain and chassis"
5. "Snow chains"

Tire pressure monitor

Principle

The Tire Pressure Monitor monitors the tire pressure and issues a warning if the tire pressure has dropped.

General information

Sensors in the tire valves measure the tire inflation pressure and tire temperature.

Depending on the tires detected or registered, the system displays the specified nominal pressures on the control display and compares them with the current tire pressures.

If tires are being used that are not specified in the tire inflation pressure details on the vehicle such as tires with special approval, the system needs to be actively reset. The system will then take over the actual tire inflation pressures as the target pressures.

When operating the system, also note the information found in the Tire inflation pressure chapter.

Additional information:

Tire inflation pressure, refer to page 348.

Safety information

Warning

The display of the target pressures is not a substitute for the tire inflation pressure details on the vehicle. Incorrect entries in the tire settings can lead to incorrect target tire inflation pressure values. In this case, it cannot be guaranteed that the notification of a tire pressure loss will be reliable. There is a risk of injury and risk of property damage. Make sure that the sizes of your mounted tires are displayed correctly and match the information on the tires and the tire inflation pressure specifications on the vehicle.

Functional requirements

The following prerequisites must be met for the system; otherwise, reliable notification of a tire pressure loss is not assured:

- ▶ After each tire or wheel change, the system detects and updates the mounted tires on the control display and displays them after a short trip.

Enter the information about the mounted tires in the tire settings when the system does not automatically detect the tires.

- ▶ The Tire Pressure Monitor does not activate until after driving for a few minutes:
 - ▶ After a tire or wheel change.
 - ▶ After a reset, when using tires with special approval.
 - ▶ After changing the tire setting.
- ▶ For tires with special approval:

- ▶ After a tire or wheel change, a reset was performed with the correct tire inflation pressure.
- ▶ After the tire inflation pressure was adjusted to a new value, a reset was performed.
- ▶ Wheels with air pressure sensor.

Tire settings

General information

The information about the mounted tires can be entered in the tire settings if the system does not automatically detect the tires.

The tire sizes of the mounted tires can be gathered from the tire inflation pressure details on the vehicle or directly on the tires.

The tire details do not need to be re-entered when the tire pressure is corrected.

For summer and winter tires, the tire details entered last are stored. After a tire or wheel change, the settings of the tire sets used last can be selected.

Adjusting the tires

1.  Apps menu
2. "Vehicle"
3. "Vehicle status"
4. "Tire Pressure Monitor"
5. "Tire settings"
6. "Tire selection"
7. "Manual"
8. "Tire type"
9. Select the tire size for the rear axle.
For tires with special approval:
"Other tires"
Observe further proceeding in the perform a reset section.
10. Select the maximum speed to be driven.
11. "Save tire settings"

The measurement of the current tire inflation pressure is started. The measurement progress is displayed.

Status display

Current status

The system status can be displayed on the control display, e.g., whether or not the system is active.

1.  Apps menu
2. "Vehicle"
3. "Vehicle status"
4. "Tire Pressure Monitor"

The current status is displayed.

Current tire pressure

The current tire pressure is displayed for each tire.

The current tire inflation pressures may change while driving or depending on the outside temperature.

Current tire temperature

The current tire temperatures are displayed depending on the model.

The current tire temperatures may change while driving or due to the outside temperature.

Nominal pressure

The nominal pressure for the tires on the front and rear axles is displayed.

The specified nominal pressures take the influence of driving and outside temperature on the tire temperature into account. The appropriate nominal pressure is always displayed, independent of the weather situation, tire temperatures and travel times.

The displayed nominal pressure may change and may differ from the tire inflation pressure details on the door pillar of the driver's door.

The tire inflation pressure can thus be corrected to the value of the displayed target pressures.

The nominal pressure is immediately adjusted if the vehicle load state is changed in the tire settings.

Tire conditions

General information

Tire and system status are indicated by the color of the wheels and a text message on the control display.

Any existing messages may not be deleted if the nominal pressure is not reached after the tire inflation pressure is corrected.

All wheels green

- ▶ The system is active and bases warnings on the target pressures.
- ▶ For tires with special approval: the system is active and bases warnings on the tire inflation pressures stored during the last reset.

One to four yellow wheels

A flat tire or major tire pressure loss has occurred in the indicated tires.

Gray wheels

It may not be possible to identify tire pressure losses.

Possible causes:

- ▶ Malfunction.
- ▶ During tire inflation pressure measurement, after confirmation of the tire settings.
- ▶ For tires with special approval: a reset is performed for the system.

For tires with special approval: performing a reset

1.  Apps menu
2. "Vehicle"
3. "Vehicle status"
4. "Tire Pressure Monitor"
5. Make sure that the tire settings are correct.
Tire settings, refer to page 363.
6. Turn on drive-ready state and do not drive off.
7. "Perform reset".
8. Drive off.

The wheels are shown in gray and the tire pressure is reset.

After a travel time of several minutes, the set tire inflation pressures are accepted as the predefined tire inflation pressures. The reset is completed automatically while driving.

After resetting, the wheels are shown in green on the control display and a message appears. You may interrupt this trip at any time. When you continue driving the reset resumes automatically.

Messages: for tires without special approval

General information

When a flat tire is indicated, the Dynamic Stability Control may be turned on.

Safety information

Warning

A damaged regular tire with low or no tire inflation pressure impacts handling such as steering and braking response. Runflat tires can maintain limited stability. There is a risk of accident. Do not continue driving if the vehicle is equipped with normal tires. Follow

the information on runflat tires and continued driving with these tires.

If a tire inflation pressure check is required

Message

An icon with a Check Control message appears on the control display.

Icon	Possible cause
	Leak detected on the tire. Inflation was not carried out according to specifications, for instance when the tire has not been sufficiently inflated or in the case of a natural steady tire pressure loss.

Measure

Check the tire pressure and correct as needed.

If the tire inflation pressure is too low

Message



A yellow warning light is illuminated in the instrument cluster.

In addition, an icon with a Check Control message appears on the control display.

Icon	Possible cause
	There is a tire pressure loss.

Measure

1. Reduce the vehicle speed. Do not exceed a speed of 80 mph/130 km/h.
2. At the next opportunity, for instance at a filling station, check the tire inflation pressure in all four tires and correct if necessary.

If there is a significant tire pressure loss

Message



A yellow warning light is illuminated in the instrument cluster.

In addition, an icon with the affected tire appears in a Check Control message on the control display.

Icon	Possible cause
------	----------------



There is a flat tire or a major tire pressure loss.

Measure

1. Reduce your speed and stop cautiously. Avoid sudden braking and steering maneuvers.
2. Check whether the vehicle is fitted with standard tires or runflat tires.
Runflat tires are labeled with a circular icon containing the letters RSC marked on the tire sidewall.
Runflat tires, refer to page [357](#).
3. Read the description on what to do in case of a flat tire.
Actions in the event of a flat tire, refer to page [367](#).

Messages: for tires with special approval

General information

When a flat tire is indicated, the Dynamic Stability Control may be turned on.

Safety information

Warning

A damaged regular tire with low or no tire inflation pressure impacts handling such as steering and braking response. Runflat tires can maintain limited stability. There is a risk of accident. Do not continue driving if the vehicle is equipped with normal tires. Follow the information on runflat tires and continued driving with these tires.

If a tire inflation pressure check is required

Message

An icon with a Check Control message appears on the control display.

Icon	Possible cause
------	----------------



Inflation was not carried out according to specifications, e.g., the tire has not been sufficiently inflated.

The system has detected a wheel change, but no reset was done.

The tire inflation pressure has fallen below the level of the last reset.

No reset was performed for the system. The system issues a warning based on the tire inflation pressures stored during the last reset.

Measure

1. Check the tire pressure and correct as needed.
2. Perform a system reset.

If the tire inflation pressure is too low

Message



A yellow warning light is illuminated in the instrument cluster.

In addition, an icon with a Check Control message appears on the control display.

Icon	Possible cause
	<p>There is a tire pressure loss.</p> <p>No reset was performed for the system. The system issues a warning based on the tire inflation pressures stored during the last reset.</p>



There is a tire pressure loss.

No reset was performed for the system. The system issues a warning based on the tire inflation pressures stored during the last reset.

Measure

1. Reduce the vehicle speed. Do not exceed a speed of 80 mph/130 km/h.
2. At the next opportunity, for instance at a filling station, check the tire inflation pressure in all four tires and correct if necessary.
3. Perform a system reset.

If there is a significant tire pressure loss

Message



A yellow warning light is illuminated in the instrument cluster.

In addition, an icon with the affected tire appears in a Check Control message on the control display.

Icon	Possible cause
	<p>There is a flat tire or a major tire pressure loss.</p> <p>No reset was performed for the system. The system issues a warning based on the tire inflation pressures stored during the last reset.</p>



There is a flat tire or a major tire pressure loss.

No reset was performed for the system. The system issues a warning based on the tire inflation pressures stored during the last reset.

Measure

1. Reduce your speed and stop cautiously. Avoid sudden braking and steering maneuvers.
2. Check whether the vehicle is fitted with standard tires or runflat tires.

Runflat tires are labeled with a circular icon containing the letters RSC marked on the tire sidewall.

Runflat tires, refer to page [357](#).

3. Read the description on what to do in case of a flat tire.

Actions in the event of a flat tire, refer to page [367](#).

Actions in the event of a flat tire

Standard tires

1. Identify the damaged tire.

Check the tire pressure in all four tires, for instance using the tire pressure display of a flat tire kit.

For tires with special approval: when the tire pressure in all four tires is correct, the Tire Pressure Monitor may not have been reset. In this case, perform the reset.

If no tire damage can be identified, contact an authorized service center or another qualified service center or repair shop.

2. Repair the flat tire, e.g., with a flat tire kit or by changing the wheel.

Using sealant, e.g., from the flat tire kit, may damage the air pressure sensor. Replace the air pressure sensor at the next opportunity.

Runflat tires

Safety information

Warning

The vehicle handles differently when a runflat tire has insufficient or no tire pressure; for instance, reduced directional stability when braking, braking distances are longer and the self-steering properties will change. There is a risk of accident, injury, or property damage. Drive moderately and do not exceed a speed of 50 mph/80 km/h.

Warning

Heavy trailers can start swinging when continuing to drive with a flat tire. There may be a risk of accidents or risk of damage to property. Do not exceed a speed of 35 mph/60 km/h when driving with a trailer and a flat tire. If the trailer swings or snakes, brake immediately and apply necessary steering corrections as carefully as possible.

Warning

Vibrations or loud noises while driving can indicate the final failure of a tire. Tire components may come loose. There is a risk of accident, injury, or property damage. Reduce your speed and stop. Do not continue driving. Contact an authorized service center or another qualified service center or repair shop.

Maximum speed

You may continue driving with a damaged tire at speeds up to 50 mph/80 km/h.

Continued driving with a flat tire

Follow the following when continuing to drive with a damaged tire:

1. Avoid sudden braking and steering maneuvers.
2. Do not exceed a speed of 50 mph/80 km/h.
3. Check the tire inflation pressure in all four tires at the next opportunity.

Possible driving distance with a flat tire

The possible driving distance which may be safely traveled varies depending on how the vehicle is loaded and used, e.g., speed, road conditions, outside temperature. The distance traveled may be less but may also be more if an economical driving style is used.

If the vehicle is loaded with an average weight and used under favorable conditions, the possible distance traveled may be up to 50 miles/80 km.

Vehicle handling with damaged tires

Vehicles driven with a damaged tire will handle differently, potentially leading to conditions such as the following:

- ▶ Greater likelihood of skidding of the vehicle.
- ▶ Longer braking distances.
- ▶ Changed self-steering properties.

Modify your driving style. Avoid abrupt steering or driving over obstacles, for instance curbs or potholes.

System limits

Temperature

The tire inflation pressure depends on the tire's temperature.

Driving or exposure to the sun will increase the tire temperature, thus increasing the tire inflation pressure.

The tire inflation pressure is reduced when the tire temperature falls again.

These circumstances may cause a warning when temperatures fall very sharply.

Following a temperature-related warning, the target pressures are displayed on the control display again after a short distance.

Sudden tire pressure loss

The system cannot indicate sudden and serious tire damage caused by external circumstances.

Failure performing a reset

Tires with special approval: the system will not function correctly if a reset was not performed, for example a flat tire may be indicated although the tire inflation pressures are correct.

Malfunction

Message



The yellow warning light flashes and is then illuminated continuously. A Check Control message is displayed. It may not be possible to identify tire pressure losses.

Measure

- ▶ A wheel without air pressure sensor is mounted: Have the wheels checked as needed.
- ▶ Fault caused by systems or devices with the same transmission frequency: The system automatically reactivates after leaving the area of the interference.
- ▶ For tires with special approval: the system was unable to complete the reset. Perform a system reset again.
- ▶ If the Tire Pressure Monitor malfunctions: Have the vehicle checked by an authorized service center or another qualified service center or repair shop.

Declaration according to NHTSA/FMVSS 138 Tire Pressure Monitoring System

Each tire, including the spare (if provided) should be checked monthly when cold and inflated to the inflation pressure recommended by the vehicle manufacturer on the vehicle placard or tire inflation pressure label. (If the vehicle has tires of a different size than the size indicated on the vehicle placard or tire inflation pressure label, you should determine the proper tire inflation pressure for those tires.) As an added safety feature, the vehicle has been equipped with a tire pressure monitoring system (TPMS) that illuminates a low tire pressure telltale when one or more of your tires is significantly under-inflated. Accordingly, when the low tire pressure telltale illuminates, you should stop and check your tires as soon as possible, and inflate them to the proper pressure. Driving on a significantly under-inflated tire causes the tire to overheat and can lead to tire failure. Under-inflation also reduces fuel efficiency and tire tread life, and may affect the vehicle's handling and stopping ability. Please note that the TPMS is not a substitute for proper tire maintenance, and it is the driver's responsibility to maintain correct tire pressure, even if under-inflation has not reached the level to trigger illumination of the TPMS low tire pressure telltale. The vehicle has also been equipped with a TPMS malfunction indicator to indicate when the system is not operating properly. The TPMS malfunction indicator is combined with the low tire pressure telltale. When the system detects a malfunction, the telltale will flash for approximately one minute and then remain continuously illuminated. This sequence will continue upon subsequent vehicle start-ups as long as the malfunction exists. When the malfunction indicator is illuminated, the system may not be able to detect or signal low tire pressure as intended. TPMS malfunctions may occur for a variety of reasons, including the installation of replacement or alternate tires or wheels on the

vehicle that prevent the TPMS from functioning properly. Always check the TPMS malfunction telltale after replacing one or more tires or wheels on the vehicle to ensure that the replacement or alternate tires and wheels allow the TPMS to continue to function properly.

Flat tire monitor

Principle

The flat tire monitor detects a tire pressure loss while driving and issues a warning if the tire pressure has dropped.

General information

The system detects tire pressure loss on the basis of rotation speed differences between the individual wheels while driving.

In the event of a tire pressure loss, the diameter and therefore the rate of rotation of the corresponding wheel changes. The difference will be detected and reported as a flat tire.

The system does not measure the actual inflation pressure in the tires.

Functional requirements

The following prerequisites must be met for the system; otherwise, reliable notification of a tire pressure loss is not assured:

- ▷ After a tire or wheel change, an initialization was carried out at the correct tire pressure.
- ▷ After the tire pressure was adjusted to a new value, an initialization was performed.

Status display

The current status of the flat tire monitor can be displayed, e.g., whether the flat tire monitor is active.

1.  Apps menu
2. "Vehicle"

3. "Vehicle status"
4. "FLAT TIRE MONITOR"

The status is displayed.

Initialization required

An initialization must be performed in the following situations:

- ▷ After the tire inflation pressure has been adjusted.
- ▷ After a tire or wheel change.

Performing initialization

When initializing, the set tire inflation pressures serve as reference values in order to detect a flat tire. Initialization is started by confirming the tire inflation pressures.

Do not initialize the system when driving with snow chains.

1.  Apps menu
2. "Vehicle"
3. "Vehicle status"
4. "FLAT TIRE MONITOR"
5. Turn on drive-ready state and do not drive off.
6. "Perform reset"
7. Drive off.

The initialization is completed while driving, which can be interrupted at any time.

The initialization automatically continues when driving continues.

Messages

General information

When a flat tire is indicated, the Dynamic Stability Control (DSC) is turned on, if needed.

Safety information

Warning

A damaged regular tire with low or no tire inflation pressure impacts handling such as steering and braking response. Runflat tires can maintain limited stability. There is a risk of accident. Do not continue driving if the vehicle is equipped with normal tires. Follow the information on runflat tires and continued driving with these tires.

Indication of a flat tire



A yellow warning light is illuminated in the instrument cluster.

In addition, an icon with a Check Control message appears on the control display.

Icon	Possible cause
	There is a flat tire or a major tire pressure loss.

Measure

1. Reduce your speed and stop cautiously. Avoid sudden braking and steering maneuvers.
2. Check whether the vehicle is fitted with standard tires or runflat tires.
Runflat tires are labeled with a circular icon containing the letters RSC marked on the tire sidewall.
Runflat tires, refer to page 357.
3. Read the description on what to do in case of a flat tire.

Actions in the event of a flat tire

Standard tires

1. Identify the damaged tire.

To do this, check the tire pressure in all four tires, for instance using the tire pressure display of a flat tire kit.

When the tire inflation pressure in all four tires is correct, the flat tire monitor may not have been initialized. In this case, initialize the system.

If tire damage cannot be identified, contact an authorized service center or another qualified service center or repair shop.

2. Repair the flat tire, e.g., with a flat tire kit or by changing the wheel.

Runflat tires

Safety information

Warning

The vehicle handles differently when a runflat tire has insufficient or no tire pressure; for instance, reduced directional stability when braking, braking distances are longer and the self-steering properties will change. There is a risk of accident, injury, or property damage. Drive moderately and do not exceed a speed of 50 mph/80 km/h.

Warning

Heavy trailers can start swinging when continuing to drive with a flat tire. There may be a risk of accidents or risk of damage to property. Do not exceed a speed of 35 mph/60 km/h when driving with a trailer and a flat tire. If the trailer swings or snakes, brake immediately and apply necessary steering corrections as carefully as possible.

Warning

Vibrations or loud noises while driving can indicate the final failure of a tire. Tire components may come loose. There is a risk of accident, injury, or property damage. Reduce your speed and stop. Do not continue driving. Contact an authorized service center or another qualified service center or repair shop.

Maximum speed

You may continue driving with a damaged tire at speeds up to 50 mph/80 km/h.

Continued driving with a flat tire

Follow the following when continuing to drive with a damaged tire:

1. Avoid sudden braking and steering maneuvers.
2. Do not exceed a speed of 50 mph/80 km/h.
3. Check the tire inflation pressure in all four tires at the next opportunity.

When the tire inflation pressure in all four tires is correct, the flat tire monitor may not have been initialized. In this case, initialize the system.

Possible driving distance with a flat tire

The possible driving distance which may be safely traveled varies depending on how the vehicle is loaded and used, e.g., speed, road conditions, outside temperature. The distance traveled may be less but may also be more if an economical driving style is used.

If the vehicle is loaded with an average weight and used under favorable conditions, the possible distance traveled may be up to 50 miles/80 km.

Vehicle handling with damaged tires

Vehicles driven with a damaged tire will handle differently, potentially leading to conditions such as the following:

- ▶ Greater likelihood of skidding of the vehicle.
- ▶ Longer braking distances.
- ▶ Changed self-steering properties.

Modify your driving style. Avoid abrupt steering or driving over obstacles, for instance curbs or potholes.

System limits

The system may be delayed or malfunction in the following situations:

- ▶ A natural, even tire pressure loss in all four tires will not be recognized. Therefore, check the tire inflation pressure regularly.
- ▶ Sudden and serious tire damage caused by external circumstances cannot be recognized in advance.
- ▶ The system has not been initialized.
- ▶ When driving on a snowy or slippery road.
- ▶ Sporty driving style: slip on traction wheels, high lateral acceleration (drifting).
- ▶ When driving with snow chains.

Changing wheels/tires**General information**

When using run-flat tires or a tire repair set, wheels do not always need to be changed immediately if the vehicle has broken down because the flat tire has caused a tire pressure loss.

If necessary, a suitable wheel change tool, e.g., a jack, is available as an accessory from an authorized service center or another qualified service center or repair shop.

Safety information

Warning

The jack is only provided for short-term lifting of the vehicle for wheel changes. Even if all safety precautions are observed, there is a risk of the raised vehicle falling if the jack tips over. There is a risk of injury or danger to life. When the vehicle is raised with the jack, do not lie under the vehicle and do not switch on the drive-ready state.

Warning

Placing supports, e.g., wooden blocks or similar, under the jack may reduce its ability to bear weight because of the limited height. The load-carrying capacity of the wooden blocks may be exceeded and the vehicle may tip over. There is a risk of injury or danger to life. Do not place supports under the jack.

Warning

The jack, issued by the vehicle manufacturer, is provided in order to perform a wheel change in the event of a breakdown. The jack is not designed for frequent use, e.g., changing from summer to winter tires. Using the jack frequently may cause it to become jammed or damaged. There is a risk of injury and risk of property damage. Only use the jack to change an emergency or spare wheel in the event of a breakdown.

Warning

The jack may slip on soft, uneven, or slippery ground, e.g., snow, ice, tiles, etc. There is a risk of injury. If possible, change the wheel on a flat, solid, slip-resistant surface.

Warning

The jack is optimized for lifting the vehicle and for the jacking points on the vehicle only. There is a risk of injury. Do not lift any other vehicle or cargo using the jack.

Warning

When the jack is not inserted into the jacking point provided for this purpose, the vehicle may be damaged or the jack may slip when it is being cranked up. There is a risk of injury or risk of damage to property. When cranking up the jack, ensure that it is inserted in the jacking point next to the wheel well.

Warning

A vehicle that is raised on a jack may fall off of the jack if lateral forces are exerted on it. There is a risk of injury and risk of property damage. While the vehicle is raised, do not exert lateral effort on the vehicle or pull abruptly on the vehicle. Have a stuck wheel removed by an authorized service center or another qualified service center or repair shop.

NOTICE

Using an impact wrench to loosen or tighten the wheel lock bolt can damage the wheel lock bolt. There is a risk of property damage. Only use a lug wrench to loosen and tighten the wheel lock bolt.

Securing the vehicle against rolling away

General information

The vehicle manufacturer recommends to additionally secure the vehicle against rolling away when changing a wheel.

On a level surface



Place chocks or other suitable objects in front and behind the wheel that is diagonal to the wheel being changed.

On a slight downhill gradient



If it is necessary to change a wheel on a slight downhill gradient, place chocks and other suitable objects, e.g., rocks, under the wheels of the front and rear axles, against the direction that the vehicle will move.

Lug bolt lock

Principle

The wheel lug bolts have a special coding. The lug bolts can only be released with the adapter which matches the coding.

Overview

Depending on vehicle equipment, store the lug bolt lock adapter as follows:

- ▷ In the cargo area under the cargo area floor.
- ▷ In the cargo area on the left or right side.
- ▷ In the cargo area behind a side trim panel.

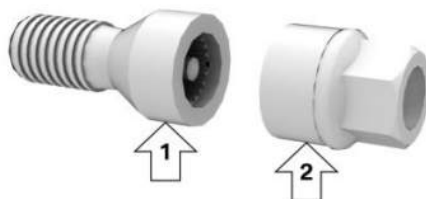

- ▷ Lug lock bolt, arrow 1.
- ▷ Adapter, arrow 2.

Unscrewing

1. Attach the adapter to the lug lock bolt.
2. Unscrew the lug lock bolt.
3. Remove the adapter after unscrewing the lug bolt.

Screwing on

1. Attach the adapter to the lug lock bolt. Turn the adapter until it fits onto the wheel lock bolt.
2. Screw on the lug lock bolt. The tightening torque is 101 lbs ft/140 Nm.
3. Remove the adapter and stow it after screwing on the lug bolt.

Safety precautions

- ▷ Park the vehicle on solid and non-slip ground at a safe distance from road traffic.
- ▷ Turn on the hazard warning system.
- ▷ Set the parking brake.
- ▷ Turn the steering wheel until the front wheels are in the straight-ahead position and engage the steering wheel lock.
- ▷ Engage a gear or move the selector lever to position P.
- ▷ As soon as permitted by the traffic flow, have all vehicle occupants get out and make sure that they remain outside the hazardous area such as behind a guardrail.
- ▷ If necessary, set up the hazard triangle or hazard warning lights at an appropriate distance.
- ▷ Depending on vehicle equipment, remove the wheel change set and, if necessary, the emergency wheel from the vehicle.
- ▷ Secure the vehicle additionally against rolling away.
- ▷ Loosen the lug bolts a half turn.
- ▷ For air suspension: disable the air suspension level adjustment.
Two-axle ride level control, refer to page 279.

Jacking points

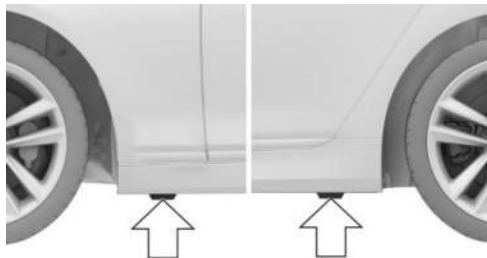

The jacking points are located at the indicated positions.

Jacking up the vehicle

Warning

Hands and fingers can be jammed when using the jack. There is a risk of injury. Comply with the described hand position and do not change this position while using the jack.

1. Hold the vehicle jack with one hand, arrow 1, and grasp the jack crank handle or lever with your other hand, arrow 2.

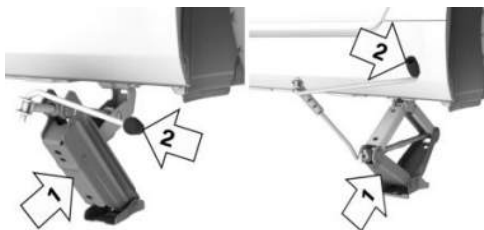

2. Insert the jack into the rectangular recess of the jacking point closest to the wheel to be changed.

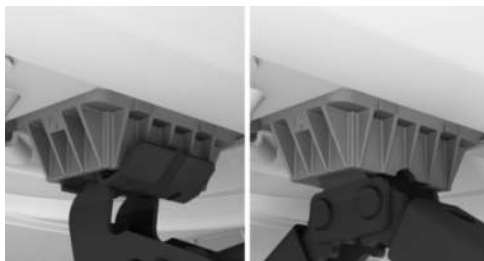

3. Extend the jack by turning the jack crank handle or lever clockwise.



- Take your hand away from the jack as soon as the jack is under load and continue turning the jack crank handle or lever with one hand.
- Make sure that the car jack foot extends vertically and is at a right angle beneath the jacking point.

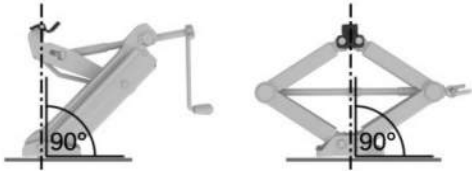

- Crank the vehicle up until the entire jack surface is on the ground and the corresponding wheel is lifted max. 1.2 inches/3 cm above the ground.

Mounting a wheel

Warning

Unsuitable wheel studs such as single-section wheel studs may loosen or come off. The wheel may come loose while driving. There is a risk of accident, injury, and property damage. Use only two-section wheel studs that are recommended by the manufacturer of the vehicle for the respective wheel type.

Mount one emergency wheel only, as required.

- Unscrew the lug bolts.
- Remove the wheel.
- Put the new wheel or emergency wheel on and screw in at least two lug bolts in a crosswise pattern until hand-tight.

When non-original light-alloy wheels of the vehicle manufacturer are mounted, the accompanying lug bolts may have to be used as well.

- Hand-tighten the remaining lug bolts and tighten all lug bolts well in a crosswise pattern.
- Turn the jack crank handle counterclockwise to retract the jack and lower the vehicle.
- Remove the jack and stow it securely.

After the wheel change

- Tighten the lug bolts crosswise. The tightening torque is 101 lbs ft/140 Nm.
- Stow the faulty wheel in the cargo area, if necessary.
- Check tire inflation pressure at the next opportunity and correct as needed.
- Re-initialize the flat tire monitor or reset the Tire Pressure Monitor.
- Check to make sure the lug bolts are tight with a calibrated torque wrench.
- Drive to the nearest authorized service center or another qualified service center or repair shop, then have the damaged tire replaced.

Emergency wheel

Principle

In the event of a flat tire, the emergency wheel can be used in place of the wheel with the faulty tire. The emergency wheel is only intended for temporary use until the faulty tire/wheel has been replaced.

General information

Mount one emergency wheel only.

Also check the tire inflation pressure of the emergency wheel in the cargo area regularly, and correct it as needed.

Safety information

Warning

The emergency wheel has particular dimensions. When driving with an emergency wheel, changed driving properties may occur, for instance reduced directional stability when braking, longer braking distance, and changed self-steering properties in the limit range. There is a risk of accident. Drive moderately and do not exceed a speed of 50 mph/80 km/h.

Overview

The emergency wheel and wheel change set are located in the cargo area under the cargo floor panel.

Removing the emergency wheel

1. Fold the rear seat backrests of the third seat rows down.
2. Fold up the cargo area floor to the end position. Make sure that the cargo floor panel is engaged.
3. Remove the cover, arrow 1. To do this, release the snap fastener, arrows 2, on both sides of the cover.

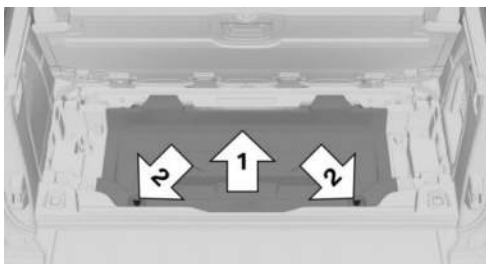

4. Slacken the luggage strap at the clasp, arrow 1, but do not release completely.

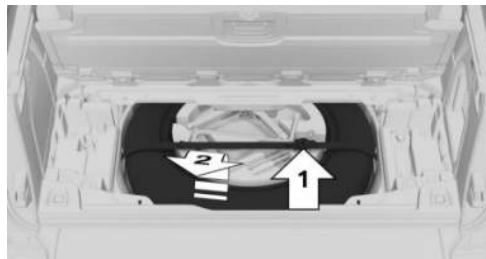

5. Pull the tensioning belt back, toward the loading edge trim, over the spare tire.
6. If necessary, open the lower tailgate.
7. Remove the emergency wheel with tool holder from the storage tray, arrow 2.

Inserting the emergency wheel

1. Fold up the cargo area floor.
2. If necessary, open the lower tailgate.
3. Place the emergency wheel with tool fixture into the storage tray.
4. Tie the luggage strap. Make sure that it is correctly and firmly seated.
5. Insert the cover and tighten the quick release fasteners.
6. Push the cargo floor panel downward.
7. If necessary, fold the rear seat backrest of the third seat row up.

Engine compartment

Vehicle features and options

This chapter describes model-specific equipment, systems, and functions that are currently

available, or may become available in the future, even if they are not present in the vehicle.

Additional information:

Vehicle equipment, refer to page 8.

Overview

Engines with 4 or 6 cylinders

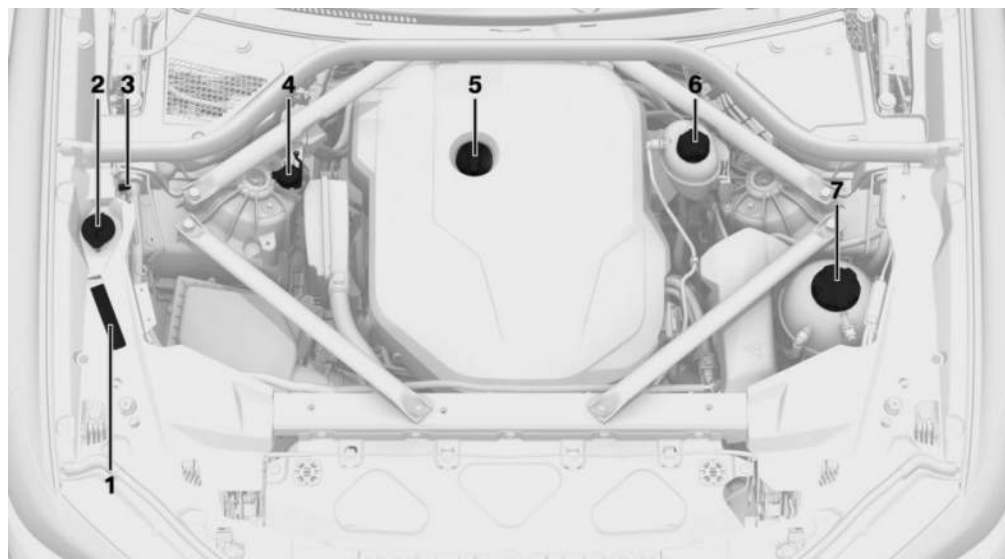

- | | | | |
|---|--|---|--------------------------------------|
| 1 | Vehicle identification number | 5 | Oil filler neck |
| 2 | Filler neck for washer fluid | 6 | Coolant reservoir, auxiliary cooling |
| 3 | Jump-starting, negative battery terminal | 7 | Coolant reservoir, engine |
| 4 | Jump-starting, positive battery terminal | | |

8-cylinder engine

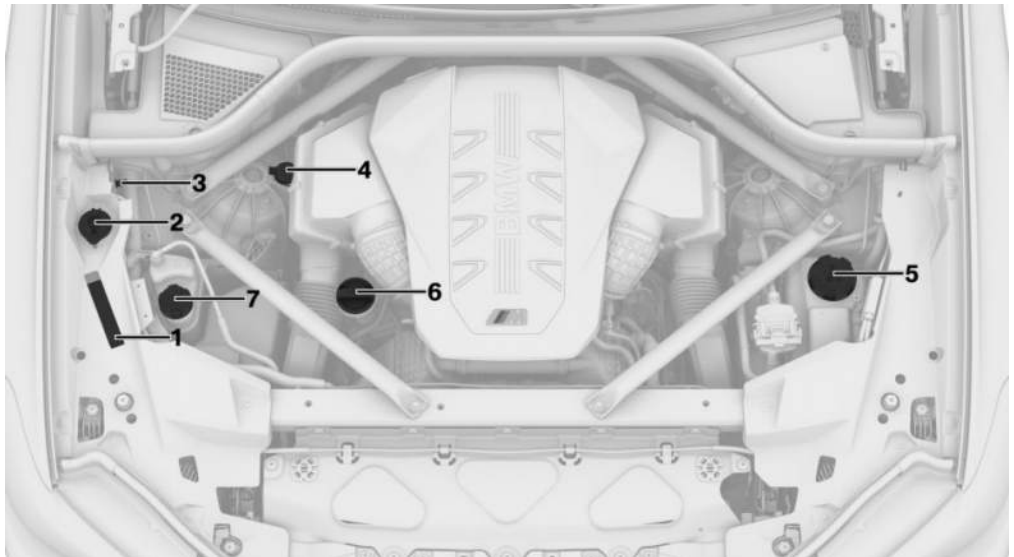

- | | |
|---|--|
| <ul style="list-style-type: none"> 1 Vehicle identification number 2 Filler neck for washer fluid 3 Jump-starting, negative battery terminal 4 Jump-starting, positive battery terminal | <ul style="list-style-type: none"> 5 Coolant reservoir, engine 6 Oil filler neck 7 Coolant reservoir, auxiliary cooling |
|---|--|

Hood

Safety information

Warning

Improperly executed work in the engine compartment can damage components and lead to a safety hazard. There is a risk of accident, injury, and property damage. The vehicle manufacturer recommends having work in the engine compartment performed by an authorized service center or another qualified service center or repair shop.

Warning

The engine compartment accommodates moving components. Certain components in the engine compartment can also move with the vehicle switched off, for instance the radiator fan. There is a risk of injury. Do not reach into the area of moving parts. Keep articles of clothing and hair away from moving parts.

Warning

There are protruding parts, for instance locking hooks, on the inside of the hood. There is a risk of injury. If the hood is open, pay attention to protruding parts and keep clear of these areas.

Warning

An incorrectly locked hood can open while driving and restrict visibility. There is a risk of accident, injury, and property damage. Stop immediately and correctly close the hood.

Warning

Body parts can be jammed when opening and closing the hood. There is a risk of injury. Make sure that the area of movement of hood is clear while opening and closing.

NOTICE

Folded-out wipers can be jammed when the hood is opened. There is a risk of property damage. Make sure that the wipers with the wiper blades mounted are folded down onto the windshield before opening the hood.

NOTICE

When the hood is closed, it must engage on both sides. Pressing again can damage the hood. There is a risk of property damage. Open the hood again and then close it energetically. Avoid pressing again.

Opening hood

1. Pull the lever, arrow 1.
Hood is unlocked.

An acoustic signal and a notice in the instrument cluster indicate that the hood is open.



2. Release the lever and pull it again, arrow 2.
Hood can be opened.
3. Be careful of protruding parts on the hood.

Closing the hood

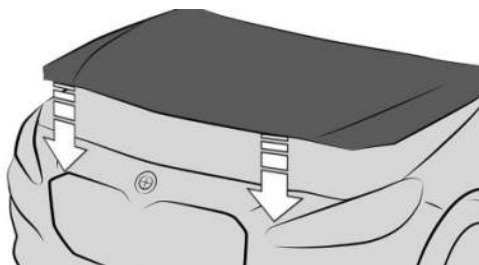

Energetically close the hood from approx. 20 in/50 cm.

The hood must engage on both sides.

Operating fluids

Vehicle features and options

This chapter describes model-specific equipment, systems, and functions that are currently available, or may become available in the future, even if they are not present in the vehicle.

Additional information:

Vehicle equipment, refer to page 8.

Fuel recommendation

General information

Depending on the region, many filling stations sell fuel that has been customized to winter or summer conditions. Fuel that is available in winter, for instance helps make a cold start easier.

Gasoline

General information

For the best fuel efficiency, the gasoline should be sulfur-free or very low in sulfur content.

Fuels that are marked on the gas pump as containing metal must not be used.

Fuels with a maximum ethanol content of 10 %, i.e., E10, may be used for refueling.

The power and consumption specifications refer to operating with RON 98 E10 fuel

Knocking noises and driving/acoustic problems may occur when using minimum quality fuel, e.g., 87 AKI, or fuel with an ethanol content of more than 10% to max. 15%. These have no effect on the engine service life.

Safety information

Caution

The use of poor-quality fuels may result in harmful engine deposits or damage. Additionally, problems relating to drivability, starting and stalling, especially under certain environmental conditions such as high ambient temperature and high altitude, may occur.

If drivability problems are encountered, we recommend switching to a high quality gasoline brand and a higher octane grade — AKI number — for a few tank fills. To avoid harmful engine deposits, it is highly recommended to purchase gasoline from Top Tier retailers.

Failure to comply with these recommendations may result in the need for additional maintenance.

Warning

Even small quantities of the wrong fuel or wrong fuel additives can damage the fuel system and engine. Furthermore, the catalytic converter can be permanently damaged. There is a risk of injury and risk of property damage. Do not refuel or add the following in the case of gasoline engines:

- ▷ Leaded gasoline.
- ▷ Metallic additives, for instance manganese or iron.

Do not turn on standby after refueling with the wrong fuel. Contact an authorized service center or another qualified service center or repair shop.

NOTICE

Fuel that does not meet the minimum quality requirements can cause the engine to malfunction or become damaged. There is a risk of property damage. Do not fill with fuel that does not comply with the minimum quality.

NOTICE

Incorrect fuels can damage the fuel system and the engine. There is a risk of property damage. Do not use fuels with a higher ethanol content than recommended. Do not refuel with fuels containing methanol, e.g. M5 to M100.

Recommended gas quality

BMW recommends AKI 91.

M Performance model:

BMW recommends AKI 93.

Minimum fuel grade

BMW recommends AKI 87.

If you use gasoline with this minimum AKI Rating, the engine may produce knocking sounds when starting at high external temperatures. This has no effect on the engine life.

BMW recommends
Shell Quality Fuels 

Engine oil

General information

The engine oil consumption and engine oil properties depend on the driving style and operating conditions.

Therefore, regularly check the engine oil level after refueling by taking a detailed measurement.

The engine oil consumption can increase in the following situations, for instance:

- ▷ Sporty driving style.
- ▷ Break-in of the engine.
- ▷ Idle operation of the engine.
- ▷ With use of engine oil types that are not recommended.

Different Check Control messages are shown on the control display depending on the engine oil level and engine oil properties.

The vehicle manufacturer recommends having the engine oil changed by an authorized service center or another qualified service center or repair shop. The suitable viscosity grade is indicated on a sign in the engine compartment.

Safety information

NOTICE

An engine oil level that is too low causes engine damage. There is a risk of property damage. Immediately add engine oil.

NOTICE

Too much engine oil can damage the engine or the catalytic converter. There is a risk of property damage. Do not add too much engine oil. If there is excess engine oil, have the engine oil level corrected by an authorized service center or another qualified service center or repair shop.

⚠ NOTICE

Engine oil that is not changed in timely fashion can cause increased engine wear and thus engine damage. There is a risk of property damage. It is recommended that you do not exceed the service intervals indicated in the vehicle.

Electronic oil measurement

General information

The electronic oil measurement has two measuring principles:

- ▷ Monitoring.
- ▷ Detailed measurement.

When making frequent short-distance trips or using a sporty driving style, for instance when cornering aggressively, regularly perform a detailed measurement.

Monitoring

Principle

The engine oil level is monitored electronically while driving and can be shown on the control display.

If the engine oil level is outside its permissible operating range, a Check Control message is displayed.

Functional requirements

A current measured value is available after approx. 30 minutes of normal driving.

Displaying the engine oil level

1.  Apps menu
2. "Vehicle"
3. "Vehicle status"
4. "Engine oil level"

The engine oil level is displayed.

System limits

When making frequent short-distance trips or using a sporty driving style, it may not be possible to calculate a measured value. In this case, the measured value for the last, sufficiently long trip is displayed.

Detailed measurement

Principle

The engine oil level is checked when the vehicle is stationary and displayed via a scale.

If the engine oil level is outside its permissible operating range, a Check Control message is displayed.

General information

During the measurement, the idle speed is increased somewhat.

Depending on vehicle equipment, an optimum operating range for racetrack use is displayed on the scale.

Functional requirements

- ▷ Vehicle is parked in a horizontal position.
- ▷ The drive-ready state is switched on by pressing the Start/Stop button.
- ▷ The engine is at operating temperature.
- ▷ Selector lever in selector lever position N or P and accelerator pedal not depressed.

Performing a detailed measurement

1.  Apps menu
2. "Vehicle"
3. "Vehicle status"
4. "Engine oil level"
5. "Oil level measurement"
6. "Start measurement"

The engine oil level is checked and displayed via a scale.

Adding engine oil

General information

Only add engine oil when the message is displayed in the instrument cluster. The top-up quantity is indicated in the message shown on the control display.

Only add suitable types of engine oil.

Safely park the vehicle and switch off drive-ready state before adding engine oil.

Take care not to add too much engine oil.

Safety information

Warning

Operating fluids, e.g., oil, grease, coolant, fuel, may contain harmful ingredients. There is a risk of injury or danger to life. Follow the instructions on the containers. Do not allow operating fluids to come into contact with your clothing, skin, or eyes. Do not fill operating fluids into different bottles. Store operating fluids out of reach of children.

NOTICE

An engine oil level that is too low causes engine damage. There is a risk of property damage. Immediately add engine oil.

NOTICE

Too much engine oil can damage the engine or the catalytic converter. There is a risk of property damage. Do not add too much engine oil. If there is excess engine oil, have the engine oil level corrected by an authorized service center or another qualified service center or repair shop.

Overview

The oil filler neck is located in the engine compartment.

Additional information:

For an overview, refer to page [378](#).

Adding engine oil

1. Opening the hood.
Opening, refer to page [380](#).
2. Open the lid counterclockwise.



3. Add engine oil.
4. Close the lid.

Engine oil types to add

General information

The engine oil grade is critical for the service life of the engine.

Only add with the types of engine oil which are listed.

Safety information

NOTICE

Oil additives can damage the engine. There is a risk of property damage. Do not use oil additives.

⚠ NOTICE

Incorrect engine oil can cause malfunctions in the engine or damage it. There is a risk of property damage. When selecting an engine oil, make sure that the engine oil has the correct oil specification.

Suitable engine oil types

When topping up engine oil, the following oil specification applies:

Gasoline engine

BMW Longlife-01 FE.

BMW Longlife-22 FE++.

The BMW Longlife-22 FE++ oil specification is not suitable for the 60i gasoline engine.

Alternative engine oil types

If an engine oil suitable for continuous use is not available, up to 1 US quart/liter of an engine oil with the following oil rating can be added:

Oil specification

API SL.

API SM.

API SN.

Viscosity grades

When selecting an engine oil, make sure that the engine oil has a suitable viscosity grade. The suitable viscosity grade is indicated on a sign in the engine compartment.

More information about suitable oil specifications and engine oil viscosity grades can be requested from an authorized service center or another qualified service center or repair shop.

**BMW recommends
Original BMW Engine Oil.**

Coolant**General information**

Coolant consists of water and coolant additive. Not all commercially available coolant additives are suitable for the vehicle. The vehicle manufacturer recommends using coolant with the BMW LC-18 specification. Do not mix coolant additives of different colors. Use a 50:50 mixing ratio of water to coolant additive. Information on suitable coolant additives can be provided by an authorized service center or another qualified service center or repair shop.

Safety information**⚠ Warning**

With the engine hot and the cooling system open, coolant can escape and lead to scalding. There is a risk of injury. Only open the cooling system with the engine cooled down.

⚠ Warning

Additives are harmful and incorrect additives can damage the engine. There is a risk of injury and risk of damage to property. Do not allow additives to come into contact with skin, eyes or articles of clothing. Use suitable additives only.

NOTICE

Too much water reduces the cooling and antifreeze properties of the coolant. There is a risk of damage to property. Use a 50:50 mixing ratio of water to coolant additive.

Coolant level

General information

The coolant reservoir may be overfilled with coolant when the vehicle is delivered from the factory or following maintenance and repair work. The specified coolant level is achieved with longer operating periods.

The nominal coolant level is indicated by the maximum mark in the filler neck of the coolant reservoir.

Additional information:

For an overview, refer to page [378](#).

Checking the coolant level

1. Let the engine cool down.
2. Turn off the climate control system.
Climate control, refer to page [286](#).
3. Opening the hood.
Opening, refer to page [380](#).
4. Turn the lid of the coolant reservoir slightly counterclockwise to allow any excess pressure to dissipate, then open it.
5. Open the coolant reservoir lid.

6. The coolant level is correct when it is just below the max. level mark on the filler neck.



7. Close the lid.

Adding coolant

1. Let the engine cool down.
2. Turn off the climate control system.
Climate control, refer to page [286](#).
3. Opening the hood.
Opening, refer to page [380](#).
4. Turn the lid of the coolant reservoir slightly counterclockwise to allow any excess pressure to dissipate, then open it.
5. Open the coolant reservoir lid.
6. If the coolant is low, slowly add coolant up to the specified fill level. Do not overfill or spill the coolant.
7. Close the lid.

Disposal



Comply with the relevant environmental protection regulations when disposing of coolant and coolant additives.

Washer fluid

General information

All spray nozzles are supplied from one tank. Use a mixture of tap water and windshield washer concentrate. If desired, a windshield

washer concentrate containing antifreeze can be used.

Recommended minimum fill quantity: 0.4 US gal/2 liters.

Safety information

Warning

Some types of antifreeze can contain harmful substances and are flammable. There is a risk of fire and an injury hazard. Follow the instructions on the containers. Keep antifreeze away from ignition sources. Do not fill operating fluids into different bottles. Store operating fluids out of reach of children.

United States: the washer fluid mixture ratio is regulated by the U.S. EPA and many individual states; do not exceed the allowable washer fluid dilution ratio limits that apply. Follow the usage instructions on the washer fluid container.

Use of BMW's Windshield Washer Concentrate or the equivalent is recommended.

Warning

Washer fluid can ignite and catch fire on contact with hot engine parts. There is a risk of injury or risk of damage to property. Only add washer fluid when the engine is cooled down. Next, fully close the lid of the washer fluid reservoir.

NOTICE

Silicon-containing additives in the washer fluid for the water-repelling effect on the windows can lead to damage to the car wash. There is a risk of property damage. Do not add silicon-containing additives to the washer fluid.

NOTICE

Mixing different windshield washer fluid concentrates or antifreeze can damage the washer system. There is a risk of property damage. Do not mix different windshield washer fluid concentrates or antifreeze. Follow the information and mixture ratios provided on the containers.

Overview



The washer fluid reservoir is located in the engine compartment.

Malfunction

The use of undiluted windshield washer fluid concentrate or alcohol-based antifreeze can lead to incorrect readings at temperatures below +5 °F/-15 °C.

Maintenance

Vehicle features and options

This chapter describes model-specific equipment, systems, and functions that are currently available, or may become available in the future, even if they are not present in the vehicle.

Additional information:

Vehicle equipment, refer to page 8.

Maintenance system

Principle

The maintenance system provides service notifications and thereby provides support in maintaining road safety and the operational reliability of the vehicle.

General information

In some cases, scopes and intervals of the maintenance system may vary according to the country version. Replacement work, spare parts, fuels and lubricants, and wear materials are calculated separately. Further information is available from an authorized service center or another qualified service center or repair shop.

Condition Based Service

Principle

Condition Based Service determines the maintenance recommendation using sensors and special algorithms that take into account the operating conditions of the vehicle.

The maintenance measures are determined taking into account the individual usage profile of the vehicle.

General information

Service notifications can be displayed on the control display.

Additional information:

Service notifications, refer to page 165.

Service data in the vehicle key

Information on the service notifications is continuously stored in the vehicle key. An authorized service center can read this data out and suggest a maintenance scope for the vehicle.

Therefore, hand the service advisor the vehicle key with which the vehicle was driven most recently.

Stationary periods

Stationary periods during which the vehicle battery was disconnected are taken into account.

Have any time-dependent maintenance measures, e.g., replacing operating fluids, performed by an authorized service center or another qualified service center or repair shop.

Maintenance Booklet for US Models

Please consult your Maintenance Booklet for additional information on the performance of service and maintenance work.

The manufacturer of the vehicle recommends that maintenance and repair be performed by an authorized service center or another qualified service center or repair shop. Records of regular maintenance and repair work should be retained.

Diagnostic socket

General information

Devices connected to the diagnostic socket will trigger the alarm system after the vehicle is locked.

Disconnect devices from the diagnostic socket before locking the vehicle.

Additional information:

Indicator/warning lights, refer to page 149.

Safety information

NOTICE

The socket for Onboard Diagnosis is an intricate component intended to be used in conjunction with specialized equipment to check the vehicle's primary emissions system. Improper use of the socket for Onboard Diagnosis, or contact with the socket for Onboard Diagnosis for other than its intended purpose, can cause vehicle malfunctions and creates risks of personal and property damage. As such, it is strongly recommended that access to the diagnostic socket be limited to an authorized service center or another qualified service center or repair shop, or other persons who have specialized training and equipment and who are able to use the diagnostic socket correctly.

Overview

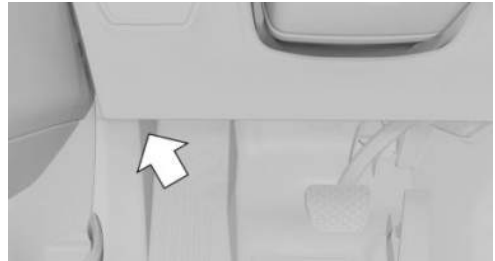

There is a diagnostic socket on the driver's side for reading out vehicle data.

Exhaust emissions



▶ The warning light illuminates:
The exhaust gas quality is declining, e.g., because the fuel filler cap is fitted incorrectly. Have the vehicle checked as soon as possible.

▶ The warning light flashes under certain circumstances:
This indicates that there is excessive misfiring in the engine.

Reduce the vehicle speed and have the vehicle checked immediately; otherwise, serious engine misfiring within a brief period can seriously damage emission control components, in particular the catalytic converter.

Have the vehicle checked by an authorized service center or another qualified service center or repair shop.

Taking the vehicle out of service

When the vehicle is shut down for longer than three months, special measures must be taken. For more information, contact an authorized service center or another qualified service center or repair shop.



Additional information:

Deep sleep mode, refer to page [41](#).

Replacing components

Vehicle features and options

This chapter describes model-specific equipment, systems, and functions that are currently available, or may become available in the future, even if they are not present in the vehicle.

Additional information:

Vehicle equipment, refer to page 8.

Onboard vehicle tool kit

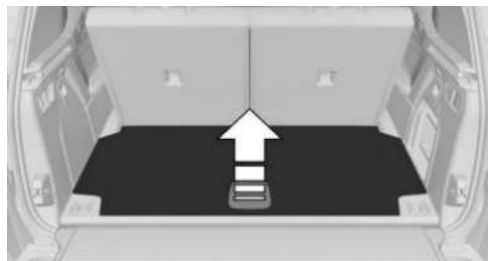

The onboard vehicle tool kit is located under the cargo area floor.

Wiper blades

Safety information

NOTICE

The window may sustain damage if the wiper falls onto it without the wiper blade installed. There is a risk of property damage. Hold the wiper firmly when changing the wiper blade. Do not fold in or switch on the wiper without a wiper blade installed.

NOTICE

Folded-out wipers can be jammed when the hood is opened. There is a risk of property damage. Make sure that the wipers with the wiper blades mounted are folded down onto the windshield before opening the hood.

Replacing the front wiper blades

1. To change the wiper blades, bring wipers into fold-out position.
Fold-out position of the wipers, refer to page 177.
2. Lift the wiper off of the windshield and hold.



3. Press the button, arrow 1, turn the wiper blade slightly clockwise, and pull it forward and out, arrow 2.

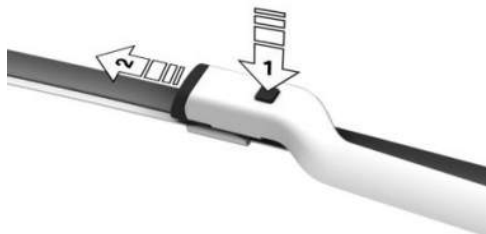

4. Insert the new wiper blade and press it on until you hear it snap into the holder.
5. Fold in the wipers.

Replacing the rear wiper blade

The wiper blade engages in the middle of the wiper arm.

1. Lift off the wiper fully and pull off the wiper blade, arrow.



2. Attach a new wiper blade. The wiper blade must engage audibly.
3. Fold in the wipers.

Lights and bulbs

General information

Lights and bulbs make an essential contribution to driving safety.

All headlights and lights are designed using LED technology at least.

In the event of a malfunction, the vehicle manufacturer recommends having any necessary work performed by an authorized service center or another qualified service center or repair shop.

Safety information

Warning

Intense brightness can irritate or damage the retina of the eye. There is a risk of injury. Do not look directly into the headlights or other light sources. Do not remove the LED covers.

Headlight glass

The inside of the headlight glass can fog up in cool or humid weather. When driving with the lights switched on, the condensation evaporates after a short time. The headlight glass does not need to be changed.

If, despite driving with the headlights switched on, moisture such as water droplets increasingly forms in the light, have the headlights checked.

Vehicle battery

General information

The battery is maintenance-free.

More information on the battery can be requested from an authorized service center or another qualified service center or repair shop.

Safety information

DANGER

Contact with live components can lead to an electric shock. There is a risk of injury and danger to life. Do not touch any components that are under voltage.

Warning

Vehicle batteries that are not recommended can damage vehicle systems and impair vehicle functions. There is a risk of accident, injury, or property damage. Only use vehicle batteries recommended by the vehicle manufacturer. For information on suitable vehicle batteries, contact an authorized service center or another qualified service center or repair shop.

Registering the battery to the vehicle

The vehicle manufacturer recommends having an authorized service center or another qualified service center or repair shop register the vehicle battery to the vehicle after the battery has been changed. Once the battery has been registered again, all comfort features will be available without limitation and any Check Control messages displayed which relate to comfort features will disappear.

Charging the battery

General information

Make sure that the battery is always sufficiently charged to guarantee that the battery remains usable for its full service life.



A discharged battery is indicated by a red indicator light.

Charge the battery when acceleration is insufficient.

The following circumstances can have a negative effect on the performance of the battery:

- ▷ Frequent short-distance drives.
- ▷ Stationary periods of more than one month.

Safety information

Warning

Battery chargers that charge the vehicle battery via sockets or cigarette lighters in the vehicle may overload or damage the 12 V electrical system. There is a risk of injury or risk of damage to property. Only connect battery chargers for the vehicle battery to the jump-start terminals in the engine compartment.

Charging the battery

Charge the battery only when the engine is off and via the jump-start terminals in the engine compartment.

With Mild Hybrid technology: charge the battery only when the hood is opened.

Additional information:

Jump-start terminals, refer to page 399.

Power interruption

After a power interruption, some equipment needs to be newly initialized or individual settings updated, for example:

- ▷ Parking brake, refer to page 142.
- ▷ With Memory function: store the positions again.
- ▷ Time: update.
- ▷ Date: update.

Deep sleep mode

Use deep sleep mode for long stationary periods.

Additional information:

Deep sleep mode, refer to page 41.

Mild Hybrid technology

Principle

Part of the Mild Hybrid technology is a battery that works with a voltage of 48 volts. Mild Hybrid technology can lower the fuel consumption.

Safety information

DANGER

Contact with live components can lead to an electric shock. There is a risk of injury and danger to life. Do not touch any components that are under voltage.

Overview

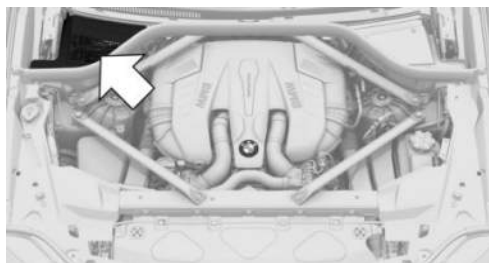

The battery for the Mild-Hybrid technology is located under a cover in the engine compartment on the front passenger side.

Removing the cover

1. Turn lid up to the opened lock icon  arrow 1.

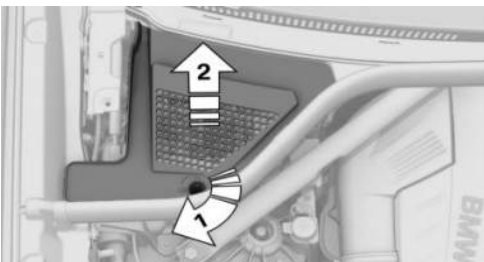

2. Remove cover, arrow 2.

Notice

Do not exchange or work on the battery for the Mild Hybrid technology.

Disposing of old batteries



Have old batteries disposed of by an authorized service center or another qualified service center or repair shop, or take them to a collection point.

Maintain the filled battery in an upright position for transport and storage. Secure the battery so that it does not tip over during transport.

Fuses

General information

The fuses are located at different places in the vehicle.

Information on the fuse layout and the positions of the fuse boxes is available on the Internet: fusecard.bmw.com.

Safety information

Warning

Incorrect and repaired fuses can overload electrical lines and components. There is a risk of fire. Never attempt to repair a blown fuse. Do not replace a nonworking fuse with a substitute of another color or amperage rating.

Replacing fuses

The vehicle manufacturer recommends having the fuses replaced by an authorized service center or another qualified service center or repair shop.

Breakdown Assistance

Vehicle features and options

This chapter describes model-specific equipment, systems, and functions that are currently available, or may become available in the future, even if they are not present in the vehicle.

Additional information:

Vehicle equipment, refer to page 8.

Hazard warning system

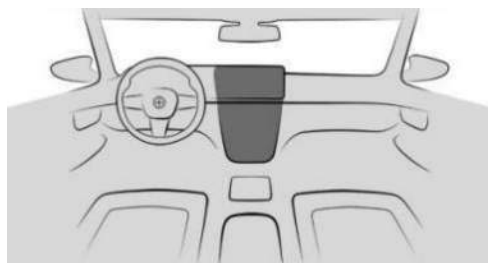

Hazard warning system button

The red light in the button flashes when the hazard warning system is turned on.

Warning triangle

The warning triangle is located in the tailgate.

1. Fold open the cover in the tailgate up.

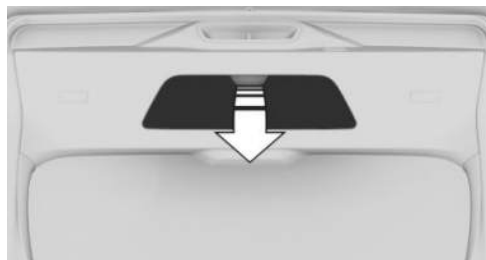

2. Release the hook and loop fastener and take the warning triangle out of the holder.

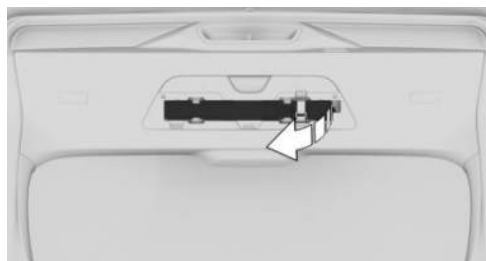

First-aid kit

General information

Depending on the vehicle equipment and national-market version, the vehicle is equipped with a first-aid kit.

Some of the articles have a limited service life.

Check the expiration dates of the contents regularly and replace any expired items promptly.

Storage

Storage for the first-aid kit is provided in the right storage compartment of the cargo area.

1. Unlock the cover of the right side trim panel, arrow 1, and fold open, arrow 2.



2. If necessary, remove the cargo cover from the storage under the cargo floor panel.
Cargo covers, refer to page 322.

BMW Assist

Principle

In the event of a breakdown, accident or if you have any questions about the vehicle, BMW Assist can be used to contact BMW Group's customer support.

General information

The offering depends on the vehicle equipment and the national-market version.

For more information on this service, the vehicle manufacturer recommends contacting an authorized service center or the hotline/customer support.

Starting services

1.  Apps menu
2. "All apps"
3. "BMW Assist"
4. "BMW Assist"

A voice connection to customer support is being established.

BMW Roadside Assistance

Principle

The BMW Group Accident Assistance is standing by to provide help in the event of a breakdown.

General information

In the event of a breakdown, data on the vehicle's condition is transmitted to the BMW Roadside Assistance.

There are various ways of contacting BMW Roadside Assistance.

- ▶ Via additional text in the Check Control message.
- ▶ Via a call with a mobile phone.
- ▶ Via the My BMW App.

Functional requirements

To use BMW Roadside Assistance, the following functional requirements must be met:

- ▶ Active ConnectedDrive contract, equipment with intelligent emergency call or BMW ConnectedDrive services.
- ▶ Cellular network reception.
- ▶ Standby state is switched on.

Starting BMW Roadside Assistance manually

If the vehicle is equipped with Teleservices, support is first offered through Teleservice Diagnosis and, where applicable, then through Teleservice Help.

BMW Roadside Assistance can be started manually as follows:

1.  Apps menu
2. "All apps"

3. "BMW Assist"
4. "BMW Roadside Assistance" or select the desired service.
Follow the displays on the control display. A voice connection is established as necessary.

Teleservice Diagnosis

Teleservice Diagnostics enables detailed vehicle data to be transmitted via mobile communications, which is necessary for vehicle diagnosis. This data is transmitted automatically. It may be necessary to approve this on the control display.

Teleservice Help

Depending on the country, Teleservice Help enables an in-depth diagnosis of the vehicle by BMW Roadside Assistance via wireless transmission.

You can launch Teleservice Help by requesting it through BMW Roadside Assistance.

1. Park vehicle in a safe place.
2. Engage the parking brake.
3. Turn on the control display.
4. Consent to Teleservice Help.

BMW Accident Assistance

Principle

The BMW Group Accident Assistance is standing by to provide help in the event of an accident.

General information

If the vehicle sensors detect a minor to moderately severe accident, which did not deploy any airbags, a Check Control message is displayed in the instrument cluster. In addition, a text message appears on the control display.

When BMW Accident Assistance is triggered, data on the vehicle's condition is sent to BMW.

Functional requirements

To use BMW Roadside Assistance, the following functional requirements must be met:

- ▷ Active ConnectedDrive contract, equipment with intelligent emergency call or BMW ConnectedDrive services.
- ▷ Cellular network reception.
- ▷ Standby state is switched on.

Starting BMW Accident Assistance

If an accident is detected automatically

A text message relating to BMW Accident Assistance appears on the control display.

The connection can be established directly: "Contact accident assistance"

The Check Control message for BMW Accident Assistance can also be called up from the stored Check Control messages for a certain length of time.

Additional information:

Check Control, refer to page 148.

Starting BMW Accident Assistance manually

BMW Accident Assistance can also be contacted independently of the automatic accident detection function.

BMW Accident Assistance can be started manually as follows:

1.  Apps menu
2. "All apps"
3. "BMW Assist"
4. "BMW Accident Assistance" or select the desired service.

Follow the displays on the control display. A voice connection is established.

Emergency Call

Principle

In case of an emergency, an emergency call can be triggered automatically by the system or manually.

Intelligent emergency call

The vehicle features an Intelligent Emergency Call system, depending on vehicle equipment.

The Intelligent Assist system establishes a connection with the BMW Response Center.

Intelligent emergency calls are made using a SIM card that is integrated into the vehicle.

The BMW Response Center then makes contact with the occupants of the vehicle and initiates further steps to help.

If an intelligent emergency call is made, the data used to determine necessary rescue measures, e.g., the vehicle's current location if it can be determined, is sent to the BMW Response Center.

Even if the driver is unable to respond, the BMW Response Center can, under certain circumstances, initiate steps to provide further assistance.

Even if the BMW Response Center is no longer heard through the loudspeakers, the BMW Response Center may still be able to hear the occupants of the vehicle.

The BMW Response Center ends the emergency call.

General information

Only press the SOS button in the headliner in an emergency.

For technical reasons, the emergency call cannot be guaranteed under unfavorable conditions.

Overview



 The SOS button is located in the headliner.

Functional requirements

To use the emergency call, the following functional requirements must be met:

- ▶ Standby state is switched on.
- ▶ The Emergency Call system is functioning correctly.
- ▶ The integrated SIM card in the vehicle has been activated.

Automatic triggering

Under certain conditions, for example if the airbags are deployed, an emergency call is automatically triggered immediately after an accident of corresponding severity. Automatic Collision Notification is not affected by pressing the SOS button.

If an emergency call is placed, all other signal tones and audio sources such as the Park Distance Control are muted.

Manual triggering

To initiate an emergency call manually, proceed as follows:

1. Tap the cover flap.
2. Press and hold the SOS button in the headliner until the LED near the button illuminates green.

- ▶ The LED is illuminated green when an Emergency Call has been initiated.
If a cancel prompt appears on the control display, the emergency call can be aborted.
If the situation allows, wait in the vehicle until the voice connection has been established.
- ▶ The LED flashes green when the connection to the BMW Response Center has been established.

Malfunction

The function of the emergency call may be impaired.

The LED near the SOS button flashes for approximately 30 seconds. A Check Control message is displayed.

Have the vehicle checked by an authorized service center or another qualified service center or repair shop.

Jump-starting

General information

If the battery is discharged, the engine can be started using the battery of another vehicle and two jumper cables. Only use jumper cables with fully insulated clamp handles.

Safety information

DANGER

Contact with live components can lead to an electric shock. There is a risk of injury and danger to life. Do not touch any components that are under voltage.

Warning

If the jumper cables are connected in the incorrect order, spark formation may occur. There is a risk of injury. Pay attention to the correct order during connection.

Warning

In the case of body contact between the two vehicles, a short circuit can occur while jump-starting. There is a risk of injury or risk of damage to property. Make sure that no body contact occurs.

Preparation

1. Check whether the battery of the other vehicle has a voltage of 12 volts. The voltage information can be found on the battery.
2. Switch off the engine of the assisting vehicle.
3. Switch off any electrical components in both vehicles.

Jump-start terminals

The jump-start terminals are located in the engine compartment.

Additional information:

For an overview, refer to page [378](#).

Open the covers of the jump-start terminals.

Connecting the cables

Before you begin, switch off all unnecessary electronic systems/components such as the radio on the assisting and receiving vehicles.

1. Open the lid of the jump-start terminal.
2. Attach one terminal clamp of the positive jumper cable to the positive battery terminal, or to the corresponding jump-start terminal of the vehicle providing assistance.

- Attach the terminal clamp on the other end of the cable to the positive battery terminal, or to the corresponding jump-start terminal of the vehicle to be started.
- Attach one terminal clamp of the negative jumper cable to the negative battery terminal, or to the corresponding engine or body ground of assisting vehicle.
- Attach the second terminal clamp to the negative battery terminal, or to the corresponding engine or body ground of the vehicle to be started.

Starting the engine

Never use spray fluids to start the engine.

- Start the engine of the assisting vehicle and let it run for several minutes at an increased idle speed.

If the vehicle to be started has a diesel engine: let the engine of the assisting vehicle run for approx. 10 minutes.

- Start the engine of the vehicle that is to be started in the usual way.

If the first attempt to start the engine is not successful, wait a few minutes before making another attempt in order to allow the discharged battery to recharge.

- Let both engines run for several minutes.
- Disconnect the jumper cables in the reverse order.

Check the battery and recharge, if needed.

Tow-starting/towing

General information

Depending on vehicle equipment, deactivate two-axle level control.

Additional information:

Two-axle ride level control, refer to page [279](#).

Safety information

Warning

When towing while safety systems or driver assistance systems are activated, the behavior of the individual systems may lead to an accident, e.g., due to automatic braking or acceleration. There is a risk of accident, injury, and property damage. Do not use the corresponding safety systems or driver assistance systems when towing.

Pushing the vehicle

To remove a broken-down vehicle from the hazard area, it can be pushed for distances of approx. 328 ft/100 m at a speed of max. 6 mph/10 km/h.

Additional information:

Rolling or pushing the vehicle, refer to page [134](#).

Transporting the vehicle

General information

The vehicle must be transported on a loading platform or tow dolly.

The vehicle must be transported by an authorized service center or another qualified service center or repair shop.

Safety information

NOTICE

The vehicle can be damaged when towing the vehicle with a single lifted axle. There is a risk of property damage. Have vehicle transported on a loading platform or use a tow dolly. Tow dollies must be used under the rear wheels only. Also make sure that no wheel is touching the ground.

Warning

The vehicle can become damaged when lifting and securing it.

There is a risk of injury or risk of damage to property.

- ▷ Lift the vehicle using suitable means.
- ▷ Do not lift or secure the vehicle by its towing eye, body parts, or suspension parts.

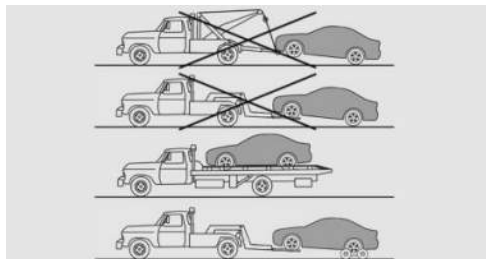
Tow truck

Have vehicle transported on a loading platform or use a tow dolly.

When using a tow dolly, make sure that none of the wheels touch the ground. This method should be used for distances of max. 124 miles/200 km. Follow the instructions, as well as specified loads and speeds, given by the tow dolly manufacturer.

Towing other vehicles**General information**

Switch on the hazard warning system, depending on local regulations.

If the electrical system has failed, clearly identify the vehicle being towed by placing a sign or a warning triangle in the rear window.

Safety information**Warning**

If the approved gross vehicle weight of the towing vehicle is lighter than the vehicle to be towed, the towing eye can tear off or it will not be possible to control vehicle handling. There is a risk of accident, injury, and property damage. Make sure that the gross vehicle weight of the towing vehicle is heavier than the vehicle to be towed.

Warning

Different levels of braking may occur when towing with adaptive recuperation. There is a risk of accident, injury, and property damage. Deactivate adaptive recuperation before towing.

NOTICE

If the tow bar or tow rope is attached incorrectly, damage to other vehicle parts can occur. There is a risk of property damage. Correctly attach the tow bar or tow rope to the towing eye.

Tow bar

The towing eyes used should be on the same side on both vehicles.

If it is impossible to avoid mounting the tow bar at an inclination, note the following:

- ▷ Free movement is limited when cornering.
- ▷ The tow bar will generate lateral forces if it is secured with an inclination.

Tow rope

Observe the following notes when using the tow rope:

- ▶ Use nylon ropes or straps, which will enable the vehicle to be towed without jerking.
- ▶ Make sure the tow rope is not twisted when fastening.
- ▶ Check the attachment of the towing eye and tow rope in regular intervals.
- ▶ Do not exceed a towing speed of 30 mph/50 km/h.
- ▶ Do not exceed a towing distance of 3 miles/5 km.
- ▶ When driving off to tow the vehicle, make sure that the tow rope is taut.

Towing eye

Principle

The towing eye is a device that can be screwed onto the vehicle in order to, e.g., secure tow cables or tow rods.

General information



The screw-in towing eye should always be carried in the vehicle.

The towing eye can be screwed in at the front or rear of the vehicle.

Safety information

⚠ NOTICE

If the towing eye is not used as intended, there may be damage to the vehicle or to the towing eye. There is a risk of property damage. Follow the notes on using the towing eye.

Storage

Depending on vehicle equipment, the towing eye may be stored in a bag as follows:

- ▶ In the cargo area under the cargo area floor.
- ▶ In the cargo area on the left or right side.
- ▶ In the cargo area behind a side trim panel.

Using the towing eye

When using the towing eye, note the following:

- ▶ Use only the towing eye provided with the vehicle.
- ▶ Turn the towing eye at least 5 turns clockwise and screw it in as far as it will go. If necessary, tighten with a suitable object.
- ▶ After use, unscrew the towing eye counterclockwise.
- ▶ Use the towing eye for towing on paved roads only.
- ▶ Avoid lateral loading of the towing eye, for instance do not lift the vehicle by the towing eye.
- ▶ Check the attachment of the towing eye in regular intervals.

Towing eye thread



Press on the mark on the edge of the cover to push it out.

Tow-starting

Do not tow-start the vehicle.

Start the engine by jump-starting, if possible.

Have the cause of starting issues corrected by an authorized service center or another qualified service center or repair shop.

Additional information:

Jump-starting, refer to page [399](#).

Vehicle care

Vehicle features and options

This chapter describes model-specific equipment, systems, and functions that are currently available, or may become available in the future, even if they are not present in the vehicle.

Additional information:

Vehicle equipment, refer to page 8.

Washing the vehicle

General information

Regularly remove foreign objects such as leaves or snow in the area below the windshield.

Wash the vehicle frequently, particularly in winter. Intense contamination and road salt can damage the vehicle.

Additional information:

Fold-out position of the wipers, refer to page 177.

Safety information

NOTICE

When washing with an open fuel filler flap, damage may occur. There is a risk of property damage. Close the fuel filler flap before washing. Clean dirt behind the fuel filler flap with a cloth.

Steam-jet cleaner and high pressure cleaner

Safety information

NOTICE

When cleaning with high pressure cleaners, components can be damaged due to the pressure or temperatures being too high. There is a risk of damage to property. Maintain sufficient distance and do not spray too long continuously. Follow the operating instructions for the high pressure cleaners.

Distances and temperature

- ▷ Maximum temperature: 140 °F/60 °C.
- ▷ Minimum distance from sensors, cameras, seals and lights: 12 inches/30 cm.
- ▷ Minimum distance from glass sunroof: 31.5 in/80 cm.

Automatic car washes or car washes

Safety information

NOTICE

Improper use of automatic car washes can cause damage to the vehicle. There is a risk of property damage. Follow the following instructions:

- ▷ Give preference to cloth car washes or those that use soft brushes in order to avoid paint damage.
- ▷ Note the permissible vehicle dimensions for the car wash.

- ▷ Do not drive through a car wash with guide rails higher than 4 in/10 cm to avoid damage to the body.
- ▷ Observe the tire width of the guide rail to avoid damage to tires and rims.
- ▷ Fold in exterior mirrors to avoid damage to the exterior mirrors.
- ▷ Deactivate the wiper and, if necessary, rain sensor to avoid damage to the window wiper system.
- ▷ Take off all removable attachments, e.g., antennas.

Driving into a car wash

NOTICE

Selector lever position P is automatically engaged when standby state is switched off. The wheels are blocked. There is a risk of property damage. Do not switch off standby if the vehicle is meant to coast, e.g., in a car wash.

In a car wash, the vehicle must be able to roll freely.

Some car washes do not permit persons in the vehicle. The vehicle cannot be locked from the outside when in selector lever position N. A signal sounds when an attempt is made to lock the vehicle.

Additional information:

Rolling or pushing the vehicle, refer to page [134](#).

Driving out of a car wash

Ensure that the vehicle key is in the car.

Turn on drive-ready state.

Additional information:

Drive-ready state, refer to page [42](#).

Lights

Do not rub wet lights dry and do not use abrasive or acidic cleaning agents or cleaning agents containing alcohol.

Soak areas that have been dirtied, for instance from insects, with auto shampoo and wash off with water.

Thaw ice with de-icing spray; do not use an ice scraper.

After washing the vehicle

After washing the vehicle, apply the brakes briefly to dry them. Otherwise, their braking effect may be reduced. The heat generated while braking dries brake disks and brake pads and protects them against corrosion.

Completely remove all residues on the windows to minimize loss of visibility due to smearing and to reduce wiper noises and wiper blade wear.

Vehicle care

Vehicle care products

General information

BMW recommends using vehicle care and cleaning agents from BMW. Suitable vehicle care products are available from an authorized service center or another qualified service center or repair shop.

Safety information

Warning

Cleaning agents can contain substances that are dangerous and harmful to your health. There is a risk of injury and risk of property damage. When cleaning the interior, open the doors or windows. Only use cleaning agents that are intended for cleaning the respective

component. Follow the instructions on the packaging.

Vehicle paintwork

General information

Regular vehicle care contributes to driving safety and value retention. Environmental influences in areas with elevated air pollution or natural contaminants such as tree resin or pollen can affect the vehicle paintwork. Tailor the frequency and extent of the vehicle care to these influences.

Aggressive substances such as spilled fuel, oil, grease or bird droppings must be removed immediately to prevent alterations or discolorations of the finish.

Matte paintwork

Only use cleaning and care products suitable for vehicles with matte paintwork.

Leather care

Remove dust from the leather regularly, using a cloth or vacuum cleaner.

Otherwise, particles of dust and road grime chafe in pores and folds, and lead to heavy abrasion and premature degradation of the leather surface.

To guard against discoloration such as from clothing, clean leather and provide leather care roughly every two months.

Clean light-colored leather more frequently because contamination on such surfaces is substantially more visible.

Use leather care products; otherwise, dirt and grease will gradually break down the protective coating of the leather surface.

Remove aggressive substances, e.g., sunscreen, immediately to prevent alterations or discolorations of the leather.

Synthetic leather care

Clean synthetic leather regularly with a damp microfiber cloth or vacuum cleaner.

Otherwise, dust and road grime particles will rub into pores and folds, causing significant abrasion and premature degradation of the surface.

In case of major soiling, use a moist soft sponge or microfiber cloth with suitable interior cleaners.

Immediately remove aggressive substances, e.g., sunscreen, to prevent alterations or discolorations of the synthetic leather.

Fabric care

General information

In case of major contaminations such as beverage stains, use a moist soft sponge or microfiber cloth with a suitable interior cleaners.

Immediately remove aggressive substances, e.g., sunscreen, to prevent alterations or discolorations of the fabric.

Safety information

NOTICE

Open hook and loop fasteners on articles of clothing can damage the seat covers and other cloth upholstery in the vehicle. There is a risk of damage to property. Ensure that any Velcro® fasteners are closed.

Upholstery material care

Vacuum regularly with a vacuum cleaner.

Clean extensively down to the seams. Avoid rubbing the material vigorously.

Textile care

Use a microfiber cloth for cleaning minor contamination.

Dampen the cloth with water.

Caring for special components

Displays, operating elements, and protective glass of the Head-up display

NOTICE

Surfaces can be damaged by improper cleaning, e.g., by using chemical cleaners, or from moisture or liquid of any kind. There is a risk of property damage.

- ▷ Avoid pressure that is too high and do not use any scratching materials.
- ▷ Use a dry, clean antistatic microfiber cloth for cleaning displays.
- ▷ Clean the operating elements and, depending on vehicle equipment, the protective glass of the Head-up display with a damp microfiber cloth and standard household dish soap.

Light-alloy wheels

When cleaning the vehicle, use only neutral rim cleaners having a pH value from 5 to 9. Do not use abrasive cleaning agents or steam-jet cleaners above 140 °F/60 °C. Follow the manufacturer's instructions.

Corrosive, acidic, or alkaline cleaning agents can damage the rim surface and the protective layer on adjacent components, e.g., the brakes.

After cleaning, apply the brakes briefly to dry them. The heat generated while braking dries brake disks and brake pads and protects them against corrosion.

Chrome surfaces

Carefully clean chrome-like surfaces, especially if exposed to road salt, using plenty of water as well as auto shampoo as needed.

Rubber components

Environmental influences can cause surface contamination of rubber parts and a loss of gloss. Use only water and suitable cleaning agents for cleaning.

Treat especially worn rubber parts with rubber care products at regular intervals. When cleaning rubber seals, do not use any silicon-containing vehicle care products in order to avoid damage or noises.

Wiper blades

The wiper blades are cleaned by using the window washer system.

Avoid cleaning the wiper blades manually, as this may reduce wiper performance.

Fine wood parts

Clean the fine wood veneer and fine wood components with a damp cloth. Then dry with a soft cloth.

Plastic components

NOTICE

Solvent cleaners that contain alcohol or solvents such as lacquer thinners, cold cleaning agents, fuel and such, can damage plastic parts. There is a risk of property damage. Clean with a microfiber cloth. Dampen the cloth lightly with water, if needed.

When cleaning plastic parts, make sure that no fabric parts, e.g., the headliner, become wet.

Seat belts

Warning

Chemical solvent cleaners can destroy the fabric of the seat belts and lead to seat belts no longer having their protective effect. There is a risk of injury or danger to life. Use only a mild soap solution for cleaning the seat belts.

Dirty belt straps impede the reeling action and thus should be avoided for safety reasons.

Use only a mild soap solution for cleaning the installed belt straps.

Seat belts should only be allowed to retract if they are dry.

Carpets and floor mats

Warning

Objects in the driver's footwell can limit the pedal travel or block a depressed pedal. There is a risk of accident. Stow objects in the vehicle such that they are secured and cannot enter into the driver's footwell. Use floor mats that are suitable for the vehicle and can be safely attached to the floor. Do not use loose floor mats and do not layer several floor mats. Make sure that there is sufficient clearance for the pedals. Ensure that the floor mats are securely fastened again after they were removed, for instance for cleaning.

The floor mats can be removed from the interior for cleaning.

If the floor carpets are very contaminated, clean with a microfiber cloth and water or a textile cleaner. To prevent matting of the carpet, rub back and forth in the driving direction only.

Mount for trailer hitch

Depending on vehicle equipment, keep the mount clean.

Regularly grease or oil bearings and sliding surfaces with resin-free greases or oils.

Before using steam cleaners or high pressure cleaners on the vehicle, remove the ball head and insert the cover into the mount.

Sensors and camera lenses

To clean sensors and camera lenses, use a cloth moistened with a small amount of glass detergent.

Technical data

Vehicle features and options

This chapter describes model-specific equipment, systems, and functions that are currently available, or may become available in the future, even if they are not present in the vehicle.

Additional information:

Vehicle equipment, refer to page 8.

Vehicle-specific data may deviate from this, for instance due to the optional equipment chosen, national-market version, or country-specific measuring process. More specific values can be obtained in approval documents, on the vehicle info label, or from an authorized service center or another qualified service center or repair shop.

General information

The technical data and specifications in the Owner's Manual are used as guidance values.

Dimensions

The dimensions can vary depending on the model version, equipment version or country-specific measurement procedure.

The height of the vehicle can also differ, e.g. due to tires and vehicle load.

BMW X7

Width with mirrors	in/mm	87.3/2,218
Width without mirrors	in/mm	78.7/2,000
Height	in/mm	72.2/1,835
Length	in/mm	203.6/5,172
Wheelbase	in/mm	122.2/3,105
Turning radius diameter	ft/m	42.7/13.0

Weights

BMW X7 xDrive40i

Permissible gross mass	lbs/kg	7,088/3,215
Payload	lbs/kg	1,316/597
Approved front axle weight	lbs/kg	3,230/1,465
Approved rear axle weight	lbs/kg	4,244/1,925

BMW X7 M60i xDrive

Permissible gross mass	lbs/kg	7,319/3,320
Payload	lbs/kg	1,230/558
Approved front axle weight	lbs/kg	3,230/1,465
Approved rear axle weight	lbs/kg	4,244/1,925

Trailer towing

BMW X7 xDrive40i

Trailer load unbraked	lbs/kg	1,653/750
a) Trailer load with brakes on uphill grades of up to 12 %	lbs/kg	5,952/2,700
b) Trailer load with brakes on uphill grades of up to 12 %	lbs/kg	7,507/3,405
Maximum drawbar nose weight	lbs/kg	606/275
Approved rear axle weight, towing vehicle	lbs/kg	4,244/1,925
Permissible gross mass, towing vehicle	lbs/kg	7,088/3,215

- a) The trailer load only applies to vehicles with a mount for trailer hitches retrofitted by BMW.
 b) The trailer load only applies to vehicles with a factory-installed mount for trailer hitches.

BMW X7 M60i xDrive

Trailer load unbraked	lbs/kg	1,653/750
a) Trailer load with brakes on uphill grades of up to 12 %	lbs/kg	5,952/2,700
b) Trailer load with brakes on uphill grades of up to 12 %	lbs/kg	7,507/3,405

BMW X7 M60i xDrive

Maximum drawbar nose weight	lbs/kg	606/275
Approved rear axle weight, towing vehicle	lbs/kg	4,244/1,925
Permissible gross mass, towing vehicle	lbs/kg	7,319/3,320

- a) The trailer load only applies to vehicles with a mount for trailer hitches retrofitted by BMW.
- b) The trailer load only applies to vehicles with a factory-installed mount for trailer hitches.

Filling capacities

BMW X7

Fuel tank, approx.	US gal/liters	21.9/83.0
--------------------	---------------	-----------

Observe further information on fuel quality, refer to page [381](#).

Appendix

General information

Any updates to the Owner's Manual of the vehicle are listed here.

Updates made after the editorial deadline

The following chapters were updated in the printed version of the Owner's Manual after the editorial deadline for the Integrated Owner's Manual in the vehicle had closed:

Everything from A to Z

Index

0-9

- 2-axle air suspension, see Two-axle level control [279](#)
- 3D view [256](#)
- 48-volt technology, see Mild Hybrid technology [393](#)
- 6-seater [110](#)

A

- ABS, see Antilock Braking System [216](#)
- Acceleration Assistant, see Launch Control [137](#)
- Acceleration sensor, see G-Meter [162](#)
- Accessories and parts [9](#)
- Accident Assistance, see BMW Accident Assistance [397](#)
- Accident prevention, see Active Protection [213](#)
- Acoustic pedestrian protection [130](#)
- Activated carbon filter, see Interior filter [297](#)
- Activation points, panorama view [258](#)
- Activation, trailer towing [336](#)
- Activation word [54](#)
- Active Blind Spot Detection [197](#)
- Active comfort chassis, see Executive Drive Pro [279](#)
- Active Cruise Control, Distance Control, see Speed control systems [224](#)
- Active Guard, see Collision warning systems [181](#)
- Active M Sport differential [219](#)
- Active Park Distance Control [264](#)
- Active Protection [213](#)
- Active roll stabilization [279](#)
- Active seat ventilation [294](#)
- Active Steering, integral [221](#)
- Adaptive 2-axle air suspension, see Two-axle level control [279](#)
- Adaptive lighting functions [172](#)
- Adaptive recuperation [342](#)

- Adding engine oil types [384](#)
- Additional camera view displays [252](#)
- Additives, engine oil types [384](#)
- Adjusting speed to route [245](#)
- Advanced Real Time Traffic Information, see Owner's Manual for Navigation, Entertainment, Communication [6](#)
- After run of fan, see Exhaust gas particulate filter [330](#)
- Airbags [178](#)
- Airbags, warning light [180](#)
- Air circulation, see Recirculated-air mode [292](#)
- Air conditioning, climate [291](#)
- Air distribution, manual [291](#)
- Air drying, see air conditioning [291](#)
- Air flow, automatic climate control [290](#)
- Air outlets, see Ventilation [295](#)
- Air pressure, tires [348](#)
- Air quality [296](#)
- Air suspension, see Two-axle level control [279](#)
- Air vent, see Ventilation [295](#)
- Alarm, avoiding [95](#)
- Alarm system [93](#)
- Alcantara, care, see Fabric care [406](#)
- All-season tires, see Winter tires [356](#)
- All-season tires, tread [353](#)
- All-wheel drive, see BMW xDrive [218](#)
- Amazon Alexa Car Integration [57](#)
- Ambient Air package [297](#)
- Ambient light [173](#)
- Android Auto, see Owner's Manual for Navigation, Entertainment, Communication [6](#)
- Antifreeze, see Washer fluid [386](#)
- Antilock Braking System [216](#)
- Anti-theft protection, lug bolt lock [374](#)
- Anti-trap mechanism, glass sunroof [102](#)
- Anti-trap mechanism, windows [97](#)
- Apple CarPlay, see Owner's Manual for Navigation, Entertainment, Communication [6](#)

- Applications see Owner's Manual for Navigation, Entertainment, Communication [6](#)
- Applications, see Owner's Manual for Navigation, Entertainment, Communication [6](#)
- Apps, see Owner's Manual for Navigation, Entertainment, Communication [6](#)
- Aquaplaning [331](#)
- Armrest heating [294](#)
- Articulation angle, Trailer Assistant [338](#)
- Artificial engine noise, see Acoustic pedestrian protection [130](#)
- Assistance, BMW [396](#)
- Assistance with breakdown [395](#)
- Assisted Driving Mode, lane keeping, see Speed control systems [224](#)
- Assisted Driving Mode Plus, see Speed control systems [224](#)
- Assisted View [161](#)
- Audio player, see Owner's Manual for Navigation, Entertainment, Communication [6](#)
- Audio, see Owner's Manual for Navigation, Entertainment and Communication [6](#)
- Authorized service center, see BMW Accident Assistance [397](#)
- Authorized service center, see BMW Roadside Assistance [396](#)
- AUTO H, see Automatic Hold [142](#)
- Automatic camera perspective [255](#)
- Automatic climate control [286](#)
- Automatic control, headlight [169](#)
- Automatic Curb Monitor, exterior mirror [120](#)
- Automatic deactivation, front-seat passenger airbags [180](#)
- Automatic dimming, see Automatic High Beam Assistant [167](#)
- Automatic headlight control [169](#)
- Automatic High Beam Assistant [167](#)
- Automatic Hold [142](#)
- Automatic locking [92](#)
- Automatic Parking Assistant [266](#)
- Automatic Parking Assistant Professional [266](#)
- Automatic Parking Assistant, see Maneuver Assistant [271](#)
- Automatic program, automatic climate control [288](#)
- Automatic time setting [162](#)
- Automatic transmission, see Steptronic transmission [133](#)
- Automatic unlocking [92](#)
- Automatic wiper system, see Rain sensor [175](#)
- Automating routines, BMW Intelligent Personal Assistant [57](#)
- AUTO program, automatic climate control [288](#)
- Auto Start/Stop function [131](#)
- Average consumption, see Trip data [160](#)
- Axle loads, approved [411](#)
- ## B
- Backrest curvature, see Lumbar support [106](#)
- Backrest, seats [104](#)
- Backrest tilt [105](#)
- Backrest tilt, rear seats [109](#)
- Backrest width [106](#)
- Back-up Assistant [276](#)
- Ball head, removable [335](#)
- Bandages, see First-aid kit [395](#)
- Bar for tow-starting/towing [401](#)
- Base position, rear seats [109](#)
- Battery, disposal [394](#)
- Battery, vehicle [392](#)
- Being towed, see Tow-starting and towing [400](#)
- Belts, see Seat belts [113](#)
- Belt tension [113](#)
- Beverage holder, front [314](#)
- Beverage holder, rear [315](#)
- Blind spot collision warning [197](#)
- Blocking, power window, see Safety switch [98](#)
- Blower, see Air flow [290](#)
- Bluetooth audio, see Owner's Manual for Navigation, Entertainment, Communication [6](#)
- Bluetooth connection, see Owner's Manual for Navigation, Entertainment, Communication [6](#)
- BMW Accident Assistance [397](#)
- BMW app, see Owner's Manual for Navigation, Entertainment, Communication [6](#)
- BMW Assist, see Owner's Manual for Navigation, Entertainment and Communication [6](#)
- BMW Curved Display [47](#)
- BMW Digital Key [86](#)
- BMW Drive Recorder [210](#)

BMW Gesture Control [58](#)
 BMW IconicSounds [285](#)
 BMW ID [68](#)
 BMW iDrive [44](#)
 BMW Intelligent Personal Assistant [53](#)
 BMW Live Cockpit Plus, see BMW Curved Display [47](#)
 BMW Live Cockpit Professional, see BMW Curved Display [47](#)
 BMW maintenance system, see Maintenance system [388](#)
 BMW Natural Interaction, see BMW Gesture Control [58](#)
 BMW Operating System, see BMW iDrive [44](#)
 BMW Roadside Assistance [396](#)
 BMW SIM Reader, see Owner's Manual for Navigation, Entertainment, Communication [6](#)
 BMW Theater Screen, see Owner's Manual for Navigation, Entertainment, Communication [6](#)
 BMW xDrive [218](#)
 Bottle holder, front, see Cup holder, front [314](#)
 Bottle holder, rear, see Cup holder, rear [315](#)
 Brake assistant [216](#)
 Brake Controller [340](#)
 Brake disks, see Brake system [328](#)
 Brake pads, see Brake system [328](#)
 Brake system [328](#)
 Braking, information [331](#)
 Breakdown assistance [395](#)
 Break-in [328](#)
 Break-in procedures [328](#)
 Break recommendation, see Fatigue alert [214](#)
 Brightness, control display [48](#)
 Button, central locking system [90](#)
 Buttons on the steering wheel [30](#)
 Button, SOS, see Intelligent emergency call [398](#)
 Button, Start/Stop, driving [130](#)
 Bypassing, see Jump-starting [399](#)

C

Cable for tow-starting/towing [401](#)
 Calibration of the front seats [107](#)
 California Proposition 65 Warning [9](#)
 Call, gesture control [59](#)

Camera cleaning [408](#)
 Camera, instrument cluster, see Driver Attention Camera [215](#)
 Camera lenses, care [408](#)
 Camera perspective, automatic [255](#)
 Camera perspective, semi-automatic [255](#)
 Camera, rearview camera [254](#)
 Cameras, see Vehicle sensors [35](#)
 Camera view aid lines [252](#)
 CANCEL button, see Speed control systems [224](#)
 Care [404](#)
 Care, displays, screens [407](#)
 Care, Head-up display [407](#)
 Care, light-alloy wheels [407](#)
 Care, vehicle [405](#)
 Cargo [318](#)
 Cargo area [318](#)
 Cargo area, enlarging [320](#)
 Cargo area partition net [325](#)
 Cargo cover [322](#)
 Cargo straps, see Lashing eyes in the cargo area [319](#)
 Car key, see Vehicle key [73](#)
 Carpet, care [408](#)
 Car seats, see Transporting children safely [123](#)
 Cartridge replacement, see Ambient Air package [297](#)
 Car wash [404](#)
 Car wash, automatic [404](#)
 Car wash view [257](#)
 Catalytic converter, see Hot exhaust gas system [329](#)
 CBS, see Condition Based Service [388](#)
 Cell phone, see Owner's Manual for Navigation, Entertainment and Communication [6](#)
 Center armrest, front [313](#)
 Center armrest, rear [314](#)
 Center console [32](#)
 Central display area, instrument cluster [159](#)
 Central Information Display (CID), see Control display [48](#)
 Central locking switch, see Central locking system [90](#)
 Central locking system [90](#)
 Central screen, see Control display [48](#)

- Changes, technical, see For Your Own Safety [8](#)
- Change, wheels and tires [354](#)
- Changing parts [391](#)
- Changing wheels [372](#)
- Charging cradle [309](#)
- Charging smartphone, see Wireless charging tray [309](#)
- Charging tray for smartphones, see Wireless charging tray [309](#)
- Chassis number, see Vehicle identification number [13](#)
- Check Control [148](#)
- Checking the engine oil level, electronic [383](#)
- Checking the oil level, electronic [383](#)
- Children, seating position [123](#)
- Children, transporting safely [123](#)
- Child restraint seats [123](#)
- Child restraint system LATCH [126](#)
- Child restraint systems, mounting [124](#)
- Child restraint systems, see Transporting children safely [123](#)
- Child safety latch [128](#)
- Child safety locks [128](#)
- Child seat installation [124](#)
- Child seat, mounting [124](#)
- Child seats, see Transporting children safely [123](#)
- Chrome-plated surfaces, care [407](#)
- Chrome surfaces, care [407](#)
- Cleaning, see Care [405](#)
- Climate control [286](#)
- Closing with the Key Card [85](#)
- Closing with the smartphone, see BMW Digital Key [86](#)
- Clothes hooks [316](#)
- Coasting [343](#)
- Coasting with idling engine [343](#)
- Coat hooks [316](#)
- Collision warning systems [181](#)
- Comfort Access [79](#)
- COMFORT, see Driving Experience Control [138](#)
- Communication, see Owner's Manual for Navigation, Entertainment and Communication [6](#)
- Compact wheel, see Emergency wheel [376](#)
- Comparison of entries, see Entry comparison [46](#)
- Compartments in the doors [313](#)
- Compressor [358](#)
- Concierge Service, see BMW Assist [396](#)
- Condensation water under the parked vehicle [332](#)
- Condensation, windshield [293](#)
- Condition Based Service [388](#)
- ConnectedDrive, see Owner's Manual for Navigation, Entertainment and Communication [6](#)
- ConnectedDrive services, see Owner's Manual for Navigation, Entertainment and Communication [6](#)
- Connected Music, see Owner's Manual for Navigation, Entertainment, Communication [6](#)
- Connecting mobile devices to the vehicle [60](#)
- Connection, electrical devices, see Sockets [306](#)
- Consumption, see Trip data [160](#)
- Contactless trunk opening/closing [83](#)
- Contacts, see Owner's Manual for Navigation, Entertainment, Communication [6](#)
- Continued driving with a flat tire, see Tire Pressure Monitor [362](#)
- Continued driving with flat tire, see Flat tire monitor [370](#)
- Control display [48](#)
- Controller [49](#)
- Control systems, driving stability [216](#)
- Convoy Assistant, Assisted Driving Mode Plus, see Speed control systems [224](#)
- Coolant [385](#)
- Coolant level [386](#)
- Coolant temperature, see Engine temperature [158](#)
- Cooling, maximum [292](#)
- Cooling system [385](#)
- Cornering light [172](#)
- Corrosion, brake disks [332](#)
- Cosmetic mirror [306](#)
- Cross Traffic Warning [207](#)
- Cruise Control, Cruise Control, see Speed control systems [224](#)
- Cruise Control, see Speed control systems [224](#)
- Cruising range [163](#)
- Cup holder, front [314](#)
- Cup holder, rear [315](#)

Cup holder, third row of seats [316](#)
 Current driving condition [164](#)
 Curved Display [47](#)
 Cushions in 6-seater [119](#)
 Customer support [396](#)

D

Damage, tires [354](#)
 Dashboard [30](#)
 Dashboard, see Instrument cluster [145](#)
 Dashcam, see BMW Drive Recorder [210](#)
 Data memory [10](#)
 Data protection, settings [67](#)
 Data, see Personal data, deleting [67](#)
 Data, technical [410](#)
 Date [162](#)
 Day, see Date [162](#)
 Daytime driving lights [171](#)
 Daytime running lights [171](#)
 Deep sleep mode [41](#)
 Defrosting, windshield [293](#)
 Deleting, personal data [67](#)
 Departure schedule, see Pre-ventilation [300](#)
 Departure time, pre-conditioning via Remote Engine Start [302](#)
 Departure time, pre-ventilation [300](#)
 Destination input [6](#)
 Diagnostic connection [389](#)
 Diagnostic socket [389](#)
 Differential lock [219](#)
 Digital Key [86](#)
 Digital key, see BMW Digital Key [86](#)
 Dimensions [410](#)
 Dimmable interior mirror [121](#)
 Dimming exterior mirror [120](#)
 Direct dial buttons, see Shortcuts [47](#)
 Display and operating concept, see BMW iDrive [44](#)
 Display, iDrive [46](#)
 Displaying information on parking assistance, see Assisted View [161](#)
 Display lighting, see Instrument lighting [172](#)
 Display panel, see Instrument cluster [145](#)
 Displays [145](#)
 Displays and icons [7](#)

Displays, BMW xDrive [218](#)
 Displays for the vehicle, see Live Vehicle [146](#)
 Display speed limit, see Speed Limit Info [222](#)
 Display SPRINT [138](#)
 Disposal, coolant [386](#)
 Disposal, vehicle battery [394](#)
 Distance Control, see Speed control systems [224](#)
 Distance to vehicle driving ahead, see Speed control systems [224](#)
 Distance Warning, see Park Distance Control [261](#)
 Door handle lighting, see Welcome lights [170](#)
 Door opening angle [259](#)
 Downhill control, see Hill Descent Control [219](#)
 Drawbar nose weight, technical data [411](#)
 Drive-off monitoring [265](#)
 Drive power reduced [156](#)
 Driver activity, see Driver Attention Camera [215](#)
 Driver Assistance, parking, see Parking assistance systems [249](#)
 Driver assistance systems [222](#)
 Driver Attention Camera [215](#)
 Drive-ready state, see Operating state of vehicle [40](#)
 Drive Recorder [210](#)
 Driver profiles [68](#)
 Driver profiles, welcome screen [68](#)
 Drive sound, see BMW IconicSounds [285](#)
 Driving [130](#)
 Driving Assistant, see Collision warning systems [181](#)
 Driving comfort [279](#)
 Driving condition, display [164](#)
 Driving Experience Control [138](#)
 Driving mode, see Driving Experience Control [138](#)
 Driving notes [328](#)
 Driving on poor roads [328](#)
 Driving stability control systems [216](#)
 Driving through flood [331](#)
 Driving through water [331](#)
 Driving tips, see General driving notes [329](#)
 DSC, see Dynamic Stability Control [216](#)
 Dynamic Drive [279](#)
 Dynamic Stability Control [216](#)

Dynamic Traction Control [218](#)

E

ECO PRO, see Driving Experience Control [138](#)

Efficiency Coach, Efficient mode [344](#)

Efficient rolling, see Current driving condition [164](#)

Electronic oil measurement [383](#)

Electronic stability program, see Dynamic Stability Control [216](#)

Emergency brake, see Emergency Stop Assistant [206](#)

Emergency braking, see PostCrash iBrake [213](#)

Emergency call [398](#)

Emergency release, fuel filler flap [347](#)

Emergency release, transmission lock [136](#)

Emergency Stop Assistant [206](#)

Emergency unlocking, rear seat backrest [112](#)

Emergency wheel [376](#)

Emissions, see Exhaust emissions [389](#)

Energy savings, see Gear shift indicator [156](#)

Engine, automatic Start/Stop function [131](#)

Engine compartment [378](#)

Engine coolant [385](#)

Engine idling when driving, see Coasting [343](#)

Engine noise, artificial, see Acoustic pedestrian protection [130](#)

Engine oil filler neck [384](#)

Engine oil, refilling [384](#)

Engine oil types to add [384](#)

Engine sound, see BMW IconicSounds [285](#)

Engine start, see Drive-ready state [42](#)

Engine start, see Jump-starting [399](#)

Engine stopping, see Drive-ready state [42](#)

Engine temperature [158](#)

Entering a destination, see Owner's Manual for Navigation, Entertainment, Communication [6](#)

Entering an address, navigation, see Owner's Manual for Navigation, Entertainment and Communication [6](#)

Entertainment, see Owner's Manual for Navigation, Entertainment and Communication [6](#)

Entertainment, selection list in the instrument cluster [155](#)

Entry comparison [46](#)

Error indicators, see Check Control [148](#)

eSIM telephony, see Owner's Manual for Navigation, Entertainment, Communication [6](#)

ESP, see Dynamic Stability Control [216](#)

Evasion Assistant, see Forward Collision Mitigation [183](#)

Event Data Recorder EDR [13](#)

Exchange, wheels and tires [354](#)

Executive Drive Pro [279](#)

Exhaust emissions [389](#)

Exhaust gas particulate filter [330](#)

Exhaust gas system [329](#)

Exhaust, see Exhaust gas system [329](#)

Exit Warning [192](#)

Exterior lighting, locked vehicle [171](#)

Exterior mirror [119](#)

Exterior mirror, Automatic Curb Monitor [120](#)

Exterior mirror cameras, see Vehicle sensors [35](#)

External start, see Jump-starting [399](#)

Eye for towing [402](#)

Eyes, see Lashing eyes in the cargo area [319](#)

F

Factory settings, see Vehicle data, resetting [67](#)

Failure message, see Check Control [148](#)

Fan after run, see Exhaust gas particulate filter [330](#)

Fastening seat belts, see Seat belts [113](#)

Fatigue Alert [214](#)

Fatigue Alert, see Driver Attention Camera [215](#)

Fatigue warner, see Fatigue Alert [214](#)

Fault indicators, see Check Control [148](#)

Filler neck for engine oil [384](#)

Filter, see Interior filter [297](#)

Fine wood parts, care [407](#)

First-aid kit [395](#)

Fittings for trailer safety chain, trailer towing [335](#)

Flat tire, changing wheels [372](#)

Flat tire, continued driving, see Flat tire monitor [370](#)

Flat tire, continued driving, see Tire Pressure Monitor [362](#)

Flat tire message, see Flat tire monitor [370](#)

Flat tire message, see Tire Pressure Monitor [366](#)
 Flat tire monitor [370](#)
 Flat tire, repairing [357](#)
 Flat tire, see Flat tire monitor [370](#)
 Flat tire, see Tire Pressure Monitor [362](#)
 Flat tire warning light, see Flat tire monitor [370](#)
 Flat tire warning light, see Tire Pressure Monitor [366](#)
 Floor carpet, care [408](#)
 Floor mats, care [408](#)
 Fold-away position, wiper [177](#)
 Fold-out position [177](#)
 Foot brake [331](#)
 Forward Collision Mitigation [183](#)
 Forward Collision Warning, see Forward Collision Mitigation [183](#)
 For Your Own Safety [8](#)
 Fragrance cartridge, see Ambient Air package [297](#)
 Fragrance, see Ambient Air package [297](#)
 Fragrancing, see Ambient Air package [297](#)
 Front airbags [178](#)
 Front camera, see Vehicle sensors [35](#)
 Front lights, replacing, see Lights and bulbs [392](#)
 Front passenger's side exterior mirror, tilting down, see Automatic Curb Monitor [120](#)
 Front passenger airbags, automatic deactivation [180](#)
 Front passenger seat functionality [107](#)
 Front radar sensor, see Vehicle sensors [35](#)
 Front-seat passenger airbag, indicator light [181](#)
 Front seats [104](#)
 Fuel [381](#)
 Fuel filler cap [346](#)
 Fuel filler flap [346](#)
 Fuel gauge [163](#)
 Fuel quality [381](#)
 Fuel recommendation [381](#)
 Fuel tank, see Filling capacity [412](#)
 Fuses [394](#)

G

Garage door opener, see Integrated Universal Remote Control [304](#)
 Gasoline [381](#)
 Gasoline particulate filter, see Exhaust gas particulate filter [330](#)
 Gasoline particulate filter, see Exhaust particulate filter [330](#)
 Gasoline quality [382](#)
 Gear change, Steptronic transmission [133](#)
 Gear position, see Steptronic transmission [133](#)
 General driving notes [329](#)
 Gentleman function, see Front passenger seat functionality [107](#)
 Gesture Control [58](#)
 Gestures, see BMW Gesture Control [58](#)
 Glare shield, see Sun visor [306](#)
 Glass sunroof [99](#)
 Glass sunroof, initializing the glass sunroof and sun protection [103](#)
 Glove compartment [312](#)
 G-Meter [162](#)
 GPS navigation, navigation, see Owner's Manual for Navigation, Entertainment, Communication [6](#)
 Gross vehicle weight, approved [411](#)
 Gross vehicle weight, trailer mode [411](#)
 Ground clearance, see xOFFROAD package [282](#)
 Guest profile, see BMW ID [68](#)

H

Handbrake, see Parking brake [140](#)
 Hand-held transmitter, alternating code [305](#)
 Hands-free device, see Owner's Manual for Navigation, Entertainment, Communication [6](#)
 Hands-free system [6](#)
 Hazard warning system [395](#)
 HDC, see Hill Descent Control [219](#)
 Head airbag [179](#)
 Headlight control, automatic [169](#)
 Headlight flasher [166](#)
 Headlight glass [392](#)
 Headlights, care [405](#)

- Headlights, replacing, see Lights and bulbs [392](#)
 - Headlights, turning up, dimming, see Automatic High Beam Assistant [167](#)
 - Headliner [34](#)
 - Head restraint pillow [118](#)
 - Head restraints and seats [104](#)
 - Head restraints, front [115](#)
 - Head restraints, rear [117](#)
 - Head-up display [147](#)
 - Head-up display, care [407](#)
 - Head-up display, store position, see Memory function [121](#)
 - Heated steering wheel [295](#)
 - Heavy cargo, stowing [319](#)
 - Height, vehicle [410](#)
 - High-beam headlights [166](#)
 - Highway Assistant, Assisted Driving Mode Plus, see Speed control systems [224](#)
 - Hill Descent Control [219](#)
 - Hills [332](#)
 - HomeLink, see Integrated Universal Remote Control [304](#)
 - Homepage, see Internet [7](#)
 - Hood [378](#)
 - Horn [30](#)
 - Hotel function, see Valet parking mode [91](#)
 - Hot exhaust gas system [329](#)
 - Hotline, see Customer support [396](#)
 - Hour, see Time [162](#)
- I**
- iBrake PostCrash [213](#)
 - Ice warning, see Outside temperature [158](#)
 - IconicSounds [285](#)
 - Icons and displays [7](#)
 - Identification marks, tires [351](#)
 - Identification number, see Vehicle identification number [13](#)
 - Idle state, see Operating state of vehicle [40](#)
 - iDrive [44](#)
 - Inclination [105](#)
 - Indicator light, front-seat passenger airbag [181](#)
 - Indicator lights [149](#)
 - Individual air distribution [291](#)
 - Individual settings, see BMW ID [68](#)
 - Inductive charging, smartphone, see Wireless charging tray [309](#)
 - Information [6](#)
 - Information on Driver Assistance, displaying, see Assisted View [161](#)
 - Information window, control display [47](#)
 - Initialization, see flat tire monitor [370](#)
 - Input, iDrive [46](#)
 - Installation of child restraint systems [124](#)
 - Instrument cluster [145](#)
 - Instrument lighting [172](#)
 - Instrument panel, see Instrument cluster [145](#)
 - Integral Active Steering [221](#)
 - Integrated key [74](#)
 - Integrated Owner's Manual in the vehicle [6](#)
 - Integrated Universal Remote Control [304](#)
 - Intelligent emergency call [398](#)
 - Intelligent Personal Assistant [53](#)
 - Intended use [8](#)
 - Interior equipment [304](#)
 - Interior filter [297](#)
 - Interior lights [172](#)
 - Interior lights, locked vehicle [171](#)
 - Interior mirror [121](#)
 - Interior mirror, automatic dimming feature [121](#)
 - Interior motion sensor [95](#)
 - Internet page [7](#)
 - Intersection Collision Warning, see Forward Collision Mitigation [183](#)
 - Interval indicator, see Service notifications [165](#)
 - Ionization, see Ambient air package [297](#)
 - Ionizer [297](#)
- J**
- Jacking points [375](#)
 - Jacking points for the vehicle jack [375](#)
 - Journey data [160](#)
 - Joystick, Steptronic transmission [133](#)
 - Jump-starting [399](#)
 - Jump-starting terminals [399](#)
 - Jump-start terminals [399](#)

K

- Key Card [85](#)
- Keyless Go, see Comfort Access [79](#)
- Key, mechanical [74](#)
- Key, see Vehicle key [73](#)
- Kickdown, Steptronic transmission [133](#)
- Knee airbag [179](#)

L

- Labeling [351](#)
- Lane boundary [193](#)
- Lane Change Assistant [239](#)
- Lane change with active destination guidance [247](#)
- Lane departure warning [193](#)
- Lane Keeping Assistant with active side collision protection, see Side Collision Warning [200](#)
- Lane keeping, Assisted Driving Mode, see Speed control systems [224](#)
- Lane lines, additional camera view displays [252](#)
- Lane threshold, warning [193](#)
- Language, setting [55](#)
- Lashing eyes in the cargo area [319](#)
- LATCH child restraint system [126](#)
- Lateral Parking Aid [255](#)
- Launch Control [137](#)
- Leather care [406](#)
- LED headlights, changing, see Lights and bulbs [392](#)
- Length, vehicle [410](#)
- Letters and numbers, entering [46](#)
- Level control, see Two-axle level control [279](#)
- Light-alloy wheels, care [407](#)
- Light carpet, see Welcome Light Carpet [170](#)
- Light in exterior mirror, see Active Blind Spot Detection [197](#)
- Light in exterior mirror, see Cross Traffic Warning [207](#)
- Lighting [168](#)
- Lighting, speakers [174](#)
- Light replacement, see Lights and bulbs [392](#)
- Lights [166](#)

- Lights and bulbs [392](#)
- Lights, care [405](#)
- Light switch [168](#)
- List, instrument cluster, see Selection lists [155](#)
- Live Cockpit Plus, see BMW Curved Display [47](#)
- Live Cockpit Professional, see BMW Curved Display [47](#)
- Live Vehicle [146](#)
- Load [319](#)
- Loading [318](#)
- Loading the cargo area, see Cargo [318](#)
- Local time, see Time [162](#)
- Locking, see Opening and Closing [73](#)
- Locking, settings [91](#)
- Locking the rear automatic climate control [288](#)
- Lock, lug bolts [374](#)
- Long stationary periods, see Deep sleep mode [41](#)
- Loop, see Towing eye [402](#)
- Low-beam headlights [170](#)
- Lower back support, see Lumbar support [106](#)
- Lug bolt lock [374](#)
- Luggage net [325](#)
- Luggage rack, refer to Roof bars [332](#)
- Luggage straps [319](#)
- Lumbar massage, see Seat massage [107](#)
- Lumbar support [106](#)

M

- Maintenance [388](#)
- Maintenance recommendation, see Condition Based Service [388](#)
- Maintenance system [388](#)
- Make-up mirror [306](#)
- Malfunction, vehicle key [76](#)
- Maneuver Assistant [271](#)
- Manual brake, see Parking brake [140](#)
- Manually unlocking doors, see Integrated key [74](#)
- Manual mode, transmission [136](#)
- Map, see Owner's Manual for Navigation, Entertainment, Communication [6](#)
- Map update, see Owner's Manual for Navigation, Entertainment, Communication [6](#)
- Marking, run-flat tire [357](#)

Matte paintwork [406](#)
Matt paint, care [406](#)
Maximum cooling [292](#)
Maximum speed, display, see Speed Limit Info [222](#)
Maximum speed, winter tires [356](#)
Medical supplies, see First-aid kit [395](#)
Memory function [121](#)
Messages, see Check Control [148](#)
Messages, see Owner's Manual for Navigation, Entertainment, Communication [6](#)
Meters, see Instrument cluster [145](#)
Microfilter, see Interior filter [297](#)
Mild Hybrid technology [393](#)
Minimum tread depth, tires [353](#)
Minute, see Time [162](#)
Mobile communications in the vehicle [330](#)
Mobile devices, connecting [60](#)
Mobile phone, see Owner's Manual for Navigation, Entertainment and Communication [6](#)
Mobile Service, see BMW Accident Assistance [397](#)
Mobile Service, see BMW Roadside Assistance [396](#)
Mobility system, see Tire repair set [358](#)
MODE button, see Speed control systems [224](#)
Modifications, technical, see For Your Own Safety [8](#)
Moisture in headlight, see Headlight glass [392](#)
Monitor, see Control display [48](#)
Mount for trailer hitch, care [408](#)
Mounting of child restraint systems [124](#)
MP3 player, see Owner's Manual for Navigation, Entertainment, Communication [6](#)
M Sport differential [219](#)
Mug holder, front, see Cup holder, front [314](#)
Mug holder, rear, see Cup holder, rear [315](#)
Multi-function steering wheel [30](#)
Multifunction steering wheel, buttons [30](#)
My BMW app, see Owner's Manual for Navigation, Entertainment, Communication [6](#)

N

Neck restraints, front, see Head restraints, front [115](#)
Neck restraints, rear, see Head restraints, rear [117](#)
Net, cargo area [319](#)
Neutral cleaner, see Light-alloy wheels, care [407](#)
Notifications, see Owner's Manual for Navigation, Entertainment, Communication [6](#)
No-touch opening and closing of the tailgate [83](#)
No Turn on Red function [205](#)
Nylon rope for tow-starting/towing [401](#)

O

OBD, see On-board diagnosis [389](#)
Obstacle marking, additional camera view displays [252](#)
Octane number, see Gasoline quality [382](#)
Odometer, see Trip data [160](#)
OFF indicator, see Standby and drive-ready state [158](#)
Off-road capability, see xOFFROAD package [282](#)
Off-road driving, see Driving on poor roads [328](#)
Oil filler neck [384](#)
Oil, refilling [384](#)
Oil service interval, see Service notifications [165](#)
Oil types to add, engine [384](#)
Old battery [394](#)
On-board computer, see Trip data [160](#)
On-board diagnosis [389](#)
Onboard toolkit [391](#)
On-call service, see BMW Accident Assistance [397](#)
On-call service, see BMW Roadside Assistance [396](#)
One-touch signaling [166](#)
Opening and closing [73](#)
Opening and closing the cargo area [81](#)
Opening and closing the tailgate [81](#)
Opening with the Key Card [85](#)
Opening with the smartphone, see BMW Digital Key [86](#)
Operating fluids [381](#)

Operating principle, see BMW iDrive [44](#)
 Operating state of vehicle [40](#)
 Operating system, see BMW iDrive [44](#)
 Operating temperature, see Engine temperature [158](#)
 Operation via voice [53](#)
 Optional equipment, see Vehicle equipment [8](#)
 Outside temperature [158](#)
 Overheating of the engine, see Engine temperature [158](#)
 Overwintering, see Long-term vehicle storage [389](#)
 Owner's Manual via voice operation, BMW Intelligent Personal Assistant [55](#)

P

Paint, vehicle care [406](#)
 Paintwork [406](#)
 Panic alarm, see Panic mode [94](#)
 Panic mode [94](#)
 Panorama View [258](#)
 Panorama View, see Panorama View [258](#)
 Panoramic display, see Owner's Manual for Navigation, Entertainment, Communication [6](#)
 Panoramic glass sunroof, see Glass sunroof [99](#)
 Park Distance Control [261](#)
 Parking aid lines, additional camera view displays [252](#)
 Parking assistance systems [249](#)
 Parking assistant [266](#)
 Parking Assistant Professional, see Parking assistance systems [249](#)
 Parking Assistant, see Park Distance Control [261](#)
 Parking Assistant, see Parking assistance systems [249](#)
 Parking brake [140](#)
 Parking brake function, see Active Park Distance Control [264](#)
 Parking lights [169](#)
 Parking view, gesture control [59](#)
 Parking with Automatic Hold [142](#)
 Particulate filter, see Exhaust gas particulate filter [330](#)

Partition net [325](#)
 Parts and accessories [9](#)
 Pathway lighting [171](#)
 Pathway lighting, turning on [171](#)
 Payload [319](#)
 Payload, technical data [411](#)
 PDC, see Park Distance Control [261](#)
 Pedestrian protection, acoustic [130](#)
 Pedestrian Warning, see Forward Collision Mitigation [183](#)
 Performance display, see Sport displays [164](#)
 Personal Assistant [53](#)
 Personal data, deleting [67](#)
 Personal eSIM, see Owner's Manual for Navigation, Entertainment, Communication [6](#)
 Personal hotspot, see Owner's Manual for Navigation, Entertainment, Communication [6](#)
 Personal profile, see BMW ID [68](#)
 Personal settings [67](#)
 Physical units, see Setting units of measurement [163](#)
 Pillow for head restraints in the rear [118](#)
 Plastic parts, care [407](#)
 Pollutant emissions, see Exhaust emissions [389](#)
 Pop-up [47](#)
 Possible gestures, gesture control [59](#)
 PostCrash iBrake [213](#)
 Power Display, instrument cluster [156](#)
 Power failure [393](#)
 Power interruption [393](#)
 Power Meter, see Power Display [156](#)
 Power windows [95](#)
 Pre-conditioning through Remote Engine Start [301](#)
 Pressure monitor, tire, see Tire Pressure Monitor [362](#)
 Pressure, tires [348](#)
 Pressure warning, see Flat tire monitor [370](#)
 Pressure warning, see Tire Pressure Monitor [362](#)
 Pretensioning, seat belt [113](#)
 Pre-ventilation [300](#)
 Prevention of rear-end collision, see Rear-end collision preparation [201](#)
 Primary user, see BMW ID [69](#)

Protective function, glass sunroof, see Anti-trap mechanism [102](#)
Protective function, windows, see Anti-trap mechanism [97](#)
Push-and-turn reel, see Controller [49](#)

R

Racing track [333](#)
Radar sensors, see Vehicle sensors [35](#)
Radiator fan, see Exhaust gas particulate filter [330](#)
Radiator fluid [385](#)
Radio information, see Owner's Manual for Navigation, Entertainment, Communication [6](#)
Radio, see Owner's Manual for Navigation, Entertainment and Communication [6](#)
Radio stations, see Owner's Manual for Navigation, Entertainment, Communication [6](#)
Rain sensor [175](#)
Rain sensor mode [175](#)
READY indicator, see Standby and drive-ready state [158](#)
Rear automatic climate control [286](#)
Rear carrier [341](#)
Rear-end collision preparation [201](#)
Rear lights, replacing, see Lights and bulbs [392](#)
Rear-mounted luggage rack, see Rear carrier [341](#)
Rear seat backrests, folding down [320](#)
Rear seat backrest tilt [109](#)
Rear seats [108](#)
Rearview camera [254](#)
Rearview camera, see Vehicle sensors [35](#)
Rear-view mirror, exterior [119](#)
Rear-view mirror, interior [121](#)
Rear-wheel steering, see Integral Active Steering [221](#)
Rear window defroster [293](#)
Rear window wiper, operation [176](#)
Rear wiper [176](#)
Recirculated-air mode [292](#)
Recirculating air filter, see Interior filter [297](#)
Recommended tire brands [355](#)
Recuperation, adaptive [342](#)
Reduced drive power [156](#)
Refueling [346](#)
Release fuel filler flap, manual [347](#)
Remote 3D View [260](#)
Remote control, see Remote Control Parking [275](#)
Remote control, see Vehicle key [73](#)
Remote control, universal [304](#)
Remote Engine Start, see Pre-conditioning [301](#)
Remote parking [275](#)
Remote services, see Owner's Manual for Navigation, Entertainment, Communication [6](#)
Remote Software Upgrade [63](#)
Renewal, wheels and tires [354](#)
Replacement, wheels and tires [354](#)
Replacing bulbs, see Lights and bulbs [392](#)
Replacing light diodes, see Lights and bulbs [392](#)
Replacing parts [391](#)
Replacing the battery, vehicle key [74](#)
Reporting safety malfunctions [14](#)
Reserve warning, see Range [163](#)
Reservoir, washer fluid [386](#)
Resetting, vehicle data [67](#)
Reset, Tire Pressure Monitor [365](#)
Reset, vehicle settings [67](#)
Restricted Driving, see BMW Digital Key [86](#)
RESUME button, see Speed control systems [224](#)
Retreaded tires [355](#)
Reversing Assistant [276](#)
Reversing Assistant Professional [276](#)
Risk of collision when exiting [192](#)
Roadside Assistance, see BMW Roadside Assistance [396](#)
Roadside parking lights [170](#)
Roller cover for luggage compartment, see Cargo cover [322](#)
Roller sunblinds, rear side windows [97](#)
Rolling code hand-held transmitter [305](#)
Rolling to a stop with engine decoupled, see Coasting [343](#)
Roll stabilization, see Active roll stabilization [279](#)
RON, see gasoline quality [382](#)
Roof bars [332](#)

Roofliner [34](#)
 Roof luggage rack, refer to Roof bars [332](#)
 Rope for tow-starting/towing [401](#)
 Rough roads [328](#)
 Route and Intersection Assistant, see Adjusting speed to route [245](#)
 Route, navigation, see Owner's Manual for Navigation, Entertainment, Communication [6](#)
 RSC, see Runflat tires [357](#)
 Rubber components, care [407](#)
 Runflat tires [357](#)
 Runflat tires, see Runflat tires [357](#)

S

Safe braking [331](#)
 Safe Exit, see Exit warning [192](#)
 Safe Share function, see BMW Digital Key [86](#)
 Safety and warning, see Collision warning systems [181](#)
 Safety locks, doors, and windows [128](#)
 Safety package, see Active Protection [213](#)
 Safety switch, windows [98](#)
 Safety systems, see Airbags [178](#)
 Safety systems, see Collision warning systems [181](#)
 Satellite radio, see Owner's Manual for Navigation, Entertainment, Communication [6](#)
 Saved stations, see Owner's Manual for Navigation, Entertainment, Communication [6](#)
 Screen, see BMW Curved Display [47](#)
 Screen, see Control display [48](#)
 Sealant, see Tire repair set [358](#)
 Seamless mode change, see Remote Control Parking [275](#)
 Seat and armrest heating [294](#)
 Seat belt reminder, see Seat belt warning [115](#)
 Seat belts [113](#)
 Seat belts, care [408](#)
 Seat belt warning [115](#)
 Seat calibration [107](#)
 Seat heating [294](#)
 Seating position for children [123](#)
 Seat massage [107](#)
 Seats and head restraints [104](#)
 Seats, front [104](#)

Seats, rear [108](#)
 Seat ventilation, active [294](#)
 Securing, cargo [319](#)
 Selection list on the instrument cluster [155](#)
 Selector lever, Steptronic transmission [133](#)
 Semi-automatic camera perspective [255](#)
 Sensors, care [408](#)
 Service and warranty [10](#)
 Service notifications [165](#)
 Service notifications, see Condition Based Service [388](#)
 Servotronic [220](#)
 SET button, see Speed control systems [224](#)
 Setting the time, see Time [162](#)
 Setting units of measurement [163](#)
 Shift lights [159](#)
 Shift paddles on the steering wheel [136](#)
 Shift point display [156](#)
 Shift point indicator, tachometer [159](#)
 Shift recommendation for fuel-efficient driving, see Shift point display [156](#)
 Shortcuts, iDrive [47](#)
 Side airbag [178](#)
 Side Collision Warning [200](#)
 Side protection, see Automatic camera perspective [255](#)
 Side view [256](#)
 Signaling, horn [30](#)
 Signals when unlocking, see Confirmation signals [92](#)
 SIM Reader, see Owner's Manual for Navigation, Entertainment, Communication [6](#)
 Sitting safely [104](#)
 Slipperiness, see Outside temperature [158](#)
 Slippery road, see Outside temperature [158](#)
 Smallest turning circle, vehicle [410](#)
 Smartphone, see Owner's Manual for Navigation, Entertainment and Communication [6](#)
 Smartphone, using via voice control [57](#)
 Snow chains [361](#)
 Sockets, electrical devices [306](#)
 Soft-close automatic, doors [90](#)
 Soft-close automatic function [90](#)
 Software Update, see Remote Software Upgrade [63](#)

- Software Upgrade, see Remote Software Upgrade [63](#)
- Soot particulate filter, see Exhaust gas particulate filter [330](#)
- SOS button, see Intelligent emergency call [398](#)
- Sound settings, see Owner's Manual for Navigation, Entertainment, Communication [6](#)
- Sound system, see Owner's Manual for Navigation, Entertainment, Communication [6](#)
- Spare tire, see Emergency wheel [376](#)
- Speaker lighting [174](#)
- Speed control systems [224](#)
- Speed Limit Assist [243](#)
- Speed Limit Assistant [243](#)
- Speed limit device, speed limiter, see Speed control systems [224](#)
- Speed limit, display, see Speed Limit Info [222](#)
- Speed limiter, manual, see Speed control systems [224](#)
- Speed Limit Info [222](#)
- Speed warning [222](#)
- Sport differential [219](#)
- Sport displays [164](#)
- Sport program, transmission [133](#)
- SPORT, see Driving Experience Control [138](#)
- Sprint function [138](#)
- Stability control systems [216](#)
- Standard equipment, see Vehicle equipment [8](#)
- Standby state, see Operating state of vehicle [40](#)
- Start/stop, automatic function [131](#)
- Start/Stop button, driving [130](#)
- Starting aid terminals [399](#)
- Starting, see Drive-ready state [42](#)
- Starting the engine, see Drive-ready state [42](#)
- Starting the engine with the Key Card [85](#)
- Stationary periods, see Deep sleep mode [41](#)
- Stations, see Owner's Manual for Navigation, Entertainment, Communication [6](#)
- Status control display, tires [364](#)
- Status information, iDrive [45](#)
- Status of Owner's Manual [8](#)
- Status, vehicle [163](#)
- Steering column adjustment [121](#)
- Steering, see Integral Active Steering [221](#)
- Steering support, see Servotronic [220](#)
- Steering wheel, adjusting [121](#)
- Steering wheel, buttons [30](#)
- Steering wheel heating [295](#)
- Steptronic Sport transmission, see Steptronic transmission [133](#)
- Steptronic transmission [133](#)
- Stopping the engine, see Drive-ready state [42](#)
- Storage compartment, cargo area [320](#)
- Storage compartment, center console [313](#)
- Storage compartments [312](#)
- Storage, tires [356](#)
- Store Mirror position, see Memory function [121](#)
- Store seat position, see Memory function [121](#)
- Store steering wheel position, see Memory function [121](#)
- Storing the vehicle [389](#)
- Stowage, cargo [319](#)
- Straps for cargo, see Lashing eyes in the cargo area [319](#)
- Summer tires, tread [353](#)
- Sun visor [306](#)
- Supplementary Owner's Handbooks [7](#)
- Supplementary Owner's Manuals [7](#)
- Suspension settings, see Driving Experience Control [138](#)
- Swinging of trailer, see Trailer stabilization control [340](#)
- Switches, see Dashboard [30](#)
- Switch for driving dynamics, see Driving Experience Control [138](#)
- SYNC program, automatic climate control [293](#)
- System language, setting, see Language, setting [55](#)

T

- Tachometer [157](#)
- Tailgate, opening and closing with no-touch activation [83](#)
- Tail lights, replacing, see Lights and bulbs [392](#)
- Taking the vehicle out of service [389](#)
- Tank volume [412](#)
- Technical changes, see For Your Own Safety [8](#)
- Technical data [410](#)
- Telephone, see Owner's Manual for Navigation, Entertainment and Communication [6](#)

- Telephone, selection list in the instrument cluster [155](#)
- Teleservices, see Owner's Manual for Navigation, Entertainment, Communication [6](#)
- Temperature, automatic climate control [289](#)
- Temperature display, see outside temperature [158](#)
- Theft alarm system, see Alarm system [93](#)
- Thigh support [106](#)
- Third row of seats [111](#)
- Tilt alarm sensor [94](#)
- Tilt, backrest [105](#)
- Tilting down, front passenger's side exterior mirror, see Automatic Curb Monitor [120](#)
- Time [162](#)
- Time of day, see Time [162](#)
- Time setting, automatic [162](#)
- Time zone [162](#)
- Tire brands, recommendation [355](#)
- Tire change [354](#)
- Tire damage [354](#)
- Tire identification marks [351](#)
- Tire inflation pressure [348](#)
- Tire marking [351](#)
- Tire pressure [348](#)
- Tire Pressure Monitor [362](#)
- Tire pressure monitoring, see Flat tire monitor [370](#)
- Tire Pressure Monitor, reset [365](#)
- Tire pressure, tires [348](#)
- Tire pressure warning, see Flat tire monitor [370](#)
- Tire repair set [358](#)
- Tires and wheels [348](#)
- Tire sealant, see Tire repair set [358](#)
- Tire settings [363](#)
- Tires, run-flat [357](#)
- Tire tread [353](#)
- Title, gesture control [59](#)
- Tools [391](#)
- Torque display, see Sport displays [164](#)
- Touchpad, Controller [51](#)
- Tow bar [401](#)
- Towing [400](#)
- Towing eye [402](#)
- Tow rope [401](#)
- Tow-starting [400](#)
- Traction Control [218](#)
- Traction control system, see Dynamic Stability Control [216](#)
- TRACTION, driving dynamics [218](#)
- Traction, see Dynamic Traction Control [218](#)
- Traffic bulletins, see Owner's Manual for Navigation, Entertainment, Communication [6](#)
- Traffic Jam Assistant, Assisted Driving Mode Plus, see Speed control systems [224](#)
- Traffic Light And Sign Warning [202](#)
- Trailer angle, Trailer Assistant [338](#)
- Trailer Assistant [338](#)
- Trailer hitch, ball head, removable [335](#)
- Trailer hitch, care [408](#)
- Trailer hitch, mount for [335](#)
- Trailer hitch view [257](#)
- Trailer loads [411](#)
- Trailer stabilization control [340](#)
- Trailer towing [334](#), [411](#)
- Trailer towing, activation [336](#)
- Trailer towing, technical data [411](#)
- Transmission, see Steptronic transmission [133](#)
- Transporting children safely [123](#)
- Travel & Comfort System [309](#)
- Tread, tires [353](#)
- Trip data [160](#)
- Trip odometer, see Trip data [160](#)
- Trunk, see Cargo area [318](#)
- Turn indicators, see Turn signals [166](#)
- Turning circle lines, additional camera view displays [252](#)
- Turning circle, vehicle [410](#)
- Turning display, see No Turn on Red function [205](#)
- Turn signal, indicator light [153](#)
- Turn signal, replacing bulbs, see Lights and bulbs [392](#)
- Turn signals [166](#)
- Turn Warning, see Forward Collision Mitigation [183](#)
- Two-axle level control [279](#)

U

- Ultrasonic sensors, see Vehicle sensors [35](#)

Unintended alarm, see Unintentional alarm, avoiding [95](#)

Unintentional alarm, avoiding [95](#)

Units, see Setting units of measurement [163](#)

Universal remote control [304](#)

Unlocking, see Opening and Closing [73](#)

Unlocking, settings [91](#)

Unlocking the transmission lock, electronic [136](#)

Unpaved roads, see Driving on poor roads [328](#)

Updates made after the editorial deadline [8](#)

Upgrade, see Remote Software Upgrade [63](#)

Upholstery material care [406](#)

Upper backrest, front [106](#)

Upper retaining strap, top tether [127](#)

USB audio, see Owner's Manual for Navigation, Entertainment, Communication [6](#)

USB port, position in vehicle [307](#)

Used battery, disposing of [394](#)

Use, intended [8](#)

User, see BMW ID [68](#)

Using menus, see BMW iDrive [44](#)

V

Valet parking mode [91](#)

Vanity mirror [306](#)

Variable steering, see Integral Active Steering [221](#)

Vehicle battery [392](#)

Vehicle breakdown, see Breakdown assistance [395](#)

Vehicle care [405](#)

Vehicle care products [405](#)

Vehicle data, resetting [67](#)

Vehicle equipment [8](#)

Vehicle identification number [13](#)

Vehicle issues [395](#)

Vehicle key [73](#)

Vehicle key, additional [73](#)

Vehicle key, loss [74](#)

Vehicle laminated glass [330](#)

Vehicle paint, care [406](#)

Vehicle paintwork [406](#)

Vehicle sensors [35](#)

Vehicle status [163](#)

Vehicle storage [389](#)

Ventilation [295](#)

Ventilation, see Pre-ventilation [300](#)

Venting, see Ventilation [295](#)

Version Software, see Remote Software Upgrade [63](#)

Video recording, see BMW Drive Recorder [210](#)

Video, see Owner's Manual for Navigation, Entertainment and Communication [6](#)

VIN, see Vehicle identification number [13](#)

Voice activation system [53](#)

Voice control [53](#)

Voice control, see BMW Intelligent Personal Assistant [53](#)

Voice recognition [53](#)

Volume, gesture control [59](#)

Volume, see Owner's Manual for Navigation, Entertainment, Communication [6](#)

W

Wake word [54](#)

Warning for crossing traffic [207](#)

Warning function for incorrect driving direction, see Wrong Way Warning [204](#)

Warning function for oncoming traffic, see Forward Collision Mitigation [183](#)

Warning function, rear-end collision [201](#)

Warning light in exterior mirror, see Active Blind Spot Detection [197](#)

Warning light in exterior mirror, see Cross Traffic Warning [207](#)

Warning lights [149](#)

Warning messages, see Check Control [148](#)

Warning systems for collision hazards [181](#)

Warning triangle [395](#)

Warning when exiting [192](#)

Warning when opening doors, see Exit Warning [192](#)

Warranty [9](#)

Warranty Booklet, see Warranty [9](#)

Washer fluid [386](#)

Washer nozzles, windshield [176](#)

Washing the vehicle [404](#)

Washing, vehicle [404](#)

Water on road [331](#)

Water, see Condensation water under the parked vehicle [332](#)

Website, see Internet [7](#)

Weights [411](#)

Welcome Light Carpet, see Welcome light [170](#)

Welcome lights [170](#)

Welcome screen, driver profiles [68](#)

Wheelbase [410](#)

Wheel base, vehicle [410](#)

Wheel change [372](#)

Wheels and tires [348](#)

Wheels and tires, exchange [354](#)

Widgets, iDrive [45](#)

Widgets, instrument cluster, see Central display area [159](#)

Width, vehicle [410](#)

Wi-Fi connection, see Owner's Manual for Navigation, Entertainment, Communication [6](#)

Wind deflector, defrosting [293](#)

Wind deflector, removing condensation [293](#)

Window, defrosting [293](#)

Windows, powered [95](#)

Windshield cleaning system, see Wiper system [174](#)

Windshield, defrosting [293](#)

Windshield, removing condensation [293](#)

Windshield washer fluid, see Washer fluid [386](#)

Windshield washer nozzles [176](#)

Windshield wipers, see Wiper system [174](#)

Winter storage, see Long-term vehicle storage [389](#)

Winter tires [356](#)

Winter tires, tread [353](#)

Wiper blades, replacing [391](#)

Wiper fluid, see Washer fluid [386](#)

Wiper, fold-away position [177](#)

Wipers, see Wiper system [174](#)

Wiper system [174](#)

Wireless charging, smartphone, see Wireless charging tray [309](#)

Wireless charging tray for smartphones [309](#)

Wood parts, care [407](#)

Wordmatch principle, see Entry comparison [46](#)

Wrong Way Warning [204](#)

X

xDrive [218](#)

xOFFROAD package [282](#)

xView, see BMW xDrive [218](#)

Y

Yield warning [202](#)



01405B37F42 ue

California Proposition 65 Warning

For vehicles sold in California:

California Proposition 65 Warning



WARNING

Operating, servicing and maintaining a passenger vehicle or off-highway motor vehicle can expose you to chemicals including engine exhaust, carbon monoxide, phthalates, and lead, which are known to the State of California to cause cancer and birth defects or other reproductive harm. To minimize exposure, avoid breathing exhaust, do not idle the engine except as necessary, service your vehicle in a well-ventilated area and wear gloves or wash your hands frequently when servicing your vehicle. For more information go to www.P65Warnings.ca.gov/passenger-vehicle.

BMW DRIVER'S GUIDE APP.

YOUR DIGITAL VEHICLE INFORMATION.

The BMW Driver's Guide app explains the equipment of your vehicle and offers further scopes and functions:

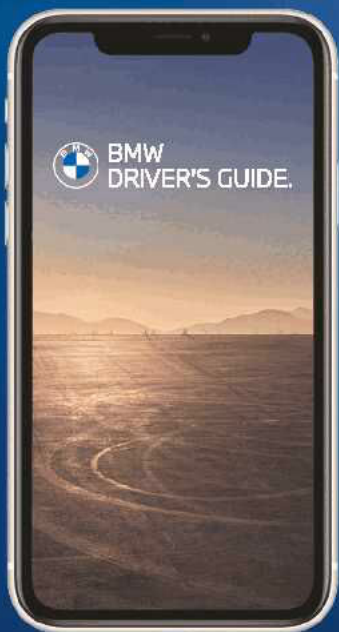

All information surrounding navigation, entertainment and communication

Photorealistic animations for various vehicle functions

Keyword search

360° view: Explore your vehicle interactively inside and out

Smart Scan for Apple iPhone: Icon and optical character recognition on the buttons in the vehicle

Available in more than 30 languages

Can be used offline after download



01405B37F42 ue

