

FOREWORD

Dear Customer,

Thank you for selecting your new Kia vehicle.

As a global car manufacturer focused on building high-quality vehicles with exceptional value, Kia is dedicated to providing you with a customer service experience that exceeds your expectations.

This Owner's Manual is valid for all variants of your model, and describes all options, features, and equipment available, along with the maintenance needs. Therefore, this manual may also describe optional equipment not purchased on your vehicle, country specifications, and functions and features not available in your region. Please always keep this manual in the vehicle for your and any subsequent owner's reference.

Authorized Kia Dealerships provide factory-trained technicians, utilized recommended special service tools, and supply genuine Kia replacement parts to help you maintain and service your vehicle during your ownership.

All information contained in this Owner's Manual was accurate at the time of publication. However, as Kia continues to make improvements to its products, the company reserves the right to make changes to this manual or any of its vehicles at any time without notice and without incurring any obligations.

Please drive safely, and enjoy your Kia vehicle!

© 2023 Kia Canada Inc.

All rights reserved. Reproduction by any means, electronic or mechanical, including photocopying, recording, or by any information storage and retrieval system or translation in whole or part is not permitted without written authorization from Kia Canada Inc.

Printed in Korea

How to use this manual

We want to help you get the greatest possible driving pleasure from your vehicle. Your Owner's Manual can assist you in many ways.

We strongly recommend that you read the entire manual. In order to minimize the chance of death or injury, you must read the WARNING and CAUTION sections in the manual.

Illustrations complement the words in this manual to best explain how to enjoy your vehicle. By reading your manual, you learn about features, important safety information, and driving tips under various road conditions.

The general layout of the manual is provided in the Table of Contents. Use the index when looking for a specific area or subject, it has an alphabetical listing of all information in your manual.

Chapters: This manual has nine chapters plus an index. Each chapter begins with a brief list of contents so you can tell at a glance if that chapter has the information you want.

You will find various WARNINGS, CAUTIONS, and NOTICES in this manual. These WARNINGS were prepared to enhance your personal safety. You should carefully read and follow ALL procedures and recommendations provided in these WARNINGS, CAUTIONS and NOTICES.

WARNING

A WARNING indicates a situation in which harm, serious bodily injury or death could result if the warning is ignored.

CAUTION

A CAUTION indicates a situation in which damage to your vehicle could result if the caution is ignored.

NOTICE

A NOTICE indicates interesting or helpful information is being provided.

Table of Contents

Electric vehicle guide	①
Introduction	②
Your vehicle at a glance	③
Safety features of your vehicle	④
Features of your vehicle	⑤
Driving your vehicle	⑥
Driver assistance system	⑦
What to do in an emergency	⑧
Maintenance	⑨
Specifications & Consumer information	⑩
Abbreviation	Ⓐ
Index	Ⓘ

Overview of electric vehicle	1-3
• Battery information.....	1-3
Main components of electric vehicle	1-3
• High voltage (HV) battery (lithium-ion).....	1-4
• High voltage battery warmer system	1-5
EV menu	1-5
• EV mode screen.....	1-6
• Energy Information	1-7
• Next Departure.....	1-7
• Charging and Climate	1-8
• Vehicle To Load (V2L)	1-9
• Nearby Stations	1-13
• EV Settings.....	1-13
Charge types for electric vehicle	1-16
• Charging information.....	1-16
• Charging time information	1-16
• Charging types.....	1-17
Charge indicator lamp for electric vehicle	1-18
• Charging status.....	1-18
Charging connector lock	1-19
• Locking charging cable	1-19
Scheduled charging	1-20
Charging electric vehicle	1-21
• Electric charging door.....	1-21
• Precautions for charging electric vehicle	1-22
• Unlock charging connector in emergency.....	1-23
• AC charge	1-24
• DC charge.....	1-28
• Portable charge (sold separately).....	1-30
Charging electric vehicle (Abrupt stop)	1-38

1 Electric vehicle guide

- Actions to be taken when charging stops abruptly..... 1-38
- Driving electric vehicle..... 1-39**
- How to start the vehicle1-39
- How to stop the vehicle.....1-39
- Virtual Engine Sound System (VESS).....1-39
- Distance to empty..... 1-40
- ECO Driving..... 1-41
- Electricity Use1-42
- Power/Charge gauge.....1-42
- State of Charge (SOC) gauge for high voltage battery1-42
- Aux. Battery Saver+ 1-43
- Warning and indicator lights (Related to electric vehicle) 1-44
- LCD display messages (Related to electric vehicle) 1-45
- Safety precautions for electric vehicle 1-50**
- If an accident occurs 1-50
- Other precautions for electric vehicle..... 1-51
- High voltage cut-off switch1-52

Electric vehicle guide

Overview of electric vehicle

Unlike a vehicle with an internal combustion engine, electric vehicles are propelled by an electric motor powered by a high-voltage battery. When decelerating or driving downhill, regenerative braking can charge the high voltage battery. This reduces energy loss and can increase the distance to empty. When the battery charge is not sufficient, AC charge (L2-Normal), DC charge and Trickle charge (L1-Trickle) are available. (Refer to "Charge types for electric vehicle" on page 1-16.)

* NOTICE

What Does Regenerative Braking Do?

It uses the electric motor when decelerating and braking and recaptures & transforms kinetic to electrical energy in order to charge the high voltage battery. (Torque is applied in the opposite direction when decelerating to generate braking force and electric energy.)

Battery information

The vehicle is composed of a high voltage battery that drives the motor, air conditioner, and charges an auxiliary battery (12V) that drives all other 12V systems.

The auxiliary battery is automatically charged when the vehicle is in the **READY** mode or the high voltage battery is being charged.

Main components of electric vehicle

- **On-Board Charger (OBC):** Transforms (inverts) AC power, to DC power, to charge the high voltage battery.
- **Inverter:** Transforms direct current into alternating current to supply power to the motor, and transforms alternating current into direct current to charge the high voltage battery.
- **LDC:** Transforms (converts) power from the high voltage battery to low voltage (12V) to supply power to the vehicle (DC-DC).
- **VCU:** Functions as a supervisory controller of electric vehicle
- **Motor:** Uses electrical energy stored inside the high voltage battery to drive the vehicle (functions like an engine in a standard vehicle).
- **Reduction gear:** Delivers rotational force of the motor to the tires at appropriate speeds and torque.
- **High voltage battery (lithium-ion):** Stores and supplies power necessary for the electric vehicle to operate (12V auxiliary battery provides power to the vehicle features such as lights and wipers).

* OBC: On-Board Charger

* LDC: Low Voltage DC-DC Converter

* VCU: Vehicle Control Unit

⚠ WARNING

- Do not remove or disassemble high voltage components and high voltage battery connectors and/or wiring (orange cabling). Also, be careful not to damage high voltage components and the high voltage battery. It may cause serious injury and significantly

impact the performance and durability of the vehicle.

- When inspection and maintenance is required for high voltage components and the high voltage battery, have the vehicle inspected by an authorized Kia dealer.

High voltage (HV) battery (lithium-ion)

- The charge of the high voltage battery may gradually decrease when the vehicle is not driven or charged.
- The battery capacity of the high voltage battery may decrease over time when the vehicle is stored in high or low temperatures.
- Distance to empty may vary depending on the driving conditions (cargo, rain, snow, wind, road surfaces), even if the charge amount is the same. The high voltage battery may expend more energy when driving a fast pace or uphill. These actions may reduce the distance to empty.
- The high voltage battery is used when using the air conditioner/heater. This may reduce the distance to empty. Make sure to set moderate temperatures when using the air conditioner/heater and/or use the pre-conditioning feature prior to departures.
- Natural degradation may occur with the high voltage battery depending on the number of years the vehicle was used and/or the number of charging cycles. This will reduce the distance to empty over time.
- When the charge capacity and distance to empty suddenly or dramatically drops, contact an authorized Kia dealer for inspection and maintenance.
- If the vehicle will not be in use for an extended period of time, charge the high voltage battery once every three months to prevent it from discharging. Also, if the vehicle battery charge is insufficient, immediately charge the vehicle to full capacity and store the vehicle.
- AC charging is recommended to keep the high voltage battery in optimal condition.
- If the high voltage battery charge amount is below 20%, you can keep the high voltage battery performance in optimal condition if you charge the high voltage battery to 100%. (Once a month or more is recommended.)
- The value of the high voltage battery charge level may vary according to the charging conditions (state of charger, outside temperature, battery temperature, etc.). In order to fully charge the battery, the current of the high voltage battery will be gradually decreased, so that the longevity and safety of the battery can be secured.

CAUTION

- Make sure to use a designated charger when charging the high voltage battery. Using non-approved or inappropriate type of chargers may have a serious impact on vehicle durability.
- If the vehicle is kept with insufficient charge for a long period, it may damage the high voltage battery and the high voltage battery may have to be replaced depending on the level of degradation.
- If the vehicle is in a collision, contact an authorized Kia dealer to inspect whether the high voltage battery is still connected.

- Using the V2L function may reduce the mileage due to the use of high voltage battery energy, and repeated use of the V2L function may cause a decrease in the life of the high voltage battery.

High voltage battery warmer system (if equipped)

The high voltage battery warmer system prevents reduction of battery output when battery temperature is low. If the charging connector is connected, the warmer system automatically operates according to the battery temperature. Charging time may shorten compare to vehicles without the high voltage battery warmer system. But, the use of electricity charge may increase because of high voltage battery warmer system operation.

* NOTICE

The high voltage battery warmer system operates when the charging connector is connected to the vehicle. However, the high voltage warmer system may not operate when battery temperature drops below -35 °C (-31 °F).

EV menu

If you select the **EV** menu at the multi-media system home screen, you can enter the **EV** menu.



- * The image of **EV** menu screen in this manual may differ from the actual screen depending on the vehicle specification and the version of the multi-media system software. For more information, please refer to the separately supplied infotainment system manual.

EV mode screen



- 1 Energy Information
- 2 Next Departure
- 3 Charging and Climate
- 4 Vehicle to Load (V2L)
- 5 Nearby Stations
- 6 EV Settings
- 7 Menu

Energy Information



Select **EV** and see the vehicle image from the infotainment system screen. You can check battery information and energy consumption.

Battery Information



A: Energy Information

- 1 DC Charger
- 2 AC Charger

You can check the estimated range, battery power remaining, and expected charging time for each charger type.

- The distance to empty is calculated based on the real-time electric energy efficiency while driving.
- The distance may change if the driving pattern changes.

Next Departure



A: Electric Vehicle

1 Next Departure

Select **EV** → **Next Departure** on the screen. You can set the date and time of when to charge the battery, climate control temperature, and other various functions.

Departure Time

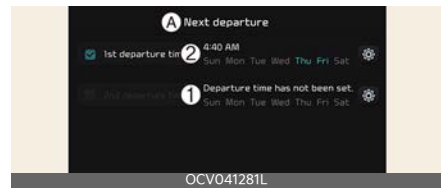

A: Next Departure

- 1 1st Departure Time
- 2 2nd Departure Time

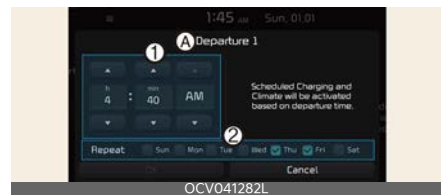

A: Departure 1

- 1 Departure Time: Set the time that you wish to start the vehicle after charging the battery.
- 2 Departure Day: Set the day of the week to activate reserved charging and target temperature for departure time.

Charging and Climate



A: Electric Vehicle

1 Scheduled Charging and Target Temperature

Select **EV** → **Charging and Climate** on the screen.

* NOTICE

Vehicle must be connected with the charging connector at the time set for pre-scheduled charging.

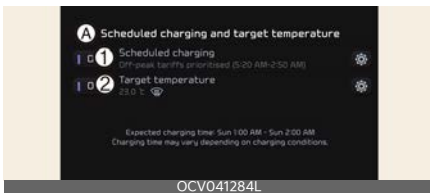

A: Scheduled Charging and Target Temperature

1 Scheduled Charging 2 Target Temperature

You can set the date and time of when to charge the battery and the climate control temperature. Also, you may select the time to start charging using the off-peak time setting.

Off-peak Hours Settings



A: Off-peak Hours Settings

- 1 **Start Time:** Charging begins at the designated off-peak time. If deselected, starts charging only on the scheduled time.
- 2 **End Time:** Set the most inexpensive time to complete charging.
- 3 **Charging mode**
 - Off-peak tariffs prioritized: If selected, starts charging at off-peak time (may keep on charging pass off-peak time to charge 100%).
 - Charge only during Off-peak: If selected, charges only within off-peak time (may not charge 100%).

* NOTICE

Off-peak charging rates for electricity may not be available everywhere. Check with your local utility for details.

Target Temperature Settings



A: Target Temperature Settings

- 1 **Set Target Temperature:** If the target temperature (1) is set with the charger connected, the cabin temperature will be adjusted to the target temperature

at departure time (without loss of high voltage battery charging level). In cold weather, pre-scheduled heating helps enhance electric vehicle performance by heating the vehicle in advance.

Vehicle To Load (V2L) (if equipped)

V2L is the system that provides AC power using the high voltage battery for driving to operate several electronic products.



OCV041287L

A: Electric Vehicle

1 EV Charge Transfer

Select **EV** → **Vehicle to Load (V2L)** on the screen.

You can set the battery discharging limit for high voltage battery for driving.

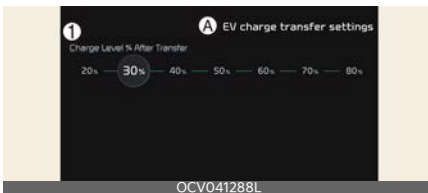

OCV041288L

A: EV Charge Transfer Settings

1 Discharging Limit

When the vehicle reaches the discharging limit, it automatically cuts the supply of electricity.

Energy information

To check the discharging level, go to the infotainment system screen and select **EV** and the vehicle image.

How to connect

Exterior

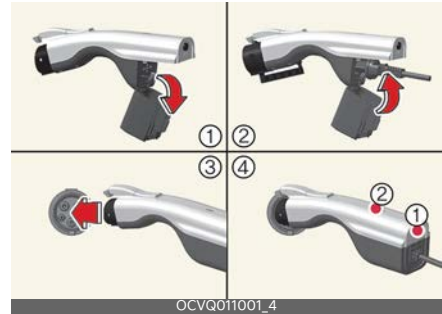

- 1 Open the cover of the V2L connector.
- 2 Close the cover after connecting compatible appliances and electronic products to the power outlet.
- 3 Connect the V2L connector to the charging hole on the vehicle.
- 4 Press the switch (1) of the V2L connector and check whether the light (2) is on or off. The light (2) may not turn on normally when:

- The battery discharging limit is set higher than the actual charge of the battery. Check the battery discharging limit for high voltage battery for driving in **Energy Consumption** menu on the screen.
- Check whether the light of V2L connector or interior power outlet turns on or not.
- If the warning message for V2L appears on the cluster, refer to "LCD display messages" on page 1-10.
- If V2L does not work the same as when connecting other compatible appliances, have your vehicle inspected by an authorized Kia dealer.

5 Press the switch (1) to turn off the light (2) the V2L will be off to stop V2L charging. You can disconnect the V2L connector when the light (2) has turned off or you have deactivated the charging door lock by pressing the door unlock button on the smart key.

Interior

1. Use the mechanical key to unlock the power outlet cover.



2. Connect to the power outlet located in the base of the rear seat with the EV button in the ON position.



3. Check the operation status through the front indicator of the power outlet.



- Blue: Standby
- Red: No power supply even though the power outlet is connected
- Green: Normal power supply through the normal connection of the power outlet.

LCD display messages

V2L has ended. Battery level has reached the set value



A: V2L has ended. Battery level has reached the set value

When the high voltage battery level reaches the discharging limit set level, the V2L will stop and the warning will be displayed. If you want to use the V2L continuously, make the discharging limit set level lower than the present battery level.

V2L stopped due to excessive power use



A: V2L stopped due to excessive power use

If you use an electrical appliance that exceeds the maximum power output the vehicle can supply, it will stop working and display a warning message. Make sure that the total power consumption of your electrical appliances does not exceed the V2L maximum power output.

V2L conditions not met



A: V2L conditions not met

If V2L is interrupted for any of the following reasons, a warning message is displayed.

- V2L connector switch off
- V2L connector overheating
- Opening the charging door while using the V2L interior outlet

Make sure there are no problems with the V2L connector and the vehicle indoor outlet.

⚠ WARNING

Electrical shock, serious injury and death can result if you disobey the following instructions:

- Do not touch the V2L connector or the terminals in the vehicle charging port.
- Do not put metal objects to the V2L connector or charging port.
- Do not touch the V2L connector, charging port or power plug with a wet hand or while standing in water or with bare feet.
- Do not use the V2L connector, charging port or power plug if they are wet or dirty. Dry and clean them first.
- Do not alter or disassemble the V2L connector.
- When the power plug is connected or disconnected to the V2L connector or you open or close the connector cover

of the V2L, be careful not to be scratched on the hand.



- Do not charge if the V2L connector, charging port, power plug or cable are damaged, corroded or rusted.
- Do not use if the sheath of home appliance cables is damaged or broken or the connection is loose.

⚠ WARNING

Do not use your vehicle as a power source for any high amperage appliances such as irons, coffee pots, and toasters. This could cause a fire, serious injury and death.

*** NOTICE**

Be aware of the precautions below to prevent accidents.

- If V2L charging has stopped before the vehicle is charged, it may be because the system has overheated. Check whether the V2L connector, charging port or power plug are contaminated, worn, corroded or broken or if the vehicle is drawing 16 amps. When the temperature falls to normal levels, you can use it again. Use only compatible appliances.
- Do not remodel or disassemble the provided V2L connector. The failure caused by remodeling or disassembling is not covered by the warranty.
- Do not drop the V2L connector or give a strong impact to it.

- Do not place objects on the V2L connector.
- Be sure to disconnect the V2L connector from the vehicle when you are finished using V2L.
- When the high voltage battery charge reaches the set discharging limit (%), the operation stops, and a warning message is displayed on the instrument cluster. If you want V2L operation, set the discharging limit (%) lower than the current battery charge.
- When using various electric appliances, use them below the maximum power capacity that can be supplied by the vehicle.
- If you use an electrical appliance that exceeds the maximum power capacity that the vehicle can supply, the operation will stop and a warning message will be displayed on the instrument cluster. Make sure the total power consumption of the electrical appliance you use does not exceed the V2L maximum power capacity.
- Some of the electric appliances may not operate normally even if the appliance has power consumption less than the maximum power capacity provided by the vehicle.
 - Electrical appliances that require high power during initial operation.
 - Measuring devices that need to process accurate data.
 - Electric appliances sensitive to inverter type AC power supply. (Inverter: A device that converts DC power into AC power)
- Do not use appliances that require a continuous power supply, such as medical equipment. The power supply may be interrupted depending on the vehicle's condition.
- Only use compatible appliances under 16 ampere.
- Insert the power plug in fully and do not use plugs that are worn, corroded or broken, not meeting the standard. An electric shock or malfunction may occur.
- Use the power plug with a ground connection.
- Do not use high power home appliances such as air conditioner, washing machine or dryer.
- Do not hang home appliances on the V2L charging cable.
- For various devices connected to a power outlet, use only appliances that have obtained national safety certification. For usage and precautions, refer to the manual of the device. (Electrical appliances, multi-outlets, cord extension cables, etc.)
- For electronic devices that are used outdoors in a vehicle, use a appliance with a waterproof function or use it in a waterproof environment. Do not use in environments with rain or high humidity. (Electrical appliances, multi-outlets, cord extension cables, etc.)
- If there is a risk of lightning, do not use the V2L function outside the vehicle.
- Do not connect portable multi-outlets.
- Make sure the extension cable is not twisted. It may cause a fire. Be sure to use the cable without twisting it.
- When using the V2L, power is also supplied to the vehicle's interior power outlet. Unplug electrical appliances that are not in use from the indoor power outlet.

- When using the V2L, the cooling fan in the vehicle motor compartment can operate automatically even if the vehicle is turned off. Do not put your hand near the cooling fan in the V2L operating state.
- Please connect the V2L connector to the charging hole within 60 seconds after the charging cover opens. To prevent theft after connecting, it is changed to auto lock automatically so that it is difficult to separate.
- When using V2L, cancel the scheduled air conditioning setting. V2L may not be available to operate if the scheduled air conditioning is being activated.
- V2L discharging mode will shut off if the vehicle is turned off using interior V2L.
- Opening the charging door or connecting the V2L connector to the charging inlet, the V2L discharging mode will shut off. If you want to use the interior and exterior V2L simultaneously, first connect the V2L connector to the charging inlet and use the indoor V2L.

Nearby Stations



A: Electric Vehicle

Select **EV** → **Map** on the screen. Stations around the current location are searched.



A: Electric Vehicle

Select 'Search for charging stations' icon on the screen.



A: Near Current Position

Around the course, around the current site, around the selected destination or charging stations of interest will be searched. If you choose the charging station, the detailed information will be provided.

For more detailed information, please refer to the separately supplied infotainment system manual.

EV Settings



A: Electric Vehicle

Select **EV** → 'Settings' icon on the screen. You can set the Battery Charge Level, Charging Current, Battery Conditioning Mode, and Utility Mode functions.

Charging Limit (Max. % Charge)

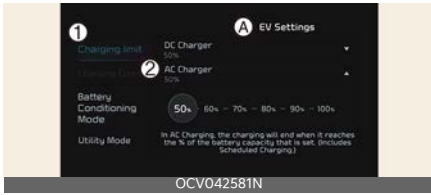

- A: EV Settings
- 1 Charging Limit
- 2 AC Charger

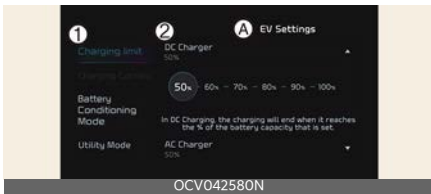

- A: EV Settings
- 1 Charging Limit
- 2 DC Charger

The target battery charge level can be selected when charged with AC charger or DC charger.

The charging level can be changed by 10%.

If the target battery charge level is lower than the high voltage battery charge level, the battery will not be charged.

Charging Current

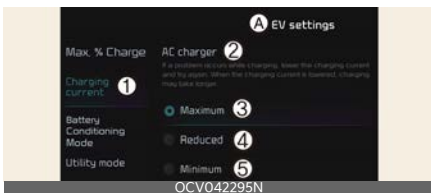

- A: EV Settings
- 1 Charging Current
- 2 AC Charger
- 3 Maximum

4 Reduced 5 Minimum

You can adjust the charging current for an AC charger. Select an appropriate charging current for the charger used.

If the charging process does not start or abruptly stops in the middle, re-select another proper current and retry charging the vehicle.

Charging time varies depending on which charging current is selected.

Battery conditioning mode (if equipped)

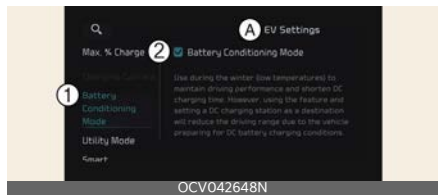

- A: EV Settings
- 1 Battery conditioning mode
- 2 Battery conditioning mode

- The Battery conditioning mode is efficient during the winter time when the high voltage battery temperature is low. This mode is recommended to improve driving and DC charging performance during winter. However, the driving distance may be reduced as the energy is required to increase battery temperature.

- If the battery temperature is low during driving, Battery conditioning mode raises the battery temperature to an adequate level. Also, if the battery temperature is low when scheduled air conditioner/heater is activated, this mode is operated to improve driving and charging performance. However, the mode is not

operated to ensure driving distance when the battery level is low.

- If you set the DC charging station as a destination in battery conditioning mode, you can reduce the charging time by raising the battery temperature to an adequate level when you arrive.
- Battery conditioning mode indicator light () appears while battery conditioning mode is operating.

* NOTICE

- This mode is available for the vehicles equipped with the battery heater.
- The infotainment system may change after software updates. For more information, refer to the manual provided in the infotainment system and the quick reference guide.

Utility Mode

When driving is not necessary such as while camping or when stopping the vehicle for a long time, it is possible to use the electrical devices (audio, lights, etc.) for long hours.

The high voltage battery is used instead, to maintain the 12V auxiliary battery, for operating the convenient 12V features of the vehicle.

System Setting and Activation

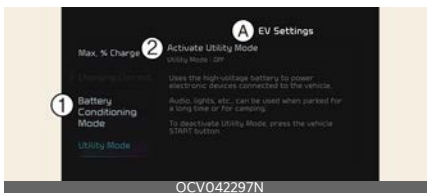

A: EV Settings

1 Utility Mode

2 Activate Utility Mode

When the following conditions are satisfied, you can activate the Utility Mode function by selecting **EV Settings** → **Utility Mode** on the screen.

- The vehicle is in the **READY** mode.
- The gear is in P (Park).
- EPB (Electronic Parking Brake) is applied.
- **EV Settings** → **Utility Mode** is selected on the infotainment system screen.

System Activation

- The **READY** indicator will turn off and the **UTIL** indicator will appear on the cluster and the EPB is applied.
- All vehicle electronics are usable but the vehicle cannot be driven.
- The EPB can be canceled by pressing the EPB switch.
- Gear cannot be shifted out of P (Park). If a shift attempt is made, **Shifting conditions not met** message will be displayed on the cluster.

System Deactivation

The Utility Mode can be deactivated by pressing the EV button to the OFF position. The function cannot be deactivated from the **EV Settings**.

Charge types for electric vehicle

Charging information

AC charge

The electric vehicle is charged by plugging into a AC charger installed at your home or a public charging station. (For further details, refer to "AC charge" on page 1-24.)

DC charge

You can charge at high speeds at public charging stations. Refer to the respective company's manual that is provided for each DC charger type.

Battery performance and durability can deteriorate if the DC charger is used constantly.

Use of DC charge should be minimized in order to help prolong high voltage battery life.

Portable charge

The Electric vehicle can be charged by using household electricity. The electrical outlet at your home must comply with regulations and can safely accommodate the Voltage/Current (Amps)/Power (Watts) ratings specified on the portable charge. (Portable charging cable: Sold separately)

Charging time information









Charging type		Standard battery type	Extended battery type
AC charge		Takes approx. 9 hours at room temperature when charged to 100%	Takes approx. 11 hours 45 minutes at room temperature when charged to 100%
DC charge	350 kW charger	Takes about 18 minutes at room temperature when charged from 10% to 80%. Can be charged to 100%.	Takes about 18 minutes at room temperature when charged from 10% to 80%. Can be charged to 100%.
	50 kW charger	Takes about 63 minutes at room temperature when charged from 10% to 80%. Can be charged to 100%.	Takes about 73 minutes at room temperature when charged from 10% to 80%. Can be charged to 100%.
Portable charge		Takes approx. 51 hours at room temperature when charged to 100%.	Takes approx. 68 hours at room temperature when charged to 100%.

* NOTICE

All charging times are approximate and based on manufacturer testing. Actual charging times will vary based on a number of factors including vehicle condition, battery state of charge, charger specifications and ambient temperature.

Charging types

- * Depending on the condition and durability of the high voltage battery, charger specifications, and ambient temperature, the time required for charging the high voltage battery may vary.
- * Actual charger appearance and charging method may vary in accordance with the charger manufacturer.
- * For your safety, your vehicle may stop charging if the external charger is outdated or defective. Try charging the vehicle using a different charger that works properly.
- * A maximum diagnosis time of 3 minutes may be added to check the battery condition during the battery charging process.
- * Portable charging cable is sold separately.

Category	AC Charge	DC Charge	Portable Charge
Charging Inlet (Vehicle)	 OCVQ011059N	 OCVQ011059	 OCVQ011059N
Charging Connector	 OCVQ011060	 OCVQ011061	 OCVQ011060
Charging Outlet	 OCVQ011007L	 OCVQ011008L	 OCVQ011009L
How to Charge	Use AC charger installed at home or public charging station	Use the DC charger at public charging station	Use household current

* INFORMATION

Type 3R enclosure satisfies the requirements of UL 50E standard when the charging connector is connected to the vehicle side charging inlet. An additional Type 3R enclosure should be provided in the end installation of the vehicle side charging inlet. The "Type 3R" marking can be found on the charging inlet.

- * What is type 3R?: Performance requirement for enclosures intended for outdoor use that provides a degree of protection against falling dirt, rain, sleet, and/or snow.

⚠ WARNING

Risk of Electric Shock, Do Not Disconnect Under Load.

* NOTICE

- Suitable For Use On A Circuit Capable Of Delivering Not More Than 30000 rms Symmetrical Amperes, 1000 Volts DC Maximum.
- Suitable For Use On A Circuit Capable Of Delivering Not More Than 5000 rms Symmetrical Amperes, 120 Volts AC Maximum

Charge indicator lamp for electric vehicle

Charging status

Electric charging door



OCVQ013010L

When charging the high voltage battery, the charge level can be checked from inside the charging door.

Lamp status	Battery SOC [%]
	0~24
	25~49
	50~74
	75~100

High voltage indicator



OCVQ011109N

The high voltage indicator is located on bottom of the windshield. When the 12V auxiliary battery is discharged, it is charged from the high voltage battery of the vehicle. When the high voltage electricity flow in the vehicle, the color of the indicator changes to amber and turns off after charging is finished.

⚠ WARNING

When the function is activating, the Charging Indicator Lamp will turn on and high voltage electricity will be flowing in the vehicle. Do not touch the high voltage electric wire (orange), connector, and all electric components and devices. This may cause electric shock and lead to injuries. Also, do not modify your vehicle in any way. This may affect your vehicle performance and lead to an accident.

Charging connector lock

Locking charging cable

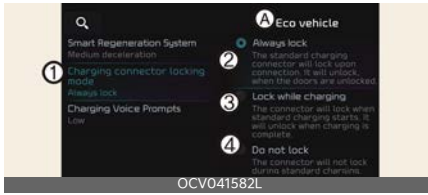

A: ECO Vehicle

1 Charging Connector Locking Mode

2 Always Lock

3 Lock While Charging

4 Do Not Lock

You may select when the charging connector can be locked and unlocked in the charging inlet.

Select **Setup** → **EV** → **Charging Connector Locking Mode** in the infotainment system.

* INFORMATION

The infotainment system may change after software updates. For more information, refer to the user's manual provided in the infotainment system and the quick reference guide.

When the charging connector is locked

Category	While charging	Always	Do not lock
Before charging	X	O	X
While charging	O	O	X
Finished charging	X	O	X

Always mode

The connector locks when the charging connector is plugged into the charging inlet. The connector is locked until all doors are unlocked by the driver. This mode can be used to prevent charging cable theft.

- If the charging connector is unlocked when all doors are unlocked, but the charging cable is not disconnected within 15 seconds, the connector will be automatically locked again.
- If the charging connector is unlocked when all doors are unlocked, but all doors are locked again, immediately, the connector will be automatically locked again.

Lock While Charging mode

The connector locks when charging starts. The connector unlocks when charging is complete. This mode can be used when charging at a public charging station.

Do Not Lock mode

The connector unlocks regardless of the state of charging. Press the charging connector release button, disconnect the connector. Be careful of theft of the charging cable.

Scheduled charging

You can set up a charging schedule for your vehicle using the infotainment screen or the Kia Connect application on your smart phone.

Refer to the multimedia system and the Kia Connect manual about scheduled charging.

Scheduled charging can only be done when using a AC charger or the Portable Charging Cable (ICCB: In-Cable Control Box) (sold separately).

When scheduled charging is set and the AC charger or the Portable Charging Cable (ICCB: In-Cable Control Box) is connected for charging, the indicator lamp blinks from the first level to the last for about 3 minutes to indicate that scheduled charging is set.



When scheduled charging is set, charging is not initiated immediately when the AC charger or Portable Charging Cable (ICCB: In-Cable Control Box) is connected. When immediate charging is required, use the infotainment system or the Kia Connect application on your smart phone to deactivate the scheduled charging or press and hold the charging button on the charging door for 2 seconds.

When scheduled charging is set, charging time is automatically calculated, so in some cases, charging may start right after the charger is connected.

If you press the charging button to immediately charge the battery,

charging must be initiated 3 minutes after the charging cable has been connected.



When you press the charging button for immediate charging, the scheduled charge setting is not completely deactivated. If you need to completely deactivate the scheduled charge setting, use the multimedia system or the Kia Connect application on your smart phone.

* Refer to "AC charge" on page 1-24, "Portable charge (sold separately)" on page 1-30 for details about connecting the AC charger and the Portable Charging Cable (ICCB: In-Cable Control Box) (sold separately).





Charging electric vehicle

Electric charging door



The electric charge door will open and close as follows.

1

Methods	Open	Close
Push/Touch	 <p>OCVQ013012L Push the charging door.</p>	 <p>OCVQ013013L_2 Press the charging door close button.</p>
Charging door open/close button (Located on the crash pad)	 <p>OCVQ011014N Press the charging door open/close button.</p>	
Voice Recognition		

* NOTICE

The charging door automatically closes when:

- The charge connector is disconnected
- The charging procedure has not **started** for approximately 2 minutes while the charging door is opened.
- The gear is in D (drive), N (neutral), or R (Reverse).
- After replacing the battery (12 volt), open and close the charging door

once to check that the charging door automatic opening mechanism is functioning properly.

- When replacing the charging door, be sure to disconnect the vehicle-side wiring connector of the charging door module and reconnect it to ensure normal operation of the charging door.

Precautions for charging electric vehicle

AC Charger



OCVQ011007L

AC Charging Cable (if equipped)



OCVQ011063N

DC Charger



OCVQ011008L

* Actual charger appearance and charging method may vary in accordance with the charger manufacturer.

⚠ WARNING

- Electromagnetic waves that are generated from the charger can seriously impact medical electric devices, such as an implantable cardiac pacemaker. When using electronic medical devices, such as an implantable cardiac pacemaker, make sure to ask the medical team and manufacturer

whether charging your electric vehicle will impact the operation of the medical electric devices, such as an implantable cardiac pacemaker.

- Check to make sure there is no water or dust on the charging cable connector and plug before connecting to the charger and charging inlet. Connecting while there is water or dust on the charging cable connector and plug may cause a fire or electric shock.

⚠ WARNING

- Be careful not to touch the charging connector, charging plug, and the charging inlet when connecting the charger connector cable to the charging outlet and the charging inlet on the vehicle.
- Comply with the following in order to prevent electrical shock when charging:
 - Use a waterproof charger.
 - Do not touch the charging connector and charging plug when your hand is wet, or do not stand in water or snow when connecting the charging cable.
 - Do not charge when there is lightning and/or potential for lightning.
 - Do not charge when the charging connector and plug is wet.

⚠ WARNING

- Immediately stop charging when you discover abnormal symptoms (e.g., smell, smoke, etc.).
- Replace the charging cable if the cable coating is damaged to prevent electrical shock.

- When connecting or removing the charging cable, make sure to hold the charging connector handle.



- Only use the charging cable (if equipped) certified by Kia. If you use a separate extension cable such as a reel or use an uncertified cable, it may cause abnormalities of electrical outlets, leading to fire or explosion.
- If you pull the cable itself (without using the handle), the internal wires may be disconnected or get damaged. This may lead to electric shock or fire.
- Do not leave the vehicle with the charging door open. An open charging door may indicate that the vehicle door has been unlocked and may be subject to vehicle theft.

CAUTION

- Always keep the charging connector and charging plug in clean and dry condition. Be sure to keep the charging cable in a condition where there is no water or moisture.
- Make sure to use the designated charger for charging the electric vehicle. Using any other charger may cause failure.

- Before charging the battery, turn the vehicle OFF.
- When the vehicle is switched OFF while charging, the cooling fan inside the motor compartment may automatically operate. Do not touch the cooling fan while charging.
- Be careful not to drop the charging connector. The charging connector can be damaged.
- Do NOT use an extension cord, when using the L1-Portable charger, as this may overheat and/or cause damage.

*** NOTICE**

When Right after charging the high voltage battery, the A/C system will activate to control the high voltage battery temperature.

At this time, the noise might occur by the air conditioner compressor and cooling fan, but this is due to normal operation.

Unlock charging connector in emergency

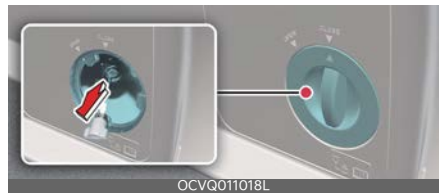

If the charging cable does not detach due to battery discharge and failure of the electric wires, open the liftgate and slightly pull the emergency cable on the right side area as shown above. The charging connector will then unlock.

AC charge

You can use an AC charger at home or public charging stations, or the charging cable provided with your vehicle. (if equipped)

AC Charger



AC charging cable (if equipped)



- A: Charging plug (Charger)
 - B: Charging connector (Vehicle)
- * Shape of charger and how to use the charger may be different for each manufacturer.

How to connect AC charger

1. While the brake pedal is pressed, engage the parking brake.
2. Turn OFF all switches, place the gear in P (Park), and turn OFF the vehicle.
If you try to charge while the gear is not placed in P (Park), it will automatically move to P (Park).
However, charge the battery only when the gear is placed in P for safety reasons.

3. Press the charging door to open the charging door. The charging door opens only when the vehicle's doors are unlocked.



⚠ CAUTION

If you cannot open the charging door due to freezing weather, tap lightly or remove any ice near the charging door. Do not try to forcibly open the charging door.

4. Open the charging door and remove the AC charging inlet cover (1) to access the AC charging inlet port.

⚠ CAUTION

In order to connect the charging connector, release the door lock to unlatch the charging connector lock system. If not, the charging connector and the vehicle's charging inlet may be damaged.

5. Check if there is any dust, foreign substances, water or moisture on the charging connector and charging inlet.
6. Hold the charging connector handle and connect it to the vehicle AC charging inlet.
7. Push the connector until you hear a "clicking" sound. If the charging connector and charging terminal are not connected properly or damaged, this may cause a fire.

- * For more information about how to charge and how to disconnect, please refer to the manual of each AC charger.
- * The shape of the charging connector may be different for each manufacturer.

8. Connect the charging plug to the electric outlet at an AC charging station to start charging.

AC Charger



OCV0011007L

9. Check if the charge indicator lamp in the instrument cluster is turned ON.

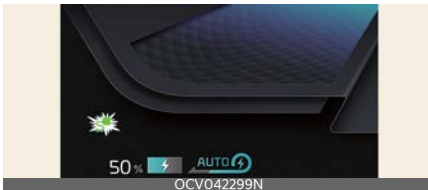

OCV042299N

Charging does not occur when the charging indicator lamp is OFF.

When the charging connector and charging plug are not connected properly, reconnect the charging cable to charge.

*** NOTICE**

- You can start charging when the EV button is in the OFF position and the gear is in P (Park). After charging has started, you can use electrical components, such as the radio by pressing the EV button to the ACC or ON position.

- Do not shift out of P (Park) while charging. If the vehicle is shifted to other gear, charging stops immediately. If you want to start charging again, place the gear to P (Park) again or press the EV button to the OFF position. Unplug and reconnect the charging cable to start charging again.
- During charging, you cannot move the gear from P (parking) to other positions.

10. After charging has started, estimated charging time, current SOC (State of Charge), and charge level in kW, is displayed, as well as the charge level, on the instrument cluster for about 1 minute.



OCV042103N

A: Remaining Time

- * The remaining charging time in the LCD image may differ from actual charging time.

If you open the driver door while charging, the estimated charging time is also displayed on the instrument cluster for about 1 minute.

When scheduled charging is set, the estimated charging time is displayed as "--".

If air conditioning/remote air conditioning control is set, the estimated time to charge is displayed as "--".

⚠ CAUTION

If the charge auto unlock has not been activated, release the door lock to unlatch it.

If not, the charging connector and the vehicle's charging inlet may be damaged.

*** NOTICE**

Depending on the condition and durability of the high voltage battery, charger specifications, and ambient temperature, the time required for charging the battery may vary.

Charging connector AUTO/LOCK mode

When the charging connector and the charging inlet are connected, you can choose the mode on the infotainment system. The charging connector will be locked at a different time depending on the selected mode.

For more information, refer to the "Charging connector lock" on page 1-19.

How to disconnect AC charger

1. When charging is complete, remove the charging plug from the electrical outlet.

AC Charger



2. Hold the charging connector handle (2) and pull it while pressing the release button (1).



To prevent charging cable theft, the charging connector cannot be disconnected from the inlet when the vehicle's doors are locked. Unlock all doors to disconnect the charging connector from the inlet.

However, if the vehicle is in the charging connector AUTO mode, the charging connector automatically unlocks from the inlet when charging is completed.

For more details, refer to "Charging connector lock" on page 1-19.

⚠ CAUTION

In order to disconnect the charging connector, release the door lock to unlatch the charging connector lock system.

If not, the charging connector and the vehicle's charging inlet may be damaged.

⚠ CAUTION

Before disconnecting the charging connector, make sure the vehicle's doors are unlocked. When the doors are locked, the charging connector lock release button (1) will not work.

When disconnecting the charging connector, do not try to disconnect it by force without pressing the release button. This may damage the charging connector and vehicle charging inlet.

If the charging connector lock does not unlatch even after the door lock doors have been unlocked, open the liftgate

and pull the emergency release lever to disconnect the charging connector. If this occurs, the charging connector lock function may have a problem, so have your vehicle inspected by an authorized Kia dealer.

3. Make sure to completely close the AC charging inlet cover.
4. Make sure to completely close the charging door.
5. Close the protective covers of the charging connector and the charging plug to prevent foreign substances from entering the terminals.
6. Store the charging cable safely in the storage compartment

How to store and keep the AC charging cable (if equipped)



Store the charging cable safely in the storage compartment.

* NOTICE

- Do not disassemble or modify the charging Cable (ICCB: In-Cable Control Box). Such acts will void your warranty on the charger.
- Always keep the charging connector and charging plug in a clean and dry condition. Be sure to keep the charging cable in a condition where there is no water or moisture.
- When the charging connector or charging plug is damaged, corroded, or rusted, or if it feels loose when the charging connector and charging

plug are connected, do not charge the vehicle and contact an authorized Kia dealer.

- Please note the following when using the charging cable.
 - Do not pull the cable by excessive force.
 - Do not twist or bend it.
 - Do not drag it on the floor.
 - Do not place any object on the cable.
 - Do not use an extension cord, when using the L1-Portable/120VAC charger.
 - Do not place an object that can generate high temperatures near the charger.
 - Do not drop or subject it to shock or impact.
 - Do not store it with liquids.

For cleaning the charging cable, use only a soft cloth like gauze and lightly wipe the surface with water containing a 3% neutral detergent and remove the water with a clean cloth.

Dry it in a well-ventilated shade after wiping off the water. Be careful not to expose the charging connector and charging plug to water.

⚠ WARNING

Do not disassemble or modify the charging Cable (ICCB: In-Cable Control Box). Such acts could result in a fire, electric shock and injury.

⚠ CAUTION

When cleaning the charging cable, do not use an organic solvent, such as paint thinner, benzene, alcohol or gasoline.

Doing so may change the color and damage the charging cable. When you use a general car cleaner to clean the charging cable, make sure that any organic solvent mentioned above is not included.

DC charge

You can charge at high speed at public charging stations. Use the charging cable installed with DC chargers.

DC Charger



- * Actual charger appearance and charging method may vary in accordance with the charger manufacturer.
- * If you use a DC charger when the vehicle is already fully charged, some DC chargers will send out an error message. When the vehicle is fully charged, do not charge the vehicle.

⚠ CAUTION

If you cannot open the charging door due to freezing weather, try again after removing any ice near the charging door. If you open it by force, the charging door may be damaged.

How to connect DC charger

1. While the brake pedal is pressed, engage the parking brake.
2. Place the gear in P (Park), and turn OFF the vehicle.

If you try to charge while the gear is not placed in P (Park), it will automatically move to P (Park).

However, charge the battery only when the gear is placed in P (Park) for safety reasons.

3. Press the charging door to open the charging door.



You cannot open the charging door when the vehicle's doors are locked.

4. Open the cover of the charging inlet.
5. Check whether there is dust or foreign substances inside the charging connector and charging inlet.
6. Hold the charging handle and connect it to the vehicle DC charging inlet.

Push the connector until you hear a "clicking" sound. If the charging connector and charging terminal are not connected properly, this may cause a fire.

- * Refer to the manual for each type of DC charger for how to charge and remove the charger.
- * The shape of the charging connector may vary depending on the manufacturer.

7. Check if the charger indicator lamp in the instrument cluster is turned ON.



Charging doesn't start when the charging indicator lamp is OFF.

When the charging connector is not connected properly, reconnect the charging cable to charge it again.

* NOTICE

- Charge your car only when the gear is placed in P (Park) for safety.
- You can start charging when the EV button is in the OFF position and the gear is in P (Park).

After charging has started, you can use electrical components, such as the radio, by pressing the EV button to ACC or ON position.

- You cannot move the gear other than P (Park) while charging.

* NOTICE

To control the temperature of the high voltage battery while charging, the air conditioner is used to cool down the battery, which may generate noise from operation of the air conditioner compressor and cooling fan.

Also, the air conditioner's performance may be degraded during the summer due to operation of the cooling system for the high voltage battery.

8. After charging has started, the estimated charging time is displayed on the instrument cluster for about 1 minute.



A: Remaining Time

- * The remaining charging time in the LCD image may differ from actual charging time.

* NOTICE

- Depending on the condition and durability of the high voltage battery, charger specifications, and ambient temperature, the time required for charging the battery may vary.
- In rare cases, you might hear high frequency noise (very little beep sound) outside the car when charging with 400V fast charger that is deteriorated or has a long communication delay. The high frequency noise can be generated only when the car tries to reduce its own electromagnetic waves to keep fast charging as possible. So, this noise is normal, because it is the intentional operation of the car that does not affect any charging performance or the vehicle itself at all.

How to disconnect DC charger

1. Remove the charging connector when DC charging is completed, or after you stop charging using the DC charger.

Refer to each respective fast charger manual for details about how to disconnect the charging connector.

⚠ CAUTION

When disconnecting the charging connector, do not try to disconnect it by force without pressing the release button. This may damage the charging connector and vehicle charging inlet.

2. Make sure to completely close the DC charging inlet cover.
3. Make sure to completely close the charging door.

Portable charge (sold separately)



- 1 Cord & AC plug (Cord set)
- 2 Control Box
- 3 Charging Cable and Charging Connector

This cable is designed to prevent problems caused by unexpected battery discharge and when you use general outlets. This may lead to excessive electricity charges. Refrain from using it to fully charge your car.

If this cable is connected to a household power source, it may exceed the capacity of the outlet (amperage), resulting in safety problems such as electrical shut-down and fire.

*** NOTICE**

Household power source should be a dedicated 120VAC/15AMP/properly grounded outlet.

How to set the charge level of the portable charger (sold separately)

1. Check the outlet's current rating before connecting the plug to the outlet.
2. Connect the power plug to the household electrical outlet.



3. Check the status of the control box display
4. Adjust the charging current by pressing the button (1) on the back of the control box for more than 1 second.



5. Each time the button (1) is pressed, the control box display is sequentially changed to 12 A, 10 A and 8 A. Once the charging current setting is complete, start charging (refer to "Portable charge (sold separately)" on page 1-30 for more information).

Examples of ICCB charging current setting

Control box display window



OCVQ011023L

Outlet Current	ICCB Charge Level
14~16 A	12A
12~13 A	10A
10~11 A	8A
8~9 A	6A

⚠ CAUTION

Please make sure that charge level selection matches the capacity of your circuit breaker to avoid blowing a fuse.

* NOTICE

(Examples are only for reference and situations may vary depending on the surrounding environment.)

How to connect portable charger (ICCB: In-Cable Control Box) (sold separately)

1. Connect the plug to a household electric outlet.



OCVQ01107N

* NOTICE

- If the outlet is aged, damaged or cracked, do not use it.
- Do NOT use an extension cord between the household electric outlet and L1-trickle charger, as household power source should be a dedicated 120VAC/15AMP/properly grounded outlet.

2. Check if the power lamp (green) on the control box turns ON.



OCVQ011024

3. While the brake pedal is pressed, engage the parking brake.
4. Place the gear in P (Park). If you try to charge while the gear is not placed in P (Park), it will automatically move to P (Park).

However, charge the battery only when the gear is placed in P for safety reasons.

* Make sure that the plug is not loosely put into the outlet. (If it is loose, it may generate heat.)

5. Press the charging door to open. You cannot open the charging door when the vehicle's doors are locked.



OCVQ013012L

⚠ CAUTION

If you cannot open the charging door due to freezing weather, tap lightly or remove any ice near the charging door. Do not try to forcibly open the charging door.

⚠ CAUTION

In order to connect the charging connector, unlock the vehicle's doors to unlatch the charging connector lock system. If not, the charging connector and the vehicle's charging inlet may be damaged.

6. Open the charging door and then open the inlet cover.
7. Open the protective cover of the charging connector and check if there is dust on the charging connector and charging inlet.
8. Hold the charging connector handle and connect it to the vehicle AC charging inlet.
9. Push the connector until you hear a "clicking" sound.
Charging starts automatically and the charging indicator lamp starts to blink.



⚠ WARNING

If the charging connector and charging terminal are not connected properly, this may cause a fire.

10. Check if the charge indicator lamp (green) in the instrument cluster is turned ON.

Charging does not occur when the charging indicator lamp is OFF.



When the charging connector is not connected properly, reconnect the charging cable to charge it again.

*** NOTICE**

- You can start charging when the EV button is in the OFF position and the gear is in P (Park).
After charging has started, you can use electrical components, such as the radio, by pressing the EV button to ACC or ON position.
- You cannot move the gear other than P (Park) while charging. Charging stops immediately. If you want to start charging again, place the gear to P (Park) and press the EV button to the OFF position. Unplug and reconnect the charging cable to start charging again.
- During charging, you cannot move the gear from P (parking) to other positions.

11. After charging has started, the estimated charging time is displayed on the instrument cluster for about 1 minute.



A: Remaining Time

- * The remaining charging time in the LCD image may differ from actual charging time.

If you open the driver door while charging, the estimated charging time is also displayed on the instrument cluster for about 1 minute.

When scheduled charging is set, the estimated charging time is displayed as "--".

⚠ CAUTION

In order to disconnect the charging connector, release the door lock to unlatch the charging connector lock system.

If not, the charging connector and the vehicle's charging inlet may be damaged.

* NOTICE

Depending on the condition and durability of the high voltage battery, charger specifications, and ambient temperature, the time required for charging the battery may vary.

Charging connector AUTO/LOCK mode

When the charging connector and the charging inlet are connected, you can choose the mode on the infotainment system. The charging connector will be locked at a different time depending on the selected mode.

For more information, refer to the "Charging connector lock" on page 1-19.

Charging status indicator lamp for portable charger

Indicator		Details
POWER		On: Power on
CHARGE		On: Charge Blink: Current limit due to high plug temperature or high internal temperature
FAULT		Blink: Charging interrupted
CHARGE LEVEL	12	12 A
	10	10 A
	08	8 A
	06	6 A
	The charging current changes whenever the button (1) is pressed for less than 1 sec with the charger plugged into an electrical outlet but not the vehicle.	
<p>Control box</p> 		

Error Code	Item	Cause
E1	Control Pilot communication	Vehicle communication error
E2	Leakage	Current leakage
E3		Charger error
E4	Plug temperature	Plug overtemperature warning
E5		Plug temperature failure
E6		Charger error
E7	Overcurrent	Charging overcurrent warning
E8	Internal temperature	Charger overheating
E9		Charger error
F1	Relay fusion	Charger error
F2	Ground Monitoring/Interrupt	Poor grounding of outlet
F3	Switched mode power supply power failure	Switched mode power supply error (voltage failure)
F4		Switched mode power supply error (abnormal voltage)
F5	Control Pilot voltage error	Control Pilot (-) voltage error
F6		Control Pilot (+) voltage error
F7	Temperature sensor error	Plug temperature sensor error
F8		PCB internal temperature sensor error

Status/Diagnosis/Countermeasure



- Charging connector plugged into vehicle (**POWER** Green ON)
- Plug connected to an electric outlet (**POWER** Green ON)

While charging



- Charge indicator (**POWER** Green ON/**CHARGE** Blue ON)
- Charging current

Before plugging charging connector into vehicle (**POWER** Green ON, **FAULT** Red blink)



- Abnormal temperature
- ICCB (In-Cable Control Box) failure
- Contact an authorized Kia dealer.

Plugged into vehicle (**POWER** Green ON, **FAULT** Red Blink)



- Diagnostic device failure
- Current leakage
- Abnormal temperature

Leakage current failure (**POWER** Green ON, **FAULT** Red Blink)



- Disconnect and reconnect the power plug to clear the error.

Power saving mode



- Charge level indicator is turned off if there is no status change for more than 1 minute.

How to disconnect portable charging cable (ICCB: In-Cable Control Box) (sold separately)

1. Hold the charging connector handle (2) and pull it while pressing the release button (1).



Before disconnecting the charging connector, make sure the vehicle's doors are unlocked. When the doors are locked, the charging connector lock system will be triggered. And the charging connector will not be disconnected.

However, in AUTO Mode, the lock is released automatically when charging is completed, and you can disconnect the charging connector.

For more information, refer to the "Charging connector lock" on page 1-19.

CAUTION

In order to disconnect the charging connector, unlock the vehicle's doors to unlatch the charging connector lock system.

If not, the charging connector and the vehicle's charging inlet may be damaged.

CAUTION

When disconnecting the charging connector, do not try to disconnect it by force while not pressing the release button. This may damage the charging connector and vehicle charging inlet.

- If the charging connector lock does not unlatch even after the vehicle's doors are unlocked, open the liftgate, and pull the emergency release lever to disconnect the charging connector. If such case occurs, the charging connector lock function may be defective, so have your vehicle inspected by an authorized Kia dealer.

2. Make sure to completely close the AC charging inlet cover.



3. Make sure to completely close the charging door.
4. Disconnect the plug from the household electric outlet. Do not pull the cable when disconnecting the plug.



5. Close the protective cover for the charging connector so that foreign substances do not flow into the terminal.
6. Put the charging cable inside the cable compartment to protect it.

Precautions for portable charging cable (ICCB: In-Cable Control Box) (sold separately)

⚠ WARNING

- Use a portable charging cable that is certified by Kia.
- Do not try to repair, disassemble, or adjust the portable charging cable.
- Do not use an extension cord or adapter.
- Stop using immediately when failure occurs.
- Do not touch the plug and charging connector with wet hands.
- Do not touch the terminal part of the AC charging connector and the AC charging inlet on the vehicle.
- Do not connect the charging connector to voltage that does not comply with specifications.

⚠ WARNING

- Do not use the portable charging cable if it is worn out, exposed, or there exists any type of damage on the portable charging cable.
- If the ICCB case or AC charging connector is damaged, cracked, or the wires are exposed in any way, do not use the portable charging cable.
- Do not let children operate or touch the portable charging cable.
- Charging with a worn out or damaged household electric outlet can result in a risk of electric shock. If you are unsure about the condition of a household electric outlet have it checked by licensed electrician and charge again.
- Stop using the portable charging cable immediately if the household

electric outlet or any components are overheating or you notice burning odors.

*** NOTICE**

- Keep the control box free of water.
- Keep the AC charging connector or plug terminal free of foreign substances.
- Do not step on the cable or cord.
- Do not pull the cable or cord and do not twist or bend it. Do not charge when there is lightning.
- Do not drop the control box or place a heavy object on the control box.
- Do not place an object that can generate high temperatures near the charger when charging.

Charging electric vehicle (Abrupt stop)

Actions to be taken when charging stops abruptly

When you cannot charge the high voltage battery after connecting the charger, check the following:

1. Check the charging setting for the vehicle. Refer to "EV Settings" on page 1-13. (e.g. When scheduled charging is set, charging is not initiated immediately when the AC charger or portable charger (ICCB: In-Cable Control Box) is connected.)
2. Check the operation status of the AC charger, portable charger and DC charger. (Refer to "Charging status" on page 1-18.)
* Actual method for indicating the charging status may vary in accordance with the charger manufacturer.
3. When the vehicle does not charge and a warning message appears on the cluster, check the corresponding message. Refer to "LCD display messages (Related to electric vehicle)" on page 1-45.
4. If the vehicle is properly charged when charged with another normally working charger, contact the charger manufacturer.
5. If the vehicle does not charge when charged with another normally working charger, contact an authorized Kia dealer for inspection.
6. If charging fails and the service warning light () is lit in the cluster, contact an authorized Kia dealer.

Driving electric vehicle

How to start the vehicle

1. With the smart key in the vehicle, sit in the driver's seat.
2. Fasten the seat belt before starting the vehicle.
3. Make sure to engage the parking brake.
4. Make sure to depress and hold the brake pedal.
5. Make sure the vehicle is in P (Park).
6. Depress and hold the brake pedal while pressing the EV button.
7. When the **READY** indicator is ON, you can drive the vehicle. When the **READY** indicator is OFF, you cannot drive the vehicle. Start the vehicle again.

Vehicle ON → **READY** (Green)



8. Press and hold the brake pedal and shift to the desired position.
9. Release the parking brake and slowly release the brake pedal. Check if the vehicle moves in the intended direction, then depress the accelerator pedal.

* NOTICE

While the charging cable is connected, the gear cannot be shifted from P (Park) to any other gear for safety reasons.

How to stop the vehicle

1. Hold down the brake pedal.
2. Shift to P (Park).
3. Engage the parking brake.
4. Press the EV button and turn off the vehicle.
5. Check if the **READY** indicator is turned OFF in the instrument cluster.

Vehicle OFF



⚠ WARNING

When the **READY** indicator is ON and the gear is in a position other than P (Park), the driver can accidentally depress the accelerator pedal, causing the vehicle to move unexpectedly.

Virtual Engine Sound System (VSS)

Virtual Engine Sound System (VSS) generates an engine sound for pedestrians to hear the vehicle because there is no sound while the Electric Vehicle (EV) is operating.

If the vehicle is in the **READY** mode and the gear is not in P (Park), the VSS will operate.

When the gear is shifted to R (Reverse), an additional warning sound will be heard.

⚠ WARNING

The sound system only plays a supplementary role. The system is not designed to and does not replace the care of drivers. Drivers should always

pay attention to their surroundings while driving.

⚠ WARNING

- The vehicle is much quieter while driving than a conventional gasoline-powered vehicle. Be aware of your surroundings and always drive safely.
- After you park the vehicle or while you are waiting at a traffic light, check whether there are children or obstacles around the vehicle.
- Check if there is something behind the vehicle when driving in reverse. Pedestrians may not hear the sound of the vehicle.

Distance to empty



The distance to empty is displayed differently according to the selected drive mode in the drive mode integrated control system.

Impact on distance to empty

- Driving range depends on the driving style, electrical load usage, environment, and high voltage battery energy. Distance to empty displayed on the vehicle may be higher or lower than the certification range because these effects are considered.
- Driving style refers to driving speed and acceleration/deceleration tendency. The higher the speed, or the more frequent the acceleration/deceleration, distance to empty will be reduced.
- Electrical loads usage means air conditioning, heaters, lamps or additional auxiliary loads, and as the usage increases, distance to empty will be reduced.
- Environment refers to weather, temperature, and terrain. Distance to empty is reduced in cases of snow/rain/high winds or low temperatures, uphill or slippery or rough road surfaces.
- High voltage battery energy is proportional to SOC (charge amount), but may vary depending on the battery temperature, SOH (State of Health), etc.

Change of distance to empty when 100% charging

- If the distance to empty is lowered due to learning by the driving style or the environment in which the vehicle is used, the driving distance may be increased again if the vehicle continues to drive according to the "driving tips for improving the driving distance". The distance to empty can be reset at the Kia dealer, but it does not actually increase the range. Therefore, the distance to empty may be inaccurate until the learning proceeds.
- Distance to empty decreases when the high voltage battery temperature is low in winter. It is not a permanent change. If the temperature rises, the distance to empty is restored.
- Reducing the use of electrical loads increases the range available.
- Natural degradation of the high voltage battery occurs depending on the

length of use of the vehicle, which reduces the distance to empty.

Operating tips to improve driving range.

- As electric vehicles speed up, air resistance increases rapidly. Not speeding up helps increase driving range.
- High driving energy is consumed during rapid acceleration. Motor regenerative braking is restricted during rapid deceleration. Keep the accelerator pedal position constant and drive at a constant speed.
- Excessive operation of the heater and air conditioner can increase power consumption and shorten the driving range. When setting the temperature to 22°C (72°F) auto, optimal energy consumption driving is possible. In particular, using a heated seat and reducing air heating in winter is very helpful. Turn off the heater and air conditioner when heating and cooling are not needed.
- Selecting recirculation mode consumes less energy than selecting fresh mode. In the fresh mode, energy consumption is large because the outdoor air must be reheated or cooled. When driving with the window open, air resistance increases and heater and air conditioner usage increases. Close the window completely while driving to reduce energy consumption.
- When driving alone, use DRIVER ONLY mode when using the heater and air conditioning system.
- Always maintain the specified tire pressure and use tires exclusively for electric vehicles.

- Do not use unnecessary electrical components while driving.
- Do not load unnecessary items in the vehicle.
- Do not mount parts that may increase air resistance.

ECO Driving



A: Electric Vehicle

1 ECO Driving

Select **Menu** → **Energy Information** → **Menu** → **EV Economy History** on the screen. You can check ECO level information and ECO driving history.

Electric Energy Economy History



A: ECO Driving

1 EV Economy

You can check the driving date, driving distance, and the average energy consumption rating for the last 30 driving trips.

Electricity Use



A: Electric Vehicle

1 Electricity Use

Select **Menu** → **Electricity Use** on the screen. You can check the current energy consumption for each system of the vehicle.



A: Energy Consumption

1 Battery Care: Shows the momentary power and energy consumption which are used to:

- Operate the battery conditioning mode to increase the battery temperature during winter to improve the driving performance.
- Cool down the battery temperature during summer to prevent overheating of the battery.

2 Electronics: Shows the power and energy consumption which are used by the vehicle systems including the cluster, infotainment system (speaker and navigation), headlamp, vehicle control unit, etc.

3 Climate: Shows the power and energy consumption which are used by the heater or air conditioner.

4 Drivetrain: Shows the total power and energy consumption of the driving

motor's driving energy and regenerative energy.

Power/Charge gauge



The Power/Charge gauge shows the energy consumption rate of the vehicle and the charge/discharge status of the regenerative brakes.

- **PWR (Power):** It shows the energy consumption rate of the vehicle when driving uphill or accelerating. The more electric energy is used, the higher the gauge level.
- **CHG (Charge):** It shows the charging status of the battery when it is being charged by the regenerative brakes (decelerating or driving on a downhill road). The more electric energy is charged, the lower the gauge level.

State of Charge (SOC) gauge for high voltage battery



The SOC gauge shows the charging status of the high voltage battery.

The low percentage number on the indicator indicates that there is a limited amount of driving range in the high voltage battery. 100% indicates that the driving battery is fully charged.

When driving on highways or motorways, make sure to check in advance if the driving battery is charged enough.



When the remaining battery is lower than 10% (15% for GT) on the SOC gauge, the warning light (🔋⚡) turns ON to alert you of the battery level.

If the distance to empty is insufficient

- If the battery warning light is on, recharge immediately at the nearest charging station.
- Drive efficiently according to Operating tips to improve driving range. Refer to "Operating tips to improve driving range." on page 1-41.
- If the remaining battery is 0%, go to a safe place and request rescue.

Aux. Battery Saver+ (if equipped)

The Aux. Battery Saver+ is a function that monitors the charging status of the 12 V auxiliary battery. If the auxiliary battery level is low, the main high voltage battery charges the auxiliary battery.

⚠ WARNING

When the function is activating the indicator lamp will appear and high voltage electricity will be flowing in the vehicle. Do not touch the high voltage electric wire (orange), connector, and all electric components and devices. This may cause electric shock and lead to injuries. Also, do not modify your vehicle in any

way. This may affect your vehicle performance and lead to an accident.



* NOTICE

- The Aux. Battery Saver+ activates for a maximum of 20 minutes. If the Aux. Battery Saver+ function activates more than 10 times consecutively in the automatic mode, the function will deactivate because of a potential problem with the auxiliary battery. In this case, drive the vehicle for some period of time. The function will start activating if the auxiliary battery returns to normal.
- The Aux. Battery Saver+ function cannot prevent battery discharge if the auxiliary battery is damaged, worn out, used as a power supply or unauthorized electronic devices are used.
- If the Aux. Battery Saver+ function was activated the high voltage battery level may have decreased.

Warning and indicator lights (Related to electric vehicle)

The warning light and indicator light indicate the situation where the driver should be careful and whether the various functions are activated.

Ready indicator READY

This indicator appears:

When the vehicle is ready to be driven.

- ON: Normal driving is possible.
- OFF: Normal driving is not possible, or a problem has occurred.
- Blinking: Emergency driving.

When the ready indicator goes OFF or blinks, there is a problem with the system. In this case, have your vehicle inspected by an authorized Kia dealer.

Service warning light

This warning light appears:

- When the EV button is in the ON position.
 - It appears for approximately 3 seconds and then goes off.
- When there is a problem with related parts of the electric vehicle control system, such as sensors, etc.

When the warning light appears while driving, or does not go OFF after starting the vehicle, have your vehicle inspected by an authorized Kia dealer.

Power down indicator light

This indicator appears:

- When the EV button is in the ON position.
 - It appears for approximately 3 seconds and then goes off.
- When the power is limited for the safety of the high-powered parts of an electric vehicle. The power is limited for the following reasons. (Unless both Service Warning Light and Power Down Indicator Light appear at the same time, it is not a failure.)
 - The high voltage battery level is too low or voltage is decreasing
 - The temperature of the high voltage battery is too high or too low
 - The temperature of the motor is high

* NOTICE

Do not accelerate or start the vehicle suddenly when the Power Down Indicator Light is ON.

Charge the battery immediately when the high voltage battery level is insufficient.

* NOTICE

When the power is limited for the safety of the high-powered parts of an electric vehicle, the power down indicator light appears. Your vehicle may not be driven, or may roll back on a slope with the indicator light ON due to the limitation of the vehicle power.

Charging cable connection indicator light

This indicator appears:

This indicator appears when the charging cable is connected.

Regenerative brake warning light



(Red color)  **(Yellow color)**

This warning light appears:

When the regenerative brake does not operate and the brake does not perform well. This causes the Brake Warning light (red) and Regenerative Brake Warning Light (yellow) to appear simultaneously. In this case, drive safely and have the vehicle inspected by an authorized Kia dealer.

The operation of the brake pedal may be more difficult than normal, and the braking distance can increase, as it may default to manual hydraulic mode.

High voltage battery low level warning light

This warning light appears:

When the high voltage battery level is low.

When the warning light turns ON, charge the battery immediately.

LCD display messages (Related to electric vehicle)

Shift to P to charge

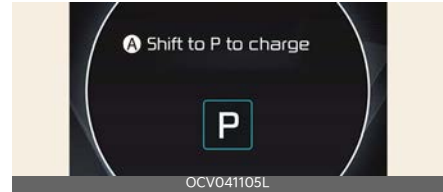

A: Shift to P to charge

This message is displayed if you connect the charging cable without the gear in the P (Park) position.

Shift to P (Park) before connecting the charging cable.

Low EV battery

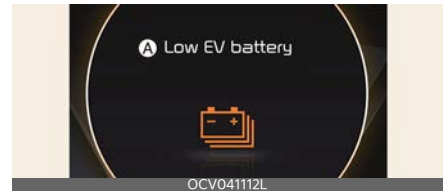

A: Low EV battery

When the high voltage battery level reaches around 10% (around 15% for GT) or less, this warning message is displayed.

The warning light on the instrument cluster  will turn on simultaneously. Charge the battery immediately.

Charge immediately. Power limited



A: Charge immediately. Power limited

When the high voltage battery level reaches around 5% or less, this warning message is displayed.

The warning light on the instrument cluster (🚨) will turn on simultaneously. The vehicle's power will be reduced to minimize the energy consumption of the high voltage battery. Charge the battery immediately.

Check electric vehicle system



A: Check electric vehicle system

This warning message is displayed when there is a problem with the electric vehicle control system.

⚠️ WARNING

Refrain from driving when the warning message is displayed.

If this occurs, park the vehicle in a safe location and have your vehicle towed to the nearest authorized Kia dealer and have the vehicle inspected.

Power limited



A: Power limited

In the following cases, this warning message is displayed when the vehicle's power is limited for safety.

- When the power is limited for the safety of the high-powered parts of an electric vehicle. The power is limited for the following reasons (Unless both Service Warning Light and Power Down Indicator Light appear at the same time, it is not a failure.):
- The high voltage battery level is too low or voltage is decreasing.
- The temperature of the high voltage battery is too high or too low.
- The temperature of the motor is high.

⚠️ WARNING

When this warning message is displayed, do not accelerate or start the vehicle suddenly. Charge the battery immediately when the high voltage battery level is not enough.

* NOTICE

When the power is limited for the safety of the high-powered parts of an electric vehicle, the power down indicator light appears. Your vehicle may not be driven, or may roll back on a slope with the indicator light ON.

Power limited due to low EV battery temperature. Charge battery

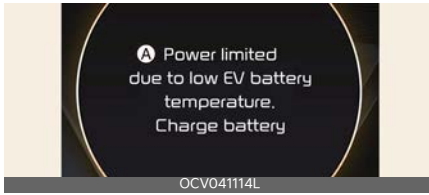

A: Power limited due to low EV battery temperature. Charge battery

The warning message is displayed to protect the electric vehicle system when you turn off or turn on the vehicle while outside temperature is low. If the high voltage battery charging level is low and parked outside in low temperature for a long time, vehicle power could be limited. Charging the battery before driving, increases the battery temperature and helps increase power.

* NOTICE

If this warning message is still displayed even when the ambient temperature is sufficiently high, have the vehicle inspected by an authorized Kia dealer.

EV Battery Overheated! Stop vehicle



A: EV Battery Overheated! Stop vehicle

This warning message is displayed to protect the battery and electric vehicle

system when the high voltage battery temperature is too high.

Turn off the EV button and stop the vehicle so that the battery temperature decreases.

⚠ WARNING

If this warning is still displayed even after the EV button has been turned off for sufficient time, refrain from driving and have the vehicle inspected by an authorized Kia dealer.

Stop vehicle and check power supply



A: Stop vehicle and check power supply

This warning message is displayed when a failure occurs in the 12 V power supply system.

If this occurs, park the vehicle in a safe location, tow your vehicle to the nearest authorized Kia dealer and have the vehicle inspected.

Unplug vehicle to start



A: Unplug vehicle to start

This message is displayed when you start the vehicle, without unplugging the charging cable and will not shift out of park. Unplug the charging cable and then turn on the vehicle.

Charging Door Open

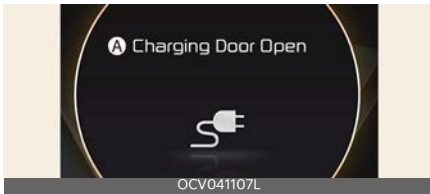

A: Charging Door Open

This message is displayed when the vehicle is driven with the charging door opened. Close the charging door and then start driving.

Remaining Time



A: Remaining Time

* The remaining charging time in the LCD image may differ from actual charging time.

This message is displayed to notify the remaining time to charge the battery, to the selected target battery charge level, and the charge voltage level.

Charging Stopped. Check the AC charger/Charging Stopped. Check the DC charger

AC Charge

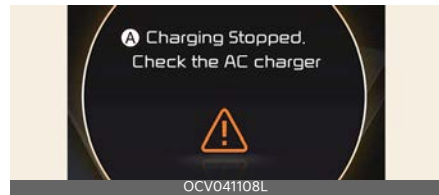

A: Charging Stopped. Check the AC charger

DC Charge

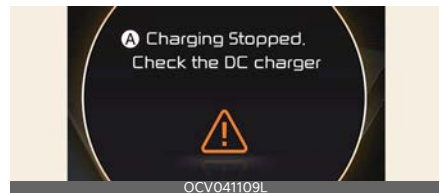

A: Charging Stopped. Check the DC charger

This warning message is displayed when charging is stopped for the reasons below:

- There is a problem with the external AC charger or DC charger.
- The external AC charger stopped charging
- The charging cable is damaged.

If this occurs, check whether there is any problem with the external AC or DC charger and charging cable.

If the same problem occurs when charging the vehicle with a well-functioning external charger or genuine Kia

portable charger, have your vehicle inspected by an authorized Kia dealer.

Charging Stopped. Check the cable connection



A: Charging Stopped. Check the cable connection

This warning message is displayed for the reasons below:

- The charging connector is not correctly connected to the charging inlet.
- The charging connector lock release button is pressed.

If this occurs, separate the charging connector and re-connect it.

Check whether there is any problem (external damage, foreign substances, etc.) with the charging connector and charging inlet.

If the same problem occurs when charging the vehicle with a replaced charging cable or genuine Kia portable charger, have your vehicle inspected by an authorized Kia dealer.

Check regenerative brakes



A: Check regenerative brakes

This warning message is displayed when the regenerative brake system does not work properly.

In this case, have your vehicle inspected by an authorized Kia dealer.

Check Virtual Engine Sound System



A: Check Virtual Engine Sound System

This message is displayed when there is a problem with the Virtual Engine Sound System (VESS).

In this case, have your vehicle inspected by an authorized Kia dealer.

Check Active Air Flap System



A: Check Active Air Flap System

This warning message is displayed in the following situations:

- There is a malfunction with the actual flap
- There is a malfunction with the actual air flap controller
- The air flap does not open

In this case, have your vehicle inspected by an authorized Kia dealer.

Refill coolant



A: Refill coolant

This message is displayed when the coolant is low. If the warning message is displayed, stop driving and check the amount of coolant. Driving without sufficient amount of coolant for a prolonged period of time can cause serious problems with the vehicle's electrical equipment and make normal driving impossible.

Safety precautions for electric vehicle

If an accident occurs

⚠ WARNING

- When a vehicle accident occurs, move the vehicle to a safe place, turn OFF the vehicle and remove the auxiliary battery (12V) terminal to prevent high voltage electricity from flowing.
- If electric wires are exposed from inside or outside the vehicle, do not touch the wires.
Also, do not touch the high voltage electric wire (orange), connector, or any of the electric components and devices. This may cause electric shock and lead to injuries.

⚠ WARNING

- When a vehicle accident occurs and the high voltage battery is damaged, harmful gas and electrolytes may leak. Be careful not to touch the leaked liquid.
- When you suspect leakage of inflammable gas and other harmful gases, open the windows and evacuate to a safe place. If any leaked fluid comes in contact with your eyes or skin, immediately clean the affected area thoroughly with tap water or saline solution and seek medical attention it as soon as possible.

⚠ WARNING

- If a small scale fire occurs, use a fire extinguisher (ABC, BC) that is meant for electrical fires. If it is impossible to extinguish the fire in the early stage, maintain a safe distance away from the vehicle and immediately call your

local fire emergency responders. Also, advise them that an electric vehicle is involved.

- If the fire spreads to the high voltage battery, large amounts of water is needed to put out the fire. Using small amounts of water or fire extinguishers not meant for electrical fires could cause serious injury or death from electrical shocks.

⚠ WARNING

- If you cannot put out the fire immediately, the high voltage battery may explode. Evacuate to a safe place and do not let other people approach the site. Contact the fire department and notify them of an electric vehicle fire.
- If the vehicle is flooded with water, immediately turn OFF the vehicle and evacuate to a safe place. Contact the fire department or an authorized Kia dealer.

⚠ WARNING

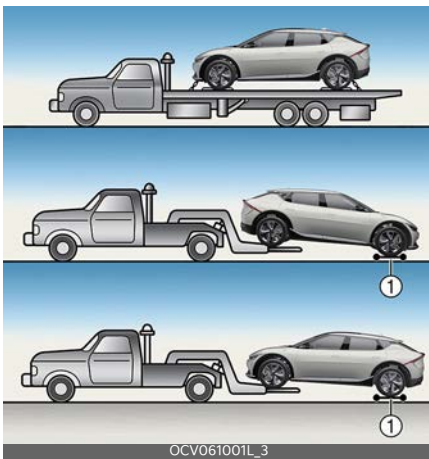

1 Dollies

- If towing is required, lift all four wheels off the ground and tow the vehicle.
- If you tow the vehicle while the rear wheels (for 2WD vehicle) or all 4 wheels (for AWD vehicle) are touching the ground, the vehicle motor may generate electricity and the motor components may be damaged or a fire may occur.
- When a vehicle fire occurs due to the battery, there is a risk of a second fire. Contact the fire department when towing the vehicle.

Other precautions for electric vehicle

- When you paint, apply heat treatment to the vehicle as a result of an accident, and/or weld on the vehicle, the performance of the high voltage battery can be reduced.
- If heat treatment is required, have the vehicle serviced by an authorized Kia dealer and have the high voltage battery removed, prior to any repairs.
- When you clean the motor compartment, do not use high pressure water to wash. This may cause an electric shock due to a discharge in high voltage electricity, or damage the vehicle's electric system.
- Use, modify, or install only genuine parts or those of an equivalent standard. If not, this may damage the

electric power system. Kia Genuine Parts are guaranteed for quality and performance.

High voltage cut-off switch



The high voltage cut-off switch is located in the motor room compartment fuse box.

Pull the yellow lever in the high voltage cut-off switch to shut down high voltage battery.

*** NOTICE**

Never disconnect the high voltage cutoff switch except in an emergency situation. If the high voltage cutoff switch is disconnected, an inability to start the vehicle.

*** NOTICE**

Applying excessive force to the switch lever while shutting down the high voltage battery may severely damage the high voltage cut-off switch.

Vehicle data collection and event data recorders	2-2
Vehicle handling instructions	2-3
Vehicle modifications.....	2-3

Introduction

Vehicle data collection and event data recorders

This vehicle is equipped with an event data recorder (EDR). The main purpose of an EDR is to record data to help understand vehicle performance in a crash or near crash (such as airbag deployment, hitting an obstacle, etc.). The EDR is designed to record data related to vehicle dynamics and safety systems for a short period of time, typically 30 seconds or less. The EDR in this vehicle is designed to record such data as:

- How various systems in your vehicle were operating;
- Whether or not the driver and passenger safety belts were buckled/fastened;
- How far (if at all) the driver was depressing the accelerator and/or brake pedal; and,
- How fast the vehicle was traveling.

These data can help provide a better understanding of the circumstances in which crashes and injuries occur.

NOTE: EDR data are recorded by your vehicle only if a non-trivial crash situation occurs; no data are recorded by the EDR under normal driving conditions and no personal data (e.g., name, gender, age, and crash location) are recorded. However, other parties, such as law enforcement, could combine the EDR data with the type of personally identifying data routinely acquired during a crash investigation.

To read data recorded by an EDR, special equipment is required, and access to the vehicle or the EDR is needed. In addition to the vehicle manufacturer, other

parties, such as law enforcement, that have the special equipment, can read the information if they have access to the vehicle or the EDR.

Vehicle handling instructions

As with all vehicles of this type, failure to operate this vehicle correctly may result in loss of control, an accident or vehicle rollover.

Specific design characteristics (higher ground clearance, track, etc.) give this vehicle a higher center of gravity than other types of vehicles. In other words they are not designed for cornering at the same speeds as conventional 2-wheel drive vehicles. Avoid sharp turns or abrupt maneuvers. Again, failure to operate this vehicle correctly may result in loss of control, an accident or vehicle rollover. Be sure to read the "Reducing the risk of a rollover" driving guidelines, in chapter 6 of this manual.

Vehicle modifications

This vehicle should not be modified. Modification of your vehicle could affect its performance, safety or durability and may even violate governmental safety and emissions regulations.

* NOTICE

Damage or performance problems resulting from any modification may not be covered under warranty.

⚠ WARNING

If you use unauthorized electronic appliances, they may cause the vehicle to operate abnormally, wire damage, battery discharge and fire. For your safety, do not use unauthorized electronic devices.

Your vehicle at a glance **3**

Exterior overview	3-2
Interior overview	3-8
Instrument panel overview	3-10
Motor room compartment.....	3-12

Your vehicle at a glance

Exterior overview

Front view



OCV012001N

Front view (GT-Line)



Front view (GT)



OCVGT012005N

* The actual appearance may differ from the illustration. Not all equipment is included in all vehicles.

- | | |
|----------------------------------|--------------|
| 1. Hood | 5-39 |
| 2. Head lamp | 5-86, 9-39 |
| 3. Wheel and tire | 9-18, 10-4 |
| 4. Outside rearview mirror | 5-58 |
| 5. Wide sunroof | 5-43 |
| 6. Front windshield wiper blades | 5-92, 9-15 |
| 7. Windows | 5-35 |
| 8. Front ultrasonic sensor | 7-115, 7-126 |
| 9. Front radar | 7-4 |
| 10. Front view camera | 7-4 |

Rear view



OCV011002N

Rear view (GT-Line)



OCV013006L

Rear view (GT)



OCVGT013002L

* The actual appearance may differ from the illustration. Not all equipment is included in all vehicles.

1. Doors	5-15
2. Charging door	5-42
3. Rear combination lamp	9-39
4. High mounted stop lamp	9-39
5. Liftgate	5-25
6. Antenna	5-121
7. Wide-rear view camera	7-96, 7-99
8. Rear ultrasonic sensor	7-112, 7-115
9. Backup lamp	9-39

Interior overview



* The actual appearance may differ from the illustration. Not all equipment is included in all vehicles.

- | | |
|--|------------|
| 1. Inside door handle | 5-18 |
| 2. Driver position memory system (Except for GT) | 5-23 |
| 3. Outside rearview mirror folding switch | 5-59 |
| 4. Outside rearview mirror control switch | 5-59 |
| 5. Central door lock/unlock switch | 5-19 |
| 6. Power window switches | 5-36 |
| 7. Power window lock/Electronic power child safety lock button | 5-21, 5-37 |
| 8. Steering wheel tilt/telescopic lever | 5-48 |
| 9. Steering wheel | 5-47 |
| 10. Instrument panel illumination control button | 5-62 |
| 11. Charging door open/close button | 5-42 |
| 12. ESC OFF button | 6-31 |
| 13. Power liftgate open/close button | 5-28 |

14.EPB switch	6-22
15.Hood release lever	5-39
16.Instrument panel fuse	9-28
17.Seat	4-5
18.Reduction gear (shifter dial)	6-6

Instrument panel overview



OCV011004N_2

* The actual appearance may differ from the illustration. Not all equipment is included in all vehicles.

- 1. Audio remote control button
- 2. Driver's front air bag 4-41
- 3. Horn 5-49
- 4. Driving Assist button 7-23, 7-62
- 5. Instrument cluster 5-61
- 6. Light control/turn signals lever (Left) 5-87
- Wiper and washer control lever (Right) 5-92
- 7. EV button 6-4
- 8. Infotainment system 5-121
- 9. Hazard warning flasher switch 8-2
- 10. Infotainment/climate switchable controller 5-122
- 11. Front seat warmer/air ventilation seat button 5-113, 5-114
- 12. Glove box 5-112

13.Steering wheel heater button	5-48
14.AUTO HOLD button	6-27
15.Parking/View button	7-96, 7-99, 7-126
16.Parking Safety button	7-99, 7-126
17.Wireless charging system	5-117
18.Center console storage box	5-112
19.Passenger's front air bag	4-41

Motor room compartment

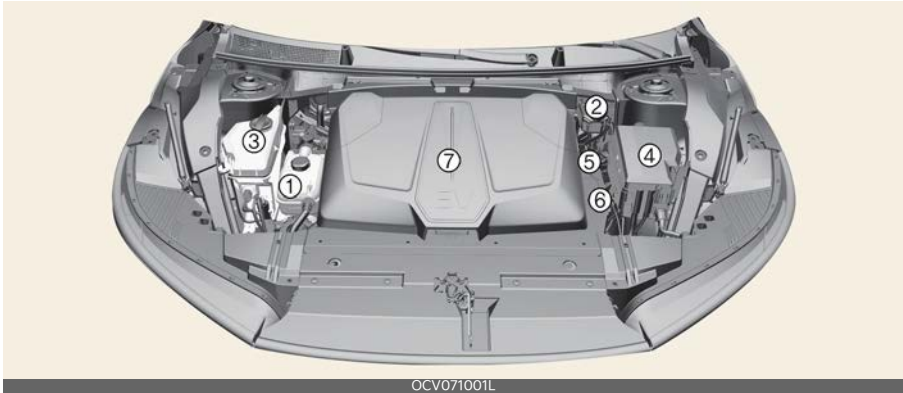

* The actual appearance may differ from the illustration. Not all equipment is included in all vehicles.

- | | |
|--------------------------------------|-----------|
| 1. Coolant reservoir | 9-11 |
| 2. Brake fluid reservoir | 9-12 |
| 3. Windshield washer fluid reservoir | 9-13 |
| 4. Fuse box | 9-28 |
| 5. Negative battery terminal (-) | 8-4, 9-16 |
| 6. Positive battery terminal (+) | 8-4, 9-16 |
| 7. Front trunk | 5-41 |

Important safety precautions	4-3
Seat	4-5
• Feature of seat leather	4-7
• Infotainment system.....	4-8
• Front seat adjustment for manual seat.....	4-8
• Front seat adjustment for power seat	4-9
• Seatback pocket.....	4-10
• Folding the rear seat.....	4-11
• Headrest (for front seat).....	4-13
• Headrest (for rear seat).....	4-15
• Armrest.....	4-16
Seat belts	4-17
• Seat belt restraint system.....	4-17
• Seat belt warning light.....	4-18
• Seat belt - driver's 3-point system with emergency locking retractor	4-18
• Seat belts - front passenger and rear seat 3-point system with combination locking retractor	4-20
• Pre-tensioner seat belt	4-21
• Seat belt precautions.....	4-22
• Care of seat belts	4-24
Child Restraint System (CRS).....	4-25
• Children always in the rear.....	4-25
• Selecting a Child Restraint System (CRS)	4-26
• Installing a Child Restraint System (CRS).....	4-27
Air bag - advanced supplemental restraint system.....	4-32
• How does the air bag system operate?.....	4-33
• Do not install a child restraint on the front passenger's seat....	4-34
• Air bag warning light	4-34
• Supplemental Restraint System (SRS) components and functions.....	4-35

4 Safety features of your vehicle

- Occupant Detection System (ODS).....4-36
- Driver's and passenger's front air bag 4-41
- Side air bag.....4-43
- Curtain air bag 4-45
- Air bag collision sensors 4-46
- Why didn't my air bag go off in a collision? (Inflation and non-inflation conditions of the air bag).....4-47
- Supplemental Restraint System (SRS) care 4-49
- Adding equipment to or modifying your air bag-equipped vehicle..... 4-50
- Air bag warning label 4-50

Safety features of your vehicle

Important safety precautions

You will find many safety precautions and recommendations throughout this section, and throughout this manual.

The safety precautions in this section are among the most important.

Always wear your seat belt

A seat belt is your best protection in all types of accidents. Air bags are designed to supplement seat belts, not replace them. So even though your vehicle is equipped with air bags, ALWAYS make sure you and your passengers always wear their seat belts, and wear them properly.

Restrain all children

All children under age 13 should ride in your vehicle properly restrained in a rear seat, not the front seat. Infants and small children should be restrained in an appropriate child restraint. Larger children should use a booster seat with the lap/shoulder belt until they can use the seat belt properly without a booster seat.

Air bag hazards

While air bags can save lives, they can also cause serious or fatal injuries to occupants who sit too close to them, or who are not properly restrained. Infants, young children, and shorter adults are at the greatest risk of being injured by an inflating air bag. Follow all instructions and warnings in this manual.

Driver distraction

Driver distraction presents a serious and potentially deadly danger, especially for inexperienced drivers. Safety should be the first concern when behind the wheel and drivers need to be aware of the wide array of potential distractions, such as drowsiness, reaching for objects, eating, personal grooming, other passengers, and using cellular phones.

Drivers can become distracted when they take their eyes and attention off the road or their hands off the wheel to focus on activities other than driving. To reduce your risk of distraction or getting into an accident:

- ALWAYS set up your mobile devices (i.e., MP3 players, phones, navigation units, etc.) when your vehicle is parked or safely stopped.
- ONLY use your mobile device when allowed by laws and when conditions permit safe use. NEVER text or email while driving. Most countries have laws prohibiting drivers from texting. Some countries and cities also prohibit drivers from using handheld phones.
- NEVER let the use of a mobile device distract you from driving. You have a responsibility to your passengers and others on the road to always drive safely, with your hands on the wheel as well as your eyes and attention on the road.

Control your speed

Excessive speed is a major factor in crash injuries and deaths. Generally, the higher the speed, the greater the risk, but serious injuries can also occur at lower speeds. Never drive faster than is

safe for current conditions, regardless of the maximum speed posted.

Keep your vehicle in safe condition

Having a tire blowout or a mechanical failure can be extremely hazardous. To reduce the possibility of such problems, check your tire pressures and condition frequently, and perform all regularly scheduled maintenance.

Seat

The following explains name, feature and adjustment of each seat.

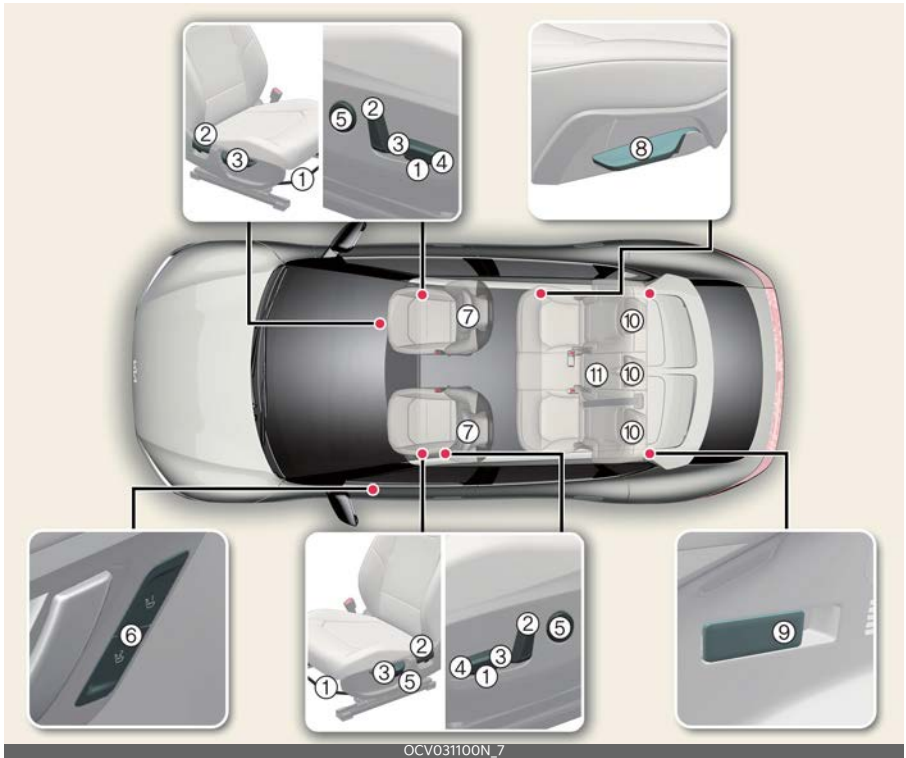

OCV031100N_7

Front seat

- 1 Forward and backward
- 2 Seatback angle
- 3 Seat cushion height
- 4 Seat cushion tilt
- 5 Lumbar support (if equipped)
- 6 Driver position memory system (if equipped)
- 7 Headrest

Rear seat

- 8 Seatback angle/folding
- 9 Seatback folding
- 10 Headrest
- 11 Armrest

⚠ WARNING**Loose Objects**

Do not place anything in the driver's footwell or under the front seats. Loose objects in the driver's foot area could interfere with the operation of the foot pedals.

⚠ WARNING**Uprighting Seat**

Do not press the release lever on a manual seatback without holding and controlling the seatback. The seatback will spring upright possibly impacting you or other passengers.

⚠ WARNING**Driver Responsibility for Passengers**

The driver must advise the passengers to keep the seatback in an upright position whenever the vehicle is in motion. If a seat is reclined during an accident, the restraint system's ability to restrain will be greatly reduced.

⚠ WARNING**Seat Cushion**

Occupants should never sit on aftermarket seat cushions or sitting cushions. The passenger Occupant Detection System (ODS) may not operate properly, or passenger's hips may slide under the lap portion of the seat belt during an accident or a sudden stop.

⚠ WARNING**Driver's Seat**

- Never attempt to adjust the seat while the vehicle is moving. This could result in loss of control of your vehicle.
- Do not allow anything to interfere with the normal position of the seatback. Storing items against the seatback could result in serious or fatal injury in a sudden stop or collision.
- Sit as far back as possible from the steering wheel while still maintaining comfortable control of the your vehicle. A distance of at least 25 cm (10 inches) from your chest to the steering wheel is recommended. Failure to do so can result in air bag inflation injuries to the driver.

⚠ WARNING**Rear Seatbacks**

Always lock the rear seatback before driving. Failure to do so could result in passengers or objects being thrown forward injuring vehicle occupants.

⚠ WARNING**Unexpected Seat Movement**

After adjusting a manual seat, always check that it is locked by shifting your weight to the front and back. Sudden or unexpected movement of the driver's seat could cause you to lose control of the vehicle.

⚠ WARNING**Seat Adjustment**

- Do not adjust the seat while wearing seat belts. Moving the seat forward will cause strong pressure on the abdomen.

- Do not place your hand near the seat bottom or seat track while adjusting the seat. Your hand could get caught in the seat mechanism.

⚠ WARNING

Luggage and Cargo

Do not stock pile or stack luggage or cargo higher than the seatback in the cargo area. In an accident the cargo could strike and injure a passenger. If objects are large, heavy or must be piled, they must be secured in the cargo area.

⚠ WARNING

Cargo Area

Do not allow passengers to ride in the cargo area under any circumstance. The cargo area is solely for the purpose of transporting luggage or cargo.

⚠ WARNING

Small Objects

Use extreme caution when picking up small objects trapped under the seats or between the seat and the center console. Your hands might be cut or injured by the sharp edges of the seats mechanism.

⚠ WARNING

Seat Short Circuit Risk

Be aware of wires or air vents when placing a seat cover or covering the seat with plastic cover. A short circuit may occur, which could lead to fire.

⚠ CAUTION

Precautions with Seat Covers

Use caution when working on the seat cover. A short circuit or disconnection may occur, which could lead to noise or damage the ventilation system.

Feature of seat leather (if equipped)

- Our car seats are upholstered with a combination of artificial and genuine leather. The genuine leather is made from the outer skin of an animal, which goes through a special process to be available for use. Since it is a natural substance, each part differs in thickness or density. Also, wrinkles could appear depending on the temperature and humidity.
- The seat cover is made of stretchable material to improve comfort of passengers.
- The parts contacting the body are curved and the side supporting area is high which provides driving comfort and stability.
- Wrinkles may appear naturally from usage. It is not a fault of the product.

⚠ CAUTION

- Belts with metallic accessories, zippers or keys inside the back pocket may damage the seat fabric.
- Make sure not to wet the seat. It may change the leather.
- Jeans or clothes which could bleach may contaminate the surface of the seat covering fabric.

*** NOTICE**

Wrinkles or abrasions may appear naturally from usage. It is not a fault of product. Wrinkles or abrasions are not covered by warranty.

Infotainment system



Select **Setup** → **Vehicle** → **Seat** from the Settings menu in the infotainment system screen, you may use various convenience functions.

- **Seat Position Change Alert:** When the seat position changes, details of the change are shown with a seat image.
- **Seat Easy Access**
 - **Driver Seat Easy Access (Normal/Extended/Off)** the seat automatically moves when the driver enters or leaves the vehicle may be selected.

For detailed information, refer to the separately supplied infotainment system manual.

*** NOTICE**

The information provided may differ according to which functions are applicable to your vehicle.

Front seat adjustment for manual seat (if equipped)



OCV031002L



OCVG1032002L

The front seat can be adjusted by using the control levers located on the outside of the seat cushion.

Forward and backward (1)

Adjust the seat before driving, and make sure the seat is locked securely by trying to move forward and backward without using the lever. If the seat moves, it is not locked properly.

To move the seat forward or backward:

1. Pull the seat slide adjustment lever up and hold it.
2. Slide the seat to the position you desire.
3. Release the lever and make sure the seat is locked in place.

Seatback angle (2)

To recline the seatback:

1. Lean forward slightly and lift up the seatback recline lever.
2. Carefully lean back on the seat and adjust the seatback of the seat to the position you desire.
3. Release the lever and make sure the seatback is locked in place. (The lever MUST return to its original position for the seatback to lock.)

⚠ WARNING

Reclining Seatback

Sitting in a reclined position when the vehicle is in motion can be dangerous. Even when buckled up, the protections of your restraint system (seat belts and/or air bags) are greatly reduced by reclining your seatback.

Seat belts must be snug against your hips and chest to work properly. When the seatback is reclined, the shoulder belt cannot do its job because it will not be snug against your chest. Instead, it will be in front of you. During an accident, you could be thrown into the seat belt, causing neck or other injuries.

The more the seatback is reclined, the greater chance the passenger's hips will slide under the lap belt or the passenger's neck will strike the shoulder belt.

Seat height (3)

To change the height of the seat, push the lever upwards or downwards.

- To lower the seat cushion, push the lever down several times.
- To raise the seat cushion, pull the lever up several times.

Front seat adjustment for power seat (if equipped)



The front seat can be adjusted by using the control switches located on the outside of the seat cushion.

Before driving, adjust the seat to the proper position so you can easily control the steering wheel, pedals and switches on the instrument panel.

Forward and backward (1)



To move the seat forward or backward:

- Push the control switch forward or backward to move the seat to the desired position. Release the switch once the seat reaches the desired position.

Seatback angle (2)



OCV031121N_2

To recline the seatback:

- Push the control switch forward or backward to move the seatback to the desired angle. Release the switch once the seat reaches the desired position.

Seat height/tilt (3)



OCV031122N_2

To change the height of the seat:

- Pull the front portion of the control switch up to raise or press down to lower the front part of the seat cushion. Pull the rear portion of the control switch up to raise or press down to lower the seat cushion. Release the switch once the seat reaches the desired position.

Lumbar support for driver's seat (if equipped)



OCV031004N_2

The lumbar support can be adjusted by pressing the lumbar support switch on the side of the seat.

1. Press the front portion of the switch (1) to increase support, or the rear portion of the switch (2) to decrease support.
2. Release the switch once it reaches the desired position.

Seatback pocket (if equipped)



OCV031101L

There is a pocket (1) in the front seat back for storing simple books or atlases, and USB charger (2) (if equipped) for rear passengers.

WARNING

Seatback Pockets

Do not put heavy or sharp objects in the seatback pockets. In an accident they could come loose from the pocket and injure vehicle occupants.

Folding the rear seat

The rear seatbacks may be folded to facilitate carrying long items or to increase the luggage capacity of the vehicle.

⚠ WARNING

Folded Seatback

The purpose of the fold-down rear seatbacks is to allow you to carry larger objects that could not otherwise be accommodated.

- Never allow a passenger to sit on top of the folded down seatback while the car is moving. This is not a proper seating position since no seat belts are available for use.
- To reduce the risk of injury caused by sliding cargo within the passenger compartment of the vehicle, objects carried on the folded down seatback should not extend higher than the top of the front seats.

Folding down the rear seatback

1. Set the front seatback to the upright position and if necessary, slide the front seat forward.
2. Lower the rear headrests to the lowest position by pressing the headrest release button (1) while pulling the headrest down (2).



⚠ WARNING

Objects

Objects carried on the folded down seatback should not extend higher than the top of the front seatbacks. This could allow cargo to slide forward and cause injury or damage during sudden stops.

3. Route the seat belt webbing to the outboard of the rear seat to prevent the belts from being trapped behind or under the seats.



4. Pull on the seatback folding lever, then fold the seat toward the front of the vehicle. When you return the seatback to its upright position, always be

sure it has locked into position by pushing on the top of the seatback.



- To use the rear seat, lift and unfold the seatback to the upright position by pulling up the folding lever. Push the seatback firmly until it clicks into place. Make sure the seatback is locked in place.



- Return the rear seat belt to the proper position.

⚠ WARNING

Uprighting Seat

When you return the seatback to its upright position, hold the seatback and return it slowly. If the seatback is returned without holding it, the back of the seat could spring forward, resulting in injury caused by being struck by the seatback.

⚠ WARNING

Rear Seatback

To ensure maximum protection in the event of an accident or sudden stop, when returning the rear seat to the upright position:

- Be careful not to damage the seat belt webbing or buckle.

- Do not allow the seat belt webbing or buckle to become pinched or caught in the rear seat.
- Ensure the seatback is completely locked into its upright position by pushing on the top of the seatback. Failure to adhere to any of these instructions could result in serious injury or death in the event of a crash.

⚠ WARNING

Unless the driver's position is properly set according to the driver's physical size, do not fold the rear seat. It may increase bodily injuries in a sudden stop or collision.

⚠ WARNING

Cargo

Cargo should always be secured to prevent it from being thrown about the vehicle in a collision and causing injury to the vehicle occupants. Do not place objects in the rear seats, since they cannot be properly secured and may hit the front seat occupants in a collision.

⚠ CAUTION

Damaging Rear Seat Belt Buckles

When you fold the rear seatback, insert the buckle between the rear seatback and cushion. Doing so can prevent the buckle from being damaged by the rear seatback.

⚠ CAUTION**Rear Seat Belts**

When returning the rear seatbacks to the upright position, remember to return the rear shoulder belts to their proper position.

⚠ CAUTION

Be careful when loading cargo through the rear passenger seats to prevent damage to the vehicle interior.

Seatback remote folding

Pull the rear seatback folding switch (1, 2) located on both sides of the cargo area.

⚠ WARNING**Rear Seat Folding**

Do not fold the rear seats, if passengers, pets or luggage are in the rear seats. It may cause injury or damage to passengers, pets, luggage.

Cargo Loading

Make sure the vehicle is off, the shifter dial is in P (Park) and the parking brake is securely applied whenever loading or unloading cargo. Failure to take these steps may allow the vehicle to move if the shifter dial is inadvertently moved to another position.

Headrest (for front seat)

The driver's and front passenger's seats are equipped with a headrest for the occupant's safety and comfort.



The headrest not only provides comfort for the driver and front passenger, but also helps protect the head and neck in the event of a rear collision.

For maximum effectiveness in case of an accident, the headrest should be adjusted so the middle of the headrest is at the same height of the center of gravity of an occupant's head. Generally, the center of gravity of most people's head is similar with the height of the top of their eyes.

Also, adjust the headrest as close to your head as possible. For this reason, the use of a cushion that holds the body away from the seatback is not recommended.

⚠ WARNING**Headrest Removal/Adjustment**

- Do not operate the vehicle with the headrests removed. Headrests can provide critical neck and head support in a crash.
- Do not adjust the headrest height while the vehicle is in motion. Driver may lose control of the vehicle.

⚠ CAUTION

Excessive pulling or pushing may damage the headrest.

Adjusting the height up and down (if equipped)

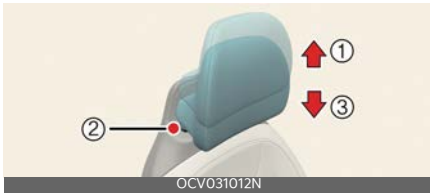

- Pull it up to the desired position (1).
- To lower the headrest, push and hold the release button (2) on the headrest support.
- Lower the headrest to the desired position (3).

Adjusting the headrest forward and backward (if equipped)



Operation

- Pull the headrest fully forward and release it.

* INFORMATION

The headrest may be adjusted forward to 3 different positions by pulling the headrest forward.

* NOTICE

If you fold the seatback towards the front with the headrest and seat cushion raised, the headrest may come in contact with the sun visor or other parts of the vehicle.



Removing headrest

Type A



Type B



To remove the headrest:

1. Recline the seatback (2) with the recline lever or switch (1).
2. Raise headrest as far as it can go.
3. Press the headrest release button (3) while pulling the headrest up (4).

⚠ WARNING

Headrest Removal

NEVER allow anyone to ride in a seat with the headrest removed or reversed. Headrests can provide critical neck and head support in a crash.

Reinstalling headrest

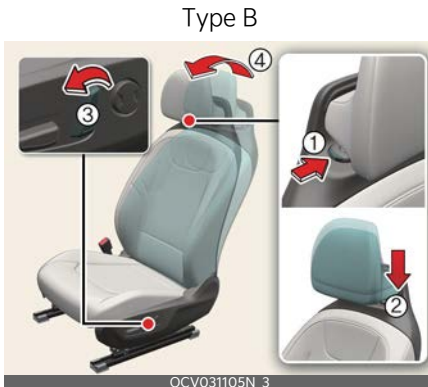

To reinstall the headrest:

1. Put the headrest poles (2) into the holes while pressing the release button (1).
2. Recline the seatback (4) with the recline lever or switch (3).
3. Adjust the headrest to the appropriate height.

⚠ WARNING

Headrest Reinstallation

To reduce the risk of injury to the head or neck, always make sure the headrest is locked into position and adjusted properly after reinstalling.

Headrest (for rear seat)

The rear seat is equipped with headrests in all the seating positions for the occupant's safety and comfort.



The headrest not only provides comfort for passengers, but also helps protect the head and neck in the event of a collision.

For maximum effectiveness in case of an accident, the headrest should be adjusted so the middle of the headrest is at the same height of the center of gravity of an occupant's head. Generally, the center of gravity of most people's heads is similar with the height as the top of their eyes.

Also, adjust the headrest as close to your head as possible. For this reason, the use of a cushion that holds the body away from the seatback is not recommended.

Adjusting the height up and down



- To raise the headrest, pull it up to the desired position (1).
- To lower the headrest, push and hold the release button (2) on the headrest support and lower the headrest to the desired position (3).

Removal and reinstallation



- To remove the headrest, raise it as far as it can go then press the release button (1) while pulling the headrest upward (2).
- To reinstall the headrest, put the headrest poles (3) into the holes while pressing the release button (1).

- Then adjust it to the appropriate height and ensure that it locks in position.

Armrest

To use the armrest, pull it forward from the seatback.



- Slide the cover outwards to use the cup holder.
- Slide the cover inwards to use the storage area.

Seat belts

The following explains seat belts precautions and how to fasten seat belts.

Seat belt restraint system

For maximum restraint system protection, the seat belts must always be used whenever the vehicle is moving.

- A properly positioned shoulder belt should be positioned midway over your shoulder across your collarbone.
- Never allow children to ride in the front passenger seat. See "Child Restraint System (CRS)" on page 4-25 for further discussion.

WARNING

Twisted Seat Belt

Make sure your seat belt is not twisted when worn. A twisted seat belt may not properly protect you in an accident and could even cut into your body.

WARNING

Shoulder Belt

- Never wear the shoulder belt under your arm or behind your back. An improperly positioned shoulder belt cannot protect the occupant in a crash.
- Always wear both the shoulder portion and lap portion of the lap/shoulder belt.

WARNING

Damaged Seat Belt

Replace the entire seat belt assembly if any part of the webbing or hardware is damaged, as you can no longer be sure that a damaged seat belt will provide protection in a crash.

Seat belts are designed to bear upon the bony structure of the body, and should be worn low across the front of the pelvis, chest and shoulders, as applicable; wearing the lap section of the belt across the abdominal area must be avoided.

Seat belts should be adjusted as firmly as possible, consistent with comfort, to provide the protection for which they have been designed.

A slack belt will greatly reduce the protection afforded to the wearer.

Care should be taken to avoid contamination of the webbing with polishes, oils and chemicals, and particularly battery acid. Cleaning may safely be carried out using mild soap and water. The belt should be replaced if webbing becomes frayed, contaminated or damaged.

- No modifications or additions should be made by the user which would either prevent the seat belt adjusting devices from operating to remove slack, or prevent the seat belt assembly from being adjusted to remove slack.
- When you fasten the seat belt, be careful not to latch the seat belt in buckles of other seats. It is very dangerous and you may not be protected by the seat belt properly.
- Do not unfasten the seat belt and do not fasten and unfasten the seat belt repeatedly while driving. This could result in loss of control, and an accident causing death, serious injury, or property damage.
- When fastening the seat belt, make sure that the seat belt does not pass over objects that are hard or can break easily.

⚠ WARNING**Seat Belt Buckle**

Do not allow foreign material (gum, crumbs, coins, liquids, etc.) to obstruct the seat belt buckle. This may prevent the seat belt from fastening securely.

Seat belt warning light**Driver's seat belt warning**

As a reminder to the driver, the seat belt warning light will appear for approximately 6 seconds each time the EV button is in ON regardless of belt fastening.

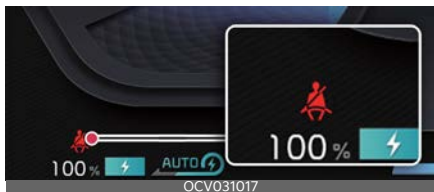

If the driver continues not to fasten the seat belt, the warning light will stay on and the warning chime will sound for approximately 6 seconds until the belt is fastened each time the EV button is in ON. This will happen every time the EV button is in ON.

If a driver continues not to fasten the seat belt and drives 9 km/h (6 mph) or more but less than 20 km/h (12 mph), the warning light will stay on. If a driver unfastens the seat belt while driving below 20 km/h (12 mph), the warning light will stay on.

If a driver continues not to fasten the seat belt while driving over 20 km/h (12 mph), the seat belt warning chime will sound for approximately 100 seconds and the corresponding warning light will blink.

Front passenger's seat belt warning

As a reminder to the front passenger, the seat belt warning light will appear for approximately 6 seconds each time the EV button is in ON regardless of belt fastening. If the front passenger continues not to fasten the seat belt, the warning light will stay on until the belt is fastened each time EV button is in ON.

If a front passenger continues not to fasten the seat belt and the vehicle is driven 9 km/h (6 mph) or more but less than 20 km/h (12 mph), the warning light will stay on.

If a front passenger unfastens the seat belt while the vehicle is driven below 20 km/h (12 mph), the warning light will stay on.

If a front passenger continues not to fasten the seat belt while the vehicle is driven over 20 km/h (12 mph), the seat belt warning chime will sound for approximately 100 seconds and the corresponding warning light will blink.

*** NOTICE**

- Even if the front passenger seat is not occupied, the seat belt warning light will appear for 6 seconds.
- The front passenger's seat belt warning may operate when luggage is placed on the front passenger seat.

Seat belt - driver's 3-point system with emergency locking retractor

The following explains how to fasten and adjust the driver's seat belt.

Fastening the seat belt



- Pull it out of the retractor and insert the metal tab (1) into the buckle (2). There will be an audible "click" when the tab locks into the buckle.



You should place the lap belt portion as low as possible and snugly across your hips. If the lap belt is located too high on your waist, it may increase the chance of injury in the event of a collision.

The arm closest to the seat belt buckle should be over the belt while the other arm should be under the belt as shown in the illustration. Never wear the seat belt under the arm closest to the door.

The seat belt automatically adjusts to the proper length only after the lap belt portion is adjusted manually so that it fits snugly around your hips. If you lean forward in a slow, easy motion, the belt will extend and let you move around. If there is a sudden stop or impact, however, the belt will lock into position. It will also lock if you try to lean forward too quickly.

* NOTICE

If you are not able to pull out the seat belt from the retractor, firmly pull the belt out and release it. Then you will be able to pull the belt out smoothly.

Height adjustment

You can adjust the height of the shoulder belt anchor to one of the 4 positions for maximum comfort and safety.



The height of the adjusting seat belt should not be too close to your neck. The shoulder portion should be adjusted so that it lies across your chest and mid-way over your shoulder near the door and not your neck.

To adjust the height of the seat belt anchor, lower or raise the height adjuster into an appropriate position.

- To raise the height adjuster, pull it up (1).
- To lower it, push it down (2) while pressing the height adjuster button (3).

Release the button to lock the anchor into position. Try sliding the height adjuster to make sure that it has locked into position.

Improperly positioned seat belts can cause serious injuries in an accident.

⚠ WARNING**Shoulder Belt Positioning**

Verify the shoulder belt anchor is locked into position at the appropriate height. Never position the shoulder belt across your neck or face. Improperly positioned seat belts can cause serious injuries in an accident.

⚠ WARNING**Seat Belt Replacement**

After a collision, the seat belt system should be inspected to ensure it is operating normally. Replace any belts that are not functioning appropriately.

Seat belts - front passenger and rear seat 3-point system with combination locking retractor

The following explains how to fasten the passenger's and rear seat belt.

Fastening the seat belt

Combination retractor type seat belts are installed in the rear seat positions to help accommodate the installation of child restraint systems. Although a combination retractor is also installed in the front passenger seat position, it is strongly recommended that children always be seated in the rear seat. NEVER place any infant restraint system in the front seat of the vehicle.

This type of seat belt combines the features of both an emergency locking retractor seat belt and an automatic locking retractor seat belt.

- Pull it out of the retractor and insert the metal tab into the buckle. There will be an audible "click" when the tab locks into the buckle. When not securing a child restraint, the seat belt

operates in the same way as the driver's seat belt (emergency locking retractor type).

It automatically adjusts to the proper length only after the lap belt portion of the seat belt is adjusted manually so that it fits snugly around your hips.

When the seat belt is fully extended from the retractor to allow the installation of a child restraint system, the seat belt operation changes to allow the belt to retract, but not to extend (automatic locking retractor type). Refer to "Securing a child restraint with a lap/shoulder belt" on page 4-30.

⚠ CAUTION

Do NOT fold down the left portion of the rear seatback when the rear center seat belt is buckled. ALWAYS UNBUCKLE the rear center seat belt before folding down the left portion of the rear seatback. If the rear center seat belt is buckled when the left portion of the rear seatback is folded down, distortion and damage to the top portion of the seatback and seat belt garnish may result, causing the seatback to lock into the folded down position.

*** NOTICE**

Although the combination retractor provides the same level of protection for seated passengers in either emergency or automatic locking modes, have the seated passengers use the emergency locking feature for improved convenience. The automatic locking function is intended to facilitate child restraint installation. To convert from the automatic locking feature to the emergency locking operation mode, allow the unbuckled seat belt to fully retract.

The seat belt should be locked into the buckle on each seat cushion to be properly fastened.

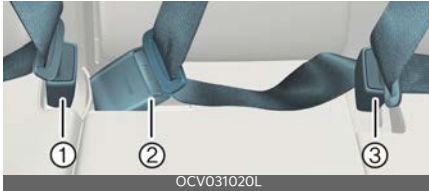

- 1 Rear right seat belt fastening buckle
- 2 Rear center seat belt fastening buckle
- 3 Rear left seat belt fastening buckle

⚠ WARNING

Prior to fastening the rear seat belts, ensure the latch matches the seat belt buckle. Forcefully fastening the left or right seat belt to the center buckle can result in an improper fastening scenario that will not protect you in an accident.

When using the rear center seat belt, the buckle with the "CENTER" mark must be used.



Releasing the seat belt



The seat belt is released by pressing the release button (1) on the locking buckle. When it is released, the belt should automatically draw back into the retractor.

If this does not happen, check the belt to make sure it is not twisted, then try again.

Pre-tensioner seat belt

Your vehicle is equipped with driver's and front passenger's pre-tensioner seat belts (retractor pre-tensioner).



The pre-tensioner seat belts may be activated when a frontal collision is severe enough, together with the air bags.

When the vehicle stops suddenly, or if the occupant tries to lean forward too quickly, the seat belt retractor may lock into position. In certain frontal collisions, the pre-tensioner will activate and pull the seat belt into tighter contact against the occupant's body.

1 Retractor pre-tensioner

The purpose of the retractor pre-tensioner is to make sure that the shoulder belts fit tightly against the occupant's upper body in certain frontal collisions.

If the system senses excessive tension on the driver or passenger's seat belt when the pre-tensioner system activates, the load limiter inside the retractor pre-tensioner will release some of the pressure on the affected seat belt.

*** NOTICE**

When the pre-tensioner seat belts are activated, a loud noise may be heard and fine dust, which may appear to be smoke, may be visible in the passenger

compartment. These are normal operating conditions and are not hazardous.

The seat belt pre-tensioner system consists mainly of the following components. Their locations are shown in the illustration:

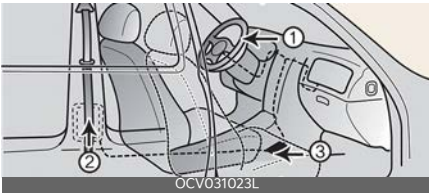

* The actual position of seat belt pre-tensioner system components may differ from the illustration.

- 1 SRS air bag warning light
- 2 Retractor pre-tensioner assembly
- 3 SRS control module

⚠ WARNING

Skin Irritation

Wash all exposed skin areas thoroughly after an accident in which the pre-tensioner seat belts were activated. The fine dust from the pre-tensioner activation may cause skin irritation and should not be inhaled for prolonged periods.

*** NOTICE**

- Both the driver's and front passenger's seat belt pre-tensioner systems may be activated, not only in certain frontal collisions, but also in certain side collisions or rollovers, if the vehicle is equipped with a side or curtain air bag.
- Because the sensor that activates the SRS air bag is connected with the pre-tensioner seat belt, the SRS air bag warning light (👤) on the instrument panel will appear for approximately 6

seconds after the EV button has been changed to the ON position, and then it should turn off.

If the pre-tensioner seat belt system is not working properly, this warning light will appear even if there is not a malfunction with the SRS air bag. If the SRS air bag warning light does not appear when EV button has been changed to ON, or if it remains on after appearing for approximately 6 seconds, or if it appears while the vehicle is being driven, have an authorized Kia dealer inspect the pre-tensioner seat belt and SRS air bag system as soon as possible.

⚠ WARNING

Hot Pre-tensioner

Do not touch the pre-tensioner seat belt assemblies for several minutes after they have been activated. When the pre-tensioner seat belt mechanism fires during a collision, the pre-tensioner becomes hot and can burn you.

*** NOTICE**

Do not attempt to service or repair the pre-tensioner seat belt system in any manner. Do not attempt to inspect or replace the pre-tensioner seat belts yourself. This must be done by an authorized Kia dealer.

Pre-tensioners are designed to operate only one time. After activation, pre-tensioner seat belts must be replaced. If the pre-tensioner must be replaced, contact an authorized Kia dealer.

Seat belt precautions

Take the following precautions when using seat belts.

Infant or small child

Most countries have child restraint laws. You should be aware of the specific requirements in your country. Child and/or infant seats must be properly placed and installed in the rear seat. For more information about the use of these restraints, refer to "Child Restraint System (CRS)" on page 4-25.

* NOTICE

Small children are best protected from injury in an accident when properly restrained in the rear seat by a child restraint system that meets the requirements of the Safety Standards of your country. Before buying any child restraint system, make sure that it has a label certifying that it meets Safety Standards of your country. The restraint must be appropriate for your child's height and weight. Check the label on the child restraint for this information. Refer to "Child Restraint System (CRS)" on page 4-25.

Larger children

Children who are too large for child restraint systems should always occupy the rear seat and use the available lap/shoulder belts. The lap portion should be fastened and snug on the hips as low as possible. Check periodically to insure that the belt fits. A child's squirming could put the belt out of position. Children are given the most safety in the event of an accident when they are restrained by a proper restraint system in the rear seat. If a larger child (over age 13) must be seated in the front seat, the child should be securely restrained by the available lap/shoulder belt and the seat should be placed in the rearmost

position. Children age 13 and under should be restrained securely in the rear seat. NEVER place a child age 13 and under in the front seat. NEVER place a rear facing child seat in the front seat of a vehicle.

If the shoulder belt portion slightly touches the child's neck or face, try placing the child closer to the center of the vehicle. If the shoulder belt still touches their face or neck they need to be returned to a child restraint system.

⚠ WARNING

Small Children

Do not allow small children to ride in the vehicle without an appropriate child restraint system. If the shoulder belt comes in contact with your child's neck or face, your child is too small to ride in the vehicle. In a crash the seat belt will inflict injury to your child's neck, throat and face.

Restraint of pregnant women

Pregnant women should wear lap/shoulder belt assemblies whenever possible according to specific recommendations by their doctors. The lap portion of the belt should be worn AS SECURELY AND LOW AS POSSIBLE.

⚠ WARNING

Pregnant Women

Pregnant women must never place the lap portion of the seat belt above or on the abdomen where the fetus is located. The force of the seat belt during a collision can seriously injure the fetus.

Injured person

A seat belt should be used when an injured person is transported. In such cases, you should consult a physician for recommendations.

One person per belt

Two people (including children) should never attempt to use a single seat belt. This could increase the severity of injuries in case of an accident.

Do not lie down

To reduce the chance of injuries in the event of an accident and to achieve maximum effectiveness of the restraint system, all passengers should be sitting up and the front and rear seats should be in an upright position when the vehicle is moving. A seat belt cannot provide proper protection if the person is lying down in the rear seat or if the front and rear seats are in a reclined position.

Care of seat belts

Seat belt systems should never be disassembled or modified. In addition, care should be taken to assure that seat belts and belt hardware are not damaged by seat hinges, doors or other abuse.

WARNING

Pinched Seat Belt

Make sure that the webbing and/or buckle does not get caught or pinched in the rear seat when returning the rear seatback to its upright position. A caught or pinched webbing/buckle may become damaged and could fail during a collision or sudden stop.

WARNING

Seatbelts can become hot in a vehicle that has been closed up in sunny weather. They could burn infants and children.

Periodic inspection

All seat belts should be inspected periodically for wear or damage of any kind. Any damaged parts should be replaced as soon as possible.

Keep belts clean and dry

Seat belts should be kept clean and dry. If belts become dirty, they can be cleaned by using a mild soap solution and warm water. Bleach, dye, strong detergents or abrasives should not be used because they may damage and weaken the fabric.

When to replace seat belts

The entire in-use seat belt assembly or assemblies should be replaced if the vehicle has been involved in an accident. This should be done even if no damage is visible. Additional questions concerning seat belt operation should be directed to an authorized Kia dealer.

Child Restraint System (CRS)

Infants and younger children must be restrained in an appropriate rear-facing or forward-facing CRS that has first been properly secured to the rear seat of the vehicle.

Children always in the rear

Children under age 13 must always ride in the rear seats and must always be properly restrained to minimize the risk of injury in an accident, sudden stop or sudden maneuver.

WARNING

Restraint Location

Never install a child or infant seat in the front passenger's seat. A child riding in the front passenger seat can be forcefully struck by an inflating airbag and get seriously injured.

WARNING

Hot Child Restraint

A child restraint system can become very hot if it is left in a closed vehicle on a sunny day. Be sure to check the seat cover, buckles and latches before placing a child in the restraint system.

According to accident statistics, children are safer when properly restrained in the rear seats than in the front seat. Even with air bags, children can be seriously injured or killed. Children too large for a child restraint must use the seat belts provided.

Most countries have child restraint laws which require children to travel in approved child restraint devices. The laws governing the age or height/weight restrictions at which seat belts can be used instead of child restraints differs

among countries, so you should be aware of the specific requirements in your country, and where you are traveling.

Child restraint systems must be properly placed and installed in the rear seat. You must use a commercially available child restraint system that meets the requirements of the Safety Standards of your country.

Child restraint systems are generally designed to be secured in a vehicle seat by lap belt portion of a lap/shoulder belt, or by a LATCH system in the rear seats of the vehicle.

Child restraint system (CRS)

Infants and younger children must be restrained in an appropriate rear-facing or forward-facing CRS that has first been properly secured to the rear seat of the vehicle. Read and comply with the instructions for installation and use provided by the manufacturer of the CRS.

WARNING

Child Restraint Installation

An improperly secured child restraint system can increase the risk of serious injury or death in an accident. Always take the following precautions when using a child restraint system:

- Always follow the child restraint system manufacturer's instructions for installation and use.
- Always properly restrain your child in the child restraint system.
- If the vehicle head restraint prevents proper installation of a child seat (as described in the child restraint system manual), the head restraint of the respective seating position should be readjusted or entirely removed.

- Do not use an infant carrier or a child safety seat that "hooks" over a seat-back, as it may not provide adequate protection in an accident.

* NOTICE

After an accident, have a Kia dealer check the child restraint system, seat belts, tether anchors and lower anchors.

Selecting a Child Restraint System (CRS)

When selecting a CRS for your child, always:

- Make sure the CRS has a label certifying that it meets applicable Safety Standards of your country.
- Select a child restraint based on your child's height and weight. The required label or the instructions for use typically provide this information.
- Select a child restraint that fits the vehicle seating position where it will be used.
- Read and comply with the warnings and instructions for installation and use provided with the child restraint system.

⚠ WARNING

Holding Children

Never hold a child in your arms or lap when riding in a vehicle. The violent forces created during a crash will tear the child from your arms and throw the child against the car's interior. Always use a child restraint system, which is appropriate for your child's height and weight.

⚠ WARNING

Unattended Children

Never leave children unattended in a vehicle. The car can heat up very quickly, resulting in injuries to the child in the vehicle.

⚠ WARNING

Seat Belt Use

Do not use one seat belt for two occupants at the same time. This will eliminate any safety benefit provided by the seat belt to the occupants.

Child restraint system types

There are three main types of child restraint systems: rear-facing seats, forward-facing seats, and booster seats. They are classified according to the child's age, height and weight.

Rear-facing child seats



ONQ5021098N

A rear-facing child seat provides restraint with the seating surface against the back of the child. The harness system holds the child in place, and in an accident, acts to keep the child positioned in the seat and reduces the stress to the neck and spinal cord.

All children under age one must always ride in a rear-facing infant child restraint. Convertible and 3-in-1 child seats typically have higher height and weight limits for the rear-facing position, allowing

you to keep your child rear-facing for a longer period of time.

Continue to use a rear-facing child seat for as long as your child will fit within the height and weight limits allowed by the child seat manufacturer. It's the best way to keep them safe. Once your child has outgrown the rear-facing child restraint, your child is ready for a forward-facing child restraint with a harness.

Forward-facing child restraints



A forward-facing child seat provides restraint for the child's body with a harness. Keep children in a forward-facing child seat with a harness until they reach the top height or weight limit allowed by your child restraint's manufacturer.

Once your child outgrows the forward-facing child restraint, your child is ready for a booster seat.

Booster seats

A booster seat is a restraint designed to improve the fit of the vehicle's seat belt system. A booster seat positions the seat belt so that it fits properly over the lap of your child.

Keep your child in a booster seat until they are big enough to sit in the seat without a booster and still have the seat belt fit properly. For a seat belt to fit properly, the lap belt must lie snugly across the upper thighs, not the stomach. The shoulder belt should lie snug across the shoulder and chest and not

across the neck or face. Children under age 13 must always ride in the rear seats and must always be properly restrained to minimize the risk of injury.

Installing a Child Restraint System (CRS)

After selecting a proper child seat for your child, check to make sure it fits properly in your vehicle.

Follow the instructions provided by the manufacturer when installing the child seat. Note these general steps when installing the seat to your vehicle:

- **Properly secure the child restraint to the vehicle.** All child restraints must be secured to the vehicle with the lap part of a lap/shoulder belt or with the LATCH system.
- **Make sure the child restraint is firmly secured.** After installing a child restraint to the vehicle, push and pull the seat forward and from side-to-side to verify that it is securely attached to the seat. A child restraint secured with a seat belt should be installed as firmly as possible. However, some side-to-side movement can be expected.
- **Secure the child in the child restraint.** Make sure the child is properly strapped in the child restraint according to the manufacturer instructions.

Lower Anchors and Tether for Children (LATCH) System

The LATCH system holds a child restraint during driving and in an accident. This system is designed to make installation of the child restraint easier and reduce the possibility of improperly installing your child restraint. The LATCH

system uses anchors in the vehicle and attachments on the child restraint. The LATCH system eliminates the need to use seat belts to secure the child restraint to the rear seats.

Lower anchors are metal bars built into the vehicle. There are two lower anchors for each LATCH seating position that will accommodate a child restraint with lower attachments.

To use the LATCH system in your vehicle, you must have a child restraint with LATCH attachments.

The child seat manufacturer will provide you with instructions on how to use the child seat with its attachments for the LATCH lower anchors.



LATCH anchors have been provided in the left and right outboard rear seating positions. Their locations are shown in the illustration. There are no LATCH anchors provided for the center rear seating position.

⚠ WARNING

LATCH Lower Anchors

Never attempt to attach a LATCH equipped seat in the center seating position. LATCH lower anchors are only to be used in the left and right rear outboard seating positions. You may damage the anchors or the anchors may fail and break in a collision if the seat is in the center seating position.

The lower anchor position indicator symbols are located on the left and right rear seatbacks to identify the position of the lower anchors in your vehicle (see arrows in illustration).



- 1 Lower Anchor position indicator
- 2 Lower Anchor

The LATCH anchors are located between the seatback and the seat cushion of the rear seat left and right outboard seating positions.

To use the lower anchor, push the upper portion of the lower anchor cover.

Securing a child restraint with the LATCH anchors system

To install a LATCH-compatible child restraint in either of the rear outboard seating positions:

1. Move the seat belt buckle away from the lower anchors.
2. Move any other objects away from the anchors that could prevent a secure connection between the child restraint and the lower anchors.
3. Place the child restraint on the vehicle seat, then attach the seat to the lower anchors according to the instructions provided by the child restraint manufacturer.

- Follow the child restraint instructions for properly adjusting and tightening the lower attachments on the child restraint to the lower anchors.

⚠ WARNING

Take the following precautions when using the LATCH system:

- Read and follow all installation instructions provided with your child restraint system.
- To prevent the child from reaching and taking hold of the unused seat belts, buckle all unused rear seat belts before the child is placed into the vehicle. Lock each unused seatbelt following the instructions in the "automatic locking mode" subsection, and place the webbing behind the child seat or against an unused seatback. Children can be strangled if a shoulder belt becomes wrapped around their neck and the seat belt tightens.
- NEVER attach more than one child restraint to a single anchor. This could cause the anchor or attachment to come loose or break.
- Always have the LATCH system inspected by your authorized Kia dealer after an accident. An accident can damage the LATCH system and may not properly secure the child restraint.

Securing a child restraint seat with "Tether Anchor" system



First secure the child restraint with the LATCH lower anchors or the seat belt. If the child restraint manufacturer recommends that the top tether strap be attached, attach and tighten the top tether strap to the top tether strap anchor.

Child restraint hook holders are located on the shelf behind the rear seats.

⚠ WARNING

Take the following precautions when installing the tether strap:

- Read and follow all installation instructions provided with your child restraint system.
- NEVER attach more than one child restraint to a single tether anchor. This could cause the anchor or attachment to come loose or break.
- Do not attach the tether strap to anything other than the correct tether anchor. It may not work properly if attached to something else.
- Do not use the tether anchors for adult seat belts or harnesses, or for attaching other items or equipment to the vehicle.
- Always fasten the seat belts behind the child restraint seat when they are not used to secure the child seat. Failure to do so may result in child strangulation.

To install the tether anchor:



1. Route the child restraint tether strap over the child restraint seatback. Route the tether strap under the head restraint and between the head restraint posts, or route the tether strap over the top of the vehicle seatback. Make sure the strap is not twisted.
2. Connect the tether strap hook to the tether anchor, then tighten the tether strap according to the child seat manufacturer's instructions to firmly secure the child restraint to the seat.
3. Check that the child restraint is securely attached to the seat by pushing and pulling the seat forward and from side-to-side.

Securing a child restraint with a lap/shoulder belt

When not using the LATCH system, all child restraints must be secured to a vehicle rear seat with the lap part of a lap/shoulder belt.

Automatic locking mode



Since all passenger seat belts move freely under normal conditions and only lock under extreme or emergency conditions (emergency locking mode), you must manually pull the seat belt all the way out to shift the retractor to the "automatic locking" mode to secure a child restraint.

The "automatic locking" mode will help prevent the normal movement of the child in the vehicle from causing the seat belt to loosen and compromise the child restraint system.

To install a child restraint system on the rear seats, do the following:

1. Place the child restraint system on a rear seat and route the lap/shoulder belt around or through the child restraint, following the restraint manufacturer's instructions.
Be sure the seat belt webbing is not twisted.
2. Fasten the lap/shoulder belt latch into the buckle. Listen for the distinct "click" sound.

Position the release button so that it is easy to access in case of an emergency.



3. Pull the shoulder portion of the seat belt all the way out. When the shoulder portion of the seat belt is fully extended, it will shift the retractor to the "automatic locking" (child restraint) mode.



4. Slowly allow the shoulder portion of the seat belt to retract and listen for an audible "clicking" or "ratcheting" sound. This indicates that the retractor is in the "automatic locking" mode. If no distinct sound is heard, repeat steps 3 and 4.



5. Remove as much slack from the belt as possible by pushing down on the child restraint system while feeding the shoulder belt back into the retractor.
6. Push and pull on the child restraint system to confirm that the seat belt is holding it firmly in place. If it is not, release the seat belt and repeat steps 2 through 5.
7. Double check that the retractor is in the "automatic locking" mode by attempting to pull more of the seat belt out of the retractor. If you cannot, the retractor is in the "automatic locking" mode.

If your CRS manufacturer instructs or recommends you to use a tether anchor with the lap/shoulder belt, refer to "Securing a child restraint with the LATCH anchors system" on page 4-28 for more information.

⚠ WARNING

Auto Lock Mode

Set the retractor to Automatic Lock mode when installing any child restraint system. If the retractor is not in the automatic locking mode, the child restraint can move when your vehicle turns or stops suddenly. A child can be seriously injured or killed if the child restraint is not properly anchored in the car, including manually pulling the seat belt all the way out to shift the retractor to the "Auto Lock" mode.

*** NOTICE**

When the seat belt is allowed to retract to its fully stowed position, the retractor will automatically switch from the "automatic locking" mode to the emergency lock mode for normal adult usage.

To remove the child restraint, press the release button on the buckle and then pull the lap/shoulder belt out of the restraint and allow the seat belt to retract fully.

Air bag - advanced supplemental restraint system

The appropriate air bags inflate instantly in the event of a serious frontal collision or side collision in order to help protect the occupants from serious physical injury.



OCV031098N

* The actual air bags in the vehicle may differ from the illustration.

- 1 Passenger's front air bag
- 2 Driver's front air bag
- 3 Side air bag
- 4 Curtain air bag
- 5 Driver's knee air bag

Even in vehicles with air bags, you and your passengers must always wear the safety belts provided in order to minimize the risk and severity of injury in the event of a collision or rollover.

How does the air bag system operate?

- Air bags are activated (able to inflate if necessary) only when the EV button has been changed to ON position or the vehicle is in the ready mode.
- The appropriate air bags inflate instantly in the event of a serious frontal collision or side collision in order to help protect the occupants from serious physical injury.
- Generally, air bags are designed to inflate based upon the severity of a collision and its direction. These two factors determine whether the sensors produce an electronic deployment/inflation signal.
- Air bags will inflate based upon the severity of a collision and its direction, etc. But air bags will not inflate in every crash or collision situation.
- The front air bags will completely inflate and deflate in an instant. It is virtually impossible for you to see the air bags inflate during an accident. It is much more likely that you will simply see the deflated air bags hanging out of their storage compartments after the collision.
- In addition to inflating in serious side collisions, side and/or curtain air bags will inflate if the sensing system detects a rollover.
- When a rollover is detected, side and/or curtain air bags will remain inflated longer to help provide protection from ejection, especially when used in conjunction with the seat belts.
- In order to help provide protection, the air bags must inflate rapidly. The speed of the air bag inflation is a consequence of extremely short time in which to inflate the air bag between

the occupant and the vehicle structures before the occupant impacts those structures. This speed of inflation reduces the risk of serious or life-threatening injuries and is thus a necessary part of the air bag design. However, air bag inflation can also cause injuries which can include facial abrasions, bruises and broken bones because the inflation speed also causes the air bags to expand with a great deal of force.

- **There are even circumstances under which contact with the steering wheel or passenger air bag can cause fatal injuries, especially if the occupant is positioned excessively close to the steering wheel or passenger air bag.**

WARNING

Airbag Inflation

Sit as far back as possible from the steering wheel while still maintaining comfortable control of the vehicle. A distance of at least 25 cm (10 in) from your chest to the steering wheel is recommended. Failure to do so can result in airbag inflation injuries to the driver.

Noise and smoke

When inflated, the air bags make a loud noise and leave smoke and powder in the air inside the vehicle. This is normal and is a result of the ignition of the air bag inflator. After the air bag inflates, you may feel substantial discomfort in breathing due to the contact of your chest with both the seat belt and the air bag, as well as from breathing the smoke and powder. **Open your doors and/or windows as soon as possible after impact in order to reduce dis-**

comfort and prevent prolonged exposure to the smoke and powder.

Though smoke and powder are non-toxic, it may cause irritation to the skin (eyes, nose and throat, etc). If this is the case, wash and rinse with cold water immediately and consult a doctor if the symptom persists.

⚠ WARNING

Hot Components

Do not touch the air bag storage area's internal components immediately after airbag inflation. The air bag related parts in the steering wheel, instrument panel and the roof rails above the front and rear doors are very hot. Hot components can result in burn injuries.

⚠ WARNING

Do not install or place any accessories near air bag deployment areas, such as the instrument panel, windows, pillars, and roof rails.

Do not install a child restraint on the front passenger's seat

Never place a rear-facing child restraint in the front passenger's seat.



If the air bag deploys, it would impact the rear-facing child restraint, causing serious or fatal injury.

In addition, do not place front-facing child restraints in the front passenger's seat. If the front passenger air bag

inflates, it could cause serious or fatal injuries to the child.

⚠ WARNING

Air Bag Deployment

When children are seated in the rear outboard seats of a vehicle equipped with side and/or curtain air bags, install the child restraint system as far away from the door side as possible. Inflation of the side and/or curtain air bags could impact the child.

Air bag warning light

The purpose of air bag warning light in your instrument panel is to alert you of a potential problem with your air bag system, which could include your side and/or curtain air bags used for rollover protection.

If the air bag warning light appears for more than 6 seconds after EV button has been changed to ON, or if appears during vehicle operation, an SRS component may not be functioning properly and you should have your vehicle checked by an authorized Kia dealer.



If any of the following conditions occur, this indicates a malfunction in the air bag system. Have an authorized Kia dealer inspect the air bag system as soon as possible.

- The light does not turn on briefly when you change EV button to ON.
- The light stays on after appearing for approximately 6 seconds.
- The light comes on while the vehicle is in motion.

- The light blinks when EV button is in the ON position.

Supplemental Restraint System (SRS) components and functions

The SRS consists of multiple elements and sensors.

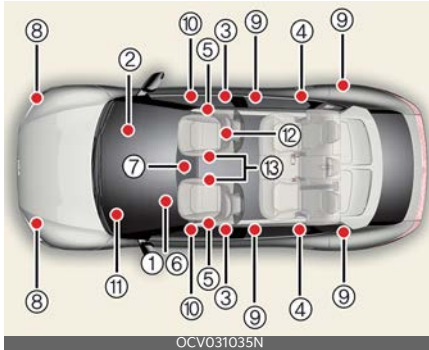

* The actual position of SRS components may differ from the illustration.

The SRS consists of the following components:

- 1 Driver's front air bag module
- 2 Passenger's front air bag module
- 3 Side air bag modules
- 4 Curtain air bag modules
- 5 Retractor pre-tensioner assemblies
- 6 Air bag warning light
- 7 SRS control module (SRSCM)/rollover sensor
- 8 Front impact sensors
- 9 Side impact sensors
- 10 Side pressure sensors
- 11 Driver's knee air bag module
- 12 Occupant detection system (Front passenger's seat only)
- 13 Front driver/passenger's seat belt buckle sensor

Driver's front air bag (1)



The front air bag modules are located both in the center of the steering wheel and in the front passenger's panel above the glove box. When the SRSCM detects a sufficiently severe impact to the front of the vehicle, it will automatically deploy the front air bags.

Driver's front air bag (2)



Upon deployment, tear seams molded directly into the pad covers will separate under pressure from the expansion of the air bags. Further opening of the covers then allows full inflation of the air bags.

Driver's front air bag (3)



A fully inflated air bag, in combination with a properly worn seat belt, slows the driver's or the passenger's forward motion, reducing the risk of head and chest injury.

After complete inflation, the air bag immediately starts deflating, enabling the driver to maintain forward visibility and the ability to steer or operate other controls.

Passenger's front air bag



⚠ WARNING

Air Bag Obstructions

Do not install or place any accessories on the steering wheel, instrument panel, or on the front passenger's panel above the glove box in a vehicle. Such objects may become dangerous projectiles if the air bag deploys.

⚠ WARNING

Flying Objects

Do not place any objects (an umbrella, bag, etc.) between the front door and the front seat. Such objects may become dangerous projectiles if the side airbag inflates.

- If an air bag deploys, there may be a loud noise followed by a fine dust released in the vehicle. These conditions are normal and are not hazardous - the air bags are packed in this fine powder. The dust generated during air bag deployment may cause skin or eye irritation as well as aggravate asthma for some persons. Always wash all exposed skin areas thoroughly with cold water and a mild

soap after an accident in which the air bags were deployed.

- The SRS can function only when EV button is in the ON position. If the SRS air bag warning light does not appear, or continuously remains on after appearing for about 6 seconds when EV button is in the ON position after the vehicle is in the **READY** mode, or comes on while driving, the SRS is not working properly. If this occurs, have your vehicle immediately inspected by an authorized Kia dealer.

*** NOTICE**

Before you replace a fuse or disconnect a battery terminal, change the EV button to the OFF position. Never remove or replace the air bag related fuse(s) when the EV button is in the ON position. Failure to heed this warning will cause the SRS air bag warning light to appear.

Occupant Detection System (ODS)

Your vehicle is equipped with an occupant detection system in the front passenger's seat.



The occupant detection system is designed to detect the presence of a properly-seated front passenger and determine if the passenger's front air bag should be enabled (may inflate) or not. Only the front passenger front air bag is controlled by the Occupant Detection System.

Do not put anything in front of the passenger air bag OFF indicator.

Main components of the occupant detection system

- An detection device located within the front passenger seat cushion.
- An electronic system which determines whether the passenger air bag systems should be activated or deactivated.
- An indicator light located on the instrument panel which appears the words PASSENGER AIR BAG OFF indicates the front passenger air bag system is deactivated.
- The instrument panel air bag warning light is interconnected with the occupant detection system.

If the front passenger seat is occupied by a person that the system determines to be of appropriate size, and he/she sits properly (sitting upright with the seatback in an upright position, centered on the seat cushion with their seat belt on, legs comfortably extended and their feet on the floor), the PASSENGER AIR BAG OFF indicator will turn off and the front passenger's air bag will be able to inflate, if necessary, in frontal crashes.

You will find the PASSENGER AIR BAG OFF indicator on the map lamp. This system detects the conditions 1~4 in the following table and activates or deactivates the front passenger air bag based on these conditions.

Always be sure that you and all vehicle occupants are seated and restrained properly (sitting upright with the seat in an upright position, centered on the seat cushion, with the person's legs comfortably extended, feet on the floor, and wearing the safety belt properly) for the

most effective protection by the air bag and the safety belt.

- The ODS (Occupant Detection System) may not function properly if the passenger takes actions which can defeat the detection system. These include:
 1. Failing to sit in an upright position.
 2. Leaning against the door or center console.
 3. Sitting towards the sides or the front of the seat.
 4. Putting legs on the dashboard or resting them on other locations which reduce the passenger weight on the front seat.
 5. Improperly wearing the safety belt.
 6. Reclining the seatback.

Condition and operation in the front passenger occupant detection system

- * 1. The system judges a person of adult size as an adult. When a smaller adult sits in the front passenger seat, the system may recognize him/her as a child depending on his/her physique and posture.
- * 2. Do not allow children to ride in the front passenger seat. When a larger child who has outgrown a child restraint system sits in the front passenger seat, the system may recognize him/her as an adult depending upon his/her physique or sitting position.
- * 3. Never install a child restraint system on the front passenger seat.
- * 4. The PASSENGER AIR BAG OFF indicator may turn on or off when a child above 12 months to 12 years old (with or without child restraint system) sits in the front passenger seat. This is a normal condition.

Condition detected by the occupant classification system	Indicator/Warning light		Devices
	"PASSENGER AIR BAG OFF" indicator light	SRS warning light	Front passenger air bag
1. Adult ¹	Off	Off	Activated
2. Child restraint system with child under 12 months old ^{2,3,4}	On	Off	Deactivated
3. Unoccupied	On	Off	Deactivated
4. Malfunction in the system	Off	On	Activated

⚠ WARNING

- Do not install a child restraint system in the passenger seat when the seat is heavily soaked with any type of liquid.
- Do not alter or modify the ODS (Occupant Detection System). This may damage the system and prevent its proper function in a collision.

*** NOTICE**

- Do not use car seat cushions that cover up the surface of the seat and aftermarket manufactured passenger seat heaters.
- After conducting car interior cleaning using steam or detergent, the seat should be dried properly. Afterward, check for normal operation of the PASSENGER AIR BAG OFF and air bag warning lights.
- Any service related to the passenger seat and the ODS must be done at an authorized Kia service center.
- After the passenger seat has been removed or installed for repair purposes, check for normal operation of the PASSENGER AIR BAG OFF and air bag warning lights with a person seated or not seated in the passenger seat.

⚠ WARNING

When the PASSENGER AIR BAG OFF symbol appears, the passenger air bag system will not operate. The passenger air bag system will operate when necessary if the symbol does not appear.

*** NOTICE**

Do not modify or replace the front passenger seat. Do not place anything on or attach anything, such as a blanket, front seat cover or aftermarket seat heater, to the front passenger seat. This can adversely affect the occupant detection system.

⚠ WARNING

ODS System

Riding in an improper position adversely affects the Occupant Detection System and may result in the deactivation of the front passenger airbag. It is important for the driver to instruct the passenger as to the proper seating instructions as contained in this manual.

- Do not place a heavy load in the front passenger seatback pocket or on the front passenger seat.



- Do not place feet on the front passenger seatback.



Safety features of your vehicle

- Do not move your hips too forward in the seat.



- Never excessively recline the front passenger seatback.



- Never place feet on the dashboard.



- Never lean on the door or center console.
- Do not sit with your weight excessively skewing to the left or right on the front passenger seat.



- Do not use car seat accessories, such as thick blankets and cushions, that cover up the car seat surface.

Air bag - advanced supplemental restraint system

- Do not sit on the passenger seat wearing heavily padded clothes, such as ski wear and hip protector.



- Do not place electronic devices, such as laptops and DVD player, or conductive materials such as water bottles, on the passenger seat.
- Do not use electronic devices, such as laptops and satellite radios, that use inverter chargers.

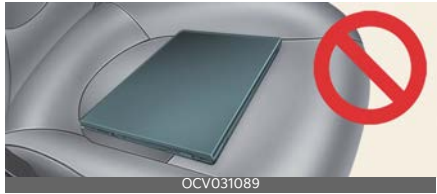

- Wet Passenger Seat

Do not spill liquid in the passenger seat. Spilled liquid on the passenger seat may cause the air bag warning light to appear or malfunction. If any liquid is spilled, make sure the seat has been completely dried before driving the vehicle.

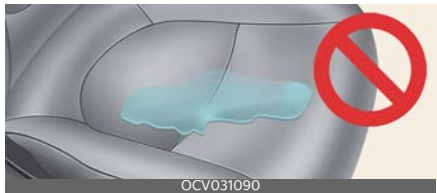

Proper position



When an adult is seated in the front passenger seat, if the PASSENGER AIR BAG OFF indicator is on, change EV button to the OFF position and ask the passenger to sit properly (sitting upright with the seatback in an upright position, centered on the seat cushion with their seat belt on, legs comfortably extended and their feet on the floor). Restart the vehicle and have the person remain in that position. This will allow the system to detect the person and to enable the passenger air bag.

If the PASSENGER AIR BAG OFF indicator is still on, ask the passenger to move to the rear seat.

⚠ WARNING

PASSENGER AIR BAG OFF Light

Do not allow an adult passenger to ride in the front seat when the PASSENGER AIR BAG OFF indicator appears because the air bag will not deploy in the event of a crash. The driver must instruct the passenger to reposition himself in the seat. Failure to properly position himself may lead to air bag deactivation, resulting in air bag non-deployment in a collision. If the PASSENGER AIR BAG OFF indicator remains on after the passenger repositions themselves properly and the car is restarted, it is recommended that the passenger move to the rear seat because the passenger's front air bag will not deploy.

*** NOTICE**

The PASSENGER AIR BAG OFF indicator appears for about 4 seconds after EV button is turned to the ON position after the vehicle is started. If the front passenger seat is occupied, the occupant detection sensor will then classify the front passenger after several more seconds.

- Even though your vehicle is equipped with the occupant detection system, never install a child restraint system in the front passenger's seat. A deploying air bag can forcefully strike a child resulting in serious injuries or death.

Any child age 13 and under should ride in the rear seat. Children too large for child restraints should use the available lap/shoulder belts. No matter what type of crash, children of all ages are safer when restrained in the rear seat.

If the occupant detection system is not working properly, the SRS air bag warning light on the instrument panel will appear because the passenger's front air bag is connected with the occupant detection system. If there is a malfunction of the occupant detection system, the PASSENGER AIR BAG OFF indicator will not appear and the passenger's front air bag will inflate in frontal impact crashes even if there is no occupant in the front passenger's seat.

Driver's and passenger's front air bag

Your vehicle is equipped with an Advanced Supplemental Restraint (Air Bag) System and lap/shoulder belts at both the driver and passenger seating position.

Driver's front air bag



Driver's knee air bag



Passenger's front air bag



The indication of the system's presence are the letters "AIR BAG" located on the air bag pad cover on the steering wheel and the passenger's side front panel pad above the glove box.

The SRS consists of air bags installed under the pad covers in the center of the steering wheel and the passenger's side front panel above the glove box.

The purpose of the SRS is to provide the vehicle's driver and/or the front passenger with additional protection than that offered by the seat belt system alone in case of a frontal impact of sufficient severity. The SRS uses sensors to gather information about the driver's and front passenger's seat belt usage and impact severity.

The seat belt buckle sensor determines if the front passenger's seat belt is fastened.

These sensors provide the ability to control the SRS deployment based on whether or not the seat belts are fastened, and how severe the impact is.

The advanced SRS offers the ability to control the air bag inflation with two levels. A first stage level is provided for moderate-severity impacts. A second stage level is provided for more severe impacts.

The passenger's front air bag is designed to help reduce the injury of children sitting close to the instrument panel in low speed collisions. However, children are safer if they are restrained in the rear seat.

According to the impact severity and seat belt usage, the SRSCM (SRS Control Module) controls the air bag inflation. Failure to properly wear seat belts can increase the risk or severity of injury in an accident.

Additionally, your vehicle is equipped with an occupant detection system in the front passenger's seat. The occupant detection system detects the presence of a passenger in the front passenger's seat and will turn off the front passenger's air bag under certain conditions. For more detail, see "Occupant Detection System (ODS)" on page 4-36.

⚠ WARNING

Modification

Modification to the seat structure can cause the air bag to deploy at a different level than should be provided.

Manufacturers are required by government regulations to provide a contact point concerning modifications to the

vehicle for persons with disabilities, which modifications may affect the vehicle's advanced air bag system. That contact is Kia's toll-free Customer Experience Department at 1-877-KIA-AUTO (1-877-542-2886). However, Kia does not endorse nor will it support any changes to any part or structure of the vehicle that could affect the advanced air bag system, including the occupant detection system.

⚠ WARNING

Replacement/Modifications

The front passenger seat, dashboard or door should not be replaced except by an authorized Kia dealer using original Kia parts designed for this vehicle and model. Any other such replacement or modification could adversely affect the operation of the occupant detection system and your advanced air bags.

⚠ WARNING

Modification

Modification to the seat structure can cause the air bag to deploy at a different level than should be provided.

Advanced air bags are combined with pre-tensioner seat belts to help provide enhanced occupant protection in frontal crashes. Front air bags are not intended to deploy in collisions in which sufficient protection can be provided by the seat belt.

*** NOTICE**

Air bags can only be used once - have an authorized Kia dealer replace the air bag immediately after deployment.

Front air bags are not intended to deploy in side-impact, rear-impact or

rollover crashes. However, when frontal deployment threshold is satisfied at side-impact, front air bags may deploy. In addition, front air bags will not deploy in frontal crashes below the deployment threshold.

⚠ WARNING

SRS Wiring

Do not tamper with or disconnect SRS wiring or other components of the SRS system. Doing so could result in injury, due to accidental deployment of the air bags or by rendering the SRS inoperative.

⚠ WARNING

No Attaching Objects

No objects (such as crash pad cover, cellular phone holder, cup holder, perfume or stickers) should be placed over or near the air bag modules on the steering wheel, instrument panel, windshield glass, and the front passenger's panel above the glove box. Such objects could cause harm if the vehicle is in a crash severe enough to cause the air bags to deploy.

Do not place any objects over the air bag or between the air bag and yourself.

Side air bag

Your vehicle is equipped with a side air bag in each front seat.





* The actual air bags in the vehicle may differ from the illustration.

The purpose of the air bag is to provide the vehicle's driver and/or the front passenger with additional protection than that offered by the seat belt alone.

- The side air bags are designed to deploy during certain side-impact collisions, depending on the crash severity of impact.
- The side air bags may deploy on the side of the impact or on both sides.
- The side and/or curtain air bags on both sides of the vehicle will deploy if a rollover or possible rollover is detected.
- The side air bags are not designed to deploy in all side impact or rollover situations.

⚠ WARNING

Unexpected Deployment

Avoid impact to the side impact airbag sensor when the EV button is ON to prevent unexpected deployment of the side air bag.

- The side air bag is supplemental to the driver's and the passenger's seat belt systems and is not a substitute for them. Therefore your seat belts must be worn at all times while the vehicle is in operation.
- For best protection from the side air bag system and to avoid being injured by the deploying side air bag, both

front seat occupants should sit in an upright position with the seat belt properly fastened. The driver's hands should be placed on the steering wheel at the 9:00 and 3:00 positions. The passenger's arms and hands should be placed on their laps.

⚠ WARNING

Deployment

Do not install any accessories including seat covers, on the side or near the side air bag, as this may adversely affect the deployment of the side air bags.

- If seat or seat cover is damaged, have the vehicle checked and repaired by an authorized Kia dealer. Inform the dealer that your vehicle is equipped with side air bags and an occupant detection system.

⚠ WARNING

Flying Objects

Do not place any objects (an umbrella, bag, etc.) between the front door and the front seat. Such objects may become dangerous projectiles if the side airbag inflates.

⚠ WARNING

No Attaching Objects

- Do not place any objects over the air bag or between the air bag and yourself. Also, do not attach any objects around the area in which the air bag inflates, such as the door, side door glass, front and rear pillar.
- Do not put any objects between the side airbag label and seat cushion. It could cause harm if the vehicle is in a crash severe enough to cause the air bags to deploy.

- Never place or insert any object into any small opening near the side air-bag labels attached to the vehicle seats. When the air bag deploys, the object may adversely affect the deployment and result in an unexpected accident or bodily harm.
- Do not install any accessories on the side or near the side air bags.

Curtain air bag

Curtain air bags are located along both sides of the roof rails above the front and rear doors.

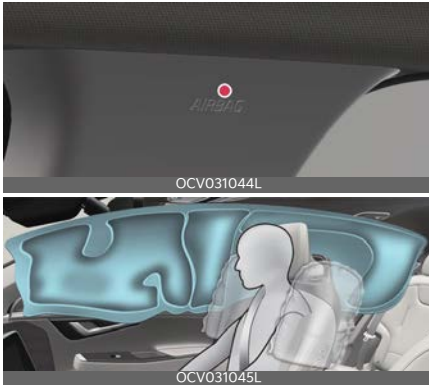

* The actual air bags in the vehicle may differ from the illustration.

They are designed to help protect occupants in certain side impacts and to help prevent them from ejecting out of the vehicle as a result of a rollover, especially when the seatbelts are also in use.

- The curtain air bags are designed to deploy during certain side impact collisions, depending on the severity of impact. However, when side deployment threshold is satisfied at front-impact, side air bags may deploy.
- The curtain air bags may deploy on the side of the impact or on both sides.

- Also, the curtain air bags on both sides of the vehicle will deploy in certain rollover situations.
- The curtain air bags are not designed to deploy in all side impact or rollover situations.

Do not allow the passengers to lean their heads or bodies against the doors, put their arms on the doors, stretch their arms out of the window or place objects between the doors and passengers when they are seated on seats equipped with side impact and/or curtain air bags.

* NOTICE

Never try to open or repair any components of the side and curtain air bag system. This should only be done by an authorized Kia dealer.

⚠ WARNING

No Attaching Objects

- Do not place any objects over the air bag. Also, do not attach any objects around the area in which the air bag inflates, such as the door, side door glass, front and rear pillar, roof side rail.
- Do not hang hard, breakable, or heavy objects on the coat hooks for safety reasons.

Air bag collision sensors

The air bag collision sensors are located in the following positions.



OCV031046N



* The actual shape and position of sensors may differ from the illustration.

- 1 Supplemental Restraint System (SRS) control module/rollover sensor
- 2 Front impact sensor
- 3 Side pressure sensors (front door)
- 4 Side impact sensor (B-pillar)
- 5 Side impact sensor (C-pillar)

WARNING**Air Bag Sensors**

- Do not hit or allow any objects to impact the locations where air bags or sensors are installed.

This may cause unexpected air bag deployment, which could result in serious personal injury or death.

- If the installation location or angle of the sensors is altered in any way, the air bags may deploy when they should not or they may not deploy when they should.

Therefore, do not try to perform maintenance on or around the air bag sensors. Have the vehicle checked and repaired by an authorized Kia dealer.

Problems may arise if the sensor installation angles are changed due to the deformation of the front bumper, front end module, body or front doors where side collision sensors are installed. Have the vehicle checked and repaired by an authorized Kia dealer.

Installing bumper guards (or side step or running board) or replacing a bumper (or front door module) with non-genuine parts may adversely affect your vehicle's collision and air bag deployment performance. Kia Genuine bumper guards/bumpers are parts we guarantee for quality and performance.

Why didn't my air bag go off in a collision? (Inflation and non-inflation conditions of the air bag)

There are many types of accidents in which the air bag would not be expected to provide additional protection.

These include rear impacts, second or third collisions in multiple impact accidents, as well as low speed impacts.

Air bag inflation conditions**Front air bags**

Front air bags are designed to inflate in a frontal collision depending on several factors, including the severity of impact of the front collision.

Side and/or curtain air bags

Side and/or curtain air bags are designed to inflate when an impact is detected by side collision sensors depending on the severity of impact resulting from a side impact collision.

Also, the side and curtain air bags are designed to inflate when a rollover is detected by a rollover sensor.

Although the front air bags (driver's and front passenger's air bags) are primarily designed to inflate in frontal collisions, they may inflate in other types of collisions if the front impact sensors detect a

Safety features of your vehicle

sufficient frontal force in another type of impact.

Similarly, although side and curtain air bags are designed to inflate in certain side impact collisions, they may inflate in other types of collisions where a side force is detected by the sensors. For instance, side air bag and/or curtain air bags may inflate if rollover sensors indicate the possibility of a rollover occurring (even if none actually occurs) or in other situations, including when the vehicle is tilted while being towed.

Even if side and/or curtain air bags do not provide impact protection in a roll-over, they will deploy to prevent ejection of occupants, especially those who are restrained with seat belts.

If the vehicle chassis is impacted by bumps or objects on unimproved roads, the air bags may deploy. Drive carefully on unimproved roads or on surfaces not designed for vehicle traffic to prevent unintended air bag deployment.

Air bag non-inflation conditions

- In certain low-speed collisions the air bags may not deploy. The air bags are designed not to deploy in such cases because they may not provide benefits beyond the protection of the seat belts in such collisions.



- Air bags are not designed to inflate in rear collisions, because occupants are moved backward by the force of the impact. In this case, inflated air bags

Air bag - advanced supplemental restraint system

would not be able to provide any additional benefit.



- Front air bags may not inflate in side impact collisions, because occupants move to the direction of the collision, and thus in side impacts, frontal air bag deployment would not provide additional occupant protection.



- In an angled collision, the force of impact may direct the occupants in a direction where the air bags would not be able to provide any additional benefit, and thus the sensors may not deploy any air bags.



- Just before impact, drivers often brake heavily. Such heavy braking lowers the front portion of the vehicle causing it to "ride" under a vehicle with a higher ground clearance. Air bags may not inflate in this "under-ride" situation because deceleration forces that are detected by sensors

may be significantly reduced by such "under-ride" collisions.



- Front air bags may not inflate in all rollover accidents when the SRSCM indicates that the front air bag deployment would not provide additional occupant protection.



- Air bags may not inflate if the vehicle collides with objects such as utility poles or trees, where the point of impact is concentrated to one area and the full force of the impact is not delivered to the sensors.



Supplemental Restraint System (SRS) care

The SRS is virtually maintenance-free and so there are no parts you can safely service by yourself.

If the SRS air bag warning light does not appear, or continuously remains on, have your vehicle immediately inspected by an authorized Kia dealer.

Any work on the SRS system, such as removing, installing, repairing, or any work on the steering wheel, the front passenger's panel, front seats and roof rails must be performed by an authorized Kia dealer. Improper handling of the SRS system may result in serious personal injury.

For cleaning the air bag pad covers, use only a soft, dry cloth or one which has been moistened with plain water. Solvents or cleaners could adversely affect the air bag covers and proper deployment of the system.

If components of the air bag system must be discarded, or if the vehicle must be scrapped, certain safety precautions must be observed. An authorized Kia dealer knows these precautions and can give you the necessary information. Failure to follow these precautions and procedures could increase the risk of personal injury.

⚠ WARNING

Tampering with SRS

Do not tamper with or disconnect SRS wiring, or other components of the SRS system. Doing so could result in the accidental inflation of the air bags or render the SRS inoperative.

⚠ WARNING

Towing Vehicle

Always have the vehicle in OFF position when your vehicle is being towed. The side air bags may inflate if the vehicle is tilted, such as when being towed, because of the rollover sensors in the vehicle.

Adding equipment to or modifying your air bag-equipped vehicle

If you modify your vehicle by changing your vehicle's frame, bumper system, front end or side sheet metal or ride height, this may affect the operation of your vehicle's air bag system.

Air bag warning label

Air bag warning labels, some required by the Canada Motor Vehicle Safety Standards (CMVSS), are attached to the sun visor to alert the driver and passengers of potential risks of the air bag system.



Features of your vehicle **5**

Keys	5-6
• Smart key.....	5-7
• Immobilizer system.....	5-12
• Theft-alarm system.....	5-13
Door locks	5-15
• Operating door unlocks from outside the vehicle.....	5-15
• Operating door locks from outside the vehicle.....	5-16
• Operating door locks from inside the vehicle.....	5-18
• In case of an emergency.....	5-19
• Door lock/unlock features.....	5-20
• Child-protector rear door lock.....	5-21
• Electronic child safety lock.....	5-21
• Rear Occupant Alert (ROA).....	5-22
Driver Position Memory System	5-23
• Storing memory positions.....	5-23
• Recalling memory positions.....	5-24
• Resetting memory positions.....	5-24
• Seat easy access.....	5-25
Liftgate	5-25
• Opening the liftgate.....	5-25
• Closing the liftgate.....	5-26
• Emergency liftgate safety release.....	5-26
Power liftgate	5-27
• Operating the power liftgate.....	5-28
• Setting the power liftgate.....	5-29
• Resetting the power liftgate.....	5-30
• Emergency liftgate safety release.....	5-31
Smart Liftgate with Auto Open	5-31
• Using smart liftgate.....	5-32
• Deactivating smart liftgate.....	5-33
• Detecting area.....	5-33

5 Features of your vehicle

Windows	5-35
• Window opening and closing	5-36
• Power window lock button	5-37
• Remote window opening.....	5-38
Hood	5-39
• Opening the hood.....	5-39
• Closing the hood	5-40
• Hood open warning	5-40
Front trunk	5-41
• Opening the front trunk.....	5-41
• Closing the front trunk	5-41
Charging door	5-42
• Opening and closing the charging door	5-42
Wide sunroof	5-43
• Power sunshade.....	5-44
• Tilt open/close	5-44
• Slide open/close	5-44
• Automatic reversal	5-45
• Resetting the sunroof.....	5-45
• Sunroof open warning.....	5-46
Steering wheel	5-47
• Electric Power Steering (EPS).....	5-47
• Tilt and telescopic steering wheel	5-48
• Heated steering wheel.....	5-48
• Horn.....	5-49
Mirrors	5-49
• Inside rear view mirror.....	5-49
• Outside rear view mirror.....	5-58
Instrument cluster	5-61
• Instrument panel illumination control.....	5-62

Features of your vehicle **5**

• Gauges.....	5-62
LCD display.....	5-65
• LCD display control.....	5-65
• LCD display modes.....	5-65
• LCD display messages.....	5-70
Warning and indicator lights	5-75
• Warning lights.....	5-75
• Indicator lights.....	5-80
Augmented Reality HUD	5-83
• Head-up display settings.....	5-83
• Head-up display information.....	5-84
• Precautions while using the head-up display	5-84
Lighting.....	5-86
• Battery saver function.....	5-86
• Headlight escort function.....	5-86
• Daytime running light (DRL)	5-86
• Lighting control.....	5-87
• Operating high beam	5-88
• Operating turn signals and lane change signals	5-88
• One-touch lane change function.....	5-89
• High Beam Assist (HBA).....	5-89
Wipers and washers	5-92
• Auto control.....	5-92
• Operating windshield washer	5-93
Interior lights.....	5-94
• Automatic turn off function.....	5-94
• Room lamp.....	5-94
• Map lamp.....	5-94
• Liftgate room lamp.....	5-95
• Vanity mirror lamp	5-95
• Glove box lamp.....	5-95

5 Features of your vehicle

• Charging inlet lamp	5-95
Welcome system	5-96
Defroster	5-97
• Operating rear window defroster	5-97
• Outside mirror defroster	5-97
Automatic climate control system	5-98
• Using the infotainment/climate switchable controller	5-99
• Heating and air conditioning automatically	5-99
• Heating and air conditioning manually	5-101
• System operation	5-105
• Climate control air filter	5-107
• Checking the amount of air conditioner refrigerant and compressor lubricant	5-107
Windshield defrosting and defogging	5-108
• Defrosting outside windshield with automatic climate control	5-109
• Defogging inside windshield with automatic climate control	5-109
• Defogging logic	5-109
• Auto Defogging System (ADS)	5-110
• Automatic ventilation	5-110
• Smart ventilation	5-110
• A/C Automatic Drying	5-111
Storage compartment	5-112
• Center console storage	5-112
• Glove box	5-112
• Luggage board	5-112
Interior features	5-113
• Ambient light	5-113
• Cup holder	5-113
• Seat warmer	5-113
• Air ventilation seat	5-114

Features of your vehicle **5**

• Sun visor.....	5-115
• Power outlet	5-115
• USB charger	5-116
• Wireless smart phone charging system.....	5-117
• Coat hook	5-119
• Floor mat anchor(s).....	5-120
• Luggage net holder.....	5-120
• Cargo security screen	5-121
Audio system.....	5-121
• Sharkfin antenna.....	5-121
• USB port	5-121
• Using the infotainment/climate switchable controller.....	5-122
• How vehicle radio works.....	5-122
Declaration of Conformity	5-125
• IC.....	5-125

Features of your vehicle

Keys

The mechanical key and various remote functions are integrated into the smart key to provide convenience to the driver.

Battery replacement

A smart key battery should last for several years, but if the smart key is not working properly, try replacing the battery with a new one.



If you are unsure how to use your smart key or replace the battery, contact an authorized Kia dealer.

1. Remove the mechanical key.
2. Pry open the rear cover.
3. Replace the battery with a new battery (CR2032). When replacing the battery, make sure the battery is in the correct position.
4. Install the battery in the reverse order of removal.

The smart key is designed to give you years of trouble-free use, however it can malfunction if exposed to moisture or static electricity. If you are unsure how to use or replace the battery, contact an authorized Kia dealer.

Using the wrong battery can cause the smart key to malfunction. Be sure to use the correct battery.

To avoid damaging the smart key, don't drop it, get it wet, or expose it to heat or sunlight.



An inappropriately disposed battery can be harmful to the environment and human health. Dispose the battery according to your local law(s) or regulations.

WARNING

THIS PRODUCT CONTAINS A BUT-TON BATTERY

If swallowed, a lithium button battery can cause severe or fatal injuries within 2 hours.

Keep batteries out of reach of children.

If you think batteries may have been swallowed or placed inside any part of the body, seek immediate medical attention.

WARNING

Do not leave the smart key in your vehicle with unsupervised children. Unattended children could press the EV button and may operate power windows or other controls, or even make the vehicle move, which could result in serious injury or death.

Record your key number

The key code number is stamped on the bar code tag attached to the key set. Should you lose your keys, this number will enable an authorized Kia dealer to duplicate the keys easily. Remove the bar code tag and store it in a safe place. Also, record the code number and keep it in a safe and handy place, but not in the vehicle.

⚠ WARNING**Aftermarket Keys**

Use only Kia original parts for the key in your vehicle. If an aftermarket key is used, the EV button may not return to ON after START. If this happens, the vehicle will continue to operate causing possible fire due to excessive current in the wiring.

Smart key

With a smart key, you can lock or unlock a door and even start the vehicle without inserting the key.



OCV041003_2

- 1 Door lock
- 2 Door unlock
- 3 Liftgate unlock/open
- 4 Panic alarm
- 5 Remote start
- 6 Remote Start Parking Assist (Forward)
- 7 Remote Start Parking Assist (Backward)

Locking (1)**Manual type**

OCV041583L

To lock your vehicle using the door handle touch sensor or the smart key:

1. Make sure all doors, the hood and the liftgate are closed.
2. Press the door lock button (1) on the smart key. The hazard warning lights will blink with an alarm, and the doors will be locked.
3. In addition, pushing the button on the door handle (the engraved part) while holding the smart key will lock all doors.

5

Electric type (if equipped)

OCV041085L

To lock your vehicle using the door handle touch sensor or the smart key:

1. Make sure all doors, the hood and the liftgate are closed.
2. Press the door lock button (1) on the smart key. The hazard warning lights will blink with an alarm, and the handles will retract back.
3. In addition, touching the touch sensor on the door handle (the engraved part) while keeping the smart key will

lock all doors and let the door handle to retract back.

*** NOTICE**

- The outside rearview mirrors will fold if **Enable on Door Unlock** is selected from the Settings menu in the infotainment system screen.
Select **Setup** → **Vehicle** → **Convenience** → **Welcome Mirror** → **Enable on Door Unlock**
- The door handle touch sensor will only operate when the smart key is within 0.7~1 m (28~40 inches) from the outside door handle.
- Touching the door handle touch sensor does not unlock the doors. To unlock the doors, refer to the following page.
- Note that you cannot lock your vehicle using the door handle touch sensor if any of the following occur:
 - The smart key is in the vehicle.
 - The EV button is in ACC or ON position.
 - Any of the doors are open except for the liftgate.

*** NOTICE**

- To fold/unfold the outside rearview mirrors simultaneously when the door is locked/unlocked, select **Setup** → **Vehicle** → **Convenience** → **Welcome Mirror** → **Enable on Door Unlock** in the infotainment system screen.
- The door handle button will only operate when the smart key is within 0.7~1 m (28~40 inches) from the outside door handle. Other people can also open the doors without the smart key in possession.

- After unlocking the doors, the doors will lock automatically after 30 seconds unless a door is opened.
For detailed information, refer to the separately supplied infotainment system manual.
- If the smart key is not moved for some time, the detection function for smart key operation will pause. Lift the smart key to activate the detection again.

Unlocking (2)

Manual type



To unlock your vehicle using the door handle button or the smart key:

1. Make sure you have the smart key in your possession.
2. Pushing the button on the door handle (engraved part) or press the door unlock button (2) on the smart key. All doors handles will be unlocked and the hazard warning lights will blink twice.
3. After unlocking the doors, the doors will automatically re-lock after 30 seconds unless a door is opened.

Electric type (if equipped)



When you release the Two Press Unlock function

To unlock your vehicle using the door handle touch sensor or the smart key:

1. Make sure you have the smart key in your possession.
2. Touch the touch sensor on the door handle (engraved part) or press the door unlock button (2) on the smart key. All door handles will pop out and the doors will be unlocked and the hazard warning lights will blink and the chime will sound.
3. After unlocking the doors, the doors will automatically re-lock after 30 seconds unless a door is opened.

When you set the Two Press Unlock function

1. Make sure you have the smart key in your possession.
2. Touch the touch sensor on the door handle (engraved part) or press the door unlock button (2) on the smart key. The driver's door handle will pop out and the driver's door will be unlocked.
3. Touch the touch sensor on the door handle (engraved part) or press the door unlock button (2) on the smart key within 4 seconds again. All door handles will pop out and the doors will be unlocked and the hazard warning

lights will blink twice and the chime will sound.

4. After unlocking the doors, the doors will automatically relock after 30 seconds unless a door is opened.

Two Press Unlock Feature

The priority for unlocking the driver door only, or unlocking all the doors with one press may be adjusted in the infotainment system screen.

The Two Press Unlock feature, when enabled, will require the user to press the door unlock button once for driver door only and twice for unlocking all the doors.

Select or deselect the Two Press Unlock Feature in the infotainment system. The option can be found under the following menu:

Setup → Vehicle → Door → Two Press Unlock

The Two Press Unlock Feature can also be enabled or disabled by pressing the door lock and unlock buttons simultaneously on the key fob:

- Press and hold both the door lock button (1) and the door unlock button (2) simultaneously until the hazard warning lights blink.
- This will enable or disable the Two Press Unlock feature. Repeat this procedure to enable/disable the mode again.

* NOTICE

- The outside rearview mirrors will unfold if **Enable on Door Unlock** is selected from the Settings menu in the infotainment system screen. Select **Setup → Vehicle → Convenience → Welcome Mirror → Enable on Door Unlock**

- The door handle touch sensor will only operate when the smart key is within 0.7~1 m (28~40 inches) from the outside door handle.
- The doors may lock or unlock if the touch sensor of the outer door handle is recognized while washing your car or due to heavy rain.
- To prevent unintentional door lock or unlock:
 - Press the lock button on the smart key and immediately press the unlock button along with the lock button for more than 4 seconds. The hazard warning lights will blink four times. At this time, the doors will not lock or unlock even though the touch sensor is touched on the outside door handle. To deactivate the function, press the door lock or unlock button on the smart key.
- The doors may not lock or unlock in the following situations.
 - If the touch sensor is touched with gloves on
 - If the door is suddenly approached

Liftgate open (3)

To open:

1. Make sure you have the smart key in your possession.
2. Pressing the button (3) on the smart key will only unlock the liftgate.
3. Once the liftgate is opened and then closed, the liftgate will lock automatically.

* NOTICE

The liftgate unlock will only operate when the smart key is within 28~40 inches (0.7~1 m) from the liftgate.

Panic alarm (4)

1. Press the panic button (4) for more than 1 second.
2. The horn sounds and hazard warning light flash for about 27 seconds.

To stop the horn and lights, press any button on the smart key.

Remote start (5)

You can start the vehicle using the remote start button (5) of the smart key.

To start the vehicle remotely:

- Lock the doors by pressing the door lock button (1) within 10 m (32 feet) distance from the vehicle.
- Press the remote start button (5) for over 2 seconds within 4 seconds after locking the doors.

Press the remote start button (5) once to turn off the vehicle. Air conditioner/heater system maintains the status before turning off the vehicle. If no further action for operating/driving the vehicle is taken, the vehicle will be turned off 10 minutes after starting the vehicle remotely.

* NOTICE

- Laws in your country may restrict the use of remote start. You should check country regulations before using this remote starting system.
- It is only possible to start the vehicle remotely when shifted to P (Park).
- If the hood or the liftgate is opened, you cannot start the vehicle remotely.

Remote Smart Parking Assist (RSPA) (6, 7) (if equipped)

The Remote Smart Parking Assist (RSPA) helps the drivers park their vehicle by using sensors to measure parking spaces and control the steering wheel,

gear shift and vehicle speed to semi-automatically park the vehicle.

With the smart key, the driver can move the vehicle forward or backward using the forward/backward buttons (6, 7) on the smart key.

For more information, refer to "Remote Smart Parking Assist (RSPA) (if equipped)" on page 7-126.

Mechanical key

If the smart key does not operate normally, you can lock or unlock the driver's door by using the mechanical key.

To remove the mechanical key, press and hold the release button (1) and remove the mechanical key (2).



To reinstall the mechanical key, put the key into the hole and push it until a click sound is heard.

With a smart key, you can lock or unlock a door (and liftgate) and start the vehicle.

Loss of the smart key

A maximum of 2 smart keys can be registered to a single vehicle.

If you happen to lose your smart key, you will not be able to start the vehicle. You should immediately take the vehicle and remaining key to your authorized Kia dealer (tow the vehicle, if necessary) to protect it from potential theft.

Smart key precautions

The smart key will not work if any of the following occur:

- The smart key is close to a radio transmitter such as a radio station or an airport which can interfere with normal operation of the smart key.
- The smart key is near a mobile two way radio system or a cellular phone.
- Another vehicle's smart key is being operated close to your vehicle.

When the smart key does not work correctly, open and close the door with the mechanical key and contact an authorized Kia dealer.

If the smart key is in close proximity to your cell phone or smart phone, the signal from the smart key could be blocked by normal operation of your cell phone or smart phone. This is especially important when the phone is active such as making calls, receiving calls, text messaging, and/or sending/receiving emails. Avoid placing the smart key and your cell phone or smart phone in the same pants or jacket pocket and maintain adequate distance between the two devices.

⚠ CAUTION

Smart Key

Keep the smart key away from water or any liquid, as it can become damaged and not function properly if wet.

* NOTICE

If the smart key is inoperative due to exposure to water or liquids, it will not be covered by your manufacturer's vehicle warranty.

* INFORMATION

If the smart key is not moved for some time, the detection function for smart key operation will pause. Lift the smart key to activate the detection again.

⚠ CAUTION

Smart Key Damage

Do not drop, get wet or expose the smart key to heat or sunlight, or it will be damaged.

⚠ WARNING

IC WARNING

This device complies with Industry Canada licence-exempt RSS standard(s).

1. This device may not cause interference, and
2. This device must accept any interference, including interference that may cause undesired operation of the device.

Immobilizer system

The immobilizer system protects your vehicle from theft. If an improperly coded key (or other device) is used, the vehicle's power system is disabled.

When the EV button is placed in the ON position, the immobilizer system indicator should come on briefly, then go off. If the indicator starts to blink, the system does not recognize the coding of the key.

Place the EV button to the OFF position, then place the EV button to the ON position again.

In some circumstances, the vehicle may not recognize your smart key if another smart key device is nearby or a metal

object such as a key chain is causing interference with the smart key.

If this occurs, your vehicle may not start. Remove any metal objects or additional keys near the smart key before attempting to start the vehicle again.

If the system repeatedly does not recognize the coding of the key, it is recommended that you contact your Kia dealer.

Do not attempt to alter this system or add other devices to it. Electrical problems could result that may make your vehicle inoperable.

* NOTICE

When starting the vehicle, do not use the key with other immobilizer keys around. Otherwise the vehicle may not start or may stop soon after it starts. Keep each key separate in order to avoid a starting malfunction.

⚠ WARNING

In order to prevent theft of your vehicle, do not leave spare keys anywhere in your vehicle. Your immobilizer password is a customer unique password and should be kept confidential.

This device complies with Industry Canada licence-exempt RSS standard(s).

Operation is subject to the following conditions:

1. This device may not cause interference, and
2. This device must accept any interference, including interference that may cause undesired operation of the device.

- Changes or modifications not expressly approved by the party responsible for compliance could void the user's authority to operate the device.

*** NOTICE**

Changes or modifications not expressly approved by the party responsible for compliance could void the user's authority to operate the equipment. If the smart key is inoperative due to changes or modifications not expressly approved by the party responsible for compliance, it will not be covered by your manufacturer's vehicle warranty.

Theft-alarm system

This system is designed to provide protection from unauthorized entry into the vehicle.

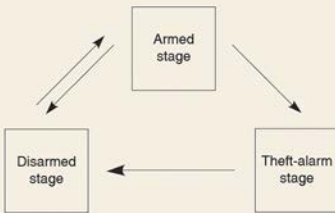

OGL3041503L

This system is operated in three stages: the first is the "Armed" stage, the second is the "Theft-alarm" stage, and the third is the "Disarmed" stage. If triggered, the system provides an audible alarm with blinking of the hazard warning lights.

Armed stage

Park and stop the vehicle. Arm the system as described below.

Entering the armed stage using the smart key

- Place the EV button in the OFF position.
- Make sure that all doors, the hood and liftgate are closed and latched.
- Lock the doors by pressing the button of the front outside door handle with the smart key in your possession.

After completion of the steps above, the hazard warning lights will operate once to indicate that the system is armed.

If any door (or liftgate) or hood remains open, the hazard warning lights and the chime will not operate and the theft-alarm will not arm. If all doors and liftgate and hood are closed after the lock button is pressed, the hazard warning lights blink once.

The system can also be armed by locking the doors with the key from the front doors; however, the hazard warning lights will not blink using this method.

- Lock the doors by pressing the lock button on the smart key.

After completion of the steps above, the hazard warning lights will operate once to indicate that the system is armed.

*** NOTICE**

Do not arm the system until all passengers have left the vehicle. If the system is armed while a passenger(s) remains in the vehicle, the alarm may be activated when the remaining passenger(s) leaves

the vehicle. If any door (or liftgate) or hood is opened within 30 seconds after the system enters the armed stage, the system will be disarmed to prevent unnecessary alarm.

Theft-alarm stage

The alarm will be activated if any of the following occurs while the system is armed.

- A front or rear door is opened without using the smart key.
- The liftgate is opened without using the smart key.
- The hood is opened.

The horn will sound and the hazard warning lights will blink continuously for approximately 27 seconds, and repeat the horn 3 times unless the system is disarmed. To turn off the system, unlock the doors with the smart key.

Disarmed stage

The system will be disarmed when:

- The doors (and liftgate) are unlocked with the smart key.

After pressing the unlock button, the hazard warning lights will blink and the chime will sound twice (in smart key) to indicate that the system is disarmed.

After pressing the unlock button, if any door (or liftgate) is not opened within 30 seconds, the system will be rearmed.

* NOTICE

- Avoid trying to start the vehicle while the alarm is activated. The vehicle starting motor is disabled during the theft-alarm stage.

If the system is not disarmed with the smart key, open the doors by using the mechanical key and start the vehi-

cle by directly pressing the EV button with the smart key.

- If you lose your keys, consult your authorized Kia dealer.

⚠ CAUTION

Adjusting Alarm System

Do not change, alter or adjust the theft alarm system in your vehicle. Improper installation of the alarm system could damage the vehicle or cause the system to malfunction.

* NOTICE

Malfunctions caused by improper alterations, adjustments or modifications to the theft-alarm system are not covered by your vehicle manufacturer warranty.

This device complies with Industry Canada licence-exempt RSS standard(s).

Operation is subject to the following two conditions:

1. This device may not cause interference, and
2. This device must accept any interference, including interference that may cause undesired operation of the device.

* NOTICE

Changes or modifications not expressly approved by the party responsible for compliance could void the user's authority to operate the equipment. If the smart key is inoperative due to changes or modifications not expressly approved by the party responsible for compliance, it will not be covered by your manufacturer's vehicle warranty.

Door locks

Know how to use the door lock so that you can lock or unlock the door if necessary.

Operating door unlocks from outside the vehicle

Manual type

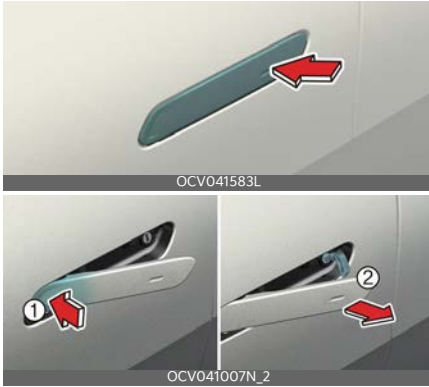

Push the button on the front outside door handle (the engraved part) while carrying the Smart Key with you, all doors will unlock.

The hazard warning lights will blink twice and chime also sounds twice. Once the doors are unlocked, when press the front of the door handle (1) then rear of the door handle will pop out (2).

Pull the outside door handle to open the door.

Electric type (if equipped)

Approach Unlock system

The outside door handle will slide out and the doors will unlock when the driver approaches the vehicle possessing the smart key.

The driver can activate/deactivate the **Approach Unlock** system on the infotainment screen.

To activate Approach unlock system for only the driver's seat, select **Setup** → **Vehicle** → **Door** → **Remote Power Door Open** → **Unlock All Doors** in the infotainment system screen.

To activate Approach unlock system, select **Setup** → **Vehicle** → **Door** → **Activate Approach Unlock** in the infotainment system. The outside door handle will slide out and the door will unlock when the driver approaches the vehicle possessing the smart key. If Approaching unlock system is deactivated, the door handle will not slide out even when the driver approaches to the vehicle with the smart key. To unlock doors when Approach unlock system is deactivated, touch the lock/unlock sensor (engraved part) on the handle.

When the Approach unlock is activated

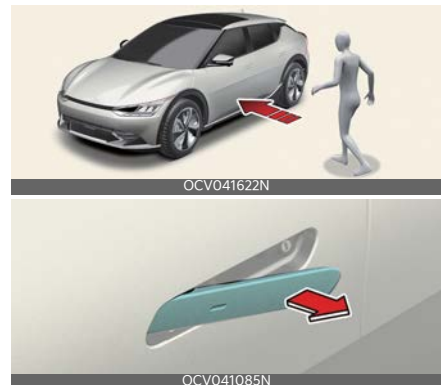

If you approach (within 30 cm (1 ft.)) the driver or front passenger's door handle possessing the smart key, the outside door handles slide out and the doors are unlocked. In this case, Hazard Warning

Flasher blinks twice and chime also sounds twice.

After first approach, the vehicle tries detecting the smart key every 5 seconds and if the key is not detected, the doors will lock automatically and the handles will slide in.

When the Approach unlock is deactivated

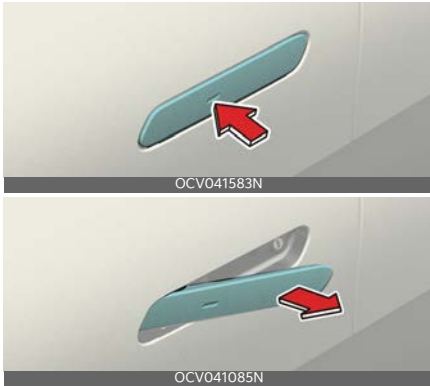

The handle does not slide out even when you approach with the smart key in possession. The doors are unlocked if you press the outside handle as the handles slide out.

The doors will lock automatically and the handles will slide in after 30 seconds unless a door is opened.

* NOTICE

In emergency situations, such as battery is dead, the outside electric door handle can still be operated in a way that the manual type outside manual door handle operate.

Operating door locks from outside the vehicle

Manual type



Push the button on the front outside door handle (the engraved part) while carrying the smart key with you, all doors will lock.

The hazard warning lights will blink and chime also sounds once.

Push the door to close.

Electric type (if equipped)

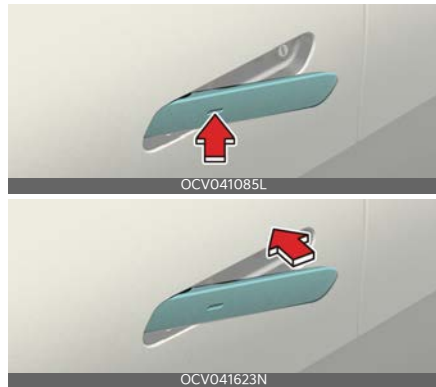

When all doors are closed, touch the touch sensor on the front outside door handle (the engraved part) while carrying the smart key with you, outside door handle will return and doors will be locked.

The hazard warning lights will blink and chime also sounds once.

* NOTICE

- If the door is locked/unlocked multiple times in rapid succession with the smart key, door lock button or door lock switch, the system may stop operating temporarily in order to protect the circuit. Also, the **Approach Unlock** system may not operate. Try operation after a sufficient time in case the system does not operate due to multiple operations.
- **Approach Unlock** system is not operated continuously. Retry after a certain period of time when all the doors are closed.

* NOTICE

- In cold and wet climates, door lock and door mechanisms may not work properly due to freezing conditions.
- If the door is locked/unlocked multiple times in rapid succession with either the vehicle key or door lock switch, the system may stop operating temporarily in order to protect the circuit and prevent damage to system components.
- When washing the vehicle
 - Self car wash
Keep the door locked with the outside door handle closed.
To keep the door unlocked, push back the outside door handle by hand. This function prevents the door handle from being damaged, and the door handle pops out again when the unlock button is pressed.
 - Auto car wash
Keep the door locked with the outside door handle closed.
If the smart key is not in the vehicle, turn off the vehicle and keep the

smart key away at least 2 m (78 inches) from the vehicle to prevent the outside door handle operates.

Mechanical key



Press the front part (1) of the door handle to pull out the rear part of the door handle. While keep pressing the front part of the door handle, insert the mechanical key (2) to the lock with the key handle facing the ground as shown. To lock the door, turn the key toward the front (left side) of the vehicle. To unlock, turn the key toward the rear (right side) of the vehicle.

⚠ CAUTION

Do not apply excessive force on the door and door handle. It may damage the door and door handle.

* NOTICE

The mechanical key only locks/unlocks the driver's door handle. For more details, refer to 'In case of an emergency' in this chapter.

How to remove ice from door handles

In extreme winter conditions, the door handle may not open due to icing inside the door handle. You can usually use the bottom of your fist to tap the door handle a few times to remove the ice.

1. Remove icing by tapping the door handle using the bottom of your fist in a circular pattern along the perimeter of the door handle.



2. If necessary, increase the intensity of tapping to remove ice, and repeat until the door handle protrudes when unlocking the door.
3. When the door handle protrudes and can be pulled, open and close a few times to remove any icing residue.

⚠ CAUTION

- Before performing this procedure, remove any jewelry or objects that could damage the paintwork and do not attempt to use tools or excessive force.
- Do not hit the vehicle too hard as dents may occur. You should use a force similar to knocking on your neighbor's door.

Operating door locks from inside the vehicle

With the door handle



Front door

If the inner door handle is pulled when the door is locked, the door will unlock and open.

Rear door

If the inner door handle is pulled once when the door is locked, the door will unlock. If the inner door handle is pulled once more, the door will open.

*** NOTICE**

Door Lock Malfunction

If a power door lock ever fails to function while you are in the vehicle, try one or more of the following techniques to exit:

- Operate the door unlock feature repeatedly (both electronic and manual) while simultaneously pulling on the door handle.
- Operate the other door locks and handles, front and rear.
- Lower a front window and use the key to unlock the door from outside.

⚠ WARNING

Do not pull the inner door handle of driver's (or passenger's) door while the vehicle is moving.

With the central door lock switch

Driver side



Passenger side



Operate by pressing the central door lock switch.

- To lock all vehicle doors, press the central door lock switch (1) of driver and passenger side.
- To unlock all vehicle doors, press central door unlock switch (2) of driver and passenger side.
- When all vehicle doors are locked, the indicating lights (3) on the driver's door and passenger's door will turn on. If any door is unlocked, it will go off.
- Any door is opened, the doors will not lock even though the central door lock switch is pressed.

⚠ WARNING

Doors

- The doors should always be fully closed and locked while the vehicle is in motion to prevent accidental opening of the door.
- Be careful when opening doors and watch out for vehicles, motorcycles, bicycles or pedestrians approaching

the vehicle in the path of the door. Opening a door when something is approaching can result in an accident to cause vehicle damage or serious injury.

⚠ WARNING

Unattended children, the elderly or pets

An enclosed vehicle can become extremely hot, causing death or severe injury such as heatstroke to unattended children, the elderly or pets who cannot escape the vehicle. When left or trapped in a hot vehicle, make sure to stay hydrated and avoid sun exposure through the vehicle's windshield. Furthermore, children might operate features of the vehicle that could injure them, or they could encounter other harm, possibly from someone gaining entry to the vehicle. Never leave children or animals unattended in your vehicle.

In case of an emergency



In case of emergency such as when the battery is discharged, the only way to lock the door(s) is with the mechanical key from the outside key hole. Doors without an outside key hole can be locked as follows:

1. Open the door.
2. Insert the key into the emergency door lock hole and turn the key to the lock position.
3. Close the door securely.

⚠ WARNING

- The doors should always be fully closed and locked while the vehicle is in motion. If the doors are unlocked, the risk of being thrown from the vehicle in a crash is increased.
- Do not pull the inner door handle of the driver's or passenger's door while the vehicle is moving.

⚠ WARNING

Do not leave children or animals unattended in your vehicle. An enclosed vehicle can become extremely hot, causing death or serious injury to unattended children or animals who cannot escape the vehicle. Children might operate features of the vehicle that could injure them, or they could encounter other harm, possibly from someone gaining entry to the vehicle.

⚠ WARNING

Always secure your vehicle. Leaving your vehicle unlocked increases the potential risk to you or others from someone hiding in your vehicle. To secure your vehicle, while depressing the brake, shift the gear to the P (Park) position, engage the parking brake, and press the EV button to the OFF position, close all windows, lock all doors, and always take the key with you.

⚠ WARNING

If you stay in the vehicle for a long time while the weather is very hot or cold, there are risks of injuries or danger to life. Do not lock the vehicle from the outside when someone is in the vehicle.

⚠ CAUTION

Opening a door when something is approaching may cause damage or injury. Be careful when opening doors and watch for vehicles, motorcycles, bicycles or pedestrians approaching the vehicle in the path of the door.

*** NOTICE**

If the electrical power door lock switch does not operate (ex. dead car battery) and the liftgate is closed, you will not be able to open the liftgate until power is restored.

Door lock/unlock features

Your vehicle is equipped with features that will automatically lock or unlock your vehicle based on settings you select in the infotainment system screen. For detailed information, refer to the separately supplied infotainment system manual.

Auto LOCK Enable on speed

When this feature is set in the infotainment system screen, all the doors will be locked automatically when the vehicle exceeds 15 km/h (9 mph).

You can activate or deactivate the auto door lock/unlock features in the vehicle. Refer to "Vehicle settings (infotainment system)" on page 5-69.

Auto LOCK Enable on shift

When this feature is set in the infotainment system screen, all the doors will be locked automatically when the vehicle is shifted out of P (Park) while the vehicle is ON.

Auto UNLOCK On Shift to P

When this feature is set in the infotainment system screen, all the doors will be unlocked automatically when the vehicle is shifted back into P (Park) while the vehicle is ON.

Auto UNLOCK Vehicle off

When this feature is set in the infotainment system screen, all the doors will be unlocked automatically when the vehicle is turned off.

Additional unlock safety feature air bag deployment

As an additional safety feature, all doors will be automatically unlocked when an impact causes the air bags to deploy.

Impact sensing door unlock system

All doors will automatically unlock when an impact causes the air bags to deploy.

Child-protector rear door lock (if equipped)

The child safety lock is provided to help prevent children from accidentally opening the rear doors from inside the vehicle. The rear door safety locks should be used whenever children are in the vehicle.

The child safety lock is located on the edge of each rear door. When the child safety lock is in the lock position (1), the rear door will not open if the inner door handle (2) is pulled.

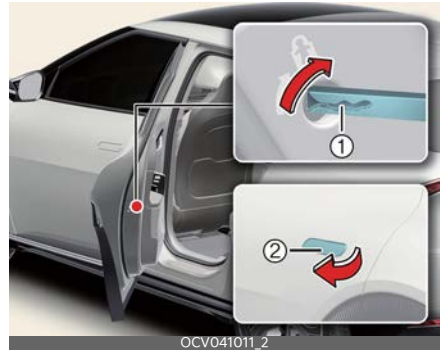

To lock the child safety lock, insert a key (or screwdriver) into the hole and turn it to the lock position.

To allow a rear door to be opened from inside the vehicle, unlock the child safety lock.

⚠ WARNING

Rear Door Locks

Use the rear door safety locks whenever children are in the vehicle. If a child accidentally opens the rear doors while the vehicle is moving, he or she may fall out.

Electronic child safety lock (if equipped)



If you push the electronic child safety lock switch and the indicator appears, rear passengers cannot open the rear door from inside the vehicle.

To cancel the electronic child safety lock, push the electronic child safety lock switch one more time and then the indicator turns off.

Safe Exit Assist is operated when the electronic child safety lock is activated and Safe Exit Assist is selected in the cluster. However, Safe Exit Assist does not automatically activate the electronic child safety lock system.

The electronic child safety lock is always on when the EV button is in the ON for approximately 3 minutes.

⚠ WARNING

If children accidentally opens the rear door while the vehicle is in motion, they could fall out of the vehicle. Electronic child safety lock should always be used whenever children are in the vehicle.

*** NOTICE**

If the Electronic child safety lock is not operated when pushing the Electronic child safety lock switch, the message is displayed and the alarm will sound.



A: Child safety lock failure

If this occurs, have the function checked by an authorized Kia dealer.

*** NOTICE**

If your vehicle is equipped with the Electronic child safety lock, the Child-protector rear door locks, which are manually operated, are not provided.

Rear Occupant Alert (ROA)

Rear Occupant Alert (ROA) is provided to help prevent exiting the vehicle with a rear passenger left in the vehicle.

- When you open the front door after opening and closing the rear door and turning off the vehicle, **Check rear seats** warning message appears on the cluster.



A: Check rear seats

You can activate or deactivate Rear Occupant Alert (ROA) from the infotainment system.

The option can be found under the following menu:

1. Press **Setup** button from the infotainment system screen.
2. Press **Setup** → **Vehicle** → **Convenience** → **Rear Occupant Alert** on the infotainment system screen.

For detailed information, refer to the separately supplied infotainment system manual.

⚠ WARNING

Rear Occupant Alert (ROA) does not actually detect objects or people in the rear seat. By using a rear door opened and closed history, the system informs the driver that there may be something in the rear seat.

⚠ CAUTION

- Rear Occupant Alert (ROA) uses a rear door opened and closed history.
- The history is reset after the driver turns the vehicle off normally, exits the vehicle and locks the door remotely. So even if a rear door does not reopen, Rear Occupant Alert (ROA) alert can occur.
- For example, after the Rear Occupant Alert (ROA) alert occurs, if the driver does not lock the door, and drives again, the alert can occur.

⚠ WARNING

The door lock system may not work if the electrical system is compromised. Accordingly, please train children passengers regarding how to open the car door manually before an emergency situation arises. That way, they would be able to open the door manually in the event an emergency situation arises.

Driver Position Memory System (if equipped)

The Driver Position Memory System is provided to store and recall the following memory settings with a simple button operation.



- Driver's seat position
- Outside rear view mirror position
- Instrument panel illumination intensity
- Head Up Display (HUD) display mode, position, AR matching adjustment (if equipped)

⚠ WARNING

Never attempt to operate the driver position memory system while the vehicle is moving.

This could result in loss of control, and an accident causing death, serious injury, or property damage.

*** NOTICE**

- If the battery is disconnected, the memory settings will be erased.
- If the Driver Position Memory System does not operate normally, have the system checked by an authorized Kia dealer.

Storing memory positions

1. Shift to P (Park) while the EV button is in the ON position.
2. Adjust the driver's seat position, outside rearview mirror position, and

head-up display height to the desired position.

3. Hold the button (1 or 2). The system will beep once and notify you 'Driver 1 (or 2) settings saved' will appear on the infotainment screen.

Recalling memory positions

1. Shift to P (Park) while the EV button is in the ON position.
2. Press the desired memory button (1 or 2). The system will beep once, and then the driver's seat position, outside rearview mirror position, and head-up display height will automatically adjust to the stored positions.
3. 'Driver 1 (or 2) settings applied' will appear on the infotainment screen.

* NOTICE

- In order to adjust the memory button (2) while adjusting the memory button (1), press the memory button (1) to pause the adjustment of (1), then press memory button (2).
- If you adjust the seat, rearview mirror, head-up display while recalling the stored positions, the manually adjusted settings will be applied.

Resetting memory positions

If the Driver position memory system does not work properly, initialize the system as follows:

Resetting integrated memory system

1. Stop the vehicle and open the driver's door with the EV button in the ON position and the vehicle shifted to P (Park).
2. Adjust the driver's seat and seatback to the foremost position.

3. Press the memory button 1 (or 2) and push forward the driver's seat movement switch over 2 seconds simultaneously.

While resetting integrated memory system

1. Resetting starts with a notification sound.
2. The driver's seat and seatback is adjusted to the rearward position with the notification sound.
3. The driver's seat and seatback is re-adjusted to the default position (central position) with the notification sound.

However, in the following cases, the resetting procedure and the notification sound may stop.

- The memory button is pressed.
- The seat control switch is operated.
- The gear is shifted out of P (Park).
- The driving speed exceeds 3 km/h (2 mph).
- The driver's door is closed.

* NOTICE

- While integrated memory system is being reset, if the resetting and notification sound stops incompletely, restart the resetting procedure again.
- Make sure that there is no objects around the driver's seat in advance of resetting the integrated memory system.
- After resetting the integrated memory system, the adjustment for the driver seat must be stored again to recall the memory position.

Seat easy access (if equipped)

The system will move the driver's seat automatically as follows:

Exiting the vehicle

The driver's seat will move as follows when the EV button is in the OFF position with the gear in P (Park) and the driver's door open.

- Driver seat: Moves rearward depending on the distance selected from the Settings menu in the infotainment system.

However, the driver's seat may not move rearward if there is not enough space between the driver's seat and the rear seats.

Entering the vehicle

The driver's seat will move as follows when the EV button is pressed to the ACC, ON or START position or while carrying the smart key, the driver's door is closed with the EV button in the OFF position.

- Driver seat: Moves back to its original position.

You can set the Seat Easy Access function from the Settings menu in the infotainment system screen. Select:

- Driver seat
Setup → **Vehicle** → **Seat** → **Seat Easy Access** → **Driver Seat Easy Access** → **Normal/Extended/Off**

* INFORMATION

The infotainment system may change after software updates. For more information, refer to the user's manual provided in the infotainment system and the quick reference guide.

Liftgate

When you open the liftgate, you will see a space where you can load the cargo.

Opening the liftgate

The liftgate is locked or unlocked when all doors are locked or unlocked with the key, smart key or central door lock/unlock switch.

⚠ CAUTION

Liftgate lift

Make sure that you close the liftgate before driving your vehicle. Possible damage may occur to the liftgate gas lifters and attached hardware if the liftgate is not closed prior to driving.



- Only the liftgate is unlocked if the liftgate unlock button on the smart key is pressed for approximately 1 second.
- If unlocked, the liftgate can be opened by pressing the handle (1) and pulling it up.
- Once the liftgate is opened and then closed, the liftgate locks automatically. (All doors must be locked.)

*** NOTICE**

In cold and wet climates, door lock and door mechanisms may not work properly due to freezing conditions.

⚠ WARNING

The liftgate swings upward. Make sure no objects or people are near the rear of the vehicle when opening the liftgate.

Closing the liftgate

Lower and push down the liftgate firmly. Make sure that the liftgate is securely latched.



Make sure your hands, feet and other parts of your body are safely out of the way before closing the liftgate.

⚠ WARNING

Rear Cargo Area

Occupants should never ride in the rear cargo area where no restraints are available. Occupants should always be properly restrained.

Emergency liftgate safety release

Your vehicle is equipped with the emergency liftgate safety release lever located on the bottom of the liftgate. When someone is inadvertently locked in the luggage compartment.



The liftgate can be opened by doing as follows:

1. Input the mechanical key (1) into the hole.
2. Push the mechanical key to the right.
3. Push up the liftgate.

⚠ WARNING

- No one should be allowed to occupy the cargo area of the vehicle at any time. The cargo area is a very dangerous location in the event of a crash.
- Use the release lever for emergencies only. Use with extreme caution, especially while the vehicle is in motion.

⚠ WARNING

Make sure there are no people or objects around the liftgate before opening or closing the liftgate. Wait until the liftgate is open fully and stopped before loading or unloading cargo from the vehicle.

⚠ WARNING

Do not grasp the part supporting the liftgate (gas lifter), as this may cause serious injury.



Power liftgate (if equipped)

Power liftgate operating conditions

The power liftgate operates when the gear is in P (Park) with the vehicle running. However, the power liftgate will operate regardless of the gear position when the vehicle is off. Also, the liftgate can be opened only when vehicle speed is below 3 km/h (1.8 mph).

For safety, before attempting to open or close the liftgate, make sure the vehicle is in P (Park).

⚠ WARNING

- Never leave children or animals unattended in your vehicle. Children may operate the power liftgate. Doing so can result in injury to themselves or others and can damage the vehicle.
- Make sure that there are no people or objects in the path of the power liftgate or smart liftgate prior to use. Serious injury, damage to the vehicle or damage to surrounding objects (for example, walls, ceilings, vehicles, etc.) may result if contact with the liftgate occurs.



OCCV041018L

A: 70 cm (27 inches)

B: 70 cm (27 inches)

- The liftgate may not open or may close unintentionally injuring people around the liftgate under the following situation:

- There is a lot of snow on the liftgate.
- There is a heavy object on the liftgate such as a bicycle carrier, ladder, etc.
- Do not open the liftgate before removing snow or heavy object on the liftgate.

*** NOTICE**

- Do not close or open the liftgate manually. This may cause damage to the power liftgate. If it is necessary to close or open the liftgate manually when the battery is discharged or disconnected, do not apply excessive force.
- Do not operate the power liftgate more than 10 times continuously when the vehicle is not running. Use the power liftgate with the vehicle running when the power liftgate is used repeatedly to prevent battery discharge.
- Do not leave the power liftgate open for a long period of time. This may drain the battery.
- Do not apply excessive force when the power liftgate is operating. Doing so could result in vehicle damage.
- Do not grab or hold on to the liftgate support struts at any time. Damage to the liftgate support struts could result. Deformation of the liftgate support struts may cause vehicle damage and personal injury may occur.



OCCV041022N

- Do not modify or repair any part of the power liftgate by yourself. This must be done by an authorized Kia dealer.
- Do not operate the power liftgate under the following conditions. The power liftgate may not operate properly.
 - One side of the vehicle is lifted to inspect the vehicle or change a tire
 - Parking on an uneven road such as a slope, etc.
- Close the liftgate completely and lock all doors and liftgate using the central door lock button before using an automatic car wash.
- Do not spray high pressure water directly on the power liftgate outside open/close button. The liftgate may open unintentionally.

* INFORMATION

- If the liftgate is not fully closed and vehicle speed is at or above 3 km/h (1.8 mph), a warning will sound 10 times. Immediately park the vehicle at a safe place, close the liftgate, and check that the liftgate open warning on the instrument cluster is turned off.
- In cold and wet climates, the outside power liftgate open/close button may not work properly due to freezing conditions. If this occurs, remove the ice before using the outside power liftgate open/close button or use the power liftgate open/close button on the smart key or the instrument panel.
- Operating the power liftgate more than 5 times continuously could cause damage to the operating motor. If this occurs, the power liftgate will not operate to prevent the motor from overheating. If any of the power lift-

gate buttons are pressed to try to open the liftgate, the chime will sound 3 times, but the liftgate will remain closed. Allow the power liftgate system to cool for about 1 minute before operating the system again.

Operating the power liftgate

Power liftgate open/close button (Smart key, Instrument panel)



When the liftgate is closed, press the power liftgate open/close button for 1 second. The power liftgate opens with a warning sound.

While the liftgate is opening, press the button to stop liftgate operation.

When the power liftgate is opened, press and hold the power liftgate open/close button to close the liftgate. If you release the button while the liftgate is closing, power liftgate operation will stop with a warning sound for 5 seconds.

Also, if the smart key is not within operation range (approximately 10 m) from the vehicle, power liftgate operation will stop with a warning sound for 5 seconds.

Power liftgate open/close button (Outside the power liftgate)



When the liftgate is closed, press the power liftgate open/close button to open the liftgate.

If the vehicle is locked, press the power liftgate open/close button with the smart key in your possession.

If the liftgate is unlocked, the liftgate will open or close with a warning sound when the power liftgate open/close button is pressed without carrying the smart key.

Power liftgate open/close button (Inside the power liftgate)



Press the power liftgate open/close button. The liftgate opens or closes with a warning sound.

Automatic reverse

During power liftgate operation if the power liftgate senses any obstacle, the liftgate will stop or will fully open. The automatic reverse feature may not oper-

ate properly, or it may operate unexpectedly under the following circumstances:

- The automatic reverse feature may not detect the resistance if the detected resistance is below a certain level, or if the liftgate is almost fully closed near the latched position.
- The automatic reverse feature may operate if a strong impact is applied with no obstructions placed.

⚠ WARNING

Never intentionally place any object or part of your body in the path of the power liftgate to make sure the automatic reverse feature operates. Serious injury, or damage to the vehicle or object may occur.

*** INFORMATION**

The power liftgate may stop operating if the automatic reverse feature operates more than two times while attempting to open or close the liftgate. If this occurs, carefully open or close the liftgate manually, and then after 30 seconds try to operate the power liftgate automatically again.

Setting the power liftgate

To use each feature, you must select the opening speed or opening height from the settings menu. Deselect the settings when you do not want to use the feature.

Power liftgate opening speed

To adjust the power liftgate speed, select 'Setup → Vehicle Settings → Door/Liftgate → Power Liftgate Opening Speed → Fast/Slow' in the infotainment system. (Default setting is 'Fast')

Power liftgate opening height

To adjust the power liftgate opening height, select 'Setup → Vehicle Settings → Door/Liftgate → Power Liftgate Opening Height → Full Open/Level 3/Level 2/Level 1/User Height Setting' in the infotainment system.

See additional information in supplied Infotainment Manual.

User height setting

1. Position the liftgate manually to the height you prefer.
2. Press the power liftgate open/close button located inside the liftgate for more than 3 seconds.

If 'User Height Setting' is selected for the power liftgate opening height, the power liftgate will automatically open to the height manually set by you.

* INFORMATION

- If the power liftgate opening height has not been manually set, the power liftgate will fully open when 'User Height Setting' from the infotainment system is selected.
- If one of the height setting (Full Open/Level 3/Level 2/Level 1) is selected from the settings menu in the infotainment system, and then 'User Height Setting' is selected, the liftgate will open to the height manually set by you.
- The power liftgate opening speed and opening height settings change according to the linked User Profile. If the User Profile is changed, power liftgate opening speed and opening height settings will change accordingly.

Resetting the power liftgate

In some circumstances resetting the power liftgate operation may need to be performed. Some instances where resetting the power liftgate may be required include:

- When the 12-volt battery is recharged
- When the 12-volt battery is reinstalled after removal or replacement
- When the related fuse is reinstalled after removal or replacement



1. With the vehicle in OFF or ON position, shift to P (Park, Automatic transmission) or N (Neutral, Manual transmission).
2. Press the power liftgate open/close inner button (A) and outer button (B) simultaneously until a chime sounds.
3. Slowly close the liftgate manually.
4. Press the power liftgate open/close outer button. The power liftgate will open with a chime sound.

Wait until the liftgate fully opens to complete resetting. If the liftgate stops before it is fully open, resetting cannot be completed.

* INFORMATION

If the power liftgate does not operate properly after the above procedure,

have the system inspected by an authorized Kia dealer.

Emergency liftgate safety release



To unlock and open the liftgate manually from inside the luggage compartment, perform the following procedure:

1. Insert a long, flat object, such as a key into the opening at the bottom of the liftgate.
2. Slide the latch in the direction of the arrow to unlock the liftgate.
3. Push the liftgate to open.

⚠ WARNING

- For emergencies, be fully aware of the location of the emergency liftgate safety release latch in the vehicle and how to open the liftgate if you are accidentally locked in the luggage compartment.
- No one, including animals, should be allowed to occupy the luggage compartment of the vehicle at any time. The luggage compartment is a very dangerous location in the event of an accident.
- Use the release latch for emergencies only. Use extreme caution, especially while the vehicle is in motion.

Smart Liftgate with Auto Open (if equipped)

On a vehicle equipped with a smart key, the liftgate can be opened using the Smart Liftgate with Auto Open system.



The liftgate can be opened with no-touch activation satisfying all the conditions below.

- After 15 seconds when all doors are closed and locked
- The smart key is positioned within the detecting area for more than 3 seconds.

*** NOTICE**

The Smart Liftgate with Auto Open does not operate when:

- The smart key is detected within 15 seconds after the doors are closed and locked, and is continuously detected.
- The smart key is detected within 15 seconds after the doors are closed and locked, and 1.5 m (60 inches) from the front door handles. (for vehicles equipped with Welcome Light)
- A door is not locked or closed.
- The smart key is in the vehicle.

Using smart liftgate

1. Setting

To activate the Smart Liftgate with Auto Open, go to **Setup** → **Vehicle** → **Door** → **Smart Liftgate with Auto Open** on the infotainment system.

2. Detect and Alert



If you are positioned in the detecting area (50~100 cm [20~40 inches] behind the vehicle) carrying a smart key, the hazard warning lights will blink and chime will sound to alert you the smart key has been detected and the liftgate will open.

* NOTICE

Do not approach the detecting area if you do not want the liftgate to open. If you have unintentionally entered the detecting area and the hazard warning lights and chime starts to operate, leave the detecting area with the smart key. The liftgate will stay closed.

3. Automatic Opening



After the hazard warning lights blink and the chime sounds 6 times, the smart liftgate will open.

⚠ WARNING

- Make sure you close the liftgate before driving your vehicle.
- Make sure there are no people or objects around the liftgate before opening or closing the liftgate.
- Make sure objects in the cargo area do not come out when opening the liftgate on a slope. It may cause serious injury.
- Make sure to deactivate the Smart Liftgate with Auto Open when washing your vehicle. Otherwise, the liftgate may open inadvertently.
- The key should be kept out of reach of children. Children may inadvertently open the Smart Liftgate with Auto Open while playing around the rear area of the vehicle.

⚠ CAUTION

Liftgate Lift

Make certain that you close the liftgate before driving your vehicle. Possible damage may occur to the liftgate gas lifters and attached hardware if the liftgate is not closed prior to driving.

Deactivating smart liftgate



- 1 Door lock
- 2 Door unlock
- 3 Liftgate unlock/open
- 4 Panic button
- 5 Remote start
- 6 Remote Start Parking Assist (Forward) (if equipped)
- 7 Remote Start Parking Assist (Backward) (if equipped)

If you press any button of the smart key during the Detect and Alert stage, the Smart Liftgate with Auto Open function will be deactivated.

Make sure to be aware of how to deactivate the Smart Liftgate with Auto Open function for emergency situations.

* NOTICE

- If you press the door unlock button (2), the Smart Liftgate with Auto Open function will be deactivated temporarily. But, if you do not open any door for 30 seconds, the Smart Liftgate with Auto Open function will be activated again.
- If you press the liftgate unlock/open button (3) for more than 1 second, the liftgate opens.
- If you press the door lock button (1) or liftgate unlock/open button (3) when the Smart Liftgate with Auto Open function is not in the Detect and Alert stage, the Smart Liftgate with Auto Open function will not be deactivated.

- In case you have deactivated the Smart Liftgate with Auto Open function by pressing the smart key button and opened a door, the Smart Liftgate with Auto Open function can be activated again by closing and locking all doors.

Detecting area



- The Smart Liftgate with Auto Open operates with a welcome alert if the smart key is detected within 50~100 cm (20~40 inches) from the liftgate.
- The alert stops at once if the smart key is positioned outside the detecting area during the Detect and Alert stage.

* NOTICE

- The Smart Liftgate with Auto Open function may not work if any of the following occurs:
 - The smart key is close to a radio transmitter such as a radio station or an airport which can interfere with normal operation of the transmitter.
 - The smart key is near a mobile two way radio system or a cellular phone.

- Another vehicle's smart key is being operated close to your vehicle.
 - The detecting range may decrease or increase when:
 - One side of the tire is raised to replace a tire or to inspect the vehicle.
 - The vehicle is slantingly parked on a slope or unpaved road, etc.
-

Windows

The doors of this vehicle are equipped with power windows that can be operated by a switch.



- 1 Driver's door power window switch
- 2 Front passenger's door power window switch
- 3 Rear door (left) power window switch
- 4 Rear door (right) power window switch
- 5 Power window lock switch

*** NOTICE**

In cold and wet climates, power windows may not work properly due to freezing conditions.

The EV button must be in the ON position for power windows to operate.

Each door has a power window switch that controls the door's window. The driver has a power window lock button which can block the operation of rear passenger windows. The power windows can be operated for approximately 3 minutes after the EV button is turned off. However, if the front doors are opened, the power windows cannot be operated even within the 3 minute period.

The driver's door has a master power window switch that controls all the windows in the vehicle.

If the window cannot be closed because it is blocked by objects, remove the objects and close the window.

*** NOTICE**

While driving with the rear windows down or with the sunroof (if equipped) in an open (or partially open position), your vehicle may demonstrate a wind buffeting or pulsation noise. This noise is a normal occurrence and can be reduced or eliminated by taking the following actions. If the noise occurs with one or both of the rear windows down, partially lower both front windows approximately 2.5 cm (1 inch). If you experience noise with the sunroof open, slightly reduce the size of the sunroof opening.

⚠ CAUTION

Do not install any accessories in the vehicle that extend into the open window area. Such objects will impact the proper functioning of the automatic reversal "jam protection" feature.

Window opening and closing

Type A

To open or close a window, press down or pull up the front portion of the corresponding switch to the first detent position (1).



Type B - Auto up/down window (if equipped)



Pressing or pulling up the power window switch momentarily to the second detent position (2) completely lowers or raises the window even when the switch is released. To stop the window at the desired position while the window is in operation, pull up or press down and release the switch.

If the power window does not operate normally, the automatic power window system must be reset as follows:

1. Turn the EV button to the ON position.
2. Close the window and continue pulling up the power window switch for at least 1 second after the window is completely closed.

Automatic reversal (For Type B)

If the upward movement of the window is blocked by an object or part of the body, the window will detect the resistance and will stop upward movement. The window will then lower approximately 30 cm (11.8 inches) to allow the object to be cleared.

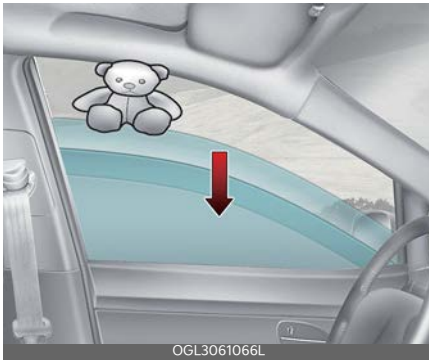

If the window detects the resistance while the power window switch is pulled up continuously, the window will stop upward movement then lower approximately 2.5 cm (1 inch).

If the power window switch is pulled up continuously again within 5 seconds after the window is lowered by the automatic window reversal feature, the automatic window reversal will not operate.

* NOTICE

The automatic reversal feature for the window is only active when the "auto up" feature is used by fully pulling up the switch. The automatic reverse feature will not operate if the window is raised

using the halfway position on the power window switch.

⚠ WARNING

Always check for obstructions before raising any window to avoid injuries or vehicle damage. If an object less than 4 mm (0.16 of an inch) in diameter is caught between the window glass and the upper window channel, the automatic reverse window may not detect the resistance and will not stop and reverse direction.

⚠ WARNING

The automatic reverse feature doesn't activate while resetting power window system. Make sure body parts or other objects are safely out of the way before closing the windows to avoid injuries.

⚠ WARNING

Do not install any accessories in the vehicle that extend into the open window area. Such objects could prevent the automatic reverse feature from functioning.

Power window lock button

The driver can disable the power window switches on the rear passengers' doors by pressing the power window lock button to the lock position (pressed).



When the power window lock button is pressed:

- The driver's master control can operate the front passenger's power window and the rear passengers' power windows.
- The front passenger's control can operate the front passenger's power window.
- The rear passengers' control cannot operate the rear passengers' power window.

⚠ CAUTION

Opening/Closing Window

To prevent possible damage to the power window system, do not open or close two windows or more at the same time. This will also ensure the longevity of the fuse.

Always double check to make sure all arms, hands, head and other obstructions are safely out of the way before closing a window.

If the window cannot be closed because it is blocked by objects, remove the objects and close the window.

⚠ WARNING

Power Windows

- Do not allow children to play with the power windows. Keep the power window lock button (on the driver's door) in the LOCK (pressed) position.
- Do not extend a face or arms outside the window opening while the vehicle is in motion. Doing so could result in significant bodily injury.

Remote window opening (if equipped)



You can still control the windows movement with the vehicle turned off.

Press the door unlock button (1) for more than 3 seconds. The window moves down after the doors are unlocked, as long as you press the door unlock button (1). The window movement stops, when you release the door unlock button (1).

⚠ WARNING

If you keep the windows open after operating the Remote window opening function, it is likely to cause a theft.

⚠ CAUTION

Using the function while raining may cause malfunction due to the inflow of water.

*** NOTICE**

- The remote window opening function may abruptly stop, when you move away from your vehicle during operation. Stay in close proximity from your vehicle, while monitoring the window movement.
- One of the windows may stop operating, when the window is interrupted by certain force. However, the other windows will keep operating. Thus, you should make sure that all windows are opened.

- Be careful when using the remote window opening function, as the doors will be unlocked.

*** NOTICE**

Remote window opening requires the automatic power window up/down function equipped for front seats.

Hood

The hood serves as a cover for the motor room and access to the front trunk.

Opening the hood

1. Pull the release lever to unlatch the hood. The hood should pop open slightly.



*** NOTICE**

Open the hood after turning off the EV button on a flat surface, turn the shifter dial to the P (Park) position and set the parking brake.

2. Go to the front of the vehicle, raise the hood slightly, push the secondary hood release lever (1) up side and lift the hood (2).



Closing the hood



1. Before closing the hood, check the following:
 - All filler caps in the motor compartment must be correctly installed.
 - Gloves, rags or any other combustible material must be removed from the motor compartment.
2. Lower the hood halfway and push down to securely lock in place.
 - Then double check to be sure the hood is secure.
 - If the hood can be lifted with a slight force, open the hood again and close it more firmly.

⚠ WARNING

Hood Obstruction

Before closing the hood, ensure that all obstructions are removed from the hood opening. Closing the hood with an obstruction present in the hood opening may result in severe personal injury or property damage.

⚠ WARNING

Fire Risk

Do not leave gloves, rags or any other combustible material in the motor compartment. Doing so may cause a heat-induced fire.

⚠ WARNING

Unsecured Hood

Always double check to be sure that the hood is firmly latched before driving away. If it is not latched, the hood could fly open while the vehicle is being driven, causing a total loss of visibility, which might result in an accident.

Hood open warning

A warning message will appear on the LCD display when hood is open.



The warning chime will operate when the vehicle is being driven above 3 km/h (2 mph) with the hood open.

Front trunk

Opening the front trunk



1 Front trunk lever

1. Open the hood.
2. Lift up the front trunk cover while depressing the front trunk lever (1).

Closing the front trunk

Push down the front trunk cover.

* INFORMATION

Available Front Trunk Weight

- 2WD/AWD: 10 kg (25 lbs.)

Available front trunk weight depends on the specifications.

▲ WARNING

- NEVER make an attempt to get inside the front trunk. It will cause a fatal injury.
- Before closing the hood, ensure all obstructions are removed from around the hood opening. The hood will rise up or move down automatically if the height is not firmly adjusted. Be aware of the damage caused by the unintended hood movements.
- Never store cigarette lighters, propane cylinders, or other flammable/explosive materials in the vehicle. These items may catch fire and/or explode if the vehicle is exposed to hot temperatures for extended periods.

▲ CAUTION

- Do not exceed the luggage volume capacity of the front trunk. The overweighted front trunk can be severely damaged.
- Do not store the fragile objects in the front trunk.
- Always keep the front trunk cover closed securely while driving. Items inside your vehicle are moving as fast as the vehicle. If you have to stop or turn quickly, or if there is a crash, the items can be damaged.
- Do not spray water in the front trunk. Vehicle driving system may get damaged since the front trunk is located at the center of motor compartment.
- Be careful when you store any liquid in the front trunk. If liquid leak outside the front trunk, it will cause a damage to the electric devices in the motor compartment.
- Do not press the front trunk cover or place the objects on the front trunk cover. It may be deformed or damaged.
- When closing the front trunk cover, be careful not to touch objects inside the trunk. Loaded objects or the front trunk may be deformed or damaged and the front trunk cover may be opened during driving due to poor closing, resulting in damage.

* NOTICE

To avoid possible theft, do not leave valuables in the storage compartments.

▲ CAUTION

Do not put objects that exceeds available front trunk weight to the front trunk, or it may cause damage to the motor room compartment.

Charging door

Opening and closing the charging door

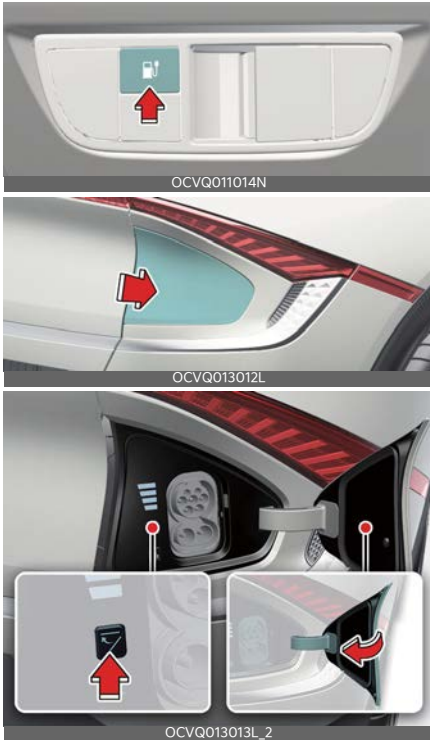

- Push the charging door open/close button on the lower crashpad or press the rear center edge of the charging door.
- Push the charging door close button located inner part of the charging door.

* NOTICE

Do not leave the vehicle with the charging door open. An open charging door may indicate that the vehicle door has been unlocked and may be subject to vehicle theft.

⚠ WARNING

The charging door opens to the right. Check the surrounding while the charging door is open or close. Use care when opening and closing the charging door to avoid your head or limbs from being hit or entrapped by the charging door.

⚠ CAUTION

Do not hold the hinge to prevent damaging the charging door and causing other accidents.

* NOTICE

- The charging door automatically closes when:
 - The charging connector is disconnected
 - The door is opened and the charging connector is not connected for approximately 2 minutes
 - The gear is not in P (Park)
- After replacing battery (12 volt), open and close the charging door once to check that the charging door automatic opening mechanism is functioning properly.

* For more details, refer to "Electric charging door" on page 1-21.

* NOTICE

- If the charging door does not open because ice has formed around it, tap lightly or push on the door to break the ice and release the door. If necessary, use hand temperature to melt down the ice or move the vehicle to a warm place and allow the ice to melt. Do not pry on the charging door or use unauthorized tools to open the

charging door. If you open it by force, the charging door may be damaged.

- Make sure that the charging door is closed before driving the vehicle. If the charging door is opened, mechanical parts of the charging door can be damaged.
- After closed the charging door, be sure to check the warning light is off.
- After charging the vehicle, close the charging inlet by the charging inlet cover properly. If the charging door is closed with the charging inlet cover closed improperly, the charging door will not be closed fully or will open again, then the charging door can be damaged.
- Do not pry on the charging door while the charging door is opening. The charging door may stop moving. Also, the electrical mechanism of the charging door and its related parts can be severely damaged.
- While washing the vehicle, do not spray a high pressure water to the charging door directly. The high pressure can damage the charging door.

Wide sunroof (if equipped)

If your vehicle is equipped with a sunroof, you can slide or tilt your sunroof with the sunroof switch located on the overhead console.



The sunroof can only be operated when the EV button is in the ON or START position.

The sunroof can be operated for approximately 3 minutes after the EV button is in the ACC or OFF position. However, if the front door is open, the sunroof cannot be operated even within the 3 minutes period.

⚠ WARNING

- Never adjust the sunroof or sunshade while driving. This could result in loss of control and an accident that may cause injury, or property damage.
- Do not leave the vehicle running and the key in your vehicle with unsupervised children. Unattended children could operate the sunroof, which could result in serious injury.
- Do not sit on the top of the vehicle. It may cause injury or vehicle damage.

Power sunshade



OCV041028L_2

Use the power sunshade to block direct sunlight coming through the sunroof glass.

- Push the sunroof switch rearward to the first detent position, the power sunshade automatically slides open.
- Push the sunroof switch forward to the first detent position, the power sunshade automatically closes. However, if the sunroof glass is open, the glass will close first.

To stop the power sunshade at any point, push the sunroof switch in any direction.

* NOTICE

Do not pull or push the power sunshade by hand as such action may damage the power sunshade or cause it to malfunction.

Wrinkles formed on the power sunshade are normal due to material characteristic.

Tilt open/close



OCV041029L_2

- Push the sunroof switch upward, the sunroof glass tilts open. However, if

the power sunshade is close, the sunshade will open first.

- Push the sunroof switch upward or forward when the sunroof glass is tilt opened, the sunroof glass automatically closes.

To stop the sunroof movement at any point, push the sunroof switch in any direction.

Slide open/close



OCV041030L_2

- Push the sunroof switch rearward to the first detent position, the sunroof glass opens. However, if the power sunshade is close, the power sunshade will open first.

Push the sunroof switch forward to the first detent position, the sunroof glass closes. However, if the sunroof glass is close, the power sunshade will close.

- Push the sunroof switch forward or rearward to the second detent position, the sunroof glass and power sunshade operate automatically until full open or full close.

To stop the sunroof movement at any point, push the sunroof switch in any direction.

Automatic reversal



If the power sunshade or sunroof glass senses any obstacle while it is closing automatically, it will reverse direction then stop at a certain position.

The auto reverse function may not work if an object thin or soft is caught between the sliding power sunshade or sunroof glass and sunroof sash.

⚠ WARNING

- Make sure heads, hands, arms or any other body parts or objects are out of the way before operating the sunroof. Body parts or objects may get caught causing injuries or vehicle damage.
- Never deliberately use your body parts to test the automatic reversal function. The power sunshade or sunroof glass may reverse direction, but there is a risk of injury.

*** NOTICE**

- Do not continue to push the sunroof switch after the sunroof is fully opened, closed, or tilted. Damage to the sunroof motor could occur.
- Continuous operations such as slide open/close, tilt open/close, etc. may cause the motor or sunroof system to malfunction.
- Regularly remove any accumulated dust on the sunroof rail.
- Dust accumulated between the sunroof and roof panel can make noise.

Open the sunroof and remove dust regularly using a clean cloth.

- Do not try to open the sunroof when the temperature is below freezing or when the sunroof is covered with snow or ice. The sunroof may not work properly and may break if opened by force.
- Do not open or drive with the sunroof glass open immediately after rain or washing the vehicle. Water may wet the interior of the vehicle.
- Do not extend any luggage outside the sunroof while driving. Vehicle damage may occur if the vehicle suddenly stops.

⚠ WARNING

Do not extend your head, arms, body parts or objects outside the sunroof while driving. Injuries may occur if the vehicle suddenly stops.

Resetting the sunroof



In some circumstances resetting the sunroof operation may need to be performed. Some instances where resetting the sunroof may be required include:

- When the 12-volt battery is either disconnected or discharged
- When the sunroof fuse is replaced
- If the sunroof one-touch AUTO OPEN/CLOSE operation is not functioning properly

Sunroof resetting procedure:

1. It is recommended to perform the reset procedure with the vehicle in the ready mode. Start the vehicle in P (Park).
2. Make sure the power sunshade and sunroof glass are in the fully closed position. If the power sunshade and sunroof glass are open, push the switch forward until the power sunshade and sunroof glass are fully closed.
3. Release the switch when the power sunshade and sunroof glass are fully closed.
4. Push the switch forward until the power sunshade and sunroof glass move slightly. Then release the switch.
5. Once again push and hold the sunroof switch forward until the power sunshade and sunroof glass slide open and close. Do not release the switch until the operation is completed.

If you release the switch during operation, start the procedure again from step 2.

* NOTICE

If the sunroof does not reset when the vehicle battery is disconnected or discharged, or the sunroof fuse is blown, the sunroof may not operate normally.

Sunroof open warning



If the driver turns off the vehicle when the sunroof is not fully closed, the warning chime will sound for several seconds and the sunroof open warning will appear on the cluster LCD display. Close the sunroof securely when leaving your vehicle.

⚠ CAUTION

Make sure the sunroof is closed fully when leaving your vehicle.

If the sunroof is left open, rain or snow may wet the interior of the vehicle. Also, leaving the sunroof open when the vehicle is unattended may invite theft.

Steering wheel

The steering wheel of this vehicle is equipped with Electric Power Steering.

Electric Power Steering (EPS)

Power steering uses an electric motor to assist you in steering the vehicle.

If the vehicle is off or if the power steering system becomes inoperative, the vehicle may still be steered, but it will require increased steering effort.

Electric Power Steering is controlled by the power steering control unit which senses the steering wheel torque and vehicle speed to command the motor.

The steering effort becomes heavier as the vehicle's speed increases and becomes lighter as the vehicle's speed decreases for better control of the steering wheel.

Should you notice any change in the effort required to steer during normal vehicle operation, have the power steering checked by an authorized Kia dealer.

* NOTICE

The following symptoms may occur during normal vehicle operation:

- The EPS warning light does not appear.
- The steering gets heavy immediately after turning the EV button in ON position. This happens as the system performs the EPS system diagnostics. When the diagnostics are completed, the steering wheel will return to its normal condition.
- A click noise may be heard from the EPS relay after turning the EV button in ON or OFF position.
- A motor noise may be heard when the vehicle is at a stop or at a low driving speed.

- When the charging system warning light comes on due to the low voltage (when the alternator or battery does not operate normally or malfunctions), the steering wheel may require increased steering effort.
- If the vehicle needs to be jump started due to battery discharge, the steering wheel may not function normally. This is a temporary situation caused by low battery voltage. It will be solved once the battery is charged. Check for normal steering function by turning the steering wheel slowly before driving the vehicle.
- The steering effort can suddenly increase, if the operation of the EPS system is stopped to prevent serious accidents when EPS control unit detects malfunction of the EPS system by self-diagnosis.

If the Electric Power Steering system does not operate normally, the warning light will appear on the instrument cluster. The steering wheel may become difficult to control or operate abnormally. In this case, have the system inspected by an authorized Kia dealer.

When you operate the steering wheel in low temperature, the steering effort may be high and abnormal noise could occur. If temperature rises, the noise will disappear. This is a normal condition.

When the vehicle is stationary, and the steering wheel is turned all the way to the left or right continuously, the steering wheel becomes harder to turn. The power assist is limited to protect the motor from overheating.

As time passes, the steering wheel will return to its normal condition.

Tilt and telescopic steering wheel

A tilt and telescopic steering wheel allows you to adjust the steering wheel before you drive.

You can also raise it to give your legs more room when you exit and enter the vehicle.

The steering wheel should be positioned so that it is comfortable for you to drive, while permitting you to see the instrument panel warning lights and gauges.

⚠ WARNING

Steering Wheel Adjustment

Never adjust the angle and height of the steering wheel while driving. You may lose steering control.

Adjusting steering wheel angle and height



1. To change the steering wheel angle, pull down the lock release lever (1).
2. Adjust the steering wheel to the desired angle (2) and height (3).
3. Pull up the lock-release lever (4) to lock the steering wheel in place.
4. Be sure to adjust the steering wheel to the desired position before driving.

*** NOTICE**

After adjustment, sometimes the lock-release lever may not lock the steering wheel.

It is not a malfunction. This occurs when two gears engage. In this case, adjust the steering wheel again and then lock the steering wheel.

Heated steering wheel (if equipped)

With the EV button in the ON position, pressing the heated steering wheel button warms the steering wheel. The indicator on the button will appear.



To turn the heated steering wheel off, press the button once again. The indicator on the button will turn off.

⚠ WARNING

If the steering wheel becomes too warm, turn the system off. The heated steering wheel may cause burns even at low temperatures, especially if used for long periods of time.

⚠ CAUTION

- Do not install any type of grip cover for the steering wheel, it may impair the function of the heated steering wheel system.
- When cleaning the heated steering wheel, do not use an organic solvent, such as paint thinner, benzene, alco-

hol and gasoline. Doing so may damage the surface of the steering wheel.

- If the surface of the steering wheel is damaged by a sharp object, damage to the heated steering wheel components could occur.

* NOTICE

The heated steering wheel will turn off automatically approximately 30 minutes after the heated steering wheel is turned on.

Horn

To sound the horn, press the area indicated by the horn symbol on your steering wheel (see illustration).



The horn will operate only when this area is pressed. Check the horn regularly to be sure it operates properly.

* NOTICE

To sound the horn, press the area indicated by the horn symbol on your steering wheel (see illustration). The horn will operate only when this area is pressed.

Mirrors

This vehicle is equipped with rearview mirrors inside and outside to provide views of objects behind the vehicle.

Inside rear view mirror

Adjust the rear view mirror so that the center view through the rear window is seen. Make this adjustment before you start driving.

Do not place objects in the rear seat or cargo area which would interfere with your vision out the rear window.

⚠ WARNING

Mirror Adjustment

Do not adjust the rear view mirror while the vehicle is moving. This could result in loss of control.

⚠ CAUTION

Cleaning Mirror

When cleaning the mirror, use a paper towel or similar material dampened with glass cleaner. Do not spray glass cleaner directly on the mirror. It may cause the liquid cleaner to enter the mirror housing.

⚠ WARNING

Do not modify the inside mirror in any manner, including installing a wide mirror. Doing so could result in injury during an accident or deployment of the air bag.

For Telematics button function



- 1 Virtual assist button
- 2 Kia Connect button
- 3 Roadside assist button

Day/night rear view mirror (if equipped)

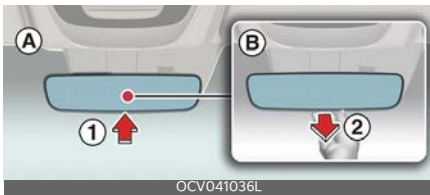

(A): Day, (B): Night

Make this adjustment before you start driving and while the day/night lever is in the day position (1).

Pull the day/night lever toward you (2) to reduce the glare from the headlamps of the vehicles behind you during night driving.

Remember that you lose some rear view clarity in the night position.

Electric Chromic Mirror (ECM) (if equipped)

The electric rear view mirror automatically controls the glare from the headlamps of the vehicles behind you in nighttime or low light driving conditions.



The sensor mounted in the mirror senses the light level around the vehicle, and automatically controls the headlamp glare from the vehicles behind you. When the vehicle is running, the glare is automatically controlled by the sensor mounted in the rear view mirror.

Electric Chromic mirror (ECM) with HomeLink® system (if equipped)



- 1 HomeLink Channel 1
- 2 HomeLink Channel 2
- 3 HomeLink Channel 3
- 4 Garage Door Opener Status Indicator: Closing or Closed
- 5 HomeLink Operation Indicator
- 6 Garage Door Opener Status Indicator: Opening or Opened
- 7 HomeLink User Interface Indicator

Your vehicle may be equipped with a Gentex Automatic-Dimming Mirror with

an Integrated HomeLink® Wireless Control System.

During nighttime driving, this feature will automatically detect and reduce rear view mirror glare. The HomeLink® Universal Transceiver allows you to activate your garage door(s), electric gate, home lighting, etc.

Automatic-Dimming Night Vision Safety™ (NVS®) Mirror

The NVS® Mirror automatically reduces glare by monitoring light levels in the front and the rear of the vehicle. Any objects that obstructs the light sensor will degrade the automatic dimming control feature.

For more information regarding NVS® mirrors and other applications, please refer to the Gentex website:

www.gentex.com

Your mirror will automatically dim upon detecting glare from the vehicles traveling behind you.

The mirror defaults to the ON position each time the vehicle is started.

Integrated HomeLink® Wireless Control System

The HomeLink® Wireless Control System provides a convenient way to replace up to three handheld radio-frequency (RF) transmitters used to activate compatible devices such as gate operators, garage door openers, entry door locks, security systems, and home lighting.

* NOTICE

Considering the Home Security when the vehicle is parked outside the garage, the HomeLink will ONLY work when the ignition switch is in ACC position or ON position.

* NOTICE

Before programming HomeLink to a garage door opener or gate operator, make sure that people and objects are out of the way of the device to prevent potential harm or damage. When programming a garage door opener, it is advised to park outside of the garage. Do not use HomeLink with any garage door opener that lacks safety stop and reverse features as required by U.S. federal safety standards (this includes any garage door opener model manufactured before April 1, 1982). A garage door that cannot detect an object signaling the door to stop and reverse - does not meet current U.S. federal safety standards. For more information, contact HomeLink at **www.homelink.com**, or call HomeLink customer support at **1-800-355-3515**.

It is also recommended that a new battery be replaced in the hand-held transmitter of the device being trained to HomeLink for quicker training and accurate transmission of the radio frequency.

1. Programming HomeLink®

The following steps show how to program HomeLink. If you have any questions or are having difficulty programming your HomeLink buttons, refer to the HomeLink website or call the HomeLink customer support toll-free

number. Do this, before going back to the dealer who sold you the car.

- Visit the HomeLink website at: www.homelink.com. Then at the top of the page, choose your vehicle make. Then watch the You Tube video, and/or access additional website information.
- If you choose to access the website via your cell phone, scan the QR code.



- Or, call HomeLink customer support at **1-800-355-3515** (Please have the vehicle make/model AND the opener device make/model readily available.)

1) Programming Preparation

1. When programming a garage door opener, it is advised to park the vehicle outside of the garage.
2. It is recommended that a new battery be placed in the hand-held transmitter of the device being programmed to HomeLink for quicker training and accurate transmission of the radio-frequency signal.
3. Place the EV button to the ACC (Accessory) position for programming of HomeLink.



2) Programming a New Home-Link® Button

1. Press and release the HomeLink button (1), (2) or (3), you would like to program. The HomeLink indicator light (7) will flash orange slowly (if not, perform the steps of "Erasing Home-Link Buttons" section, and start over).



2. Position the garage door opener remote 2~8 cm (1~3 inches) away from the HomeLink buttons.



3. While the HomeLink indicator light (7) is flashing orange, press and hold the hand-held remote button. Continue pressing the hand-held remote button until the HomeLink indicator light (7) light changes from orange to green. You may now release the hand-held remote button.
4. Wait until your garage door comes to a complete stop, regardless of position, before proceeding to the next steps.
5. Press and release the HomeLink button you are programming and observe the indicator light.
 - If the indicator light remains solid green, your device should operate when the HomeLink button is

pressed. At this point, if your device operates, programming is complete.

- If the indicator light rapidly flashes green, firmly press, hold for two seconds and release the HomeLink button up to three times in a row slowly to complete the programming process. Do not press the HomeLink button rapidly. At this point if your device operates, programming is complete. If the device does not operate, continue with step 6.

6. At the garage door opener motor, (security gate motor, etc.) locate the "Learn", "Smart", "Set" or "Program" button. This can usually be found where the hanging antenna wire is attached to the motor-head unit (see the device's manual to identify this button). The name and color of the button may vary by manufacturer.

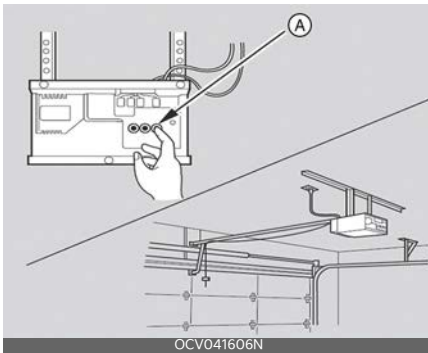

* A ladder and/or second person may simplify the following steps.

7. Firmly press and release the "Learn", "Smart", "Set" or "Program" button. You now have up to 30 seconds in which to complete the next step.
8. Return to the vehicle and firmly press, hold for two seconds and release, the

HomeLink button up to three times in a row slowly. Do not press the HomeLink button rapidly. As soon as you see the garage door start to move, stop pressing any buttons until a few seconds after the garage door has come to a complete stop, regardless of position. At this point programming is complete and your device should operate when the HomeLink button is pressed and released.

3) Two-Way Communication Programming (For select garage door openers)

If your garage door opener has the 'myQ' logo on its side, your opener has Two-Way Communication capability. HomeLink has the capability to establish Two-Way Communication with your garage door opener. HomeLink can receive and display "closing" or "opening" status messages from compatible garage door openers. At any time, HomeLink can also recall and display the last recorded status communicated by the garage door opener to indicate your garage door being "closed" or "opened".

To check if your garage door opener is compatible with this feature, refer to www.homelink.com/compatible/Two-way-Communication. If your garage door opener has this functionality, AND the Two-Way Communication indicators (4), (6) in the mirror appear while the garage door is opening/closing, then no further steps are needed. Two-Way Communication Programming is already complete. However, if your garage door opener has this functionality, AND the Two-Way Communication indicators (4), (6) in the mirror DO NOT appear while the garage door is opening/closing, use

the following instructions to enable this functionality.

1. In your vehicle, press and hold the programmed HomeLink button for 2 seconds, then release. Confirm that the garage door is moving. AFTER it stops, you will have one minute to complete the following steps:
 - * A ladder and/or second person may simplify the following steps.
2. On your garage door opener in your garage, locate the "Learn" button (usually near where the hanging antenna wire is attached to the garage door opener). If there is difficulty locating this button, refer to the device's owner's manual.
3. Press and release the "Learn" button.
4. A light on your garage door opener may flash, and your Two-Way Communication indicators (4), (6) in your vehicle may flash, confirming completion of the process.
5. Return to the vehicle and firmly press and release the programmed HomeLink button to activate your garage door. The Two-Way Communication indicators (4), (6) flash in orange when the door is moving. Do not make any additional button presses until AFTER the garage door has come to a complete stop.
6. Your Two-Way Communication programming is now complete.

*** NOTICE**

If your garage door opener has Two-Way Communication functionality, it is possible for HomeLink to stop functioning the garage door shortly after initial programming, if the Two-Way Communication Programming wasn't properly completed. This usually happens after

the first 10 times a programmed HomeLink button is pressed. If you experience this, completing the "Programming a New HomeLink Button" and "Two-Way Communication Programming" will restore door operation.

4) Canadian Programming

Canadian radio-frequency laws require transmitter remote signals to "time-out" (or quit) after a couple seconds of transmission, which may not be long enough for HomeLink to pick up the signal during programming.

If you live in Canada or you are having difficulties programming a gate operator or garage door opener by using the programming procedures, replace "Programming a New HomeLink Button" step 3 with the following:

While the HomeLink indicator light (7) is flashing orange, press and release ("cycle") your device's hand-held remote every two seconds until the HomeLink indicator light (7) changes from orange to green. You may now release the hand-held remote button. Then proceed with "Programming a New HomeLink Button" step 4.

2. Operating HomeLink®

1) Operating HomeLink®

1. Press and release the desired programmed HomeLink button (1, 2 or 3).



*** NOTICE**

The HomeLink indicator (7) should light green, solid or flashing, and your programmed device should operate.

If your device does not operate, the HomeLink programming was not successful, and you'll need to reprogram the button.

2) Two-Way Communication Display Behavior

1. Press and release one of the programmed HomeLink buttons (1, 2 or 3)



2. The indicator (4) and (6) operates as below, if your garage door opener has Two-Way Communication functionality.



- If the indicator (4) flashes in Orange, it indicates that the garage door is "Closing".
- The indicator (4) turns solid green once the garage door has closed.
- If the indicator (6) flashes in Orange, it indicates that the garage door is "Opening".

- The indicator (6) turns solid green once the garage door has fully opened.
- If the indicator (4) or (6) does not turn to green, it indicates that the last status of garage door was not received properly. The HomeLink mirror tries to receive the last known status of the garage door for a few seconds.

3) Recalling Garage Door Status

HomeLink mirror with Two-Way Communication provides a way to view the last stored message from the garage door opener. In order to recall the last known status of the last activated device, press the buttons "1 and 2" OR "2 and 3" simultaneously.

- If the indicator (4) appears solid Green, it indicates that the last activated device was "closed" properly.
- If the indicator (6) appears solid Green, it indicates that the last activated device was "open" properly.

3. Erasing HomeLink® Buttons

1) Erasing and Reprogramming a Single HomeLink® Button:

1. Press and hold the desired HomeLink button you want to re-program. DO NOT release the button.
2. The HomeLink indicator light (7) will appear solid green. Release the button as soon as the HomeLink indicator light (7) begins to flash orange, usually about 20 seconds.
3. Proceed with the steps in the "Programming a New HomeLink Button" section.

*** NOTICE**

If you do not complete the re-programming of a new device to the button, it will revert to the previously stored programming.

2) The following instructions will erase ALL HomeLink® programming from ALL buttons:



1. Press and hold the buttons (1) and (3) simultaneously
2. The HomeLink indicator light (7) will appear solid Orange for about 10 seconds
3. Release the buttons once the HomeLink indicator light (7) changes to Green and flashes rapidly
4. Now all three HomeLink buttons (1), (2) and (3) are cleared of any programming

Information

HomeLink and the HomeLink House logo are registered trademarks of Genex Corporation.

The myQ logo is a registered trademark of The Chamberlain Group, Inc

FCC (USA) and ISED (Canada)

This device complies with FCC rules part 15 and Innovation, Science, and Economic Development Canada RSS-210. Operation is subject to the following two conditions: (1) This device may not cause

harmful interference, and (2) This device must accept any interference that may be received including interference that may cause undesired operation. **WARNING:** The transmitter has been tested and complies with FCC and ISED rules. Changes or modifications not expressly approved by the party responsible for compliance could void the user's authority to operate the device.

This equipment complies with FCC and ISED radiation exposure limits set forth for an uncontrolled environment. End Users must follow the specific operating instructions for satisfying RF exposure compliance. This transmitter must be at least 20 cm from the user and must not be co-located or operating in conjunction with any other antenna or transmitter.

HomeLink 5 Programing Flow Chart

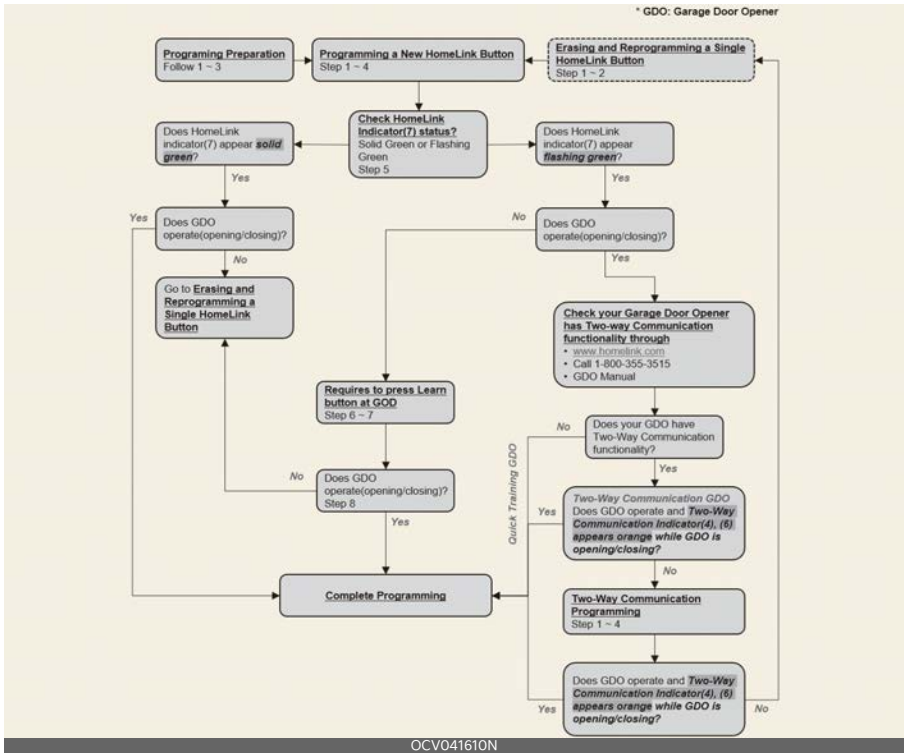

Outside rear view mirror

Your vehicle is equipped with both left-hand and right-hand outside rear view mirrors.

Be sure to adjust the mirror angles before driving.

The mirrors can be adjusted remotely with the remote switch. The mirror heads can be folded back to prevent damage during an automatic car wash or when passing through a narrow street.

⚠ CAUTION

Rear View Mirrors

Do not scrape ice off the mirror face; this may damage the surface of the glass. If ice should restrict the movement of the mirror, do not force the mirror for adjustment. To remove ice, use a de-icer spray, a sponge or soft cloth with very warm water.

If the mirror is jammed with ice, do not adjust the mirror by force. Use an approved spray de-icer (not radiator antifreeze) to release the frozen mechanism or move the vehicle to a warm place and allow the ice to melt.

⚠ WARNING

Mirror Adjustment

Do not adjust or fold the outside rear view mirrors while the vehicle is moving. This could result in loss of control.

Adjusting the outside rear view mirrors



Adjusting the rear view mirrors:

1. Move the R or L switch (1) to select the right side mirror or the left side mirror.
2. Press a corresponding point on the mirror adjustment control (2) to position the selected mirror up, down, left or right.
3. After adjustment, put the button into neutral (center) position to prevent inadvertent adjustment.

⚠ CAUTION

- The mirrors stop moving when they reach the maximum adjusting angles, but the motor continues to operate while the switch is pressed. Do not press the switch longer than necessary, the motor may be damaged.
- Do not attempt to adjust the outside rear view mirror by hand. Doing so may damage the parts.

Folding the outside rear view mirror

The outside rear view mirror can be folded or unfolded by pressing the switch as below.



The mirror will fold or unfold automatically as follows:

- The mirror will fold or unfold when the door is locked or unlocked by the smart key.
- The mirror will fold or unfold when the door is locked or unlocked by the button on the outside door handle.
- The mirror will unfold when you approach the vehicle (all doors closed and locked) with a smart key in possession. (if equipped)

CAUTION

The electric type outside rear view mirror operates even though the EV button is in OFF position. However, to prevent unnecessary battery discharge, do not adjust the mirrors longer than necessary while the EV button is ON.

Do not fold an electric type outside rear view mirror by hand as this could cause motor failure.

Reverse parking aid function (if equipped)

When the gear is shifted to the R (Reverse) position, the outside rear view lever(s) will rotate downwards to aid with driving in reverse.



The position of the outside rear view mirror switch (1) determines whether or not the mirrors will move:

- Left/Right: When either the L (Left) or R (Right) switch is selected, both outside rear view mirrors will move.
- Neutral: When neither switch is selected, the outside rear view mirrors will not move.

The outside rear view mirrors will automatically revert to their original positions if any of the followings occur:

- The EV button is placed to either the OFF position or the ACC position.
- The gear is shifted to any position except R (Reverse).
- The remote control outside rear view mirror switch is not selected.

Reverse parking aid user settings mode

If you cannot secure enough visibility with the angles provided as factory default conditions, you can readjust and

store the angles of outside rear view mirrors.

The factory default angles of the right and left rear view mirrors might be set differently to improve visibility.

1. Set the shift lever to P (Parking). Make sure that the vehicle is stopped and the mirrors are not working.
2. Position the lever to L (left) or R (right) depending on the mirror that you want to adjust.
3. Step on the brake pedal and shift the shift lever to R (Reverse).
4. When the downward movement of the rear view mirror is finished, adjust the mirror to the desired angle by pressing the switches, ▼, ▲, ◀, ▶.
5. If you shift the shift lever to a position other than R (Reverse), or change the rear view mirror selector lever to the neutral position, and the automatic return of the mirror is finished, the adjusted angle will be automatically saved.
6. You can adjust the rear view mirror on the other side by following the same procedures (1~5).

4. When the downward movement of the rear view mirror is finished, press the switch (▲) to locate the mirror in the position higher than before (P, N or D).

(Adjust the mirror in the higher position compared to its position in the driving mode)

5. It is initialized when the shift lever is shifted to a position other than R (Reverse), or the rear view mirror selector lever is changed to the neutral position. (Initialized position will be applied from next operation)
6. You can initialize settings for the mirror on the other side by following the same procedures (1~5).

* NOTICE

We recommend following the procedures in an orderly manner to change or initialize the auto reversing user settings. If you move to the next step before completing the previous one, the changed angle may not be changed or initialization may not work properly.

Resetting reverse parking aid user settings mode

If you want to change the automatic control function of rear view mirrors to factory-default conditions, follow the steps below.

1. Shift the shift lever to P (Park). Make sure that the vehicle is stopped and the mirror is not working.
2. Choose the mirror to be adjusted by positioning the lever to L (left) or R (right).
3. Step on the brake pedal and shift the shift lever to R (Reverse).

Instrument cluster

The instrument cluster displays various information about the vehicle's condition.



* The actual cluster and contents of the LCD display in the vehicle may differ from the illustration.

- 1 Speedometer
- 2 Distance to empty
- 3 Power/Charge gauge
- 4 Battery SOC (State of Charge) gauge
- 5 LCD display (including Trip computer)
- 6 Warning and indicator lights
- 7 Reduction gear shift indicator
- 8 Odometer
- 9 Regenerative braking level indicator
- 10 Electric energy economy

⚠ WARNING

Be careful while driving as dynamic-themed animation effects can distract the driver and lead to unexpected accidents.

Instrument panel illumination control

The brightness of the instrument panel illumination is changed by pressing the illumination control button ("+" or "-") when the vehicle's position lights or headlamps are turned on.



- If you hold the illumination control button ("+" or "-"), the brightness will be changed continuously.



- If the brightness reaches to the maximum or minimum level, an alarm will sound.

⚠ WARNING

Never adjust the instrument cluster while driving. This could result in loss of control and lead to an accident that may cause death, serious injury, or vehicle damage.

Gauges

The gauges display various information such as the speed of the vehicle, the amount of charge of the battery, and so on.

Speedometer



The speedometer indicates the speed of the vehicle and is calibrated in kilometers per hour (km/h) and/or miles per hour (mph).

Power/Charge gauge



The Power/Charge gauge shows the energy consumption rate of the vehicle and the charge/discharge status of the regenerative brakes.

- **PWR** (Power): It shows the energy consumption rate of the vehicle when driving uphill or accelerating. The more electric energy is used, the higher the gauge level.
- **CHG** (Charge): It shows the charging status of the battery when it is being charged by the regenerative brakes (decelerating or driving on a downhill road). The more electric energy is charged, the lower the gauge level.

State of Charge (SOC) gauge for high voltage battery



The SOC gauge shows the charging status of the high voltage battery.

The low percentage number on the indicator indicates that there is not enough energy in the high voltage battery. 100% indicates that the driving battery is fully charged.

When driving on highways or motorways, make sure to check in advance if the driving battery is charged enough.



When the remaining battery is lower than 10% (15% for GT) on the SOC gauge, the warning light (🔋) turns ON to alert you of the battery level.

When the warning light (🔋) turns ON, the vehicle can drive approximately an additional 30~40 km (18~25 miles) depending on the driving speed, heater/air conditioner, weather, driving style, and other factors. Charging is required.

* NOTICE

When the high voltage battery range is 40~50 km (25~30 miles), the vehicle speed is limited, and then eventually the vehicle will turn OFF. Charge the vehicle immediately.

Outside temperature gauge



This gauge indicates the current outside air temperatures by 1 °F (1 °C).

The outside temperature on the display may not change immediately like a general thermometer to prevent the driver from being distracted.

You can change the temperature unit from the Settings menu in the infotainment system screen. Select:

General Settings → **Unit** → **Temperature Unit** → °C/°F

For detailed information, refer to the separately supplied infotainment system manual.

Both the temperature unit on the cluster LCD display and climate control screen will change.

* INFORMATION

The infotainment system may change after software updates. For more information, refer to the user's manual provided in the infotainment system and the quick reference guide.

Odometer



The odometer indicates the total distance that the vehicle has been driven and should be used to determine when periodic maintenance should be performed.

Distance to empty



- The distance to empty is the estimated distance the vehicle can be driven with the remaining electric energy.
- The distance to empty varies depending on which drive mode is selected among **ECO/NORMAL/SPORT/SNOW** mode.

* NOTICE

- If the vehicle battery power has been interrupted, the distance to empty function may not operate correctly.
- The distance to empty may differ from the actual driving distance as it is an estimate of the available driving distance.
- The distance to empty may vary significantly based on driving conditions, driving habits, and condition of the vehicle.

Reduction gear shift indicator



This indicator displays which position is selected.

- Park: P
- Reverse: R
- Neutral: N
- Drive: D

Regenerative braking level indicator



The regenerative brake indicates the level of the regenerative braking that you set. And it also indicates Smart regenerative system's operation status.

LCD display

The LCD display shows trip computer and other information.

LCD display control

The LCD display modes can be changed by using the control buttons.



- 1 : MODE button for changing modes
- 2 : MOVE switch for changing items
- 3 : OK: SELECT/RESET button for setting or resetting the selected item

LCD display modes

*: if equipped

		Mode				
		 Driving Assist	 Trip Computer	 Turn By Turn (TBT)*	 Information	 Master Warning
^ v Up/ Down	Forward Collision-Avoidance Assist	Drive Info	Route Guidance	Energy Flow (AWD)	The Master Warning mode displays warning messages related to the vehicle when one or more systems is not operating normally.	
	Lane Keeping Assist					
	Blind-Spot Collision-Avoidance Assist					
Smart Cruise Control	After Recharging	Destination Info	TPMS			
Lane Following Assist						
Highway Driving Assist	Accumulated Info					
Driver Attention Warning						
Intelligent Speed Limit Assist*						

Trip modes

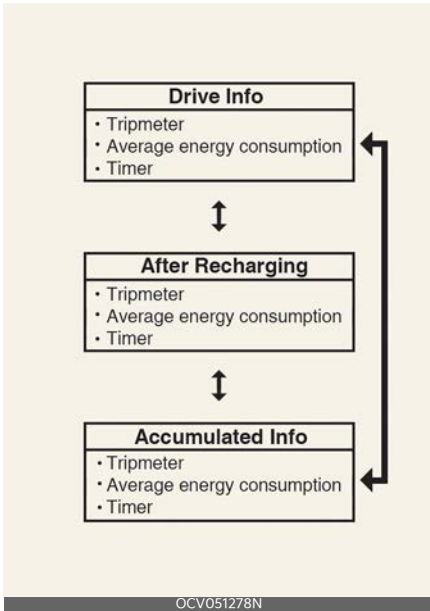

To change the trip mode, toggle the switch (↖/↗) on the steering wheel.

Electric energy economy

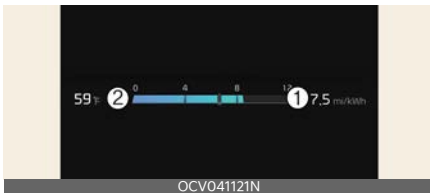

Average Energy Consumption (1)

- The average energy consumption is calculated by the total driving distance and the high voltage battery consumption since the last average energy consumption reset.
- The average energy consumption can be reset both manually and automatically.

Manual reset

To clear the average energy consumption manually, press the OK button on the steering wheel for more than 1 second when the average energy consumption is displayed.

Automatic reset

To automatically reset the average energy consumption select either menu from the 'Energy Consumption Reset' in the Cluster menu on the infotainment system screen.

- At Vehicle Start: The average energy consumption will reset automatically whenever it has passed 4 hours after turning OFF the vehicle.
- After recharging: The average energy consumption will reset automatically when driving speed exceeds 1 km/h (1 mph), after recharging more than 10%.

* NOTICE

The vehicle must be driven for a minimum of 300 meters (0.19 miles) since the last ignition key cycle before the average energy consumption will be recalculated.

Instant Energy Consumption (2)

- The instantaneous energy consumption is displayed according to the bar graph in the LCD display while driving.

Driving Assist mode

This mode displays the state of:

- Forward Collision-Avoidance Assist
- Lane Keeping Assist
- Blind-Spot Collision-Avoidance Assist
- Smart Cruise Control
- Lane Following Assist

Highway Driving Assist

- Driver Attention Warning
- Intelligent Speed Limit Assist

Trip computer mode 

* You may change through items in the following order.

Drive Info



A: **Drive Info**

- 1 Accumulated trip distance
- 2 Average energy consumption
- 3 Total driving time

This display shows the accumulated trip distance (1), the average energy consumption (2), and the total driving time (3).

The information is combined for each ignition cycle. However, drive Info screen will reset when the driver's door is opened after turning off the vehicle, or the vehicle is turned on after 3 minutes have passed.

The driving information will continue to be counted while the vehicle is in the **READY** mode (for example, when the vehicle is in traffic or stopped at a stop light).

*** NOTICE**

The vehicle must be driven for a minimum of 300 meters (0.19 miles) since the last ignition key cycle before the driving information is recalculated.

After Recharging



A: **After recharging**

- 1 Accumulated trip distance
- 2 Average energy consumption
- 3 Total driving time

This display shows the accumulated trip distance (1), the average energy consumption (2), and the total driving time (3) after recharging.

To manually reset the information, press and hold the OK button when viewing the **After Recharging**.

Accumulated Info

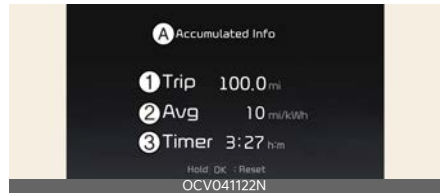

A: **Accumulated Info**

- 1 Accumulated trip distance
- 2 Average energy consumption
- 3 Total driving time

This display shows the accumulated trip distance (1), the average energy consumption (2), and the total driving time (3).

The information is accumulated starting from the last reset.

To reset the details, press and hold the OK button when viewing the Accumulated driving info. The accumulated trip distance, the average energy consumption,

tion, and total driving time will reset simultaneously.

The accumulated driving information will continue to be counted while the vehicle is in the **READY** mode (for example, when the vehicle is in traffic or stopped at a stop light).

*** NOTICE**

The vehicle must be driven for a minimum of 300 meters (0.19 miles) since the last ignition key cycle before the average accumulated driving information is recalculated.

Energy flow (AWD) (if equipped)

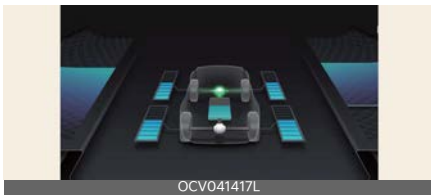

- The electric vehicle system informs the drivers its energy flow in various operating modes.
- The distribution status of the driving power of the front and rear wheels are displayed when Auto AWD mode is activated. For more details, refer to "All wheel drive (AWD) (if equipped)" on page 6-42.

Turn By Turn (TBT) mode ↗

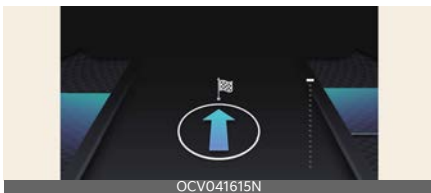

This mode displays the Navigation status.

Information mode ⓘ

Tire pressure



A: Low tire pressure

- Information related to Tire Pressure. Refer to "Tire Pressure Monitoring System (TPMS)" on page 8-6.

Master warning mode ⚠

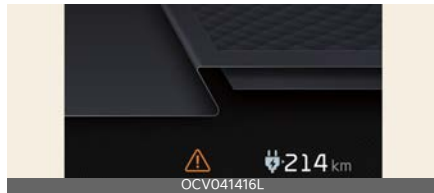

This mode informs you of the following situations:

- Driver assistance system malfunction, limitation or radar/camera blockage
- LED headlamp malfunction
- Lamp malfunction
- TPMS failure, low tire pressure, etc.

At this time, a Master Warning icon (⚠) will appear in the lower right corner on the LCD display. If the warning situation is solved, the master warning light will be turned off and the Master Warning icon will disappear.

Service Interval

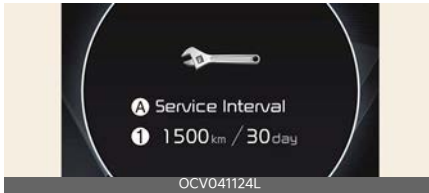

A: Service Interval

1 Service interval schedule

To reset the service interval, select **Setup** → **Vehicle** → **Cluster** → **Service Interval** → **Reset**.

* NOTICE

Calculates and displays when you need a scheduled maintenance service (mileage or days). If the remaining mileage or time reaches 1,500 km (900 miles) or 30 days, the message **Service in** is displayed for several seconds each time you set the vehicle to the ON position.

Driver Assistance settings (infotainment system)



Select **Setup** → **Vehicle** → **Driver Assistance** on the infotainment system screen to set the Driver Assistance function.

- **Driver Assistance**
 - **Smart Cruise Control**
 - **Driving Convenience**
 - **Speed Limit**
 - **Warning Timing**
 - **Warning Methods**

- **Driver Attention Warning**
- **Forward Safety**
- **Lane Safety**
- **Blind-Spot Safety**
- **Parking Safety**

Vehicle settings (infotainment system)



1. Press the **Settings** button on the head unit of the infotainment system.
2. Select **Vehicle** and change the setting of the features.

Vehicle Settings in the infotainment system provides user options for a variety of settings including door lock/unlock features, convenience features, driver assistance settings, etc.

- **Vehicle Settings**
 - **Driver Assistance**
 - **Drive Mode**
 - **Eco Vehicle**
 - **Active Sound Design**
 - **Head-up Display**
 - **Cluster**
 - **Climate**
 - **Seat**
 - **Lights**
 - **Door**
 - **Convenience**

⚠ WARNING

Do not operate the **Vehicle Settings** while driving. This may cause distraction resulting in an accident.

* NOTICE

- The information provided may differ depending on which features are applicable to your vehicle.
- For detailed information, refer to the separately supplied infotainment system manual.

LCD display messages

Door, hood, liftgate open warning display



This warning is displayed if any door or the hood or the liftgate is left open. The warning will indicate which door is open in the display.

* NOTICE

Before driving the vehicle, you should confirm that the door/hood/liftgate is fully closed. Also, check that there is no door/hood/liftgate open warning light or message displayed on the instrument cluster.

Sunroof open warning display (if equipped)

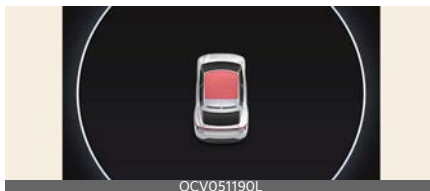

This warning is displayed if you turn off the vehicle when the sunroof is open. Close the sunroof securely before leaving your vehicle.

Low tire pressure warning display



A: Low tire pressure

This warning message is displayed if the tire pressure is low. The corresponding tire on the vehicle will appear.

* For more details, refer to "Tire Pressure Monitoring System (TPMS)" on page 8-6.

Lights mode



A: Lights

- 1 LED
- 2 AUTO
- 3 AUTO

4 OFF

This indicator displays which exterior light is selected using the lighting control.

You can activate or deactivate Wiper/Lights Display function from the infotainment system.

Wiper mode



A: Front Wiper

- 1 OFF
- 2 AUTO
- 3 LO
- 4 HI

This indicator displays which wiper speed is selected using the wiper control.

You can activate or deactivate Wiper/Lights Display function from the infotainment system.

Low key battery

This warning message is displayed if the battery of the smart key is discharged while changing the EV button to the OFF position.

Press brake pedal to start vehicle

This warning message is displayed if the EV button changes to the ACC position twice by pressing the button repeatedly without depressing the brake pedal.

You can start the vehicle by depressing the brake pedal.

Key not in vehicle

This warning message is displayed if the smart key is not in the vehicle when you press the EV button.

When attempting to start the vehicle, always have the smart key with you.

Key not detected

This warning message is displayed if the smart key is not detected when you press the EV button.

Press EV button again

This message is displayed if you were unable to start the vehicle when the EV button was pressed.

If this occurs, attempt to start the vehicle by pressing the EV button again.

If the warning message appears each time you press the EV button, have your vehicle inspected by an authorized Kia dealer.

Press EV button with key

This warning message is displayed if you press the EV button while the warning message **Key not detected** is displayed.

Shift to P to start vehicle

This warning message is displayed if you try to start the vehicle without shifting to the P (Park) position.

Shift to P

This warning message is displayed if you try to turn off the vehicle with the gear in the N (Neutral) position.

At this time, the EV button changes to the ACC position (If you press the EV button once more, it will turn to the ON position).

Battery discharging due to external electrical devices

This message is displayed if the battery voltage is weak due to any non-factory electrical accessories (ex. dashboard camera). Be careful that the battery is not discharged.

If the warning message appears after removing the non-factory electrical accessories, have your vehicle inspected by an authorized Kia dealer.

Low washer fluid

This warning message is displayed if the washer fluid level in the reservoir is nearly empty.

Have the washer fluid reservoir refilled.

Shift to P to charge

This message is displayed if you connect the charging cable without the gear in the P (Park) position.

Shift to P (Park) before connecting the charging cable.

Low EV battery

When the high voltage battery level reaches around 10% (around 15% for GT) or less, this warning message is displayed.

The warning light on the instrument cluster (🔋) will turn on simultaneously. Charge the battery immediately.

Charge immediately. Power limited

When the high voltage battery level reaches around 5% or less, this warning message is displayed.

The warning light on the instrument cluster (🔋) and the power down indicator light (🔌) will turn on simultaneously.

The vehicle's power will be reduced to minimize the energy consumption of the high voltage battery. Charge the battery immediately.

Check electric vehicle system

This warning message is displayed when there is a problem with the electric vehicle control system.

WARNING

Refrain from driving when the warning message is displayed.

If this occurs, park the vehicle in a safe location and have your vehicle towed to the nearest authorized Kia dealer and have the vehicle inspected.

Power limited

In the following cases, this warning message is displayed when the vehicle's power is limited for safety.

- When the power is limited for the safety of the high-powered parts of an electric vehicle. The power is limited for the following reasons. (Unless both Service Warning Light and Power Down Indicator Light appear at the same time, it is not a failure.)
- The high voltage battery level is too low or voltage is decreasing.
- The temperature of the high voltage battery is too high or too low.
- The temperature of the motor is high.

*** NOTICE**

When this warning message is displayed, do not accelerate or start the vehicle suddenly. Charge the battery immediately when the high voltage battery level is not enough.

*** NOTICE**

When the power is limited for the safety of the high-powered parts of an electric vehicle, the power down indicator light appears. Your vehicle may not be driven, or may roll back on a slope with the indicator light ON due to the limitation of the vehicle power.

Power limited due to low EV battery temperature. Charge battery

The warning message is displayed to protect the electric vehicle system when you turn off or turn on the vehicle while outside temperature is low. If the high voltage battery charging level is low and parked outside in low temperature for a long time, vehicle power could be limited. Charging the battery before driving, increases the battery temperature, and helps increase power.

*** NOTICE**

If this warning message is still displayed even when the ambient temperature is sufficiently high, have the vehicle inspected by an authorized Kia dealer.

EV Battery Overheated! Stop vehicle

This warning message is displayed to protect battery and electric vehicle system when the high voltage battery temperature is too high.

Turn off the EV button and stop the vehicle so that the battery temperature decreases.

*** NOTICE**

If this warning is still displayed even after the EV button has been turned off for sufficient time, refrain from driving and have the vehicle inspected by an authorized Kia dealer.

Stop vehicle and check power supply

This warning message is displayed when a failure occurs in the 12 V power supply system.

If this occurs, park the vehicle in a safe location, tow your vehicle to the nearest authorized Kia dealer and have the vehicle inspected.

Unplug vehicle to start

This message is displayed when you start the vehicle, without unplugging the charging cable, and will not shift out of park. Unplug the charging cable, and then turn on the vehicle.

Charging Door Open

This message is displayed when the vehicle is driven with the charging door opened. Close the charging door and then start driving.

Remaining Time

This message is displayed to notify the remaining time to charge the battery, to the selected target battery charge level, and the charge voltage level.

Charging Stopped. Check the AC charger/Charging Stopped. Check the DC charger

This warning message is displayed when charging is stopped for the reasons below:

- There is a problem with the external AC charger or DC charger.
- The external AC charger stopped charging
- The charging cable is damaged.

If this occurs, check whether there is any problem with the external AC or DC charger and charging cable.

If the same problem occurs when charging the vehicle with a well-functioning external charger or genuine Kia portable charger (sold separately), have your vehicle inspected by an authorized Kia dealer.

Charging Stopped. Check the cable connection

This warning message is displayed for the reasons below:

- The charging connector is not correctly connected to the charging inlet.
- The charging connector lock release button is pressed.

If this occurs, separate the charging connector and re-connect it.

Check whether there is any problem (external damage, foreign substances, etc.) with the charging connector and charging inlet.

If the same problem occurs when charging the vehicle with a replaced charging cable or genuine Kia portable charger (sold separately), have your vehicle inspected by an authorized Kia dealer.

Check regenerative brakes

This warning message is displayed when the regenerative brake system does not work properly.

In this case, have your vehicle inspected by an authorized Kia dealer.

Check Virtual Engine Sound System

This message is displayed when there is a problem with the Virtual Engine Sound System (VESS).

In this case, have your vehicle inspected by an authorized Kia dealer.

Check Active Air Flap System

This warning message is displayed in the following situations:

- There is a malfunction with the actuator flap
- There is a malfunction with the actuator air flap controller
- The air flap does not open

When all of the above conditions are fixed, the warning will disappear.

Refill coolant

This message is displayed when the coolant is low. If the warning message is displayed, stop driving and check the amount of coolant. Driving without sufficient coolant for a prolonged period of time can cause serious problems with the vehicle's electrical equipment and make normal driving impossible.

Warning and indicator lights

The warning light and indicator light indicate a situation where the driver should be careful and whether the various functions are activated.

Warning lights

The warning light indicates situations that require the driver to pay attention.

* NOTICE

Warning Lights

Make sure that all warning lights are OFF after starting the vehicle. If any light is still ON, this indicates a situation that needs attention.

Service warning light

This warning light appears:

- When the EV button is in the ON position.
 - It appears for approximately 3 seconds and then goes off.
- When there is a problem with related parts of the electric vehicle control system, such as sensors, etc.

When the warning light appears while driving, or does not go OFF after starting the vehicle, have your vehicle inspected by an authorized Kia dealer.

Air bag warning light

This warning light appears:

- Once you set the EV button to the ON position.
 - It appears for approximately 6 seconds and then goes off.
- When there is a malfunction with the SRS.

In this case, have the vehicle inspected by an authorized Kia dealer.

Seat belt warning light

This warning light informs the driver that the seat belt is not fastened.

* For more details, refer to "Seat belts" on page 4-17.

Parking brake & brake fluid warning light

This warning light appears:

- Once you set the EV button to the ON position.
 - It appears for approximately 3 seconds
 - It remains on if the parking brake is applied.
- When the parking brake is applied.
- When the brake fluid level in the reservoir is low.
 - If the warning light appears with the parking brake released, it indicates the brake fluid level in reservoir is low.

If the brake fluid level in the reservoir is low:

1. Drive carefully to the nearest safe location and stop your vehicle.
2. With the vehicle stopped, check the brake fluid level immediately and add fluid as required (For more details, refer to "Brake fluid" on page 9-12). Then check all brake components for fluid leaks. If any leak on the brake system is still found, the warning light remains on, or the brakes do not

operate properly, do not drive the vehicle.

In this case, have your vehicle towed to an authorized Kia dealer and inspected.

Dual-diagonal braking system

Your vehicle is equipped with dual-diagonal braking systems. This means you still have braking on two wheels even if one of the dual systems should fail.

With only one of the dual systems working, more than normal pedal travel and greater pedal pressure are required to stop the vehicle.

Also, the vehicle will not stop in as short a distance with only a portion of the brake system working.

WARNING

Parking Brake & Brake Fluid Warning Light

Driving the vehicle with a warning light ON is dangerous. If the parking brake & brake fluid warning light appears with the parking brake released, it indicates that the brake fluid level is low.

In this case, have your vehicle inspected by an authorized Kia dealer.

Anti-lock Brake System (ABS) warning light

This warning light appears:

- When the EV button is in the ON position.
 - It appears for approximately 3 seconds and then goes off.
- When there is a malfunction with the ABS (The normal braking system will

still be operational without the assistance of the anti-lock brake system).

In this case, have your vehicle inspected by an authorized Kia dealer.

Electronic Brake force Distribution (EBD) system warning light



These two warning lights appear at the same time while driving:

- When the ABS and regular brake system may not work normally.

In this case, have your vehicle inspected by an authorized Kia dealer.

WARNING

Electronic Brake force Distribution (EBD) System Warning Light

When both ABS and parking brake & brake fluid warning lights are on, the brake system will not work normally and you may experience an unexpected and dangerous situation during sudden braking.

In this case, avoid high speed driving and abrupt braking.

Have your vehicle inspected by an authorized Kia dealer as soon as possible.

Regenerative brake warning light

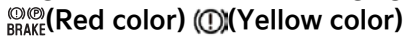

(Red color) (Yellow color)

This warning light appears:

When the regenerative brake does not operate and the brake does not perform well. This causes the Brake Warning light (red) and Regenerative Brake Warning Light (yellow) to appear simultaneously.

In this case, drive safely and have the vehicle inspected by an authorized Kia dealer.

The operation of the brake pedal may be more difficult than normal, and the braking distance can increase, as it may default to manual hydraulic mode.

Electric Power Steering (EPS) warning light

This warning light appears:

- When the EV button is in the ON position.
 - It remains on until the vehicle is started.
 - When there is a malfunction with the EPS.
- When there is a malfunction with the EPS.

In this case, have your vehicle inspected by an authorized Kia dealer.

Charging system warning light



This warning light appears:

- When the 12-volt battery level is low or a failure occurs on the charging system such as LDC.
- If the warning light turns on while driving, move the vehicle to a safe location, turn off and turn on the vehicle again, and check if the warning light turns off. If the warning light remains on, have your vehicle inspected by an authorized Kia dealer.
- Even if the warning light turns off, have the vehicle inspected by an authorized Kia dealer.

If you drive the vehicle while the warning light is on, vehicle speed may be limited and the 12-volt battery may be discharged.

* LDC: Low voltage DC-DC Converter.

High voltage battery low level warning light

This warning light appears:

- When the high voltage battery level is low.

When the warning light turns ON, charge the battery immediately.

Power down indicator light

This indicator appears:

- When the EV button is in the ON position.
 - It appears for approximately 3 seconds and then goes off.
- When the power is limited for the safety of the high-powered parts of an electric vehicle. The power is limited for the following reasons. (Unless both Service Warning Light and Power Down Indicator Light appear at the same time, it is not a failure.)
 - The high voltage battery level is too low or voltage is decreasing
 - The temperature of the high voltage battery is too high or too low
 - The temperature of the motor is high

* NOTICE

Do not accelerate or start the vehicle suddenly when the Power Down Indicator Light is ON.

Charge the battery immediately when the high voltage battery level is not enough.

*** NOTICE**

When the remaining battery power is low, the Power Down Indicator Light turns on and the output is limited. In that case, charge the battery immediately; otherwise, it could be difficult to climb hills or the vehicle may move backward.

Low tire pressure warning light



This warning light appears:

- When the EV button is in the ON position.
 - It appears for approximately 3 seconds and then goes off.
 - When one or more of your tires are significantly under inflated.
- * For more details, refer to "Tire Pressure Monitoring System (TPMS)" on page 8-6.

This warning light remains ON after blinking for approximately 60 seconds, or repeats blinking ON and OFF at the intervals of approximately 3 seconds:

- When there is a malfunction with the TPMS.

In this case, have your vehicle inspected by an authorized Kia dealer.
- * For more details, refer to "Tire Pressure Monitoring System (TPMS)" on page 8-6.

⚠ WARNING

Low Tire Pressure

- Significantly low tire pressure makes the vehicle unstable and can contribute to loss of vehicle control and increased braking distances.
- Continued driving on low pressure tires will cause the tires to overheat and fail.

⚠ WARNING

Safe Stopping

- The TPMS cannot alert you to severe and sudden tire damage caused by external factors.
- If you notice any vehicle instability, immediately take your foot off the accelerator pedal, apply the brakes gradually with light force, and slowly move to a safe position off the road.

Master warning light ⚠

This warning light informs the driver the following situations

- Forward Collision-Avoidance Assist malfunction
- Forward Collision-Avoidance Assist radar blocked
- Blind-Spot Collision-Avoidance Assist malfunction (if equipped)
- Blind-Spot Collision-Avoidance Assist radar blocked (if equipped)
- Smart Cruise Control malfunction
- Smart Cruise Control radar blocked
- Lamp malfunction
- High Beam Assist malfunction

To identify the details of the warning, look at the LCD display.

Electronic Parking Brake (EPB) warning light EPB

This warning light appears:

- When the EV button is in the ON position.
 - It appears for approximately 3 seconds and then goes off.
- When there is a malfunction with the EPB.

In this case, have your vehicle inspected by an authorized Kia dealer.

* NOTICE

Electronic Parking Brake (EPB) Warning Light

The Electronic Parking Brake (EPB) Warning Light may appear when the Electronic Stability Control (ESC) Indicator Light comes on to indicate that the ESC is not working properly (This does not indicate malfunction of the EPB).

LED headlamp warning light

This warning light appears:

- When the EV button is in the ON position.
 - It appears for approximately 3 seconds and then goes off.
- When there is a malfunction with the LED headlamp.

In this case, have your vehicle inspected by an authorized Kia dealer.

This warning light blinks:

- When there is a malfunction with a LED headlamp related part.

In this case, have your vehicle inspected by an authorized Kia dealer.

CAUTION

LED Headlamp Warning Light

Continuous driving with the LED Headlamp Warning Light on or blinking can reduce LED headlamp (low beam) life.

Forward Safety warning light

This warning light appears:

- When the EV button is in the ON position.
 - It appears for approximately 3 seconds and then goes off.
- When Forward Collision-Avoidance Assist is turned off.
- When ESC is turned off by pressing and holding the ESC OFF button
- When the radar sensor or cover is blocked with dirt or snow. Check the sensor and cover and clean them by using a soft cloth.
- When there is a malfunction with Forward Collision-Avoidance Assist. If this occurs, have your vehicle inspected by an authorized Kia dealer.

* For more details, refer to "Forward Collision-Avoidance Assist (FCA)" on page 7-4.

Icy road warning light

This warning light appears:

This warning light is to warn the driver the road may be icy. When the temperature on the outside temperature gauge is approximately below 4 °C (39 °F) the icy road warning light and outside temperature gauge blinks and then appears. Also, the warning chime sounds 1 time.

*** NOTICE**

If the icy road warning light appears while driving, you should drive more attentively and safely refraining from over-speeding, rapid acceleration, sudden braking or sharp turning, etc.

All Wheel Drive (AWD) warning light  (if equipped)

This warning light appears:

- Once you set the EV button to the ON position.
 - It appears for approximately 3 seconds and then goes off.
- When there is a malfunction with the AWD.

In this case, have your vehicle inspected by an authorized Kia dealer.

* For more details, refer to "All wheel drive (AWD) (if equipped)" on page 6-42.

Indicator lights

The indicator light indicates whether the various functions are activated.

Ready indicator light (READY)

This indicator appears:

When the vehicle is ready to be driven.

- ON: Normal driving is possible.
- OFF: Normal driving is not possible, or a problem has occurred.
- Blinking: Emergency driving.

When the ready indicator goes OFF or blinks, there is a problem with the system. In this case, have your vehicle inspected by an authorized Kia dealer.

Charging cable connection indicator light 

This indicator appears:

This indicator appears when the charging cable is connected.

Electronic Stability Control (ESC) indicator light 

This indicator light appears:

- When the EV button is in the ON position.
 - It appears for approximately 3 seconds and then goes off.
- When there is a malfunction with the ESC system.
 - In this case, have your vehicle inspected by an authorized Kia dealer.

This indicator light blinks:

While the ESC is operating.

* For more details, refer to "Electronic Stability Control (ESC)" on page 6-31.

Electronic Stability Control (ESC) OFF indicator light 

This indicator light appears:

- When the EV button is in the ON position.
 - It appears for approximately 3 seconds and then goes off.
- When you deactivate the ESC system by pressing the ESC OFF button.

* For more details, refer to "Electronic Stability Control (ESC)" on page 6-31.

Immobilizer indicator light (with smart key)

This indicator light appears for up to 30 seconds:

- When the vehicle detects the smart key in the vehicle with the EV button in the ACC or ON position.
 - Once the smart key is detected, you can start the vehicle (**READY** indicator ON).
 - The indicator light goes off after starting the vehicle (**READY** indicator ON).

This indicator light blinks for a few seconds:

- When the smart key is not in the vehicle.
 - At this time, you cannot start the vehicle.

This indicator light appears for 2 seconds and goes off:

- If the smart key is in the vehicle and the EV button is ON, but the vehicle cannot detect the smart key. In this case, have your vehicle inspected by an authorized Kia dealer.

This indicator light blinks:

- When the battery of the smart key is weak.
- When there is a malfunction with the immobilizer system. In this case, have your vehicle inspected by an authorized Kia dealer.

Turn signal indicator light

This indicator light blinks:

- When you turn the turn signal light on. If any of the following occurs, there may be a malfunction with the turn signal system.

In this case, have your vehicle inspected by an authorized Kia dealer.

- The indicator light does not blink but appears.
- The indicator light blinks more rapidly.
- The indicator light does not appear at all.

Low beam indicator light

This indicator light appears:

- When the headlights are on.

High beam indicator light

This indicator light appears:

- When the headlights are on and in the high beam position.
- When the turn signal switch is pulled into the Flash-to-Pass position.

High Beam Assist indicator light



This indicator light appears:

- When High Beam Assist is activated.
- * For more details, refer to "High Beam Assist (HBA)" on page 5-89.

Light ON indicator light

This indicator light appears:

- When the tail lights or headlights are on.

AUTO HOLD indicator light (AUTO HOLD)

This indicator light appears:

- White: When you activate the AUTO HOLD system by pressing the AUTO HOLD button.
- Green: When you stop the vehicle completely by depressing the brake pedal with the AUTO HOLD system activated.
- Yellow: When there is a malfunction with the AUTO HOLD system.

In this case, have the vehicle inspected by an authorized Kia dealer.

* For more details, refer to "AUTO HOLD" on page 6-27.

Lane Safety indicator light

This indicator light appears:

The Lane Safety indicator light will appear when you turn Lane Keeping Assist on by pressing and holding the Lane Driving Assist button.

If there is a problem with the function, the yellow Lane Safety indicator will appear.

* For more details, refer to "Lane Keeping Assist (LKA)" on page 7-23.

Lane Following Assist indicator



This indicator light appears:

Lane Following Assist indicator will appear when you turn Lane Following Assist on by pressing Lane Driving Assist button.

If there is a problem with the function, the yellow Lane Following Assist indicator will appear.

* For more details, refer to "Lane Following Assist (LFA)" on page 7-83.

Highway Lane Change Assist indicator light (if equipped)

This indicator light appears:

- Green: When Highway Lane Change Assist is ready for operation.
- Grey: When Highway Lane Change Assist is in standby.

This indicator light blinks:

- Green: When Highway Lane Change Assist is operating.
- White: When Highway Lane Change Assist is canceled.

* For more details, refer to "Highway Driving Assist (HDA) (if equipped)" on page 7-86.

Drive mode indicator light (ECO/NORMAL/SPORT/SNOW)

This indicator light appears:

- When you select each mode as drive mode.
- * For more details, refer to "Drive mode integrated control system" on page 6-37.

Battery conditioning mode indicator light

This indicator light appears:

- When Battery conditioning mode is activated.
- * For more details, refer to "Battery conditioning mode (if equipped)" on page 1-14.

Drift mode indicator light DRIFT (if equipped)

This indicator light appears:

- When drift mode is activated.
- * For more details, refer to "Drift Mode (For GT)" on page 6-40.

Augmented Reality HUD (if equipped)



The Head-Up Display projects the instrument cluster and navigation information onto the windshield.

Head-up display settings



A: Head-up display

- 1 Display mode
- 2 Augmented reality mode
- 3 Standard mode
- 4 Head-up display Off

Head-up display can be enabled from the Settings menu in the infotainment system screen. Select either **Augmented reality mode** or **Standard mode** from:

- **Setup** → **Vehicle** → **Head-up display** → **Display mode** → **Augmented reality mode/Standard mode**

After turning on the head-up display, you can change the settings of **Display control**, **AR matching adjustment** (When Augmented reality mode is selected) and **Content selection** of the Head-Up Display.

Head-up display information

AR mode display information

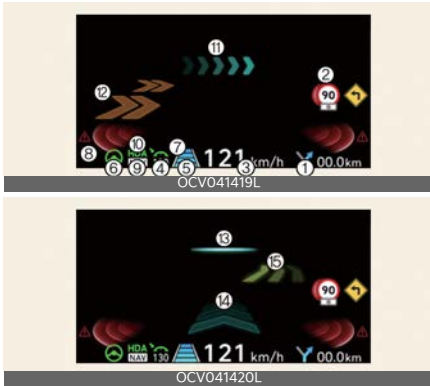

- 1 Turn By Turn (TBT) navigation information
- 2 Traffic information
- 3 Speedometer information
- 4 SCC set speed information
- 5 SCC vehicle distance information
- 6 Lane Following Assist information
- 7 Lane Safety information
- 8 Blind-Spot Safety information
- 9 Highway Auto Speed Change information
- 10 Highway Driving Assist information
- 11 Turn by turn (TBT) navigation information (AR)
- 12 Lane Safety information (AR)
- 13 Front Vehicle indicator (AR) (if Highway Lane Change Assist function equipped)
- 14 Leading Vehicle Departure Alert (AR)
- 15 Highway Lane Change Assist information (AR)

Standard mode display information



- 1 Turn By Turn (TBT) navigation information
- 2 Traffic information
- 3 Speedometer information
- 4 SCC set speed information
- 5 SCC vehicle distance information
- 6 Lane Following Assist information
- 7 Lane Safety information
- 8 Blind-Spot Safety information
- 9 Highway Auto Speed Change information
- 10 Highway Driving Assist information
- 11 Surrounding vehicle information

Precautions while using the head-up display

- It may sometimes be difficult to read information on the Head-Up Display in the following situations.
 - The driver is improperly positioned in the driver's seat
 - The driver wears polarizing-filter sunglasses
 - An object is located above the head-up display cover
 - The vehicle is driven on a wet road
 - Any improper lighting accessory is installed inside the vehicle, or there is incoming light from outside of the vehicle
 - The driver wears glasses
 - The driver wears contact lenses

- When it is difficult to read the Head-Up Display information, adjust the image position, brightness level or AR matching information from the Settings menu in the infotainment system screen.
- The AR mode display information may be difficult to recognize when the vehicle is driven under severe weather condition, such as heavy rain, heavy snow, low visibility, etc.
- Head-up display information may partially overlap the road ahead, causing fatigue and discomfort while driving. Adjust the image if you feel tired or uncomfortable, or if symptoms persist, turn off the head-up display.
- When the direct flash light or sunlight hits the front windshield, a warning message will appear. If the temperature of the front windshield keep rises, Head-up display will be deactivated temporarily to protect Head-up display from the high temperature. When the temperature drops, Head-up display will be reactivated.
- For your safety, make sure to stop the vehicle before adjusting the settings.
- Do not tint the front windshield glass or add other types of metallic coating. Otherwise, the Head-Up Display image may be invisible.
- Do not place any accessories on the crash pad or attach any objects on the windshield glass.
- When replacing the front windshield glass, replace it with a windshield glass designed for Head-Up Display operation. Otherwise, duplicated images may be displayed on the windshield glass.

WARNING

- The warning information of Blind-Spot Safety on the Head-Up Display are supplemental. Do not solely depend on them to change lanes. Always take a look around before changing lanes.

The driving route guidance display in the augmented reality mode is an auxiliary function. Be sure to check the navigation screen together.

- ALWAYS pay attention on the road while driving when the Head-Up Display is on.

* NOTICE

- AR mode is the basic setting for Head-up display.
For detailed information, refer to the separately supplied infotainment system manual.
- Standard Head-up display information may not be consistent based on the different system settings menu.

* NOTICE

Head-Up Display includes GPL, LGPL, MPL and other open source license softwares. To obtain the source code developed under the open source license installed on this product, please visit <http://www.mobis.co.kr/opensource/list.do>.

You can download all applicable license notices, including the source code.

If you send an e-mail to MOBIS_OSSrequest@mobis.co.kr within three (3) years of your purchase of the product to request an open source code for the software on this product, you will receive it in a CD-ROM and/or other storage

medium at a minimal charge (the charge will cover costs for the storage medium and delivery).

Lighting

This vehicle is equipped with a variety of lights to illuminate the interior and exterior of the vehicle.

Battery saver function

The purpose of this feature is to prevent the battery from being discharged if the lights are left in the ON position. The system automatically shuts off the parking lights after the vehicle is turned off and the driver's door is opened.

However, the position lamps stay ON even when the driver-side door is opened if the light switch is operated after the vehicle is turned off.

If necessary, to keep the lamps on turn the position lamps OFF and ON again using the headlamp switch on the steering column after the vehicle is turned off.

Headlight escort function

If you turn the EV button to the ACC or OFF position with the headlights ON, the headlights remain on for about 5 minutes.

However, if the driver's door is opened and closed, the headlights are turned off after 15 seconds.

The headlights can be turned off by pressing the lock button on the smart key one more time or turning the light switch to the OFF position.

Daytime running light (DRL)

The Daytime Running Lights can make it easier for others to see the front of your vehicle during the day.

DRL can be helpful in many different driving conditions, and it is especially helpful after dawn and before sunset.

The DRL system will turn the dedicated lamp OFF when:

- The headlight switch is on.
- The vehicle is off.
- Engaging the parking brake.

Lighting control

The light switch has a Headlight and a Parking light position.



To operate the lights, turn the knob at the end of the control lever to one of the following positions:

- 1 OFF position
- 2 AUTO light position
- 3 Position & Taillamp
- 4 Headlamp (Low beam)

Position & Taillamp



When the light switch is in the parking light position, the tail, license and instrument panel lights will turn ON.

Headlamp (Low beam)



When the light switch is in the headlamp (Low beam) position, the head, tail, license lights will turn ON.

* NOTICE

The EV button must be in the ON position to turn on the headlights.

AUTO light

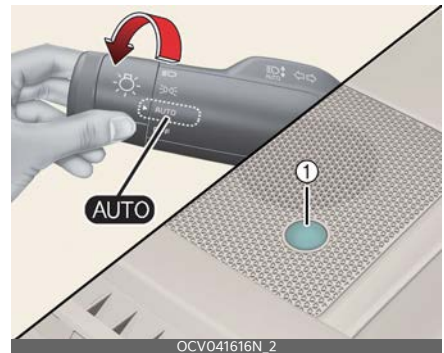

When the light switch is in the AUTO light position, the taillights and headlights will turn ON or OFF automatically depending on the amount of light outside the vehicle.

When the light switch is positioned at an auto light position, at first, the wiper will turn on and then, after 5 seconds the head lamp will turn on automatically.

If the head lamp has been turned on due to this function of the vehicle, the head lamp will turn off 60 seconds after the wiper has been turned off.

CAUTION

- Never place anything over the sensor (1) located on the instrument panel, as this will ensure better auto-light system control.
- Do not clean the sensor using a window cleaner. The cleaner may leave a light film which could interfere with sensor operations.
- If your vehicle has window tint or other types of metallic coating on the front windshield, the auto light system may not work properly.

Operating high beam



To turn on the high beam headlamp:

- Push the lever away from you.
The lever will return to its original position.
The high beam indicator will light when the headlight high beams are switched on.
To prevent the battery from being discharged, do not leave the lights on for a prolonged time while the vehicle is off.

WARNING

High Beams

Do not use high beam when there are other vehicles in front of or approaching your vehicle. Using high beam could obstruct the other driver's vision.

To flash the headlights:

- Pull the lever towards you.



It will return to the normal (low beam) position when released. The headlight switch does not need to be on to use this flashing feature.

Operating turn signals and lane change signals



The EV button must be on for the turn signals to function.

To turn on the turn signals:

- Move the lever up or down (A).
The green arrow indicators on the instrument panel indicate which turn signal is operating.
They will self-cancel after a turn is completed. If the indicator continues to flash after a turn, manually return the lever to the OFF position.

To signal a lane change:

- Move the turn signal switch slightly and hold it in position (B).
The lever will return to the OFF position when released.

If an indicator stays on and does not flash or if it flashes abnormally, one of the turn signal bulbs may be burned out and will require replacement.

One-touch lane change function

To activate a one-touch lane change function, move the turn signal lever slightly and then release it. The lane change signals will blink 3, 5 or 7 times. You can activate or deactivate the One Touch Turn Signal function or choose the number of blinking (3, 5, or 7) by selecting "Vehicle → Lights → One Touch Turn Signal".

* NOTICE

If an indicator flash is abnormally quick or slow, a bulb may be burned out or have a poor electrical connection in the circuit. The bulb may require replacement.

High Beam Assist (HBA)



High Beam Assist is a function that automatically adjusts the headlamp range (switches between high beam and low beam) depending on the brightness of detected vehicles and certain road conditions.

Detecting sensor

Front view camera



The front view camera is used as a detecting sensor to detect ambient light and brightness while driving. Refer to the picture above for the detailed location of the detecting sensor.

⚠ CAUTION

Always keep the front view camera in good condition to maintain optimal performance of High Beam Assist.

For more details on the precautions of the front view camera, refer to "Forward Collision-Avoidance Assist (FCA)" on page 7-4.

High Beam Assist Setting

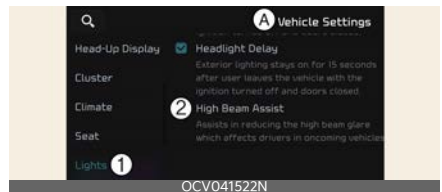

A: Vehicle Settings

1 Lights

2 High Beam Assist

With the vehicle in the ON position, select **Setup** → **Vehicle** → **Lights** → **High Beam Assist** from the Settings menu to turn on High Beam Assist function.

⚠ WARNING

For your safety, change the settings only after parking the vehicle at a safe location.

High Beam Assist operation

- After selecting **High Beam Assist** in the **Settings** menu, High Beam Assist will operate by following the procedure below.
 - Place the headlamp switch in the AUTO position and push the headlamp lever towards the instrument cluster. The High Beam Assist (HBA) indicator light will appear on the cluster and the function will be enabled.
 - When the function is enabled, high beam will turn on when vehicle speed is above 40 km/h (25 mph). The High Beam (HB) indicator light will appear on the cluster when high beam is on. When vehicle speed is below 25 km/h (15 mph), high beam will not turn on, and the white High Beam Assist (HBA) indicator will appear.
- When High Beam Assist is operating, if the headlamp lever or switch is used, the function operates as follow:
 - If the headlamp lever is pulled towards you when the high beam is off, the high beam will turn on. When you let go of the headlamp lever, High Beam Assist will turn on again.
 - If the headlamp lever is pulled towards you when the high beam is on, the low beam will turn on and High Beam Assist will be canceled.
 - If you push the light switch towards the instrument cluster, high beam is

turned on and High Beam Assist is released.

- If the headlamp switch is placed from AUTO to another position (headlamp/position/off), High Beam Assist will turn off and the corresponding lamp will turn on.
- When High Beam Assist is operating, high beam switches to low beam if any of the following conditions occur:
 - When the headlamp of an oncoming vehicle is detected.
 - When the tail lamp of a vehicle in front is detected.
 - When the headlamp or tail lamp of a motorcycle or a bicycle is detected.
 - When the surrounding ambient light is bright enough that high beams are not required.
 - When streetlights or other lights are detected.

* NOTICE

Depending on the instrument cluster specifications or theme, images or colors may be displayed differently.

High Beam Assist Malfunction and limitations

High Beam Assist Malfunction

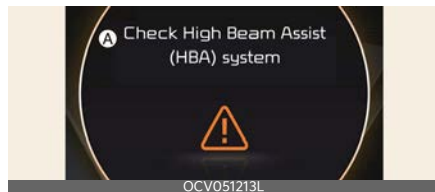

A: Check High Beam Assist (HBA) system

When High Beam Assist is not working properly, the warning message will

appear and warning light (⚠) will appear on the cluster. Have your vehicle inspected by an authorized Kia dealer.

Limitations of High Beam Assist

- Light from a vehicle is not detected because of lamp damage, or because it is hidden from sight, etc.
- Headlamp of a vehicle is covered with dust, snow or water.
- A vehicle's headlamps are off but the fog lamps are on and etc.
- There is a lamp that has a similar shape as a vehicle's lamp.
- Headlamps have been damaged or not repaired properly.
- Headlamps are not aimed properly.
- Driving on a narrow curved road, rough road, uphill or downhill.
- Vehicle in front is partially visible on a crossroad or curved road.
- There is a traffic light, reflecting sign, flashing sign or mirror ahead.
- There is a temporary reflector or flash ahead (construction area).
- The road conditions are bad such as being wet, iced or covered with snow.
- A vehicle suddenly appears from a curve.
- The vehicle is tilted from a flat tire or is being towed.
- Light from a vehicle is not detected because of exhaust fume, smoke, fog, snow, etc.

* NOTICE

For more details on the limitations of the front view camera, refer to "Forward Collision-Avoidance Assist (FCA)" on page 7-4.

⚠ WARNING

- At times, High Beam Assist may not work properly. The function is for your convenience only. It is the responsibility of the driver for safe driving practices and always check the road conditions for your safety.
- When High Beam Assist does not operate normally, change the headlamp position manually between high beam and low beam.

Wipers and washers

The wipers and washers remove foreign substances from the windshield and rear window, helping to maintain visibility.

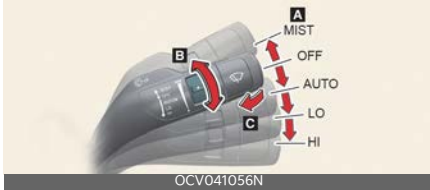

A: Wiper speed control (front)

- MIST - Single wipe
- OFF - Off
- AUTO - Auto control wipe
- LO - Low wiper speed
- HI - High wiper speed

B: Auto control wipe time adjustment

C: Wash with brief wipes

Windshield washers

Operates as follows when the EV button is turned ON.

MIST: For a single wiping cycle, move the lever to this (MIST) position and release it. The wipers will operate continuously if the lever is held in this position.

OFF: Wiper is not in operation

LO: Normal wiper speed

HI: Fast wiper speed

CAUTION

If there is heavy accumulation of snow or ice on the windshield, defrost the windshield for about 10 minutes, or until the snow and/or ice is removed before using the windshield wipers to ensure proper operation. If you do not remove the snow and/or ice before using the wiper and washer, it may damage the wiper and washer system.

Auto control

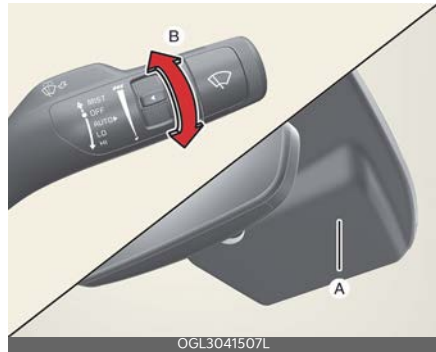

The rain sensor (A) located on the upper end of the windshield glass senses the amount of rainfall and controls the wiping cycle for the proper interval. The more it rains, the faster the wiper operates. When the rain stops, the wiper stops.

To vary the speed setting, turn the speed control knob (B).

If the wiper switch is set in AUTO mode when the EV button is ON, the wiper will operate once to perform a self-check of the system. Set the wiper to OFF position when the wiper is not in use.

CAUTION

When the EV button is ON and the windshield wiper switch is placed in the AUTO mode, use caution in the following situations to avoid any injury to the hands or other parts of the body:

- Do not touch the upper end of the windshield glass facing the rain sensor.
- Do not wipe the upper end of the windshield glass with a damp or wet cloth.
- Do not put pressure on the windshield glass.

CAUTION

- When washing the vehicle, set the wiper switch in the OFF position to stop the auto wiper operation.
The wiper may operate and be damaged if the switch is set in the AUTO mode while washing the vehicle.
- Do not remove the sensor cover located on the upper end of the passenger side windshield glass. Damage to system parts could occur and may not be covered by your vehicle warranty.
- When starting the vehicle in winter, set the wiper switch in the OFF position. Otherwise, wipers may operate and ice may damage the windshield wiper blades. Always remove all snow and ice and defrost the windshield properly prior to operating the windshield wipers.
- When tinting the windshield, be careful of any fluid getting into the sensor located in the top center of the front windshield. It may damage the related parts.

Operating windshield washer

Use this function when the windshield is dirty.



1. Move the wiper speed control switch to the OFF position.
2. Pull the lever gently toward you to spray washer fluid on the windshield and to run the wipers 1~3 cycles.

The spray and wiper operation will continue until you release the lever.
If the washer does not work, check the washer fluid level. If the fluid level is not sufficient, you will need to add appropriate non-abrasive windshield washer fluid to the washer reservoir.

The reservoir filler neck is located in the front of the motor compartment on the passenger side.

CAUTION**Washer Pump**

To prevent possible damage to the washer pump, do not operate the washer when the fluid reservoir is empty.

WARNING**Obscured Visibility**

Do not use the washer in freezing temperatures without first warming the windshield with the defrosters; the washer solution could freeze on the windshield and obscure your vision.

CAUTION**Wipers & Windshields**

- To prevent possible damage to the wipers or windshield, do not operate the wipers when the windshield is dry.
- To prevent damage to the wiper blades, do not use gasoline, kerosene, paint thinner, or other solvents on or near them.
- To prevent damage to the wiper arms and other components, do not attempt to move the wipers manually.

Interior lights

This vehicle is equipped with lights throughout the vehicle to illuminate the interior.

Do not use the interior lights for extended periods when the vehicle is off. It may cause battery discharge.

⚠ WARNING

Interior Lights

Do not use the interior lights when driving in the dark. Accidents could happen because the view may be obscured by interior lights.

Automatic turn off function (if equipped)

The interior lights automatically turn off approximately 20 minutes after the EV button is turned off, if the lights are in the ON position.

If your vehicle is equipped with the theft alarm system, the interior lights automatically turn off approximately 5 seconds after the system is armed.



Room lamp



- : The light stays on at all times.

Map lamp



- Press the lens (1) to turn ON the map lamp.
To turn the map lamp OFF press the lens (1) again.
-  (2): DOOR mode
 - The map lamp and room lamp come on when a door is opened. The lamps go out after approximately 30 seconds.
 - The map lamp and room lamp come on for approximately 30 seconds when doors are unlocked with a transmitter or smart key as long as the doors are not opened.
 - The map lamp and room lamp will stay on for approximately 20 minutes if a door is opened with the EV button in the ACC or LOCK/OFF position.
 - The map lamp and room lamp will stay on continuously if the door is opened with the EV button in the ON position.
 - The map lamp and room lamp will go out immediately if the EV button is changed to the ON position or all doors are locked.
 - To turn off the DOOR mode, press the DOOR button (2) once again (not pressed).
-  (3): Press this switch to turn the front and rear room lamps on and off.

*** NOTICE**

The DOOR mode and ROOM mode cannot be selected at the same time.

Liftgate room lamp

The liftgate room lamp comes on when the liftgate is opened.



*** NOTICE**

The liftgate lamp comes on as long as the liftgate lid is open. To prevent unnecessary charging system drain, close the liftgate lid securely after using the liftgate.

Vanity mirror lamp



- Push the switch to turn the light on or off.
 - ☰: The lamp will turn on if this button is pressed.
 - ○: The lamp will turn off if this button is pressed.

⚠ CAUTION

Vanity Mirror Lamp

Always have the switch in the off position when the vanity mirror lamp is not in use. If the sun visor is closed without the lamp off, it may discharge the battery or damage the sun visor.

Glove box lamp



The glove box lamp comes on when the glove box is opened.

⚠ CAUTION

To prevent unnecessary charging system drain, close the glove box securely after using the glove box.

Charging inlet lamp

The charging inlet lamp comes on when the charging door is opened.



*** NOTICE**

The charging inlet lamp comes on as long as the charging door is open. To prevent unnecessary charging system drain, close the charging door securely after using the charger.

Welcome system

The welcome system is a function that illuminates the surroundings or the interior when the driver approaches or exits the vehicle.

Headlight (Headlamp) escort function

The headlights (and/or taillights) remain on for approximately 5 minutes after the vehicle is turned off. However, if the driver's door is opened and closed, the headlights are turned off after 15 seconds.

The headlights can be turned off by pressing the lock button on the transmitter or smart key twice or turning off the light switch from the headlight or Auto light position.

Interior light

When the interior light switch is in the DOOR position and all doors (and liftgate) are locked and closed, the room lamp will come on for 30 seconds if any of the following occurs.

- With the smart key system
 - When the door unlock button is pressed on the smart key.
 - When the button of the outside door handle is pressed.

At this time, if you press the door lock button, the lamps will turn off immediately.

Body silhouette lamp



When all doors are locked and closed, the body silhouette lamp will come on for 15 seconds if any of the below is performed.

- With the smart key system
 - When the door unlock button is pressed on the smart key.
 - Approaching a vehicle with a smart key within 1.5 m (5 ft)
 - When the button of the outside door handle is pressed.

At this time, if you press the door lock button, the lamps will turn off immediately.

If the welcome mirror/light settings are not activated in the infotainment system or the liftgate is opened, the body silhouette lamp will not turn on.

Defroster

The vehicle is equipped with a defroster for removing frost or fog from the rear window.

⚠ CAUTION

Conductors

To prevent damage to the conductors bonded to the inside surface of the rear window, never use sharp instruments or window cleaners containing abrasives to clean the window.

If you want to defrost and defog the front windshield, refer to "Windshield defrosting and defogging" on page 5-108.

Operating rear window defroster

The defroster heats the window to remove frost, fog and thin ice from the rear window, while the vehicle is on.

If there is heavy accumulation of snow on the rear window, brush it off before operating the rear defroster.



To activate the rear window defroster:

- Press the rear window defroster button located in the center fascia switch panel.

The indicator on the rear window defroster button appears when the defroster is ON.

The rear window defroster automatically turns off after approximately 20 minutes or when the EV button is turned off.

To turn off the defroster:

- Press the rear window defroster button again.

Outside mirror defroster (if equipped)

If your vehicle is equipped with the outside rearview mirror defrosters, they will operate at the same time you turn on the rear window defroster.

Automatic climate control system

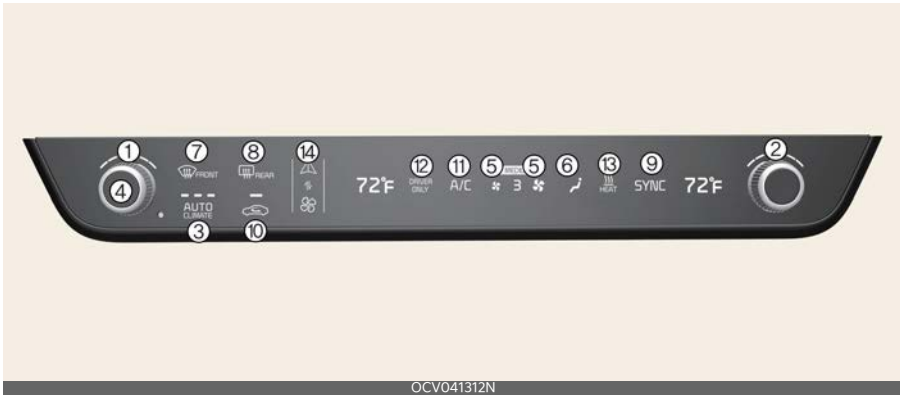

- 1 Driver's temperature control knob
- 2 Passenger's temperature control knob
- 3 AUTO (automatic control) button
- 4 OFF button
- 5 Fan speed control button
- 6 Mode selection button
- 7 Front windshield defroster button
- 8 Rear window defroster button
- 9 SYNC button
- 10 Air intake control button
- 11 Air conditioning (A/C) button
- 12 DRIVER ONLY select button
- 13 HEAT button
- 14 Infotainment/climate control mode switching button

* NOTICE

Operating the blower when the EV button is in the OFF position could cause the battery to discharge. Operate the blower when the vehicle is in ON position.

Using the infotainment/climate switchable controller

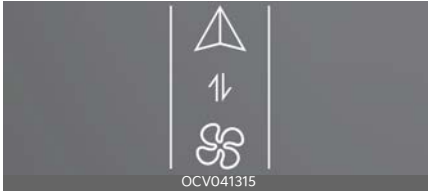

Press the button on the switchable controller to switch between infotainment system or climate control panel.

Press and hold the button to select the default mode for the control panel.

Switching between panels

Infotainment control panel



Climate control panel



Press the button on the switchable controller to select the desired control panel.

The selected control panel icon will appear and the control panel will be changed.

- The knob display will appear according to the selected control panel mode.

- When the vehicle is in the ACC position, only the infotainment system will be activated.

Setting the default mode



Press and hold the button to select the default mode for the control panel.

- After the setting, the control panel will return to the default mode after a certain period of time even if the control panel is switched to the different mode.
- If the mode is set to 'OFF', the control panel will display the mode used recently.

Heating and air conditioning automatically

1. Press the AUTO button.

The modes, fan speeds, air intake and air-conditioning will be controlled automatically by setting the temperature.



2. Turn the temperature control switch to the desired temperature.



- To turn the automatic operation off, select any button or switch of the following:
 - Mode selection button
 - Air conditioning button
 - Front windshield defroster button (Press the button one more time to deselect the front windshield defroster function. The 'AUTO' sign will appear on the information display once again.)
 - Air intake control button
 - Fan speed control switch

The selected function will be controlled manually while other functions operate automatically.

- For your convenience and to improve the effectiveness of the climate control, use the AUTO button and set the temperature to 22 °C (72 °F).

*** NOTICE**

Do not place anything over the sensor located on the instrument panel to ensure better control of the heating and cooling system.



Level	Indicator	LCD Display	Air flow
High			2-8
Medium			1-6
Low			1-4

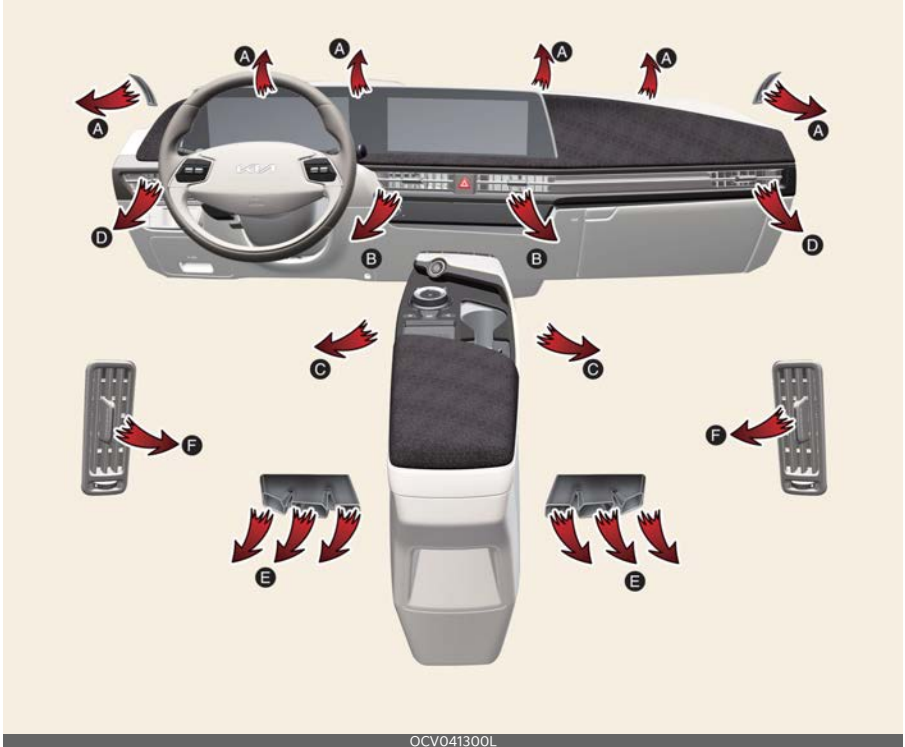

Heating and air conditioning manually

The heating and cooling system can be controlled manually by pressing buttons or turning knob(s) other than the AUTO button.



OCV041300L

In this case, the system works sequentially according to the order of buttons or knob(s) selected.

1. Start the vehicle.
2. Set the mode to the desired position.
 - For improving the effectiveness of heating and cooling;
 - Heating: 
 - Cooling: 
3. Set the temperature control to the desired position.
4. Set the air intake control to the outside (fresh) air position.
5. Set the fan speed control to the desired speed.

If air conditioning is desired, turn the air conditioning system on.

Press the AUTO button in order to convert to full automatic control of the system.

Mode selection

The mode selection button controls the direction of the air flow through the ventilation system.



The air flow outlet port is directed as follows:



Face-Level (B, D, F)

Air flow is directed toward the upper body and face. Additionally, each outlet can be controlled to direct the air discharged from the outlet.

Bi-Level (B, C, D, E, F)

Air flow is directed towards the face and the floor.

Floor-Level (A, C, D, E)

Most of the air flow is directed to the floor, with a small amount of the air being directed to the windshield and side window defrosters.

Floor/Defrost-Level (A, C, D, E)

Most of the air flow is directed to the floor and the windshield with a small amount directed to the side window defrosters.

Instrument panel vents

Front



Rear



The outlet vents can be opened or closed by moving the vent left or right. Also, you can adjust the direction of air delivery from these vents using the vent control lever as shown.

Temperature control



The temperature will increase to the maximum (HI) by turning the knob to the extreme right.

The temperature will decrease to the minimum (LO) by turning the knob to the extreme left.

When turning the knob, the temperature will increase or decrease by 1 °F/0.5 °C. When set to the lowest temperature setting, the air conditioning will operate continuously.

*** NOTICE**

When starting the vehicle in cold weather using manual temperature control, operate the system in the following method to improve heating.

- Turn off or lower the blower, right after starting the vehicle.
- Allow the vehicle to warm up during this time since the air flow from the heater is still cold.
- After a few minutes of vehicle warm up, turn on or set the fan to a higher level and adjust the temperature setting to hot.

Temperature conversion

You can switch the temperature mode from Centigrade to Fahrenheit as follows:

Go to **Setup** → **Units** → **Temperature** on the infotainment system.

For detailed information, refer to the separately supplied infotainment system manual.

*** INFORMATION**

The infotainment system may change after software updates. For more information, refer to the user's manual provided in the infotainment system and the quick reference guide.

Controlling air intake

This is used to select the outside (fresh) air position or recirculated air position.



To change the air intake control position:

- Push the control button.

Outside (fresh) air position



With the outside (fresh) air position selected, air enters the vehicle from outside and is heated or cooled according to the function selected. The indicator light will turn off.

Recirculated air position



With the recirculated air position selected, air from the passenger compartment will be drawn through the heating system and heated or cooled according to the function selected. Prolonged operation of the heater in the recirculated air position (without air con-

ditioning selected) may cause fogging of the windshield and side windows and the air within the passenger compartment may become stale.

In addition, prolonged use of the air conditioning with the recirculated air position selected will result in excessively dry air in the passenger compartment.

*** NOTICE**

Operating the system primarily in Fresh mode is recommended. Use Recirculation mode temporarily only when needed. Prolonged operation of the heater in Recirculation mode and without the air conditioning ON can cause fogging of the windshield. In addition, prolonged use of the air conditioning ON in Recirculation mode may result in excessively dry, dehumidified air in the cabin and may promote formation of musty vent odor due to stagnant air.

Controlling fan speed

The fan speed can be set to the desired speed by operating the fan speed control switch.

To change the fan speed:

- Press right for higher speed, or press left for lower speed.



- To turn the fan speed control off, press the OFF knob.

Air conditioning



- Press the A/C button to turn the air conditioning system on (indicator light will appear).
- Press the button again to turn the air conditioning system off.

WARNING

Reduced Visibility

Continuous use of the climate control system in the recirculated air position may allow humidity to increase inside the vehicle, which may fog the glass and obscure visibility.

WARNING

Recirculated Air

Continued use of the climate control system in the recirculated air position can cause drowsiness or sleepiness, and loss of vehicle control. Set the air intake control to the outside (fresh) air position as much as possible while driving.

WARNING

Sleeping with A/C on

Do not sleep in a vehicle with the air conditioning or heating on, as this may cause serious harm or death due to a drop in the oxygen level and/or body temperature.

* NOTICE

Operating the fan when the EV button is in the OFF position could cause the battery to discharge. Operate the fan when the vehicle is running.

Turning heating on or off

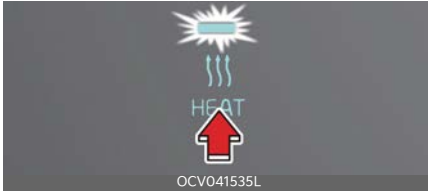

- Push the HEAT button to turn the heater on (indicator light will appear).
- Push the button again to turn the heater off.

The air conditioner and heater uses energy from the battery. If you use the heater or air conditioner for too long, distance to empty can be reduced due to increased power consumption.

Turn off the heater or air conditioner if not necessary.

Air conditioning for driver only



- Press the DRIVER ONLY button and the indicator light appears, cold air mostly blows in the direction of the driver's seat. However, some of the cold air may come out of other seats' ducts to keep indoor air pleasant.

Turning off the front air climate control



- Press the OFF knob to turn off the front air climate control system. However, you can still operate the air intake buttons as long as the EV button is in the ON position.

System operation

Ventilation

1. Set the mode to the (🌀) position.
2. Set the air intake control to the outside (fresh) air position.
3. Set the temperature control to the desired position.
4. Set the fan speed control to the desired speed.

Heating

1. Set the mode to the (🔥) position.
2. Set the air intake control to the outside (fresh) air position.
3. Set the temperature control to the desired position.
4. Set the fan speed control to the desired speed.
5. If dehumidified heating is desired, turn the air conditioning system (if equipped) on.
 - If the windshield fogs up, set the mode to the (🌀) or (🔥) position.

Heating operation tips

- To keep dust or unpleasant fumes from entering the vehicle through the ventilation system, temporarily set the air intake control to the recirculated air position. Be sure to return the control to the fresh air position when the irritation has passed to keep fresh air in the vehicle. This will help keep the driver alert and comfortable.
- Air for the heating/cooling system is drawn in through the grilles just ahead of the windshield. Care should be taken that these are not blocked by leaves, snow, ice or other obstructions.
- To prevent interior fog on the windshield, set the air intake control to the fresh air position and fan speed to the desired position, turn on the air conditioning system, and adjust the temperature control to desired temperature.

Air conditioning

All Kia air conditioning systems are filled with R-1234yf refrigerant.

1. Start the vehicle. Press the air conditioning button.
2. Set the mode to the (↔) position.
3. Set the air intake control to the outside-air or recirculated air position.
4. Adjust the fan speed control and temperature control to maintain maximum comfort.
 - When maximum cooling is desired, set the temperature control to the extreme left position, then set the fan speed control to the highest speed.

⚠ CAUTION

- The refrigerant system should only be serviced by trained and certified technicians to insure proper and safe operation.
- The refrigerant system should be serviced in a well-ventilated place.
- The air conditioning evaporator (cooling coil) shall never be repaired or replaced with one removed from a used or salvaged vehicle and new replacement MAC evaporators shall be certified (and labeled) as meeting SAE Standard J2842.

⚠ CAUTION

- When using the air conditioning system, monitor the temperature gauge closely while driving up hills or in heavy traffic when outside temperatures are high. Air conditioning system operation may cause vehicle overheating. Continue to use the blower fan but turn the air conditioning system off if the temperature gauge indicates vehicle overheating.
- When opening the windows in humid weather, air conditioning may create water droplets inside the vehicle. Since excessive water droplets may cause damage to electrical equipment, air conditioning should only be used with the windows closed.

Air conditioning operation tips

- If the vehicle has been parked in direct sunlight during hot weather, open the windows for a short time to let the hot air inside the vehicle escape.

- To help reduce moisture inside of the windows on rainy or humid days, decrease the humidity inside the vehicle by operating the air conditioning system.
- During air conditioning system operation, you may occasionally notice a slight change in vehicle speed as the air conditioning compressor cycles. This is a normal system operation characteristic.
- Use the air conditioning system at least every month only for a few minutes to ensure maximum system performance.
- When using the air conditioning system, you may notice clear water dripping (or even puddling) on the ground under the passenger side of the vehicle. This is a normal system operation characteristic.
- Operating the air conditioning system in the recirculated air position provides maximum cooling; however, continual operation in this mode may cause the air inside the vehicle to become stale.
- During cooling operation, you may occasionally notice a misty air flow because of rapid cooling and humid air intake. This is a normal system operation characteristic.

Climate control air filter

The climate control air filter installed inside the motor room compartment filters the dust or other pollutants that come into the vehicle from the outside through the heating and air conditioning system.

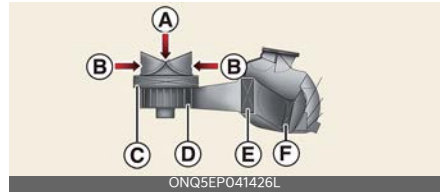

- A: Outside air
- B: Recirculated air
- C: Climate control air filter
- D: Blower
- E: Evaporator core
- F: Heater core

If dust or other pollutants accumulate in the filter over a period of time, the air flow from the air vents may decrease, resulting in moisture accumulation on the inside of the windshield even when the outside (fresh) air position is selected. If this happens, have the climate control air filter replaced by an authorized Kia dealer.

* NOTICE

- Replace the filter according to the Maintenance Schedule. If the vehicle is being driven in severe conditions, such as dusty or rough roads, more frequent air conditioner filter inspections and changes are required.
- When the air flow rate suddenly decreases, the system should be checked at an authorized Kia dealer.

Checking the amount of air conditioner refrigerant and compressor lubricant

When the amount of refrigerant is low, the performance of the air conditioning is reduced. Overfilling also has a negative impact on the air conditioning system.

Therefore, if abnormal operation is found, have the system inspected by an authorized Kia dealer.

⚠ WARNING

The oil and refrigerant in your vehicle's air conditioning system is under very high pressure. If proper service procedures are not followed an explosion may result. To reduce the risk of serious injury or death, the air conditioning system in your vehicle should only be serviced by trained and certified technicians.

⚠ WARNING

Vehicles equipped with R-1234yf



Since the refrigerant is mildly flammable and operated at high pressure, the air conditioning system should only be serviced by trained and certified technicians. (Refer to the SAE J2845)

It is important that the correct type and amount of oil and refrigerant are used. All refrigerants should be reclaimed with proper equipment. Venting refrigerants directly to the atmosphere is harmful to individuals and environment.

Failure to heed these warnings can lead to serious injuries.

Windshield defrosting and defogging

When the windshield is covered with frost or moisture, the front view is blurred, you should remove the frost and moisture.

⚠ WARNING

Windshield Heating

Do not use the (☀) or (☁) position during cooling operation in extremely humid weather. The difference between the temperature of the outside air and the windshield could cause the outer surface of the windshield to fog up, causing loss of visibility. In this case, set the mode selection to the (🌀) position and fan speed control to the lower speed.

- For maximum defrosting, set the temperature control to the extreme right/hot position and the fan speed control to the highest speed.
- If warm air to the floor is desired while defrosting or defogging, set the mode to the floor-defrost position.
- Before driving, clear all snow and ice from the windshield, rear window, outside rear view mirrors, and all side windows.
- Clear all snow and ice from the hood and air inlet in the cowl grill to improve heater and defroster efficiency and to reduce the probability of fogging up the inside of the windshield.

Defrosting outside windshield with automatic climate control

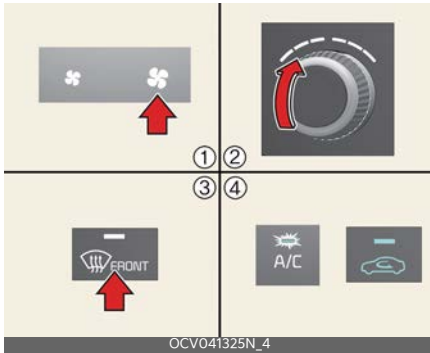

1. Set the fan speed to the highest position.
2. Set the temperature to the extreme hot (HI) position.
3. Press the defroster button (☀️).
4. The outside (fresh) air position will be selected automatically and the air conditioning will turn on according to the detected ambient temperature.

Defogging inside windshield with automatic climate control

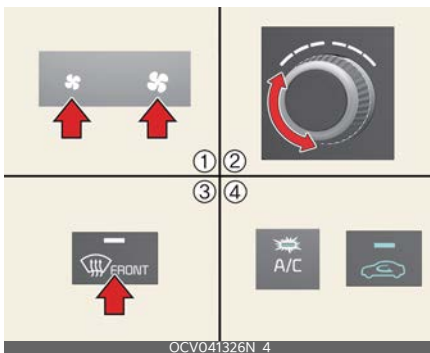

1. Set the fan speed to the desired position.
2. Select desired temperature.
3. Press the defroster button (☀️).

4. The outside (fresh) air position will be selected automatically and the air conditioning will turn on according to the detected ambient temperature.

If the air conditioning and outside (fresh) air position are not selected automatically, adjust the corresponding button manually. If the (🔄) position is selected, lower fan speed is adjusted to a higher fan speed.

Defogging logic (if equipped)

To reduce the possibility of fogging up the inside of the windshield, the air intake or air conditioning is controlled automatically according to certain conditions such as (🔄) or (☀️) position.

To cancel automatic defogging logic or return to the automatic defogging logic, do the following.

Turning the defogging logic on or off

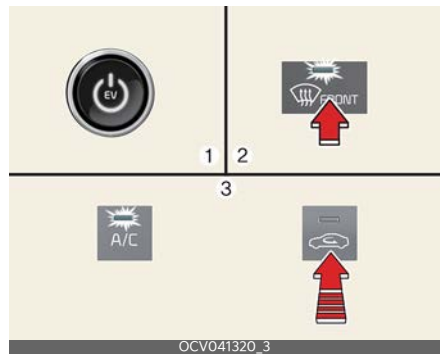

1. Turn the EV button to the ON position.
2. Press the defroster button (☀️).
3. While pressing the air conditioning button (A/C), press the air intake control button at least 5 times within 3 seconds.

The recirculation indicator blinks 3 times in 0.5 second of intervals. It indicates

that the defogging logic is canceled or returned to the programmed status. If the battery has been discharged or disconnected, it resets to the defog logic status.

Auto Defogging System (ADS)

Auto defogging reduces the probability of fogging up the inside of the windshield by automatically sensing the moisture of inside the windshield.



The auto defogging system operates when the heater or air conditioning is on. The indicator appears when the auto defogging system senses the moisture on the inside of the windshield and operates.

The auto defogging system addresses excess moisture on the inside of the windshield in stages. For example if auto defogging does not defog inside the windshield at step • Outside air position, it tries to defog again at step • Operating the air conditioning.

- Outside air position
- Operating the air conditioning
- Increasing air flow toward the windshield
- Blowing air flow toward the windshield

Turning the auto defogging system on or off

- Press the front windshield defroster button for 3 seconds when the EV button is in the ON position.

When the ADS system is canceled, the defroster button indicator will blink 3 times per 0.5 sec.

When the ADS system is reset, the defroster button indicator will blink 6 times per 0.25 sec.

⚠ CAUTION

Do not remove the sensor cover located on the upper end of the passenger side windshield glass. Damage to the system parts could occur and may not be covered by your vehicle warranty.

Automatic ventilation

The system automatically selects the outside (fresh) air position when the climate control system operates over a certain period of time (5 minutes) in low temperature with the recirculated air position selected.

To cancel or reset the Automatic Ventilation

When the air conditioning system is on, select Face Level (↔) mode and press the recirculated air position button more than five times within 3 seconds while pressing A/C button.

When the automatic ventilation is canceled, the indicator blinks 3 times. When the automatic ventilation is activated, the indicator blinks 6 times.

Smart ventilation (if equipped)

The smart ventilation system maintains pleasant/fresh air conditioning inside the passenger compartment by automatically detecting/controlling the temperature and humidity level, when you drive the vehicle with the climate control system in OFF position. When the smart ventilation system starts to operate, the

message appears for approximately 5 seconds.

The smart ventilation system stops when:

- OFF button is selected.
- Any of the buttons of the climate control is selected for operation.

* NOTICE

The smart ventilation system may not operate when the vehicle is driven at low speed.

A/C Automatic Drying

A/C Automatic Drying feature dries the moisture in the air conditioner and reduces air conditioner odor. The blower motor automatically operates after 30 minutes the vehicle is turned off.

Turning A/C Automatic Drying on or off

The A/C Automatic Drying feature can be turned on and off by selecting **Setup** → **Climate** → **Climate Features** → **A/C Automatic Drying** from the infotainment system. See additional information in supplied infotainment manual. If the operating condition is satisfied, a message **Air Conditioning Automatic Drying will start in 30 minutes** will be displayed on the infotainment/climate switchable controller screen and then the blower motor will automatically operate on schedule.

When the A/C Automatic Drying feature is activated, the air conditioner sets the fan speed to the third level, selects Fresh mode, and directs the air flow to the floor.

Operating conditions

The A/C Automatic Drying feature operates under the following conditions:

- The vehicle is turned off after operating the air conditioner for a certain period
- The 12-volt battery level is sufficient
- The outside temperature is above a certain level

Non-operating conditions

The A/C Automatic Drying feature stops operating under the following conditions:

- The A/C Automatic Drying feature has operated for 3 minutes
- The EV button is pressed, or the vehicle is ON
- The climate control system is operated remotely

* NOTICE

- The A/C Automatic Drying feature reduces air conditioner odors but may not remove all odors.
- The A/C Automatic Drying feature does not operate if the remaining battery level is insufficient to prevent battery discharge.

* INFORMATION

The infotainment system may change after software updates. For more information, refer to the user's manual provided in the infotainment system and the quick reference guide.

Storage compartment

These compartments can be used to store small items required by the driver or passengers.

- To avoid possible theft, do not leave valuables in the storage compartment.
- Always keep the storage compartment covers closed while driving. Do not attempt to place so many items in the storage compartment that the storage compartment cover cannot close securely.

⚠ WARNING

Flammable Materials

Do not store glasses, gas lighter, portable battery, canned beverage, spray can, propane cylinder, cosmetic tube or other flammable/explosive materials in the vehicle. These items may catch fire and/or explode if the vehicle is exposed to hot temperatures for extended periods.

Center console storage



To open the center console storage:

- Pull up the lever.

Glove box

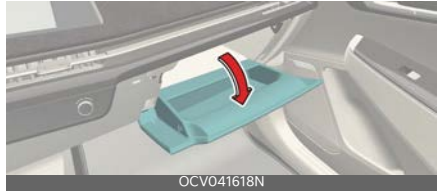

To open the glove box:

- Push the lever and the glove box will automatically open.
- Close the glove box after use.

⚠ WARNING

Glove Box

To reduce the risk of injury in an accident or sudden stop, always keep the glove box door closed while driving.

*** NOTICE**

If the temperature control switch is in the warm or hot position, warm or hot air will flow into the glove box.

Luggage board (if equipped)



You can place tools, etc. in the box for easy access. (if equipped)

- Grasp the handle on the edge of the cover and lift it.

Interior features

There are various features inside the vehicle for the convenience of the occupants.

Ambient light (if equipped)



The ambient lights are installed in the front crash pad, front doors, and the top/bottom of the center console.

Cup holder



Cups or small beverage cans may be placed in the cup holders.

⚠ WARNING

Hot Liquids

Do not place uncovered cups with hot liquid in the cup holder while the vehicle is in motion. If the hot liquid spills, you may burn yourself. Such a burn to the driver could lead to loss of control of the vehicle.

⚠ CAUTION

- Keep your drinks sealed while driving to prevent spilling your drink. If liquid spills, it may get into the vehicle's electrical/electronic system and damage electrical/electronic parts.
- When cleaning spilled liquids, do not use heat to dry the cup holders. This may damage the cup holder.

⚠ CAUTION

Be careful not to spill drinks in the cup holder. The cup holder may not work.

Seat warmer (if equipped)

The seat warmer is provided to warm the front and rear (if equipped) seats during cold weather.

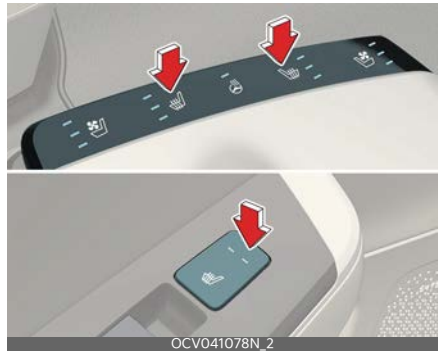

With the EV button in the ON position:

- Push either of the buttons to warm the front and rear (if equipped) seats.

During mild weather or under conditions where the operation of the seat warmer is not needed, keep the buttons in the "OFF" position.

Temperature control (Manual)

Each time you press the button, the temperature setting of the seat will change as follows:

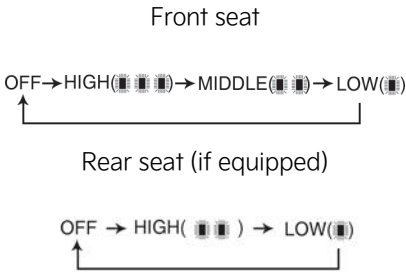

The seat warmer defaults to the OFF position whenever the EV button is turned on.

Temperature control (Automatic)

The seat warmer starts to automatically control the seat temperature in order to prevent low-temperature burns after being manually turned ON.

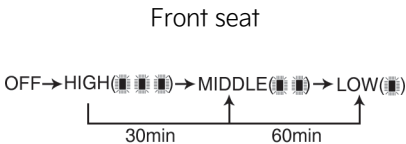

You may manually press the button to increase the seat temperature. However, it soon returns to the automatic mode again. When pressing the button for more than 1.5 seconds with the seat warmer operating, the seat warmer will turn OFF. The seat warmer defaults to the OFF position whenever the vehicle is in the ON position.

* NOTICE

With the seat warmer button in the ON position, the heating system in the seat turns off or on automatically depending on the seat temperature.

⚠ WARNING

Seat Warmer Burns

The seat warmer may cause burns, even at low temperature, if used over a long period of time. Never allow passengers who may not be able to take care of themselves to be exposed to the risk of seat heater burns. These include:

1. Infants, children, elderly or disabled persons, or hospital outpatients
2. Persons with sensitive skin or those that burn easily
3. Fatigued individuals
4. Intoxicated individuals
5. Individuals taking medication that can cause drowsiness or sleepiness (sleeping pills, cold tablets, etc.)

Air ventilation seat (if equipped)



The temperature setting of the seat changes according to the button indicator.

- To ventilate your seat cushion, press the switch (blue color).

Each time you press the button, the airflow will change as follows:

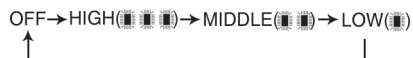

The seat warmer (with air ventilation) defaults to the OFF position whenever the EV button is turned on.

CAUTION**Seat Damage**

- When cleaning the seats, do not use an organic solvent, such as paint thinner, benzene, alcohol and gasoline. Doing so may damage the air ventilation seat.
- Do not place heavy or sharp objects on the seat. Those things may damage the air ventilation seat.
- Be careful not to spill liquid, such as water or beverages, on the seat. If you spill some liquid, wipe the seat with a dry towel. Before using the air ventilation seat, dry the seat completely.

Sun visor

Use the sun visor to shield direct light through the front or side windows.



- * The actual sun visor lamp in the vehicle may differ from the illustration.
- To use the sun visor, pull it downward.
 - To use the sun visor for the side window, pull it downward, unsnap it from the bracket (1) and swing it to the side (2).
 - To use the vanity mirror, pull down the visor and slide the mirror cover (4).
- Adjust the sun visor extension forward or backward (3).
- The ticket holder (5) is provided for holding a tollgate ticket.

CAUTION**Vanity Mirror Lamp**

If you use the vanity mirror lamp, turn off the lamp before returning the sun visor to its original position; otherwise, it could result in battery discharge and possible sun visor damage.

Power outlet

The power outlet is designed to provide power for mobile telephones or other devices designed to operate with vehicle electrical systems.

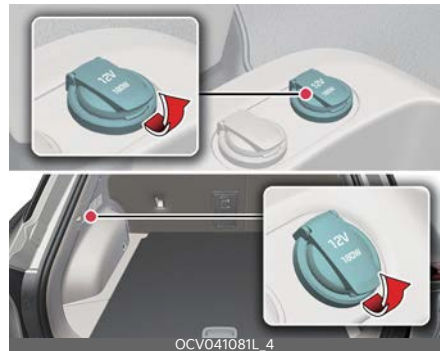

The devices should draw less than 10 amps with the vehicle on.

- Use the power outlet only when the vehicle is on and remove the accessory plug after use. Using the accessory plug for prolonged periods of time with the vehicle off could cause the battery to discharge.
- Only use 12 V electric accessories which are less than 10 A in electric capacity
- Adjust the air-conditioner or heater to the lowest operating level when using the power outlet.
- Close the cover when not in use.
- Some electronic devices can cause electronic interference when plugged

into a vehicle's power outlet. These devices may cause excessive audio static and malfunctions in other electronic systems or devices used in your vehicle.

- Push the plug in as far as it will go. If good contact is not made, the plug may overheat and the fuse may open.
- Plug in battery equipped electronic devices with reverse current protection. The current from the battery may flow into the vehicle's electrical/electronic system and cause system malfunction.

⚠ WARNING

Electric Shock

Do not put a finger or a foreign object (pen, etc.) into a power outlet and do not touch with a wet hand. You may get an electric shock.

USB charger (if equipped)

The USB charger is designed to recharge batteries of small size electrical devices using a USB cable.



The electrical devices can be recharged when the vehicle is in ACC/ON position. The battery charging state may be monitored on the electrical device.

Disconnect the USB cable from the USB port after use.

*** NOTICE**

- Some devices are not supported for fast charging but will be charged with normal speed.
- Use the USB charger when the vehicle is on to prevent battery discharge.
- Only devices that fit the USB port can be used.
- The USB charger can be used only for battery charging purposes.
- Battery chargers cannot be charged.

*** INFORMATION**

Power Delivery 3.0 is available on the smart phone or the tablet PC equipped with fast charging capabilities.

It is applicable to digital devices with USB C-type.

Charging speed is determined according to the charging specification of the connected digital device.

- Rated output
 - Digital device with fast charging: 9.0 V/Max 3.0 A
 - Digital devices with normal charging: 5.0 V/Max 3.0 A

Wireless smart phone charging system (if equipped)

A wireless smart phone charging system is located on the center console.

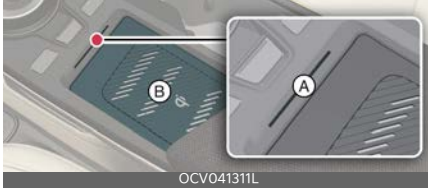

A: Indicator

B: Charging pad

Firmly close all doors, and turn vehicle on. To start wireless charging, place the smart phone equipped with wireless charging function on the wireless charging pad.

For best wireless charging results, place the smart phone on the center of the charging pad.

The wireless charging system is designed for one smart phone equipped with Qi per single usage only. Please refer to the smart phone accessory cover or the smart phone manufacturer homepage to check whether your smart phone supports Qi function.

Charging wireless smart phone

1. Remove any object on the smart phone charging pad including the smart key. If there is any foreign object on the pad other than a smart phone, the wireless charging function may not operate properly.
2. Place the smart phone on the center of the wireless charging pad.

The indicator light will change to orange once the wireless charging begins. After the charging is com-

plete, the orange light will change to green.

You can choose to turn the wireless charging function to either ON or OFF by selecting the menu on the infotainment system. (Please refer to "Vehicle settings (infotainment system)" on page 5-69 for details).

If the wireless charging does not work, gently move your smart phone around the pad until the charging indicator light turns orange.

Depending on the smart phone, the charging indicator light may not turn green even after the charging is complete.

If the wireless charging is not functioning properly, the orange light will blink and flash for ten seconds then turn off. In such cases, remove the smart phone from the pad and replace it on the pad again, or double check the charging status.

If you leave the smart phone on the charging pad when the vehicle is turned off, the vehicle will alert you through warning messages and sound (applicable for vehicles with voice guidance function) after the 'Good bye' function on the instrument cluster ends.

⚠ WARNING

Distracted Driving

Driving while distracted can result in a loss of vehicle control that may lead to an accident, severe bodily injury, or death. The driver's primary responsibility is in the safe and legal operation of a vehicle. Any use of handheld devices, other equipment, or vehicle systems that take the driver's eyes, attention, and focus away from the safe operation of a vehicle are not permissible by law. These

should never be used during the operation of the vehicle.

⚠ CAUTION

Liquid in Wireless Smart Phone Charger

To prevent liquid from damaging the wireless smart phone charging system in your vehicle, be sure not to spill liquid over the charging system when charging your phone.

⚠ CAUTION

Metal in Wireless Charging System

If any metallic object, system such as a coin, is located between the wireless charging system and the smart phone, the charging may be disrupted. Also, the metallic object may heat up and potentially damage the charging system. If there is any metallic object between the smart phone and the charging pad, immediately remove the smart phone. Remove the metallic object after it has cooled down.

*** NOTICE**

- When the interior temperature of the wireless charging system rises above a set temperature, the wireless charging system will cease to function. After the interior temperature drops below the threshold, the wireless charging function will resume.
- The wireless charging system may not function properly when there is a heavy accessory cover on the smart phone.
- The wireless charging system will stop when using the wireless smart key search function to prevent radio wave disruption.
- The wireless charging system will stop when the smart key is moved out of the vehicle with the vehicle in ON.
- The wireless charging system will stop when any of the doors are opened (applicable for vehicles equipped with smart keys).
- The wireless charging system will stop when the vehicle is turned OFF.
- The wireless charging system will stop when the smart phone is not in complete contact with the wireless charging pad.
- Items equipped with magnetic components, such as credit card, telephone card, bankbook or any transportation ticket, may become damaged during wireless charging.
- Place the smart phone on the center of the charge pad for best results. The smart phone may not charge when placed near the rim of the charging pad. When the smart phone does get charged, it may heat up excessively.
- For smart phones without a built-in wireless charging system, an appropriate accessory has to be equipped in order to use the vehicle's wireless charging system.
- Smart phones of some manufacturers may display messages on weak current. This is due to the particular characteristic of the smart phone and does not imply a malfunction on wireless charging function.
- The indicator light of some manufacturers' smart phones may still be orange after the smart phone is fully charged. This is due to the particular characteristic of the smart phone and not a malfunction of the wireless charging system.

- When any smart phone without a wireless charging function or a metallic object is placed on the charging pad, a small noise may sound. This small sound is due to the vehicle discerning compatibility of the object placed on the charging pad. It does not affect your vehicle or the smart phone in any way.
- The wireless cellular phone charging system may not support certain cellular phones, which are not verified for Qi specification (Φ).
- When placing your cellular phone on the charging mat, position the phone in the middle of the mat for optimal charging performance. If your cell phone is off to the side, the charging rate may be less and in some cases the cell phone may experience higher heat conduction.
- When charging some cellular phones with a self-protection feature, the wireless charging speed may decrease and the wireless charging may stop.

This device complies with Industry Canada licence-exempt RSS standard(s).

Operation is subject to the following two conditions:

1. This device may not cause interference, and
2. This device must accept any interference, including interference that may cause undesired operation of the device.

Coat hook

A coat hook is next to the rear grab handle.



OCV041620N

* This actual feature may differ from the illustration.

CAUTION

Hanging Clothing

Do not hang heavy clothes, since they may damage the hook.

WARNING

Do not hang other objects, such as hangers or hard objects except clothes. Also, do not put heavy, sharp or breakable objects in the clothing's pockets. In an accident or when the curtain air bag is inflated, it may cause vehicle damage or personal injury.



OCV041638N

Floor mat anchor(s)

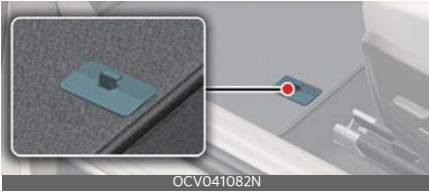

When using a floor mat on the front floor carpet, make sure it attaches to the floor mat anchor(s) in your vehicle. This keeps the floor mat from sliding forward.

⚠ WARNING

- **Aftermarket Floor Mat**
 - Do not install after market floor mats that are not capable of being securely attached to the vehicle's floor mat anchors.
Unsecured floor mats can interfere with pedal operation.
- Use floor mats not too thick and designed to be properly secured on the floor to avoid the interference with pedals. Make sure that installing the floor mats without removing plastic films on carpets may damage or break floor mat fix rings, resulting in the mats to be unsecured.
Especially for a driver's seat, the unsecured mats may cause unintended acceleration/brake. Ensure to remove all the plastic films on the carpets before installing the mats.

The following must be observed when installing ANY floor mat to the vehicle.

- Ensure that the floor mats are securely attached to the vehicle's floor mat anchor(s) before driving the vehicle.

- Do not use ANY floor mat that cannot be firmly attached to the vehicle's floor mat anchors.
- Do not stack floor mats on top of one another (e.g. all-weather rubber mat on top of a carpeted floor mat). Only a single floor mat should be installed in each position.

*** NOTICE**

Your vehicle was manufactured with driver's side floor mat anchors that are designed to securely hold the floor mat in place. To avoid any interference with pedal operation, Kia recommends that only the Kia floor mat designed for use in your vehicle be installed.

Luggage net holder

To keep items from shifting in the cargo area, you can use the holders located in the cargo area to attach the luggage net. (if equipped)

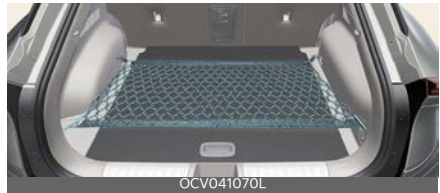

If necessary, contact an authorized Kia dealer.

⚠ CAUTION

To prevent damage to the vehicle, care should be taken when carrying fragile or bulky objects in the luggage compartment.

⚠ WARNING**Luggage net**

Always keep your face and body out of the luggage net recoil path and avoid using the luggage net when the straps have visible signs of wear or damage. The luggage net can snap and cause injuries.

Cargo security screen (if equipped)

Use the cargo security screen to hide items stored in the cargo area.



- To use the cargo security screen, pull the handle backward and insert the edges into the slots.

⚠ WARNING**Cargo Security Screen**

Do not place objects on the cargo security screen. Such objects may be thrown about inside the vehicle and possibly injure vehicle occupants during an accident or when braking.

⚠ CAUTION

Do not place luggage on the cargo security screen. This may cause the security screen to become damaged or malformed.

Audio system*** NOTICE**

If you install an after market HID head lamp, your vehicle's audio and electronic device may malfunction.

- * If your vehicle is equipped with multi-media system, refer to a separately supplied manual for detailed information.

Sharkfin antenna

The shark fin antenna receives data transmitted from base stations and satellites (e.g. AM/FM, GPS, Sirius XM, LTE) and also transmits to base stations (e.g. LTE).

USB port

You can use a USB port to plug in a USB.



Using the infotainment/climate switchable controller



Press the button on the switchable controller to switch between infotainment system or climate control panel.

Press and hold the button to select the default mode for the control panel.

Switching between panels

Infotainment control panel



Climate control panel



Press the button on the switchable controller to select the desired control panel.

The selected control panel icon will appear and the control panel will be changed.

- The knob display will appear according to the selected control panel mode.

- When the vehicle is in the ACC position, only the infotainment system will be activated.

Setting the default mode



Press and hold the button to select the default mode for the control panel.

- After the setting, the control panel will return to the default mode after a certain period of time even if the control panel is switched to the different mode.
- If the mode is set to 'OFF', the control panel will display the mode used recently.

How vehicle radio works

FM reception

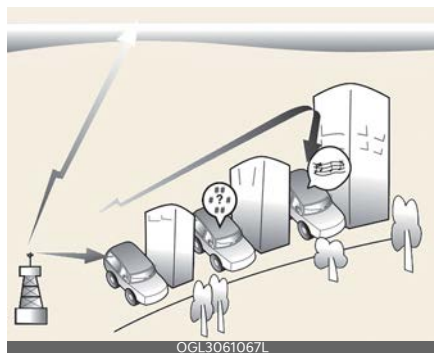

AM and FM radio signals are broadcast from transmitter towers located around your city. They are intercepted by the radio antenna on your vehicle. This sig-

nal is then processed by the radio and sent to your vehicle speakers. However, in some cases the signal coming to your vehicle may not be strong and clear. This can be due to factors, such as the distance from the radio station, closeness of other strong radio stations or the presence of buildings, bridges or other large obstructions in the area.

AM reception

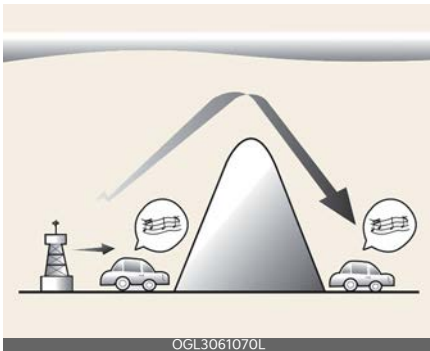

AM broadcasts can be received at greater distances than FM broadcasts. This is because AM radio waves are transmitted at low frequencies. These long distance, low frequency radio waves can follow the curvature of the earth rather than traveling straight. In addition, they curve around obstructions resulting in better signal coverage.

FM radio station

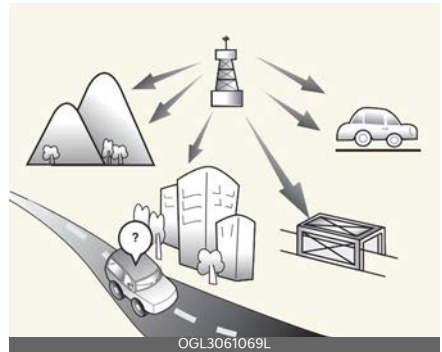

FM broadcasts are transmitted at high frequencies and do not bend to follow the earth's surface. Because of this, FM broadcasts generally begin to fade within short distances from the station. Also, FM signals are easily affected by buildings, mountains, and obstructions. This can lead to undesirable or unpleasant listening conditions which might lead you to believe a problem exists with your radio.

The following conditions are normal and do not indicate radio trouble:

- Fading - As your vehicle moves away from the radio station, the signal will weaken and sound will begin to fade. When this occurs, we suggest that you select another station with a stronger signal.

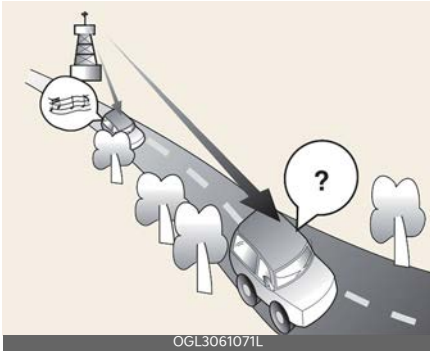

- Flutter/Static - Weak FM signals or large obstructions between the transmitter and your radio can disturb the signal causing static or fluttering noises to occur. Reducing the treble level may lessen this effect until the disturbance clears.
- Station Swapping - As an FM signal weakens, another more powerful signal near the same frequency may begin to play. This is because your radio is designed to lock onto the clearest signal. If this occurs, select another station with a stronger signal.

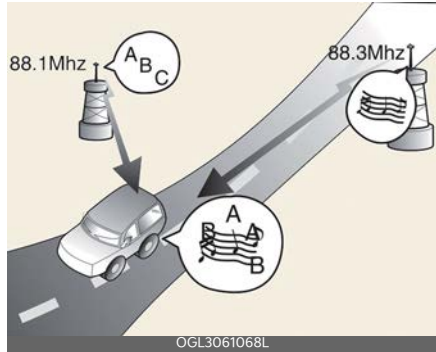

- Multi-Path Cancellation - Radio signals being received from several directions can cause distortion or fluttering. This can be caused by a direct and reflected signal from the same station, or by signals from two stations with close frequencies. If this occurs, select another station until the condition has passed.

Using a cellular phone or a two-way radio

When a cellular phone is used inside the vehicle, noise may be produced from the audio system. This does not mean that something is wrong with the audio equipment. In such a case, try to operate mobile devices as far from the audio equipment as possible.

When using a communication system such as a cellular phone or a radio set inside the vehicle, a separate external antenna must be fitted. When a cellular phone or a radio set is used with an internal antenna alone, it may interfere with the vehicle's electrical system and adversely affect safe operation of the vehicle.

⚠ WARNING**Cell Phone Use**

Do not use a cellular phone while driving. Stop at a safe location to use a cellular phone.

⚠ WARNING**Distracted Driving**

Driving while distracted can result in a loss of vehicle control that may lead to an accident, severe bodily injury, or death. The driver's primary responsibility is in the safe and legal operation of a vehicle. Any use of handheld devices, other equipment, or vehicle systems that take the driver's eyes, attention, and focus away from the safe operation of a vehicle are not permissible by law. These should never be used during the operation of the vehicle.

Declaration of Conformity**IC**

This device complies with Industry Canada's licence-exempt RSSs.

Operation is subject to the following two conditions:

1. This device may not cause interference; and
2. This device must accept any interference, including interference that may cause undesired operation of the device.

Le présent appareil est conforme aux CNR d'Industrie Canada applicables aux appareils radio exempts de licence.

L'exploitation est autorisée aux deux conditions suivantes:

1. l'appareil ne doit pas produire de brouillage, et
2. l'utilisateur de l'appareil doit accepter tout brouillage radioélectrique subi, même si le brouillage est susceptible d'en compromettre le fonctionnement.

Before driving	6-3
EV button	6-4
• Starting the vehicle.....	6-5
• Turning off the vehicle.....	6-6
Reduction gear	6-6
• Reduction gear operation.....	6-6
• Parking.....	6-9
• LCD display messages.....	6-9
• Good driving practices	6-11
Regenerative braking system	6-12
• Regenerative braking (Paddle shifter).....	6-12
• One pedal driving	6-13
• i-Pedal	6-14
Smart regeneration system	6-15
• Setting smart regeneration system.....	6-15
• Smart regeneration system activation	6-15
• Resuming smart regeneration system	6-16
• Turning smart regeneration system off.....	6-16
• Vehicle-to-vehicle distance recognition sensor	6-16
• System malfunction	6-17
• Limitations of the system	6-17
Brake system	6-20
• Power brakes.....	6-20
• High Performance Brake.....	6-22
• Electronic Parking Brake (EPB).....	6-22
• AUTO HOLD	6-27
• Anti-lock Brake System (ABS)	6-30
• Electronic Stability Control (ESC).....	6-31
• Vehicle Stability Management (VSM).....	6-33
• Hill-start Assist Control (HAC)	6-34
• Brake Assistant System (BAS)	6-34

6 Driving your vehicle

- Electronic Limited Slip Differential (For GT)..... 6-35
- Electronic Control Suspension 6-36
- Good braking practices..... 6-36
- Drive mode integrated control system 6-37**
 - DRIVE MODE..... 6-37
 - Selecting DRIVE MODE (For GT)..... 6-38
 - Initial setting for each DRIVE MODE 6-39
- Drift Mode (For GT)..... 6-40**
- Maximum Power Output Mode (For GT)..... 6-41**
- All wheel drive (AWD)..... 6-42**
 - For safe AWD operation..... 6-42
 - Emergency precautions..... 6-44
- Active air flap 6-45**
 - Active air flap malfunction..... 6-45
- Vehicle auto-shut off function..... 6-46**
- Special driving conditions 6-47**
- Winter driving 6-51**
- Trailer towing 6-53**
 - Hitches..... 6-54
 - Safety chains..... 6-55
 - Trailer brakes..... 6-55
 - Driving with a trailer 6-55
 - Maintenance when trailer towing 6-58
 - If you do decide to pull a trailer..... 6-58
- Vehicle load limit 6-61**
 - Steps for Determining Correct Load Limit - 6-61
 - Certification label 6-63
- Vehicle weight..... 6-64**

Driving your vehicle

Before driving

Before getting into the vehicle, you should examine the car and its surroundings. After getting into the vehicle, you should check a number of things before driving.

Before entering the vehicle

- Be sure that all windows, outside mirror(s), and outside lights are clean.
- Check the condition of the tires.
- Check under the vehicle for any sign of leaks.
- Be sure there are no obstacles behind you if you intend to back up.

Before starting

- Close and lock all doors.
- Position the seat so that all controls are easily reached.
- Buckle your seat belt.
- Adjust the inside and outside rear view mirrors.
- Be sure that all lights work.
- Check all gauges.
- Check the operation of warning lights when the EV button is turned to the ON position.
- Release the parking brake and make sure the brake warning light goes out.

For safe operation, be sure you are familiar with your vehicle and its equipment.

WARNING

Check Surroundings

Always check the surrounding areas near your vehicle for pedestrians, especially children, before putting a vehicle into D (Drive) or R (Reverse).

WARNING

Loose Objects

Securely store items in your vehicle. When you make a sudden stop or turn the steering wheel rapidly; loose objects may drop on the floor and it could interfere with the operation of the foot pedals, possibly causing an accident.

WARNING

Proper Footwear

Always wear appropriate shoes when operating your vehicle. Unsuitable shoes (high heels, ski boots, sandals, etc.) may interfere with your ability to use the brake and accelerator pedals.

WARNING

Driving While Intoxicated

Do not drive while intoxicated. Drinking and driving is dangerous. Even a small amount of alcohol will affect your reflexes, perceptions and judgment. Driving while under the influence of drugs is as dangerous as or more dangerous than driving drunk.

WARNING

Distracted Driving

Focus on the road while driving. The driver's primary responsibility is in the safe and legal operation of the vehicle. Use of any handled devices, other equipment or vehicle systems that distract the driver should not be used during vehicle operation.

EV button

Whenever the front door is opened, the EV button will appear for your convenience.



The light will go off after about 30 seconds when the door is closed.

When all doors are closed, if you lock the vehicle by using the transmitter or the smart key, the light will go off immediately.

EV button position

The EV button has the following four positions.

- OFF
- ACC (Accessory)
- ON
- START/RUN

OFF

To turn off the vehicle power (ON position), press the EV button with the shifter dial in the P (Park) position.

ACC (Accessory)

Press the EV button while it is in the OFF position without depressing the brake pedal.

If the EV button is in the ACC position for more than 1 hour, the button is turned off automatically to prevent battery discharge.

ON

Press the EV button while it is in the ACC position without depressing the brake pedal.

The warning lights can be checked before the vehicle is started. Do not leave the EV button in the ON position for a long time. The battery may discharge, because the vehicle is not running.

START/RUN

To start the vehicle, depress the brake pedal and press the EV button with the shifter dial in the P (Park) position.

If you press the EV button without depressing the brake pedal, the vehicle will not start and the EV button changes as follow:

Go to OFF → ACC → ON → OFF or ACC

* NOTICE

If you leave the EV button in the ACC or ON position for a long time, the battery will discharge.

⚠ WARNING

Starting Vehicle

Never press the EV button while the vehicle is in motion except in an emergency. This would result in loss of directional control and braking function, which could cause an accident.

⚠ WARNING

Leaving the Vehicle

To avoid unexpected or sudden vehicle movement, never leave your vehicle if the reduction gear is not locked in the P (Park) position and the parking brake is fully engaged. Before leaving the driver's seat, always make sure the reduction

gear is engaged in P (Park), set the parking brake fully and shut the vehicle off.

Starting the vehicle

⚠ WARNING

Do not start the vehicle with the accelerator pedal depressed. The vehicle can move and lead to an accident.

- The vehicle will start by pressing the EV button, only when the smart key is in the vehicle.
 - Even when the smart key is in the vehicle, if it is far away from the driver, the vehicle may not start.
 - When the EV button is in the ACC or ON position, and any door is open, the system checks for the smart key. When the smart key is not in the vehicle, the **READY** indicator will blink and **Key not in vehicle** message will come on. When all doors are closed, the chime will also sound for about 5 seconds. Keep the smart key in the vehicle when in the ACC position or if the vehicle is ON.
1. Always carry the smart key with you.
 2. Make sure the parking brake is applied.
 3. Make sure the shifter dial is in P (Park).
 4. Depress the brake pedal.
 5. Press the EV button. If the vehicle starts, the **READY** indicator will come on.

* NOTICE

- Always start the vehicle with your foot on the brake pedal. Do not depress the accelerator while starting the vehicle.

- If ambient temperature is low, the **READY** indicator may remain illuminated longer than the normal amount of time.

⚠ CAUTION

To prevent damage to the vehicle:

- If the **READY** indicator turns off while you are in motion, do not attempt to move the shifter dial to the P (Park) position. If traffic and road conditions permit, you may put the shifter dial in the N (Neutral) position while the vehicle is still moving and press the EV button in an attempt to restart the vehicle.
- Do not push or tow your vehicle to start the vehicle.

⚠ WARNING

Unintended Vehicle Movement

Never leave the smart key in the vehicle with children or vehicle occupants who are unfamiliar with the vehicle operation. Pushing the EV button while the smart key is in the vehicle may result in unintended vehicle activation and/or unintended vehicle movement.

If the battery is weak or the smart key does not work correctly, you can start the vehicle by pressing the EV button with the smart key.



The side with the lock button should contact the EV button directly.

When you press the EV button directly with the smart key, the smart key should contact the button at a right angle.

When the stop lamp fuse is blown, you can't start the vehicle normally. Replace the fuse with a new one. If it is not possible, you can start the vehicle by pressing the EV button for 10 seconds while it is in the ACC position. The vehicle can start without depressing the brake pedal. But for your safety always depress the brake pedal before starting the vehicle.

Do not press the EV button for more than 10 seconds except when the stop lamp fuse is blown.

Turning off the vehicle

1. Depress the brake pedal fully.
2. Shift to P (Park).
3. Apply the parking brake.
4. Press the EV button to turn the vehicle off.
5. Make sure the **READY** indicator light on the instrument cluster is turned off.

⚠ CAUTION

If the **READY** indicator light on the instrument cluster is still on, the vehicle is not turned off and can move when the gear is in any position except P (Park).

Reduction gear

Electric cars transmit the rotation of the motor to the wheel through the reducer.

Reduction gear operation

Select gear positions by turning the shifter dial.



⚠ WARNING

To reduce the risk of serious injury or death:

- ALWAYS check the surrounding areas near your vehicle for people, especially children, before shifting a vehicle into D (Drive) or R (Reverse).
- Before leaving the driver's seat, always make sure the gear is in the P (Park) position, then set the parking brake, and place the Power button in the OFF position. Unexpected and sudden vehicle movement can occur if these precautions are not followed.

For your safety, always depress the brake pedal while shifting to another gear.

Gear position

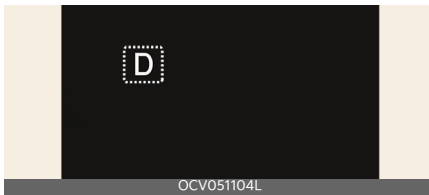

The indicator in the instrument cluster displays the gear position when the EV button is in the ON position.

P (Park)

Always come to a complete stop before shifting into P (Park).

To shift the gear from R (Reverse), N (Neutral) or D (Drive) to P (Park), press the [P] button.

If you turn off the vehicle while it is stopped, the gear automatically shifts to P (Park).

With the vehicle on, the gear automatically shifts to P (Park) if you open the driver's door when the gear is in N (Neutral), R (Reverse) or D (Drive) and the following conditions are met:

- The vehicle speed is below 2 km/h (1 mph).

When the vehicle is over a certain speed, the gear does not shift to P (Park) when the [P] button is pressed.

⚠ WARNING

- Shifting into P (Park) while the vehicle is in motion may cause you to lose control of the vehicle.
- After the vehicle has stopped, always make sure the gear is in P (Park), apply the parking brake, and turn the vehicle off.
- Do not use the P (Park) position in place of the parking brake.

R (Reverse)

Use this position to drive the vehicle backward.

To shift to R (Reverse), turn the shifter dial to R (Reverse) position while depressing the brake pedal.

⚠ CAUTION

Shifting

Always come to a complete stop before shifting into or out of R (Reverse); you may damage the reduction gear if you shift into R (Reverse) while the vehicle is in motion, except on "Rocking the vehicle" on page 6-48.

N (Neutral)

To shift to N (Neutral) from P (Park), turn the shifter dial to N (Neutral) position while depressing the brake pedal.

If the Electronic Parking Brake is applied, release the Electronic Parking Brake manually while depressing the brake pedal.

If equipped with Electronic Parking Brake, it is not released automatically when you turn the shift dial to N (Neutral).

To turn off the vehicle from the ACC position, press the [P] button within 3 minutes. The vehicle will shift to P (Park) and turn off.

When the driver's door is opened within 3 minutes with the EV button in the ACC position and the gear in N (Neutral), the vehicle is automatically turned OFF and shifted to the P (Park) position.

To stay in N (Neutral) when vehicle is OFF

If you want to stay in N (Neutral) after the vehicle is OFF (in the ACC state), do the following.

1. Turn off AUTO HOLD and release Electronic Parking Brake when the vehicle is running.
2. Rotate the shift dial to N (Neutral) while depressing the brake pedal.
3. When you take your foot off the brake pedal, the message 'Press and hold OK button on the steering wheel to stay in Neutral' will appear on the cluster LCD display.
4. Press and hold the OK button on the steering wheel for more than 1 second.
5. When the message 'Vehicle will stay in (N). Change gear to cancel' (or 'N will stay engaged when the vehicle is Off') will appear on the cluster LCD display, press the EV button while depressing the brake pedal.

However, if you open the driver's door within 3 minutes in the ACC state, the gear will automatically shift to P (Park) and the EV button will change to the OFF position.

CAUTION

Do not open the driver's door when going through an automatic car wash tunnel machine. Failure to follow this instruction can damage your vehicle or the car wash machine.

For vehicles equipped with Electronic Parking Brake (EPB), the parking brake is automatically applied.

* NOTICE

With the gear in N (Neutral) the EV button will be in the ACC position. Note that the doors cannot be locked in the ACC position or the 12V battery may discharge if left in the ACC position for a long period.

D (Drive)

This is the normal driving position.

To shift to D (Drive), turn the shifter dial to D (Drive) position while depressing the brake pedal.

Shift-lock system

For your safety, your vehicle has a shift-lock system which prevents shifting the gear from P (Park) or N (Neutral) into R (Reverse) or D (Drive) unless the brake pedal is depressed.

To shift from P (Park) or N (Neutral) into R (Reverse) or D (Drive), from R (Reverse) into D (Drive) or from D (Drive) into R (Reverse):

1. Depress and hold the brake pedal.
2. Start the vehicle or place the EV button in the ON position.
3. Press the R (Reverse) or D (Drive) button.

* NOTICE

You cannot shift the gear while the charging cable is connected.

When the battery (12V) is discharged

You cannot shift the gear when the battery is discharged.

Jump start your vehicle (refer to "Jump starting (12V battery)" on page 8-4) or contact an authorized Kia dealer.

Parking

1. Always come to a complete stop and continue to depress the brake pedal.
2. Shift to the P (Park) position.
3. Apply the parking brake.
4. Place the EV button in the OFF position.
5. Take the key with you when leaving the vehicle.

LCD display messages

If a message appears on the LCD display, refer to the next section for the appropriate steps to take.

Shifting conditions not met

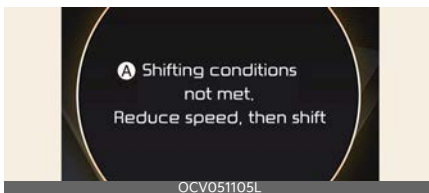

A: Shifting conditions not met, Reduce speed, then shift

The message appears on the LCD display in the following conditions:

1. When driving speed is too fast to shift the gear. Decrease the vehicle speed or slow down before shifting the gear.
2. When the gear is shifted while the vehicle is in Utility mode.

Press brake pedal to change gear



A: Press brake pedal to change gear

The message appears on the LCD display, when the brake pedal is not depressed while shifting the gear.

Depress the brake pedal and then shift the gear.

Shift to P after stopping



A: Shift to P after stopping

The message appears on the LCD display when the gear is shifted to P (Park) while the vehicle is moving.

Stop the vehicle before shifting to P (Park).

Gear already selected



A: Gear already selected

The message appears on the LCD display when the selected gear button is pressed again.

PARK malfunction. Engage parking brake when parking vehicle



A: PARK malfunction. Engage parking brake when parking vehicle

The message is displayed when there is a problem with function engaging P (Park) position.

Immediately have the vehicle inspected by an authorized Kia dealer.

Check P button

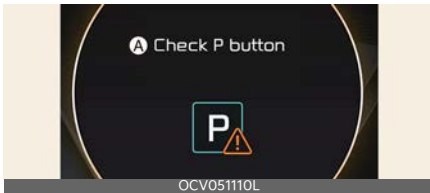

A: Check P button

The message appears on the LCD display when there is problem with the P button.

Immediately have the vehicle inspected by an authorized Kia dealer.

Check shifter dial

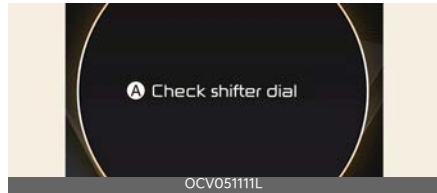

A: Check shifter dial

The message appears on the LCD display when there is problem with the shift dial.

Immediately have the vehicle inspected by an authorized Kia dealer.

Rotary shifter stuck

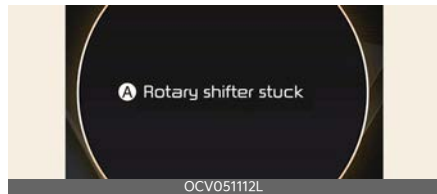

A: Rotary shifter stuck

The message appears on the LCD display when the shifter dial is continuously stuck or there is problem with the shifter dial.

Make sure that there is no object over the shifter dial. If the problem persists, immediately have the vehicle inspected by an authorized Kia dealer.

Shift button held down



A: Shift button held down

The message appears on the LCD display when the shifter button is continuously pressed or there is problem with the button.

Make sure that there is no object over the shift button. If the problem persists, immediately have the system checked by an authorized Kia dealer.

Rotary shifter turned while pressing P



A: Rotary shifter turned while pressing P

The message appears on the LCD display when the shifter dial is turned while pressing P button.

Make sure that shifter dial is not turned while pressing P button.

Good driving practices

Good driving habits reduce the risk of accidents and help maintain vehicle performance.

- Never shift from P (Park) or N (Neutral) to any other position with the accelerator pedal depressed.

- Never shift from P (Park) when the vehicle is in motion.
Be sure the vehicle is completely stopped before you attempt to shift into R (Reverse) or D (Drive).
- Do not shift to N (Neutral) when driving. Doing so may result in an accident.
- Do not drive with your foot resting on the brake pedal. Even light, but consistent pedal pressure can result in the brakes overheating, brake wear and possibly even brake failure.
- Always apply the parking brake when leaving the vehicle. Do not depend on placing the gear in P (Park) to keep the vehicle from moving.
- Exercise extreme caution when driving on a slippery surface. Be especially careful when braking, accelerating or shifting gears. On a slippery surface, an abrupt change in vehicle speed can cause the drive wheels to lose traction and may cause loss of vehicle control resulting in an accident.
- Optimum vehicle performance and economy is obtained by smoothly depressing and releasing the accelerator.

⚠ WARNING

When driving uphill or downhill, always shift to D (Drive) for driving forward or shift to R (Reverse) for driving backwards, and check the gear position indicated on the cluster before driving. Driving in the opposite direction of the selected gear can lead to a dangerous situation by shutting off the vehicle and affecting the braking performance.

⚠ WARNING

To reduce the risk of **SERIOUS INJURY** or **DEATH**:

- ALWAYS wear your seat belt. In a collision, an unbelted occupant is significantly more likely to be seriously injured or killed than a properly belted occupant.
- Avoid high speeds when cornering or turning.
- Do not make quick steering wheel movements, such as sharp lane changes or fast, sharp turns.
- The risk of rollover is greatly increased if you lose control of your vehicle at highway speeds.
- Loss of control often occurs if two or more wheels drop off the roadway and the driver over steers to reenter the roadway.
- In the event your vehicle leaves the roadway, do not steer sharply. Instead, slow down before pulling back into the travel lanes.
- Kia recommends you follow all posted speed limits.

Regenerative braking system

The regenerative braking system allows you to charge the battery when you use the brakes to stop the vehicle.

Regenerative braking (Paddle shifter)

The paddle shifter is used to adjust the regenerative braking level from 0 to 3 during decelerating or braking.



- Left side (+): Increases regenerative braking and deceleration.
- Right side (-): Decreases regenerative braking and deceleration.

Pull and hold the left side paddle shifter for more than 0.5 seconds and One Pedal Driving function is operated, increasing the regenerative braking. In this case, stopping the vehicle is possible by pulling the paddle shifter.

* Refer to "One pedal driving" on page 6-13.

Pull and hold the right side paddle shifter for over 1 second to turn on and off the automatic change of the regenerative braking.

* Refer to "Smart regeneration system" on page 6-15.

*** NOTICE**

The paddle shifter does not operate when:

- The (+/-) and (-/+) paddle shifters are pulled at the same time.
- The vehicle is decelerating by depressing the brake pedal.
- Smart Cruise Control is activated.
- Regenerative braking system is activated when the vehicle state of charge is 100%.
- SNOW mode is activated from DRIVE MODE.
- Trailer is attached to the vehicle.
- Selecting 0 step of the regenerative braking system, the brake disc cleaning function is operated around 10 times. While operating to clean the brake disc, the driving distance and the regenerative braking performance can be reduced. After finishing, the regenerative braking performance will be restored.

The selected regenerative braking level is displayed on the instrument cluster.



Initial setting of the regenerative braking level and adjustable range vary according to the selected Drive mode.

Drive mode	Adjustable range
SNOW*1	0~1
ECO	0~3
NORMAL	0~3
SPORT	0~3
GT*2	0~3
MY DRIVE*2	0~3

*1: Except for GT

*2: Only for GT

* For more details, refer to "Drive mode integrated control system" on page 6-37.

One pedal driving

The driver can stop the vehicle by pulling and holding the left side paddle shifter.

To operate

- Pull and hold the left side paddle shifter while coasting.
- When the vehicle speed is above 3 km/h (2 mph), release the paddle shifter to return to the previously set level.
- When the vehicle speed is below 3 km/h (2 mph), the function maintains control to stop the vehicle even though the paddle shifter is released.
- While the One pedal driving is in activation, the driver can control the vehicle stopping position using the accelerator pedal.

Automatic engagement of EPB

After the vehicle is stopped by the One Pedal Driving function, EPB is automatically engaged when any of these conditions occur:

- The gear is shifted to P (Park).
- The driver's door is open.
- The hood is open.
- The liftgate is open.
- 5 minutes have passed after the vehicle has stopped.
- The system operation is limited due to other reasons.

WARNING

- Do not solely rely on one pedal driving to stop the vehicle. Stopping the vehicle may not be possible depending on the vehicle and road conditions. Pay attention to the road condition ahead and apply the brake if necessary.
- Avoid increasing the regenerative braking level suddenly on slippery roads (like snow or icy conditions) because it may lead to slipping of the tires and skidding of vehicle. It can be dangerous due to the loss of the vehicle's steering force.

NOTICE

When the vehicle is stopped or parked by One Pedal Driving on the steep hills, be sure to depress the brake pedal.

To operate

1. Pull the left side paddle shifter to level 3 regenerative braking system.
2. Pull the left side paddle shifter once again when the regenerative braking level is 3.
 - Check i-Pedal indicator symbol on the instrument cluster.

CAUTION

When the vehicle is stopped or parked by i-Pedal on the steep hills, be sure to depress the brake pedal.

i-Pedal

i-Pedal is controlled by the accelerator pedal. i-Pedal provides vehicle speed control (acceleration/deceleration, stopping) without manually controlling the paddle shifter.

Smart regeneration system

The Smart Regeneration System controls the regenerative braking automatically according to the road gradient and driving condition of the vehicle in front.

The system minimizes the unnecessary operation of the brake and acceleration pedal, improving the electric efficiency and assisting the driver.

Setting smart regeneration system

Pull and hold the right side paddle shifter for over 1 second to turn on and off the automatic change of the regenerative braking. The automatic regenerative braking adjustment by smart regeneration system is activated above the standard set level.

Smart regeneration system activation

With 'AUTO' for the regenerative braking level displayed on the cluster, the regenerative braking level is controlled automatically when vehicle speed is above 10 km/h (6 mph) and one of the condition below is met.

- The road gradient changes
- Distance from the vehicle ahead reduces or increases
- Speed of the vehicle ahead reduces or increases

* NOTICE

- The regenerative braking level can be adjusted based on the driver's deceleration style. (**Strong/Medium/Gentle**)

To adjust the level, select **Setup** → **EV** → **Smart Regeneration System** in the infotainment system.

- The infotainment system may change after software updates. For more information, refer to the user's manual provided in the infotainment system and the quick reference guide

* NOTICE

When vehicle speed is under 10 km/h (6 mph), the Smart Regeneration System is canceled. The driver must adjust the vehicle speed by depressing the accelerator or brake pedal according to the road condition ahead and driving condition.

When the system is turned on from the Vehicle Settings menu, but the front radar doesn't recognize the vehicle in front, 'AUTO' is displayed in white.



If the front radar recognizes the vehicle in front, 'AUTO' is displayed in blue. The regenerative braking level is automatically controlled depending on the driving condition of the vehicle in front and the level is indicated with arrows.

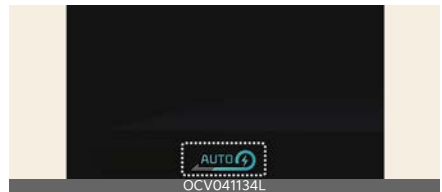

However, current regenerative braking level is maintained if the driver depresses the brake pedal while the system is in activation. Also, the system is

canceled temporarily if the accelerator pedal is depressed.

⚠ WARNING

The Smart Regeneration System which automatically controls the regenerative braking level when coasting is only a supplemental system for the driver's convenience. Do not solely rely on this system to stop the vehicle. The system cannot completely stop the vehicle in all situations nor avoid all collisions. The brake control may be insufficient depending on the speed of the vehicle in front and when the vehicle in front suddenly stops, a vehicle cuts in suddenly or there is a steep slope. Always look ahead cautiously to prevent unexpected and sudden situations from occurring.

Smart regeneration system will be temporarily canceled when:

- Canceled manually
Pulling and holding the right side of the paddle shifter for more than 1 second.
The Smart Regeneration System turns off temporarily and AUTO for the regenerative braking level disappears from the cluster.
- Canceled automatically
 - The vehicle is shifted to N (Neutral), R (Reverse) or P (Park).
 - Smart Cruise Control is in activation.
 - The ESC (Electronic Stability Control) or ABS is operating.

*** NOTICE**

When the Smart Regeneration System is canceled automatically, adjust the vehicle speed directly by depressing the accelerator or brake pedal according to the road and driving conditions ahead.

Resuming smart regeneration system

To re-activate the Smart Regeneration System while driving:

- Pull and hold the right side paddle shifter for more than 1 second again. Then, AUTO for the regenerative braking level will appear on the cluster.

Turning smart regeneration system off

To turn off the system:

- Pull and hold the right side of the paddle shifter for more than 1 second.

Vehicle-to-vehicle distance recognition sensor

In order for the Smart Regeneration System to operate properly, always make sure the radar sensor cover is clean and free of dirt, snow, and debris.

Dirt, snow, or foreign substances on the lens may adversely affect the sensing performance of the sensor. In this case, the system operation may stop temporarily and not operate normally.

Front radar



OCV051005N

⚠ CAUTION

- Do not apply license plate frame or foreign objects such as a bumper sticker or a bumper guard near the radar sensor. Doing so may adversely affect the sensing performance of the radar.
- Always keep the radar sensor and lens cover clean and free of dirt and debris.
- Use only a soft cloth to wash the vehicle. Do not spray pressurized water directly on the sensor or sensor cover.
- Be careful not to apply unnecessary force on the radar sensor or sensor cover. If the sensor is forcibly moved out of proper alignment, the Smart Regeneration System may not operate correctly. In this case, a warning message may not be displayed. Have the vehicle inspected by an authorized Kia dealer.
- If the front bumper becomes damaged in the area around the radar sensor, the Smart Regeneration System may not operate properly. Have the vehicle inspected by an authorized Kia dealer.
- Use only genuine Kia parts to repair or replace a damaged sensor or sensor cover. Do not apply paint to the sensor cover.

System malfunction

The following message will appear when the Smart Regeneration System is not functioning normally.



A: Check Smart Regeneration System

The message will appear when the system is not functioning normally. The system will be canceled and the word 'AUTO' on the cluster will disappear and instead display regenerative braking level. Check for foreign substances on the front radar. Remove any dirt, snow, or foreign material that could interfere with the radar sensors. If the system still does not operate normally, take your vehicle to an authorized Kia dealer and have the system checked.

Limitations of the system

The Smart Regeneration System may not operate properly in certain situations when the driving condition is beyond the performance of the front radar sensor. Driver's attention is required in such cases when the system does not react properly or operate unintentionally.

Driving on a curved road



When driving on the curve, the system may not detect the vehicle in your lane and the regenerative braking level will reduce automatically, making you feel that the vehicle is accelerating.

Also, if the system suddenly recognizes the vehicle in front, the regenerative braking level will increase automatically, making you feel that the vehicle is decelerating.

The driver must maintain a safe braking distance, and if necessary, depress the brake pedal to reduce your driving speed in order to maintain a safe distance.



The smart regeneration system may recognize a vehicle in an adjacent lane when driving on a curved road. In this case, the system increase the braking level and slow the vehicle.

Always pay attention to road and driving conditions while driving. If necessary, depress the brake pedal to reduce your driving speed in order to maintain a safe distance. Also, when necessary, you may depress the accelerator pedal to prevent the system from unnecessarily decelerating your vehicle.

Always check the traffic conditions around the vehicle.

Driving on a sloped road



When driving uphill or downhill, the system may not detect the vehicle in your lane and the regenerative braking level will reduce automatically, making you feel that the vehicle is accelerating.

Also, if the system suddenly recognizes the vehicle in front, the regenerative braking level will increase automatically, making you feel that the vehicle is decelerating.

The driver must maintain a safe braking distance, and if necessary, depress the brake pedal to reduce your driving speed in order to maintain a safe distance.

Changing lanes

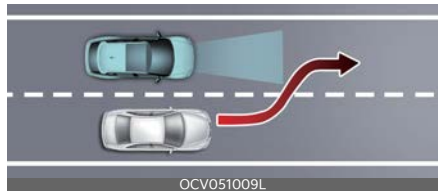

When a vehicle changes lanes in front of you, the smart regeneration system may not immediately detect the vehicle, especially if the vehicle changes lanes abruptly. In this case, you must maintain a safe braking distance, and if necessary, depress the brake pedal to reduce

your driving speed in order to maintain a safe distance.

Recognizing the vehicle



Some vehicles in your lane cannot be recognized by the sensor:

- Narrow vehicles such as motorcycles or bicycles
- Vehicles offset to one side
- Slow-moving vehicles or sudden-decelerating vehicles
- Stopped vehicles (When the vehicle ahead drives away, the system may not detect a stopped vehicle.)
- Vehicles with small rear profile such as trailers with no loads

A vehicle ahead cannot be recognized correctly by the sensor if any of following occurs:

- When the vehicle is pointing upwards due to overloading in the luggage compartment
- While the steering wheel is operating
- When driving to one side of the lane
- When driving on narrow lanes or on curves

Apply the brake or accelerator pedal if necessary.

WARNING

When using the Smart Regeneration System take the following precautions:

- If an emergency stop is necessary, you must apply the brakes.

- Keep a safe distance according to road conditions and vehicle speed. If the vehicle distance is too close during high-speed driving, a serious collision may result.
- Always maintain sufficient braking distance and decelerate your vehicle by applying the brakes if necessary.
- The Smart Regeneration System is designed to detect and monitor the vehicle ahead in the roadway through radar signals. It is not designed to detect oncoming vehicles, pedestrians, bicycles, motorcycles, or smaller wheeled objects such as luggage bags, shopping carts, or strollers.
- Vehicles moving in front of you with a frequent lane change may cause a delay in the system's reaction or may cause the system to react to a vehicle actually in an adjacent lane. Always drive cautiously to prevent unexpected and sudden situations from occurring.
- The Smart Regeneration System may not recognize complex driving situations so always pay attention to driving conditions and control your vehicle speed.

*** NOTICE**

The Smart Regeneration System may not operate temporarily due to:

- Electrical interference
- Modifying the suspension
- Differences of tire abrasion or tire pressure
- Installing different type of tires

This device complies with Industry Canada licence-exempt RSS standard(s).

Operation is subject to the following conditions:

1. This device may not cause interference, and
2. This device must accept any interference, including interference that may cause undesired operation of the device.
3. Changes or modifications not expressly approved by the party responsible for compliance could void the user's authority to operate the device.

Brake system

This vehicle is equipped with various brakes and functions to stop the vehicle or keep it stationary.

Power brakes

Your vehicle has power-assisted brakes that adjust automatically through normal usage.

In the event of a vehicle power failure, the power assist for the brakes will not work. You can still stop your vehicle, but it will require greater force and increased pedal travel than normal. The stopping distance, however, will be longer than with power brakes.

Pump the brake pedal only when necessary to maintain steering control on slippery surfaces.

* NOTICE

- When stepping on the brake pedal under a certain driving or weather condition, you may witness your car make a sound of squealing or some other noises. This is not a brake malfunction but a normal phenomenon.
- When driving on the road to which deicing chemicals are applied, the vehicle may witness noises from the brake or abnormal abrasion of tires because of such deicing chemicals. You should operate brake additionally so that you would be able to remove the deicing chemicals on the brake disk and pad under a safe traffic condition.

⚠ CAUTION**Brake Pedal**

Do not drive with your foot resting on the brake pedal. This will create abnormally high brake temperatures which can cause excessive brake lining and pad wear.

⚠ WARNING**Steep Hill Braking**

Avoid continuous application of the brakes when descending a long or steep hill by increasing the regeneration level. Continuous brake application will cause the brakes to overheat and could result in a temporary loss of braking performance.

Wet brakes may impair the vehicle's ability to safely slow down; the vehicle may also pull to one side when the brakes are applied. Applying the brakes lightly will indicate whether they have been affected in this way. Always test your brakes in this fashion after driving through deep water. To dry the brakes, apply them lightly while maintaining a safe forward speed until brake performance returns to normal.

*** NOTICE**

Do not depress the brake pedal continuously without the **READY** indicator ON. The battery may be discharged.

Brake disc cleaning

If there is a surface rust on the brake disc or squeal can be heard, select level 0 of the regenerative brake system.

The regenerative brake system will be temporarily deactivated to clean the brake disc.

Depressing a brake while driving approximately 10 times, the regenerative brake system will not be operated during Brake Disc Cleaning mode is activated (Regenerative brake system level 0). The energy consumption may increase.

After Brake Disc Cleaning mode operates, the regenerative brake system will activate again.

In the event of brake failure

If service brakes fail to operate while the vehicle is in motion, you can make an emergency stop with the parking brake. The stopping distance, however, will be much greater than normal.

⚠ WARNING**Parking Brake**

Avoid applying the parking brake to stop the vehicle while it is moving except in an emergency situation. Applying the parking brake while the vehicle is moving at normal speeds can cause a sudden loss of control of the vehicle. If you must use the parking brake to stop the vehicle, use great caution in applying the brake.

Disc brakes wear indicator

When your brake pads are worn and new pads are required, you will hear a high-pitched warning sound from your front brakes or rear brakes. You may hear this sound come and go or it may occur whenever you depress the brake pedal.

Always replace the front or rear brake pads as pairs.

⚠ WARNING

Replace Brake Pads

Do not continue to drive with worn brake pads. Continuing to drive with worn brake pads can damage the braking system and result in costly brake repairs, and can also lead to a serious accident.

⚠ WARNING

Brake Wear

Do not ignore high pitched wear sounds from your brakes. If you ignore this audible warning, you will eventually lose braking performance, which could lead to a serious accident.

High Performance Brake (if equipped)

As this vehicle is equipped with the High Performance Brake (large diameter brakes for enhanced braking performance), noise such as a squeal, squeak or groan is generated while braking. This is normal and the friction may create circle patterns on the disc surface. This is also a normal situation which does not affect braking performance.

* NOTICE

- Occasional brake noise is normal. If a continuous grinding or continuous squeal sound is present, the brake lining may be worn-out. Contact an authorized Kia dealer.
- If the vehicle has continuous vibration or shudder in the steering wheel while braking, contact an authorized Kia dealer.

⚠ CAUTION

Frequent speeding and braking may deform components and wear the disc brake causing vibration when braking. Prevent brake damage by avoiding excessive braking.

Brake wear, noise, vibration from excessive braking or deformation of the brakes caused by repeatedly braking in high speed, racing on tracks, etc. can be excluded from warranty coverage.

Electronic Parking Brake (EPB)

The Electronic Parking Brake switch is located on the lower left side of the shifter dial.

Applying the parking brake



- Press the brake pedal.
- Pull up the EPB switch.
- Make sure the warning light comes on.

Also, the EPB is applied automatically if the Auto Hold button is on when the

vehicle is turned off. If you pull up the EPB switch after the vehicle is turned off, the EPB will be Applied.

* NOTICE

On a steep incline or when pulling a trailer, if the vehicle does not remain at a standstill, do as follows:

1. Apply the EPB.
2. Pull up the EPB switch for more than 3 seconds.

Do not operate the EPB while the vehicle is moving except in an emergency situation.

* NOTICE

A click or electric brake motor whine sound may be heard while operating or releasing the EPB.

These conditions are normal and indicate that the EPB is functioning properly.

Releasing the parking brake with Electronic Parking Brake (EPB) switch



1. Releasing the parking brake with EPB switch,
 - Place the EV button in the ON position.
 - Depress the brake pedal.
 - The shifter dial must be in P (Park).
2. Make sure the brake warning light goes off.

Automatic release of Electronic Parking Brake (EPB)

The EPB is released automatically under following conditions.

- Shifter dial in P (Park)

With the vehicle running depress the brake pedal and shift out of P (Park) to R (Reverse) or D (Drive).
- Shifter dial in N (Neutral)

With the vehicle running depress the brake pedal and shift out of N (Neutral) to R (Reverse) or D (Drive).
- Reduction gear
 1. Start the vehicle.
 2. Fasten the driver's seat belt.
 3. Close the driver's door, hood and liftgate.
 4. Depress the accelerator pedal while the shifter dial is in R (Reverse) or D (Drive).

Make sure the brake warning light goes off.

⚠ WARNING

- Never allow a passenger, children, or animal to touch the Electronic Parking Brake.
- Do not input any other objects around the Electronic Parking Brake. It may be operated unintentionally.

* NOTICE

- For your safety, you can engage the EPB even though the EV button is in the OFF position, but you cannot release it.
- For your safety, depress the brake pedal and release the parking brake manually with the EPB switch when you drive downhill or when backing up the vehicle.

⚠ CAUTION

- If the parking brake warning light is still on even though the EPB has been released, have the system checked by an authorized Kia dealer.
- Do not drive your vehicle with the EPB applied. It may cause excessive brake pad and brake rotor wear.
- Whenever leaving the vehicle or parking, make sure the gear is shifted to P (Park) position, then apply the parking brake. Block the tires if necessary.
- Electronic Parking Brake may not be released because it can freeze in winter. Do not use Electronic Parking Brake and shift the gear to P (Park), block the tires, and park the vehicle on the flat and safe road. If the Electronic Parking Brake is applied when you shift the gear to P (Park), release the Auto Hold and Electronic Parking Brake, and park the vehicle with the tires blocked.
- When driving with the Electronic Parking Brake applied, brake system may be overheated, brake lines may be worn, and the Electronic Parking Brake may be damaged.
- When the battery charge is not sufficient, Electronic Parking Brake may not be applied or released. In this case, connect to the auxiliary battery.

EPB (Electronic Parking Brake) may be automatically applied when:

- The EPB is overheated
- Requested by other systems
- If equipped with Electronic Parking Brake, parking brake is applied automatically when the gear is shifted to P (Park).

⚠ CAUTION

- If you notice a continuous noise or burning smell when the EPB is used for emergency braking, have your vehicle checked by an authorized Kia dealer.
- If the gear is shifted to N (Neutral) while Electronic Parking Brake is applied, it is not released automatically. If you don't release Electronic Parking Brake manually before using an automatic car wash tunnel machine or etc., this may result in damage to the vehicle or the automatic car wash tunnel machine.

*** NOTICE**

For EPB (Electronic Parking Brake) equipped vehicles with AUTO HOLD function used while driving, if the EV button has been turned OFF, the EPB will be engaged automatically. Therefore, AUTO HOLD function should be turned off before the EV button is turned off.

System warning

The EPB will display a warning message with sound under certain conditions.

- If you try to drive off depressing the accelerator pedal with the EPB applied, but the EPB doesn't release automatically, a warning will sound and a message will appear.
- If the driver's seat belt is not fastened and the vehicle hood, driver's door or liftgate is opened, a warning will sound and a message will appear.

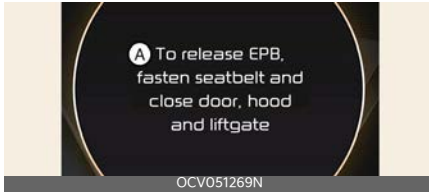

A: To release EPB, fasten seatbelt and close door, hood and liftgate

- If there is a problem with the vehicle, a warning may sound and a message may appear.

If the above situation occurs, depress the brake pedal and release EPB by pressing the EPB switch.

⚠ WARNING

- To prevent unintentional movement when stopped and leaving the vehicle, do not use the shifter dial in place of the parking brake. Set the parking brake and make sure the shifter dial is securely positioned in P (Park).
- Never allow a passenger to touch the parking brake. If the parking brake is released unintentionally, serious injury may occur.
- All vehicles should always have the parking brake fully engaged when parked to avoid inadvertent movement of the vehicles which can injure occupants or pedestrians.

*** NOTICE**

- A click or electric brake motor whine sound may be heard while operating or releasing the EPB. These conditions are normal and indicate that the EPB is functioning properly.
- If you hand over the vehicle to other people, make sure they understand how to use the Electronic Parking Brake for safety.
- The EPB may malfunction if you drive with the EPB applied.
- When you automatically release EPB by depressing the accelerator pedal, depress it slowly.

When the conversion from AUTO HOLD to EPB is not working properly a warning will sound and a message will appear.

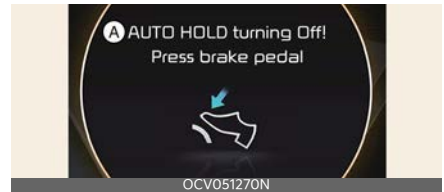

A: AUTO HOLD turning Off! Press brake pedal

*** NOTICE**

Engage the brake pedal when the above message appears for the AUTO HOLD and EPB may not activate.

If the EPB is applied while AUTO HOLD is activated because of an ESC (Electronic Stability Control) signal, a warning will sound and a message will appear.

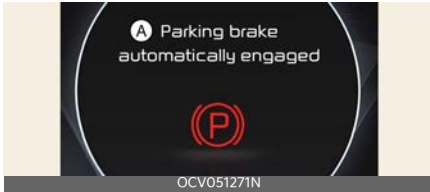

A: Parking brake automatically engaged

EPB malfunction indicator

This warning light appears if the EV button is changed to the ON position and goes off in approximately 3 seconds if the system is operating normally.



If the EPB malfunction indicator remains on, comes on while driving, or does not come on when the EV button is changed to the ON position, this indicates that the EPB may have malfunctioned.

If this occurs, have your vehicle checked by an authorized Kia dealer as soon as possible.

The EPB malfunction indicator may appear when the ESC indicator comes on to indicate that the ESC is not working properly, but it does not indicate a malfunction of the EPB.

The EPB warning light may appear if the EPB switch operates abnormally. Shut the vehicle off and turn it on again after a few minutes.

* NOTICE

The warning light will go off and the EPB switch will operate normally. However, if the EPB warning light is still on, have the system checked by an authorized Kia dealer.

If the parking brake warning light does not appear or blinks even though the EPB switch was pulled up, the EPB is not applied.

If the parking brake warning light blinks when the EPB warning light is on, press the EPB switch, then pull it up. Once

more press it back to its original position and pull it back up. If the EPB warning does not go off, have the system checked by an authorized Kia dealer.

Emergency braking

If there is a problem with the brake pedal while driving, emergency braking is possible by pulling up and holding the EPB switch.

Braking is possible only while you are holding the EPB switch.

⚠ WARNING

Do not operate the Electronic Parking Brake while the vehicle is moving except in an emergency situation. Applying the Electronic Parking Brake while the vehicle is moving at normal speeds can cause a sudden loss of control of the vehicle. If you must use the Electronic Parking Brake to stop the vehicle, use great caution in applying the brake.

*** NOTICE**

During emergency braking by the EPB, the parking brake warning light will appear to indicate that the system is operating.

If you notice a continuous noise or burning smell when the EPB is used for emergency braking, have your vehicle checked by an authorized Kia dealer.

When the EPB (Electronic Parking Brake) is not released

If the EPB does not release normally, take your vehicle to an authorized Kia dealer by loading the vehicle on a flat-bed tow truck and have the system checked.

AUTO HOLD

The AUTO HOLD maintains the vehicle in a standstill even though the brake pedal is not depressed after the driver brings the vehicle to a complete stop by depressing the brake pedal.

Applying AUTO HOLD function

1. Depress the brake pedal, start the vehicle and then press the AUTO HOLD button. The white AUTO HOLD indicator will come on indicating the system is in standby.



2. When coming to a complete stop by depressing the brake pedal, the AUTO HOLD indicator changes from white to green indicating the AUTO HOLD is engaged.
3. The vehicle will remain at a standstill even if you release the brake pedal.



4. If EPB is applied, AUTO HOLD will be released.

If you press the accelerator pedal with the shifter dial in D (Drive), or R (Reverse) when the accelerator is not depressed, the AUTO HOLD will be released automatically and the vehicle will start to move. The indicator changes from green to white indicating the AUTO

HOLD is in standby and the EPB is released.

⚠ WARNING

When driving off from AUTO HOLD by depressing the accelerator pedal, always check the surrounding area near your vehicle.

Slowly depress the accelerator pedal for a smooth launch.

Canceling AUTO HOLD function



- To cancel the AUTO HOLD operation, press the AUTO HOLD switch. The AUTO HOLD indicator will turn off.
- To cancel the AUTO HOLD operation when the vehicle is at a standstill, press the AUTO HOLD switch while depressing the brake pedal.

*** NOTICE**

- The following are conditions when the AUTO HOLD will not engage (AUTO HOLD light will not turn green and the AUTO HOLD system remains in standby):
 - The shifter dial is in P (Park)
 - The EPB is applied
- For your safety, the AUTO HOLD automatically switches to EPB under any of the following conditions (AUTO HOLD light remains white and the EPB automatically applies):
 - The vehicle is in a standstill for more than 10 minutes

- The vehicle is standing on a steep slope
- The vehicle moved for a few seconds

In these cases, the brake warning light comes on, the AUTO HOLD indicator changes from green to white, and a warning sounds and a message will appear to inform you that EPB has been automatically engaged. Before driving off again, press foot brake pedal, check the surrounding area near your vehicle and release parking brake manually with the EPB switch.

- If the AUTO HOLD indicator lights up yellow, the AUTO HOLD is not working properly. Take your vehicle to an authorized Kia dealer and have the system checked.
- If the vehicle is restarted with the AUTO HOLD button pressed, AUTO HOLD will be in the standby state.

⚠ WARNING

To reduce the risk of an accident, do not activate AUTO HOLD while driving downhill, backing up or parking your vehicle.

If there is a malfunction with the driver's door or vehicle hood or liftgate open detection system, the AUTO HOLD may not work properly.

Take your vehicle to an authorized Kia dealer and have the system checked.

* NOTICE

A click or electric brake motor whine sound may be heard while operating or releasing the EPB, but these conditions are normal and indicate that the EPB is functioning properly.

Warning messages

The AUTO HOLD function will display a warning message with sound under certain conditions.

When the EPB is applied from AUTO HOLD, a warning will sound and a message will appear.



A: Parking brake automatically engaged

When the conversion from AUTO HOLD to EPB is not working properly a warning will sound and a message will appear.

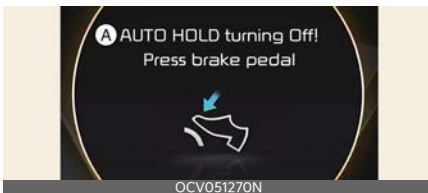

A: AUTO HOLD turning Off! Press brake pedal

* NOTICE

When this message is displayed, the AUTO HOLD and EPB may not operate. For your safety, depress the brake pedal.

If you do not apply the brake pedal when you release the AUTO HOLD by pressing the [AUTO HOLD] switch, a warning will sound and a message will appear.

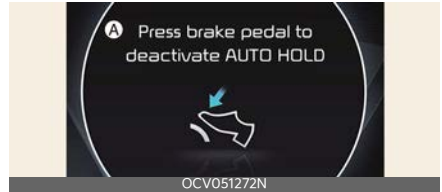

A: Press brake pedal to deactivate AUTO HOLD

⚠ WARNING

Parking Brake Use

- Never allow a passenger to touch the parking brake. If the parking brake is released unintentionally, serious injury may occur.
- All vehicles should always have the parking brake fully engaged when parked to avoid inadvertent movement of the vehicles which can injure occupants or pedestrians.

Check the brake warning light by pressing EV button ON (do not start the vehicle). This light will appear when the parking brake is applied with the EV button in the START or ON position.

(!) (P)
BRAKE

Before driving, be sure the parking brake is fully released and the brake warning light is off.

If the brake warning light remains on after the parking brake is released while the vehicle is running, there may be a malfunction in the brake system. Immediate attention is necessary.

If at all possible, cease driving the vehicle immediately. If that is not possible, use extreme caution while operating the vehicle and only continue to drive the vehicle until you can reach a safe location or repair shop.

Anti-lock Brake System (ABS)

The ABS prevents the wheels from locking. So the vehicle remains stable and can still be steered.

ABS (or ESC) will not prevent accidents due to improper or dangerous driving maneuvers. Even though vehicle control is improved during emergency braking, always maintain a safe distance between you and objects ahead. Vehicle speeds should always be reduced during extreme road conditions. The vehicle should be driven at reduced speeds in the following circumstances:

- When driving on rough, gravel or snow-covered roads
- When driving on roads where the road surface is pitted or has different surface heights.

Driving in these conditions increases the stopping distance for your vehicle.

The ABS continuously senses the speed of the wheels. If the wheels are going to lock, the ABS system repeatedly modulates the hydraulic brake pressure to the wheels.

When you apply your brakes under conditions which may lock the wheels, you may hear a "tik-tik" sound from the brakes, or feel a corresponding sensation in the brake pedal. This is normal and it means your ABS is active.

In order to obtain the maximum benefit from your ABS in an emergency situation, do not attempt to modulate your brake pressure and do not try to pump your brakes.

* NOTICE

A click sound may be heard in the vehicle compartment when the vehicle begins to move after the vehicle is started. These conditions are normal and indicate that the anti-lock brake system is functioning properly.

Even with the anti-lock brake system, your vehicle still requires sufficient stopping distance. Always maintain a safe distance from the vehicle in front of you. Always slow down when cornering. The anti-lock brake system cannot prevent accidents resulting from excessive speeds.

On loose or uneven road surfaces, operation of the anti-lock brake system may result in a longer stopping distance than for vehicles equipped with a conventional brake system.

The ABS warning light will stay on for approximately 3 seconds after the EV button is ON.



During that time, the ABS will go through self-diagnosis and the light will go off if everything is normal. If the light stays on, you may have a problem with your ABS. Contact an authorized Kia dealer as soon as possible.

When you drive on a road having poor traction, such as an icy road, and have operated your brakes continuously, the ABS will be active continuously and the ABS warning light may appear. Pull your vehicle over to a safe place and stop the vehicle.

Restart the vehicle. If the ABS warning light goes off, then your ABS system is

normal. Otherwise, you may have a problem with the ABS. Contact an authorized Kia dealer as soon as possible.

* NOTICE

When you jump start your vehicle because of a drained battery, the vehicle may not run as smoothly and the ABS warning light may turn on at the same time. This happens because of low battery voltage. It does not mean your ABS has malfunctioned.

- Do not pump your brakes!
- Have the battery recharged before driving the vehicle.

Electronic Stability Control (ESC)

The ESC system is designed to stabilize the vehicle during cornering maneuvers.



ESC checks where you are steering and where the vehicle is actually going. ESC applies the brakes on individual wheels and intervenes with the vehicle management system to stabilize the vehicle.

ESC will not prevent accidents. Excessive speed in turns, abrupt maneuvers and hydroplaning on wet surfaces can still result in serious accidents.

Only a safe and attentive driver can prevent accidents by avoiding maneuvers that cause the vehicle to lose traction. Even with ESC installed, always follow all the normal precautions for driving - including driving at safe speeds for the conditions.

⚠ WARNING

For maximum protection, always wear your seat belt. No system, no matter how advanced, can compensate for all driver error and/or driving conditions. Always drive responsibly.

The ESC system is an electronic system designed to help the driver maintain vehicle control under adverse conditions. It is not a substitute for safe driving practices. Factors including speed, road conditions and driver steering input can all affect whether ESC will be effective in preventing a loss of control. It is still your responsibility to drive and corner at reasonable speeds and to leave a sufficient margin of safety.

When you apply your brakes under conditions which may lock the wheels, you may hear a "tik-tik" sound from the brakes, or feel a corresponding sensation in the brake pedal. This is normal and it means your ESC is active.

* NOTICE

A click sound may be heard in the vehicle compartment when the vehicle begins to move after the vehicle is started. These conditions are normal and indicate that the Electronic Stability Control System is functioning properly.

Electronic stability control (ESC) operation

ESC ON condition

- When the EV button is turned ON, ESC and ESC OFF indicator lights appear for approximately 3 seconds, then ESC is turned on.

- Press the ESC OFF button for at least half a second after turning the vehicle ON to turn ESC off. (ESC OFF indicator will appear). To turn the ESC on, press the ESC OFF button (ESC OFF indicator light will go off).
- When starting the vehicle, you may hear a slight ticking sound. This is the ESC performing an automatic system self-check and does not indicate a problem.

When operating

 When the ESC is in operation, the ESC indicator light blinks.

When the Electronic Stability Control is operating properly, you can feel a slight pulsation in the vehicle. This is only the effect of brake control and indicates nothing unusual.

When moving out of the mud or driving on a slippery road, pressing the accelerator pedal may not cause the vehicle speed to increase.

Electronic stability control (ESC) operation off

 This car has 2 kinds of ESC off states.

If the vehicle stops when ESC is off, ESC remains off. Upon restarting the vehicle, the ESC will automatically turn on again.



ESC off state 1 - Traction control disabled

To turn off the traction control function and only operate the brake control function of the ESC, press the ESC OFF button (ESC OFF ) for less than 3

seconds and the ESC OFF indicator light (ESC OFF ) will appear.

When GT mode is selected, automatically changed to ESC off State 1 and the ESC OFF indicator light (ESC OFF ) comes on.

ESC off state 2 - Traction & stability control disabled

To turn off the traction control function and the brake control function of the ESC, press the ESC OFF button (ESC OFF ) for more than 3 seconds. ESC OFF indicator light (ESC OFF ) will appear and ESC OFF warning chime will sound. At this state, the car stability control function does not operate any more.

Indicator light

ESC indicator light



ESC OFF indicator light



When EV button is turned to ON, the indicator light appears, then goes off if the ESC system is operating normally. The ESC indicator light blinks whenever ESC is operating or appears when ESC fails to operate.

The ESC OFF indicator light comes on when the ESC is turned off with the button.

⚠ WARNING**Electronic Stability Control**

Drive carefully even though your vehicle has Electronic Stability Control. It can only assist you in maintaining control under certain circumstances.

ESC OFF usage**When driving**

- ESC should be turned on for daily driving whenever possible.
- To turn ESC off while driving, press the ESC OFF button while driving on a flat road surface.

⚠ WARNING**Operating ESC**

Never press the ESC OFF button while ESC is operating (ESC indicator light blinks).

If ESC is turned off while ESC is operating, the vehicle may slip out of control.

*** NOTICE**

- When operating the vehicle on a dynamometer, ensure that the ESC is turned off (ESC OFF light appeared). If the ESC is left on, it may prevent the vehicle speed from increasing, and result in false diagnosis.
- Turning the ESC off does not affect ABS or brake system operation.

Vehicle Stability Management (VSM)

This system provides further enhancements to vehicle stability and steering responses when a vehicle is driving on a slippery road or a vehicle detects changes in coefficient of friction between right wheels and left wheels when braking.

⚠ WARNING**Tire/Wheel Size**

When replacing tires and wheels, make sure they are the same size as the original tires and wheels installed. Driving with varying tire or wheel sizes may diminish any supplemental safety benefits of the VSM system.

Vehicle stability management (VSM) operation

When the VSM is in operation, ESC indicator light () blinks.

When the vehicle stability management is operating properly, you can feel a slight pulsation in the vehicle and/or abnormal steering responses (EPS- Electric Power Steering). This is only the effect of brake and EPS control and indicates nothing unusual.

The VSM does not operate when:

- Driving on a sloping road such as a gradient or incline
- Driving in reverse
- ESC OFF indicator light () remains on the instrument cluster
- EPS indicator light remains on the instrument cluster

Vehicle stability management (VSM) operation off

If you press the ESC OFF button to turn off the ESC, the VSM will also cancel and the ESC OFF indicator light () appears.

To turn on the VSM, press the button again. The ESC OFF indicator light goes out.

WARNING

Vehicle Stability Management

Drive carefully even though your vehicle has vehicle stability management. It can only assist you in maintaining control of the vehicle under certain circumstances.

Malfunction indicator

The VSM can be deactivated even if you don't cancel the VSM operation by pressing the ESC OFF button. It indicates that a malfunction has been detected somewhere in the Electric Power Steering system or VSM system. If the ESC indicator light () or EPS warning light remains on, take your vehicle to an authorized Kia dealer and have the system checked.

The Vehicle Stability Management system is not a substitute for safe driving practices but a supplementary function only. It is the responsibility of the driver to always check the speed and the distance to the vehicle ahead. Always hold the steering wheel firmly while driving. Your vehicle is designed to activate according to the driver's intention, even with installed VSM. Always follow all the normal precautions for driving at safe speeds for the conditions - including driving in inclement weather and on a slippery road.

WARNING

For maximum protection, always wear your seat belt. No system, no matter how advanced, can compensate for all driver error and/or driving conditions. Always drive responsibly.

Hill-start Assist Control (HAC)

A vehicle has the tendency to roll back on a steep hill when it starts to go after stopping. The Hill-start Assist Control (HAC) prevents the vehicle from rolling back by applying the brakes automatically for approximately 2 seconds.

The brakes are released when the accelerator pedal is depressed or after about 2 seconds.

The HAC is activated only for about 2 seconds, so when the vehicle is starting off always depress the accelerator pedal.

WARNING

Maintaining Brake Pressure on Incline

HAC does not replace the need to apply brakes while stopped on an incline. While stopped, make sure you maintain brake pressure sufficient to prevent your vehicle from rolling backward and causing an accident. Don't release the brake pedal until you are ready to accelerate forward.

Brake Assistant System (BAS)

The Brake Assistant System provides additional pressure when the brake pedal is momentarily and strongly depressed in a situation sudden braking is required while driving.

The Brake Assistant System reduces the time for ABS (Anti-Lock Brake System) control to enter and consequently reduces the braking distance, by provid-

ing additional pressure up to the point of ABS intervention.

BAS operation

- When the vehicle speed is more than 10 km/h (6 mph) and the ABS control is not entered.
- When the brake pedal is depressed strongly over a certain level.
- When the friction of the road surface is above a certain level.

BAS operation off

- The vehicle speed is below 5 km/h (3 mph).
- The brake pedal is depressed over a certain conditions.
- The friction of the road surface is below a certain level.

* NOTICE

The system may not operate

depending on driver's driving habit, the degree to which the brake pedal is depressed and the road surface condition.

Electronic Limited Slip Differential (For GT)

Electronic Limited Slip Differential controls the differential functions of the wheels to help:

- Improve steering performance when circling at high speed.
- Improve launching performance.
- Prevent slipping on rainy or snowy roads due to dissimilar friction of the left and right wheels.

⚠ WARNING

Never run the wheels with one of wheels lifted on a jack. It is extremely dangerous for a vehicle equipped with Electronic Limited Slip Differential.

Drive Mode Selection

The characteristic of Electronic Limited Slip Differential varies according to which drive mode is selected by using the DRIVE MODE switch.

Selected mode	Characteristic of e-LSD
ECO / NORMAL	NORMAL
SPORT	SPORT
GT	SPORT+
MY DRIVE	NORMAL/SPORT/SPORT+

For more details, refer to "Drive mode integrated control system" on page 6-37.

Warning Messages

Electronic Limited Slip Differential temporarily disabled due to overheating

Overheating of related parts will temporarily disable Electronic Limited Slip Differential. Wait until the vehicle cools down.

Limited-slip differential disabled. Tire diameter mismatch / Tire size mismatch. Limited-slip differential disabled. Check tire sizes

If your vehicle is equipped with different tires (size, type, etc.), the message will appear. To use Electronic Limited Slip Differential, equip the vehicle with the same tires.

Check Limited Slip Differential

When Electronic Limited Slip Differential is not working properly, this warning message will appear on the cluster LCD display. If this occurs, visit an authorized Kia dealer.

Electronic Control Suspension (if equipped)

Electronic Control Suspension controls the vehicle suspension automatically using vehicle sensors to maximize driving comfort by taking into account the driving conditions such as speed, surface of the road, cornering, stopping requirements and acceleration.

System Malfunction

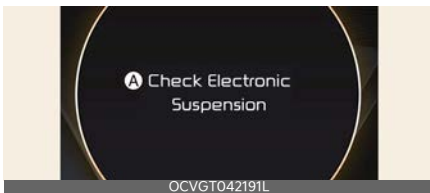

A: Check Electronic Suspension

When Electronic Control Suspension is not working properly, this warning message will appear on the cluster LCD display. If this occurs, have the system inspected by an authorized Kia dealer.

Good braking practices

Good braking practices help to drive safely and extend brake life.

- Check to be sure the parking brake is not engaged and the parking brake indicator light is out before driving away.
- Driving through water may get the brakes wet. They can also get wet when the vehicle is washed. Wet brakes can be dangerous! Your vehi-

cle will not stop as quickly if the brakes are wet. Wet brakes may cause the vehicle to pull to one side.

To dry the brakes, apply the brakes lightly until the braking action returns to normal, taking care to keep the vehicle under control at all times. If the braking action does not return to normal, stop as soon as it is safe to do so and call an authorized Kia dealer for assistance.

- Don't coast down hills with the vehicle out of gear. This is extremely hazardous. Keep the vehicle in gear at all times, use the brakes to slow down, then shift to a lower gear so that vehicle braking will help you maintain a safe speed.
- Don't "ride" the brake pedal. Resting your foot on the brake pedal while driving can be dangerous because the brakes might overheat and lose their effectiveness. It also increases the wear of the brake components.
- If a tire goes flat while you are driving, apply the brakes gently and keep the vehicle pointed straight ahead while you slow down. When you are moving slowly enough for it to be safe to do so, pull off the road and stop in a safe place.
- Be cautious when parking on a hill. Firmly engage the parking brake and place the shifter dial in P. If your vehicle is facing downhill, turn the front wheels into the curb to help keep the vehicle from rolling. If your vehicle is facing uphill, turn the front wheels away from the curb to help keep the vehicle from rolling. If there is no curb or if it is required by other conditions to keep the vehicle from rolling, block the wheels.

- Under some conditions your parking brake can freeze in the engaged position. This is most likely to happen when there is an accumulation of snow or ice around or near the rear brakes or if the brakes are wet. If there is a risk that the parking brake may freeze, apply it only temporarily while you put the shifter dial in P and block the rear wheels so the vehicle cannot roll. Then release the parking brake.
- Do not hold the vehicle on an incline with the accelerator pedal. This can cause the reduction gear to overheat. Always use the brake pedal or parking brake.
- Do not pump the brake pedal as the vehicle is equipped with ABS.
- The vehicle is equipped with electronic hydraulic brake. Due to malfunction or power instability, the brake booster may not operate normally and cause the brake pedal to feel stiff, resulting in longer braking distances. In this case, stop the vehicle by depressing the brake pedal stronger than usual. Have the system inspected by an authorized Kia dealer.
- The sound of electronic hydraulic brake operating or its motor may be heard temporarily when:
 - Repeatedly depressing the brake pedal
 - Opening driver's door

Drive mode integrated control system

The drive mode integrated control system allows the driver to select the drive mode most appropriate to the surrounding environment.

DRIVE MODE

The drive mode may be selected according to the driver's preference or road condition.



- The mode changes, as below, whenever the DRIVE MODE button is pressed.
- When restarting from ECO mode, the ECO mode is maintained, and when restarting from another mode, the mode is changed to NORMAL mode.



A: **Hold**

Selecting DRIVE MODE (For GT)

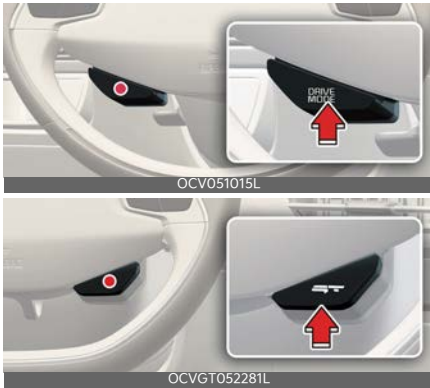

Operation

- **DRIVE MODE** will change to **NORMAL** mode when the vehicle is restarted. **ECO** mode will be maintained when the vehicle is restarted.
- Press the **DRIVE MODE** button.

Mode	Characteristics
SPORT	Provides sporty but firm riding
NORMAL	Driving on general roads, city center and highways
ECO	Improves electric energy efficiency for eco-friendly driving

- Press the **GT** button.

Mode	Characteristics
GT	Provides sportier and firm riding for maximum performance
MY DRIVE MODE	Adjusts modes of each driving system.

NORMAL mode

Normal mode is a driving with auto changing the driving mode (2WD/AWD) on road condition.

ECO mode

ECO mode is a driving mode in which the vehicle can change the engagement status of the motor according to the situation required. Auto changing the driving mode (2WD/AWD) helps improve energy efficiency.

Electric energy efficiency varies according to the driver's driving habit and road condition.

- When ECO mode is selected, the ECO indicator will appear on the instrument cluster and the color of the mood lamp will change.
- When ECO mode is activated:
 - The acceleration response may be slightly reduced if the accelerator pedal is depressed moderately.
 - The air conditioner performance may be limited.

The situations above are normal conditions when ECO mode is activated to help improve electric energy efficiency.

SPORT mode

SPORT mode is a driving mode improving driving performance by fixing AWD system.

In SPORT mode, the electric energy efficiency may decrease.

When SPORT mode is selected, the SPORT indicator will appear on the instrument cluster and the color of the mood lamp will change.

SNOW mode

SNOW mode is a driving mode improving driving performance by changing the engagement status of the motor according to the situation required. Auto changing the driving mode (2WD/AWD) helps improve driving stability.

- Press and hold the drive mode button to select SNOW mode.
- When SNOW mode is selected, the SNOW indicator will appear on the instrument cluster and the color of the mood lamp will change.
- When SNOW mode is activated, the driving power is distributed to four wheels automatically, increasing the stability of the vehicle.

▲ WARNING

- Depress the accelerator pedal softly on the snow and the ice.
- Keep appropriate distance from the vehicle in the front.
- Prevent rapid acceleration, deceleration and steering control. Abrupt driving on the snow may cause the accident.

GT mode

GT mode Provides sportier and firm riding for maximum performance.

In GT mode, the electric energy efficiency may decrease.

When GT mode is selected, the GT indicator will appear on the instrument cluster and the color of the mood lamp will change.

When GT mode is selected, automatically changed to ESC off State 1 and the ESC OFF indicator light (ESC OFF ) comes on.

MY DRIVE mode

In MY DRIVE mode, the driver can select separate modes and combine them on the infotainment system screen. Press the GT button.

Initial setting for each DRIVE MODE

* It is possible to set the driving condition for each drive mode, at the drive mode setting in Infotainment system, For more information, refer to the separately supplied manual.

DRIVE MODE	SNOW	NORMAL	ECO	SPORT	GT*	MY DRIVE*
Characteristics	Snow driving	Normal driving mode	High electric energy efficiency mode	Sporty driving mode	More sportier and firm riding mode	Adjusts modes of each driving system
Button activation	Press more than 1 second	Press	Press	Press	Press	Press
Cluster indicator	SNOW	NORMAL	ECO	SPORT	GT	MY
Climate system control	NORMAL	NORMAL	ECO/NORMAL	NORMAL	NORMAL	NORMAL
Speed Limit	-	-	-	-	-	-
Regenerative braking level	0~1	0~3				
Brake mode	NORMAL	NORMAL/SPORT	NORMAL	NORMAL/SPORT	-	NORMAL/SPORT

* : Press the **GT** button.

Drift Mode (For GT)

Drift Mode is a driving mode that automatically activates rear wheels (2WD) and brakes or Electronic Limited Slip Differential (e-LSD) to easily achieve drift with a small steering wheel angle and accelerator pedal.

Operation

- Pull and hold the left and right paddle shift levers simultaneously for more than 3 seconds.
- **Drift Mode activated** message and the Drift Mode indicator light (**DRIFT**) will appear on the instrument cluster.

Operating condition(s)



All of the following conditions should be satisfied:

- Gear in P (Park)
- ESC OFF is in state 2 (Push and hold the ESC OFF button for approximately 3~5 seconds)
- The drive mode is in SPORT or GT mode
- Fully depressing the brake pedal

Non-operating condition(s)

Drift Mode will be canceled or limited when:

- During Drift Mode operation, Drive mode is changed to a mode other than SPORT or GT mode
- During Drift Mode operation, Pulling and holding the left and right paddle shift levers simultaneously for more than 3 seconds
- ESC OFF state 2 is released

- The power down indicator light () or service warning indicator light () is appeared
- The ESC or e-LSD indicator is appeared

WARNING

- The driver should hold the responsibility to safely drive and control the vehicle when using Drift Mode.
- Use Drift Mode in wide and flat road surfaces without any pedestrians, vehicles or obstacles for the safety of vehicles and pedestrians.
- Always look ahead cautiously to prevent unexpected and sudden situations from occurring.
- If you drive in Drift Mode continuously, it may cause premature wear or damage to your tires, driveshafts, brake components and reduction gear.

Maximum Power Output Mode (For GT)

Maximum Power Output Mode optimizes temperature of power electric systems including high voltage battery to provide high acceleration performance of the GT. Available power output will be displayed on the split screen when this mode is activated.

Operation

- Select **Maximum Power Output Mode** on the infotainment system. Maximum Power Output Mode can be turned on and off with the button on the infotainment system screen.
- Maximum Power Output Mode will automatically deactivate when the vehicle is turned off (**READY** indicator off).

Operating condition(s)

Maximum Power Output Mode will be activated when all of the following conditions are satisfied.

- Vehicle is in ON position (**READY** indicator on)
- High-voltage battery is charged more than approximately 70%
- Power electric system is in normal condition

If one of the following conditions are not satisfied, Maximum Power Output Mode will automatically turn off and the button will be deactivated.

WARNING

When Maximum Power Output Mode is activated, the thermal optimization of vehicle's power electric system may consume additional power, which may affect the range and the performance of the vehicle.

All wheel drive (AWD) (if equipped)

When All Wheel Drive (AWD) is activated, driving forces are distributed appropriately to front and rear wheels. It could improve driving performance by maximizing the driving force of vehicles on severe road conditions such as steep hills, unpaved, slippery, etc.

Advantage of electronic AWD

- Improvement of straight stability
- Improvement of driving performance on curve
- Secure stability on severe condition such as wet and sandy roads.
- Improvement of energy efficiency from driving mode automatic control.

For safe AWD operation

Before driving

- Make sure all passengers are wearing seat belts.
- Sit upright and closer to the steering wheel than usual. Adjust the steering wheel to a position comfortable for you to drive.

Driving on snow-covered or icy roads

- Start off slowly by applying the accelerator pedal gently.
- Use snow tires or tire chains.
- Keep sufficient distance between your vehicle and the vehicle in front of you.
- Using the regenerative braking helps the steering on the downhill. However it is difficult to adjust the vehicle while coasting, so avoid using the third level

of regenerative braking as much as possible.

- Avoid speeding, rapid acceleration, sudden brake applications, and sharp turns to prevent skids.
- It is difficult to start again if the vehicle stops on an uphill road. Keep your distance from other vehicles and drive slowly.

Driving in sand or mud

- Maintain a slow, constant speed.
- Use tire chains driving in mud if necessary.
- Keep sufficient distance between your vehicle and the vehicle in front of you.
- Reduce vehicle speed and always check the road condition.
- Avoid speeding, rapid acceleration, sudden brake applications, and sharp turns to prevent getting stuck.

Driving up or down hills

- Driving uphill
 - Before starting off, check if it is possible to drive uphill.
 - Drive as straight as possible.
- Driving downhill
 - Do not change gear while driving downhill. Select gear before driving downhill.
 - Drive straight as possible.

Driving through water



- Try to avoid driving in deep standing water.
- If you need to drive in water, stop your vehicle, set the vehicle in Multi Terrain mode and drive under 8 km/h (5 mph).

- Do not change gear while driving in water.

Additional driving conditions

- Become familiar with the off-road conditions before driving.
- Always pay attention when driving off-road and avoid dangerous areas.
- Drive slowly when driving in heavy wind.
- Reduce vehicle speed when cornering. The center of gravity of AWD vehicles is higher than conventional 2WD vehicles, making them more likely to roll over when you rapidly turn corners.
- Always hold the steering wheel firmly when you are driving off-road.

WARNING

- If the AWD warning light () stays on the instrument cluster, your vehicle may have a malfunction with the AWD system. When the AWD warning light () appears, have your vehicle checked by an authorized Kia dealer.
- Do not drive in conditions that exceed the vehicles intended design such as challenging off-road conditions.
- Avoid high speeds when cornering or turning.
- Do not make quick steering wheel movements, such as sharp lane changes or fast, sharp turns.
- The risk of a rollover is greatly increased if you lose control of your vehicle at highway speeds.
- Loss of control often occurs if two or more wheels drop off the roadway and the driver over steers to reenter the roadway.

- In the event your vehicle leaves the roadway, do not steer sharply. Instead, slow down before pulling back into the travel lanes.
- Exercise extreme caution when driving up or down steep hills. The vehicle may flip depending on the grade, terrain and water/mud conditions.
- Do not grab the inside of the steering wheel when you are driving off-road. You may hurt your arm by a sudden steering maneuver or from steering wheel rebound due to an impact with objects on the ground. You could lose control of the steering wheel which may lead to serious injury or death.

CAUTION

Always drive slowly in water. If you drive too fast, water may get into the motor compartment, causing your vehicle to suddenly stop.

NOTE

- Do not drive in water if the level is higher than the center of the wheel.
- Check your brake condition once you are out of mud or water. Depress the brake pedal several times as you move slowly until you feel normal braking return.
- Shorten your scheduled maintenance interval if you drive in off-road conditions such as sand, mud or water (refer to "Scheduled maintenance service" on page 9-7.)
- Make sure that AWD vehicle is towed by a flatbed tow truck.
- AWD vehicles could change the engagement status of the motor according to the situation required. Auto changing the driving mode

(2WD/AWD) helps improve energy efficiency and driving stability.

- When the vehicle is stuck in snow, sand or mud, place a non-slip material under the drive wheels to provide traction OR slowly spin the wheels in forward and reverse directions which causes a rocking motion that may free the vehicle.
- When putting the tire chains to the tire, be sure to attach the chain to the two rear wheels. In this case, drive below 30 km/h (20 mph) and minimize the driving distance. High-speed or long-term driving with putting the tire chains may cause malfunction or damage to the all-wheel drive.
- If tire chains must be used, use fabric snow chain and install the tire chain after reviewing the instructions provided with the tire chains. For more information on Snow Tires and Tire Chains, refer to "Winter driving" on page 6-51.

Emergency precautions

Tires

When replacing the tires, be sure to equip all four tires with the tire and wheel of the same size, type, tread, brand and load-carrying capacity.

In case of emergency such as tire puncture, repair it using TMK (Tire Mobility Kit) for temporary use. Afterwards, have the tire be inspected by an authorized Kia dealer.

Towing

AWD vehicles must be towed with a wheel lift and dollies or flatbed equipment with all the wheels off the ground. For more information, refer to "Towing" on page 8-17.

Vehicle inspection

- When the vehicle is on a car lift, do not operate the front and rear wheels separately. All four wheels should be operated.
- Never engage the parking brake while running the vehicle on a car lift. This may damage the AWD system.

Dynamometer testing

AWD vehicle must be tested on a special four wheel chassis dynamometer.

If a 2WD roll tester must be used, perform the following procedure.



- A: Roll tester (Speedometer)
- B: Temporary free roller

Operation

1. Check the tire pressures recommended for your vehicle.
2. Place the rear wheels on the roll tester for a speedometer test as shown in the illustration.
3. Release the parking brake.
4. Place the front wheels on the temporary free roller as shown in the illustration.

⚠ WARNING

- Do not use tire and wheel with different size and type from the one originally installed on your vehicle. It can affect the safety and performance of your vehicle, which could lead to steering failure or rollover causing serious injury.

- Never start or run the vehicle while AWD vehicle is raised on a jack. The vehicle can slip or roll off of a jack causing serious injury or death to you or those nearby.
- Keep away from the front of the vehicle while the vehicle is in gear on the dynamometer. The vehicle can jump forward and cause serious injury or death.

Active air flap



OCV041202N

Active air flap system controls the air flap below the front bumper to cool the vehicle parts and improve energy efficiency.

Active air flap malfunction



OCV041192L

A: Check Active Air Flap System

The active air flap system may not operate normally if the air flap is temporarily opened due to foreign factors or if the controller is contaminated by snow or rain, etc.

When the message is popped up on the display, stop the vehicle in a safe place and check the status of the air flap.

Start the vehicle after performing the necessary work like foreign matter removal and waiting 10 minutes. If the pop-up remains up, have the vehicle inspected by an authorized Kia dealer.

⚠ CAUTION

- Regardless of the pop-up, if the air flaps aren't in the same position, stop the vehicle and wait for 10 minutes and start the vehicle and inspect the air flap.

- The active air flap system is actuated by motors. Do not disturb actuation or apply force excessively. It may cause failure.

*** NOTICE**

Active air flap system could be activate regardless of the vehicle condition. (Parking, driving, charging, etc.)

Vehicle auto-shut off function

If you forget to turn off the vehicle for a period of time, Vehicle shuts off auto-matically to prevent waste electric power.

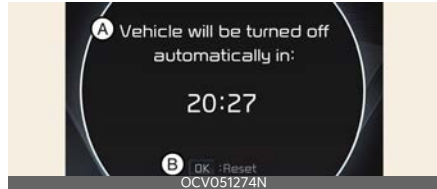

A: Vehicle will be turned off automatically in:

B: Reset

Operating conditions

Vehicle Auto-Shut Off timer activates when the following conditions are met.

- Not Auto-Shut Off timer reset condition
 - Vehicle is not in EV READY state (Only Ignition On) or the Utility Mode is on
 - Gear shift other than P (Park)
 - Stepped on the brake pedal instead of the accelerator pedal
 - Fastened driver's seat belt and passenger's seat belt
 - Passenger's seat is occupied
 - The vehicle moves (vehicle speed is above 3 km/h (2 mph))
 - When Auto-Shut Off timer is left 10minutes, the user setting mode pops up in the instrument cluster. And you can check the time left. If you push the 'OK' button, Auto-Shut off timer is reset.
- Head unit is not updating
- Outside of vehicle charging connector engaged or exterior V2L used

- If you want to deactivate auto-shut off function during interior V2L, use the Utility Mode

System operation

If the system meets operating conditions after 90 minutes, vehicle shuts off automatically.

Special driving conditions

If driving conditions deteriorate due to poor weather or road conditions, you should pay even more attention than usual to your driving.

Hazardous driving conditions

When hazardous driving conditions are encountered such as water, snow, ice, mud, sand, or similar hazards, follow these suggestions:

- Drive cautiously and allow extra distance for braking.
- Avoid sudden braking or steering.
- When braking with non-ABS brakes pump the brake pedal with a light up-and-down motion until the vehicle is stopped.
- Do not pump the brake pedal on a vehicle equipped with ABS.
- If stalled in snow, mud, or sand, use the second gear. Accelerate slowly to avoid spinning the drive wheels.
- Use sand, rock salt, or other nonslip material under the drive wheels to provide traction when stalled in ice, snow, or mud.

Reducing the risk of a rollover

This multi-purpose passenger vehicle is defined as a Sport Utility vehicles (SUV). Utility vehicles have a significantly higher rollover rate than other types of vehicles. SUV's have higher ground clearance and a narrower track to make them capable of performing in a wide variety of offroad applications.

Specific design characteristics give them a higher center of gravity than ordinary vehicles. An advantage of the higher ground clearance is a better view of the

road, which allows you to anticipate problems.

They are not designed for cornering at the same speeds as conventional passenger vehicles, any more than low-slung sports vehicles are designed to perform satisfactorily in off-road conditions. Due to this risk, driver and passengers are strongly recommended to buckle their seat belts.

In a rollover crash, an unbelted person is significantly more likely to die than a person wearing a seat belt. There are steps that a driver can make to reduce the risk of a rollover.

If at all possible, avoid sharp turns or abrupt maneuvers, do not load your roof rack with heavy cargo, and never modify your vehicle in any way.

⚠ WARNING

Rollover

As with other Sports Utility Vehicle (SUV), failure to operate this vehicle correctly may result in loss of control, an accident or vehicle rollover.

- SUVs have a significantly higher rollover rate than other types of vehicles.
- Specific design characteristics (higher ground clearance, narrower track, etc.) give this vehicle a higher center of gravity than ordinary vehicles.
- A SUV is not designed for cornering at the same speeds as conventional vehicles.
- Avoid sharp turns or abrupt maneuvers.
- In a rollover crash, an unbelted person is significantly more likely to die than a person wearing a seat belt. Make sure everyone in the vehicle is properly buckled up.

⚠ WARNING

Your vehicle is equipped with tires designed to provide safe riding and handling capability. Do not use a size and type of tire and wheel that is different from the one that is originally installed on your vehicle. It can affect the safety and performance of your vehicle, which could lead to steering failure or rollover and serious injury. When replacing the tires, be sure to equip all four tires with the tire and wheel of the same size, type, tread, brand and load-carrying capacity. If you nevertheless decide to equip your vehicle with any tire/wheel combination not recommended by Kia for off road driving, you should not use these tires for highway driving.

Rocking the vehicle

If it is necessary to rock the vehicle to free it from snow, sand, or mud, first turn the steering wheel right and left to clear the area around your front wheels. Then, shift back and forth between R (Reverse) and any forward gear.

Do not race the vehicle, and spin the wheels as little as possible. If you are still stuck after a few tries, have the vehicle pulled out by a tow vehicle to avoid vehicle overheating and possible damage to the reduction gear.

⚠ WARNING

Sudden Vehicle Movement

Do not attempt to rock the vehicle if people or objects are nearby. The vehicle may suddenly move forward or backwards as it becomes unstuck.

⚠ WARNING**Vehicle Rocking**

Prolonged rocking may cause vehicle overheating, reduction gear damage or failure, and tire damage.

⚠ WARNING**Spinning Tires**

Do not spin the wheels, especially at speeds more than 56 km/h (35 mph). Spinning the wheels at high speeds when the vehicle is stationary could cause tires to overheat, which could result in tire damage that may injure bystanders.

The ESC system should be turned OFF prior to rocking the vehicle.

Smooth cornering

Avoid braking or gear changing in corners, especially when roads are wet. Ideally, corners should always be taken under gentle acceleration. If you follow these suggestions, tire wear will be held to a minimum.

Driving at night

Because night driving presents more hazards than driving in the daylight, here are some important tips to remember:

- Slow down and keep more distance between you and other vehicles, as it may be more difficult to see at night, especially in areas where there may not be any street lights.
- Adjust your mirrors to reduce the glare from other driver's headlights.
- Keep your headlights clean and properly aimed. (On vehicles not equipped

with the automatic headlight aiming feature.) Dirty or improperly aimed headlights will make it much more difficult to see at night.

- Avoid staring directly at the headlights of oncoming vehicles. You could be temporarily blinded, and it will take several seconds for your eyes to readjust to the darkness.

Driving in the rain

Rain and wet roads can make driving dangerous, especially if you're not prepared for the slick pavement.

Here are a few things to consider when driving in the rain:

- A heavy rainfall will make it harder to see and will increase the distance needed to stop your vehicle, so slow down.
- Keep your windshield wiping equipment in good shape. Replace your windshield wiper blades when they show signs of streaking or missing areas on the windshield.
- If your tires are not in good condition, making a quick stop on wet pavement can cause a skid and possibly lead to an accident. Be sure your tires are in good shape.
- Turn on your headlights to make it easier for others to see you.
- Driving too fast through large puddles can affect your brakes. If you must go through puddles, try to drive through them slowly.
- If you believe you may have gotten your brakes wet, apply them lightly while driving until normal braking operation returns.

Driving in flooded areas

Avoid driving through flooded areas unless you are sure the water is no higher than the bottom of the wheel hub. Drive through any water slowly. Allow adequate stopping distance because brake performance may be affected.

After driving through water, dry the brakes by gently applying them several times while the vehicle is moving slowly. If the brake system is wet and has reduced braking effect or frequent sounds when braking, adjust the setting for the regenerative braking to 'O' speed with paddle shifter and apply the brake pedal lightly several times. Maintain a safe distance to dry the brake system. Setting the regenerative braking to 'O' may reduce efficiency while braking several times for brake performance, but this is normal. The regenerative braking system will be normally operated afterwards.

Driving off-road

Drive carefully off-road because your vehicle may be damaged by rocks or roots of trees. Become familiar with the off-road conditions where you are going to drive before you begin driving.

Highway driving

Tires

Adjust the tire inflation pressures to specification. Low tire inflation pressures will result in overheating and possible failure of the tires.

Avoid using worn or damaged tires which may result in reduced traction or tire failure.

Never exceed the maximum tire inflation pressure shown on the tires.

WARNING

Under/Overinflated Tires

Always check the tires for proper inflation before driving. Underinflated or overinflated tires can cause poor handling, loss of vehicle control, and sudden tire failure leading to accidents, injuries, and even death. For proper tire pressures, refer to "Tires and wheels" on page 10-4.

WARNING

Tire Tread

Always check the tire tread before driving your vehicle. Worn-out tires can result in loss of vehicle control. Worn-out tires should be replaced as soon as possible. For further information and tread limits, refer to "Tires and wheels" on page 9-18.

Winter driving

Severe weather conditions in the winter result in greater wear and other problems.

To minimize the problems of winter driving, you should follow these suggestions:

Snowy or icy conditions

To drive your vehicle in deep snow, it may be necessary to use snow tires on your tires.

If snow tires are needed, it is necessary to select tires equivalent in size and type of the original equipment tires. Failure to do so may adversely affect the safety and handling of your vehicle. Furthermore, speeding, rapid acceleration, sudden brake applications, and sharp turns are potentially very hazardous practices. During deceleration, use vehicle braking to the fullest extent. Sudden brake applications on snowy or icy roads may cause skids to occur. You need to keep sufficient distance between the vehicle in operation in front of your vehicle. Also, apply the brake gently.

Snow tires

If you mount snow tires on your vehicle, make sure they are radial tires of the same size and load range as the original tires. Mount snow tires on all four wheels to balance your vehicle's handling in all weather conditions. Keep in mind that the traction provided by snow tires on dry roads may not be as high as your vehicle's original equipment tires. You should drive cautiously even when the roads are clear. Check with the tire dealer for maximum speed recommendations.

Do not install studded tires without first checking local, state and municipal regulations for possible restrictions against their use.

WARNING

Snow Tire Size

Snow tires should be equivalent in size and type to the vehicle's standard tires. Otherwise, the safety and handling of your vehicle may be adversely affected.

Use high quality ethylene glycol coolant

Your vehicle is delivered with high quality ethylene glycol coolant in the cooling system. It is the only type of coolant that should be used because it helps prevent corrosion in the cooling system, lubricates the water pump and prevents freezing. Be sure to replace or replenish your coolant refer to "Scheduled maintenance service" on page 9-7. Before winter, have your coolant tested to assure that its freezing point is sufficient for the temperatures anticipated during the winter.

Check 12V battery and cables

Winter puts additional burdens on the battery system. Visually inspect the 12V battery and cables (refer to "12V battery" on page 9-16). The level of charge in your battery can be checked by an authorized Kia dealer or a service station.

To keep locks from freezing

To keep the locks from freezing, squirt an approved de-icer fluid or glycerine into the key opening. If a lock is covered with ice, squirt it with an approved de-

icing fluid to remove the ice. If the lock is frozen internally, you may be able to thaw it out by using a heated key. Handle the heated key with care to avoid injury.

Use approved window washer anti-freeze in system

To keep the water in the window washer system from freezing, add an approved window washer anti-freeze solution in accordance with instructions on the container. Window washer anti-freeze is available from an authorized Kia dealer and most auto parts outlets. Do not use vehicle coolant or other types of anti-freeze as these may damage the paint finish.

Don't let your parking brake freeze

Under some conditions your parking brake can freeze in the engaged position. This is most likely to happen when there is an accumulation of snow or ice around or near the rear brakes or if the brakes are wet. If there is a risk the parking brake may freeze, apply it only temporarily while you put the gear shifter dial in P (Park) and block the rear wheels so the vehicle cannot roll. Then release the parking brake.

Don't let ice and snow accumulate underneath

Under some conditions, snow and ice can build up under the fenders and interfere with the steering. When driving in severe winter conditions where this may happen, you should periodically check underneath the vehicle to be sure the movement of the front wheels and

the steering components are not obstructed.

Carry emergency equipment

Depending on the severity of the weather, you should carry appropriate emergency equipment. Some of the items you may want to carry include tow straps or chains, flashlight, emergency flares, sand, shovel, jumper cables, window scraper, gloves, ground cloth, coveralls, blanket, etc.

Trailer towing (if equipped)

If you are considering towing with your vehicle, you should first check with your country's Department of Motor Vehicles to determine their legal requirements.

Since laws vary the requirements for towing trailers, cars, or other types of vehicles or apparatus may differ. Ask an authorized Kia dealer.

WARNING

Towing a Trailer

If you don't use the correct equipment and drive improperly, you can lose control when you pull a trailer. For example, if the trailer is too heavy, the brakes may not work well - or even at all. You and your passengers could be seriously or fatally injured. Pull a trailer only if you have followed all the steps in this section.

WARNING

Weight Limits

Before towing, make sure the total trailer weight, gross combination weight, gross vehicle weight, gross axle weight and trailer tongue load are all within the limits.

CAUTION

Any part of the rear number plate or lighting devices of the vehicle must not be obscured by the mechanical coupling device. If the rear number plate and/or lighting devices can be obscured partially by any part of the mechanical coupling device, mechanical coupling devices that can not be easily removed or repositioned without use of any tool, except an easily operated (i.e. an effort not exceeding 20 N·m) release key

which is supplied by the manufacturer of the coupling device, are not permitted for use. Please note that the mechanical coupling device that is fitted and not in use must always be removed or repositioned if the rear number plate and/or rear lighting devices are obscured by any part of the mechanical coupling device.

NOTE

- The technically permissible maximum load on the rear axle(s) may be exceeded by not more than 15% and the technically permissible maximum laden mass of the vehicle may be exceeded by not more than 10% or 100 kg (220.4 lbs.), whichever value is lower. In this case, do not exceed 100 km/h (60 mph) for vehicle of category M1 or 80 km/h (50 mph) for vehicle of category N1.
- When towing a trailer, the additional load imposed at the trailer coupling device may cause the rear tire maximum load ratings to be exceeded, but not by more than 15%. In such a case, do not exceed 100 km/h (60 miles), and the rear tire pressure should be at least 0.2 bar (20 kPa) above the tire pressure(s) as recommended for normal use (i.e. without a trailer attached).

CAUTION

Pulling a trailer improperly can damage your vehicle and result in costly repairs not covered by your warranty. To pull a trailer correctly, follow the advice in this section.

Your vehicle can tow a trailer. To identify what the vehicle trailering capacity is for

your vehicle, refer to "Weight of the trailer" on page 6-59 that appears later in this section.

Remember that trailering is different than just driving your vehicle by itself. Trailering means changes in handling, durability, and electric energy economy. Successful, safe trailering requires correct equipment, and it has to be used properly.

This section contains many time-tested, important trailering tips and safety rules. Many of these are important for your safety and that of your passengers. Please read this section carefully before you pull a trailer.

Load-pulling components such as the motor, reduction gear, wheel assemblies, and tires are forced to work harder against the load of the added weight. The motor is required to operate at relatively higher speeds and under greater loads. This additional burden generates extra heat. The trailer also considerably adds wind resistance, increasing pulling requirements.



* NOTICE

Location of Trailer Mounting

The mounting hole for hitches are located on both sides of the underbody behind the rear tires.

Hitches

It's important to have the correct hitch equipment. Crosswinds, large trucks going by, and rough roads are a few reasons why you'll need the right hitch.

Here are some rules to follow:

- Do you have to make any holes in the body of your vehicle when you install a trailer hitch? If you do, then be sure to seal the holes later when you remove the hitch.
If you don't seal them, dirt and water can get into your vehicle.
- The bumpers on your vehicle are not intended for hitches. Do not attach rental hitches or other bumper-type hitches. Use only a frame-mounted hitch that does not attach to the bumper.
- Any part of the rear number plate or lighting devices of the vehicle must not be obscured by the mechanical coupling device.
- If the rear number plate and/or lighting devices can be obscured partially by any part of the mechanical coupling device, mechanical coupling devices that can not be easily removed or repositioned without use of any tools, except an easily operated (i.e. an effort not exceeding 20 N·m) release key which is supplied by the manufacturer of the coupling device, are not permitted for use.
- Please note that the mechanical coupling device that is fitted and not in use must always be removed or repositioned if the rear number plate and/or rear lighting devices are obscured by any part of the mechanical coupling device.
- Kia trailer hitch accessory is available at an authorized Kia dealer.

Safety chains

You should always attach chains between your vehicle and your trailer. Cross the safety chains under the tongue of the trailer so that the tongue will not drop to the road if it becomes separated from the hitch.

Instructions about safety chains may be provided by the hitch manufacturer or by the trailer manufacturer. Follow the manufacturer's recommendation for attaching safety chains. Always leave just enough slack so you can turn with your trailer. And, never allow safety chains drag on the ground.

Trailer brakes

If your trailer is equipped with a braking system, make sure it conforms to your country's regulations and that it is properly installed and operating correctly.

If your trailer weighs more than the maximum trailer weight without trailer brakes loaded, then it needs its own brakes and they must be adequate. Be sure to read and follow the instructions for the trailer brakes so you'll be able to install, adjust and maintain them properly.

- Don't tap into your vehicle's brake system.

WARNING

Trailer Brakes

Do not use a trailer with its own brakes unless you are absolutely certain that you have properly set up the brake system. This is not a task for amateurs. Use an experienced, competent trailer shop for this work.

Driving with a trailer

Towing a trailer requires a certain amount of experience. Before setting out for the open road, you must get to know your trailer. Acquaint yourself with the feel of handling and braking with the added weight of the trailer. And always keep in mind that the vehicle you are driving is now a good deal longer and not nearly so responsive as your vehicle is by itself.

Before you start, check the trailer hitch and platform, safety chains, electrical connector(s), lights, tires and mirror adjustment. If the trailer has electric brakes, start your vehicle and trailer moving and then apply the trailer brake controller by hand to be sure the brakes are working. This lets you check your electrical connection at the same time.

During your trip, check occasionally to be sure that the load is secure, and that the lights and trailer brakes are still working.

Following distance

Stay at least twice as far behind the vehicle ahead as you would when driving your vehicle without a trailer. This can help you avoid situations that require heavy braking and sudden turns.

Passing

You'll need more passing distance up ahead when you're towing a trailer. And, because of the increased vehicle length, you'll need to go much farther beyond the passed vehicle before you can return to your lane.

Backing up

Hold the bottom of the steering wheel with one hand. Then, to move the trailer to the left, just move your hand to the left. To move the trailer to the right, move your hand to the right. Always back up slowly and, if possible, have someone guide you.

Making turns

When you're turning with a trailer, make wider turns than normal. Do this so your trailer won't strike soft shoulders, curbs, road signs, trees, or other objects. Avoid jerky or sudden maneuvers. Signal well in advance.

Turn signals when towing a trailer

When you tow a trailer, your vehicle has to have a different turn signal flasher and extra wiring. The green arrows on your instrument panel will flash whenever you signal a turn or lane change. Properly connected, the trailer lights will also flash to alert other drivers you're about to turn, change lanes, or stop.

When towing a trailer, the green arrows on your instrument panel will flash for turns even if the bulbs on the trailer are burned out. Thus, you may think drivers behind you are seeing your signals when, in fact, they are not. It's important to check occasionally to be sure the trailer bulbs are still working. You must also check the lights every time you disconnect and then reconnect the wires.

Do not connect a trailer lighting system directly to your vehicle's lighting system. Use only an approved trailer wiring harness.

Have yourself assisted by a professional workshop in installing the wiring harness.

Visit an authorized Kia dealer.

WARNING

Failure to use an approved trailer wiring harness could result in damage to the vehicle electrical system and/or personal injury.

Detection of trailer light connection

This functionality is only given with genuine accessories (tow bar and wiring harness) that recognize when a trailer is connected and consequently inform the vehicle systems. Trailer recognition works as follows: when a trailer socket is plugged in, either the brake pedal shall be pushed or turn signal lamps activated; the electronic control unit will then detect the trailer because of the power consumption by the trailer lighting and inform the vehicle systems. When the trailer is disconnected, the brake pedal shall be pushed again or turn signal lamps activated for the control unit to be able to detect that there is no power consumption anymore by trailer lighting; the assistance systems that were turned off will automatically turn on again.

It is the driver's responsibility to ensure that all electrical connections are working and all trailer lights are operating before and during towing. You must perform manual checks.

CAUTION

Use only genuine electrical connections. Do not attempt to arbitrarily splice or directly connect the trailer wiring using

any other methods. Doing so may damage the vehicle's electrical system, resulting in malfunctions.

Driving on grades

Reduce the speed and shift to a lower gear before you start down a long or steep downgrade. If you don't shift down, you might have to use your brakes so much that they would get hot and no longer operate efficiently.

On a long uphill grade, shift down and reduce your speed to around 70 km/h (45 mph) to reduce the possibility of motor and reduction gear overheating.

CAUTION

- To prevent motor overheating: If you tow a trailer with the maximum gross vehicle weight and maximum trailer weight, it can cause the motor to overheat. When driving in such conditions, stop the vehicle until it cools down. You may proceed once the motor has cooled sufficiently. When towing a trailer, your vehicle speed may be much slower than the general flow of traffic, especially when climbing an uphill grade. Use the outer lane when towing a trailer on an uphill grade. Choose your vehicle speed according to the maximum posted speed limit for vehicles with trailers, the steepness of the grade, and your trailer weight.
 - You must decide the driving speed depending on trailer weight and uphill grade to reduce the possibility of motor and reduction gear overheating.
-

Parking on hills

Generally, if you have a trailer attached to your vehicle, you should not park your vehicle on a hill. People can be seriously or fatally injured, and both your vehicle and the trailer can be damaged if unexpectedly roll down hill.

WARNING

Parking on a Hill

Parking your vehicle on a hill with a trailer attached could cause serious injury or death, should the trailer break loose.

However, if you ever have to park your trailer on a hill, here's how to do it:

1. Pull the vehicle into the parking space. Turn the steering wheel in the direction of the curb (right if headed down hill, left if headed up hill).
2. Set the parking brake and shut off the vehicle.
3. Place chocks under the trailer wheels on the down hill side of the wheels.
4. Start the vehicle, hold the brakes, shift to neutral, release the parking brake and slowly release the brakes until the trailer chocks absorb the load.
5. Reapply the brakes, reapply the parking brake.
6. Shut off the vehicle and release the vehicle brakes but leave the parking brake set.

WARNING

Parking Brake

It can be dangerous to get out of your vehicle if the parking brake is not firmly set.

If you have left the vehicle running, the vehicle can move suddenly. You or others could be seriously or fatally injured.

When you are ready to leave after parking on a hill

1. Apply your brakes and hold the brake pedal down while you:
 - Start your vehicle;
 - Shift into gear; and
 - Release the parking brake.
2. Slowly remove your foot from the brake pedal.
3. Drive slowly until the trailer is clear of the chocks.
4. Stop and have someone pick up and store the chocks.

Maintenance when trailer towing

Your vehicle will need service more often when you regularly pull a trailer. Important items to pay particular attention to include reduction gear fluid, axle lubricant and cooling system fluid. Brake condition is another important item to frequently check. Each item is covered in this manual, and the Index will help you find them quickly. If you're trailering, it's a good idea to review these sections before you start your trip.

Don't forget to also maintain your trailer and hitch. Follow the maintenance schedule that accompanied your trailer and check it periodically. Preferably, conduct the check at the start of each day's driving. Most importantly, all hitch nuts and bolts should be tight.

CAUTION

- Due to higher load during trailer usage, overheating might occur in hot days or during uphill driving. If the

coolant gauge indicates overheating, switch off the A/C and stop the vehicle in a safe area to cool down the motor.

- When towing, check the reduction gear fluid more frequently.
 - If your vehicle is not equipped with an air conditioner, you should install a condenser fan to improve motor performance when towing a trailer.
-

If you do decide to pull a trailer

Here are some important points if you decide to pull a trailer:

- Consider using a sway control. You can ask a hitch dealer about sway control.
- Do not do any towing with your vehicle during its first 2,000 km (1,200 miles) in order to allow the motor to properly break in. Failure to heed this caution may result in serious motor or reduction gear damage.
- When towing a trailer, consult an authorized Kia dealer on additional requirements such as a towing kit, etc.
- Always drive your vehicle at a moderate speed (less than 100 km/h (60 mph)).
- On a long uphill grade, do not exceed 70 km/h (45 mph) or the posted towing speed limit, whichever is lower.
- The chart contains important considerations that have to do with weight:
- The driving range of electric vehicle is affected by the weight and the shape of the trailer. Depending on the trailer, the driving range can decrease up to 50%.

Weight of the trailer

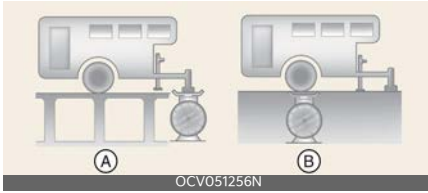

A: Tongue Load

B: Total Trailer Weight

What is the maximum safe weight of a trailer? It should never weigh more than the maximum trailer weight with trailer brakes. But even that can be too heavy. It depends on how you plan to use your trailer. For example, speed, altitude, road grades, outside temperature and how often your vehicle is used to pull a trailer are all important. The ideal trailer weight can also depend on any special equipment that you have on your vehicle.

Weight of the trailer tongue



A: Gross Axle Weight

B: Gross Vehicle Weight

The tongue load of any trailer is an important weight to measure because it affects the total gross vehicle weight (GVW) of your vehicle. This weight includes the curb weight of the vehicle, any cargo you may carry in it, and the people who will be riding in the vehicle. And if you tow a trailer, you must add the tongue load to the GVW because your vehicle will also be carrying that weight.

The trailer tongue should weigh a maximum of 10% of the total loaded trailer weight, within the limits of the maximum trailer tongue load permissible.

After you've loaded your trailer, weigh the trailer and then the tongue, separately, to see if the weights are proper. If they aren't, you may be able to correct them simply by moving some items around in the trailer.

⚠ WARNING

Trailer

- Never load a trailer with more weight in the rear than in the front. The front should be loaded with approximately 60% of the total trailer load; the rear should be loaded with approximately 40% of the total trailer load.
- Never exceed the maximum weight limits of the trailer or trailer towing equipment. Improper loading can result in damage to your vehicle and/or personal injury. Check weights and loading at a commercial scale or highway patrol office equipped with scales.
- An improperly loaded trailer can cause loss of vehicle control.

Reference weight when towing a trailer

Item		Weight (Standard type)	Weight (Extended type)	Weight (Extended type - GT)
Maximum trailer weight	With brake system	-	1,043 kg (2,300 lbs.)	1,043 kg (2,300 lbs.)
	Without brake system	-	750 kg(1,653 lbs.)	750 kg(1,653 lbs.)
Maximum tongue weight		-	100 kg (220 lbs.)	100 kg (220 lbs.)

Vehicle load limit

The vehicle load limit is displayed on the tire and loading information label on the driver's door.

Tire and loading information label

The label located on the driver's door sill gives the original tire size, cold tire pressures recommended for your vehicle, the number of people that can be in your vehicle and vehicle capacity weight.



Vehicle capacity weight:

Standard type: 375 kg (826 lbs.)

Extended type: 375 kg (826 lbs.)

Vehicle capacity weight is the maximum combined weight of occupants and cargo. If your vehicle is equipped with a trailer, the combined weight includes the tongue load.

Seating capacity:

Total: 5 persons (Front seat: 2 persons, Rear seat: 3 persons)

Seating capacity is the maximum number of occupants including a driver, your vehicle may carry.

However, the seating capacity may be reduced based upon the weight of all of the occupants, and the weight of the cargo being carried or towed.

Do not overload the vehicle as there is a limit to the total weight, or load limit

including occupants and cargo, the vehicle can carry.

Towing capacity:

- Standard type: N/A
- Extended type
 - With brake system: 1,043 kg (2,300 lbs.)
 - Without brake system: 750 kg (1,653 lbs.)

Towing capacity is the maximum trailer weight including its cargo weight, your vehicle can tow.

Cargo capacity:

The cargo capacity of your vehicle will increase or decrease depending on the weight and the number of occupants.

Steps for Determining Correct Load Limit -

- (1) Locate the statement "The combined weight of occupants and cargo should never exceed XXX kg or XXX lbs." on your vehicle's placard.
- (2) Determine the combined weight of the driver and passengers that will be riding in your vehicle.
- (3) Subtract the combined weight of the driver and passengers from XXX kg or XXX lbs.
- (4) The resulting figure equals the available amount of cargo and luggage load capacity. For example, if the "XXX" amount equals 635 kg (1400 lbs.) and there will be five 68 kg (150 lbs.) passengers in your vehicle, the amount of available cargo and luggage load capacity is 295 kg (650 lbs.). $(635 - 340) (5 \times 68) = 295 \text{ kg}$ or $1400 - 750 (5 \times 150) = 650 \text{ lbs.}$
- (5) Determine the combined weight of luggage and cargo being loaded on the vehicle. That weight may not safely

exceed the available cargo and luggage load capacity calculated in Step 4.

(6) If your vehicle will be towing a trailer, load from your trailer will be transferred to your vehicle. Consult this manual to determine how this reduces the available cargo and luggage load capacity of your vehicle.

⚠ WARNING

Loose Cargo

Do not travel with unsecured objects in the passenger compartment of your vehicle (e.g. suit cases or unsecured child seats). These items may strike an occupant during a sudden stop or crash.

Example 1



Item	Description	Total
A	Vehicle Capacity Weight	385 kg (849 lbs.)
B	Subtract Occupant Weight 150 lbs. (68 kg) × 2	136 kg (300 lbs.)
C	Available Cargo and Luggage weight	249 kg (549 lbs.)

Example 2

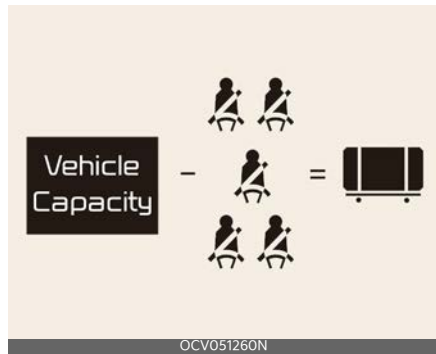

Item	Description	Total
A	Vehicle Capacity Weight	385 kg (849 lbs.)
B	Subtract Occupant Weight 150 lbs. (68 kg) × 5	340 kg (750 lbs.)
C	Available Cargo and Luggage weight	45 kg (99 lbs.)

Example 3

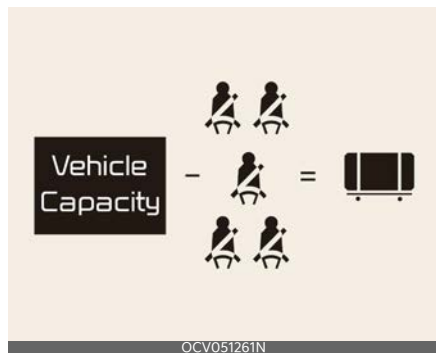

Item	Description	Total
A	Vehicle Capacity Weight	385 kg (849 lbs.)
B	Subtract Occupant Weight 161 lbs. (73 kg) × 5	365 kg (805 lbs.)
C	Available Cargo and Luggage weight	20 kg (44 lbs.)

Refer to your vehicle's tire and loading information label for specific information about your vehicle's capacity weight and seating positions. The combined weight of the driver, passengers and cargo should never exceed your vehicle's capacity weight.

Certification label

The certification label is located on the driver's door sill at the center pillar.

This label shows the maximum allowable weight of the fully loaded vehicle. This is called the GVWR (Gross Vehicle Weight Rating). The GVWR includes the weight of the vehicle, all occupants and cargo.

This label also tells you the maximum weight that can be supported by the front and rear axles, called Gross Axle Weight Rating (GAWR).

To find out the actual loads on your front and rear axles, you need to go to a weigh station and weigh your vehicle. Your dealer can help you with this. Be sure to spread out your load equally on both sides of the centerline.

⚠ WARNING

Over Loading

Never exceed the GVWR for your vehicle, the GAWR for either the front or rear axle and vehicle capacity weight. Exceeding these ratings can affect your vehicle's handling and braking ability.

The label will help you decide how much cargo and installed equipment your vehicle can carry.

If you carry items inside your vehicle - like suitcases, tools, packages, or anything else - they are moving as fast as the vehicle. If you have to stop or turn quickly, or if there is a crash, the items will keep going and can cause an injury if they strike the driver or a passenger.

⚠ WARNING

Over Loading

Do not overload your vehicle. Overloading your vehicle can cause heat buildup in your vehicle's tires and possible tire failure, increased stopping distances and poor vehicle handling--all of which may result in a crash.

*** NOTICE**

Overloading your vehicle may cause damage. Repairs would not be covered by your warranty. Do not overload your vehicle.

Vehicle weight

This chapter will guide you in the proper loading of your vehicle and/or trailer, to keep your loaded vehicle weight within its design rating capability, with or without a trailer.

Properly loading your vehicle will provide maximum return of the vehicle design performance. Before loading your vehicle, familiarize yourself with the following terms for determining your vehicle's weight ratings, with or without a trailer, from the vehicle's specifications and the compliance label:

Base curb weight This is the weight of the vehicle including a full tank of fuel and all standard equipment. It does not include passengers, cargo, or optional equipment.

Vehicle curb weight This is the weight of your new vehicle when you picked it up from your dealer plus any aftermarket equipment.

Cargo weight This figure includes all weight added to the Base Curb Weight, including cargo and optional equipment.

GAW (Gross axle weight) This is the total weight placed on each axle (front and rear) - including vehicle curb weight and all payload.

GAWR (Gross axle weight rating) This is the maximum allowable weight that can be carried by a single axle (front or rear). These numbers are shown on the compliance label. The total load on each axle must never exceed its GAWR.

GVW (Gross vehicle weight) This is the Base Curb Weight plus actual Cargo Weight plus passengers.

GVWR (Gross vehicle weight rating) This is the maximum allowable weight of the fully loaded vehicle (including all options, equipment, passengers and

cargo). The GVWR is shown on the certification label located on the driver's door sill.

Forward Collision-Avoidance Assist (FCA)	7-4
• Forward Collision-Avoidance Assist settings	7-7
• Forward Collision-Avoidance Assist operation	7-9
• Forward Collision-Avoidance Assist malfunction and limitations	7-16
Lane Keeping Assist (LKA)	7-23
• Lane Keeping Assist settings	7-23
• Lane Keeping Assist operation	7-25
• Lane Keeping Assist malfunction and limitations	7-26
Blind-Spot Collision-Avoidance Assist (BCA)	7-28
• Blind-Spot Collision-Avoidance Assist settings	7-30
• Blind-Spot Collision-Avoidance Assist operation	7-32
• Blind-Spot Collision-Avoidance Assist malfunction and limitations	7-35
Safe Exit Warning (SEW)	7-39
• Safe Exit Warning settings	7-39
• Safe Exit Warning operation	7-40
• Safe Exit Warning malfunction and limitations	7-41
Safe Exit Assist (SEA)	7-43
• Safe Exit Assist settings	7-43
• Safe Exit Assist operation	7-44
• Safe Exit Assist malfunction and limitations	7-46
Manual Speed Limit Assist (MSLA)	7-48
• Manual Speed Limit Assist operation	7-48
Intelligent Speed Limit Assist (ISLA)	7-50
• Intelligent Speed Limit Assist settings	7-50
• Intelligent Speed Limit Assist operation	7-52
• Intelligent Speed Limit Assist malfunction and limitations	7-53
Driver Attention Warning (DAW)	7-55
• Driver Attention Warning settings	7-56

7 Driver assistance system

- Driver Attention Warning operation 7-56
- Driver Attention Warning malfunction and limitations 7-59
- Blind-Spot View Monitor (BVM) 7-61**
 - Blind-Spot View Monitor settings 7-61
 - Blind-Spot View Monitor operation 7-61
 - Blind-Spot View Monitor malfunction 7-62
- Smart Cruise Control (SCC) 7-62**
 - Smart Cruise Control settings 7-63
 - Smart Cruise Control operation 7-67
 - Smart Cruise Control malfunction and limitations 7-72
- Navigation-based Smart Cruise Control (NSCC) 7-77**
 - Navigation-based Smart Cruise Control settings 7-78
 - Navigation-based Smart Cruise Control operation 7-78
 - Navigation-based Smart Cruise Control limitations 7-80
- Lane Following Assist (LFA) 7-83**
 - Lane Following Assist settings 7-83
 - Lane Following Assist operation 7-84
 - Lane Following Assist malfunction and limitations 7-85
- Highway Driving Assist (HDA) 7-86**
 - Highway Driving Assist settings 7-87
 - Highway Driving Assist operation 7-88
 - Highway Driving Assist malfunction and limitations 7-94
- Rear View Monitor (RVM) 7-96**
 - Rear View Monitor settings 7-96
 - Rear View Monitor operation 7-97
 - Rear View Monitor malfunction and limitations 7-98
- 360° camera monitoring system 7-99**
 - 360° camera monitoring system settings 7-99
 - 360° camera monitoring system operation 7-101
 - 360° camera monitoring system malfunction and limitations 7-103

Rear Cross-Traffic Collision-Avoidance Assist (RCCA).....	7-104
• Rear Cross-Traffic Collision-Avoidance Assist settings.....	7-104
• Rear Cross-Traffic Collision-Avoidance Assist operation.....	7-105
• Rear Cross-Traffic Collision-Avoidance Assist malfunction and limitations.....	7-108
Reverse Parking Distance Warning (PDW).....	7-112
• Reverse Parking Distance Warning settings.....	7-112
• Reverse Parking Distance Warning operation.....	7-113
• Reverse Parking Distance Warning malfunction and precautions.....	7-113
Forward/Reverse Parking Distance Warning (PDW).....	7-115
• Forward/Reverse Parking Distance Warning settings.....	7-116
• Forward/Reverse Parking Distance Warning operation.....	7-116
• Forward/Reverse Parking Distance Warning malfunction and precautions.....	7-118
Reverse Parking Collision-Avoidance Assist (PCA).....	7-120
• Reverse Parking Collision- Avoidance Assist settings.....	7-120
• Reverse Parking Collision- Avoidance Assist operation.....	7-121
• Reverse Parking Collision- Avoidance Assist malfunction and limitations.....	7-122
Remote Smart Parking Assist (RSPA).....	7-126
• Remote Smart Parking Assist settings.....	7-128
• Remote Smart Parking Assist operation.....	7-129
• Remote Smart Parking Assist malfunction and limitations.....	7-144
Declaration of conformity.....	7-148

Driver assistance system

* INFORMATION

Due to the infotainment software version, the description of each function of the driver assistance system may differ from the owner's manual. In this case, for detailed information on updates, refer to the separately supplied infotainment system manual.

Forward Collision-Avoidance Assist (FCA)

Basic function



Forward Collision-Avoidance Assist is designed to help detect and monitor the vehicle ahead or help detect a pedestrian or cyclist in the roadway and warn the driver that a collision is imminent with a warning message and an audible warning apply emergency braking.

In addition, if equipped with front corner radars, when driving at high speeds, Forward Collision-Avoidance Assist will help detect vehicles in front and adjacent lanes. If a collision is imminent when changing lanes, Forward Collision-Avoidance Assist may apply emergency braking to help prevent a collision. (if equipped)

Junction Turning function



Junction Turning function may help avoid a collision with an oncoming vehicle in an adjacent lane when turning left at a crossroad with the turn signal on by applying emergency braking.

Junction Crossing function (if equipped)



Junction Crossing function may help avoid a collision with oncoming vehicles on the left or right side when crossing an intersection by applying emergency braking.

Lane-Change Oncoming function (if equipped)

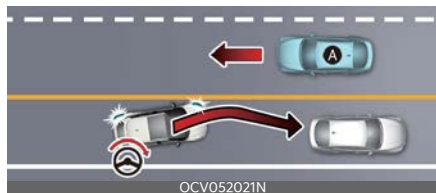

[A]: Oncoming vehicle

Lane-Change Oncoming function may help avoid a collision with an oncoming vehicle when changing lanes by assisting the driver's steering.

Lane-Change Side function (if equipped)



[A]: Front-side vehicle

Lane-Change Side function may help avoid a collision with the vehicle ahead in the next lane when changing lanes by assisting the driver's steering.

Evasive Steering Assist function (if equipped)

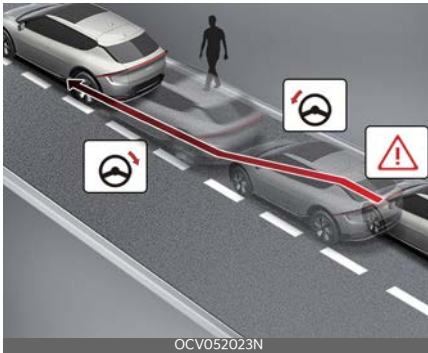

- Driver steering assist
Evasive Steering Assist function may help avoid a collision with a vehicle, pedestrian or cyclist ahead in the same lane. When a risk of collision is detected, Evasive Steering Assist function will warn the driver and if the driver steers to avoid collision it may assist the driver's steering.
- Evasive steering assist
Evasive Steering Assist function may help to avoid a collision with a pedestrian or cyclist ahead in the same lane.

When a risk of collision is detected, Evasive Steering Assist function may warn the driver and if there is space to avoid collision in the lane, it will assist the driver's steering.

Detecting sensor

Front view camera



Front radar



Front corner radar (if equipped)



Rear corner radar (if equipped)



Refer to the pictures above for the detailed location of the detecting sensors.

⚠ CAUTION

Take the following precautions to maintain optimal performance of the detecting sensors:

- Never disassemble the detecting sensor or sensor assembly, or apply any impact on it.
 - If a detecting sensors have been replaced or repaired, have the vehicle inspected by an authorized Kia dealer.
 - Never install any accessories or stickers on the front windshield, or tint the front windshield.
 - Pay extreme caution to keep the front view camera dry.
 - Never place any reflective objects (i.e. white paper, mirror) over the dashboard.
 - Do not place any objects near the front windshield or install any accessories on the front windshield. It can affect the performance of the defogging and defrosting function of the climate control system, which may prevent the Driver Assistance systems from operating.
 - Do not apply license plate frame or objects, such as a bumper sticker, film or a bumper guard, near the front radar cover.
 - Always keep the front radar and cover clean and free of dirt and debris. Use only a soft cloth to wash the vehicle. Do not spray pressurized water directly on the sensor or sensor cover.
 - If unnecessary force has been applied to the radar or around the radar, Forward Collision-Avoidance Assist may not properly operate even though a warning message does not appear on the cluster. Have the vehicle inspected by an authorized Kia dealer.
- The genuine Kia front radar sensor covers are parts with quality and performance ensured. If arbitrarily applying paint on or changing the cover, Forward Collision-Avoidance Assist may not function properly. Use only Kia Genuine Parts or those of an equivalent standard with proven quality and performance to repair or replace the radar sensor covers.
 - Vehicles equipped with front corner radar and/or rear corner radar
 - Do not apply license plate frame or objects, such as a bumper sticker, film or a bumper guard, near the front corner radar or rear corner radar.
 - The function may not work properly when the bumper has been replaced, or the surroundings of the front corner radar or rear corner radar has been damaged or paint has been applied.
 - If a trailer, carrier, etc. is installed, it may adversely affect the performance of the rear corner radar or Forward Collision-Avoidance Assist may not operate properly.
-

Forward Collision-Avoidance Assist settings

Forward Safety



A: Driver Assistance

- 1 Forward Safety
- 2 Active Assist
- 3 Warning Only
- 4 Off

With the vehicle on, select **Setup** → **Vehicle** → **Driver Assistance** → **Forward Safety** from the infotainment system screen to set whether or not to use each function.

- **Active Assist:** Forward Collision-Avoidance Assist will warn the driver with a warning message and/or audible warning depending on the collision risk levels. Braking assist or steering assist (if equipped) may be applied depending on the collision risk.
- **Warning Only:** Forward Collision-Avoidance Assist will warn the driver with a warning message and an audible warning depending on the collision risk levels. Braking and steering (if equipped) will not be assisted. The driver must apply the brake pedal or steer the vehicle if necessary.
- **Off:** Forward Collision-Avoidance Assist will turn off. The warning light (🚗) will appear on the cluster.

The driver can monitor Forward Collision-Avoidance Assist On/Off status from the Settings menu. If the warning

light (🚗) remains On when Forward Collision-Avoidance Assist is On, have the vehicle inspected by an authorized Kia dealer.

Forward Cross-Traffic Safety



A: Driver Assistance

- 1 Forward Safety
- 2 Forward Cross-Traffic Safety

With the vehicle on, select **Setup** → **Vehicle** → **Driver assistance** → **Forward safety** → **Forward Cross-Traffic Safety** from the infotainment system screen to turn on Junction Crossing function and deselect to turn off the function.

⚠ WARNING

When the vehicle is restarted, Forward Collision-Avoidance Assist will always turn on. However, if **Off** is selected, the driver should always be aware of the surroundings and drive safely.

⚠ CAUTION

- If **Warning Only** is selected, braking and steering (if equipped) is not assisted.
- The settings for Forward Safety include 'Basic function' and 'Junction Turning', 'Lane-Change Oncoming', 'Lane-Change Side' and 'Evasive Steering Assist' (if equipped).
- If Forward Safety is set to **Off**, Junction Crossing function will not operate

even when **Forward Cross-Traffic Safety** (if equipped) is selected.

*** NOTICE**

Forward Collision-Avoidance Assist will turn off when electronic stability Control (ESC) is turned off by pressing and holding the ESC OFF button. The warning light (🚗) will appear on the cluster.

Warning Timing



A: Driver Assistance

1 Warning Timing

2 Standard

3 Late

With the vehicle on, select **Setup** → **Vehicle** → **Driver Assistance** → **Warning Timing** from the infotainment system screen to change the initial warning activation time for Forward Collision-Avoidance Assist.

- **Standard:** Use in a normal driving environment. If the function operates too sensitively, set to the warning timing to **Late**.
- **Late:** The warning timing will be slow

Warning Methods



A: Driver Assistance

1 Warning Methods

2 Warning Volume

3 Haptic Warning

4 Driving Safety Priority

Warning Methods can be set when the vehicle is in ON position.

- **Warning Volume:** Select **Setup** → **Vehicle** → **Driver Assistance** → **Warning Methods** → **Warning Volume** on the infotainment system, and adjust the warning volume.

Even if you set the warning volume to 0, Warning volume will keep its volume in 1. (If steering wheel vibration equipped)

- **Haptic Warning:** Select **Setup** → **Vehicle** → **Driver Assistance** → **Warning Methods** → **Haptic Warning** on the infotainment system, and set the steering wheel vibration warning. (if equipped)
- **Driving Safety Priority:** Select **Setup** → **Vehicle Settings** → **Driver Assistance** → **Warning Methods** → **Driving Safety Priority** on the infotainment system.

For safe driving, the audio volume will temporarily decrease to warn the driver with the audible warning.

CAUTION

- Ensure that **Warning Methods** you have set may apply to the Warning Methods of other driver assistance systems.
- **Warning Methods** will maintain its last setting even if the vehicle is restarted.
- The setting menu may not be available for your vehicle depending on

the vehicle features and specifications.

- When the warning volume is 0, if you deselect **Haptic Warning**, the warning volume will be automatically adjusted to volume 2.
- With the **Haptic Warning** is deselected, if you adjust the warning volume to 0, the **Haptic Warning** will be automatically selected.

Forward Collision-Avoidance Assist operation

Basic function

The basic function for Forward Collision-Avoidance Assist is warned and controlled by the following level.

- Collision Warning
- Emergency Braking
- Stopping vehicle and ending brake control

Collision Warning



A: Collision Warning

The warning message and an audible warning will sound and the steering wheel will vibrate (if equipped) to warn the driver of a collision.

Collision Warning will operate under the following conditions depending on the collision risk level, target, and your driving speed:

- Vehicle: approximately 10~200 km/h (6~124 mph)

- Pedestrian or cyclist: approximately 10~85 km/h (6~53 mph)

Emergency braking



A: Emergency Braking

The warning message and an audible warning will sound and the steering wheel will vibrate (if equipped) to warn the driver that emergency braking will be assisted. The brake assist will be activated and it may help avoid a collision with a vehicle, pedestrian and cyclist.

Emergency Braking will be activated in following conditions depending on the target and the level of risk.

- Vehicle:

	Driving target	Stopped target
Weak braking power	Approximately 10~200 km/h (6~124 mph)	
Strong braking power	Approximately 10~85 km/h (6~53 mph)	Approximately 10~75 km/h (6~47 mph)
Strong braking power - (if equipped)*	Approximately 10~100 km/h (6~62 mph)	

- (if equipped)*: If Forward Collision-Avoidance Assist judges that avoiding collision is difficult even by changing the driving lane due to surroundings of the vehicle, it assist braking at an earlier time.

- Pedestrian or cyclist: approximately 10~65 km/h (6~40 mph)

Stopping vehicle and ending brake control



A: Drive carefully

When the vehicle is stopped due to emergency braking, the warning message will appear on the cluster.

For your safety, the driver should depress the brake pedal immediately and check the surroundings.

- Brake control will end after the vehicle is stopped by emergency braking for approximately 2 seconds.

Junction Turning function

Warning and control

The basic function for Junction Turning function is warned and controlled by the following level.

- Collision Warning
- Emergency Braking
- Stopping vehicle and ending brake control

Collision Warning



A: Collision Warning

The warning message and an audible warning will sound and the steering wheel will vibrate (if equipped) to warn the driver of a collision.

Collision Warning will be activated under the following conditions.

- Your driving speed: Approximately 10~30 km/h (6~19 mph)
- Oncoming vehicle speed: Approximately 30~70 km/h (19~44 mph)

Emergency braking



A: Emergency Braking

The warning message and an audible warning will sound and the steering wheel will vibrate (if equipped) to warn the driver that emergency braking will be assisted. The brake assist will be activated and it may help avoid a collision.

Emergency Braking will be activated under the following conditions.

- Your driving speed: Approximately 10~30 km/h (6~19 mph)
- Oncoming vehicle speed: Approximately 30~70 km/h (19~44 mph)

* NOTICE

If the driver's seat is on the left side, Junction Turning function will operate only when the driver turns left. If the driver's seat is on right side, the function will operate only when you turn right.

Stopping vehicle and ending brake control



A: Drive carefully

When the vehicle is stopped due to emergency braking, the warning message will appear on the cluster.

For your safety, the driver should depress the brake pedal immediately and check the surroundings.

- Brake control will end after the vehicle is stopped by emergency braking for approximately 2 seconds.

Junction Crossing function (if equipped)

Warning and control

The basic function for Junction Crossing function is warned and controlled by the following level.

- Collision Warning
- Emergency Braking
- Stopping vehicle and ending brake control

Collision Warning



A: Collision Warning

The warning message and an message and an audible warning will sound and the steering wheel will vibrate (if equipped) to warn the driver of a collision.

Collision Warning will be activated in following conditions.

- Your driving speed: Approximately 10~30 km/h (6~19 mph)
- Crossing vehicle speed: Approximately 10~60 km/h (6~37 mph)

Emergency braking



A: Emergency Braking

The warning message and an audible warning will sound and the steering wheel will vibrate (if equipped) to warn the driver that emergency braking will be assisted. The brake assist will be activated and it may help avoid a collision of a vehicle.

Emergency Braking will be activated in following conditions.

- Your driving speed: Approximately 10~30 km/h (6~19 mph)
- Crossing vehicle speed: Approximately 10~20 km/h (6~12 mph)

Stopping vehicle and ending brake control



A: Drive carefully

When the vehicle is stopped due to emergency braking, the **Drive carefully** warning message will appear on the cluster.

For your safety, the driver should depress the brake pedal immediately and check the surroundings.

- Brake control will end after the vehicle is stopped by emergency braking for approximately 2 seconds.

⚠ CAUTION

If the collision angle with the crossing vehicle is beyond a certain range, Junction Crossing Warning and control may be late or may not operate.

Lane-Change Oncoming function (if equipped)

Warning and control

The basic function for Lane-Change Oncoming function is warned and controlled by the following level.

- Collision Warning
- Emergency Steering

Collision Warning



A: Collision Warning

The warning message and an audible warning will sound and the steering wheel will vibrate (if equipped) to warn the driver of a collision.

Collision Warning will be activated in following conditions.

- Your driving speed: Approximately 40~145 km/h (25~90 mph)
- Oncoming vehicle speed: Approximately above 10 km/h (6 mph)
- Relative speed: Approximately below 200 km/h (124 mph)

Emergency Steering



A: Emergency Steering

To warn the driver that emergency steering will be assisted, the warning message will appear on the cluster, an

audible warning will sound and the steering wheel will vibrate (if equipped). Emergency Steering will be activated in following conditions.

- Your driving speed: Approximately 40~145 km/h (25~90 mph)
- Oncoming vehicle speed: Approximately above 10 km/h (6 mph)
- Relative speed: Approximately below 200 km/h (124 mph)

Lane-Change Side function (if equipped)

Warning and control

The basic function for Lane-Change Oncoming function is warned and controlled by the following level.

- Collision Warning
- Emergency Steering

Collision Warning



A: Collision Warning

To warn the driver of a collision, the warning message will appear on the cluster, an audible warning will sound and the steering wheel will vibrate (if equipped).

Emergency Steering will be activated in following conditions.

- Your driving speed: 40~145 km/h (25~90 mph)
- Front-side vehicle: Driving

Emergency Steering



A: Emergency Steering

To warn the driver that emergency steering will be assisted, the warning message will appear on the cluster, an audible warning will sound and the steering wheel will vibrate (if equipped). Emergency Steering will be activated in following conditions.

- Your driving speed: Approximately 40~145 km/h (25~90 mph)

⚠ CAUTION

Lane-Change Side function does not operate if the oncoming vehicle from the front side is stopped.

Evasive Steering Assist function (if equipped)

Warning and control

The basic function for Lane-Change Oncoming function is warned and controlled by the following level.

- Emergency Steering

Emergency Steering (Driver steering assist)



A: Emergency Steering

To warn the driver that emergency steering will be assisted, the warning message will appear on the cluster, an audible warning will sound and the steering wheel will vibrate (if equipped). If there is a risk of collision with a vehicle, pedestrian or cyclist in front, the steering will be assisted to help prevent collision when the driver steers the vehicle to avoid collision.

Emergency Steering will be activated in following conditions.

- Vehicle speed: 40~85 km/h (25~53 mph)

Emergency Steering (Evasive steering assist)



A: Emergency Steering

To warn the driver that emergency steering will be assisted, the warning message will appear on the cluster, an audible warning will sound and the steering wheel will vibrate (if equipped). If there is high risk of collision with a pedestrian or cyclist in front, and the vehicle speed to operate emergency braking is within the operation range, the steering will be assisted to help prevent collision when there is space to avoid collision in the driving lane.

Emergency Steering will be activated in following conditions.

- Your driving speed: 65~75 km/h (40~47 mph)

⚠ CAUTION

- The steering wheel may turn automatically when emergency steering is operating.
- Emergency steering will automatically cancel when risk factors disappear. If necessary, the driver must steer the vehicle.
- Emergency steering may not operate or may cancel during operation if the

steering wheel is held tight or steered in the opposite direction.

- When steering is assisted to avoid collision with a vehicle, pedestrian and cyclist, Evasive steering assist will be canceled if collisions with other objects (vehicles, pedestrians, or cyclists) are expected.
- Evasive steering assist may not operate if space to avoid collision in the driving lane is insufficient.

* NOTICE

For more details on warning messages, refer to "Collision Warning" on page 7-9.

▲ WARNING

- For your safety, change the Settings after parking the vehicle at a safe location.
- With **Active Assist** or **Warning Only** selected, when ESC is turned off by pressing and holding the ESC OFF button, Forward Collision-Avoidance Assist will turn off automatically. In this case, Forward Collision-Avoidance Assist cannot be set from the Settings menu and the (警告) warning light will appear on the cluster which is normal. If ESC is turned on by pressing the ESC OFF button again, Forward Collision-Avoidance Assist will maintain the last setting. Forward Collision-Avoidance Assist does not operate in all situations or cannot avoid all collisions.
- The driver has primary responsibility to control the vehicle. Do not solely depend on Forward Collision-Avoidance Assist. Rather, maintain a safe braking distance, and if necessary, depress the brake pedal to reduce driving speed or to stop the vehicle.
- Never deliberately test Forward Collision-Avoidance Assist on people, objects, etc. It may cause serious injury or death.
- Forward Collision-Avoidance Assist may not operate if the driver depresses the brake pedal to avoid collision.
- Depending on the road and driving conditions, Forward Collision-Avoidance Assist may warn the driver late or may not warn the driver.
- During Forward Collision-Avoidance Assist operation, the vehicle may stop suddenly injuring passengers and shifting loose objects. Always have the seat belt on and keep loose objects secured.
- If any other function's warning message is displayed or audible warning is generated, Forward Collision-Avoidance Assist warning message may not be displayed and audible warning may not be generated.
- You may not hear the warning sound of Forward Collision-Avoidance Assist if the surroundings are noisy.
- Forward Collision-Avoidance Assist may turn off or may not operate properly or may operate unnecessarily depending on the road conditions and the surroundings.
- Even if there is a problem with Forward Collision-Avoidance Assist, the vehicle's basic braking performance will operate normally.
- During emergency braking, braking control by Forward Collision-Avoidance Assist will automatically cancel when the driver excessively depresses

the accelerator pedal or sharply steers the vehicle.

CAUTION

- Depending on the condition of the vehicle, pedestrian and cyclist in front and the surroundings, or as the recognizable distance is reduced, the speed range to operate Forward Collision-Avoidance Assist may reduce. Forward Collision-Avoidance Assist may only warn the driver, or it may not operate.
- Forward Collision-Avoidance Assist will operate under certain conditions by determining the risk level based on the condition of the oncoming vehicle, driving direction, speed and surroundings.
- If your speed is too high or the speed difference with the other vehicle is large, Forward Collision-Avoidance Assist may be limited or may not operate properly.

WARNING

When a collision with a surrounding vehicle is expected, Lane-Change Oncoming, Lane-Change Side and Evasive Steering Assist functions will only warn the driver. (if equipped)

NOTICE

- When a collision is imminent, the Forward Collision-Avoidance Assist may assist the driver with brakes if the driver fails to brake enough.
- The images or colors may be displayed differently depending on the specifications of the instrument cluster or theme.

Forward Collision-Avoidance Assist malfunction and limitations

Forward Collision-Avoidance Assist malfunction

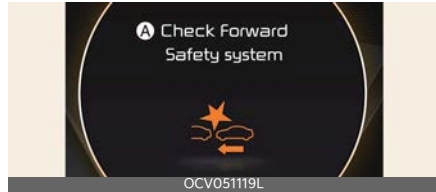

A: Check Forward Safety system

When Forward Collision-Avoidance Assist is not working properly, the warning message will appear, and the (★) and (⚠) warning lights will appear on the cluster. Have the vehicle inspected by an authorized Kia dealer.

Forward Collision-Avoidance Assist disabled

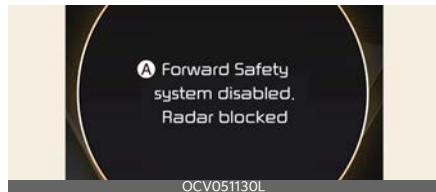

A: Forward Safety system disabled. Radar blocked



A: Forward Safety system disabled. Camera obscured

When the front windshield where the front view camera is located, front radar cover, bumper or sensor is covered with

foreign material, such as snow or rain, it can reduce the detecting performance and temporarily limit or disable Forward Collision-Avoidance Assist.

If this occurs the warning message and and the (🚗) and (⚠️) warning lights will appear on the cluster.

Forward Collision-Avoidance Assist will operate normally when snow, rain or foreign material is removed.

If Forward Collision-Avoidance Assist does not operate normally after obstruction (snow, rain, or foreign material) is removed (including trailer, carrier, etc. from the rear bumper), have the vehicle inspected by an authorized Kia dealer.

WARNING

- Even though the warning message or warning light does not appear on the cluster, Forward Collision-Avoidance Assist may not properly operate.
- Forward Collision-Avoidance Assist may not properly operate in an area (e.g. open terrain), where any substance are not detected after turning ON the vehicle.
- If the vehicle is turned off and then restarted with the sensor blocked or malfunction, Forward Collision-Avoidance Assist may not operate properly.

Limitations of Forward Collision-Avoidance Assist

Forward Collision-Avoidance Assist may not operate normally, or it may operate unexpectedly under the following circumstances:

- The detecting sensor or the surroundings are contaminated or damaged
- The temperature around the front view camera is high or low due to surrounding environment

- The camera lens is contaminated due to tinted, filmed or coated windshield, damaged glass, or sticky foreign material (sticker, bug, etc.) on the glass
- Moisture is not removed or frozen on the windshield
- Washer fluid is continuously sprayed, or the wiper is on
- Driving in heavy rain or snow, or thick fog
- The field of view of the front view camera is obstructed by sun glare
- Street light or light from an oncoming vehicle is reflected on the wet road surface, such as a puddle on the road
- An object is placed on the dashboard
- Your vehicle is being towed
- The surrounding is very bright
- The surrounding is very dark, such as in a tunnel, etc.
- The brightness changes suddenly, for example when entering or exiting a tunnel
- The brightness outside is low, and the headlamps are not on or are not bright
- Driving through steam, smoke or shadow
- Only part of the vehicle, pedestrian or cyclist is detected
- The vehicle in front is a bus, heavy truck, truck with a unusually shaped luggage, trailer, etc.
- The vehicle in front has no tail lights, tail lights are located unusually, etc.
- The brightness outside is low, and the tail lamps are not on or are not bright
- The rear of the front vehicle is small or the vehicle does not look normal, such as when the vehicle is tilted, over-

turned, or the side of the vehicle is visible, etc.

- The front vehicle's ground clearance is low or high
- A vehicle, pedestrian or cyclist suddenly cuts in front
- The bumper around the front radar is impacted, damaged or the front radar is out of position
- The temperature around the front radar is high or low
- Driving through a tunnel or on an iron bridge
- Driving in large areas where there are few vehicles or structures (i.e. desert, meadow, suburb, etc.)
- Driving through toll gate, construction areas, partially paved roads, bumpy roads, speed bumps, etc.
- Driving near areas containing metal substances, such as a construction zone, railroad, etc.
- There is a material near the front radar that strongly reflects the radar, such as a guardrail or a nearby vehicle.
- The cyclist in front is on a bicycle made of material that does not reflect on the front radar
- The vehicle in front is detected late
- The vehicle in front is suddenly blocked by an obstacle
- The vehicle in front suddenly changes lane or suddenly reduces speed
- The vehicle in front is bent out of shape
- The vehicle in front is covered with snow
- You are departing or returning to the lane
- Unstable driving

- You are on a roundabout and the vehicle in front is not detected
- You are continuously driving in a circle
- The vehicle in front has an unusual shape
- The vehicle in front is driving uphill or downhill
- The pedestrian or cyclist is not fully detected, for example, if the pedestrian is leaning over or is not fully walking upright
- The pedestrian or cyclist is wearing clothing or equipment that makes it difficult to detect as a pedestrian or cyclist
- The pedestrian or cyclist in front is moving very quickly

The illustration below shows the image the front view camera and front radar will detect as a vehicle, pedestrian and cyclist.



- The pedestrian or cyclist in front is short or is posing a low posture
- The pedestrian or cyclist in front has impaired mobility
- The pedestrian or cyclist in front is moving intersected with the driving direction
- There is a group of pedestrians, cyclists or a large crowd in front
- The pedestrian or cyclist is wearing clothing that easily blends into the background, making it difficult to detect

- The pedestrian or cyclist is difficult to distinguish from a similarly shaped structure in the surroundings
- You are driving by a pedestrian, cyclist, traffic signs, structures, etc. near an intersection
- Driving in a parking lot
- Driving through a tollgate, construction area, unpaved road, partial paved road, uneven road, speed bumps, etc.
- Driving on an incline road, curved road, etc.
- Driving through a roadside with trees or streetlights
- The adverse road conditions cause excessive vehicle vibrations while driving
- Your vehicle height is low or high due to heavy loads, abnormal tire pressure, etc.
- Driving through a narrow road where trees or grass are overgrown
- There is interference by electromagnetic waves, such as driving in an area with strong radio waves or electrical noise
- with objects, such as a bumper sticker, bumper guard, bike rack, etc.
- The bumper around the front corner radar or rear corner radar is impacted, damaged or the radar is out of position
- The front corner radar or rear corner radar is blocked by other vehicles, walls or pillars
- Driving on a highway (or motorway) ramp
- Driving on a road where the guardrail or wall is double structured
- The other vehicle drives so close behind your vehicle, or the other vehicle passes by your vehicle in close proximity
- The speed of the other vehicle is very fast that it passes by your vehicle in a short time
- Your vehicle passes by the other vehicle
- Your vehicle has started at the same time as the vehicle next to you and has accelerated
- The vehicle in the next lane moves two lanes away from you, or when the vehicle two lanes away moves to the next lane from you
- A motorcycle or bicycle is detected
- A vehicle such as a flat trailer is detected
- A big vehicle such as a bus or truck is detected
- A small moving obstacle such as a pedestrian, animal, shopping cart or a baby stroller is detected
- A vehicle with low height such as a sports car is detected
- The lane is difficult to see due to foreign material, such as rain, snow, dust, sand, oil and water puddles

Junction Crossing, Lane-Change Oncoming, Lane-Change Side, Evasive Steering Assist function (if equipped)

- The temperature around the front corner radar or rear corner radar is high or low
- A trailer or carrier is installed around the rear corner radar
- The front corner radar or rear corner radar is covered with snow, rain, dirt, etc.
- The bumper around the front corner radar or rear corner radar is covered

- The color of the lane marking is not distinguishable from the road
- There are markings on the road near the lane or the markings on the road looks similar to the lane markings
- The shadow is on the lane marking by a median strip, trees, guardrail, noise barriers, etc.
- The lane number increases or decreases, or the lane markings are crossing
- There are more than two lane markings on the road
- The lane markings are complicated or a structure substitutes for the lines, such as a construction area
- There are road markings, such as zig-zag lanes, crosswalk markings and road signs
- The lane suddenly disappears, such as at an intersection
- The lane is very wide or narrow
- There is a curb or road edges without a lane
- The vehicle in front is driving with one side on the lane marking
- The distance to the front vehicle is extremely short

⚠ WARNING

- Driving on a curved road

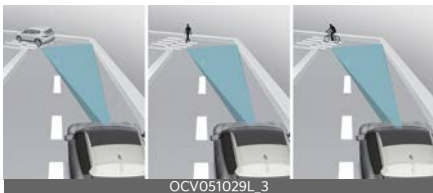

Forward Collision-Avoidance Assist may not detect other vehicles, pedestrians or cyclists in front of you on curved roads adversely affecting the

performance of the sensors. This may result in no warning, braking assist or steering assist (if equipped) when necessary.

When driving on a curved road, you must maintain a safe braking distance, and if necessary, steer the vehicle and depress the brake pedal to reduce your driving speed in order to maintain a safe distance.



Forward Collision-Avoidance Assist may detect a vehicle, pedestrian or cyclist in the next lane or outside the lane when driving on a curved road. If this occurs, Forward Collision-Avoidance Assist may unnecessarily warn the driver and control the brake or steering wheel (if equipped). Always check the traffic conditions around the vehicle.

- Driving on a sloped road



Forward Collision-Avoidance Assist may not detect other vehicles, pedestrians or cyclists in front of you while driving uphill or downhill, adversely affecting the performance of the sensors.

This may result in unnecessary warning, braking assist or steering assist (if equipped) or no warning, braking

assist or steering assist (if equipped) when necessary.
 Also, vehicle speed may rapidly decrease when a vehicle, pedestrian or cyclist ahead is suddenly detected.
 Always have your eyes on the road while driving uphill or downhill and if necessary, steer your vehicle and depress the brake pedal to reduce your driving speed in order to maintain a safe distance.

- Changing lanes



[A]: Your vehicle, [B]: Lane changing vehicle

When a vehicle moves into your lane from an adjacent lane, it cannot be detected by the sensor until it is in the sensor's detection range. Forward Collision-Avoidance Assist may not immediately detect the vehicle when the vehicle changes lanes abruptly. In this case, you must maintain a safe braking distance, and if necessary, steer your vehicle and depress the brake pedal to reduce your driving speed in order to maintain a safe distance.



[A]: Your vehicle, [B]: Lane changing vehicle,

[C]: Same lane vehicle

When a vehicle in front of you merges out of the lane, Forward Collision-Avoidance Assist may not immediately detect the vehicle that is now in front of you. In this case, you must maintain a safe braking distance, and if necessary, steer your vehicle and depress the brake pedal to reduce your driving speed in order to maintain a safe distance.

- Detecting a vehicle



If the vehicle in front of you has cargo that extends rearward from the cab,

or when the vehicle in front of you has higher ground clearance, additional special attention is required. Forward Collision-Avoidance Assist may not be able to detect the cargo extending from the vehicle. In these instances, you must maintain a safe braking distance from the rearmost object, and if necessary, steer your vehicle and depress the brake pedal to reduce your driving speed in order to maintain distance.

WARNING

- When you are towing a trailer or another vehicle, we recommend that Forward Collision-Avoidance Assist is turned off due to safety reasons.
- Forward Collision-Avoidance Assist may operate if objects that are similar in shape or characteristics to vehicles, pedestrians and cyclists are detected.
- Forward Collision-Avoidance Assist does not operate on bicycles, motorcycles, or smaller wheeled objects, such as luggage bags, shopping carts, or strollers.
- Forward Collision-Avoidance Assist may not operate normally if interfered with by strong electromagnetic waves.
- Forward Collision-Avoidance Assist may not operate for 15 seconds after the vehicle is started, or the front view camera is initialized.

This device complies with Industry Canada licence-exempt RSS standard(s).

Operation is subject to the following conditions:

1. This device may not cause interference, and
2. This device must accept any interference, including interference that may cause undesired operation of the device.
3. Changes or modifications not expressly approved by the party responsible for compliance could void the user's authority to operate the device.

Lane Keeping Assist (LKA)

Lane Keeping Assist is designed to help detect lane markings (or road edges) while driving over a certain speed. Lane Keeping Assist will warn the driver if the vehicle leaves the lane without using the turn signal, or will automatically assist the driver's steering to help prevent the vehicle from departing the lane.

Detecting sensor

Front view camera



The front view camera is used as a detecting sensor to detect lane markings (or road edges).

Refer to the picture above for the detailed location of the detecting sensor.

⚠ CAUTION

For more details on the precautions of the front view camera, refer to "Forward Collision-Avoidance Assist (FCA)" on page 7-4.

Lane Keeping Assist settings

Lane Safety



A: Driver Assistance

1 Lane Safety

2 Assist

3 Warning Only

4 Off

With the vehicle on, select or deselect **Setup** → **Vehicle** → **Driver Assistance** → **Lane Safety** from the infotainment system screen to set whether or not to use each function.

- **Assist:** Lane Keeping Assist will automatically assist the driver's steering when lane departure is detected to help prevent the vehicle from moving out of its lane.
- **Warning Only:** Lane Keeping Assist will warn the driver with an audible warning when lane departure is detected. The driver must steer the vehicle.
- **Off:** Lane Keeping Assist will turn off. The indicator (🚗) light will turn off on the cluster.

⚠ WARNING

- If **Warning Only** is selected, steering is not assisted.
- Lane Keeping Assist does not control the steering wheel when the vehicle is driven in the middle of the lane.
- The driver should always be aware of the surroundings and steer the vehicle if **Off** is selected.

Turning Lane Keeping Assist On/Off



With the vehicle on, press and hold the Lane Driving Assist button located on the steering wheel to turn on Lane Keeping Assist. The gray (LKA) indicator light will appear on the cluster.

Press and hold the button again to turn off the function.

If the vehicle is restarted, Lane Keeping Assist will maintain the last setting.

* NOTICE

- When the Lane Driving Assist button is pressed quickly, Lane Following Assist will turn on and off.
- When Lane Keeping Assist is turned off with the Lane Driving Assist button, the Lane Safety setting also changes to **Off**.

Warning Methods can be set when the vehicle is in ON position.

- **Warning Volume:** Select **Setup** → **Vehicle** → **Driver Assistance** → **Warning Methods** → **Warning Volume** on the infotainment system, and adjust the warning volume.

Even if you set the warning volume to 0, Warning volume will keep its volume in 1. (If steering wheel vibration equipped)

- **Haptic Warning:** Select **Setup** → **Vehicle** → **Driver Assistance** → **Warning Methods** → **Haptic Warning** on the infotainment system, and set the steering wheel vibration warning. (if equipped)
- **Lane Safety Audible Warning Off:** You can turn on or off the warning volume of Lane Keeping Assist. Lane Safety Audible Warning Off can be selected when both Warning Volume and haptic warning are on.
- **Driving Safety Priority:** Select **Setup** → **Vehicle Settings** → **Driver Assistance** → **Warning Methods** → **Driving Safety Priority** on the infotainment system.

For safe driving, the audio volume will temporarily decrease to warn the driver with the audible warning.

⚠ CAUTION

- Ensure that **Warning Methods** you have set apply to the Warning Methods of other driver assistance systems.
- **Warning Methods** will maintain its last setting even if the vehicle is restarted.
- The setting menu may not be available for your vehicle depending on

Warning Methods



A: Driver Assistance

1 Warning Methods

2 Warning Volume

3 Haptic Warning

4 Driving Safety Priority

the vehicle features and specifications.

- **Lane Safety Audible Warning Off** can be selected when both **Warning Volume** and **Haptic Warning** is turned on.
- With the warning volume is 0, if you deselect **Haptic Warning**, the warning volume will be automatically adjusted with volume 2.
- With the **Haptic Warning** is deselected, if you adjust the warning volume to 0, the **Haptic Warning** will be automatically selected.

and an audible warning will sound and the steering wheel will vibrate (if equipped).

- Your driving speed: Approximately 60~200 km/h (40~120 mph).

Lane Keeping Assist

- To warn the driver that the vehicle is departing from the projected lane in front, the green () indicator light will blink on the cluster, and the steering wheel will make adjustments to keep vehicle inside the lane.
- Your driving speed: Approximately 60~200 km/h (40~120 mph).

Lane Keeping Assist operation

Left



Right



Lane Keeping Assist will warn and control the vehicle with Lane Departure Warning and Lane Keeping Assist.

Lane Departure Warning

- To warn the driver that the vehicle is departing from the projected lane in front, the green () indicator light will blink on the cluster, the lane line will blink on the cluster depending on which direction the vehicle is veering,

Hands-off warning



A: Keep hands on steering wheel

If the driver takes their hands off the steering wheel for several seconds, the warning message will appear on the cluster, and an audible warning will sound in stages.

WARNING

- The steering wheel may not be assisted if the steering wheel is held tightly or the steering wheel is steered over a certain degree.
- Lane Keeping Assist does not operate at all times. It is the responsibility of the driver to safely steer the vehicle and to maintain the vehicle in its lane.
- The hands-off warning message may appear late depending on road conditions. Always have your hands on the steering wheel while driving.

- If the steering wheel is held very lightly, the hands-off warning message may appear because Lane Keeping Assist may not detect that the driver has their hands on the steering wheel.
- If you attach objects to the steering wheel, the hands-off warning may not work properly.

*** NOTICE**

- For more details on setting the instrument cluster, refer to "Instrument cluster" on page 5-61.
- When lane markings (or road edges) are detected, the lane lines on the cluster will change from gray to white and the green (🚗) indicator light will appear.
- When the lane markings (or road edges) are detected and Highway Lane Change Assist is on, the lane lines on the cluster may change to green.

Lane undetected



Lane detected



- Even though the steering is assisted by Lane Keeping Assist, the driver may control the steering wheel.
- The steering wheel may feel heavier or lighter when the steering wheel is assisted by Lane Keeping Assist than when it is not.

*** NOTICE**

The images or colors may be displayed differently depending on the specifications of the instrument cluster or theme.

Lane Keeping Assist malfunction and limitations

Lane Keeping Assist malfunction



A: Check Lane Safety system

When Lane Keeping Assist is not working properly, the warning message will appear and the yellow (🚗) indicator light will appear on the cluster. If this occurs, have the function inspected by an authorized Kia dealer.

Limitations of Lane Keeping Assist

Lane Keeping Assist may not operate normally or may operate unexpectedly under the following circumstances:

- The lane is contaminated or difficult to distinguish because,
 - The lane markings (or road edge) are covered with rain, snow, dirt, sand, oil, puddle etc.

- The color of the lane marking (or road edge) is not distinguishable from the road
- There are markings (or road edges) on the road near the lane or the markings (or road edges) on the road looks similar to the lane markings (or road edges)
- The lane marking (or road edge) is indistinct or damaged
- The shadow is on the lane marking (or road edge) by a median strip, trees, guardrail, noise barriers, etc.
- The lane number increases or decreases, or the lane markings are crossing
- There are more than two lane markings (or road edges) on the road
- The lane markings (or road edges) are complicated or a structure substitutes for the lines, such as a construction area
- There are road markings, such as zig-zag lanes, crosswalk markings and road signs
- The lane suddenly disappears, such as at the intersection
- The lane (or road width) is very wide or narrow
- There is a road edge without a lane
- There is a boundary structure in the roadway, such as a tollgate, sidewalk, curb, etc.
- The distance to the front vehicle is extremely short or the vehicle in front is covering the lane marking (or road edge)

* NOTICE

For more details on the limitations of the front view camera, refer to "Forward Collision-Avoidance Assist (FCA)" on page 7-4.

⚠ WARNING

Take the following precautions when using Lane Keeping Assist:

- The driver should hold the responsibility to safely drive and control the vehicle. Do not solely rely on the function and drive dangerously.
- The operation of Lane Keeping Assist can be canceled or not work properly depending on road conditions and surroundings. Always be cautious while driving.
- Refer to "Limitations of Lane Keeping Assist" if the lane is not detected properly.
- When you are towing a trailer or another vehicle, we recommend that Lane Keeping Assist is turned off due to safety reasons.
- If the vehicle is driven at high speed, the steering wheel will not be controlled. The driver must always follow the speed limit when using Lane Keeping Assist.
- If any other function's warning message is displayed or audible warning is generated, Lane Keeping Assist warning message may not be displayed and audible warning may not be generated.
- You may not hear the warning sound of Lane Keeping Assist if the surrounding is noisy.
- If you attach objects to the steering wheel, steering may not be assisted properly.

- Lane Keeping Assist may not operate for 15 seconds after the vehicle is started, or the Front view camera is initialized.
- Lane Keeping Assist will not operate when:
 - The turn signal or hazard warning flasher is turned on
 - The vehicle is not driven in the center of the lane when the function is turned on or right after changing a lane
 - ESC (Electronic Stability Control) or VSM (Vehicle Stability Management) is activated
 - The vehicle is driven on a sharp curved road
 - Vehicle speed is below 55 km/h (35 mph) or above 210 km/h (130 mph)
 - The vehicle makes sharp lane changes
 - The vehicle brakes suddenly

Blind-Spot Collision-Avoidance Assist (BCA) (if equipped)

Blind-Spot Collision-Avoidance Assist is designed to help detect and monitor approaching vehicles in the driver's blind spot area and warn the driver of a possible collision with a warning message and audible warning.

In addition, if there is a risk of collision when changing lanes or driving forward out of a parking space, Blind-Spot Collision-Avoidance Assist will help avoid collision by applying the brake.

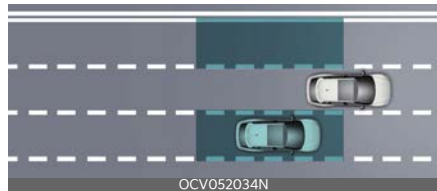

Blind-Spot Collision-Avoidance Assist helps detect and inform the driver that a vehicle is in the blind spot.

⚠ CAUTION

The detecting range may vary depending on the speed of your vehicle. However, even if there is a vehicle in the blind spot area, the function may not warn you when you pass by at high speeds.

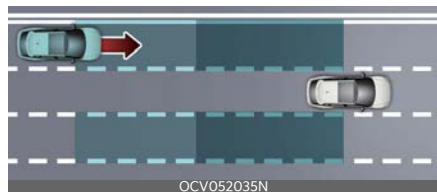

Blind-Spot Collision-Avoidance Assist helps detect and inform the driver that a vehicle is approaching at high speed from the blind spot area.

CAUTION

Warning timing may vary depending on the speed of the vehicle approaching at high speed.



When changing lanes by detecting the lane ahead, if Blind-Spot Collision-Avoidance Assist judges that there is a collision risk with an approaching vehicle in the blind spot, it will help avoid collision by applying the brake.

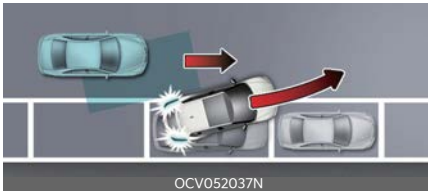

When you are driving forward out of a parking space, if Blind-Spot Collision-Avoidance Assist judges that there is a collision risk with an approaching vehicle in the blind spot, it will help avoid collision by applying the brake.

Detecting sensor

Front view camera



Rear corner radar



Refer to the picture above for the detailed location of the detecting sensors.

CAUTION

Take the following precautions to maintain optimal performance of the detecting sensor:

- Never disassemble the rear corner radar or radar assembly, or apply any impact on it.
- If there is impact on the rear corner radar or near the radar, even though the warning message does not appear on the cluster, Blind-Spot Safety system may not operate properly. Have the function be inspected by an authorized Kia dealer.
- If the rear corner radars have been replaced or repaired, have the vehicle inspected by an authorized Kia dealer.
- The genuine Kia rear bumpers which the Rear corner radar sensors are mounted are parts with quality and performance ensured. If arbitrarily applying paint on or changing the bumper, the Blind-Spot Collision-Avoidance Assist may not function properly. Use only Kia Genuine Parts or those of an equivalent standard with proven quality and performance to repair or replace the bumper.
- Do not apply license plate frame or objects, such as a bumper sticker, film or a bumper guard near the rear corner radar.

- Blind-Spot Collision-Avoidance Assist may not work properly if the bumper has been replaced, or the surroundings of the rear corner radar has been damaged or paint has been applied.
- If a trailer, carrier or other equipment is installed, it may adversely affect the performance of the rear corner radar or the function may not operate.

For more details on the precautions of the front view camera, refer to "Forward Collision-Avoidance Assist (FCA)" on page 7-4.

Blind-Spot Collision-Avoidance Assist settings

Blind-Spot Safety

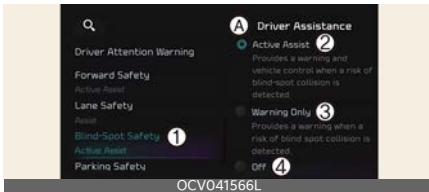

A: Driver Assistance

- 1 Blind-Spot Safety
- 2 Active Assistance
- 3 Warning Only
- 4 Off

With the vehicle on, select or deselect **Setup** → **Vehicle** → **Driver Assistance** → **Blind-Spot Safety** from the infotainment system screen to set whether or not to use each function.

- **Active Assistance:** Blind-Spot Collision-Avoidance Assist will warn the driver with a warning message and an audible warning, and braking assist will be applied depending on the collision risk levels.
- **Warning Only:** Blind-Spot Collision-Avoidance Assist will warn the driver

with a warning message and an audible warning depending on the collision risk levels. Braking will not be assisted.

- **Off:** Blind-Spot Collision-Avoidance Assist will turn off.



A: Blind-Spot Safety System is Off

When the vehicle is restarted with Blind-Spot Collision-Avoidance Assist off, the **Blind-Spot Safety System is Off** message will appear on the cluster.

If you change the setting from **Off** to **Active Assist** or **Warning Only**, the warning light on the outside rear view mirror will blink for three seconds.

In addition, if the vehicle is turned on, when Blind-Spot Collision-Avoidance Assist is set to **Active Assist** or **Warning Only**, the warning light on the outside rear view mirror will blink for three seconds.

⚠ WARNING

- If **Warning Only** is selected, braking is not assisted.
- If **Off** is selected, the driver should always be aware of the surroundings and drive safely.

* NOTICE

If the vehicle is restarted, Blind-Spot Collision-Avoidance Assist will maintain the last setting.

Warning Timing



A: **Driver Assistance**

1 Warning Timing

2 Standard

3 Late

With the vehicle on, select **Setup** → **Vehicle** → **Driver Assistance** → **Warning Timing** from the infotainment system screen to change the initial warning activation time for Blind-Spot Collision-Avoidance Assist.

To select the Warning time **Standard** or **Late**.

- **Standard:** Use under normal driving conditions. If it feels too sensitive, set the warning timing to **Late**.
- **Late:** The warning timing will be late

Warning Methods



A: **Driver Assistance**

1 Warning Methods

2 Warning Volume

3 Haptic Warning

4 Driving Safety Priority

Warning Methods can be set when the vehicle is in ON position.

- **Warning Volume:** Select **Setup** → **Vehicle** → **Driver Assistance** →

Warning Methods → **Warning Volume** on the infotainment system, and adjust the warning volume.

Even if you set the warning volume to 0, Warning volume will keep its volume in 1. (If steering wheel vibration equipped)

- **Haptic Warning:** Select **Setup** → **Vehicle** → **Driver Assistance** → **Warning Methods** → **Haptic Warning** on the infotainment system, and set the steering wheel vibration warning. (if equipped)
- **Driving Safety Priority:** Select **Setup** → **Vehicle Settings** → **Driver Assistance** → **Warning Methods** → **Driving Safety Priority** on the infotainment system.

For safe driving, the audio volume will temporarily decrease to warn the driver with the audible warning.

⚠ CAUTION

- Ensure that **Warning Methods** you have set may apply to the Warning Methods of other driver assistance systems.
- **Warning Methods** will maintain its last setting even if the vehicle is restarted.
- The setting menu may not be available for your vehicle depending on the vehicle features and specifications.
- With the warning volume is 0, if you deselect **Haptic Warning**, the warning volume will be automatically adjusted with volume 2.
- With the **Haptic Warning** is deselected, if you adjust the warning volume to 0, the **Haptic Warning** will be automatically selected.

Blind-Spot Collision-Avoidance Assist operation

Vehicle detection



- Warning light will appear in the outside rear view mirror and head-up display (if equipped) when the vehicle on both lanes is detected from the rear.

Blind-Spot Collision-Avoidance Assist will operate as following circumstances.

- Your driving speed: Above 20 km/h (12 mph)
- The speed of the vehicle in the blind spot area: Above 10 km/h (7 mph)

Collision warning

Collision warning will operate when the turn signal to change the lane in the direction of the vehicle in the blind spot area.

- To warn the driver of a collision, the warning light on the side view mirror and head-up display (if equipped) will blink. At the same time, an audible warning will sound and the steering wheel will vibrate (if equipped).
- When the turn signal is turned off or you move away from the lane, the collision warning will be canceled and the function will return to vehicle detection state.

Collision warning will operate as following circumstances.

- Your driving speed: Above 40 km/h (25 mph)

- The speed of the vehicle in the blind spot area: Above 10 km/h (7 mph)

* NOTICE

If **Warning Only** is selected from the Settings menu, the collision warning will operate when your vehicle approaches the lane in which the blind spot vehicle is detected.

⚠ WARNING

- The detecting range of the rear corner radar is determined by a standard road width, therefore, on a narrow road, the function may detect other vehicles in the two lanes away and warn you. In contrast, on a wide road, the function may not be able to detect a vehicle driving in the next lane and may not warn you.
- When the hazard warning flasher is on, the collision warning by the turn signal will not operate.

* NOTICE

- If the driver's seat is on the left side, the collision warning may occur when you turn left. If the driver's seat is on the right side, the collision warning may occur when you turn right. Maintain a proper distance with the vehicles in the lane.
- Images or colors may be displayed differently depends on the instrument cluster specifications or theme.

Collision-Avoidance Assist (while driving)



A: Emergency Braking

- To warn the driver of a collision, the warning light on the side view mirror will blink and a warning message will appear on the cluster. At the same time, an audible warning will sound, warning light on the head-up display (if equipped) will blink and the steering wheel will vibrate (if equipped). It assists in braking control to help prevent collision with the vehicle in the blind spot area.
- Collision-Avoidance Assist will be operated under the following circumstances.
 - Your driving speed: 60~200 km/h (40~120 mph)
 - Both lane markings of the driving lane are detected.

⚠ WARNING

- Collision-Avoidance Assist will be canceled under the following circumstances:
 - Your vehicle enters the next lane by a certain distance
 - Your vehicle is away from the collision risk
 - The steering wheel is sharply steered
 - The brake pedal is depressed
 - Forward Collision-Avoidance Assist is operating

- After Blind-Spot Collision-Avoidance Assist operation or changing lane, you must drive to the center of the lane. The function will not operate if the vehicle is not driven in the center of the lane.

Collision-Avoidance Assist (while departing)



A: Emergency Braking

- To warn the driver of a collision, the warning light on the outside rear view mirror will blink and a warning message will appear on the cluster. At the same time, an audible warning will sound, warning light on the head-up display (if equipped) will blink and the steering wheel will vibrate (if equipped).
- Blind-Spot Collision-Avoidance Assist will operate when your vehicle speed is below 3 km/h (2 mph) and the speed of the vehicle in the blind spot area is above 5 km/h (3 mph).
- Emergency braking will be assisted to help prevent collision with the vehicle in the blind spot area.



A: Drive carefully

When the vehicle is stopped due to emergency braking, the warning message will appear on the cluster. For your safety, the driver should depress the brake pedal immediately and check the surroundings.

- Brake control will end after the vehicle is stopped by emergency braking for approximately 2 seconds.

WARNING

Take the following precautions when using Blind-Spot Collision-Avoidance Assist:

- For your safety, change the Blind-Spot Safety system Settings after parking the vehicle at a safe location.
- If any other function's warning message is displayed or audible warning is generated, Blind-Spot Collision-Avoidance Assist's warning message may not be displayed and audible warning may not be generated.
- You may not hear the warning sound of Blind-Spot Collision-Avoidance Assist if the surrounding is noisy.
- Blind-Spot Collision-Avoidance Assist may not operate if the driver applies the brake pedal to avoid collision.
- When Blind-Spot Collision-Avoidance Assist is operating, braking control by the function will automatically cancel when the driver excessively depresses the accelerator pedal or control the steering wheel.
- During Blind-Spot Collision-Avoidance Assist operation, the vehicle may stop suddenly injuring passengers and shifting loose objects. Always have the seat belt on and keep loose objects secured.
- Even if there is a problem with Blind-Spot Collision-Avoidance Assist, the

vehicle's basic braking performance will operate normally.

- Blind-Spot Collision-Avoidance Assist does not operate in all situations or cannot avoid all collisions.
- Blind-Spot Collision-Avoidance Assist may warn the driver late or may not warn the driver depending on the road and driving conditions.
- Driver should maintain control of the vehicle at all times. Do not depend on Blind-Spot Collision-Avoidance Assist. Maintain a safe braking distance, and if necessary, depress the brake pedal to reduce driving speed or to stop the vehicle.
- The brake control may not operate properly depending on the status of ESC (Electronic Stability Control). There will only be a warning when:
 - The ESC (Electronic Stability Control) warning light is on
 - ESC (Electronic Stability Control) is engaged in a different function

NOTICE

The images or colors may be displayed differently depending on the specifications of the instrument cluster or theme.

Blind-Spot Collision-Avoidance Assist malfunction and limitations

Blind-Spot Collision-Avoidance Assist malfunction



A: Check Blind-Spot Safety system

When Blind-Spot Collision-Avoidance Assist is not working properly, the warning message will appear on the cluster for several seconds, and the master warning light (⚠) will appear. Have Blind-Spot Collision-Avoidance Assist be inspected by an authorized Kia dealer.



A: Check side view mirror warning light

When the outside rear view mirror warning light is not working properly, the warning message will appear on the cluster for several seconds, and the master warning light (⚠) will appear. Have Blind-Spot Collision-Avoidance Assist be inspected by an authorized Kia dealer.

Blind-Spot Collision-Avoidance Assist disabled

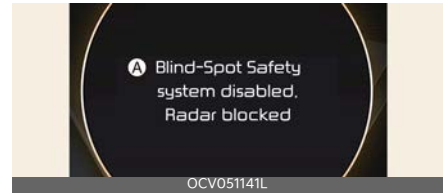

A: Blind-Spot Safety system disabled. Radar blocked

When the rear bumper around the rear corner radar or sensor is covered with foreign material, such as snow or rain, or installing a trailer or carrier, it can reduce the detecting performance and temporarily limit or disable Blind-Spot Collision-Avoidance Assist.

If this occurs, a warning message will appear on the cluster. However it is not a malfunction.

Blind-Spot Collision-Avoidance Assist will operate normally when such foreign material or trailer, other equipment is removed, and then the vehicle is restarted. Always keep it clean.

If Blind-Spot Collision-Avoidance Assist does not operate normally after vehicle rear luggage, other equipment or foreign material is removed, have Blind-Spot Collision-Avoidance Assist be inspected by an authorized Kia dealer.

⚠ WARNING

- Even though the warning message does not appear on the cluster, Blind-Spot Collision-Avoidance Assist may not properly operate.
- Blind-Spot Collision-Avoidance Assist may not properly operate in an area (e.g. open terrain) where any substance are not detected right after the vehicle is turned on, or when the

detecting sensor is blocked with foreign material right after the vehicle is turned on.

⚠ CAUTION

Turn off Blind-Spot Collision-Avoidance Assist to install a trailer, carrier, etc., or remove the trailer, carrier, etc. to use Blind-Spot Collision-Avoidance Assist.

Limitations of Blind-Spot Collision-Avoidance Assist

Blind-Spot Collision-Avoidance Assist may not operate normally as following circumstances:

- There is inclement weather, such as heavy snow, heavy rain, etc.
- The rear corner radar is covered with snow, rain, dirt, etc.
- The temperature around the rear corner radar is high or low
- The rear corner radar is covered by vehicle or pillar, walls etc.
- Driving on a highway (or motorway) ramp and tollgate.
- The road pavement (or the peripheral ground) abnormally contains metallic components (i.e. possibly due to sub-way construction).
- There is a fixed object near the vehicle, such as sound barriers, guardrails, double guardrails, central dividers, entry barriers, street lamps, signs, tunnels, walls, etc. (including double structures)
- Driving through a narrow road where trees or grass are overgrown
- Driving in large areas where there are few vehicles or structures (i.e. desert, meadow, suburb, etc.)

- Driving on a wet road surface, such as a puddle on the road
- The other vehicle drives very close behind your vehicle, or the other vehicle passes by your vehicle in close proximity
- The speed of the other vehicle is very fast that it passes by your vehicle in a short time
- Your vehicle passes by the other vehicle
- Your vehicle changes lane
- Your vehicle has started at the same time as the vehicle next to you and has accelerated
- The vehicle in the next lane moves two lanes away from you, or when the vehicle two lanes away moves to the next lane from you
- A trailer or carrier is installed around the rear corner radar
- The bumper around the rear corner radar is covered with objects, such as a bumper sticker, bike rack, etc.
- The bumper around the rear corner radar is impacted, damaged or the radar is out of position
- Your vehicle height is low or high due to heavy loads, abnormal tire pressure, etc.

Blind-Spot Collision-Avoidance Assist may not operate normally, or it may operate unexpectedly when the following objects are detected:

- A motorcycle or bicycle is detected
- A vehicle such as a flat trailer is detected
- A big vehicle such as a bus or truck is detected
- A moving obstacle such as a pedestrian, animal, shopping cart or a baby stroller is detected

- A vehicle with low height such as a sports car is detected
- Braking control may not work as following circumstances:
- The vehicle severely vibrates while driving over a bumpy road, uneven road or concrete patch
 - Driving on a slippery surface due to snow, water puddle, ice, etc.
 - The tire pressure is low or a tire is damaged
 - The brake is reworked
 - The vehicle makes abrupt lane changes

*** NOTICE**

For more details on the limitations of the front view camera, refer to "Forward Collision-Avoidance Assist (FCA)" on page 7-4 and "Lane Keeping Assist (LKA)" on page 7-23.

▲ WARNING

- Driving on a curved road



Blind-Spot Collision-Avoidance Assist may not operate properly when driving on a curved road. Blind-Spot Collision-Avoidance Assist may not detect the vehicle in the next lane.

Always pay attention to road and driving conditions while driving.



Blind-Spot Collision-Avoidance Assist may not operate properly when driving on a curved road. Blind-Spot Collision-Avoidance Assist may detect a vehicle in the same lane.

Always pay attention to road and driving conditions while driving.

- Driving where the road is merging/dividing



Blind-Spot Collision-Avoidance Assist may not operate properly when driving where the road merges or divides. Blind-Spot Collision-Avoidance Assist may not detect the vehicle in the next lane.

Always pay attention to road and driving conditions while driving on the road merges or divides.

- Driving on a sloped road

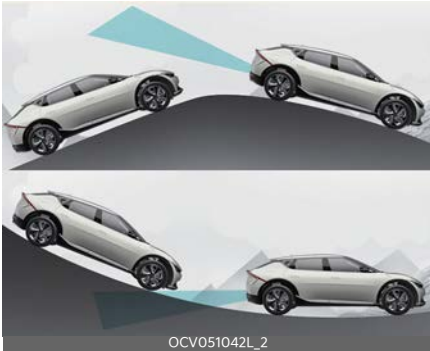

Blind-Spot Collision-Avoidance Assist may not operate properly when driving on a sloped road. Blind-Spot Collision-Avoidance Assist may not detect the vehicle in the next lane or may incorrectly detect the ground or structure.

Always pay attention to road and driving conditions while driving.

- Driving where the heights of the lanes are different



Blind-Spot Collision-Avoidance Assist may not operate properly when driving where the heights of the lanes are different. Blind-Spot Collision-Avoidance Assist may not detect the vehicle on a road with different lane heights.

Always pay attention to road and driving conditions while driving.

⚠ WARNING

- When you are towing a trailer or another vehicle, make sure that you turn off Blind-Spot Collision-Avoidance Assist.
- Blind-Spot Collision-Avoidance Assist may not operate normally if interfered by strong electromagnetic waves.
- Blind-Spot Collision-Avoidance Assist may not operate for approximately 15 seconds after the vehicle is started, or the front view camera or rear corner radars are initialized.

This device complies with Industry Canada licence-exempt RSS standard(s).

Operation is subject to the following two conditions:

1. This device may not cause interference, and
2. This device must accept any interference, including interference that may cause undesired operation of the device.

Safe Exit Warning (SEW) (if equipped)



After the vehicle stops, when an approaching vehicle from the rear area is detected as soon as a passenger opens a door, Safe Exit Warning will warn the driver with a warning message and an audible warning to help prevent a collision.

CAUTION

Warning timing may vary depending on the speed of the approaching vehicle.

Detecting sensor

Rear corner radar



Refer to the picture above for the detailed location of the detecting sensors.

CAUTION

For more details on the precautions of the rear corner radars, refer to "Blind-Spot Collision-Avoidance Assist (BCA) (if equipped)" on page 7-28.

Safe Exit Warning settings

Safe Exit Warning



- A: Driver Assistance
- 1 Blind-Spot Safety
- 2 Safe Exit Warning

With the vehicle on, select **Setup** → **Vehicle** → **Driver Assistance** → **Blind-Spot Safety** → **Safe Exit Warning** from the infotainment system screen to turn on Safe Exit Warning and deselect to turn off the function.

WARNING

The driver should always be aware of unexpected and sudden situations from occurring. If **Safe Exit Warning** is deselected, Safe Exit Warning cannot assist you.

*** NOTICE**

If the vehicle is restarted, Safe Exit Warning will maintain the last setting.

Warning Methods



- A: Driver Assistance
- 1 Warning Methods
- 2 Warning Volume

3 Driving Safety Priority

Warning Methods can be set when the vehicle is in ON position.

- **Warning Volume:** Select **Setup** → **Vehicle** → **Driver Assistance** → **Warning Methods** → **Warning Volume** on the infotainment system, and adjust the warning volume.

Even if you set the warning volume to 0, Warning volume will keep its volume in 1. (If steering wheel vibration equipped)

- **Driving Safety Priority:** Select **Setup** → **Vehicle Settings** → **Driver Assistance** → **Warning Methods** → **Driving Safety Priority** on the infotainment system.

For safe driving, the audio volume will temporarily decrease to warn the driver with the audible warning.

CAUTION

- Ensure that **Warning Methods** you have set may apply to the Warning Methods of other driver assistance systems.
- **Warning Methods** will maintain its last setting even if the vehicle is restarted.
- The setting menu may not be available for your vehicle depending on the vehicle features and specifications.

Safe Exit Warning operation

Safe Exit Warning warns the following actions.

Collision warning when exiting vehicle



A: Watch for traffic

- The warning light on the side view mirror will blink and the warning message will appear on the cluster, and an audible warning will sound.
- Safe Exit Warning will warn under the following circumstances:
 - Your driving speed: below 3 km/h (2 mph)
 - The speed of the approaching vehicle from the rear: above 6 km/h (4 mph)

WARNING

Take the following precautions when using Safe Exit Warning:

- For your safety, change the Settings after parking the vehicle at a safe location.
- If any other function's warning message is displayed or audible warning is generated, Safe Exit Warning warning message may not be displayed

and audible warning may not be generated.

- You may not hear the warning sound of Safe Exit Warning if the surrounding is noisy.
- Safe Exit Warning does not operate in all situations and cannot prevent all collisions.
- Safe Exit Warning may warn the driver late or may not warn the driver depending on driving conditions. Always check vehicle surroundings.
- The driver and passengers are responsible for accidents that occur while exiting the vehicle. Always check the surroundings before you exit the vehicle.
- Safe Exit Warning does not operate if there is a problem with Blind-Spot Collision-Avoidance Assist.
- The warning message of Blind-Spot Collision-Avoidance Assist will appear when:
 - Blind-Spot Collision-Avoidance Assist sensor or the sensor surrounding is polluted or covered
 - Blind-Spot Collision-Avoidance Assist fails to warn passengers or falsely warn passengers

* NOTICE

- After the vehicle is turned off, Safe Exit Warning operates for 3 minutes, but turns off immediately if the doors are locked.
- Images or colors may be displayed differently depending on the instrument cluster specifications or theme.

Safe Exit Warning malfunction and limitations

Safe Exit Warning malfunction



A: Check Blind-Spot Safety system

When Safe Exit Warning is not working properly, the warning message will appear on the cluster, and the master warning light (⚠) will appear on the cluster. Have Safe Exit Warning be inspected by an authorized Kia dealer.



A: Check side view mirror warning light

When the side view mirror warning light is not working properly, the warning message will appear on the cluster for several seconds, and the master warning light (⚠) will appear on the cluster. Have Safe Exit Warning be inspected by an authorized Kia dealer.

Safe Exit Warning disabled

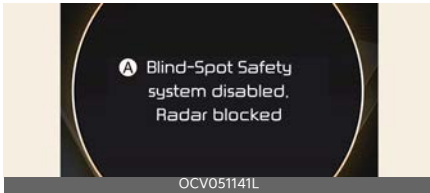

A: **Blind-Spot Safety system disabled. Radar blocked**

When the rear bumper around the rear corner radar or sensor is covered with foreign material, such as snow or rain, or installing a trailer or carrier, it can reduce the detecting performance and temporarily limit or disable Safe Exit Warning.

If this occurs, the **Blind-Spot Safety system disabled. Radar blocked** warning message will appear on the cluster.

Safe Exit Warning will operate normally when such foreign material or trailer, etc. is removed, and then the vehicle is restarted.

If Safe Exit Warning does not operate normally after it is removed, have Safe Exit Warning be inspected by an authorized Kia dealer.

WARNING

- Even though the warning message does not appear on the cluster, Safe Exit Warning may not properly operate.
- Safe Exit Warning may not properly operate in an area (e.g., open terrain), where any substance are not detected right after the vehicle is turned on, or when the detecting sensor is blocked with foreign material right after the vehicle is turned on.

CAUTION

Turn off Safe Exit Warning to install a trailer, carrier, etc., or remove the trailer, carrier, etc. to use Safe Exit Warning.

Limitations of Safe Exit Warning

Safe Exit Warning may not operate normally, or Safe Exit Warning may operate unexpectedly under the following warning.

- Getting out of the vehicle where trees or grass are overgrown
- Getting out of the vehicle where the road is wet
- The approaching vehicle is very fast or very slow

*** NOTICE**

For more details on the precautions of the rear corner radars, refer to "Blind-Spot Collision-Avoidance Assist (BCA) (if equipped)" on page 7-28.

WARNING

- Safe Exit Warning may not operate normally if interfered by strong electromagnetic waves.
- Safe Exit Warning may not operate for 3 seconds after the vehicle is restarted, or the rear corner radars are initialized.

Safe Exit Assist (SEA) (if equipped)



After the vehicle stops, when an approaching vehicle from the rear area is detected as soon as a passenger opens a door, Safe Exit Assist will warn the driver with a warning message and an audible warning to help prevent a collision.



In addition, when the electronic child safety lock button is in the LOCK position and an approaching vehicle from the rear area is detected, the electronic child safety lock button will not unlock even if the driver presses the button to prevent the rear doors from opening.

CAUTION
Warning timing may vary depending on the speed of the approaching vehicle.

Detecting sensor

Rear corner radar



Refer to the picture above for the detailed location of the detecting sensors.

CAUTION

For more details on the precautions of the rear corner radars, refer to "Blind-Spot Collision-Avoidance Assist (BCA) (if equipped)" on page 7-28.

Safe Exit Assist settings

Safe Exit Assist



A: Driver Assistance

- 1 Blind-Spot Safety
- 2 Safe Exit Assist

With the vehicle on, select **Setup** → **Vehicle** → **Driver Assistance** → **Blind-Spot Safety** → **Safe Exit Assist** from the infotainment system screen to turn on Safe Exit Assist and deselect to turn off Safe Exit Assist.

⚠ WARNING

The driver should always be aware of unexpected and sudden situations from occurring. If **Safe Exit Assist** is deselected, Safe Exit Assist cannot assist you.

*** NOTICE**

If the vehicle is restarted, Safe Exit Assist will maintain the last setting.

Warning Methods**A: Driver Assistance****1 Warning Methods****2 Warning Volume****3 Driving Safety Priority**

Warning Methods can be set when the vehicle is in ON position.

- **Warning Volume:** Select **Setup** → **Vehicle** → **Driver Assistance** → **Warning Methods** → **Warning Volume** on the infotainment system, and adjust the warning volume.

Even if you set the warning volume to 0, Warning volume will keep its volume in 1. (If steering wheel vibration equipped)

- **Driving Safety Priority:** Select **Setup** → **Vehicle Settings** → **Driver Assistance** → **Warning Methods** → **Driving Safety Priority** on the infotainment system.

For safe driving, the audio volume will temporarily decrease to warn the driver with the audible warning.

⚠ CAUTION

- Ensure that **Warning Methods** you have set may apply to the Warning Methods of other driver assistance systems.
- **Warning Methods** will maintain its last setting even if the vehicle is restarted.
- The setting menu may not be available for your vehicle depending on the vehicle features and specifications.

Safe Exit Assist operation

Safe Exit Assist warns and controls with the following actions.

Collision warning when exiting vehicle**A: Watch for traffic**

- The warning light on the side view mirror will blink and the warning message will appear on the cluster, and an audible warning will sound.
- Safe Exit Assist will warn under the following circumstances:
 - Your driving speed: below 3 km/h (2 mph)

- The speed of the approaching vehicle from the rear: above 6 km/h (4 mph)

Safe Exit Assist linked with Electronic child safety lock

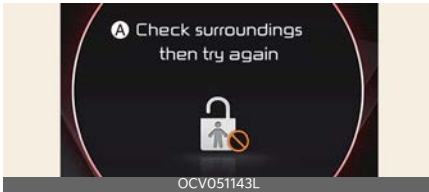

A: Check surroundings then try again

- When Electric child safety lock is operating and an approaching vehicle from the rear area is detected, the rear doors cannot be unlocked even if the driver tries to unlock the rear doors using the electronic child safety lock button. The warning light on the outside rearview mirror will blink and the warning message will appear on the cluster.
- Safe Exit Assist will warn under the following circumstances:
 - Your driving speed: below 3 km/h (2 mph)
 - The speed of the approaching vehicle from the rear: above 6 km/h (4 mph)

⚠ CAUTION

If the driver presses the electronic child lock button (🔒) again within 10 seconds after the warning message appears, Safe Exit Assist judges that the driver has unlocked the door and the door will open regardless of vehicles approaching. The electronic child safety lock will turn off (button indicator OFF). Always check the surroundings before turning

off the electronic child safety lock button.

* NOTICE

If a rear door is opened from the outside, it will open regardless of Safe Exit Assist operation.

⚠ WARNING

Take the following precautions when using Safe Exit Assist:

- For your safety, change the Settings after parking the vehicle at a safe location.
- If any other function's warning message is displayed or audible warning is generated, Safe Exit Assist warning message may not be displayed and audible warning may not be generated.
- You may not hear the warning sound of Safe Exit Assist if the surrounding is noisy.
- Safe Exit Assist does not operate in all situations or cannot prevent all collisions.
- Safe Exit Assist may warn the driver late or may not warn the driver depending on the road and driving conditions. Always check vehicle surroundings.
- The driver and passengers are responsible for accidents that occur while exiting the vehicle. Always check the surroundings before you exit the vehicle.
- Never deliberately operate Safe Exit Assist. Doing so may lead to serious injury or death.
- Safe Exit Assist does not operate if there is a problem with Blind-Spot Collision-Avoidance Assist.

- The warning message of Blind-Spot Collision-Avoidance Assist will appear when:
 - Blind-Spot Collision-Avoidance Assist sensor or the sensor surrounding is polluted or covered
 - Blind-Spot Collision-Avoidance Assist fails to warn passengers or falsely warn passengers

*** NOTICE**

- After the vehicle is turned off, Safe Exit Assist operates for 3 minutes, but turns off immediately if the doors are locked.
- Images or colors may be displayed differently depends on the instrument cluster specifications or theme.

Safe Exit Assist malfunction and limitations

Safe Exit Assist malfunction

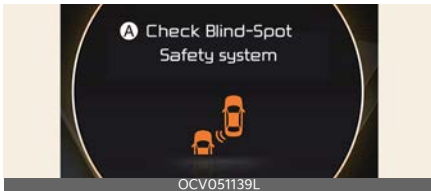

A: Check Blind-Spot Safety system

When Safe Exit Assist is not working properly, the warning message will appear and (A) warning lights will appear on the cluster, and Safe Exit Assist will turn off automatically or Safe Exit Assist will be limited. Have Safe Exit Assist inspected by an authorized Kia dealer.



A: Check side view mirror warning light

When the side view mirror warning light is not working properly, the warning message will appear on the cluster for several seconds, and (A) warning light will appear on the cluster. Have Safe Exit Assist inspected by an authorized Kia dealer.

Safe Exit Assist disabled

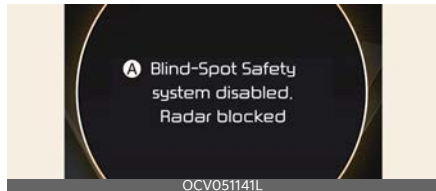

A: Blind-Spot Safety system disabled. Radar blocked

When the rear bumper around the rear corner radar or sensor is covered with foreign material, such as snow or rain, or installing a trailer or carrier, it can reduce the detecting performance and temporarily limit or disable Safe Exit Assist.

If this occurs, the **Blind-Spot Safety system disabled. Radar blocked** warning message will appear on the cluster. Safe Exit Assist will operate normally when such foreign material or trailer, etc. is removed, and then the vehicle is restarted.

If Safe Exit Assist does not operate normally after it is removed, have Safe Exit

Assist inspected by an authorized Kia dealer.

⚠ WARNING

- Even though the warning message does not appear on the cluster, Safe Exit Assist may not properly operate.
- Safe Exit Assist may not properly operate in an area (e.g., open terrain), where any substance are not detected right after the vehicle is turned on, or when the detecting sensor is blocked with foreign material right after the vehicle is turned on.

⚠ CAUTION

Turn off Safe Exit Assist to install a trailer, carrier, other equipment, or remove the trailer, carrier, etc. to use Safe Exit Assist.

Limitations of Safe Exit Assist

Safe Exit Assist may not operate normally, or Safe Exit Assist may operate unexpectedly under the following circumstances:

- Getting out of the vehicle where trees or grass are overgrown
- Getting out of the vehicle where the road is wet
- The approaching vehicle is very fast or very slow

*** NOTICE**

For more details on the limitations of the rear corner radar, refer to "Blind-Spot Collision-Avoidance Assist (BCA) (if equipped)" on page 7-28.

⚠ WARNING

- Safe Exit Assist may not operate normally if interfered by strong electromagnetic waves.
- Safe Exit Assist may not operate for 3 seconds after the vehicle is started, or the rear corner radars are initialized.

Manual Speed Limit Assist (MSLA)

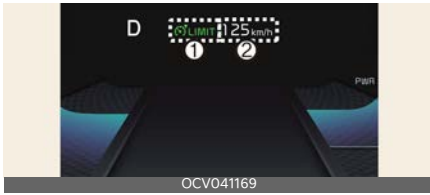

- 1 Speed Limit indicator
- 2 Set speed

You can set the speed limit when you do not want to drive over a specific speed. If you drive over the preset speed limit, the warning function operates (set speed limit will blink and chime will sound) until the vehicle speed returns within the speed limit.

Manual Speed Limit Assist operation

Setting speed limit

1. Press and hold Driving Assist (DA) button at the desired speed.



The speed limit indicator (LIMIT) light will appear and the set speed limit will be displayed on the cluster.

2. Push the + switch up or - switch down, and release it at the desired speed. Push the + switch up or - switch down and hold it. The speed will increase or decrease to the nearest multiple of five (multiple of ten in km/h) at first, and then increase or decrease by 10 km/h (5 mph).



3. If you would like to drive over the preset speed limit, depress the accelerator pedal.

The set speed limit (1) will blink and chime will sound until you return the vehicle speed within the speed limit.



* NOTICE

When the accelerator pedal is not depressed beyond the pressure point, vehicle speed will maintain within the speed limit.

Temporarily pausing Manual Speed Limit Assist



Press the (||) switch to temporarily pause the set speed limit. The set speed limit will turn off but the Speed Limit indicator (LIMIT) will stay on.

Resuming Manual Speed Limit Assist



To resume Manual Speed Limit Assist after the function was paused, operate the +, -, (i) switch.

If you push the + switch up or - switch down, vehicle speed will be set to the current speed on the cluster.

If you push the (i) switch, vehicle speed will resume to the preset speed.

Turning off Manual Speed Limit Assist



Press the Driving Assist (🚗) button to turn Manual Speed Limit Assist off. The Speed Limit indicator (LIMIT) will go off.

Always press the Driving Assist (🚗) button to turn Manual Speed Limit Assist off when not in use.

⚠️ WARNING

Take the following precautions when using Manual Speed Limit Assist:

- Always set the vehicle speed to the speed limit in your country.
- Keep Manual Speed Limit Assist off when the function is not in use, to avoid inadvertently setting a speed.

Check that the Speed Limit indicator (LIMIT) is off.

- Manual Speed Limit Assist does not substitute for proper and safe driving. It is the responsibility of the driver to always drive safely and should always be aware of unexpected and sudden situations from occurring. Pay attention to the road conditions at all times.

*** NOTICE**

The images or colors may be displayed differently depending on the specifications of the instrument cluster or theme.

Intelligent Speed Limit Assist (ISLA) (if equipped)

Intelligent Speed Limit Assist uses information from the detected road sign and navigation system to inform the driver of the speed limit and additional road signs of the current road. Also, the function helps the driver to maintain within the speed limit of the road.

⚠ CAUTION

- Intelligent Speed Limit Assist may not operate properly if the function is used in other countries.
- Update navigation system regularly for Intelligent Speed Limit Assist to operate normally.

Detecting sensor

Front view camera



Refer to the picture above for the detailed location of the detecting sensor.

⚠ CAUTION

For more precautions related to the camera sensor, refer to "Forward Collision-Avoidance Assist (FCA)" on page 7-4.

Intelligent Speed Limit Assist settings

Speed Limit

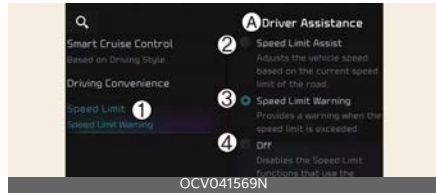

- A: **Driver Assistance**
- 1 **Speed Limit**
- 2 **Speed Limit Assist**
- 3 **Speed Limit Warning**
- 4 **Off**

With the vehicle on, select or deselect **Setup** → **Vehicle** → **Driver Assistance** → **Speed Limit** from the Settings menu to set whether or not to use each function.

- If **Speed Limit Assist** is selected, Intelligent Speed Limit Assist will inform the driver of speed limit and additional road signs. In addition, Intelligent Speed Limit Assist will inform the driver to change set speed of Manual Speed Limit Assist and/or Smart Cruise Control to help the driver stay within the speed limit.
- If **Speed Limit Warning** is selected, Intelligent Speed Limit Assist will inform the driver of speed limit and additional road signs. In addition, Intelligent Speed Limit Assist will warn the driver when the vehicle is driven faster than the speed limit. Manual Speed Limit Assist or Smart Cruise Control set speed will not be automatically adjusted. The driver should adjust the speed manually.
- If **Off** is selected, Intelligent Speed Limit Assist will turn off.

Speed Limit Offset

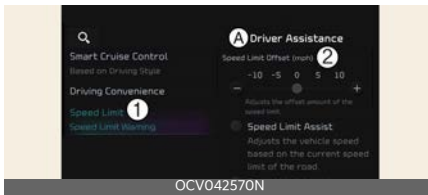

A: Driver Assistance

1 Speed Limit

2 Speed Limit Offset (mph)

With the vehicle on, when **Setup** → **Vehicle** → **Driver Assistance** → **Speed Limit** → **Speed Limit Offset** is selected, the Speed Limit Offset can be changed. Speed Limit Warning and Speed Limit Assist will operate by applying the Speed Limit Offset setting to the detected speed limit.

⚠ WARNING

- For your safety, change the Settings after parking the vehicle at a safe location.
- Speed Limit Assist function operates based on the Offset setting added to the speed limit. If you want to change the set speed according to the speed limit, set the offset to **0**.
- Speed Limit Warning function warns the driver when driving speed exceeds the speed at which the set Offset is added to speed limit. If you want Speed Limit Warning to warn you immediately when the driving speed exceeds the speed limit, set the offset to **0**.

* NOTICE

The setting of **Speed Limit Offset** is not reflected in Navigation-based Smart Cruise Control (NSCC).

Warning Methods

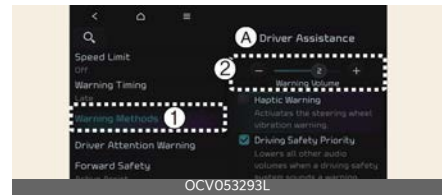

A: Driver Assistance

1 Warning Methods

2 Warning Volume

Warning Methods can be set when the vehicle is in ON position.

- **Warning Volume:** Select **Setup** → **Vehicle** → **Driver Assistance** → **Warning Methods** → **Warning Volume** on the infotainment system, and adjust the warning volume.

Even if you set the warning volume to 0, Warning volume will keep its volume in 1. (If steering wheel vibration equipped)

⚠ CAUTION

- Ensure that **Warning Methods** you have set may apply to the Warning Methods of other driver assistance systems.
- **Warning Methods** will maintain its last setting even if the vehicle is restarted.
- The setting menu may not be available for your vehicle depending on the vehicle features and specifications.

Intelligent Speed Limit Assist operation

Warning and control

Intelligent Speed Limit Assist will warn and control the vehicle by 'Displaying speed limit', 'Warning overspeed' and 'Changing set speed'.

* NOTICE

Intelligent Speed Limit Assist warning and control are described based on the Offset set to **0**. For details on Offset setting, refer to "Intelligent Speed Limit Assist settings" on page 7-50.

the supplementary sign is not recognized, it will be displayed as blank.

Warning overspeed



OCV051147N

When driving at a speed higher than the displayed speed limit, the red speed limit indicator will blink.

Displaying speed limit



OCV051146N

Speed limit information is displayed on the instrument cluster.

* NOTICE

- If speed limit information of the road cannot be recognized, '---' sign will be displayed. Please refer to "Limitations of Intelligent Speed Limit Assist" if the road signs are difficult to recognize.
- Intelligent Speed Limit Assist provides additional road sign information in addition to speed limit. The additional road sign information provided may vary according to your country.
- Supplementary sign displayed under the speed limit or overtaking restriction sign means the conditions under which the signs must be followed. If

Changing set speed

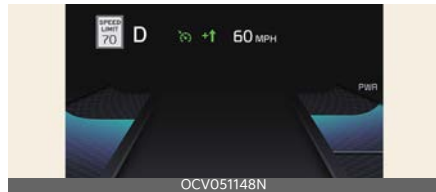

OCV051148N



OCV051149N

If the speed limit of the road changes during the operation of Manual Speed Limit Assist or Smart Cruise Control, an arrow in the direction of up or down is displayed to inform the driver that the set speed needs to be changed. At this time, the driver can change the set speed according to the speed limit by using the + or - switch on the steering wheel.

⚠ WARNING

- If the Offset is set over **0**, the set speed will change to a higher speed than the speed limit of the road. If you want to drive below the speed limit, set the Offset under **0** or use the - switch on the steering wheel to lower the set speed.
- Even after changing the set speed according to the speed limit of the road, the vehicle can still be driven over the speed limit. If necessary, depress the brake pedal to reduce your driving speed.
- If the speed limit of the road is under 20 mph (30 km/h), the set speed change function will not work.
- Intelligent Speed Limit Assist operates using the speed unit in the instrument cluster set by the driver. If the speed unit is set to a unit other than the speed unit used in your country, Intelligent Speed Limit Assist may not operate properly.

*** NOTICE**

- For more details on function operation of Manual Speed Limit Assist, refer to "Manual Speed Limit Assist (MSLA)" on page 7-48.
- For more details on operation of Smart Cruise Control, refer to "Smart Cruise Control (SCC)" on page 7-62.

*** NOTICE**

The images or colors may be displayed differently depending on the specifications of the instrument cluster or theme.

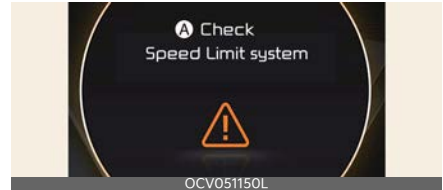
Intelligent Speed Limit Assist malfunction and limitations**Intelligent Speed Limit Assist malfunction****A: Check Speed Limit system**

When Intelligent Speed Limit Assist is not working properly, the warning message will appear on the cluster for several seconds, and the master (⚠) warning light will appear on the cluster. If this occurs, have the Intelligent Speed Limit Assist checked by an authorized Kia dealer.

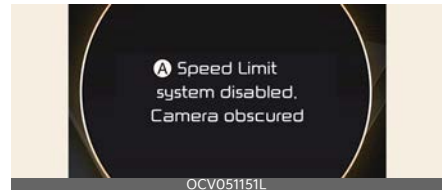
Intelligent Speed Limit Assist disabled**A: Speed Limit system disabled. Camera obscured**

When the front windshield where the front view camera is located is covered with foreign material, such as snow or rain, it can reduce the detecting performance and temporarily limit or disable Intelligent Speed Limit Assist.

If this occurs, the warning message will appear on the cluster. The function will operate normally when snow, rain or foreign material is removed.

If Intelligent Speed Limit Assist does not operate normally after it is removed, have the Intelligent Speed Limit Assist checked by an authorized Kia dealer.

* NOTICE

- Even though the warning message or warning light does not appear on the cluster, Intelligent Speed Limit Assist may not operate properly.
- If the vehicle is turned off and then restarted with the sensor blocked or malfunction, Intelligent Speed Limit Assist may not operate properly.

Limitations of Intelligent Speed Limit Assist

Intelligent Speed Limit Assist may not operate normally, or the function may operate unexpectedly under the following circumstances:

- The road sign is contaminated or indistinguishable
 - The road sign is difficult to see due to bad weather, such as rain, snow, fog, etc.
 - The road sign is not clear or damaged
 - The road sign is partially obscured by surrounding objects or shadow
 - A road sign near the road you are driving is detected
- The road signs do not conform to the standard
 - The text or picture on the road sign is different from the standard
 - The road sign is installed between the main line and the exit road or between diverging roads
 - A conditional road sign is not installed with a sign located on the road to enter or exit
 - A sign is attached to another vehicle
- The distance between the vehicle and the road signs is too far
- The vehicle encounters illuminating road signs
- Intelligent Speed Limit Assist incorrectly recognizes numbers in the street signals or other signs as the speed limit
- The minimum speed limit sign is on the road
- The brightness changes suddenly, for example when entering or exiting a tunnel or passing under a bridge
- Headlamps are not used or the brightness of the headlamps are weak at night or in the tunnel
- Road signs are difficult to recognize due to the reflection of sunlight, street lights, or oncoming vehicles
- The navigation information or GPS information contain errors.
- The driver does not follow the guide of the navigation.
- The driver is driving a new road that is not in the navigation system yet.
- The field of view of the Front view camera is obstructed by sun glare
- Driving on a road that is sharply curved or continuously curved
- Driving through speed bumps, or driving up and down or left to right on steep inclines
- The vehicle is shaking heavily
- There is an error in the navigation map information or GPS information
- The driver is not driving along the navigation guide route
- Driving on a newly opened road

⚠ WARNING

- Intelligent Speed Limit Assist is a supplemental function that helps the driver to comply with the speed limit on the road, and may not display the correct speed limit or control the driving speed properly.
- Always set the vehicle speed to the speed limit in your country.
- Intelligent Speed Limit Assist may not operate for 15 seconds after the vehicle is started, or the front view camera is initialized.

*** NOTICE**

For more details on the limitations of the front view camera, refer to "Forward Collision-Avoidance Assist (FCA)" on page 7-4.

Driver Attention Warning (DAW)**Basic function**

Driver Attention Warning will help determine the driver's attention level by analyzing driving pattern, driving time, etc. while vehicle is being driven. Driver Attention Warning will recommend a break when the driver's attention level falls below a certain level.

Leading vehicle departure alert function

Leading Vehicle Departure Alert function will inform the driver when the front vehicle departs from a stop.

Detecting sensor

Front view camera



The front view camera is used to detect driving patterns and front vehicle departure while vehicle is being driven.

Refer to the picture above for the detailed location of the detecting sensor.

⚠ CAUTION

Always keep the front view camera in good condition to maintain optimal performance of Driver Attention Warning.

For more details on the precautions of the front view camera, refer to "Forward Collision-Avoidance Assist (FCA)" on page 7-4.

Driver Attention Warning settings

Driver Attention Warning



A: Driver Assistance

- 1 Driver Attention Warning
- 2 Inattentive Driving Warning
- 3 Safety Notice Call

With the vehicle on, select or deselect **Setup** → **Vehicle** → **Driver Assistance** → **Driver Attention Warning** from the infotainment system screen to set whether or not to use each function.

- **Inattentive Driving Warning:** Driver Attention Warning will inform the driver the driver's attention level and will recommend taking a break when the level falls below a certain level.

Leading Vehicle Departure Alert

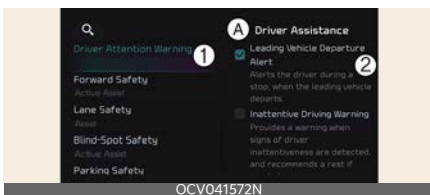

A: Driver Assistance

- 1 Driver Attention Warning
- 2 Leading Vehicle Departure Alert
- 3 Inattentive Driving Warning

Leading Vehicle Departure Alert: The function will inform the driver when the front vehicle departs from a stop.

Warning Timing



A: Driver Assistance

- 1 Warning Timing
- 2 Standard
- 3 Late

With the vehicle on, select **Setup** → **Vehicle** → **Driver Assistance** → **Warning Timing** from the infotainment system screen to change the initial warning activation time for Driver Attention Warning.

- **Standard:** Use in a normal driving environment. If Driver Attention Warning operates too sensitive, set the warning timing to **Late**.
- **Late:** The warning timing will be late

* NOTICE

- If you change the Warning Timing, the warning time of other Driver Assistance systems may change.
- If the vehicle is restarted, Driver Warning Time will maintain the last setting.

Driver Attention Warning operation

The basic functions of the Driver Attention Warning include:

- Attention Level
- Consider taking a break

Basic function

Attention level

Function off



- 1 Driver Attention Warning
- 2 System Off

Standby/Disabled



- 1 Driver Attention Warning
- 2 Standby
- 3 Last Break

Attentive driving



- 1 Attention Level
- 2 High
- 3 Last Break

Inattentive driving

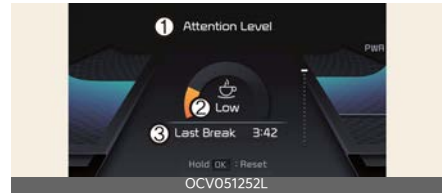

- 1 Attention Level
- 2 Low
- 3 Last Break

The driver's attention level is displayed on the scale of 1 to 5. The lower the level is, the more inattentive the driver is. The level decreases when the driver does not take a break for a certain period of time. Driver Attention Warning operates under the following conditions:

- Your driving speed: Approximately 0~130 mph (0~210 km/h).

When the **Inattentive driving warning** is deselected from the Settings menu, **System Off** is displayed.

When vehicle speed is not within the operating speed, the message **Standby** will be displayed.

Taking a break

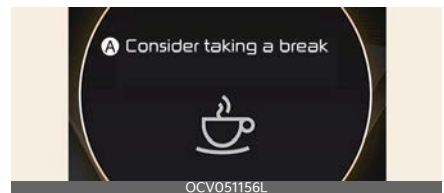

A: Consider taking a break

The warning message will appear on the cluster and an audible warning will sound to suggest that the driver take a break, when the driver's attention level is below 1.

Driver Attention Warning will not suggest a break when the total driving time is shorter than 10 minutes or 10 minutes has not passed after the last break was suggested.

⚠️ WARNING

For your safety, change the Settings after parking the vehicle at a safe location.

⚠️ CAUTION

- Driver Attention Warning may suggest a break depending on the driver's driving pattern or habits, even if the driver doesn't feel fatigued.
- Driver Attention Warning is a supplemental function and may not be able to determine whether the driver is inattentive.
- The driver who feels fatigued should take a break at a safe location, even though there is no break suggestion by Driver Attention Warning.

* NOTICE

- For more details on setting the instrument cluster, refer to "Instrument cluster" on page 5-61.
- Driver Attention Warning will reset the last break time to 00:00 in the following situations:
 - The vehicle is turned off
 - The driver unfastens the seat belt and opens the driver's door.
 - The vehicle is stopped for more than 10 minutes.

Leading vehicle departure alert function



A: Leading vehicle is driving away

When the front vehicle departs from a stop, Leading Vehicle Departure Alert will inform the driver by displaying the warning message on the cluster and an audible warning will sound.

⚠️ WARNING

- If any other function's warning message is displayed or audible warning is generated, Leading Vehicle Departure Alert warning message may not be displayed and audible warning may not be generated.
- The driver should hold the responsibility to safely drive and control the vehicle.

⚠️ CAUTION

- Leading Vehicle Departure Alert is a supplemental function and may not alert the driver whenever the front vehicle departs from a stop.
- Always check the front of the vehicle and road conditions before departure.

* NOTICE

The images or colors may be displayed differently depending on the specifications of the instrument cluster or theme.

Driver Attention Warning mal-function and limitations

Driver Attention Warning mal-function



A: Check Inattentive Driving Warning system

When Driver Attention Warning is not working properly, the warning message will appear and (A) warning lights will appear on the cluster. If this occurs, have Driver Attention Warning inspected by an authorized Kia dealer.

Limitations of Driver Attention Warning

Driver Attention Warning may not work properly in the following situations:

- The vehicle is driven violently
- The vehicle intentionally crosses over lanes frequently
- The vehicle is controlled by Driver Assistance system, such as Lane Keeping Assist

Leading vehicle departure alert function

- When the vehicle cuts in

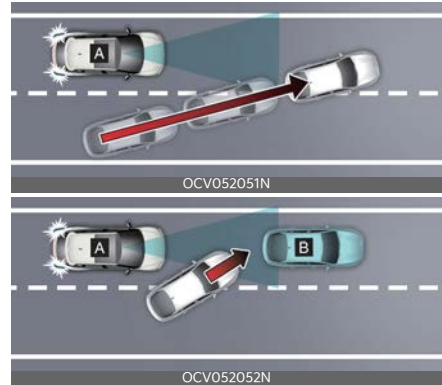

[A]: Your vehicle, [B]: Front vehicle

If a vehicle cuts in front of your vehicle, Leading Departure Alert may not operate properly.

- When the vehicle ahead sharply steers



[A]: Your vehicle, [B]: Front vehicle

If the vehicle in front makes a sharp turn, such as to turn left or right or make a U- turn, etc., Leading Vehicle Departure Alert may not operate properly.

- When the vehicle ahead abruptly departs

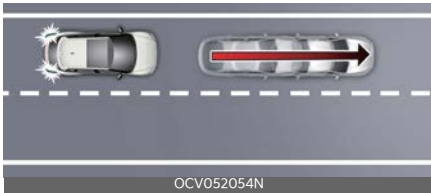

If the vehicle in front abruptly departs, Leading Vehicle Departure Alert may not operate properly.

- When a pedestrian or bicycle is between you and the vehicle ahead



If there is a pedestrian(s) or bicycle(s) in between you and the vehicle in front, Leading Vehicle Departure Alert may not operate properly.

- When in a parking lot



If a vehicle parked in front drives away from you, Leading Vehicle Departure Alert may alert you that the parked vehicle is driving away.

- When driving at a tollgate or intersection, etc.



If you pass a tollgate or intersection with lots of vehicles or you drive where lanes are merged or divided frequently, Leading Vehicle Departure Alert may not operate properly.

⚠ WARNING

Driver Attention Warning may not operate for 15 seconds after the vehicle is started, or the front view camera is initialized.

*** NOTICE**

For more details on the precautions of the front view camera, refer to "Forward Collision-Avoidance Assist (FCA)" on page 7-4.

Blind-Spot View Monitor (BVM) (if equipped)

Left side



Right side



Blind-Spot View Monitor displays the rear blind spot area of the vehicle in the cluster when the turn signal is turned on to help safely change lanes.

Detecting sensor

Wide-side view camera



(camera located at bottom of the mirror)

Refer to the picture above for the detailed location of the detecting sensors.

Blind-Spot View Monitor settings

Blind-Spot View

With the vehicle on, select **Setup** → **Vehicle** → **Driver Assistance** → **Blind-Spot Safety** → **Blind-Spot View** from the infotainment system screen to turn on Blind-Spot View Monitor and deselect to turn off the function.

Blind-Spot View Monitor operation

Turn signal switch



Blind-Spot View Monitor will turn on and off when the turn signal is turned on and off.

Blind-Spot View Monitor

Operating conditions

- When the left or right turn signal turns on, the image on the instrument cluster will turn on.

Off conditions

Blind-Spot View Monitor will turn off when one of the following conditions are satisfied:

- When the turn signal is turned off.
- When the hazard warning flasher is on.
- When other important warning is displayed on the instrument cluster.

Blind-Spot View Monitor malfunction

When Blind-Spot View Monitor is not working properly, or the cluster display flickers, or the camera image does not display normally, have Blind-Spot View Monitor inspected by an authorized Kia dealer.

⚠ WARNING

- The image shown on the cluster may differ from the actual distance of the object. Make sure to directly check the vehicle's surroundings for safety.
- If the camera lens is covered with foreign material, the Blind-Spot View Monitor may not operate normally. Always keep the camera lens clean. However, do not use chemical solvents such as strong detergents containing high alkaline or volatile organic solvents (gasoline, acetone etc.). This may damage the camera lens.

Smart Cruise Control (SCC)

Smart Cruise Control is designed to detect the vehicle ahead and help maintain the desired speed and minimum distance with the vehicle ahead.

Overtaking Acceleration Assist

While Smart Cruise Control is operating, if the function judges that the driver is determined to overtake the vehicle in front, acceleration will be assisted.

Based on Driving Style (if equipped)

Smart Cruise Control will operate based on the driver's driving style, such as inter-vehicle distance, acceleration, reaction speed.

Detecting sensor

Front view camera



Front radar



Front corner radar (if equipped)



The front view camera, front radar, and front corner radars (if equipped) are used as a detecting sensor to detect the vehicles in front.

Refer to the picture above for the detailed location of the detecting sensor.

⚠ CAUTION

- Always keep the front view camera and front radar in good condition to maintain optimal performance of Smart Cruise Control.
- For more details on the precautions of the front view camera and front radar, refer to "Forward Collision-Avoidance Assist (FCA)" on page 7-4.

Smart Cruise Control settings

Based on Driving Style (if equipped)

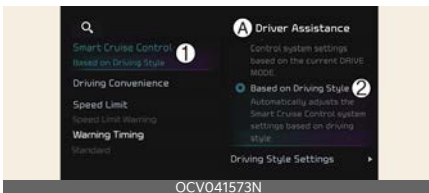

A: Driver Assistance

1 Smart Cruise Control

2 Based on Driving Style

With the vehicle on, if **Setup** → **Vehicle** → **Driver Assistance** → **Smart Cruise Control** → **Based on Driving Style** is selected from the infotainment system

screen, Smart Cruise Control will operate based on the driver's driving style, such as vehicle distance, acceleration, reaction speed.

While Smart Cruise Control is operating with **Based on Driving Mode** selected, if you press and hold the Vehicle Distance (🚗) button, Smart Cruise Control will change to **Based on Driving Style**.

While Smart Cruise Control is operating with **Based on Driving Style**, if the Vehicle Distance (🚗) button is pressed, it will change to **Based on Driving Mode**.

* NOTICE

- If equipped with Based on Driving Style, **Based on Driving Mode** and **Based on Driving Style** can be selected from the infotainment system screen by selecting **Setup** → **Vehicle** → **Driver Assistance** → **Smart Cruise Control**.
- If **Based on Driving Mode** is selected, Smart Cruise Control will operate based on the drive mode selected.
- While Smart Cruise Control is operating with **Based on Driving Style** selected, if you press and hold the Vehicle Distance (🚗) button, Smart Cruise Control will change to Based on driving mode. Press and hold the Vehicle Distance (🚗) button to change Smart Cruise Control to **Based on Driving Style** mode.

Driving Style Settings (if equipped)



A: Driver Assistance

1 Smart Cruise Control

2 View Driving Style Analysis

With the vehicle on, select **Setup** → **Vehicle** → **Driver Assistance** → **Smart Cruise Control** → **View Driving Style Analysis** from the infotainment system screen to check the driver's driving style, and to change each driving style manually.

* NOTICE

- **View Driving Style Analysis** is displayed when **Based on Driving Style** is selected.
- Smart Cruise Control learns the driver's driving styles only when the driver drives the vehicle.

Warning Methods



A: Driver Assistance

1 Warning Methods

2 Warning Volume

3 Haptic Warning

4 Driving Safety Priority

Warning Methods can be set when the vehicle is in ON position.

- **Warning Volume:** Select **Setup** → **Vehicle** → **Driver Assistance** → **Warning Methods** → **Warning Volume** on the infotainment system, and adjust the warning volume.

Even if you set the warning volume to 0, Warning volume will keep its volume in 1. (If steering wheel vibration equipped)

- **Haptic Warning:** Select **Setup** → **Vehicle** → **Driver Assistance** → **Warning Methods** → **Haptic Warning** on the infotainment system, and set the steering wheel vibration warning. (if equipped)
- **Driving Safety Priority:** Select **Setup** → **Vehicle Settings** → **Driver Assistance** → **Warning Methods** → **Driving Safety Priority** on the infotainment system.

For safe driving, the audio volume will temporarily decrease to warn the driver with the audible warning.

⚠ CAUTION

- Ensure that **Warning Methods** you have set may apply to the Warning Methods of other driver assistance systems.
- **Warning Methods** will maintain its last setting even if the vehicle is restarted.
- The setting menu may not be available for your vehicle depending on the vehicle features and specifications.
- With the warning volume is 0, if you deselect **Haptic Warning**, the warning volume will be automatically adjusted with volume 2.

- With the **Haptic Warning** is deselected, if you adjust the warning volume to 0, the **Haptic Warning** will be automatically selected.

To turn on Smart Cruise Control



Press the Driving Assist (Ⓜ) button to turn on the function. The speed will be set to the current speed on the cluster.

- If there is no vehicle in front of you, the set speed will be maintained.
- If there is a vehicle in front of you, the speed may be adjusted to maintain the distance to the vehicle ahead. If the vehicle ahead accelerates, your vehicle will travel at a steady cruising speed after accelerating to the set speed.

* NOTICE

If your vehicle speed is between 0~30 km/h (0~20 mph) when you press the Driving Assist (Ⓜ) button, the set speed will be set to 30 km/h (20 mph).

To set vehicle distance



Each time the button is pressed, the vehicle distance changes as follows:

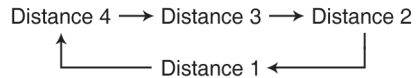

* NOTICE

- If you drive at 90 km/h (56 mph), the distance is maintained as follows:
 - Distance 4 - approximately 52.5 m (172 ft.)
 - Distance 3 - approximately 40 m (130 ft.)
 - Distance 2 - approximately 32.5 m (106 ft.)
 - Distance 1 - approximately 25 m (82 ft.)
- The distance is set to the last set distance when the vehicle is restarted, or when Smart Cruise Control was temporarily canceled.

To increase set speed



Push the + switch up and release it immediately. The set speed will increase by 1 km/h (1 mph) each time the switch is operated in this manner.

- Push the + switch up and hold it. The set speed will increase by 10 km/h (5 mph) each time the switch is operated in this manner.
- You can set the speed to 180 km/h (110 mph).

⚠ WARNING

Check the driving condition before using the + switch. Driving speed may sharply increase when you push up and hold the + switch.

To decrease set speed



Push the - switch down and release it immediately. The set speed will decrease by 1 mph (1 km/h) each time the switch is operated in this manner.

- Push the - switch down and hold it. The set speed will decrease by 10 km/h (5 mph) each time the switch is operated in this manner.
- You can set the speed to 30 km/h (20 mph).

To temporarily cancel Smart Cruise Control



Press the (||) switch or depress the brake pedal to temporarily cancel Smart Cruise Control.

To resume Smart Cruise Control



To resume Smart Cruise Control after the function was canceled, operate the +, - or (||) switch.

- If you push the + switch up or - switch down, vehicle speed will be set to the current speed on the cluster.
- If you push the (||) switch, vehicle speed will resume to the preset speed.

⚠ WARNING

Check the driving condition before using the (||) switch. Driving speed may sharply increase or decrease when you press the (||) switch.

To turn off Smart Cruise Control



Press the Driving Assist (🚗) button to turn Smart Cruise Control off.

* NOTICE

If your vehicle is equipped with Manual Speed Limit Assist, press and hold the Driving Assist (🚗) button to turn off Smart Cruise Control. However Manual Speed Limit Assist will turn on.

Based on Driving Mode

Smart Cruise Control will change acceleration based on the drive mode selected from Drive Mode Integrated Control function. Refer to the following chart.

Drive Mode	Smart Cruise Control
SNOW*	Normal
ECO	Slow
SPORT	Fast
NORMAL	Normal
GT*	Fast

* : if equipped

* NOTICE

- For more details on Drive Mode, refer to "Drive mode integrated control system" on page 6-37.
- Smart Cruise Control may not turn on or off in some of the drive modes for the operating conditions are not satisfied.
- If your vehicle is not equipped with Drive Mode Integrated Control sys-

tem, Smart Cruise Control accelerates your vehicle at a normal level.

Smart Cruise Control operation

Operating conditions

Smart Cruise Control will operate when the following conditions are satisfied.

Basic function

- The gear is in D (Drive)
- The driver's door is closed
- EPB (Electronic Parking Brake) is not applied
- Your vehicle speed is within the operating speed range
 - When there is no vehicle in front: 10~180 km/h (5~110 mph)
 - when there is a vehicle in front: 0~180 km/h (0~110 mph)
- ESC (Electronic Stability Control) or ABS is on
- ESC (Electronic Stability Control) or ABS is not controlling the vehicle
- Forward Collision-Avoidance Assist brake control is not operating
- Remote Smart Parking Assist brake control is not operating (if equipped)
- The vehicle is not in a power down status (Power down indicator light does not appear)

* NOTICE

When stopped behind another vehicle, the driver can turn on Smart Cruise Control while the brake pedal is depressed.

Overtaking Acceleration Assist

Overtaking Acceleration Assist will operate when the turn signal indicator is turned on to the left while Smart Cruise Control is operating, and the following conditions are satisfied:

- Your vehicle speed is above 60 km/h (40 mph)
- The hazard warning flasher is off
- A vehicle is detected in front of your vehicle
- Deceleration is not needed to maintain distance with the vehicle in front

⚠ WARNING

- When the turn signal indicator is turned on to the left (left-hand drive) or turned on to the right (right-hand drive) while there is a vehicle ahead, the vehicle may accelerate temporarily. Pay attention to the road conditions at all times.
- Regardless of your country's driving direction, Overtaking Acceleration Assist will operate when the conditions are satisfied. When using the function in countries with different driving direction, always check the road conditions at all times.

Smart Cruise Control display and control

Basic function

You can see the status of the Smart Cruise Control operation in the Driving Assist mode on the cluster. Refer to "Instrument cluster" on page 5-61.

Smart Cruise Control will be displayed as below depending on the status of the function.

- When operating



1. Whether there is a vehicle ahead and the selected distance level are displayed.
2. Set speed is displayed.
3. Whether there is a vehicle ahead and the selected target distance are displayed.

- When temporarily canceled



1. (~~SCC~~) indicator is displayed.
2. The previous set speed is shaded.

*** NOTICE**

- The distance of the front vehicle on the cluster is displayed according to the actual distance between your vehicle and the vehicle ahead.
- The target distance may vary according to the vehicle speed and the set distance level. If vehicle speed is low, even though the vehicle distance have changed, the change of the target vehicle distance may be small.

To temporarily accelerate

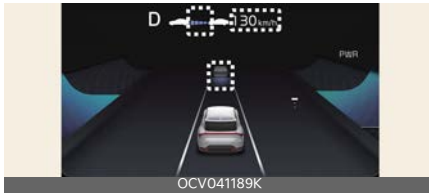

If you want to speed up temporarily without altering the set speed while Smart Cruise Control is operating, depress the accelerator pedal. While the accelerator pedal is depressed, the set speed, distance level and target distance will blink on the cluster.

However, if the accelerator pedal is depressed insufficiently, the vehicle may decelerate.

⚠ WARNING

Be careful when accelerating temporarily, because the speed and distance is not controlled automatically even if there is a vehicle in front of you.

Based on Driving Style operating (if equipped)



A: Driving Style Adaptive SCC

When Based on Driving Style is operating, the message will appear on the cluster for 2 seconds, and the distance level and target distance will be displayed based on the driving style.

Smart Cruise Control temporarily canceled



A: Smart Cruise Control canceled

Smart Cruise Control will be temporarily canceled automatically when:

- The vehicle speed is above 190 km/h (120 mph)
- The vehicle is stopped for a certain period of time
- The accelerator pedal is continuously depressed for a certain period of time
- The conditions for the Smart Cruise Control to operate is not satisfied

If Smart Cruise Control is temporarily canceled automatically, a warning message will appear on the cluster, and an audible warning will sound to warn the driver.

* NOTICE

If Smart Cruise Control is automatically canceled temporarily when the vehicle is stopped, the Electronic Parking Brake (EPB) may be applied.

⚠ WARNING

When Smart Cruise Control is temporarily canceled, distance with the front vehicle will not be maintained. Always have

your eyes on the road while driving, and if necessary, depress the brake pedal to reduce your driving speed in order to maintain a safe distance.

Smart Cruise Control conditions not satisfied

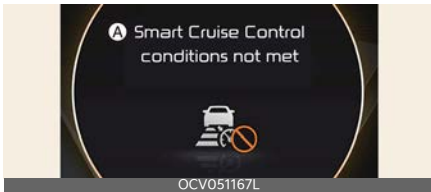

A: Smart Cruise Control conditions not met

If the Driving Assist button, + switch, - switch or (||◁) switch is pushed when Smart Cruise Control's operating conditions are not satisfied, a warning message will appear on the cluster, and an audible warning will sound.

In traffic situation

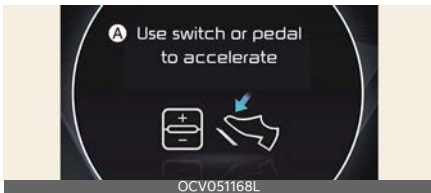

A: Use switch or pedal to accelerate

In traffic, your vehicle will stop if the vehicle ahead of you stops. Also, if the vehicle ahead of you starts moving, your vehicle will start as well.

In addition, after the vehicle has stopped and a certain time have passed, a warning message like above will appear on the cluster. Depress the accelerator pedal or push the + switch, - switch or (||◁) switch to start driving.

Warning road conditions ahead



A: Watch for surrounding vehicles

In the following situation, the warning message will appear on the cluster, and an audible warning will sound to warn the driver of road conditions ahead.

- The vehicle in front disappears when Smart Cruise Control is maintaining the distance with the vehicle ahead while driving below a certain speed.

WARNING

Always pay attention to vehicles or objects that may suddenly appear in front of you, and if necessary, depress the brake pedal to reduce your driving speed in order to maintain a safe distance.

Collision warning



A: Collision Warning

While Smart Cruise Control is operating, when the collision risk with the vehicle ahead is high, a warning message will appear on the cluster, and an audible warning will sound to warn the driver. Always have your eyes on the road while driving, and if necessary, depress the

brake pedal to reduce your driving speed in order to maintain a safe distance.

WARNING

In the following situations, Smart Cruise Control may not warn the driver of a collision.

- The distance from the front vehicle is near, and the vehicle speed of the front vehicle is faster or similar with your vehicle
- The speed of the front vehicle is very slow or is at a standstill
- The accelerator pedal is depressed right after Smart Cruise Control is turned on

WARNING

Take the following precautions when using Smart Cruise Control:

- Smart Cruise Control does not substitute for proper and safe driving. It is the responsibility of the driver to always check the speed and distance to the vehicle ahead.
- Smart Cruise Control may not detect unexpected and sudden situations or complex driving situations, so always pay attention to driving conditions and control your vehicle speed.
- Keep Smart Cruise Control off when the function is not in use to avoid inadvertently setting a speed.
- Do not open the door when Smart Cruise Control is operating, even if the vehicle is stopped.
- Always be aware of the selected speed and vehicle to vehicle distance.
- Keep a safe distance according to road conditions and vehicle speed. If the vehicle to vehicle distance is too close during high-speed driving, a serious collision may result. Always pay attention to the road condition ahead.
- When maintaining distance with the vehicle ahead, if the front vehicle disappears, the function may suddenly accelerate to the set speed. Always be aware of unexpected and sudden situations from occurring.
- Vehicle speed may decrease on an upward sloped road and increase on a downward sloped road.
- Always be aware of situations such as when a vehicle cuts in suddenly.
- When you are towing a trailer or another vehicle, we recommend that Smart Cruise Control is turned off due to safety reasons.
- Turn off Smart Cruise Control when your vehicle is being towed.
- Smart Cruise Control may be canceled if interfered by strong electromagnetic waves.
- Smart Cruise Control may not detect an obstacle in front and lead to a collision. Always look ahead cautiously to prevent unexpected and sudden situations from occurring.
- Vehicles moving in front of you with a frequent lane change may cause a delay in the function's reaction or may cause the function to react to a vehicle actually in an adjacent lane. Always drive cautiously to prevent unexpected and sudden situations from occurring.
- Always be aware of the surroundings and drive safely, even though a warning message does not appear or an audible warning does not sound.
- If any other function's warning message is displayed or warning sound is

generated, Smart Cruise Control warning message may not be displayed and warning sound may not be generated.

- You may not hear the warning sound of Smart Cruise Control if the surrounding is noisy. Always pay attention to the road condition ahead.
- The vehicle manufacturer is not responsible for any traffic violation or accidents caused by the driver while Smart Cruise Control is operating.
- Always set the vehicle speed under the speed limit in your country.
- Vehicle distance, acceleration and reaction speed may change if the driver's driving style changes. Always pay attention to the road condition ahead.

⚠ CAUTION

- The vehicle must be driven sufficiently to reflect the actual driving style of the driver, such as vehicle distance, acceleration and reaction speed.
- Based on Driving Style may not reflect the driver's driving style or driving conditions that affects driving safety.
- If you are driving in special conditions, such as snow, rain, fog or steep sloped roads, the vehicle may not be driven according to the driver's driving style.

*** NOTICE**

- Smart Cruise Control may not operate for 15 seconds after the vehicle is restarted or the front view camera or front radar is initialized.

- You may hear a sound when the brake is controlled by Smart Cruise Control.
- Based on Driving Style may not reflect the driver's driving style that is not safe such as rapid acceleration.
- Based on Driving Style does not reflect any other driving style other than vehicle distance, acceleration and reaction speed.

*** NOTICE**

The images or colors may be displayed differently depending on the specifications of the instrument cluster or theme.

Smart Cruise Control malfunction and limitations

Smart Cruise Control malfunction

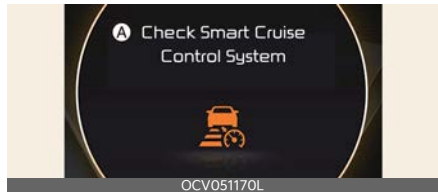

A: Check Smart Cruise Control System

When Smart Cruise Control is not working properly, a warning message will appear, and the (⚠) warning light will appear on the cluster. Have Smart Cruise Control inspected by an authorized Kia dealer.

Smart Cruise Control disabled

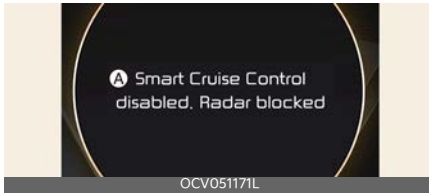

A: Smart Cruise Control disabled. Radar blocked

When the front radar cover or sensor is covered with snow, rain, or foreign material, it can reduce the detecting performance and temporarily limit or disable Smart Cruise Control.

If this occurs, a warning message will appear on the cluster.

Smart Cruise Control will operate normally when snow, rain or foreign material is removed.

⚠ WARNING

Even though the warning message does not appear on the cluster, Smart Cruise Control may not properly operate.

⚠ CAUTION

Smart Cruise Control may not properly operate in an area (e.g. open terrain), where there is nothing to detect after turning ON the vehicle.

Limitations of Smart Cruise Control

Smart Cruise Control may not operate normally under the following circumstances:

- The detecting sensor or the surroundings are contaminated or damaged
- Washer fluid is continuously sprayed, or the wiper is on
- The camera lens is contaminated due to tinted, filmed or coated windshield, damaged glass, or stuck of foreign material (sticker, bug, etc.) on the glass
- Moisture is not removed or frozen on the windshield
- The field of view of the front view camera is obstructed by sun glare
- Street light or light from an oncoming vehicle is reflected on the wet road surface, such as a puddle on the road
- The temperature around the front view camera is high or low
- An object is placed on the dashboard
- The surrounding is very bright
- The surrounding is very dark, such as in a tunnel, etc.
- The brightness changes suddenly, for example when entering or exiting a tunnel
- The brightness outside is low, and the headlamps are not on or are not bright
- Driving in heavy rain or snow, or thick fog
- Driving through steam, smoke or shadow
- Only part of the vehicle is detected
- The vehicle in front has no tail lights, tail lights are located unusually, etc.
- The brightness outside is low, and the tail lamps of the vehicle in front are not on or are not bright
- The rear of the front vehicle is small or does not look normal (i.e. tilted, overturned, etc.)
- The front vehicle's ground clearance is low or high
- A vehicle suddenly cuts in front
- Your vehicle is being towed

- Driving through a tunnel or iron bridge
- Driving near areas containing metal substances, such as a construction zone, railroad, etc.
- A material is near that reflects very well on the front radar, such as a guardrail, nearby vehicle, etc.
- The bumper around the front radar is impacted, damaged or the front radar is out of position
- The temperature around the front radar is high or low
- Driving in large areas where there are few vehicles or structures (i.e. desert, meadow, suburb, etc.)
- The vehicle in front is made of material that does not reflect on the front radar
- Driving near a highway (or motorway) interchange or tollgate
- Driving on a slippery surface due to snow, water puddle, ice, etc.
- Driving on a curved road
- The vehicle in front is detected late
- The vehicle in front is suddenly blocked by an obstacle
- The vehicle in front suddenly changes lane or suddenly reduces speed
- The vehicle in front is bent out of shape
- The front vehicle's speed is fast or slow
- With a vehicle in front, your vehicle changes lane suddenly at low speed
- The vehicle in front is covered with snow
- Unstable driving
- You are on a roundabout and the vehicle in front is not detected

- You are continuously driving in a circle
- Driving in a parking lot
- Driving through a construction area, unpaved road, partial paved road, uneven road, speed bumps, etc.
- Driving on an incline road, curved road, etc.
- Driving through a roadside with trees or streetlights
- The adverse road conditions cause excessive vehicle vibrations while driving
- Your vehicle height is low or high due to heavy loads, abnormal tire pressure, etc.
- Driving through a narrow road where trees or grass are overgrown
- There is interference by electromagnetic waves, such as driving in an area with strong radio waves or electrical noise
- Driving on a curved road



On curved roads, Smart Cruise Control may not detect a vehicle in the same lane, and may accelerate to the set speed. Also, vehicle speed may rapidly decrease when the vehicle ahead is detected suddenly.

Select the appropriate set speed on curved roads and apply the brake pedal or accelerator pedal according to the road and driving conditions ahead.



Your vehicle speed can be reduced due to a vehicle in the adjacent lane. Check to be sure that the road conditions permit safe operation of the Smart Cruise Control and if necessary, depress the brake pedal to reduce your driving speed in order to maintain a safe distance.

- Driving on a sloped road



During uphill or downhill driving, the Smart Cruise Control may not detect a moving vehicle in your lane, and cause your vehicle to accelerate to the set speed. Also, vehicle speed will rapidly decrease when the vehicle ahead is detected suddenly.

Select the appropriate set speed on sloped roads and apply the brake pedal or accelerator pedal according to the road and driving conditions ahead.

- Changing lanes

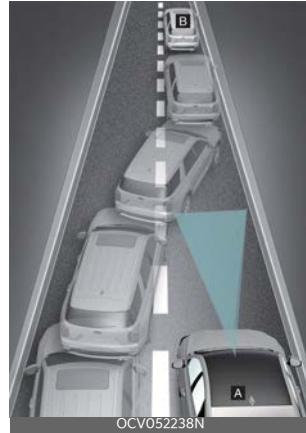

[A]: Your vehicle

[B]: Lane changing vehicle

When a vehicle moves into your lane from an adjacent lane, it cannot be detected by the sensor until it is in the sensor's detection range. Smart Cruise Control may not immediately detect the vehicle when the vehicle changes lanes abruptly. Always pay attention to the road and driving conditions and drive safely. If necessary, depress the brake pedal to reduce your driving speed in order to maintain a safe distance.

- Detecting a vehicle





In the following cases, some vehicles in your lane cannot be detected by the sensor:

- Vehicles offset to one side
- Slow-moving vehicles or sudden-decelerating vehicles
- Vehicles with higher ground clearance or vehicles carrying loads that stick out of the back of the vehicle
- Vehicles that has the front lifted due to heavy loads
- Oncoming vehicles
- Stopped vehicles
- Vehicles with small rear profile, such as trailers
- Narrow vehicles, such as motorcycles or bicycles
- Special vehicles
- Animals and pedestrians

In the following cases, the vehicle in front cannot be detected by the sensor. Always pay attention to the road and driving conditions and drive safely. If necessary, adjust your vehicle speed.

- You are steering your vehicle
- Driving on narrow or sharply curved roads



- When a vehicle ahead disappears at an intersection, your vehicle may accelerate. Always pay attention to road and driving conditions while driving.



- When a vehicle in front of you merges out of the lane, Smart Cruise Control may not immediately detect the new vehicle that is now in front of you. Always pay attention to road and driving conditions while driving.



- Always look out for pedestrians when your vehicle is maintaining a distance with the vehicle ahead.

This device complies with Industry Canada licence-exempt RSS standard(s).

Operation is subject to the following conditions:

1. This device may not cause interference, and
2. This device must accept any interference, including interference that may cause undesired operation of the device.
3. Changes or modifications not expressly approved by the party responsible for compliance could void the user's authority to operate the device.

Navigation-based Smart Cruise Control (NSCC) (if equipped)

Navigation-based Smart Cruise Control will help automatically adjust vehicle speed when driving on highways (or motorways) by using road information from the navigation function while Smart Cruise Control is operating.

*** NOTICE**

- Navigation-based Smart Cruise Control is available only on controlled access road or certain highways.
- * Controlled access road indicates roads with limited entrances and exits that allow uninterrupted high speed traffic flow. Only passenger cars and motorcycles are allowed on controlled access roads.

Available highway (Controlled access road)	
USA	Select Interstate Highway and U.S. (Federal) and State Highways
Canada	Select Provincial and Territorial Highways

- Additional highways may be expanded by future navigation updates.

*** NOTICE**

Navigation-based Smart Cruise Control operates on main roads of highways (or motorways), and does not operate on interchanges or junctions.

⚠ WARNING

Navigation-based Smart Cruise Control is a supplemental function and is not a substitute for safe driving. It is the responsibility of the driver to always check the speed and distance to the vehicle ahead. Always drive safely and use caution.

Highway Curve Zone Auto Slow-down

If vehicle speed is high, Highway Curve Zone Auto Slowdown function will temporarily decelerate your vehicle or limit acceleration to help you drive safely on a curve based on the curve information from the navigation.

Highway Set Speed Auto Change

Highway Set Speed Auto Change function automatically changes Smart Cruise Control set speed based on the speed limit information from the navigation.

Navigation-based Smart Cruise Control settings



A: Driver Assistance

1 Driving Convenience

2 Highway Auto Speed Change

With the vehicle on, select **Setup** → **Vehicle** → **Driver Assistance** → **Driving Convenience** → **Highway Auto Speed Change** from the infotainment system screen to turn on Navigation-based Smart Cruise Control and deselect to turn off the function.

* NOTICE

When there is a problem with Navigation-based Smart Cruise Control, the function cannot be set from the Settings menu.

Navigation-based Smart Cruise Control operation

Operating conditions

Navigation-based Smart Cruise Control is ready to operate if all of the following conditions are satisfied:

- Smart Cruise Control is operating
- Driving on main roads of highways (or motorways)

* NOTICE

For more details on how to operate Smart Cruise Control, refer to "Smart Cruise Control (SCC)" on page 7-62.

Navigation-based Smart Cruise Control display

When Navigation-based Smart Cruise Control operates, it will be displayed on the cluster as follows:

Navigation-based Smart Cruise Control standby



If the operating conditions are satisfied, the white (NAV) symbol will appear.

Navigation-based Smart Cruise Control operating



If temporary deceleration is required in the standby state and Navigation-based Smart Cruise Control is operating, the green (NAV) symbol will appear on the cluster.

If the Highway Set Speed Auto Change function operates, the green (NAV) symbol and set speed will appear on the cluster, and an audible warning will sound.

⚠ WARNING

The warning message will appear in the following circumstances:



A: Drive carefully

- Navigation-based Smart Cruise Control is not able to slow down your vehicle to a safe speed.

*** NOTICE**

Highway Curve Zone Auto Slowdown and Set Speed Auto Change function uses the same (NAV) symbol.

Highway Curve Zone Auto Slow-down

- Depending on the curve ahead on the highway (or motorway), the vehicle will decelerate, and after passing the curve, the vehicle will accelerate to Smart Cruise Control set speed.
- Vehicle deceleration time may differ depending on the vehicle speed and the degree of the curve on the road. The higher the driving speed, deceleration will start faster.

Highway Set Speed Auto Change

- Highway Set Speed Auto Change function will operate when Smart Cruise Control set speed and the highway (or motorway) speed limit is matched.
- While Highway Set Speed Auto Change function is operating, when the highway (or motorway), speed limit changes, Smart Cruise Control set speed automatically changes to the changed speed limit.
- If Smart Cruise Control set speed is adjusted different from the speed limit, Highway Set Speed Auto Change function will be in the standby state.
- If Highway Set Speed Auto Change function has changed to the standby state by driving on a road other than the highway (or motorway) main road, Highway Set Speed Auto Change function will operate again when you drive on the main road again without setting the set speed.
- If Highway Set Speed Auto Change function has changed to the standby state by depressing the brake pedal, press the (||◁) switch to restart the function.

- Highway Set Speed Auto Change function does not operate on highway interchanges or junctions.

*** NOTICE**

- Highway Set Speed Auto Change function only operates based on the speed limits of the highway (or motorway), it does not work with the speed cameras.
- When Highway Set Speed Auto Change function is operating, the vehicle automatically accelerates or decelerates when the highway (or motorway) speed limit changes.
- The maximum set speed for Highway Set Speed Auto Change function is 140 km/h (90 mph).
- If the speed limit of a new road is not updated in the navigation, Highway Set Speed Auto Change function may not operate properly.
- If the speed unit is set to a unit other than the speed unit used in your country, Highway Set Speed Auto Change function may not operate properly.

*** NOTICE**

The images or colors may be displayed differently depending on the specifications of the instrument cluster or theme.

Navigation-based Smart Cruise Control limitations

Navigation-based Smart Cruise Control may not operate normally under the following circumstances:

- The navigation is not working properly

- Map information is not transmitted due to infotainment system's abnormal operation
- Speed limit and road information in the navigation is not updated
- The map information and the actual road is different because of real-time GPS data or map information error
- The navigation searches for a route while driving
- GPS signals are blocked in areas such as a tunnel
- A road that divides into two or more roads and joins again
- The driver goes off course the route set in the navigation
- The route to the destination is changed or canceled by resetting the navigation
- The vehicle enters a service station or rest area
- Android Auto or Car Play is operating
- The navigation cannot detect the current vehicle position (ex: elevated roads including overpass adjacent to general roads or nearby roads exist in a parallel way)
- The navigation is being updated while driving
- The navigation is being restarted while driving
- The speed limit of some sections changes according to the road situations
- Driving on a road under construction
- Driving on a road that is controlled
- There is bad weather, such as heavy rain, heavy snow, etc.
- Driving on a road that is sharply curved

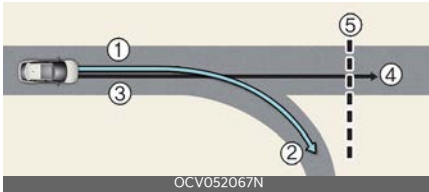

[1]: Set route, [2]: Branch line, [3]: Driving route, [4]: Main road, [5]: Curved road section

- When there is a difference between the navigation set route (branch line) and the driving route (main road), Highway Curve Zone Auto Slowdown function may not operate until the driving route is recognized as the main road.
- When the vehicle's driving route is recognized as the main road by maintaining the main road instead of the navigation set route, Highway Curve Zone Auto Slowdown function will operate. Depending on the distance to the curve and the current vehicle speed, vehicle deceleration may not be sufficient or may decelerate rapidly.

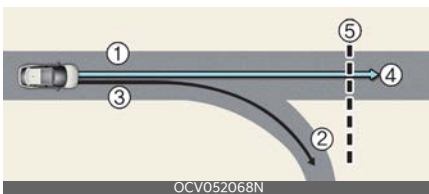

[1]: Main road, [2]: Branch line, [3]: Driving route, [4]: Set route, [5]: Curved road section

- When there is a difference between the navigation route (main road) and the driving route (branch line), Highway Curve Zone Auto Slowdown function will operate temporarily based on the curve information on the main road.

- When it is judged that you are driving out of the route by entering the highway interchange or junction, Highway Curve Zone Auto Slowdown function will not operate.

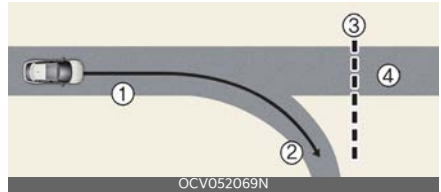

[1]: Driving route, [2]: Branch line, [3]: Curved road section, [4]: Main road

- If there is no destination set on the navigation, Highway Curve Zone Auto Slowdown function will operate based on the curve information on the main road.
- Even if you depart from the main road, Highway Curve Zone Auto Slowdown function may temporarily operate due to navigation information of the highway curve section.

⚠ WARNING

- Navigation-based Smart Cruise Control is not a substitute for safe driving practices, but a convenience function. Always have your eyes on the road, and it is the responsibility of the driver to avoid violating traffic laws.
- The navigation's speed limit information may differ from the actual speed limit information on the road. It is the driver's responsibility to check the speed limit on the actual driving road or lane.
- Navigation-based Smart Cruise Control will automatically be canceled when you leave the highway (or motorway) main road. Always pay attention to road and driving conditions while driving.

- Navigation-based Smart Cruise Control may not operate due to the existence of leading vehicles and the driving conditions of the vehicle. Always pay attention to road and driving conditions while driving.
- When you are towing a trailer or another vehicle, we recommend that Navigation-based Smart Cruise Control is turned off due to safety reasons.
- After you pass through a tollgate on a highway (or motorway), Navigation-based Smart Cruise Control will operate based on the first lane. If you enter one of the other lanes, the function might not operate properly.
- The vehicle will accelerate if the driver depresses the accelerator pedal while Navigation-based Smart Cruise Control is operating, and the function will not decelerate the vehicle. However, if the accelerator pedal is depressed insufficiently, the vehicle may decelerate.
- If the driver accelerates and releases the accelerator pedal while Navigation-based Smart Cruise Control is operating, the vehicle may not decelerate sufficiently or may rapidly decelerate to a safe speed.
- If the curve is too large or too small, Navigation-based Smart Cruise Control may not operate.
- Even if you are driving at a speed lower than Smart Cruise Control set speed, acceleration may be limited by the curve sections ahead.
- If Navigation-based Smart Cruise Control is operating while leaving the main road to enter an interchange, junction, rest area, etc., the function may operate for a certain period of time.
- Deceleration by Navigation-based Smart Cruise Control may feel it is not sufficient due to road conditions such as uneven road surfaces, narrow lanes, etc.

This device complies with Industry Canada licence-exempt RSS standard(s).

Operation is subject to the following conditions:

1. This device may not cause interference, and
2. This device must accept any interference, including interference that may cause undesired operation of the device.
3. Changes or modifications not expressly approved by the party responsible for compliance could void the user's authority to operate the device.

*** NOTICE**

- The speed information on the cluster and navigation may differ.
- The time gap could occur between the navigation's guidance and when Navigation-based Smart Cruise Control operation starts and ends.

Lane Following Assist (LFA)

Lane Following Assist is designed to help detect lane markings and/or vehicles on the road, and assists the driver's steering to help keep the vehicle between lanes.

Detecting sensor

Front view camera



The front view camera is used as a detecting sensor to detect lane markings and front vehicles.

Refer to the picture above for the detailed location of the detecting sensor.

⚠ CAUTION

For more details on the precautions of the front view camera, refer to "Forward Collision-Avoidance Assist (FCA)" on page 7-4.

Lane Following Assist settings

Warning Methods



A: Driver Assistance

1 Warning Methods

2 Warning Volume

3 Driving Safety Priority

Warning Methods can be set when the vehicle is in ON position.

- **Warning Volume:** Select **Setup** → **Vehicle** → **Driver Assistance** → **Warning Methods** → **Warning Volume** on the infotainment system, and adjust the warning volume.

Even if you set the warning volume to 0, Warning volume will keep its volume in 1. (If steering wheel vibration equipped)

- **Driving Safety Priority:** Select **Setup** → **Vehicle Settings** → **Driver Assistance** → **Warning Methods** → **Driving Safety Priority** on the infotainment system.

For safe driving, the audio volume will temporarily decrease to warn the driver with the audible warning.

⚠ CAUTION

- Ensure that **Warning Methods** you have set may apply to the Warning Methods of other driver assistance systems.
- **Warning Methods** will maintain its last setting even if the vehicle is restarted.
- The setting menu may not be available for your vehicle depending on the vehicle features and specifications.

Turning Lane Following Assist On/Off



With the vehicle on, shortly press the Lane Driving Assist button located on the steering wheel to turn on Lane Following Assist. The gray or green (Ⓢ) indicator light will appear on the cluster. Press the button again to turn off the function.

Lane Following Assist operation

Lane Following Assist will control and warn the vehicle by 'Lane Following Assist' and 'Hands-off warning'.

Lane Following Assist

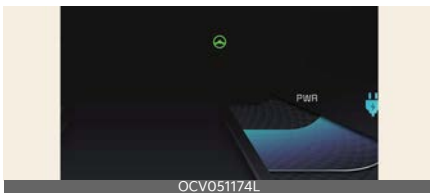

If the vehicle ahead and/or both lane markings are detected and your vehicle speed is below 180 km/h (110 mph), Lane Following Assist will help center the vehicle in the lane by assisting the steering wheel. The green (Ⓢ) indicator light will appear on the cluster.

⚠ CAUTION

When the steering wheel is not assisted, the green (Ⓢ) indicator light will blink and change to gray.

Hands-off warning



A: **Keep hands on steering wheel**

If the driver takes their hands off the steering wheel for several seconds, the warning message will appear and an audible warning will sound in stages.

- First stage: Warning message
- Second stage: Warning message (red steering wheel) and audible warning

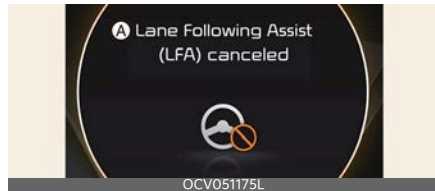

A: **Lane Following Assist (LFA) canceled**

If the driver still does not have their hands on the steering wheel after the hands-off warning, the warning message will appear and Lane Following Assist will be automatically canceled.

⚠ WARNING

- The steering wheel may not be assisted if the steering wheel is held very tight or the steering wheel is steered over a certain degree.
- Lane Following Assist does not operate at all times. It is the responsibility of the driver to safely steer the vehicle and to maintain the vehicle in its lane.
- The hands-off warning message may appear late depending on road condi-

tions. Always have your hands on the steering wheel while driving.

- If the steering wheel is held very lightly the hands-off warning message may appear because Lane Following Assist may not detect that the driver has their hands on the steering wheel.
- If you attach objects to the steering wheel, the hands-off warning may not work properly.

*** NOTICE**

- For more details on setting Lane Following Assist in the infotainment system, refer to the separately supplied infotainment system manual.
- When both lane markings are detected, the lane lines on the cluster will change from gray to white.

Lane undetected

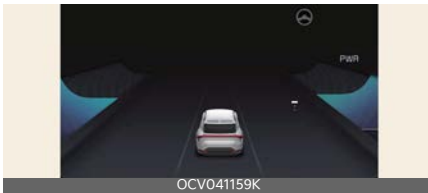

Lane detected

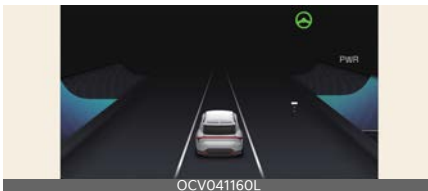

- The images and colors in the cluster may differ depending on the cluster type or theme selected from the cluster.
- If lane markings are not detected, steering wheel control by Lane Fol-

lowing Assist can be limited depending on whether a vehicle is in front or the driving conditions of the vehicle.

- Even though the steering is assisted by Lane Following Assist, the driver may control the steering wheel.
- The steering wheel may feel heavier or lighter when the steering wheel is assisted by Lane Following Assist than when it is not.

Lane Following Assist malfunction and limitations

Lane Following Assist malfunction

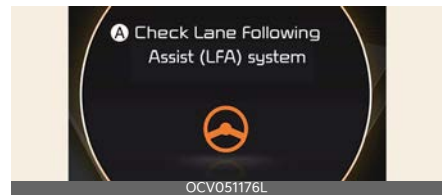

A: Check Lane Following Assist (LFA) system

When Lane Following Assist is not working properly, the warning message will appear and the master warning light (⚠) will appear on the cluster. If this occurs, have Lane Following Assist inspected by an authorized Kia dealer.

Limitations of Lane Following Assist

⚠ WARNING

For more details on Lane Following Assist precautions, refer to "Lane Keeping Assist (LKA)" on page 7-23.

Highway Driving Assist (HDA) (if equipped)

Basic function

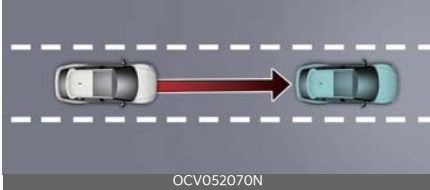

Highway Driving Assist is designed to help detect vehicles and lanes ahead, and help maintain distance from the vehicle ahead, maintain the set speed, and keep the vehicle between lanes while driving on the highway (or motorway).

Highway Lane Change Assist (if equipped)

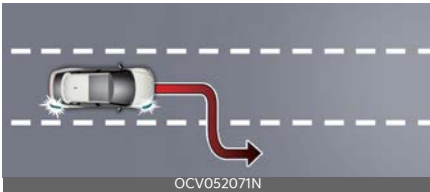

Highway Lane Change Assist function helps change lanes to the direction the driver slightly moves the turn signal switch if the function judges that lane change is possible.

* NOTICE

- Highway Driving Assist is available only on controlled access road or certain highways. (except for the interchange/junction)
 - * Controlled access road indicates roads with limited entrances and exits that allow uninterrupted high

speed traffic flow. Only passenger cars and motorcycles are allowed on controlled access roads.

Available highway (Controlled access road)	
USA	Select Interstate Highway and U.S. (Federal) and State Highways
Canada	Select Provincial and Territorial Highways

- Additional highways may be expanded by future navigation updates.

Detecting sensor

Front view camera



Front radar



Front corner radar (if equipped)



Rear corner radar (if equipped)



Refer to the picture above for the detailed location of the detecting sensors.

CAUTION

For more details on the precautions of the detecting sensors, refer to "Forward Collision-Avoidance Assist (FCA)" on page 7-4.

Highway Driving Assist settings
Basic function



A: **Driver Assistance**

1 Driving Convenience

2 Highway Driving Assist

With the vehicle on, select or deselect **Setup** → **Vehicle** → **Driver Assistance** → **Driving Convenience** from the infotainment system screen to set whether or not to use each function.

- If **Highway Driving Assist** is selected, it helps maintain distance from the vehicle ahead, maintain the set speed, and helps center the vehicle in the lane.

Highway Lane Change Assist (if equipped)

If **Highway Lane Change Assist** is selected, it helps the driver change lanes.

*** NOTICE**

- When **Highway Driving Assist** is deselected, the setting for **Highway Lane Change Assist** cannot be changed.
- If there is a problem with the functions, the settings cannot be changed. Have the function be inspected by an authorized Kia dealer.
- If the vehicle is restarted, the functions will maintain the last setting.

WARNING

For your safety, change the Settings after parking the vehicle at a safe location.

Warning Methods



A: **Driver Assistance**

1 Warning Methods

2 Warning Volume

3 Driving Safety Priority

Warning Methods can be set when the vehicle is in ON position.

- **Warning Volume:** Select **Setup** → **Vehicle** → **Driver Assistance** → **Warning Methods** → **Warning Volume** on the infotainment system, and adjust the warning volume.

Even if you set the warning volume to 0, Warning volume will keep its volume in 1. (If steering wheel vibration equipped)

- **Driving Safety Priority:** Select **Setup** → **Vehicle Settings** → **Driver Assistance** → **Warning Methods** → **Driving Safety Priority** on the infotainment system.

For safe driving, the audio volume will temporarily decrease to warn the driver with the audible warning.

CAUTION

- Ensure that **Warning Methods** you have set may apply to the Warning Methods of other driver assistance systems.
- **Warning Methods** will maintain its last setting even if the vehicle is restarted.
- The setting menu may not be available for your vehicle depending on the vehicle features and specifications.

Highway Driving Assist operation

Basic function

Highway Driving Assist display and control

You can see the status of the Highway Driving Assist operation in the Driving Assist view on the cluster. Refer to "Instrument cluster" on page 5-61.

Highway Driving Assist will be displayed as below depending on the status of the function.

Operating State



Standby State



- 1 Highway Driving Assist indicator, whether there is a vehicle ahead and the selected distance level are displayed.

- Highway Driving Assist indicator
 - Green: Operating state
 - Grey: Standby state
 - White blink: Accelerator depressed state

- 2 Set speed is displayed.
- 3 Lane Following Assist indicator displayed.
- 4 Whether there is a vehicle ahead and the target vehicle to vehicle distance are displayed.
- 5 Whether the lane is detected or not is displayed.

*** NOTICE**

- For more details on the display, refer to "Smart Cruise Control (SCC)" on page 7-62.
- For more details on the display, refer to "Lane Following Assist (LFA)" on page 7-83.

Highway Driving Assist operating

When driving on available road, press Drive Assist button to turn on Highway Driving Assist.

Highway Driving Assist will operate when entering or driving on the main road of highways (or motorways), and satisfying all the following conditions:

- Lane Following Assist is operating
- Smart Cruise Control is operating

* NOTICE

- While driving on the highway (or motorway), if Smart Cruise Control starts operating, Highway Driving Assist will operate.
- When entering the main roads of highways (or motorways) while Smart Cruise Control is operating, Driving Assist will not turn on if Lane Following Assist is turned off.

Restarting after stopping

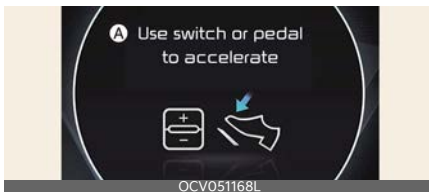

A: Use switch or pedal to accelerate

When Highway Driving Assist is operating, your vehicle will stop if the vehicle ahead of you stops. Also, if the vehicle ahead of you starts moving approximately within 30 seconds after the stop, your vehicle will start as well. In addition, after the vehicle has stopped and approximately 30 seconds have passed, the **Use switch or pedal to accelerate** message will appear on the cluster. Depress the accelerator pedal or push

the + switch, - switch or (⊖) switch to start driving.

Hands-off warning



A: Keep hands on steering wheel

If the driver takes their hands off the steering wheel for several seconds, the warning message will appear and an audible warning will sound in stages.

- First stage: Warning message
- Second stage: Warning message (red steering wheel) and audible warning

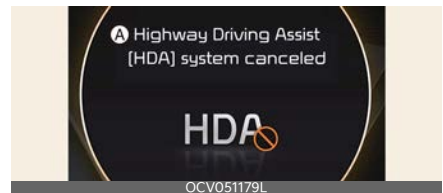

A: Highway Driving Assist (HDA) system canceled

If the driver still does not have their hands on the steering wheel after the hands-off warning, the warning message will appear and Highway Driving Assist and Lane Change Assist will be automatically canceled.

Driving speed limit



A: Driver's grasp not detected. Driving speed will be limited

When Highway Driving Assist is canceled by the hands-off warning, The driving speed will be limited. While Driving Speed Limit function is operating, the warning message will appear on the cluster, and an audible warning will sound continuously.

Driving to one side within lane (if equipped)



When vehicle speed is above 60 km/h (40 mph), if a vehicle around you is driving at a close distance, your vehicle will control steering in the opposite direction of the vehicle to assist in safe driving. If there are vehicles in both sides of the lane that are driving close to you, the function will not veer to the opposite side of the lane.

Highway Driving Assist standby

When the Smart Cruise Control is temporarily canceled while Highway Driving Assist is operating, Highway Driving Assist will be in the standby state. At this time, Lane Following Assist will operate normally.

* NOTICE

- Driving Speed Limit helps you drive below 60 km/h (40 mph). At this time, the vehicle decelerates due to the vehicle ahead. After the vehicle has decelerated, it cannot automatically accelerate.
- Driving Speed Limit will cancel in the following circumstances:
 - When the driver grabs the steering wheel again
 - When the driver turns on Lane Following Assist by pressing the Lane Driving Assist button
 - When Smart Cruise Control switch +, -, or (⏏) switch is pushed, or the accelerator pedal or the brake pedal is depressed

Highway Lane Change Assist (if equipped)

Display and control

You can see the status of the Highway Lane Change Assist function operation in the Driving Assist view on the cluster. Refer to "Instrument cluster" on page 5-61.

Highway Lane Change Assist function will be displayed as below depending on the status of the function.

Ready/Operating



Standby/Canceled

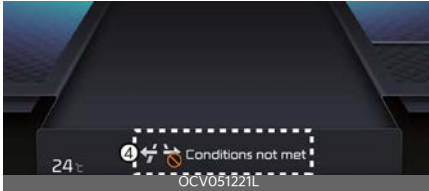

1 Highway Lane Change Assist indicator

- Green (→) on: Ready state
- Green (→) blink: Operating state
- Grey (→) on: Standby state
- White (→) blink: Canceled state (display only a certain time)

2 Lane line

The lane line is displayed identical to Highway Lane Change Assist indicator (1). However, the lane detection availability will be showed on Standby state.

3 Green arrow and shade

The green arrow is displayed when a certain amount of time has passed after the function has started operating, and until the lane change has completed.

4 Message

- Message is displayed when the function does not operate even though the turn signal lever is used.
- Message is displayed when the function is canceled while operating.

To turn on Highway Lane Change Assist



A: Press OK button to enable Lane Change Assist

1 Confirm

Highway Lane Change Assist function will turn on when the following conditions are satisfied.

- The Driving Assist button or Lane Driving Assist button is used to turn on Highway Driving Assist.
- The OK button is pressed on the steering wheel while a message asking to use Highway Lane Change Assist is displayed on the cluster.

Highway Lane Change Assist ready to operate

While Highway Lane Change Assist function is on, the function will be ready to operate when all the following conditions are satisfied:

- Highway Driving Assist is operating
- Lane Following Assist is operating
- A vehicle in the rear area of your vehicle is detected more than once after the vehicle is turned on
- Your vehicle speed is above 60 km/h (40 mph)
- Hands-off warning is not displayed on the cluster
- Hazard warning flasher is off

*** NOTICE**

- While Lane Change Assist function is turned on (indicator on), Lane Following Assist will not cancel even if the turn signal indicator or hazard warning flasher is operating.
- Lane Change Assist function turns off automatically when driven in the following road conditions:
 - One driving lane
 - A road with no structure, such as a median strip, guardrails, etc.
 - There is a pedestrian or cyclist on the road ahead
- When the function is in the ready state, and vehicle speed is below 55 km/h (35 mph), the function will change to the standby state.

⚠ WARNING

When Highway Lane Change Assist function turns off while operating, steering assist will be temporarily canceled. Always be cautious while driving.

Highway Lane Change Assist operating



Highway Lane Change Assist function will operate, when you push the turn signal lever up or down while the function is in the ready state (() indicator is green), and all of the following conditions are satisfied:

- The driver has his/her hand on the steering wheel

- There is no collision risk in the direction of lane change
- There is a single dotted lane line in the direction of lane change
- There are no Forward Collision-Avoidance Assist and Blind Spot Collision-Avoidance Assist warnings
- The vehicle is driven in the middle of the lane (should not be driving close to one side of the lane)
- The road you are driving on, or the road you are about to change lane is a road that the function can operate

*** NOTICE**

- When the turn signal lever is placed at A position, the Highway Lane Change Assist function is performed. After that, if the turn signal lever is placed in neutral, Highway Lane Change Assist function is canceled before vehicle stepping on the lane. The Highway Lane Change Assist function is not canceled after stepping on the lane, but when the lane change is completed, it is canceled and the turn signal turns off.

- When the turn signal lever is placed at B position for a certain period of time, the green arrow will appear. At this time, even when the lever is released and returns to its original position, lane change will still be assisted.

While lane change is being made by the function, the turn signal indicator will blink even when the turn signal lever is not held, and the turn signal indicator will turn off when lane change is complete.

Highway Lane Change Assist standby

Highway Lane Change Assist function will be in the standby state when one of the ready state condition is not satisfied, or when entering or driving on one of the following roads:

- Road within a certain distance from the tollgate on the main road of the highway (or motorway)
- The road ahead ends without an interchange or junction
- Road with sharp curves
- Road with narrow lanes

Highway Lane Change Assist cancel

The function will be canceled when:

- The turn signal lever is turned on in the opposite direction of lane change
- The steering wheel is steered sharply
- The turn signal lever is placed at A position, and then placed to the original position before entering the next lane

WARNING

- While the function is operating, the function will cancel if one of the following occurs:
 - Highway Driving Assist is turned off
 - Lane Following Assist or Smart Cruise Control is turned off or temporarily canceled
 - Hands-off warning message is displayed on the cluster
 - The turn signal lever is placed at A position
 - The hazard warning flasher is turned on
 - Forward Collision-Avoidance Assist or Blind-Spot Collision-Avoidance

Assist warning message is displayed

- Possible collision is detected in the next lane, even though there are no Forward Collision-Avoidance Assist and Blind Spot Collision-Avoidance Assist warning
- The target lane to make a lane change disappears
- The target lane to make a lane change is not detected
- There is a problem with turn signal lamps
- Highway Lane Change Assist function is off (The function turns off when the function is turned off from the settings menu, when the road changes to a one-way road, when there is an intersection or crosswalk ahead, when you enter a road with no structure, such as a median strip, guardrail, etc., or when there is a pedestrian or cyclist on the driving lane.)
- Your vehicle speed is below 55 km/h (35 mph)
- While the function is operating, when the function is canceled, depending on the driving conditions, the vehicle may drive to the middle of the driving lane or steering assist may stop. Always pay attention to road and driving conditions while driving.
- The function may not operate normally on roads with pedestrians or cyclists, such as an intersection or crosswalk. Always pay attention to road and driving conditions while driving.

*** NOTICE**

The images or colors may be displayed differently depending on the specifications of the instrument cluster or theme.

Highway Driving Assist malfunction and limitations

Highway Driving Assist malfunction



A: Check Highway Driving Assist (HDA) system

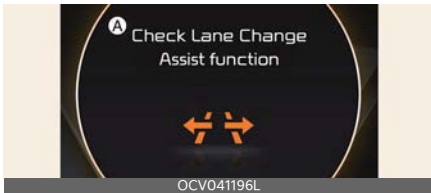

A: Check Lane Change Assist function

When Highway Driving Assist is not working properly, the warning message will appear, and the (A) warning light will appear on the cluster. Have Highway Driving Assist be inspected by an authorized Kia dealer.

⚠ WARNING

- The driver is responsible for controlling the vehicle for safe driving.
- Always have your hands on the steering wheel while driving.
- Highway Driving Assist is a supplemental function that assists the driver in driving the vehicle and is not a complete autonomous driving system.

Always check road conditions, and if necessary, take appropriate actions to drive safely.

- Always have your eyes on the road, and it is the responsibility of the driver to avoid violating traffic laws. The vehicle manufacturer is not responsible for any traffic violation or accidents caused by the driver.
- Highway Driving Assist may not be able to recognize all traffic situations. The function may not detect possible collisions due to Limitations. Always be aware of the Limitations. Obstacles such as vehicles, motorcycles, bicycles, pedestrians, guardrails, tollgate, unspecified objects, structures, etc. that may collide with the vehicle may not be detected.
- Highway Driving Assist will turn off automatically under the following situations:
 - Driving on roads that the function does not operate, such as a rest area, intersection, junction, etc.
 - The navigation does not operate properly such as when the navigation is being updated or restarted
- Highway Driving Assist may inadvertently operate or turn off depending on road conditions (navigation information) and surroundings.
- Lane Following Assist function may be temporarily disabled when the front view camera cannot detect lanes properly or the hands-off warning is on.
- You may not hear the warning sound of Highway Driving Assist if the surrounding is noisy.
- If the vehicle is driven at high speed above a certain speed at a curve, your

vehicle may drive to one side or may depart from the driving lane.

- When you are towing a trailer or another vehicle, we recommend that Highway Driving Assist is turned off due to safety reasons.
- The hands-off warning message may appear early or late depending on how the steering wheel is held or road conditions. Always have your hands on the steering wheel while driving.
- For your safety, please read the owner's manual before using the Highway Driving Assist.
- Highway Driving Assist will not operate when the vehicle is started, or when the detecting sensors or navigation is being initialized.

Limitations of Highway Driving Assist

Highway Driving Assist and Highway Lane Change function may not operate normally, or may not operate under the following circumstances:

- The map information and the actual road is different because the navigation is not updated
- The map information and the actual road is different because of real-time GPS data or map information error
- The infotainment system is overloaded by simultaneously performing functions such as route search, video playback, voice recognition, etc.
- GPS signals are blocked in areas such as a tunnel
- The driver goes off course, or resetting the navigation route by changing the destination (including route change according to real-time road

traffic information), or canceling the route to the destination

- The vehicle enters a service station or rest area
- Android Auto or Car Play is operating
- The navigation cannot detect the current vehicle position (ex: elevated roads including overpass adjacent to general roads or nearby roads exist in a parallel way)
- White single dotted lane line or road edge cannot be detected
- The road is temporarily controlled due to construction, etc.
- There is no structure, such as a median strip, guardrails, etc., on the road
- There is a changeable lane in the direction of lane change

* NOTICE

For more details on the limitations of the front view camera and front radar, refer to "Forward Collision-Avoidance Assist (FCA)" on page 7-4.

This device complies with Industry Canada licence-exempt RSS standard(s).

Operation is subject to the following conditions:

1. This device may not cause interference, and
2. This device must accept any interference, including interference that may cause undesired operation of the device.
3. Changes or modifications not expressly approved by the party responsible for compliance could void the user's authority to operate the device.

Rear View Monitor (RVM) (if equipped)

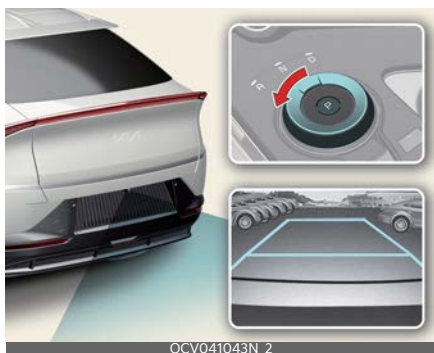

Rear View Monitor will show the area behind the vehicle to assist you when parking or Reversing.

Detecting sensor

Rear view camera



Refer to the picture above for the detailed location of the detecting sensor.

Rear View Monitor settings

Warning Methods



A: Driver Assistance

1 Warning Methods

2 Warning Volume

3 Driving Safety Priority

Warning Methods can be set when the vehicle is in ON position.

- **Warning Volume:** Select **Setup** → **Vehicle** → **Driver Assistance** → **Warning Methods** → **Warning Volume** on the infotainment system, and adjust the warning volume.

Even if you set the warning volume to 0, Warning volume will keep its volume in 1. (If steering wheel vibration equipped)

- **Parking Safety Priority:** Select **Setup** → **Vehicle Settings** → **Driver Assistance** → **Warning Methods** → **Parking Safety Priority** on the infotainment system.

For safe parking, the audio volume will temporarily decrease while Rear View Monitor is operating.

⚠ CAUTION

- Ensure that **Warning Methods** you have set may apply to the Warning Methods of other driver assistance systems.
- **Warning Methods** will maintain its last setting even if the vehicle is restarted.
- The setting menu may not be available for your vehicle depending on the vehicle features and specifications.

Camera settings

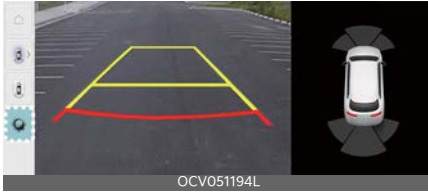

With the vehicle on, select the setup icon (⚙️) on the screen or **Setup** → **Vehicle** → **Driver Assistance** → **Parking Safety** → **Camera Settings** from the infotainment system screen to change the Rear View Monitor settings.

- Display Contents: To change the settings of **Extended Rear View Monitor** and **Rear Parking Guide Lines**.
- Display Settings: To change the screen's brightness and contrast.

Rear View Monitor operation

Parking/View button



Press the Parking/View button (1) to turn on or off Rear View Monitor while P (Park) position is selected.

Rear view



Operating conditions

Rear View Monitor will turn on when the following conditions are satisfied:

- Shifting the gear to R (Reverse).
- Pressing the Parking/View button (1) while P (Park) gear position is selected
- Pressing the View icon with the Rear top view on the screen

Off conditions

Rear View Monitor will turn off when the following conditions are satisfied:

- Pressing the Parking/View button (1) again while P (Park) gear position is selected. with the rear view on the screen.
- Changing the gear from R (Reverse) to P (Park).

* NOTICE

The rear view cannot be turned off when the gear is in R (Reverse).

Extended Rear View Monitor

Extended Rear View Monitor function maintains the rear view of the vehicle when shifting the gear from R (Reverse) to N (Neutral) or D (Drive) to help you park safely.

Operating conditions

Rear View Monitor will maintain when the following conditions are satisfied:

- Shifting the gear from R (Reverse) to N (Neutral) or D (Drive).
- The vehicle speed is below approximately 10 km/h (6 mph).

Off conditions

Extended Rear View Monitor function will turn off when one the following conditions are satisfied:

- The vehicle speed is above approximately 10 km/h (6 mph).
- Pressing the Parking/View button (1).
- Shifting the gear to P (Park).

Rear top view



Rear top view shows the distance from the vehicle or the object in the back of your vehicle while parking.

Press the Rear top view button to turn on Rear top view.

Rear View Monitor malfunction and limitations

Rear View Monitor malfunction

When Rear View Monitor is not working properly, or the screen flickers, or the camera image does not display normally, have your vehicle inspected by an authorized Kia dealer.

Limitations of Rear View Monitor

⚠ WARNING

- The wide-rear view camera does not cover the complete area behind the vehicle. The driver should always check the rear area directly through the inside and outside rear view mirror before parking or Reversing.
- The image shown on the screen may differ from the actual distance of the object. Make sure to directly check the vehicle's surroundings for safety.
- Always keep the wide-rear view camera lens clean. If the lens is covered with foreign material, it may adversely affect camera performance and Rear View Monitor may not operate normally. However, do not use chemical solvents such as strong detergents containing high alkaline or volatile organic solvents (gasoline, acetone etc.). This may damage the camera lens.

360° camera monitoring system (if equipped)



360° camera monitoring system can assist in parking by allowing the driver to see around the vehicle.

Detecting sensor



- 1: Wide-front view camera
- 2, 3: Wide-side view camera (under the side view mirror)
- 4: Wide-rear view camera

Refer to the picture above for the detailed location of the detecting sensors.

360° camera monitoring system settings

Warning Methods



A: Driver Assistance

- 1 Warning Methods
- 2 Warning Volume
- 3 Driving Safety Priority

Warning Methods can be set when the vehicle is in ON position.

- **Warning Volume:** Select **Setup** → **Vehicle** → **Driver Assistance** → **Warning Methods** → **Warning Volume** on the infotainment system, and adjust the warning volume.

Even if you set the warning volume to 0, Warning volume will keep its volume in 1. (If steering wheel vibration equipped)

- **Parking Safety Priority:** Select **Setup** → **Vehicle Settings** → **Driver Assistance** → **Warning Methods** → **Parking Safety Priority** on the infotainment system.

For safe parking, the audio volume will temporarily decrease while 360° camera monitoring system is operating.

⚠ CAUTION

- Ensure that **Warning Methods** you have set may apply to the Warning Methods of other driver assistance systems.

- **Warning Methods** will maintain its last setting even if the vehicle is restarted.
- The setting menu may not be available for your vehicle depending on the vehicle features and specifications.

Camera settings



With the vehicle on, select the setup icon (⚙️) on the screen or **Setup** → **Vehicle** → **Driver Assistance** → **Parking Safety** → **Camera Settings** from the infotainment system screen to change the Rear View Monitor settings.

- **Display Contents:** To change the settings of **Top View Parking Guidance**, **Parking Guide in Rear View**, and **Parking Distance Warning** function.
- **Display Settings:** To change the screen's brightness and contrast.

Top View Parking Guidance

Front top view



Rear top view



Parking guidance is displayed on the right side of the 360° camera monitoring system screen when the **Front or Rear Top View Parking Guidance** is selected.

Rear View Parking Guidance



Rear view parking guidance is displayed in the rear view when the **Parking Guide in Rear View** is selected.

* NOTICE

The horizontal guideline of the Rear View Parking Guidance shows the distance of 0.5 m (1.6 ft.), 1 m (3.3 ft.) and 2.3 m (7.6 ft.) from the vehicle.

Parking Distance Warning



Parking distance warning is displayed on the right side of the 360° camera monitoring system top view screen when the **Parking Distance Warning** is selected.

360° camera monitoring system Auto On

With the vehicle on, select **Setup** → **Vehicle** → **Driver Assistance** → **Parking Safety** → **360° camera monitoring system Auto On** from the infotainment system screen to use the function.

* NOTICE

For more details on 360° camera monitoring system Auto On, refer to "360° camera monitoring system Auto On" on page 7-101.

360° camera monitoring system operation

Parking/View button



Press the Parking/View button (1) to turn on or off 360° camera monitoring system.

Front view



Front view function is displayed on the screen when the gear is in N (Neutral) or D (Drive) to assist in parking. The front view has a top view, front view, side view and 3D view. Also, other view modes can be selected by pressing the view icons on the 360° camera monitoring system screen.

Operating conditions

Front view function will turn on when the following conditions are satisfied:

- Shifting from R (Reverse) to N (Neutral) or D (Drive) and the vehicle speed is below approximately 10 km/h (6 mph).
- Pressing the Parking/View button (1) when the gear is in D (Drive) or N (Neutral) and vehicle speed is below 10 km/h (6 mph).
- Forward Parking Distance Warning warns the driver while driving in D (Drive) (**Setup** → **Vehicle** → **Driver Assistance** → **Parking Safety** → **360° camera monitoring system Auto On** selected from the infotainment system screen)

Off conditions

Front view function will turn off when the following conditions are satisfied:

- Press the Parking/View button (1) or the infotainment system button (2).

- When vehicle speed is above 10 km/h (6 mph).
- Press one of the infotainment system button (2), the screen will change to the infotainment system screen.
- Shifting to P (Park).

* NOTICE

If the 360° camera monitoring system is turned off after driving more than 10 km/h (6 mph), driving below 10 km/h (6 mph) again will not switch to the 360° camera monitoring system screen.

Rear view

Rear view function is displayed on the screen when the gear is in R (Reverse) or P (Park) to assist in parking. The rear view has a top view, rear view, side view and 3D view. Also, other view modes can be selected by pressing the view icons on the 360° camera monitoring system screen.

Operating conditions

Rear view function will turn on when the following conditions are satisfied:

- Shifting to R (Reverse).
- Pressing the Parking/View button (1) when P (Park) gear position is selected.

Off conditions

Rear view function will turn off when the following conditions are satisfied:

- Shifting from R (Reverse) to P (Park).
- Pressing the Parking/View button (1) when P (Park) gear position is selected.

* NOTICE

Pressing the infotainment system button (2) will not turn the rear view off when the gear is in R (Reverse).

3D view

3D view function shows the vehicle in various angles. Press the 3D view icon on the 360° camera monitoring system screen to choose the angle. Press the 3D view icon again to reset the angle.

Operating conditions

3D view function will turn on when the following conditions are satisfied:

- Shifting to P (Park), N (Neutral) or D (Drive) and the vehicle speed is below 10 km/h (6 mph).
- When shifting to R (Reverse) and 360° camera monitoring system is on, Press 3D view icon on the 360° camera monitoring system screen.

Off conditions

3D view function will turn off when the following conditions are satisfied:

- Vehicle in P (Park), N (Neutral) or D (Drive)
 - Shifting to P (Park)
 - Pressing the Parking/View button (1)
 - Pressing the infotainment screen button (3)
 - Pressing the home button on the 360° camera monitoring system screen (2)
 - Vehicle speed is above 10 km/h (6 mph)
- Vehicle in R (Reverse)
 - Shifting to P (Park)

*** NOTICE**

3D view function does not display the parking guide.

360° camera monitoring system malfunction and limitations**360° camera monitoring system malfunction**

When 360° camera monitoring system is not working properly, or the screen flickers, or the camera image does not display normally, have your vehicle inspected by an authorized Kia dealer.

Limitations of 360° camera monitoring system

- The screen may be displayed abnormally, and an icon will appear at the top left side of the screen under the following circumstances:
 - The liftgate is opened.
 - The driver or front passenger door is opened.
 - The outside rear view mirror is folded.

⚠ WARNING

- ALWAYS look around your vehicle to make sure there are no objects or obstacles before moving the vehicle. What you see on the screen may differ from the actual vehicle's location.
- The image shown on the screen may differ from the actual distance of the object. Make sure to directly check the vehicle's surroundings for safety.
- 360° camera monitoring system is designed to be used on a flat surface. Therefore, if used on roads with different heights such as curbs and speed bumps, the image in the screen may not look correct.

- Always keep the camera lens clean. If the lens is covered with foreign material, it may adversely affect camera performance and 360° camera monitoring system may not operate normally. However, do not use chemical solvents such as strong detergents containing high alkaline or volatile organic solvents (gasoline, acetone etc.). This may damage the camera lens.

Rear Cross-Traffic Collision-Avoidance Assist (RCCA) (if equipped)

Rear Cross-Traffic Collision-Avoidance Assist is designed to help detect vehicles approaching from blind spot area while your vehicle is reversing, and warn the driver that a collision is imminent with a warning message and an audible warning. Also, braking may be assisted to potentially help prevent a collision.

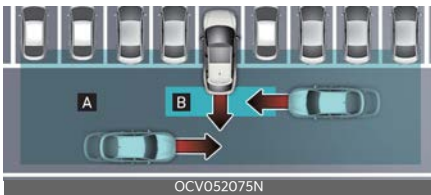

[A]: Rear Cross-Traffic Collision Warning operating range

[B]: Rear Cross-Traffic Collision-Avoidance Assist operating range

⚠ CAUTION

The time of warning may vary depending on vehicle speed of the approaching vehicle.

Detecting sensor

Rear corner radar



Refer to the picture above for the detailed location of the detecting sensor.

* NOTICE

For more details on the precautions of the rear corner radar, refer to "Blind-Spot Collision-Avoidance Assist (BCA) (if equipped)" on page 7-28.

Rear Cross-Traffic Collision-Avoidance Assist settings

Warning Timing



A: Driver Assistance

1 Warning Timing

2 Standard

3 Late

With the vehicle on, select **Setup** → **Vehicle** → **Driver Assistance** → **Warning Timing** from the infotainment system screen to change the initial warning activation time for Rear Cross-Traffic Collision-Avoidance Assist.

When the vehicle is first delivered, Warning Timing is set to **Standard**. If you change the Warning Timing, the warning time of other Driver Assistance systems may change.

Warning Methods

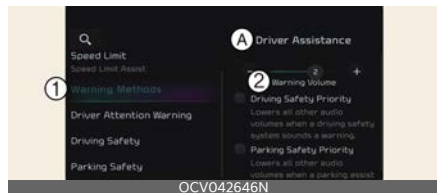

A: Driver Assistance

1 Warning Methods

2 Warning Volume

You can adjust the Warning Methods with the EV button in the ON position.

- **Warning Volume:** Select **Setup** → **Vehicle** → **Driver Assistance** → **Warning Methods** on the Infotainment system.

⚠ CAUTION

- Changing the Warning Methods may also change the Warning Methods of other driver assistance systems. Please ensure and change it.
- Warning Methods will maintain its last setting even if the vehicle is restarted.
- The setting menu may not be available for your vehicle depending on the vehicle features and specifications.
- Descriptions of each Driver Assistance system may be slightly different from the owner's manual after updating the software of your infotainment system. In this case, scan the QR code in the infotainment system manual to access the web manual for checking the changes.
- Depending on your region or update, the menu may be displayed as 'Warning Sound' or 'Warning Methods'.

Rear Cross-Traffic Collision-Avoidance Assist operation

Rear Cross-Traffic Collision-Avoidance Assist will warn and control the vehicle depending on collision level

- Collision Warning
- Emergency Braking
- Stopping vehicle and ending brake control

Collision warning



- To warn the driver of an approaching vehicle from the rear left/right side of your vehicle, the warning light on the outside rear view mirror will blink and a warning will appear on the cluster. At the same time, an audible warning will sound and the steering wheel will vibrate (if equipped). If the Rear View Monitor is operating, a warning will also appear on the infotainment system screen. (if equipped)
- Rear Cross-Traffic Collision-Avoidance Assist will operate when all the following conditions are satisfied:
 - The gear is shifted to R (Reverse) and the vehicle speed is below 8 km/h (5 mph)
 - The approaching vehicle is within approximately 25 m (82 ft.) from the blind spot area of your vehicle

- The speed of the vehicle approaching from the blind spot area is above 5 km/h (3 mph)

*** NOTICE**

If the operating conditions are satisfied, there will be a warning whenever the vehicle approaches from the left or right side even though your vehicle speed is 0 km/h (0 mph).

Emergency braking



A: Emergency Braking

- To warn the driver of an approaching vehicle from the rear left/right side of your vehicle, the warning light on the outside rear view mirror will blink and a warning message will appear on the cluster. At the same time, an audible warning will sound and the steering wheel will vibrate (if equipped). If the Rear View Monitor is operating, a

warning will also appear on the infotainment system screen. (if equipped)

- Rear Cross-Traffic Collision-Avoidance Assist will operate when all the following conditions are satisfied:
 - The gear is shifted to R (Reverse) and the vehicle speed is below 8 km/h (5 mph)
 - The approaching vehicle is within approximately 1.5 m (5 ft.) from the blind spot area of your vehicle
 - The speed of the vehicle approaching from the left and right is above 5 km/h (3 mph)
- Emergency braking will be assisted to help prevent collision with approaching vehicles from the blind spot area.

⚠ WARNING

Brake control will end:

- The approaching vehicle is out of the detecting range
- The approaching vehicle passes behind your vehicle
- The approaching vehicle does not drive toward your vehicle
- The approaching vehicle speed slows down
- The driver depresses the brake pedal with sufficient power

Stopping vehicle and ending brake control



A: Drive carefully

- When the vehicle is stopped due to emergency braking, the warning message will appear on the cluster. For your safety, the driver should depress the brake pedal immediately and check the surroundings.
 - Brake control will end after the vehicle is stopped by emergency braking for approximately 2 seconds.
 - During emergency braking, braking control by the function will automatically cancel when the driver excessively depresses the brake pedal.

⚠ WARNING

Take the following precautions when using Rear Cross-Traffic Collision-Avoidance Assist:

- For your safety, set the Settings after parking the vehicle at a safe location.
- If any other function's warning message is displayed or audible warning is generated, Rear Cross-Traffic Safety function's warning message may not be displayed and audible warning may not be generated.
- You may not hear the warning sound of Rear Cross-Traffic Collision-Avoidance Assist if the surrounding is noisy.
- Rear Cross-Traffic Collision-Avoidance Assist may not operate if the

driver applies the brake pedal to avoid collision.

- During Rear Cross-Traffic Safety Function Operation, the vehicle may stop suddenly injuring passengers and shifting loose objects. Always have the seat belt on and keep loose objects secured.
- Even if there is a problem with Rear Cross-Traffic Collision-Avoidance Assist, the vehicle's basic braking performance will operate normally.
- Rear Cross-Traffic Collision-Avoidance Assist does not operate in all situations or cannot avoid all collisions.
- When Rear Cross-Traffic Collision-Avoidance Assist is operating, braking control by the function will automatically cancel when the driver excessively depresses the accelerator pedal.
- Rear Cross-Traffic Collision-Avoidance Assist may warn the driver late or may not warn the driver depending on the road and driving conditions.
- The driver should hold the responsibility to control the vehicle. Do not solely depend on Rear Cross-Traffic Collision-Avoidance Assist. Rather, maintain a safe braking distance, and if necessary, depress the brake pedal to reduce driving speed or to stop the vehicle.
- Never deliberately test Rear Cross-Traffic Collision-Avoidance Assist on people, animal, objects, etc. It may cause serious injury or death.

⚠ CAUTION

The brake control may not operate properly depending on the status of ESC (Electronic Stability Control).

There will only be a warning when:

- The ESC (Electronic Stability Control) warning light is on
- ESC (Electronic Stability Control) is engaged in a different function

*** NOTICE**

If braking is assisted by Rear Cross-Traffic Collision-Avoidance Assist, the driver must immediately depress the brake pedal and check vehicle surroundings.

- Brake control will end when the driver depresses the brake pedal with sufficient power.
- After shifting the gear to R (Reverse), braking control will operate once for left and right vehicle approach.

*** NOTICE**

The images or colors may be displayed differently depending on the specifications of the instrument cluster or theme.

Rear Cross-Traffic Collision-Avoidance Assist malfunction and limitations

Rear Cross-Traffic Collision-Avoidance Assist malfunction

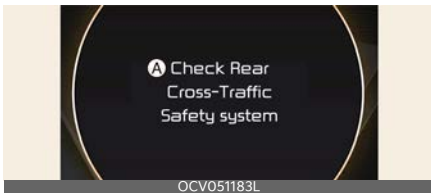

A: Check Rear Cross-Traffic Safety system

When Rear Cross-Traffic Collision-Avoidance Assist is not working properly, the warning message will appear and the master warning light (⚠) will

appear on the cluster. Have the function be inspected by an authorized Kia dealer.

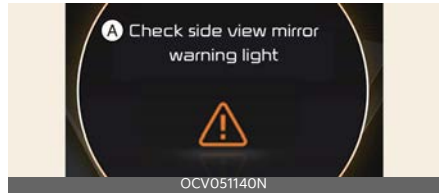

A: Check side view mirror warning light

When the outside rear view mirror warning light is not working properly, the warning message will appear and the master warning light (⚠) will appear on the cluster. Have the function be inspected by an authorized Kia dealer.

Rear Cross-Traffic Collision-Avoidance Assist disabled

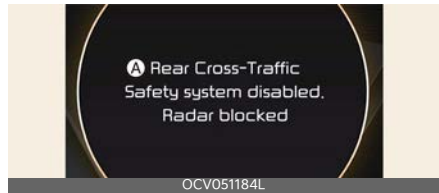

A: Rear Cross-Traffic Safety system disabled. Radar blocked

When the rear bumper around the rear corner radar or rear sensor is covered with foreign material, such as snow or rain, or installing a trailer or carrier, it can reduce the detecting performance and temporarily limit or disable Rear Cross-Traffic Collision-Avoidance Assist.

If this occurs, the warning message will appear on the cluster. But it is not a Rear Cross-Traffic Collision-Avoidance Assist malfunction.

The function will operate normally when such foreign material or trailer, etc. is removed. Always keep it clean.

If the function does not operate normally after it is removed, have the function inspected by an authorized Kia dealer.

⚠ WARNING

- Even though the warning message or warning light does not appear on the cluster, Rear Cross-Traffic Collision-Avoidance Assist may not operate properly.
- Rear Cross-Traffic Collision-Avoidance Assist may not operate properly in an area (for example: open terrain), where any substance are not detected after turning ON the vehicle.

⚠ CAUTION

Turn off Rear Cross-Traffic Collision-Avoidance Assist to install a trailer, carrier, etc., or remove the trailer, carrier, etc. to use Rear Cross-Traffic Collision-Avoidance Assist.

Limitations of Rear Cross-Traffic Collision-Avoidance Assist

Rear Cross-Traffic Collision-Avoidance Assist may not operate normally, or the function may operate unexpectedly under the following circumstances:

- Departing from where trees or grass are overgrown
- Departing from where roads are wet
- Speed of the approaching vehicle is fast or slow

Braking control may not work, driver's attention is required in the following circumstances:

- The vehicle severely vibrates while driving over a bumpy road, uneven road or concrete patch
- Driving on a slippery surface due to snow, water puddle, ice, etc.
- The tire pressure is low or a tire is damaged
- The brake is reworked
- Remote Smart Parking Assist is operating (if equipped)

*** NOTICE**

For more details on the limitations of the rear corner radar, refer to "Blind-Spot Collision-Avoidance Assist (BCA) (if equipped)" on page 7-28.

⚠ WARNING

- Driving near a vehicle or structure

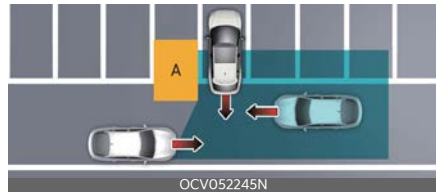

[A]: Structure

Rear Cross-Traffic Collision-Avoidance Assist may be limited when driving near a vehicle or structure, and may not detect the vehicle approaching from the blind spot area. If this occurs, the function may not warn the driver or control the brakes when necessary.

Always check your surroundings while Reversing.

- When the vehicle is in a complex parking environment



Rear Cross-Traffic Collision-Avoidance Assist may detect vehicles which are parking or pulling out near your vehicle (for example: a vehicle leaving beside your vehicle, a vehicle parking or pulling out in the rear area, a vehicle approaching your vehicle making a turn, etc.). If this occurs, the function may unnecessarily warn the driver and control the brake.

Always check your surroundings while Reversing.

- When the vehicle is parked diagonally



[A]: Vehicle

Rear Cross-Traffic Collision-Avoidance Assist may be limited when Reversing diagonally, and may not detect the vehicle approaching from the blind spot area. If this occurs, the function may not warn the driver or control the brakes when necessary.

Always check your surroundings while Reversing.

- When the vehicle is on or near a slope



Rear Cross-Traffic Collision-Avoidance Assist may be limited when the vehicle is on a uphill or downhill slope, or near it, and may not detect the vehicle approaching from the blind spot area. If this occurs, the function may not warn the driver or control the brakes when necessary.

Always check your surroundings while Reversing.

- Pulling into the parking space where there is a structure



[A]: Structure, [B]: Wall

Rear Cross-Traffic Collision-Avoidance Assist may detect vehicles passing by in front of you when parking backwards into a parking space with a wall or structure in the rear or side area. If this occurs, the function may unnecessarily warn the driver and control the brake.

Always check your surroundings while Reversing.

- When the vehicle is parked rearward

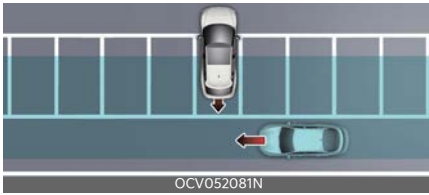

Rear Cross-Traffic Collision-Avoidance Assist may detect vehicles passing by behind you when parking backwards into a parking space. If this occurs, the function may unnecessarily warn the driver and control the brake.

Always check your surroundings while Reversing.

This device complies with Industry Canada licence-exempt RSS standard(s).

Operation is subject to the following two conditions:

1. This device may not cause interference, and
2. This device must accept any interference, including interference that may cause undesired operation of the device.

⚠ WARNING

- When you are towing a trailer or another vehicle, do not use Rear Cross-Traffic Collision-Avoidance Assist. The function could destabilize the vehicle.
- Rear Cross-Traffic Collision-Avoidance Assist may not operate suddenly if interfered by strong electromagnetic waves.
- Rear Cross-Traffic Collision-Avoidance Assist may not operate for 3 seconds after the vehicle is started, or the rear corner radars are initialized.
- If the vehicle is turned off and then restarted with the sensor blocked or malfunction, Rear Cross-Traffic Collision-Avoidance Assist may not operate properly.

Reverse Parking Distance Warning (PDW) (if equipped)

Reverse Parking Distance Warning will help warn the driver if a person, an animal or an object is detected within a certain distance when the vehicle is moving in reverse.

Detecting sensor

Rear ultrasonic sensors (Type A)



Rear ultrasonic sensors (Type B - GT-Line)



Rear ultrasonic sensors (Type C - GT)



Refer to the picture above for the detailed location of the detecting sensors.

Reverse Parking Distance Warning settings

Warning Methods



A: **Driver Assistance**

1 **Warning Methods**

2 **Warning Volume**

Warning Methods can be set when the vehicle is in ON position.

- **Warning Volume:** Select **Setup** → **Vehicle** → **Driver Assistance** → **Warning Methods** → **Warning Volume** on the infotainment system, and adjust the warning volume.

Even if you set the warning volume to 0, Warning volume will keep its volume in 1. (If steering wheel vibration equipped)

CAUTION

- Ensure that **Warning Methods** you have set may apply to the Warning Methods of other driver assistance systems.
- **Warning Methods** will maintain its last setting even if the vehicle is restarted.
- The setting menu may not be available for your vehicle depending on the vehicle features and specifications.

Reverse Parking Distance Warning operation

Parking Safety button



Press the Parking Safety (P) button to turn on or off Reverse Parking Distance Warning.

- When Reverse Parking Distance Warning is off (button indicator light off), if you shift the gear to R (Reverse), Reverse Parking Distance Warning will automatically turn on.
- If you shift the gear to R (Reverse), Reverse Parking Distance Warning will not turn off even if you press the Parking Safety (P) button for your safety.

Reverse Parking Distance Warning

Reverse Parking Distance Warning will operate under the following conditions.

- Shift the gear to R (Reverse).
- The vehicle's speed is below 10 km/h (6 mph).

Warning indication and warning sound

Distance from object	Warning indicator when driving backward	Warning sound
60~120 cm (24~48 inches)		Buzzer beeps intermittently
30~60 cm (12~24 inches)		Beeps more frequently
within 30 cm (12 inches)		Beeps continuously

- The corresponding indicator will appear on the cluster or infotainment system whenever each ultrasonic sensor detects a person, animal or object in its sensing range. Also an audible warning will sound.
- When more than two objects are detected at the same time, the closest one will be warned with an audible warning.
- Distance from object may be detected differently when obstacles are not located in front of the sensor.
- The shape of the indicator in the illustration may differ from the actual vehicle.

Reverse Parking Distance Warning malfunction and precautions

Reverse Parking Distance Warning malfunction

After starting the vehicle, a beep will sound once when the gear is shifted to R (Reverse) to indicate Reverse Parking Distance Warning is operating normally. However, if one or more of the following occurs, first check whether the ultrasonic sensor is damaged or blocked with

foreign material. If it still does not work properly, have your vehicle inspected by an authorized Kia dealer.

- The audible warning does not sound.
- The buzzer sounds intermittently.
- The warning message appears on the cluster.



A: Ultrasonic sensor error or blockage

Limitations of Reverse Parking Distance Warning

- Reverse Parking Distance Warning may not operate normally when:
 - Moisture is frozen to the sensor (Reverse Parking Distance Warning will operate normally when it is melted.)
 - Sensor is covered with foreign material, such as snow or water (Reverse Parking Distance Warning will operate normally when such foreign material are removed.)
 - The weather is extremely hot or cold
 - The sensor or sensor assembly is disassembled
 - The surface of the sensor is pressed hard or an impact is applied with a hard object
 - The surface of the sensor is scratched with a sharp object
 - The sensors or its surrounding area is directly sprayed with high pressure washer

- Reverse Parking Distance Warning may malfunction when:
 - Heavy rain or water spray is present
 - Water flows on the surface of the sensor
 - Affected by another vehicle's sensors
 - The sensor is covered with snow
 - Driving on uneven road, gravel roads or bushes
 - Objects that generates ultrasonic waves are near the sensor
 - Installing the license plate differently from the original location
 - The vehicle bumper height or ultrasonic sensor installation has been modified
 - Attaching equipments or accessories around the ultrasonic sensors
- The following objects may not be detected:
 - Sharp or slim objects, such as ropes, chains or small poles.
 - Objects, which tend to absorb sensor frequency, such as clothes, spongy material or snow.
 - Objects smaller than 100 cm (40 inches) in length and narrower than 14 cm (6 inches) in diameter.
 - Pedestrians, animals or objects that are very close to the ultrasonic sensors

WARNING

- Reverse Parking Distance Warning is a supplemental function. The operation of Reverse Parking Distance Warning can be affected by several factors (including environmental conditions). It is the responsibility of the

driver to always check the rear view before and while parking.

- Your vehicle warranty does not cover any accidents or damage to the vehicle due to the malfunction of Reverse Parking Distance Warning.
- Pay close attention when driving near objects, pedestrians, and especially children. Some objects may not be detected by the ultrasonic sensors, due to the objects distance, size or material, all of which can limit the effectiveness of the sensor.
- Parking Distance Warning indicator may not occur sequentially depending on vehicle speed or obstacle shape.
- If Reverse Parking Distance Warning needs repair, have your vehicle inspected by an authorized Kia dealer.

Forward/Reverse Parking Distance Warning (PDW) (if equipped)

Forward/Reverse Parking Distance Warning will help warn the driver if a person, an animal or an object is detected within a certain distance from the ultrasonic sensors when the vehicle is moving forward or in reverse.

Detecting sensor

Front ultrasonic sensors



Rear ultrasonic sensors (Type A)



Rear ultrasonic sensors (Type B - GT-Line)



Rear ultrasonic sensors (Type C - GT)



Refer to the picture above for the detailed location of the detecting sensors.

Forward/Reverse Parking Distance Warning settings

Warning Methods



A: Driver Assistance

1 Warning Methods

2 Warning Volume

Warning Methods can be set when the vehicle is in ON position.

- **Warning Volume:** Select **Setup** → **Vehicle** → **Driver Assistance** → **Warning Methods** → **Warning Volume** on the infotainment system, and adjust the warning volume.

Even if you set the warning volume to 0, Warning volume will keep its volume in 1. (If steering wheel vibration equipped)

CAUTION

- Ensure that **Warning Methods** you have set may apply to the Warning Methods of other driver assistance systems.
- **Warning Methods** will maintain its last setting even if the vehicle is restarted.
- The setting menu may not be available for your vehicle depending on the vehicle features and specifications.

Parking Distance Warning Auto On

You can set the parking distance warning to be ON at low speeds. To use Parking Distance Warning Auto On function, select **Setup** → **Vehicle** → **Driver Assistance** → **Parking Safety** → **Parking Distance Warning Auto On** from the infotainment system screen.

* NOTICE

If Parking Distance Warning Auto On is selected, the Parking Safety (P_{SA}) button indicator light will turn on.

Forward/Reverse Parking Distance Warning operation

Parking Safety button



Press the Parking Safety (P_{SA}) button to turn on or off Forward/Reverse Parking Distance Warning.

- When Forward/Reverse Parking Distance Warning is off (button indicator light off), if you shift the gear to R (Reverse), Forward/Reverse Parking Distance Warning will automatically turn on.
- If you shift the gear to R (Reverse), Forward/Reverse Parking Distance Warning will not turn off even if you press the Parking Safety (P_{SA}) button for your safety.

Forward Parking Distance Warning

Forward Parking Distance Warning will operate when one of the condition is satisfied.



- The gear is shifted from R (Reverse) to D (Drive)
- The gear is in D (Drive) and the Parking Safety (P+L) button indicator light is on
- **Parking Distance Warning Auto On** is selected from the Settings menu and the gear is in D (Drive)
- The function warns the driver when **Setup → Vehicle → Driver Assistance → Parking Safety → Parking Distance Warning Auto On** is selected from the infotainment system, and the gear is in D (Drive)
- Vehicle speed is below 10 km/h (6 mph)

* NOTICE

- Forward Parking Distance Warning does not operate when the vehicle's forward speed is above 10 km/h (6 mph) even when the function is on (Parking Safety button indicator is on). Forward Parking Distance Warning will operate again when the vehicle's forward speed decreases below 6 mph (10 km/h).
- When the vehicle's forward speed is above 18 mph (30 km/h), the Forward Parking Distance Warning will turn off (Parking Safety button indicator off). Although you drive below 10 km/h (6 mph) again, Forward Parking Distance Warning will not automatically turn on. (**Setup → Vehicle → Driver Assistance → Parking Safety → Parking Distance Warning Auto On**)

is not selected from the infotainment system)

Warning indication and warning sound

Distance from object	Warning indicator when driving forward	Warning sound
60~100 cm (24~40 inches)		Buzzer beeps intermittently
30~60 cm (12~24 inches)		Beeps more frequently
within 30 cm (12 inches)		Beeps continuously

- The corresponding indicator will appear on the cluster or infotainment system screen whenever each ultrasonic sensor detects a person, animal or object in its sensing range. Also an audible warning will sound.
- When more than two objects are detected at the same time, the closest one will be warned with an audible warning.
- Distance from object may be detected differently when obstacles are not located in front of the sensor.
- The shape of the indicator in the illustration may differ from the actual vehicle.

Reverse Parking Distance Warning



Reverse Parking Distance Warning will operate when one of the condition is satisfied.

- The gear is shifted to R (Reverse).
- The vehicle's rearward speed is below 10 km/h (6 mph).

* NOTICE

When the vehicle's rearward speed is below 10 km/h (6 mph), both the front and rear ultrasonic sensors will detect objects. However, the front ultrasonic sensors can detect a person, animal or object when it is within 60 cm (24 inches) from the sensors.

Warning indication and warning sound

Distance from object	Warning indicator when driving backward	Warning sound
60~100 cm (24~40 inches)		Buzzer beeps intermittently
30~60 cm (12~24 inches)		Beeps more frequently
within 30 cm (12 inches)		Beeps continuously

- The corresponding indicator will appear on the cluster or infotainment system screen whenever each ultrasonic sensor detects a person, animal or object in its sensing range. Also an audible warning will sound.
- When more than two objects are detected at the same time, the closest

one will be warned with an audible warning.

- Distance from object may be detected differently when obstacles are not located in front of the sensor.
- The shape of the indicator in the illustration may differ from the actual vehicle.

Forward/Reverse Parking Distance Warning malfunction and precautions

Forward/Reverse Parking Distance Warning malfunction

After starting the vehicle, a beep will sound once when the gear is shifted to R (Reverse) to indicate Forward/Reverse Parking Distance Warning is operating normally.

However, if one or more of the following occurs, first check whether the ultrasonic sensor is damaged or blocked with foreign material. If it still does not work properly, have your vehicle inspected by an authorized Kia dealer.

- The audible warning does not sound.
- The buzzer sounds intermittently.
- The warning message appears on the cluster.



A: Ultrasonic sensor error or blockage

Limitations of Forward/Reverse Parking Distance Warning

- Forward/Reverse Parking Distance Warning may not operate normally when:

- Moisture is frozen to the sensor (Forward/Reverse Parking Distance Warning will operate normally when it is melted.)
- Sensor is covered with foreign material, such as snow or water (Forward/Reverse Parking Distance Warning will operate normally when such foreign material are removed.)
- The weather is extremely hot or cold
- The sensor or sensor assembly is disassembled
- The surface of the sensor is pressed hard or an impact is applied with a hard object
- The surface of the sensor is scratched with a sharp object
- The sensors or its surrounding area is directly sprayed with high pressure washer
- Forward/Reverse Parking Distance Warning may malfunction when:
 - Heavy rain or water spray is present
 - Water flows on the surface of the sensor
 - Affected by another vehicle's sensors
 - The sensor is covered with snow
 - Driving on uneven road, gravel roads or bushes
 - Objects that generates ultrasonic waves are near the sensor
 - Installing the license plate differently from the original location
 - The vehicle bumper height or ultrasonic sensor installation has been modified
 - Attaching equipments or accessories around the ultrasonic sensors

- The following objects may not be detected:
 - Sharp or slim objects, such as ropes, chains or small poles.
 - Objects, which tend to absorb sensor frequency, such as clothes, spongy material or snow.
 - Objects smaller than 100 cm (40 inches) in length and narrower than 14 cm (6 inches) in diameter.
 - Pedestrians, animals or objects that are very close to the ultrasonic sensors

⚠ WARNING

- Forward/Reverse Parking Distance Warning is a supplemental function. The operation of Forward/Reverse Parking Distance Warning can be affected by several factors (including environmental conditions). It is the responsibility of the driver to always check the front and rear views before and while parking.
- Your vehicle warranty does not cover any accidents or damage to the vehicle due to the malfunction of Forward/Reverse Parking Distance Warning.
- Pay close attention when driving near objects, pedestrians, and especially children. Some objects may not be detected by the ultrasonic sensors, due to the objects distance, size or material, all of which can limit the effectiveness of the sensor.
- Parking Distance Warning indicator may not occur sequentially depending on vehicle speed or obstacle shape.
- If Forward/Reverse Parking Distance Warning needs repair, have your vehicle inspected by an authorized Kia dealer.

Reverse Parking Collision-Avoidance Assist (PCA) (if equipped)

Reverse Parking Collision-Avoidance Assist can warn the driver or assist with braking to help reduce the possibility of collision with a pedestrian or an object when Reversing.

Detecting sensor

Rear view camera



Rear ultrasonic sensors (Type A)



Rear ultrasonic sensors (Type B - GT-Line)



Rear ultrasonic sensors (Type C - GT)



Refer to the picture above for the detailed location of the detecting sensors.

Reverse Parking Collision-Avoidance Assist settings

Parking Safety



A: Driver Assistance

1 Parking Safety

2 Rear Active Assist

3 Rear Warning Only

4 Off

With the vehicle on, select or deselect **Setup** → **Vehicle** → **Driver Assistance** → **Parking Safety** from the infotainment system screen to set whether or not to use each function.

- **Rear Active Assist:** Reverse Parking Collision-Avoidance Assist may warn the driver and assist with braking when a collision with a pedestrian or an object is imminent.
- **Rear Warning Only:** Reverse Parking Collision-Avoidance Assist may warn the driver when a collision with a pedestrian or an object is imminent. Braking will not be assisted.

- **Off:** Reverse Parking Collision-Avoidance Assist will turn off.

Turning On/Off



OCV041048L

Press and hold the Parking Safety (P) button for more than 2 seconds to turn Active rear assist or Rear Warning Only on or off.

Warning Methods



OCV053293L

A: Driver Assistance

1 Warning Methods

2 Warning Volume

Warning Methods can be set when the vehicle is in ON position.

- **Warning Volume:** Select **Setup** → **Vehicle** → **Driver Assistance** → **Warning Methods** → **Warning Volume** on the infotainment system, and adjust the warning volume.

Even if you set the warning volume to 0, Warning volume will keep its volume in 1. (If steering wheel vibration equipped)

CAUTION

- Ensure that **Warning Methods** you have set may apply to the Warning Methods of other driver assistance systems.

- **Warning Methods** will maintain its last setting even if the vehicle is restarted.
- The setting menu may not be available for your vehicle depending on the vehicle features and specifications.

Reverse Parking Collision- Avoidance Assist operation

Operating conditions

After selecting **Active assistance** or **Warning only** from the Settings menu, Reverse Parking Collision-Avoidance Assist will turn on when the following conditions are satisfied:

- The liftgate is closed
- The gear is shifted to R (Reverse)
- Vehicle speed is below 10 km/h (6 mph) (For pedestrians)
- Vehicle speed is below 4 km/h (2 mph) (For objects)
- Reverse Parking Collision-Avoidance Assist components such as the rear view camera and the rear ultrasonic sensors are in normal conditions

When Reverse Parking Collision- Avoidance Assist activates, a line appears behind the vehicle image in the instrument cluster.



OCV051185L

* NOTICE

Reverse Parking Collision-Avoidance Assist operates only once after the gear is shifted to R (Reverse). To reactivate Reverse Parking Collision-Avoidance

Assist, shift the gear from another gear to R (Reverse).

Rear Collision-Avoidance Assist

If Reverse Parking Collision-Avoidance Assist detects a risk of collision with a pedestrian or an object, Reverse Parking Collision-Avoidance Assist will warn the driver with an audible warning and warning message on the cluster. When Rear View Monitor is operating, a warning will appear on the infotainment system screen. The warning will turn off when the driver shifts the gear to P (Park), N (Neutral), or D (Drive).

If Reverse Parking Collision-Avoidance Assist detects an imminent collision with a pedestrian or an object behind the vehicle, Reverse Parking Collision-Avoidance Assist will assist you with braking. The driver needs to pay attention as the brake assist will end within 5 minutes. Brake control will also end when:

- The gear is shifted to P (Park) or D (Drive).
- The driver depresses the brake pedal with sufficient power.

* NOTICE

If braking assist has lasted for approximately 5 minutes, the Electronic Parking Brake **EPB** will be engaged simultaneously.

Rear Collision Warning

If Reverse Parking Collision-Avoidance Assist detects a risk of collision with a pedestrian or an object, Reverse Parking Collision-Avoidance Assist will warn the driver with an audible warning and warning message on the cluster. When Rear View Monitor is operating, a warn-

ing will appear on the infotainment system screen. Braking will not be assisted. The warning will turn off when the gear is shifted to P (Park), N (Neutral) or D (Drive).

Reverse Parking Collision-Avoidance Assist malfunction and limitations

Reverse Parking Collision-Avoidance Assist malfunction



A: Check Parking Safety system

When Reverse Parking Collision-Avoidance Assist or other related functions are not working properly, the warning message will appear on the cluster, and Reverse Parking Collision-Avoidance Assist will turn off automatically.

Have your vehicle inspected by an authorized Kia dealer.

Reverse Parking Collision-Avoidance Assist disabled

Wide-rear view camera



The wide-rear view camera is used as a detecting sensor to detect pedestrians. If the camera lens is covered with foreign material, such as snow or rain, it may adversely affect camera performance

and Reverse Parking Collision-Avoidance Assist may not operate normally. Always keep the camera lens clean.

Rear ultrasonic sensors (Type A)



Rear ultrasonic sensors (Type B - GT-Line)



Rear ultrasonic sensors (Type C - GT)



The rear ultrasonic sensors are located inside the rear bumper to detect objects in the rear area. If the sensors are covered with foreign material, such as snow or rain, it may adversely affect sensor performance and Reverse Parking Collision-Avoidance Assist may not operate normally. Always keep the rear bumper clean.

The warning message will appear on the cluster if the following situations occur:

Wide-rear view camera

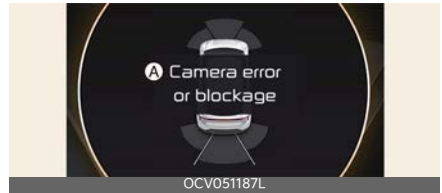

A: Camera error or blockage

Rear ultrasonic sensors



A: Ultrasonic sensor error or blockage

- The wide-rear view camera or rear ultrasonic sensor(s) is covered with foreign material, such as snow or rain, etc.
- There is inclement weather, such as heavy snow, heavy rain, etc.

If this occurs, Reverse Parking Collision-Avoidance Assist may turn off or may not operate properly. Check whether the rear view camera and rear ultrasonic sensors are clean.

Limitations of Reverse Parking Collision-Avoidance Assist

Reverse Parking Collision-Avoidance Assist may not assist braking or warn the driver even if there are pedestrians or objects under the following circumstances:

- Any non-factory equipment or accessory is installed
- Your vehicle is unstable due to an accident or other causes
- Bumper height or rear ultrasonic sensor installation has been modified

Driver assistance system

- Rear view camera or rear ultrasonic sensor(s) is damaged
- Rear view camera or the rear ultrasonic sensor(s) is stained with foreign material, such as snow, dirt, etc.
- Rear view camera is obscured by a light source or by inclement weather, such as heavy rain, fog, snow, etc.
- The surrounding is very bright or very dark
- Outside temperature is very high or very low
- The wind is either strong (above 20 km/h (12 mph)) or blowing perpendicular to the rear bumper
- Objects generating excessive noise, such as vehicle horns, loud motorcycle engines or truck air brakes, are near your vehicle
- An ultrasonic sensor with similar frequency is near your vehicle
- The pedestrians are difficult to recognize under following conditions:
 - There is ground height difference between the vehicle and the pedestrian
 - The image of the pedestrian in the rear view camera is indistinguishable from the background
 - The pedestrian is near the rear edge of the vehicle
 - The pedestrian is not standing upright
 - The pedestrian is either very short or very tall for Reverse Parking Collision-Avoidance Assist to detect
 - The pedestrian or cyclist is wearing clothing that easily blends into the background, making it difficult to detect

Reverse Parking Collision-Avoidance Assist (PCA)

- The pedestrian is wearing clothing that does not reflect ultrasonic waves well
- Size, thickness, height, or shape of the object does not reflect ultrasonic waves well (e.g. pole, bush, curbs, carts, edge of a wall, etc.)
- The pedestrian or the object is moving
- The pedestrian or the object is very close to the rear of the vehicle
- A wall is behind the pedestrian or the object
- The object is not located at the rear center of your vehicle
- The object is not parallel to the rear bumper
- The road is slippery or inclined
- The driver backs up the vehicle immediately after shifting to R (Reverse)
- The driver accelerates or circles the vehicle

Reverse Parking Collision-Avoidance Assist may unnecessarily warn the driver or assist with braking even if there are no pedestrians or objects under the following circumstances:

- Any non-factory equipment or accessory is installed
- Your vehicle is unstable due to an accident or other causes
- Bumper height or rear ultrasonic sensor installation has been modified
- Your vehicle height is low or high due to heavy loads, abnormal tire pressure, etc.
- Rear view camera or the rear ultrasonic sensor(s) is stained with foreign material, such as snow, dirt, etc.
- The pattern on the road is mistaken for a pedestrian

- There is shadow or light reflecting on the ground
- Pedestrians or objects are around the path of the vehicle
- Objects generating excessive noise, such as vehicle horns, loud motorcycle engines or truck air brakes, are near your vehicle
- Your vehicle is backing towards a narrow passage or parking space
- Your vehicle is backing towards an uneven road surface, such as an unpaved road, gravel, bump, gradient, etc.
- A trailer or carrier is installed on the rear of your vehicle
- An ultrasonic sensor with similar frequency is near your vehicle

⚠ WARNING

- Always pay extreme caution while driving. The driver is responsible for controlling the brake for safe driving.
- Always pay attention to road and traffic conditions while driving, whether or not there is a warning.
- Always look around your vehicle to make sure there are no pedestrians or objects before moving the vehicle.
- The performance of Reverse Parking Collision-Avoidance Assist may vary under certain conditions. If vehicle speed is above 4 km/h (2 mph), Reverse Parking Collision-Avoidance Assist will provide collision avoidance assist only when pedestrians are detected. Always look around and pay attention when Reversing your vehicle.
- Some objects may not be detected by the rear ultrasonic sensors due to the objects distance, size or material, all of

- which can limit the effectiveness of the sensor.
- Reverse Parking Collision-Avoidance Assist may not operate properly or may operate unnecessarily depending on the road conditions and the surroundings.
- Do not solely rely on Reverse Parking Collision-Avoidance Assist. Doing so may lead to vehicle damage or injuries.
- Always keep the rear view camera and rear ultrasonic sensors clean.
- Do not use any cleanser containing acid or alkaline detergents when cleaning the rear view camera lens. Use only a mild soap or neutral detergent, and rinse thoroughly with water.
- Do not spray the rear view camera or the rear ultrasonic sensors or their surrounding area directly with a high pressure washer. It may cause the rear view camera or the rear ultrasonic sensors to malfunction.
- Do not apply objects, such as a bumper sticker or a bumper guard, near the rear view camera or rear ultrasonic sensors or apply paint to the bumper. Doing so may adversely affect the performance of Reverse Parking Collision-Avoidance Assist.
- Never disassemble or apply impact on the rear view camera or the rear ultrasonic sensors components.
- Do not apply unnecessary force on the rear view camera or the rear ultrasonic sensors. Reverse Parking Collision-Avoidance Assist may not operate properly if the rear view camera or the rear ultrasonic sensor(s) is forcibly moved out of proper alignment. Have your vehicle inspected by an authorized Kia dealer.

- Noise may be heard when sudden braking occurs to avoid a collision.
- If any other warning sound such as the seat belt warning chime is already generated, Reverse Parking Collision-Avoidance Assist warning may not sound.
- Reverse Parking Collision-Avoidance Assist may not work properly if the bumper has been damaged, replaced or repaired.
- Reverse Parking Collision-Avoidance Assist may not operate normally if interfered by strong electromagnetic waves.
- Playing the vehicle audio system at high volume may prevent passengers from hearing Reverse Parking Collision-Avoidance Assist warning sounds.
- The brake control may not operate properly depending on the status of ESC (Electronic Stability Control).
There will only be a warning when:
 - The ESC (Electronic Stability Control) warning light is on
 - ESC (Electronic Stability Control) is engaged in a different function





*** NOTICE**

Reverse Parking Collision-Avoidance Assist can detect a pedestrian or an object when:

- A pedestrian is standing behind the vehicle
- A large obstacle, such as a vehicle, is parked in the rear center of your vehicle

Remote Smart Parking Assist (RSPA) (if equipped)

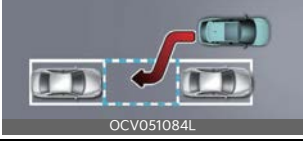
Remote Smart Parking Assist uses vehicle sensors to help the driver park and exit parking spaces remotely from outside the vehicle by automatically searching for parking spaces, and controlling the steering wheel, vehicle speed and gearshifts.

Function	Description
Remote Operation	<p>Remotely moving forward or backward</p>  <p>OCV051082L</p>
Smart Parking or Remote Smart Parking	<p>Perpendicular reverse parking</p>  <p>OCV051083L</p>
	<p>Parallel reverse parking</p>  <p>OCV051084L</p>
Smart Exit	<p>Parallel forward exit</p>  <p>OCV052085N</p>

- Remote Smart Parking and Remote Operation function may be operated from outside the vehicle using the smart key.
- Smart Parking and Remote Smart Parking function may be operated from inside the vehicle.

- Smart Parking and Remote Smart Parking function helps the driver with perpendicular reverse parking and parallel reverse parking.
- Smart Exit function helps the driver with parallel forward exit.
- When Remote Smart Parking Assist operates, Parking Distance Warning and 360° camera monitoring system will also operate. For more details, refer to "Forward/Reverse Parking Distance Warning (PDW) (if equipped)" on page 7-115 and "360° camera monitoring system (if equipped)" on page 7-99.

Detecting sensor

Front ultrasonic sensors



Front side ultrasonic sensors



Rear side ultrasonic sensors



Rear ultrasonic sensors (Type A)



Rear ultrasonic sensors (Type B - GT-Line)



Rear ultrasonic sensors (Type C - GT)



Refer to the picture above for the detailed location of the detecting sensors.

⚠ WARNING

- Never disassemble the detecting sensor or sensor assembly, or apply any impact on it.
- If the detecting sensor have been replaced or repaired, have your vehicle inspected by an authorized Kia dealer.
- Remote Smart Parking Assist may malfunction if the vehicle bumper height or ultrasonic sensor installation has been modified or damaged. Any non-factory installed equipment or accessories may also interfere with the sensor performance.

- When the ultrasonic sensor is frozen or stained with snow, dirt, or water, the sensor may not operate until the stains are removed using a soft cloth.
- Do not push, scratch or strike the ultrasonic sensor. Sensor damage could occur.
- Do not spray the ultrasonic sensors or its surrounding area directly with a high pressure washer.

Remote Smart Parking Assist settings

Warning Methods



A: Driver Assistance

1 Warning Methods

2 Warning Volume

Warning Methods can be set when the vehicle is in ON position.

- **Warning Volume:** Select **Setup** → **Vehicle** → **Driver Assistance** → **Warning Methods** → **Warning Volume** on the infotainment system, and adjust the warning volume.

Even if you set the warning volume to 0, Warning volume will keep its volume in 1. (If steering wheel vibration equipped)





CAUTION

- Ensure that **Warning Methods** you have set may apply to the Warning Methods of other driver assistance systems.
- **Warning Methods** will maintain its last setting even if the vehicle is restarted.
- The setting menu may not be available for your vehicle depending on the vehicle features and specifications.

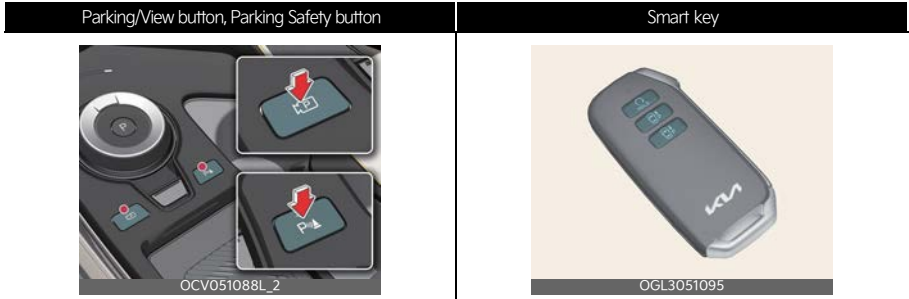
Remote Smart Parking Assist operation

Remote Smart Parking button



Location	Name	Symbol	Description
Inside vehicle	Parking/View button		<ul style="list-style-type: none"> Press and hold the Parking/View button to turn on Remote Smart Parking Assist. Also, Forward/Reverse Parking Distance warning will automatically turn on. (However, functions may differ depending on the situations. Refer to each function's description for more details in the following pages.) Press and hold the Parking/View button while Smart Parking or Smart Exit function is on to operate the function.
	Parking Safety button		<ul style="list-style-type: none"> Press the Parking Safety button while Remote Smart Parking Assist is operating to end function operation.
Smart key	Remote Start button		<ul style="list-style-type: none"> Press the Remote Start button after the door is locked with the vehicle off to start the vehicle remotely. Press the Remote Start button while Remote Operation function is operating to end function operation.
	Forward button		<ul style="list-style-type: none"> When using Remote Smart Parking function, regardless of which direction button is pressed, reverse parking is supported while the button is pressed.
	Backward button		<ul style="list-style-type: none"> When using the Remote Operation function, the vehicle moves in the direction of the button while the button is pressed.

Remote Operation

Operating order

Remote Operation operates in the following order:

1. Getting ready to remotely move forward and backward
2. Remotely moving forward and backward

1. Getting ready to remotely move forward and backward

There are two ways to operate Remote Operation function.

Method (1): Using the function with vehicle off



1. Within a certain range from the vehicle press the door lock (🔒) button on the smart key and lock all doors.
2. Press and hold the Remote Start button (🔑) within 4 seconds until the vehicle starts.

* For more details on remotely starting the vehicle, refer to "Smart key" on page 5-7.

Method (2): Using the function with vehicle on

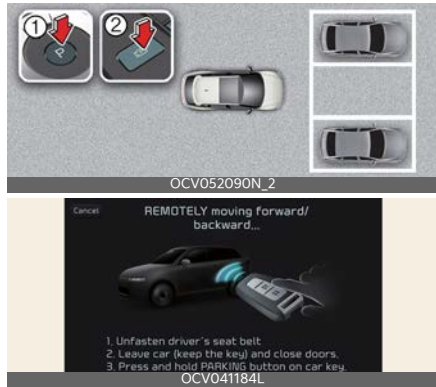

A: REMOTELY moving forward/backward...

1. Unfasten driver's seat belt.
2. Leave car (keep the key) and close doors.
3. Press and hold PARKING button on car key.

1. Park the vehicle in front of the space where you want to use Remote Operation function, and shift the gear to P (Park).
2. Press and hold the Parking/View (P/V) button to turn on Smart Parking Assist. A message **Under REMOTE control** will appear on the infotainment system screen.
3. Get out of the vehicle with the smart key and close all doors.

* NOTICE

- **Agree** must be selected on the infotainment system screen and the infotainment system has to operate properly to use Remote Operation function.

- Method (2) can be used after the vehicle has been driven above 5 km/h (3 mph).
- If the function is turned on again after parallel parking is completed by Remote Smart Parking Assist, Remote Operation function can be used with Method (2).

2. Remote Operation

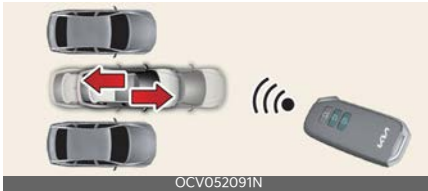

1. Press and hold one of the Forward (⏩) or Backward (⏪) button on the smart key.
 - Remote Smart Parking Assist will automatically control the steering wheel, vehicle speed and gear shift. The vehicle will move in the direction of the button pressed.
 - While Remote Operation function is operating, if you let the button, the vehicle will stop and function control will pause. The function will start operating again when the button is pressed and held again.
2. Hold down the Forward (⏩) or Backward (⏪) button until the vehicle reaches the target location.
3. When Remote Operation is done, get in the vehicle with the smart key or press the Remote Start (⏻) button on the smart key from outside the vehicle.
 - The message will appear on the infotainment system screen. The vehicle will automatically shift to P (Park) and engage the parking brake.

* NOTICE

- Remote Operation can control the vehicle remotely using the smart key outside the vehicle.
- Check that all smart keys are outside the vehicle when using Remote Operation function.
- Remote Operation function will operate only when the smart key is within 4 m (13 ft.) from the vehicle. If there is no vehicle movement even when the Forward or Backward button is pressed on the smart key, check the distance to the vehicle and press the button again.
- The detecting range of the smart key may vary depending on the surroundings that are affected by radio waves such as transmission tower, broadcast station, etc.
- When remotely moving forward using method (1), it is recognized as an exit situation, and the vehicle moves 4 m (13 ft.) to check for pedestrians, animals or objects around the vehicle. After confirmation, the steering wheel is controlled according to the condition ahead.
- When remotely moving forward using method (2), it is recognized as a parking situation, and will immediately control the steering wheel according to the condition ahead to assist with entering the parking space and aligning the vehicle. However, performance may reduce depending on the pedestrians, animals, shape of

objects, location, etc. around the vehicle.

- For moving remotely backward, both method (1) and (2) aligns the steering wheel first, and then will only move the vehicle straight.

⚠ WARNING

- When using Remote Operation function, make sure that all passengers have gotten out of the vehicle.
- Before leaving the vehicle, close windows and sunroofs, and make sure the vehicle is off before locking the doors.
- If the vehicle's battery is discharged or Remote Smart Parking Assist malfunctions when parked in a narrow parking space, Remote Operation function will not operate. Always park your vehicle in a space wide enough for you to get in or out of your vehicle.
- Please note that depending on the parking space, you may not be able to exit from the space you have entered by using Remote Operation function.
- After parking, the surrounding may change due to the movement of surrounding vehicles. If this occurs, Remote Operation function may not operate.

Remote Smart Parking Assist operation status

Operation Status	Smart key LED	Hazard warning light
Under control	Green LED Continuously blinks	-
Pause	Red LED Continuously blinks	Blinks
Off	Red LED appears for 4 seconds and then turns off	Blinks 3 times and turns off
Complete	Green LED appears for 4 seconds and then turns off	Blinks 1 time and turns off

*** NOTICE**

- Operation status by the hazard warning light may not be applicable based on the regulation of your country.
- If the smart key is not within the operating range from the vehicle (approximately 4 m (13 ft.)), the smart key LED will not appear or blink. Use the smart key within the operating range.

How to turn off Remote Operation function while operating

- Press the Parking/View (P/V) button or shift the gear except to P (Park) while the infotainment system screen guides the driver using method 2.
- Press the Parking Safety (P+S) button or select **Cancel** on the infotainment system screen.
- Press the Remote Start (R) button on the smart key while the vehicle is being controlled by Remote Operation function. Remote Operation function will turn off. At this time, the vehicle will turn off.
- Get in the vehicle with the smart key. Remote Operation function will turn

off. At this time, the vehicle will remain on.

The function will pause in the following conditions when:

When Remote Operation function is paused, the vehicle will stop. If the condition that made the function to pause disappears, the function may operate again.

- There is a pedestrian, animal or object in the direction the vehicle is moving
- The door or liftgate is open
- The Forward (⏪) or Backward (⏩) button is not continuously pressed
- Simultaneously pressing multiple buttons on a smart key
- The smart key is not operated within 4 m (13 ft.) from the vehicle
- Button of another smart key is pressed in addition to the operating smart key (Excluding start button)
- Blind-Spot Collision-Avoidance Assist or Rear Cross-Traffic Collision-Avoidance Assist operates while the vehicle is being controlled in the reverse direction.
- The vehicle moves 7 m (22 ft.) while the smart key is pressed with Remote Operation function (maximum travel distance per button press)

The function will cancel in the following conditions when:

When Remote Operation function is canceled, the vehicle will automatically stop, shift the gear to P (Park) and engage EPB (Electronic Parking Brake).

- The steering wheel is steered
- The gear is shifted while the vehicle is moving

- Operating EPB while the vehicle is moving
- The vehicle hood is open
- The brake pedal or accelerator pedal is depressed when all the doors are closed
- The smart key is outside the vehicle when the brake pedal is depressed while the driver's door is open
- Rapid acceleration occurs
- Vehicle skid occurs
- The wheel is stuck by an obstacle and cannot move
- Approximately 3 minutes and 50 seconds have past after Remote Operation function has started to operate
- The slope of the road exceeds the operational range
- The function is paused for more than 1 minute
- The total travel distance of the vehicle has exceeded 14 m (45 ft.) after Remote Operation function operation
- The steering wheel, gearshift, braking, and drive controls are not working normally
- There is a problem with the smart key or the smart key battery is low
- ABS, TCS or ESC system operates due to slippery road conditions
- The alarm of the Theft Alarm System sounds
- The charging door opens
- The EV mode is utility mode

Smart Parking, Remote Smart Parking

Operating order

Parking function operates in the following order:

1. Getting ready for parking
2. Searching for parking space
3. Select parking type and operating mode
4. Smart Parking
5. Remote Smart Parking

* NOTICE

Parking function includes Smart Parking and Remote Smart Parking.

1. Getting ready for parking



1. With the vehicle turned on, depress the brake pedal and shift the gear to D (Drive) or N (Neutral).
2. Press and hold the Parking/View (P) button to turn on Remote Smart Parking Assist.

* NOTICE

- **Agree** must be selected on the infotainment system screen and the infotainment system has to operate properly to use Parking function.
- If you drive above 5 km/h (3 mph) with the vehicle on, you may use the Parking function with the gear shifted to N (Neutral).

2. Searching for parking space



A: Searching for parking space...

1 Slowly drive forward (below 20 km (12 mph)).

Slowly drive forward maintaining the distance of approximately 100 cm (40 inches) from the parked vehicles. The vehicle will search for a parking space from the side or front/rear of parked vehicle.

When searching for a parking space is complete, a message will appear on the infotainment system screen. **Select parking type** will be displayed 100 cm (40 inches) and the selected parking space will appear on Top View screen of 360° camera monitoring system.

* NOTICE

- Remote Smart Parking Assist searches for parking spaces that are next to parked vehicles, or parking spaces with parked vehicles in front or rear.
- While searching for a parking space, when vehicle speed is above 20 km/h (12 mph), a message will appear on the infotainment system screen informing you to slow down. When vehicle speed is above 30 km/h (18 mph), Parking function will turn off.
- Searching for a parking space will be completed when there is enough space to move the vehicle in addition to the parking space.

- Even if an audible sound is heard to notify that searching for a parking space is complete, search completion can be canceled immediately depending on surroundings.

* NOTICE

- If the distance is below 50 cm (20 inches) or over 150 cm (59 inches), Remote Smart Parking Assist may not be able to search for a parking space.

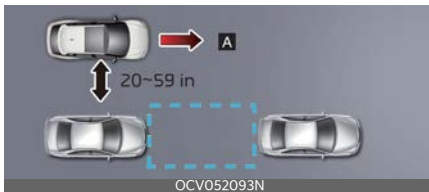

[A]: Searching for parking space

- If you do not maintain a certain distance from the parked vehicle, the performance to search for a parking space may reduce.
- Even if a diagonal parking space is searched as a parking space, parking is not assisted normally.
- Due to abnormal performance of the ultrasonic sensor or the influence of the surroundings, Parking function may not be able to search for a parking space even if there is a parking space, or may search for a space that is not suitable for parking.

3. Select parking type and operating mode

1. Parking type - Perpendicular reverse (Left/Right), Parallel reverse (Left/Right)



A: Select parking type

1 Parking type can only be selected at standstill.

With the vehicle stopped by depressing the brake pedal, touch the infotainment system screen to select the desired parking type.

* NOTICE

- If you continue to drive without stopping after the parking type selection screen appears, Remote Smart Parking Assist will return to the previous stage and search for a parking space.
- If Parking function is canceled unintentionally by pressing the Parking/View (P/V) button before the parking type is selected, you can return to the parking type selection stage by pressing and holding the button again while the vehicle is stopped.

⚠ WARNING

Before selecting the Parking type, the driver should check whether the parking space is suitable.

If the searched parking space by Remote Smart Parking Assist is narrow or unsuitable for parking, do not select

the Parking type and move the vehicle to search for another parking space.

2. Operating mode - Remote Parking, Smart Parking



A: Operation guide

1 REMOTE Parking

2 SMART Parking

After selecting a parking type, the infotainment system screen will guide you with Remote Smart Parking function and Smart Parking function. Follow the instructions to operate Remote Smart Parking Assist.

* NOTICE

- Operating instructions will be displayed on the screen for each desired function you select.
- Do not take your foot off the brake pedal during the Parking function guide. When the vehicle moves, Remote Smart Parking Assist will turn off.



A: SMART Parking

1 Take hands off steering wheel.

2 Press and hold PARKING button.

If Remote Smart Parking Assist cannot activate Remote Smart Parking function, only the Smart Parking guide will be displayed on the infotainment system screen.

4. Smart Parking



1. Press the Parking/View (P) button when the vehicle is stopped by depressing the brake pedal.
2. Release the brake pedal while holding the Parking/View (P) button.
 - Remote Smart Parking Assist will automatically control the steering wheel, vehicle speed and gear shift.
 - If you do not hold down the Parking/View button, the vehicle will

stop and function control will pause. The function will start operating again when the Parking/View button is pressed and held again.

3. Hold the Parking/View (P) button until the vehicle reaches the target parking position.
 - Message will appear on the infotainment system screen to inform you that parking is complete. The vehicle will automatically shift to P (Park) and engage the parking brake.
4. If you need to change the vehicle's position or location, manually complete parking your vehicle.

* NOTICE

- Smart Parking function will not operate if the door is open or the seat belt is not fastened.
- The parking location indicator is displayed on 360° camera monitoring system screen and is displayed until the vehicle enters the parking space for the first time by Smart Parking function.
- Vehicle speed can be adjusted by depressing the brake pedal while Smart Parking function is operating. However, the vehicle does not accelerate even when the accelerator pedal is depressed.
- Depending on parking environments, if the vehicle is stopped by a stopper, parking may be completed.

5. Remote Smart Parking



A: REMOTE Parking

1. Unfasten driver's seat belt.
2. Leave car (keep the key) and close doors.
3. Press and hold PARKING button on car key.
 1. Shift the gear to P (Park).
 2. Get out of the vehicle with the smart key, and close all doors.
 3. Press and hold one of the Forward (F) or Backward (B) button on the smart key.
 - Remote Smart Parking Assist will automatically control the steering wheel, vehicle speed and gear shift.
 - If you do not hold down the Forward (F) or Backward (B) button, the vehicle will stop and function control will pause. The function will start operating again when the button is pressed and held again.
4. Hold the Forward (F) or Backward (B) button on the smart key until the parking is complete.
 - When the vehicle reaches the target parking position, a message will appear on the infotainment system screen to inform you that parking is complete. The vehicle will automatically shift to P (Park), engage EPB (Electronic Parking Brake) and the vehicle will turn off.

5. If you need to change the vehicle's position or location, manually complete parking your vehicle.

*** NOTICE**

- When operating Remote Smart Parking function, make sure all smart keys are outside of the vehicle.
- Remote Smart Parking function will operate only when the smart key is within 4 m (13 ft.) from the vehicle. If there is no vehicle movement even when the Remote Forward or Backward button is pressed on the smart key, check the distance to the vehicle and press the button again.
- The detecting range of the smart key may vary depending on the surroundings that are affected by radio waves such as transmission tower, broadcast station, etc.
- The parking location indicator is displayed on 360° camera monitoring system screen and is displayed until the vehicle enters the parking space for the first time by Remote Smart Parking function.
- Depending on parking environments, if the vehicle is stopped by a stopper, parking may be completed.

⚠ WARNING

- When using Remote Smart Parking function, make sure that all passengers have gotten out of the vehicle.
- After ending or turning off Remote Smart Parking function, before leaving the vehicle, close windows and sunroof, and make sure the vehicle is off before locking the doors.

Smart Parking function

Operation status	Turn signal
Under control	The turn signal of the parking direction blinks until the first reverse is complete.

Operation status	Smart key LED	Hazard warning light	Turn signal
Under control	Green LED continuously blinks	-	The turn signal of the parking direction blinks until the first reverse is complete.
Pause	Red LED continuously blinks	Blinks	-
Off	Red LED appears for 4 seconds and then turns off	Blinks 3 times and turns off	-
Complete	Green LED appears for 4 seconds and then turns off	Blinks 1 time and turns off	-

*** NOTICE**

- Operation status by the hazard warning light may not be applicable based on the regulation of your country.
- If the smart key is not within the operating range from the vehicle (approximately 4 m (13 ft.)), the smart key LED will not appear or blink. Use the smart key within the operating range.

How to turn off Parking function while operating

- Press the Parking Safety (P_{SA}) button or select **Cancel** on the infotainment system screen to turn off.
- Press the Parking Safety (P_{SA}) button in Searching for parking space and Select parking type stage.
- Shift the gear to R (Reverse) while searching for parking space, select parking type and Select operating mode stage.

- While Smart Parking function is operating, depress the brake pedal to stop the vehicle. At this time, EPB (Electronic Parking Brake) will not be engaged.
 - While Smart Parking function is operating, press the Remote Start (Ω) button on the smart key.
- *
NOTICE
- Get in the vehicle with the smart key. Remote Smart Parking function will turn off. At this time, the vehicle will remain on.
-
- Remote Smart Parking
 - There is a pedestrian, animal or object in the direction the vehicle is moving
 - The door or liftgate is open
 - The Forward (⏪) or Backward (⏩) button is not continuously pressed
 - Simultaneously pressing multiple buttons on a smart key
 - The smart key is not operated within 4 m (13 ft.) from the vehicle
 - Button of another smart key is pressed in addition to the operating smart key
 - Blind-Spot Collision-Avoidance Assist or Rear-Cross Traffic Collision Assist operates while the vehicle is being controlled in the reverse direction

Parking function operation status

The function will pause in the following conditions when:

When Parking function is paused, the vehicle will automatically stop. If the condition that made the function to pause disappears, the function may operate again.

- Smart Parking
 - There is a pedestrian, animal or object in the direction the vehicle is moving
 - The door or liftgate is open
 - The driver's seat belt is not fastened
 - Blind-Spot Collision-Avoidance Assist or Rear-Cross Traffic Collision Assist operates while the vehicle is being controlled in the reverse direction
 - The Parking/View (⏪) button is not continuously pressed
 - The vehicle is stopped by depressing the brake pedal

The function will cancel in the following conditions when:

- Smart Parking

When Smart Parking function is canceled, the vehicle will automatically stop, shift the gear to P (Park) and engage EPB (Electronic Parking Brake).

 - The steering wheel is steered
 - The gear is shifted while the vehicle is moving
 - Operating EPB while the vehicle is moving
 - The hood is open
 - The driver opens the door with the seat belt unfastened
 - Rapid acceleration occurs
 - Vehicle skid occurs
 - The wheel is stuck by an obstacle and cannot move

- There are pedestrians, animals or objects at the front and rear of the vehicle
- Approximately 3 minutes and 50 seconds have passed after Smart Parking function has started to operate
- The slope of the road exceeds the operational range
- The function is paused for more than 1 minute
- The steering wheel, gearshift, braking, and drive controls are not working normally
- ABS, TCS or ESC system operates due to slippery road conditions
- The charging door opens
- The EV mode is utility mode
- Remote Smart Parking
When Remote Smart Parking function is canceled, the vehicle will automatically stop, shift the gear to P (Park) and engage EPB (Electronic Parking Brake).
 - The steering wheel is steered
 - The gear is shifted
 - Operating EPB while the vehicle is moving
 - The hood is open
 - The brake pedal or accelerator pedal is depressed when all the doors are closed
 - The smart key is outside the vehicle when the brake pedal is depressed while the driver's door is open.
 - Rapid acceleration occurs
 - Vehicle skid occurs
 - The wheel is stuck by an obstacle and cannot move

- There are pedestrians, animals or objects at the front and rear of the vehicle
- Approximately 3 minutes and 50 seconds have passed after Remote Smart Parking function has started to operate
- The slope of the road exceeds the operational range
- The function is paused for more than 1 minute
- The steering wheel, gearshift, braking, and drive controls are not working normally
- There is a problem with the smart key or the smart key battery is low
- ABS, TCS or ESC system operates due to slippery road conditions
- The alarm of the Theft Alarm System sounds
- The charging door opens
- The EV mode is utility mode

Smart Exit

Operating order

Smart Exit function operates in the following order:

1. Getting ready for exit
2. Checking space
3. Select exit direction
4. Smart Exit

1. Getting ready for exit



1. With the vehicle turned on, depress the brake pedal and shift the gear to P (Park) or N (Neutral).
2. Press and hold the Parking/View (P) button to turn on Remote Smart Parking Assist.

* NOTICE

- **Agree** must be selected on the infotainment system screen and the infotainment system has to operate properly to use Smart Exit function.
- Drive below 5 km/h (3 mph) with the vehicle on and shift the gear to N (Neutral), Smart Exit function can be used.
- If the function is turned on again after parallel parking is completed by Remote Smart Parking Assist, Smart Exit function can be used.

from nearby objects and check for space to exit.

2. When checking for space is complete, a message will appear on the infotainment system screen with an audible sound to notify the search is complete.

⚠ WARNING

- While checking for space, if there is a risk of collision with pedestrian, animal or object in the direction of vehicle exit, for your safety, Smart Exit function can be turned off.
- Even if check for space is completed, objects in the blind spot area cannot be detected by the sensors. The driver must directly check the blind spot area to continue using the function.

* NOTICE

Due to abnormal performance of the ultrasonic sensor or the influence of the surroundings, Parking function may not be able to search for a parking space even if there is a parking space, or may search for a space that is not suitable for parking.

2. Checking space



A: Checking space...

1 Stop the vehicle.

1. When the vehicle is stopped by depressing the brake pedal, the vehicle sensors will detect the distance

3. Select exiting direction



A: Select exiting direction

1 Direction can only be selected at standstill.

1. With the vehicle stopped by depressing the brake pedal, the infotainment

system screen displays the possible directions for parallel exit.

2. Touch the infotainment system screen to select the desired exit direction.

⚠ WARNING

Before selecting the Exit Direction, the driver should check whether the space for exit is suitable. If the searched exit space by Remote Smart Parking Assist is narrow or unsuitable (surrounding vehicles are parked vertically, etc.), do not use the Smart Exit function.

4. Smart Exit



A: SMART Exiting

- 1. Take hands off steering wheel.**
- 2. Press and hold PARKING button.**

1. Press the Parking/View (P) button when the vehicle is stopped by depressing the brake pedal.
 - When the brake pedal is released, Remote Smart Parking Assist will automatically control the steering wheel, vehicle speed and gearshift.
 - While Smart Exit function is operating, if you do not hold down the Parking/View button, the vehicle will stop and function control will pause. The function will start operating again when the Parking/View button is pressed and held again.
2. Hold the Parking/View (P) button until the vehicle reaches the target exit location. When the vehicle

reaches the target exit location, a message will appear on the infotainment system screen to inform you that exit is complete.

- When the vehicle reaches the target exit location, a message will appear on the infotainment system screen to inform you that exit is complete.

*** NOTICE**

- Smart Exit function will not operate if the door is open or the seat belt is not fastened.
- Vehicle speed can be adjusted by depressing the brake pedal while Smart Exit function is operating. However, the vehicle does not accelerate even when the accelerator pedal is depressed.
- If exit is completed while depressing the brake pedal, Smart Exit function will complete with the gear in D (Drive).
- If exit is completed while depressing the accelerator pedal, you must take your foot off the accelerator pedal once for the accelerator pedal to operate.
- If there is no vehicle operation such as depressing the brake pedal or accelerator pedal within 4 seconds after exit is complete, the vehicle will automatically shift to P (Park) and engage EPB (Electronic Parking Brake).
- After Exit function is complete, always check the surroundings before driving.

Smart Exit operation status

Operation status	Turn signal
Under control	The turn signal of the exit direction blinks until the exit is complete or Smart Exit is canceled.

How to turn off Smart function while operating

- Press the Parking/View (P/V) button in the following stage:
 - Checking space
 - Select exit direction
- Shift the gear to R (Reverse) in the following stage:
 - Checking space
 - Select exit direction
- Press the Parking Safety (P/S) button or select **Cancel** on the infotainment system screen to turn off Exit function.
- While Smart Exit function is operating, if the vehicle is stopped by depressing the brake pedal, and the gear is shifted, Exiting function will turn off. At this time, EPB (Electronic Parking Brake) will not be engaged.

The function will pause in the following conditions when:

When Exit function is paused, the vehicle will stop. If the condition that made the function to pause disappears, the function may operate again.

- There is a pedestrian, animal or object in the direction the vehicle is moving
- The door or liftgate is open
- The driver's seat belt is not fastened
- Blind-Spot Collision-Avoidance Assist or Rear-Cross Traffic Collision Assist operates while the vehicle is being controlled in the reverse direction

- The Parking/View (P/V) button is not continuously pressed
- The vehicle is stopped by depressing the brake pedal

The function will cancel in the following conditions when:

When Smart Exit function is canceled, the vehicle will automatically stop, shift the gear to P (Park) and engage EPB (Electronic Parking Brake).

- Smart Exit
 - The steering wheel is steered
 - The gear is shifted while the vehicle is moving
 - Operating EPB while the vehicle is moving
 - The hood is open
 - The driver opens the door with the seatbelt unfastened
 - Rapid acceleration occurs
 - Vehicle skid occurs
 - The wheel is stuck by an obstacle and cannot move
 - There are pedestrians, animals or objects at the front and rear of the vehicle
 - Approximately 3 minutes and 50 seconds have passed after Smart Exit function has started to operate
 - The slope of the road exceeds the operational range
 - The function was paused for more than 1 minute
 - The steering wheel, gearshift, braking, and drive controls are not working normally
 - ABS, TCS or ESC system operates due to slippery road conditions
 - The charging door opens

Remote Smart Parking Assist malfunction and limitations

Remote Smart Parking Assist malfunction

Remote Smart Parking Assist check



A: Check Parking Assist

1 Visit a nearby service center.

When Remote Smart Parking Assist is not working properly, the **Check Parking Assist** warning message will appear on the infotainment system screen. If the message appears, stop using the function, and have the function inspected by an authorized Kia dealer.

Remote Smart Parking Assist canceled



A: Parking Assist cancelled.

1 Please refer to owner's manual.

When Remote Smart Parking Assist is operating, the function can be canceled, and the **Parking Assist Cancelled.** warning message may appear regardless of the parking order. Other messages may appear depending on the

situations. Follow the instructions provided on the infotainment system screen while parking your vehicle with Remote Smart Parking Assist. Always look around and pay attention when using the function.

Remote Smart Parking Assist standby



A: Parking Assist conditions not met

1 Please refer to owner's manual.

When **Parking Assist conditions not met** message appears, when Parking/View (P/V) button has been pressed and held, Remote Smart Parking Assist is in standby. After a while, press and hold the Parking/View (P/V) button again to see if the function works.

The message appears even when the smart key's battery is low. Check the smart key battery level.

Limitations of Remote Smart Parking Assist

In the following circumstances, function performance to park or exit the vehicle may be limited, there may be a risk of collision, or Remote Smart Parking Assist may turn off. Park or exit the vehicle manually if necessary.

- An object is attached to the steering wheel
- The vehicle is installed with a snow chain, spare tire or different size wheel

- Tire pressure is lower or higher than the standard tire pressure
- Your vehicle is loaded with cargo longer or wider than your vehicle or a trailer is connected to your vehicle
- There is a problem with the wheel alignment
- Your vehicle is leaned severely to one side
- Your vehicle is equipped with a trailer hitch
- The license plate is installed differently from the original location
- There is a person, animal or object above or below the ultrasonic sensor when Remote Smart Parking Assist is activated
- The parking space is curved or diagonal
- There is an obstacle such as a person, animal or object (trash can, bicycle, motorcycle, shopping cart, narrow pillar etc.) near the parking space
- There is a circular pillar or narrow pillar, or a pillar surrounded by objects such as fire extinguisher, etc. near the parking space
- The road surface is bumpy (curbstone, speed bump, etc.)
- The road is slippery
- The parking space is near a vehicle with higher ground clearance or big, such as a truck, etc.
- The parking space is inclined
- There is heavy wind
- Operating Remote Smart Parking Assist on uneven roads, gravel roads, bushes, etc.
- The performance of the ultrasonic sensor is affected by extremely hot or cold weather
- The ultrasonic sensor is covered with snow or water
- An object that generates ultrasonic waves is nearby
- A wireless device with a transmission function operates near the ultrasonic sensors
- Your vehicle is affected by another vehicle's Parking Distance Warning
- The sensor is mounted or positioned incorrectly by an impact to the bumper
- When the ultrasonic sensor cannot detect the following objects: Sharp or slim objects, such as ropes, chains or small poles
- Objects smaller than 100 cm (40 inches) in length and narrower than 14 cm (6 inches) in diameter
- Objects which tend to absorb sensor frequency, such as clothes, spongy material or snow
- A narrow object such as a corner of a square pillar
- Person, animal or object near the ultrasonic sensor

Remote Smart Parking Assist may not operate normally under the following circumstances:

- Parking on inclines



Park manually when parking on inclines.

- Parking in snow



Snow may interfere with sensor operation, or Remote Smart Parking Assist may cancel if the road is slippery while parking.

- Parking on uneven surfaces



Remote Smart Parking Assist may cancel when the vehicle slips, or the vehicle cannot move due to road conditions such as pebbles or fragmented stones.

- Parking behind a truck



Do not use Remote Smart Parking Assist around vehicles with higher ground clearance, such as a bus, truck, etc. It may lead to an accident.

- Parking near a pillar



Remote Smart Parking Assist performance may reduce or collision with an obstacle may occur when there is a narrow object, circular pillar, square pillar, or a pillar surrounded by objects such as a fire extinguisher, etc. near the parking space. The driver should park the vehicle manually.

- Parking in a parking space with a vehicle on one side only



If Remote Smart Parking Assist is used, when parking in a parking space with a vehicle only on one side, your vehicle may cross the parking line to avoid the parked vehicle.

- Parking diagonal



Remote Smart Parking Assist does not provide diagonal parking. Even if your vehicle was able to enter the parking space, do not use the function because the function cannot operate normally.

- Leaving a parking space near a wall or parking in a narrow space



- Remote Smart Parking Assist may not operate properly when leaving a parking space that is narrow and near a wall. Always check for pedestrians, animals, objects while leaving.
- For your safety, Remote Smart Parking Assist does not search for parking spaces at areas with narrow parking spaces that are narrower than the minimum space required for parking.

⚠ WARNING

- It is the driver's responsibility to park and exit safely. Use Remote Smart Parking Assist while checking your surroundings at all times when parking and exiting. Under various environmental conditions, braking control may not operate because people, animals, other vehicles or objects around the vehicle may not be properly detected. If there is a risk of collision with a nearby obstacle, release the control button to stop the function.
- When using Remote Smart Parking Assist, stay out of the way in the direction the vehicle moves for your safety.
- Always check surroundings when using Remote Smart Parking Assist. You may collide with pedestrians, animals, or objects if they are near the sensor or are in the sensor's blind spot area.

- A collision may occur if a pedestrian, animal, or object suddenly appears while Remote Smart Parking Assist is operating.
- Do not use Remote Smart Parking Assist when under the influence of alcohol.
- Do not let children or other people to use the smart key.
- If Remote Smart Parking Assist is used continuously for a long period, it may adversely affect Remote Smart Parking Assist performance.
- Remote Smart Parking Assist may not operate normally if the vehicle needs wheel alignment adjustment such as when the vehicle tilts to one side. Have the vehicle inspected by an authorized Kia dealer.
- Noise may be heard when braking occurs by Remote Smart Parking Assist or when the brake pedal is depressed by the driver.
- Remote Smart Parking Assist may suddenly apply the brake to avoid collision.
- Use Remote Smart Parking Assist only in a parking space that is large enough for the vehicle to move safely.

*** NOTICE**

- If the 3rd stage warning (continuous beep) of the Forward/Reverse Parking Distance Warning sounds while Remote Smart Parking Assist is operating, it means the obstacle detected is close to your vehicle. At this time, Remote Smart Parking Assist will temporarily stop operating. Make sure there are no pedestrians, animals, or objects around your vehicle.

- Depending on brake operation, the brake lights may come on while the vehicle is moving.
 - If the vehicle is remotely started that has been parked in cold weather for a long time, the operation of Remote Smart Parking function may be delayed or canceled depending on vehicle condition.
-

Declaration of conformity (if equipped)

The radio frequency components (Front Radar) complies:

For United States and United States territories



FCC ID

: 2A30Z-MRR30

This device complies with Part 15 of the FCC Rules. Operation is subject to the following two conditions:

(1) this device may not cause harmful interference, and

(2) this device must accept any interference received, including interference that may cause undesired operation.

CAUTION TO USERS

Changes or modifications not expressly approved by the party responsible for compliance could void the user's authority to operate the equipment.

OSG2EV052204L

For Canada

Model: MRR-30
IC: 27992-MRR30

This device complies with Industry Canada licence-exempt RSS standard(s). Operation is subject to the following two conditions: (1) this device may not cause interference, and (2) this device must accept any interference, including interference that may cause undesired operation of the device.
Le présent appareil est conforme aux CNR d'Industrie Canada applicables aux appareils radio exempts de licence. L'exploitation est autorisée aux deux conditions suivantes: (1) l'appareil ne doit pas produire de brouillage, et (2) l'utilisateur de l'appareil doit accepter tout brouillage radioélectrique subi, même si le brouillage est susceptible d'en compromettre le fonctionnement.

OSG2EV052205L

The radio frequency components (Front Corner Radar/Rear Corner Radar) complies: (if equipped)

For United States and United States territories



OCV051263N

FCC ID

: LTQH5TR

This device complies with Part 15 of the FCC Rules. Operation is subject to the following two conditions:

- (1) this device may not cause harmful interference, and
- (2) this device must accept any interference received, including interference that may cause undesired operation.

CAUTION TO USERS

Changes or modifications not expressly approved by the party responsible for compliance could void the user's authority to operate the equipment.

OCV051264N

For Canada

Model: H5TR

IC: 3659A-H5TR

This device complies with Industry Canada licence-exempt RSS standard(s). Operation is subject to the following two conditions:

- (1) this device may not cause interference, and
- (2) this device must accept any interference, including interference that may cause undesired operation of the device.

Le présent appareil est conforme aux CNR

d'Industrie Canada applicables aux appareils

radio exempts de licence. L'exploitation est autorisée

aux deux conditions suivantes:

- (1) l'appareil ne doit pas produire de brouillage, et
- (2) l'utilisateur de l'appareil doit accepter tout brouillage radioélectrique subi, même si le brouillage est susceptible d'en compromettre le fonctionnement.

OCV051265N

Road warning	8-2
• Hazard warning flasher.....	8-2
In case of an emergency while driving	8-2
• If the vehicle stalls while driving.....	8-2
• If the vehicle stalls at a crossroad or crossing.....	8-2
• If you have a flat tire while driving.....	8-2
If the vehicle will not start	8-3
Emergency starting	8-4
• Jump starting (12V battery).....	8-4
• Push-starting.....	8-5
Tire Pressure Monitoring System (TPMS)	8-6
• Effective Use of the Tire Pressure Monitoring System (TPMS)...	8-6
• Low tire pressure telltale.....	8-7
• Tire replacement with TPMS.....	8-9
If you have a flat tire (with Tire Mobility Kit)	8-10
• Components of the Tire Mobility Kit.....	8-13
• Using the Tire Mobility Kit.....	8-14
• Distributing the sealant.....	8-15
• Checking the tire inflation pressure.....	8-15
• Technical data.....	8-16
Towing	8-17
• Using removable towing hook.....	8-18
If an accident occurs	8-18

What to do in an emergency

Road warning

When an emergency situation occurs while driving or when you park by the edge of the roadway, you must alert approaching or passing vehicles to be careful as they pass. For this, you should use the hazard warning flasher.

Hazard warning flasher

The hazard warning flasher serves as a warning to other drivers to exercise extreme caution when approaching, overtaking, or passing your vehicle.



It should be used whenever emergency repairs are being made or when the vehicle is stopped near the edge of a roadway.

Depress the flasher switch with the EV button in any position. The flasher switch is located in the center facia panel. All turn signal lights will flash simultaneously.

- The hazard warning flasher operates whether your vehicle is running or not.
- The turn signals do not work when the hazard flasher is on.
- Care must be taken when using the hazard warning flasher while the vehicle is being towed.

In case of an emergency while driving

The hazard warning flasher serves as a warning to other drivers to exercise extreme caution when approaching, overtaking, or passing your vehicle.

If the vehicle stalls while driving

1. Reduce your speed gradually, keeping a straight line.
2. Move cautiously off the road to a safe place.
3. Turn on your hazard warning flasher.
4. Try to start the vehicle again. If your vehicle will not start, contact an authorized Kia dealer or seek other qualified assistance.

If the vehicle stalls at a crossroad or crossing

1. If safe to do so, shift to the N (Neutral) position.
2. Push the vehicle to a safe location.

If you have a flat tire while driving

- Take your foot off the accelerator pedal and let the vehicle slow down while driving straight ahead.

WARNING

Do not apply the brakes immediately to slow down the vehicle.

- Use the paddle shifter (left side lever) to increase regenerative braking control.

WARNING

Do not attempt to pull off the road as this may cause loss of vehicle control resulting in an accident.

- When the vehicle has slowed to such a speed that it is safe to do so, brake carefully and pull off the road.
- Drive off the road as far as is possible and safe and park on firm, level ground.

⚠ WARNING

If you are on a divided highway, do not park in the median area between the two traffic lanes.

- When the vehicle is stopped, press the hazard warning flasher button, shift to P (Park), apply the parking brake, and place the EV button in the OFF position.
- Have all passengers get out of the vehicle. Be sure they all get out on the side of the vehicle that is away from traffic.
- Follow the instructions provided later in this chapter.

If the vehicle will not start

The vehicle may not start if the battery level is low.

Check the battery level by performing the following procedure.

1. Be sure the shifter dial is in P (Park).
The vehicle starts only when the shifter dial is in P (Park).
2. Check the 12-volt battery connections to be sure they are clean and tight.

⚠ WARNING

Do not push or pull the vehicle to start it. This could cause damage to your vehicle and/or injure you or those near the vehicle.

Emergency starting

Jump starting (12V battery)

Connect cables in numerical order and disconnect in reverse order.



Jump starting can be dangerous if done incorrectly. Therefore, to avoid harm to yourself or damage to your vehicle or battery, follow these jump starting procedures. If in doubt, we strongly recommend that you have a competent technician or towing service jump start your vehicle.

⚠ WARNING

Battery

Never attempt to check the electrolyte level of the battery as this may cause the battery to rupture or explode.

⚠ WARNING

Frozen Batteries

Do not attempt to jump start the vehicle if the discharged battery is frozen, as the battery may rupture or explode.

⚠ WARNING

Electrolyte

- Do not charge or discharge the battery arbitrarily. It may lead to fault, electric shock or burns.
- Do not damage the battery in such ways as to drop, deform, impact, out or spear with a sharp object. It may cause electrolyte leakage or fire.

- Breakdown of the battery may lead to electrolyte leakage or flammable gas generation. Contact an authorized Kia dealer immediately.
- If electrolyte leaks out, avoid contact with eyes, skin or clothes. In event of accident, flush with water and get medical help immediately.
- Do not place the battery near open flame or incinerate. It may lead to fire or explosion.
- Keep out of reach of children or animals.
- Keep the battery away from moisture or liquid. Do not touch or use if liquids have been spilled on.

⚠ WARNING

Battery Cables

Do not connect the jumper cable from the negative terminal of the booster battery to the negative terminal of the discharged battery, directly. This can cause the discharged battery to overheat, crack, and degrade.

Connect the jumper cable from the negative terminal of the booster battery to the chassis ground in the motor room.

⚠ WARNING

Sulfuric Acid Risk

Automobile batteries contain sulfuric acid. When jump starting your vehicle, be careful not to get sulfuric acid on yourself, your clothing, or on the vehicle. This acid is poisonous and highly corrosive.

⚠ WARNING**Battery**

Keep all flames or sparks away from the battery. The battery produces hydrogen gas which will explode if exposed to flame or sparks.

Jump-starting

1. Make sure the booster battery is 12-volt and that its negative terminal is grounded.
2. If the booster battery is in another vehicle, do not allow the vehicles to come in contact.
3. Turn off all unnecessary electrical loads.
4. Connect the jumper cables in the exact sequence shown in the illustration. First connect one end of a jumper cable to the positive terminal of the discharged battery (1), then connect the other end to the positive terminal of the booster battery (2). Proceed to connect one end of the other jumper cable to the negative terminal of the booster battery (3), then the other end to a solid, stationary, metallic point away from the battery (4).

Do not allow the jumper cables to contact anything except the correct battery terminals or the correct ground. Do not lean over the battery when making connections.

5. Start vehicle with the booster battery and let it run, then start the vehicle with the discharged battery.

If the cause of your battery discharging is not apparent, you should have your vehicle checked by an authorized Kia dealer.

*** NOTICE**

Make sure to connect one end of the jumper cable to the negative terminal of the booster battery, and the other end to a metallic point, far away from the battery.

Push-starting

Your vehicle equipped with reduction gear should not be push-started.

⚠ WARNING**Tow Starting Vehicle**

Never tow a vehicle to start it.

When the vehicle starts, the vehicle can suddenly surge forward and could cause a collision with the tow vehicle.

Tire Pressure Monitoring System (TPMS)

The tire pressure monitoring system detects the pressure of vehicle's tires and displays it on the LCD display.



- 1 Low tire pressure telltale / TPMS malfunction indicator
- 2 Low tire pressure position telltale (Shown on the LCD display)

Tire Pressure Indicator

- You can check the tire pressure in the assist mode on the cluster.
 - Refer to "LCD display modes" on page 5-65.
- Tire pressure is displayed 1~2 minutes later after driving.
- If tire pressure is not displayed when the vehicle is stopped, **Drive to display** message displays. After driving, check the tire pressure.
- You can change the tire pressure unit in the Setup menu on the infotainment system screen.
 - psi, kPa, bar (Refer to "Vehicle settings (infotainment system)" on page 5-69).

* NOTICE

- The tire pressure may change due to factors such as parking condition, driving style, and altitude above sea level.
- Low tire pressure warning may sound when a tire's pressure unit is equal or higher than nearby tires. This is a normal occurrence, which is due to the change in tire pressure along with tire temperature.
- The tire pressure shown on the dashboard may differ from the tire pressure measured by tire pressure gauge.

Effective Use of the Tire Pressure Monitoring System (TPMS)

Each tire, including the spare (if provided), should be checked monthly when cold and inflated to the inflation pressure recommended by the vehicle manufacturer on the vehicle placard or tire inflation pressure label.

(If your vehicle has tires of a different size than the size indicated on the vehicle placard or tire inflation pressure label, you should determine the proper tire inflation pressure for those tires.)

As an added safety feature, your vehicle has been equipped with a tire pressure monitoring system (TPMS) that illuminates a low tire pressure telltale when one or more of your tires is significantly under-inflated. Accordingly, when the low tire pressure telltale illuminates, you should stop and check your tires as soon as possible, and inflate them to the proper pressure. Driving on a significantly under-inflated tire causes the tire to overheat and can lead to tire failure. Under-inflation also reduces fuel efficiency and tire tread life, and may affect

the vehicle's handling and stopping ability.

Please note that the TPMS is not a substitute for proper tire maintenance, and it is the driver's responsibility to maintain correct tire pressure, even if under-inflation has not reached the level to trigger illumination of the TPMS low tire pressure telltale.

Your vehicle has also been equipped with a TPMS malfunction indicator to indicate when the system is not operating properly. The TPMS malfunction indicator is combined with the low tire pressure telltale. When the system detects a malfunction, the telltale will flash for approximately one minute and then remain continuously illuminated.

This sequence will continue upon subsequent vehicle start-ups as long as the malfunction exists. When the malfunction indicator is illuminated, the system may not be able to detect or signal low tire pressure as intended. TPMS malfunctions may occur for a variety of reasons, including the installation of replacement or alternate tires or wheels on the vehicle that prevent the TPMS from functioning properly. Always check the TPMS malfunction telltale after replacing one or more tires or wheels on your vehicle to ensure that the replacement or alternate tires and wheels allow the TPMS to continue to function properly.

Always check the TPMS malfunction telltale after replacing one or more tires or wheels on your vehicle to ensure that the replacement or alternate tires and wheels allow the TPMS to continue to function properly.

*** NOTICE**

If any of the below happens, have the system checked by an authorized Kia dealer.

1. The Low Tire Pressure TPMS Malfunction Indicator does not appear for 3 seconds when the EV button is placed to the ON position or vehicle is ON (**READY** indicator ON).
2. The TPMS Malfunction Indicator remains illuminated after blinking for approximately 1 minute.
3. The Low Tire Pressure LCD display remains illuminated.

Low tire pressure telltale 

Low tire pressure position telltale

When the tire pressure monitoring system warning indicators appear, one or more of your tires is significantly under-inflated.



A: Low tire pressure

If the telltale appears, immediately reduce your speed, avoid hard cornering and anticipate increased stopping distances. You should stop and check your tires as soon as possible.

Inflate the tires to the proper pressure as indicated on the vehicle's placard or tire inflation pressure label located on the driver's side center pillar outer panel. If you cannot reach a service station or if the tire cannot hold the newly added air,

replace the low pressure tire with the spare tire.

Then the TPMS malfunction indicator and the Low Tire Pressure telltale may turn on and appear after restarting and about 20 minutes of continuous driving before you have the low pressure tire repaired and replaced on the vehicle.

In winter or cold weather, the low tire pressure telltale may be illuminated if the tire pressure was adjusted to the recommended tire inflation pressure in warm weather. It does not mean your TPMS is malfunctioning because the decreased temperature leads to a proportional lowering of tire pressure.

When you drive your vehicle from a warm area to a cold area or from a cold area to a warm area, or the outside temperature is greatly higher or lower, you should check the tire inflation pressure and adjust the tires to the recommended tire inflation pressure.

When filling tires with more air, conditions to turn off the low tire pressure telltale may not be met. This is because a tire inflator has a margin of error in performance. The low tire pressure telltale will be turned off if the tire pressure is above the recommended tire inflation pressure.

⚠ WARNING

Low Pressure Damage

Do not drive on low pressure tires. Significantly low tire pressure can cause the tires to overheat and fail making the vehicle unstable resulting in increased braking distances and a loss of vehicle control.

Tire Pressure Monitoring System (TPMS) malfunction indicator 

The low tire pressure telltale will appear after it blinks for approximately one minute when there is a problem with the Tire Pressure Monitoring System.

If the system is able to correctly detect an underinflation warning at the same time as system failure then it will illuminate both the TPMS malfunction and low tire pressure position telltales e.g. if Front Left sensor fails, the TPMS malfunction indicator appears, but if the Front Right, Rear Left, or Rear Right tire is under-inflated, the low tire pressure position telltales may appear together with the TPMS malfunction indicator.

Have the system checked by an authorized Kia dealer as soon as possible to determine the cause of the problem.

- The TPMS malfunction indicator may appear if the vehicle is moving around electric power supply cables or radios transmitters such as at police stations, government and public offices, broadcasting stations, military installations, airports, or transmitting towers, etc. This can interfere with normal operation of the Tire Pressure Monitoring System (TPMS).
- The TPMS malfunction indicator may appear if snow chains are used or some separate electronic devices such as notebook computer, mobile charger, remote starter or navigation etc., are used in the vehicle. This can interfere with normal operation of the Tire Pressure Monitoring System (TPMS).

Tire replacement with TPMS

If you have a flat tire, the Low Tire Pressure telltale will come on. Have the flat tire repaired by an authorized Kia dealer as soon as possible or replace the flat tire with the spare tire.

CAUTION

Repair Agents

Never use a puncture-repairing agent not approved by Kia to repair and/or inflate a low pressure tire. The sealant not approved by Kia may damage the tire pressure sensor.

Each wheel is equipped with a tire pressure sensor mounted inside the tire behind the valve stem. You must use TPMS specific wheels. It is recommended that you always have your tires serviced by an authorized Kia dealer.

Even if you replace the low pressure tire with the spare tire, the Low Tire Pressure telltale will remain on until the low pressure tire is repaired and placed on the vehicle.

After you replace the low pressure tire with the spare tire, the TPMS malfunction indicator may appear after a few minutes because the TPMS sensor mounted on the spare wheel is not initiated.

Once the low pressure tire is inflated again to the recommended pressure and installed on the vehicle or the TPMS sensor mounted on the replaced spare wheel is initiated by an authorized Kia dealer, the TPMS malfunction indicator and the low tire pressure telltale will turn off within a few minutes of driving.

If the indicator has not disappeared after a few minutes of driving, please visit an authorized Kia dealer.

If an original mounted tire is replaced with the spare tire, the TPMS sensor on the replaced spare wheel should be initiated and the TPMS sensor on the original mounted wheel should be deactivated. If the TPMS sensor on the original mounted wheel located in the spare tire carrier still activates, the tire pressure monitoring system may not operate properly. Have the tire with TPMS serviced or replaced by an authorized Kia dealer.

You may not be able to identify a low tire by simply looking at it. Always use a good quality tire pressure gauge to measure the tire's inflation pressure. Please note that a tire that is hot (from being driven) will have a higher pressure measurement than a tire that is cold (from sitting stationary for at least 3 hours and driven less than 1.6 km (1 mile) during that 3 hour period).

Allow the tire to cool before measuring the inflation pressure. Always be sure the tire is cold before inflating to the recommended pressure.

A cold tire means the vehicle has been sitting for 3 hours and driven for less than 1.6 km (1 mile) in that 3 hour period.

Never use tire sealant if your vehicle is equipped with a Tire Pressure Monitoring System. The liquid sealant can damage the tire pressure sensors.

- The TPMS cannot alert you to severe and sudden tire damage caused by external factors such as nails or road debris.
- If you feel any vehicle instability, immediately take your foot off the accelerator, apply the brakes gradually and with light force, and slowly move to a safe position off the road.

*** NOTICE**

Protecting TPMS

Tampering with, modifying, or disabling the Tire Pressure Monitoring System (TPMS) components may interfere with the system's ability to warn the driver of low tire pressure conditions and/or TPMS malfunctions. Tampering with, modifying, or disabling the Tire Pressure Monitoring System (TPMS) components may void the warranty for that portion of the vehicle.

This device complies with Industry Canada licence-exempt RSS standard(s).

Operation is subject to the following conditions:

1. This device may not cause interference, and
2. This device must accept any interference, including interference that may cause undesired operation of the device.
3. Changes or modifications not expressly approved by the party responsible for compliance could void the user's authority to operate the device.

If you have a flat tire (with Tire Mobility Kit)

The Tire Mobility Kit is a temporary fix to the tire and the tire should be inspected by an authorized Kia dealer as soon as possible.



- 1 Compressor
- 2 Sealant bottle

For safe operation, carefully read and follow the instructions in this manual before use.

*** NOTICE**

When two or more tires are flat, do not use the tire mobility kit because the one supplied canister of sealant in the Tire Mobility Kit is only enough sealant for one flat tire.

⚠ WARNING

Tire Wall

Do not use the Tire Mobility Kit to repair large punctures or damage to the tire sidewalls. In these situations, the tire cannot be sealed completely and air will leak from the tire. This can result in tire failure.

⚠ WARNING

Have your tire repaired as soon as possible. The tire may lose air pressure at any time after inflating with the Tire Mobility Kit.

⚠ WARNING**Speed with Temporary Fix**

Do not exceed a speed of 80 km/h (50 mph) when driving with a tire sealed with the Tire Mobility Kit.

While driving, if you experience any unusual vibration, ride disturbance, or noise, reduce your speed and drive with caution until you can safely pull off to the side of the road.

Introduction

With the Tire Mobility Kit you stay mobile even after experiencing a tire puncture. The system of compressor and sealing compound effectively seals most punctures in a passenger car tire caused by nails or similar objects and reinflates the tire.

After you ensure that the tire is properly sealed you can drive cautiously on the tire at a max. speed of 80 km/h (50 mph) in order to reach a service station or tire dealer to have the tire replaced as soon as possible.

It is possible that some tires, especially with larger punctures or damage to the sidewall, cannot be sealed completely.

Air pressure loss in the tire may adversely affect tire performance.

For this reason, you should avoid abrupt steering or other driving maneuvers, especially if the vehicle is heavily loaded or if a trailer is in use.

The Tire Mobility Kit is not designed or intended as a permanent tire repair method and is to be used for one tire only.

This instruction shows you the step by step procedure to temporarily seal the puncture.

Read the section "Notes on the safe use of the Tire Mobility Kit".

Notes on the safe use of the Tire Mobility Kit

- Park your car at the side of the road so that you can work with the Tire Mobility Kit away from moving traffic.
- To be sure your vehicle will not move, even when you're on fairly level ground, always set your parking brake.
- Only use inflating Tire Mobility Kit for sealing/inflation passenger car tires. Only punctured areas located within the tread region of the tire can be sealed using the Tire Mobility Kit.
- Do not use on motorcycles, bicycles or any other type of tires.
- When the tire and wheel are damaged, do not use Tire Mobility Kit for your safety.
- Use of the Tire Mobility Kit may not be effective for tire damage larger than approximately 4 mm (0.16 inches). Please contact the nearest Kia dealership if the tire cannot be made road-worthy with the Tire Mobility Kit.
- Do not use the Tire Mobility Kit if a tire is severely damaged by driving with flat tires or with insufficient air pressure.
- Do not remove any foreign objects such as nails or screws that have penetrated the tire.
- Provided the car is outdoors, leave the vehicle ON (**READY** indicator ON). Otherwise operating the compressor may eventually drain the car battery.
- Never leave the Tire Mobility Kit unattended while it is being used.

What to do in an emergency

- Do not leave the compressor running for more than 10 minutes at a time or it may overheat.
- Do not use the Tire Mobility Kit if the ambient temperature is below -30 °C (-22 °F).

* NOTICE

When repairing a flat tire with the Tire Mobility Kit (TMK), quickly remove the sealant on the tire pressure sensor and wheel. When installing the repaired tire and wheel, tighten the wheel nut to a torque value of 11-13 kgf·m (79-94 lbf·ft).

⚠ WARNING

Sealant

- Keep out of the reach of children.
- Avoid contact with eyes.
- Do not swallow.

⚠ WARNING

Do not use the tire sealant after the sealant has expired (i.e. past the expiration date on the sealant container). This can increase the risk of tire failure.

⚠ WARNING

- If the sealant gets on your skin, wash it with a large amount of water. If skin irritation continues, visit a doctor for examination.
- If the sealant gets into your eyes, raise your eyelid and wash for at least 15 minutes. If eye irritation continues, visit a doctor for examination.
- If you swallowed the sealant, wash the mouth and drink a large amount of water. However, do not give anything

If you have a flat tire (with Tire Mobility Kit)

to an unconscious person and see the doctor immediately.

Exposure to the sealant for a long time may cause damage to the bodily tissues.

* NOTICE



For 20 inch wheel, take out the remover tool in the Tire Mobility Kit. Insert the tool to the hole and pull out the wheel cover.

Components of the Tire Mobility Kit

Connectors, cable and connection hose are stored in the compressor housing.

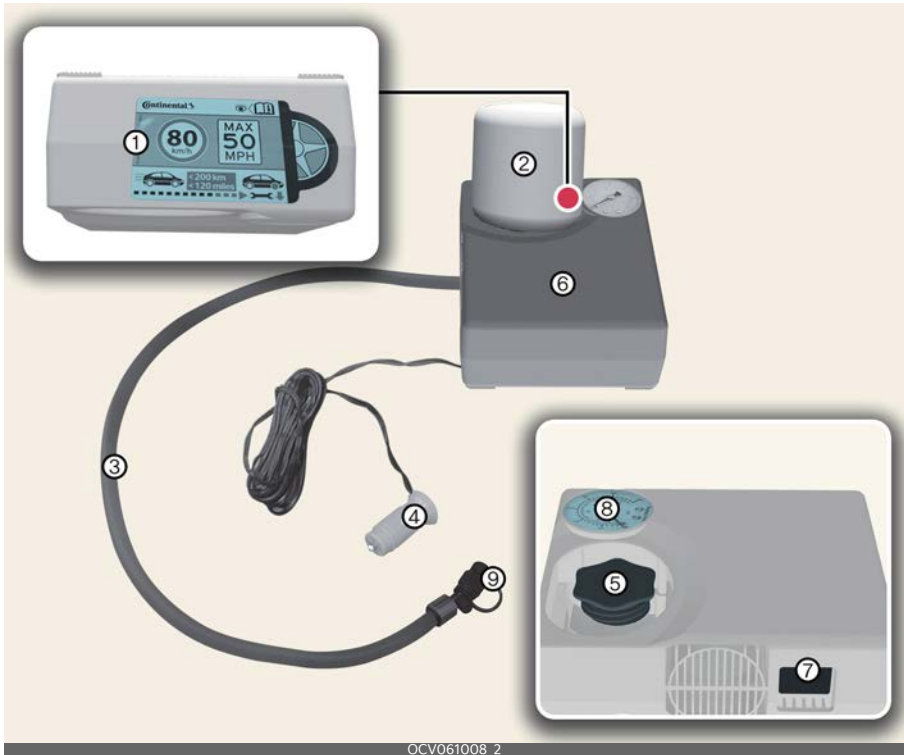

- 1 Speed restriction label
- 2 Sealant bottle
- 3 Filling hose from sealant bottle to wheel
- 4 Connectors and cable for the power outlet direct connection
- 5 Holder for the sealant bottle
- 6 Compressor
- 7 ON/OFF switch
- 8 Pressure gauge for displaying the tire inflation pressure
- 9 Valve for reducing tire inflation pressure

⚠ WARNING

Before using the Tire Mobility Kit, follow the instructions on the sealant bottle. Remove the label with the speed restriction from the sealant bottle and apply it to the steering wheel. Please note the expiration date on the sealant bottle.

*** NOTICE**

The sealant bottle and insert hose (3) cannot be reused.

*** NOTICE**

Before using the tire repair kit, please read carefully the instruction attached on the sealant bottle. Detach the speed limit label on the sealant case and put it on a highly visible place. Always drive within the speed limit.



OCV061030N

Using the Tire Mobility Kit

Carefully follow below steps.

1. Shake the sealant bottle.



OCV061010L

2. Remove the sealant bottle cap and sealant bottle holder cap and screw the bottle onto the sealant bottle holder.



OCV061011L

3. Unscrew the valve cap from the valve of the defective wheel and screw filling hose of the sealant bottle onto the valve.



OCV061015N

*** NOTICE**

If a visible foreign object has punctured the tire, do not remove it before using Tire Mobility Kit.

*** NOTICE**

If the sealant is injected when the tire air pressure injection valve and sealant injection hose are not fully interlocked, the sealant may overflow and clog the valve.

4. Make sure the compressor valve on the filling hose is locked.



OCV061014N

5. Ensure that the compressor is switched off, position 0.
6. Connect between compressor and the vehicle power outlet using the cable and connectors.



7. With the EV button ON, switch on the compressor and let it run for approximately 5~7 minutes to fill the sealant up to cold tire recommended pressure. (refer to "Tires and wheels" on page 10-4). Be careful not to overinflate the tire and stay away from the tire when filling it.

⚠ WARNING

Tire Pressure

Do not attempt to drive your vehicle if the tire pressure is below 180 kPa (26 psi). This could result in an accident due to sudden tire failure.

8. Switch off the compressor.
9. Detach the hoses from the sealant bottle connector and from the tire valve.
10. Return the Tire Mobility Kit to its storage location in the vehicle.

Distributing the sealant

After putting sealant into the tire, it is necessary to drive the vehicle so that the sealant becomes evenly distributed inside the tire.



- Immediately drive approximately 7~10 km (4~6 miles or, about 10 minutes) to evenly distribute the sealant in the tire.

Do not exceed a speed of 80 km/h (50 mph). If possible, do not fall below a speed of 20 km/h (12 mph).

While driving, if you experience any unusual vibration, ride disturbance or noise, reduce your speed and drive with caution until you can safely pull off of the side of the road.

*** NOTICE**

When you use the Tire Mobility Kit, the tire pressure sensors and wheel may be stained by sealant. Therefore, remove the tire pressure sensors and wheel stained by the sealant and have your vehicle inspected by an authorized Kia dealer.

Checking the tire inflation pressure

After driving briefly so as to distribute the sealant throughout the inside of the tire, you should check the tire inflation pressure.

1. After driving approximately 7~10 km (4~6 miles or about 10 minutes), stop at a safe location.

2. Connect the filling hose of the compressor (clip mounted side) directly and then connect the filling hose (opposite side) to the tire valve.



3. Connect between compressor and the vehicle power outlet using the cable and connectors.
4. Adjust the tire inflation pressure to the cold tire recommended pressure as indicated on the vehicle's placard or tire inflation pressure label located on the driver's side center pillar outer panel. (In this owner's manual, refer to "Tires and wheels" on page 10-4.)

- **To increase the inflation pressure**, switch on the compressor, position I. To check the current inflation pressure setting, briefly switch off the compressor.

*** NOTICE**

The pressure gauge may show higher than actual reading when the compressor is running. To get an accurate tire reading, the compressor needs to be turned off.

⚠ CAUTION

Do not let the compressor run for more than 10 minutes; otherwise, the device may overheat and be damaged.

- **To reduce the inflation pressure**, press the valve on the compressor.

⚠ CAUTION

Tire Pressure Sensor

When you use the Tire Mobility Kit with a sealant that is not approved by Kia, the tire pressure sensors may be damaged by sealant. The sealant on the tire pressure sensor and wheel should be removed when you replace the tire with a new one and the tire pressure sensors should be inspected at an authorized dealer.

Technical data

The specifications of the Tire Mobility Kit are as follows.

System Voltage		DC 12 V
Working Voltage		DC 12 V
Amperage rating		max. 15 A
Suitable for use at temperatures		-30 to 70 °C -22 to 158 °F
Max. working pressure		7 bar (101 psi)
Size	Compressor	150 x 130 x 60 mm (5.9 x 5.1 x 2.4 inches)
	Sealant bottle	115.3 x 87.3 ø mm (4.5 x 3.4 ø inches)
	Compressor weight	620 g (1.36 lbs.)
	Sealant volume	400 ml (24.4 cu. in.)

* Sealant and spare parts can be obtained and replaced at an authorized vehicle or tire dealer. Empty sealant bottles may be disposed of at home. Liquid residue from the sealant should be disposed of by your vehicle or tire dealer or in accordance with local waste disposal regulations.

Towing

If emergency towing is necessary, we recommend having it done by an authorized Kia dealer or a commercial tow-truck service.

Towing service

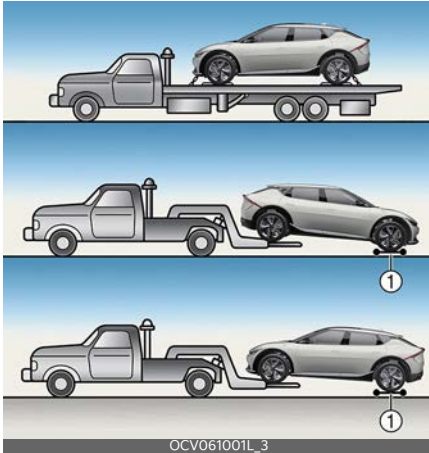

Proper lifting and towing procedures are necessary to prevent damage to the vehicle. The use of wheel dollies (1) or flatbed is recommended.

⚠ WARNING

Side and Curtain Air Bag

If your vehicle is equipped with side and curtain air bags, place the EV button in OFF or ACC when the vehicle is being towed.

The side and curtain air bag may deploy when the EV button is ON, and the rollover sensor detects the situation as a rollover.

⚠ CAUTION

Towing (For 2WD Vehicle)



- Do not tow the vehicle forward with the rear wheels on the ground as this may cause damage to the vehicle.
- Do not tow with sling-type equipment. Use wheel lift or flatbed equipment.

⚠ WARNING

- If you tow the vehicle while the rear (or front and rear for AWD vehicle) wheels are touching the ground, the vehicle motor may generate electricity and the motor components may be damaged or a fire may occur.
- When a vehicle fire occurs due to the battery, there is a risk of a second fire. Contact the fire department when towing the vehicle.

When the vehicle is being towed with tow truck or it needs to be moved, move the vehicle very short distance (within 10 m (32 ft.)) with the speed of 5 km/h (3 mph). In this case, the vehicle should be in N (Neutral) and the parking brake should be disengaged. If the parking brake and gear change operation is unavailable, move the vehicle with the rear wheels off the ground.

Using removable towing hook



Front



Rear



1. Open the liftgate, and remove the towing hook from the tool case.
2. Remove the hole cover pressing the lower part (front/rear) of the cover on the bumper.
3. Install the towing hook by turning it clockwise into the hole until it is fully secured.
4. Remove the towing hook and install the cover after use.

If an accident occurs

If an accident occurs, stay calm and take the following precautions.

⚠ WARNING

High Voltage Components

- For your safety, do not touch high voltage cables, connectors and package modules. High voltage components are orange in color.
- Exposed cables or wires may be visible inside or outside of the vehicle. Never touch the wires or cables, because an electrical shock, an injury, or a death may occur.

*** NOTICE**

Any gas or electrolyte leakage from your vehicle is not only poisonous but also flammable. Upon witnessing one of those, make sure your car is parked in a safe area away from any roads, open the windows, and maintain a safe distance away from the vehicle. Immediately contact an authorized Kia dealer and advise them that an electric vehicle is involved.

- If you need towing, refer to "Towing" on page 8-17.
- When the vehicle is severely damaged, remain a safe distance of 15 m (50 ft.) or more between your vehicle and other vehicles/flammables.
- If a fire occurs, immediately call emergency services (911) and advise the emergency responders that an electric vehicle is involved.

 **WARNING**

Submersion in Water

Do not touch your vehicle if it has been submerged in water. The high-voltage battery may cause shock or may catch fire. Immediately contact the authorities and advise them of the condition of your vehicle and that an electric vehicle is involved.

Motor room compartment	9-3
Maintenance services	9-4
Owner maintenance	9-5
Scheduled maintenance service	9-7
Explanation of scheduled maintenance items	9-10
Coolant	9-11
Brake fluid	9-12
• Checking the brake fluid level.....	9-12
Washer fluid	9-13
• Checking the washer fluid level.....	9-13
Climate control air filter	9-14
• Inspecting and replacing climate control air filter.....	9-14
Wiper blades	9-15
• Replacing front windshield wiper blade.....	9-15
12V battery	9-16
Tires and wheels	9-18
• Checking tire inflation pressure.....	9-19
• Tire rotation.....	9-20
• Wheel alignment and tire balance.....	9-20
• Tire replacement.....	9-20
• Wheel replacement.....	9-21
• Tire traction.....	9-21
• Tire maintenance.....	9-21
• Tire sidewall labeling.....	9-21
• Tire terminology and definitions.....	9-24
• All season tires.....	9-26
• Summer tires.....	9-26
• Snow tires.....	9-26
• Radial-ply tires.....	9-26
• Low aspect ratio tire.....	9-27

9 Maintenance

Fuses	9-28
• Replacing inner panel fuse.....	9-29
• Replacing motor compartment fuse	9-30
• Fuse/relay panel description	9-31
Light bulbs	9-38
• Light position (Front).....	9-39
• Light position (Rear)	9-39
• Replacing lights (LED type, except glove box lamp).....	9-40
• Side repeater lamp replacement	9-40
• Replacing high mounted stop lamp (LED type)	9-40
• Glove box lamp (Bulb type) replacement	9-41
Appearance care	9-41
• Exterior care	9-41
• Interior care	9-46

Maintenance

Motor room compartment

Open the hood to see the motor room compartment.

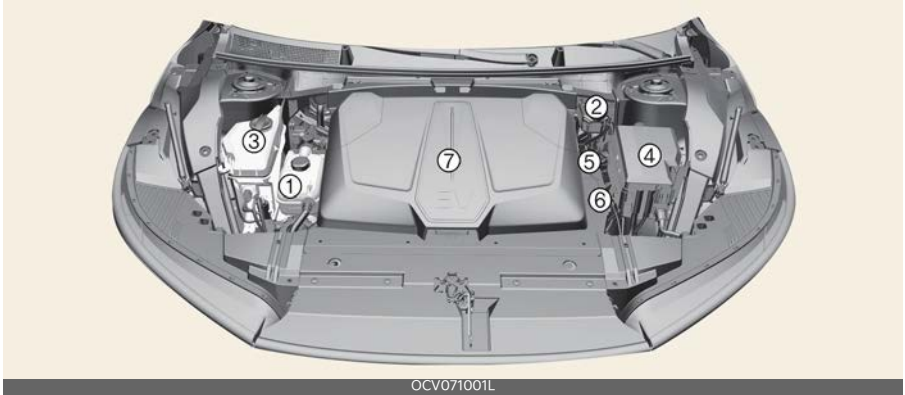

* The actual motor compartment in the vehicle may differ from the illustration.

- 1 Coolant reservoir
- 2 Brake fluid reservoir
- 3 Windshield washer fluid reservoir
- 4 Fuse box
- 5 Negative battery terminal (-)
- 6 Positive battery terminal (+)
- 7 Front trunk

Maintenance services

You should exercise the utmost care to prevent damage to your vehicle and injury to yourself whenever performing any maintenance or inspection procedures.

Should you have any doubts concerning the inspection or servicing of your vehicle, have an authorized Kia dealer perform this work.

An authorized Kia dealer has factory-trained technicians and genuine Kia parts to service your vehicle properly. For expert advice and quality service, see an authorized Kia dealer.

Inadequate, incomplete or insufficient servicing may result in operational problems with your vehicle that could lead to vehicle damage, an accident, or personal injury.

Owner's responsibility

* NOTICE

Maintenance Service and Record Retention are the owner's responsibility.

You should retain documents that show proper maintenance has been performed on your vehicle in accordance with the scheduled maintenance service charts shown on the following pages. You need this information to establish your compliance with the servicing and maintenance requirements of your vehicle warranties.

Detailed warranty information is provided in your Warranty & Consumer Information manual.

Repairs and adjustments required as a result of improper maintenance or a lack of required maintenance are not covered.

Have your vehicle maintained and repaired by an authorized Kia dealer. An authorized Kia dealer meets Kia's high service quality standards and receives technical support from Kia in order to provide you with a high level of service satisfaction.

Owner maintenance precautions

Improper or incomplete service may result in problems. This section gives instructions only for the maintenance items that are easy to perform.

As explained earlier in this section, several procedures can be done only by an authorized Kia dealer with special tools.

* NOTICE

Improper owner maintenance during the warranty period may affect warranty coverage. For details, read the separate Warranty & Consumer Information manual provided with the vehicle. If you're unsure about any servicing or maintenance procedure, have it done by an authorized Kia dealer.

⚠ WARNING

Maintenance Work

Do not wear jewelry or loose clothing while working under the hood of your vehicle with **READY** mode. These items can become entangled in moving parts, if you must run the vehicle in the **READY** mode while working under the hood, make certain that you remove all jewelry (especially rings, bracelets, watches, and necklaces) and all neckties, scarves, and similar loose clothing before getting near cooling fans.

⚠ WARNING**Touching Metal Parts**

Do not touch metal parts (including strut bars) while the vehicle is operating or hot. Doing so could result in serious bodily injury. Turn the vehicle off and wait until the metal parts cool down to perform maintenance work on the vehicle.

Owner maintenance

The following lists are vehicle checks and inspections that should be performed by the owner or an authorized Kia dealer at the frequencies indicated to help ensure safe, dependable operation of your vehicle.

Any adverse conditions should be brought to the attention of your dealer as soon as possible.

These Owner Maintenance Checks are generally not covered by warranties and you may be charged for labor, parts and lubricants used.

When you stop for charge

- Check the coolant level in coolant reservoir.
- Check the windshield washer fluid level.

⚠ WARNING

Be careful when checking your coolant level when the motor compartment is hot. This may result in coolant being blown out of the opening and cause serious burns and other injuries.

While operating your vehicle:

- Check for vibrations in the steering wheel. Notice any increased steering effort or looseness in the steering wheel, or change in its straight-ahead position.
- Notice if your vehicle constantly turns slightly or "pulls" to one side when traveling on smooth, level road.
- When stopping, listen and check for unusual sounds, pulling to one side, increased brake pedal travel or "hard-to-push" brake pedal.

- If any slipping or changes in the operation of your gear shift occurs, take your vehicle to an authorized Kia dealer.
- Check the reduction gear P (Park) function.
- Check for fluid leaks under your vehicle (water dripping from the air conditioning system during or after use is normal).
- Check the air conditioning system.
- Inspect and lubricate reduction gear linkage and controls.
- Clean the 12V battery and terminals.
- Check the brake fluid level.

At least monthly:

- Check the coolant level in the coolant reservoir.
- Check the operation of all exterior lights, including the stop/tail lamps, turn signals and hazard warning flashers.
- Check the inflation pressures of all tires including the spare for tires that are worn, show uneven wear, or are damaged.
- Check for loose wheel lug nuts.

At least once every 6 months:

- Check the windshield washer spray and wiper operation. Clean the wiper blades with clean cloth dampened with washer fluid.
- Check the head lamp alignment.
- Check the lap/shoulder belts for wear and function.

At least once a year:

- Clean the body and door drain holes.
- Lubricate the door hinges and check the hood hinges.
- Lubricate the door and hood locks and latches.
- Lubricate the door rubber weatherstrips.

Scheduled maintenance service

Follow the Normal Maintenance Schedule if the vehicle is usually operated where none of the following conditions apply.

If any of the following conditions apply, follow the Maintenance Under Severe Usage Conditions.

- Repeated driving short distance of less than 8 km/h (5 mph) in normal temperature or less than 16 km/h (10 mph) in freezing temperature
- Driving on rough, dusty, muddy, unpaved, graveled or salt-spread roads
- Driving in areas using salt or other corrosive materials or in very cold weather
- Driving in heavy dust condition
- Driving in heavy traffic area with the ambient temperature higher than 32 °C (90 °F) while consuming more than 50% of electric energy
- Driving on uphill, downhill, or mountain road repeatedly
- Towing a trailer, or using a camper or roof rack
- Driving as a patrol car, taxi, other commercial use of vehicle towing
- Frequently driving under high speed or rapid acceleration/deceleration
- Frequently driving in stop-and-go condition

If your vehicle is operated in any of the prior listed conditions, you should inspect, replace or refill more frequently, using the severe usage maintenance schedule instead of the normal usage maintenance schedule.

Normal maintenance schedule

I: Inspect and if necessary, adjust, correct, clean or replace.

R: Replace or change.

Number of months or driving distance, whichever comes first													
Months	12	24	36	48	60	72	84	96	108	120	132	144	
Miles×1,000	8	16	24	32	40	48	56	64	72	80	88	96	
Km×1,000	13	26	39	52	65	78	91	104	117	130	143	156	
Tire rotation	Rotate every 13,000 km (8,000 miles)												
Reduction gear fluid*	-	-	-	I	-	-	-	I	-	-	-	I	
Climate control air filter	I	R	I	R	I	R	I	R	I	R	I	R	
Brake fluid	Inspect every 13,000 km (8,000 miles) or 12 months Replace every 78,000 km (48,000 miles) or 48 months												
Coolant*	At first, replace at 195,000 km (120,000 miles) or 120 months After that, replace every 39,000 km (24,000 miles) or 24 months												
Air conditioner refrigerant													
Air conditioner compressor													
12V Battery condition													
Brake discs and pads													
Brake lines, hoses and connections	I	I	I	I	I	I	I	I	I	I	I	I	
Suspension ball joints													
Steering gear rack, linkage and boots													
Cooling system													
Drive shaft and boots	-	I	-	I	-	I	-	I	-	I	-	I	

* Coolant

When replacing or adding coolant, we recommend that you visit an authorized Kia dealer.

For your convenience, it can be replaced prior to its interval when you do maintenance of other items.

* Reduction gear fluid

Reduction gear fluid should be changed anytime it has been submerged in water.

Maintenance under severe usage conditions

I: Inspect and if necessary, adjust, correct, clean or replace.

R: Replace or change.

Maintenance item	Maintenance operation	Maintenance intervals	Driving condition
Reduction gear fluid	R	Every 117,000 km (72,000 miles)	A, B, E, F, H, J
Drive shaft and boots	I	More frequently	B, C, D, E, F, G, H, I
Climate control air filter	R	More frequently	B, D, F
Brake discs, pads and calipers	I	More frequently	B, C, D, F, G, H, I, J
Steering gear rack, linkage and boots	I	More frequently	C, D, E, F, G
Suspension ball joints	I	More frequently	B, C, D, E, F

Severe driving conditions

- A. Repeated driving short distance of less than 8 km/h (5 mph) in normal temperature or less than 16 km (10 miles) in freezing temperature
- B. Driving on rough, dusty, muddy, unpaved, graveled or salt spread roads
- C. Driving in areas using salt or other corrosive materials or in very cold weather
- D. Driving in heavy dust condition
- E. Driving in heavy traffic area with the ambient temperature higher than 32 °C (90 °F) while consuming more than 50% of electric energy.
- F. Driving on uphill, downhill, or mountain roads repeatedly
- G. Towing a trailer, or using a camper or roof rack
- H. Driving as a patrol car, taxi, other commercial use or vehicle towing
- I. Frequently driving under high speed or rapid acceleration/deceleration
- J. Frequently driving in stop-and-go conditions

Explanation of scheduled maintenance items

The following parts require scheduled maintenance.

Reduction gear fluid

The reduction gear fluid should be inspected according to the intervals specified in the maintenance schedule.

Cooling system

Check the cooling system components, such as the radiator, coolant reservoir, hoses and connections, coolant 3-way valve, chiller for leakage and damage. Replace any damaged parts.

Coolant

The coolant should be changed at the intervals specified in the maintenance schedule.

Brake hoses and lines

Visually check for proper installation, chafing, cracks, deterioration and any leakage. Replace any deteriorated or damaged parts immediately.

Brake fluid

Check the brake fluid level in the brake fluid reservoir. The level should be between "MIN" and "MAX" marks on the side of the reservoir. Use only hydraulic brake fluid conforming to DOT 4 specification.

Brake discs, pads and calipers

Check the pads for excessive wear, discs for run out and wear, and calipers for fluid leakage.

Suspension mounting bolts

Check the suspension connections for looseness or damage. Retighten to the specified torque.

Steering gear box, linkage & boots/lower arm ball joint

With the vehicle stopped and off, check for excessive free-play in the steering wheel.

Check the linkage for bends or damage. Check the dust boots and ball joints for deterioration, cracks, or damage. Replace any damaged parts.

Drive shafts and boots

Check the drive shafts, boots and clamps for cracks, deterioration, or damage. Replace any damaged parts and, if necessary, repack the grease.

Air conditioning refrigerant

Check the air conditioning lines and connections for leakage and damage.

Coolant

The high-pressure cooling system has a reservoir filled with year round anti-freeze coolant. The reservoir is filled at the factory.

Check the antifreeze protection and coolant level at least once a year, at the beginning of the winter season, and before traveling to a colder climate.

⚠ WARNING



The electric motor (cooling fan) is controlled by coolant temperature, refrigerant pressure and vehicle speed. It may some-

times operate even when the vehicle is not operating. Use extreme caution when working near the blades of the cooling fan so that you are not injured by a rotating fan blades. As the coolant temperature decreases, the electric motor will automatically shut off. This is a normal condition.

Check the condition and connections of all cooling system hoses.



Replace any swollen or deteriorated hoses. The coolant level should be filled between F (MAX) and L (MIN) marks on the side of the coolant reservoir when motor compartment is cool. When the coolant level (in the reservoir) is low, have your vehicle inspected by an authorized Kia dealer. Use only designated coolant water for electric vehicles,

adding other types of water or anti-freeze can damage the vehicle.

⚠ WARNING

Be careful when checking your coolant level when the motor compartment is hot. This may result in coolant being blown out of the opening and cause serious burns and other injuries.

Brake fluid

The brake fluid acts to transmit force to the brake when the driver depresses the brake pedal. Brake fluid must be maintained periodically to ensure that the brakes operate smoothly.

Checking the brake fluid level

Check the fluid level in the reservoir periodically. The fluid level should be between MAX and MIN marks on the side of the reservoir.



1. Before removing the reservoir cap and adding brake fluid, clean the area around the reservoir cap thoroughly to prevent brake fluid contamination.

⚠ CAUTION

Proper fluid

Only use brake fluid in the brake system. Small amounts of improper fluids can cause damage to the brake system.

2. Periodically check that the fluid level in the brake fluid reservoir is between MIN and MAX. The level will fall with accumulated mileage. This is a normal condition associated with the wear of the brake linings. If the fluid level is excessively low, have the brake system checked by an authorized Kia dealer.

Use only the specified brake fluid. (Refer to "Recommended lubricants and capacities" on page 10-6.)

Never mix different types of fluid.

In the event the brake system requires frequent additions of fluid, the vehicle should be inspected by an authorized Kia dealer.

When changing and adding brake fluid, handle it carefully. Do not let it come in contact with your eyes. If brake fluid should come in contact with your eyes, immediately flush them with a large quantity of fresh tap water. Have your eyes examined by a doctor as soon as possible.

⚠ CAUTION

Brake fluid

Do not allow brake fluid to contact the vehicle's body paint, as paint damage will result.

Brake fluid, which has been exposed to open air for an extended time should never be used as its quality cannot be guaranteed. It should be disposed of properly.

Washer fluid

Washer fluid is used when wiping the windshield of the vehicle with a windshield wiper. You should check and refill washer fluid periodically to make sure that it doesn't run out.

Checking the washer fluid level



The reservoir is translucent so that you can check the level with a quick visual inspection.

- Check the fluid level in the washer fluid reservoir and add fluid if necessary. Plain water may be used if washer fluid is not available. However, use washer solvent with antifreeze characteristics in cold climates to prevent freezing.

⚠ WARNING

Flammable Fluid

Do not allow the washer fluid to come in contact with open flames or sparks. The windshield washer fluid reservoir is flammable under certain circumstances. This can result in a fire.

⚠ WARNING

Coolant

- Do not use radiator coolant or anti-freeze in the washer fluid reservoir.
- Radiator coolant can severely obscure visibility when sprayed on the windshield and may cause loss of vehicle control.

⚠ WARNING

Windshield fluid

Do not drink the windshield washer fluid. The windshield washer fluid is poisonous to humans and animals.

Climate control air filter

The climate control air filter should be replaced according to the maintenance schedule. If the vehicle is operated in severely air-polluted cities or on dusty rough roads for a long period, it should be inspected more frequently and replaced earlier.

Inspecting and replacing climate control air filter

When you replace the climate control air filter, replace it performing the following procedure, and be careful to avoid damaging other components.

1. Open the hood and lift up the front trunk cover while depressing the front trunk lever (1).



2. Remove the cover by pulling the upper part of the cover.



3. Remove the climate control air filter case (2) by pulling out left side of the cover (1).



4. Replace the climate control air filter.



5. Reassemble in the reverse order of disassembly.

When replacing the climate control air filter, install it properly. Otherwise, the system may produce noise and the effectiveness of the filter may be reduced.

Wiper blades

When the wipers no longer clean adequately, the blades may be worn or cracked, and require replacement.

To prevent damage to the wiper arms or other components, do not attempt to move the wipers manually.

The use of a non-specified wiper blade could result in wiper malfunction and failure.

Blade inspection

Commercial hot waxes applied by automatic vehicle washes have been known to make the windshield difficult to clean. Contamination of either the windshield or the wiper blades with foreign matter can reduce the effectiveness of the windshield wipers. Common sources of contamination are insects, tree sap, and hot wax treatments used by some commercial vehicle washes. If the blades are not wiping properly, clean both the window and the blades with a good cleaner or mild detergent, and rinse thoroughly with clean water.

CAUTION

Wiper blades

To prevent damage to the wiper blades, do not use gasoline, kerosene, paint thinner, or other solvents on or near them.

Replacing front windshield wiper blade



After turning off the vehicle, move the wiper switch to the single wiping (MIST) position within 20 seconds and hold the switch more than 2 seconds until the wiper blade is in the fully up position.

Type A (if equipped)

1. Raise the wiper arm and turn the wiper blade assembly to expose the plastic locking clip.



CAUTION

Wiper Arms

- Do not allow the wiper arm to fall against the windshield, since it may chip or crack the windshield.
- Do not pull wiper arm forward, since it could chip the hood paint.

2. Compress the clip and slide the blade assembly downward.



3. Lift it off the arm.



4. Install the blade assembly in the reverse order of removal.

Type B (if equipped)

1. Raise the wiper arm.
2. Lift up the wiper blade clip (1). Then pull down the blade assembly and remove it (2).

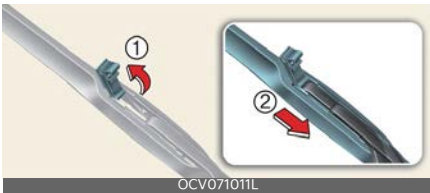

3. Install the new blade assembly.

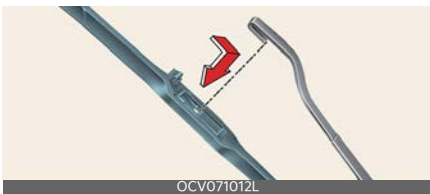

4. Return the wiper arm on the windshield.
5. Change EV button to the ON position and wiper arms will return to the normal operating position.

12V battery

The battery powers the various devices installed in the vehicle.

For best battery service



- Keep the battery securely mounted.
- Keep the battery top clean and dry.
- Keep the terminals and connections clean, tight, and coated with petroleum jelly or terminal grease.
- Rinse any spilled electrolyte from the battery immediately with a solution of water and baking soda.
- If the vehicle is not going to be used for an extended time, disconnect the battery cables.

WARNING

Risk of Explosion



Keep lit cigarettes and all other flames or sparks away from the battery.



The battery contains hydrogen -- a highly combustible gas which will explode if it comes in contact with a flame or

spark.



Keep batteries out of the reach of children because batteries contain highly corrosive SULFURIC ACID and electrolytes.

Do not allow battery acid to contact your skin, eyes, clothing or paint finish.



Wear eye protection when charging or working near a battery. Always provide ventilation when working in an enclosed space.



Always read the following instructions carefully when handling a battery.



If any electrolyte gets into your eyes, flush your eyes with clean water for at least 15 minutes and get immediate medical attention. If electrolyte gets on your skin, thoroughly wash the contacted area. If you feel pain or burning sensation, get medical attention immediately.



An inappropriately disposed battery can be harmful to the environment and human health. Dispose the battery according to your local law(s) or regulation.



The battery contains lead. Do not dispose of it after use. Please return the battery to an authorized Kia dealer to be recycled.

⚠ WARNING

Risk of Electrocutation

Never touch the electrical motor while the vehicle is running. This system works with high voltage, which can electrocute, injure, or kill you.

*** NOTICE**

If you connect unauthorized electronic devices to the battery, the battery may be discharged. Never use unauthorized devices.

⚠ WARNING

Recharging Battery

Never attempt to recharge the battery when the battery cables are connected.

Battery recharging

Your vehicle has a maintenance-free, calcium-based battery

- If the battery becomes discharged in a short time (because, for example, the headlights or interior lights were left on while the vehicle was not in use), recharge it by slow charging (trickle) for 10 hours.
- If the battery gradually discharges because of high electric load while the vehicle is being used, recharge it at 20~30 A for two hours.

When recharging the battery, observe the following precautions:

- The battery must be removed from the vehicle and placed in an area with good ventilation.
- Do not allow cigarettes, sparks, or flame near the battery.
- Watch the battery during charging, and stop or reduce the charging rate if the battery cells begin gassing (boiling) violently or if the temperature of the electrolyte of any cell exceeds 49 °C (120 °F).
- Wear eye protection when checking the battery during charging.
- Disconnect the battery charger in the following order.
 1. Turn off the battery charger main switch.
 2. Unhook the negative clamp from the negative battery terminal.

3. Unhook the positive clamp from the positive battery terminal.
- Before performing maintenance or recharging the battery, turn off all accessories and stop the vehicle.
 - The negative battery cable must be removed first and installed last when the battery is disconnected.

Reset items

The following items should be reset after the battery has been discharged or the battery has been disconnected.

- Auto up/down window (Refer to "Window opening and closing" on page 5-36)
- Trip computer (Refer to "Trip computer mode" on page 5-67)
- Climate control system (Refer to "Automatic climate control system" on page 5-98)

Tires and wheels

For proper maintenance, safety, and maximum fuel economy, you must always maintain recommended tire inflation pressures and stay within the load limits and weight distribution recommended for your vehicle.

Recommended cold tire inflation pressures

All tire pressures should be checked when the tires are cold. "Cold Tires" means the vehicle has not been driven for at least three hours or driven less than 1.6 km (one mile).

Recommended pressures must be maintained for the best ride, vehicle handling, and minimum tire wear.

For recommended inflation pressure, refer to "Tires and wheels" on page 10-4. All specifications (sizes and pressures) can be found on a label attached to the driver's side center pillar.



WARNING

Tire Underinflation

Inflate your tires consistent with the instructions provided in this manual. Severe underinflation (70 kPa (10 psi) or more) can lead to severe heat build-up, causing blowouts, tread separation and other tire failures that can result in the loss of vehicle control. This risk is much higher on hot days and when driving for long periods at high speeds.

Failure to maintain specified pressure may result in excessive wear, poor handling, reduced fuel economy, deformation of tire and/or wheel, harsh ride conditions, possibility for additional damage from road hazards, or result in tire failure.

Tire pressure

Always observe the following:

- Check tire pressure when the tires are cold. (After vehicle has been parked for at least three hours or hasn't been driven more than 1.6 km (one mile) since startup.)
- Check the pressure of your spare tire each time you check the pressure of other tires.
- Never overload your vehicle. Be careful not to overload a vehicle luggage rack if your vehicle is equipped with one.
- Warm tires normally exceed recommended cold tire pressures by 28 to 41 kPa (4 to 6 psi). Do not release air from warm tires to adjust the pressure or the tires will be underinflated.

WARNING

Tire Inflation

Overinflation or underinflation can reduce tire life, adversely affect vehicle handling, and lead to sudden tire failure. This could result in loss of vehicle control and potential injury.

Checking tire inflation pressure

Check your tires once a month or more. Use a good quality gauge to check tire pressure. You cannot tell if your tires are properly inflated simply by looking at them. Radial tires may look properly inflated even when they're underinflated.

Check the tire's inflation pressure when the tires are cold. "Cold" means your vehicle has been sitting for at least three hours or driven no more than 1.6 km (1 mile).

1. Remove the valve cap from the tire valve stem.
2. Press the tire gauge firmly onto the valve to get a pressure measurement. If the cold tire inflation pressure matches the recommended pressure on the tire and loading information label, no further adjustment is necessary.
3. If the pressure is low, add air until you reach the recommended amount.
4. If you overfill the tire, release air by pushing on the metal stem in the center of the tire valve.
5. Recheck the tire pressure with the tire gauge.
6. Be sure to put the valve caps back on the valve stems. They help prevent leaks by keeping out dirt and moisture.

Inspect your tires frequently for proper inflation as well as wear and damage. Always use a tire pressure gauge.

Tires with too much or too little pressure wear unevenly causing poor handling, loss of vehicle control, and sudden tire failure leading to accidents, injuries, and even death. The recommended cold tire pressure for your vehicle can be found

in this manual and on the tire label located on the driver's side center pillar.

Tire rotation

To equalize tread wear, it is recommended that the tires be rotated every 13,000 km (8,000 miles) or sooner if irregular wear develops.

During rotation, check the tires for correct balance.

When rotating tires, check for uneven wear and damage. Abnormal wear is usually caused by incorrect tire pressure, improper wheel alignment, out-of-balance wheels, severe braking or severe cornering. Look for bumps or bulges in the tread or side of tire. Replace the tire if you find either of these conditions. Replace the tire if fabric or cord is visible. After rotation, be sure to bring the front and rear tire pressures to specification and check lug nut tightness.

Refer to "Tires and wheels" on page 10-4.

Disc brake pads should be inspected for wear whenever tires are rotated.

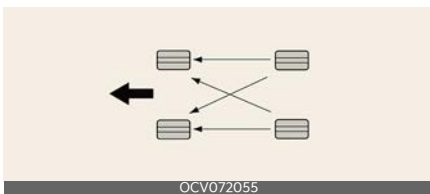

Rotate radial tires that have an asymmetric tread pattern only from front to rear and not from right to left.

⚠ WARNING

Mixing Tires

Do not mix bias ply and radial ply tires under any circumstances. This may cause unusual handling characteristics.

Wheel alignment and tire balance

The wheels on your vehicle were aligned and balanced carefully at the factory to give you the longest tire life and best overall performance.

In most cases, you will not need to have your wheels aligned again. However, if you notice unusual tire wear or your vehicle pulling one way or the other, the alignment may need to be reset.

If you notice your vehicle vibrating when driving on a smooth road, your wheels may need to be rebalanced.

⚠ CAUTION

Wheel Weight

Improper wheel weights can damage your vehicle's aluminum wheels. Use only approved wheel weights.

Tire replacement

If the tire is worn evenly, a tread wear indicator will appear as a solid band across the tread.



A: Tread wear indicator

This shows there is less than 1.6 mm (1/16 inch) of tread left on the tire. Replace the tire when this happens.

Do not wait for the band to appear across the entire tread before replacing the tire.

The ABS (Anti-lock Brake System) works by comparing the speed of the wheels. The tire size affects wheel speed. When replacing tires, all 4 tires must use the same size originally supplied with the

vehicle. Using tires of a different size can cause the ABS (Anti-lock Brake System) and ESC (Electronic Stability Control) to work irregularly.

It is best to replace all four tires at the same time. If that is not possible, or necessary, then replace the two front or two rear tires as a pair. Replacing just one tire can seriously affect your vehicle's handling.

* NOTICE

We recommend that when replacing tires, use the same originally supplied with the vehicles. If not, that affects driving performance.

Wheel replacement

When replacing the metal wheels for any reason, make sure the new wheels are equivalent to the original factory units in diameter, rim width and offset.

A wheel that is not the correct size may adversely affect wheel and bearing life, braking and stopping abilities, handling characteristics, ground clearance, body-to-tire clearance, snow chain clearance, speedometer and odometer calibration, headlight aim and bumper height.

⚠ CAUTION

Wheels

Wheels that do not meet Kia specifications may fit poorly and result in damage to the vehicle or unusual handling and poor vehicle control.

Tire traction

Tire traction can be reduced if you drive on worn tires, tires that are improperly inflated or on slippery road surfaces.

Tires should be replaced when tread wear indicators appear. Slow down whenever there is rain, snow or ice on the road to reduce the possibility of losing control of the vehicle.

Tire maintenance

In addition to proper inflation, correct wheel alignment helps to decrease tire wear.

If you find a tire is worn unevenly, have your dealer check the wheel alignment. When you have new tires installed, make sure they are balanced. This will increase vehicle ride comfort and tire life. Additionally, a tire should always be rebalanced if it is removed from the wheel.

Tire sidewall labeling

This information identifies and describes the fundamental characteristics of the tire and also provides the tire identification number (TIN) for safety standard certification.



The TIN can be used to identify the tire in case of a recall.

1. Manufacturer or brand name

Manufacturer or Brand name is shown.

2. Tire size designation

A tire's sidewall is marked with a tire size designation. You will need this information when selecting replacement tires for your vehicle. The following explains what the letters and numbers in the tire size designation mean.

Example tire size designation:

(These numbers are provided as an example only; your tire size designator could vary depending on your vehicle.)

P255/45R20 105H

- P: Applicable vehicle type (tires marked with the prefix "P" are intended for use on passenger vehicles or light trucks; however, not all tires have this marking).
- 255: Tire width in millimeters.
- 45: Aspect ratio. The tire's section height as a percentage of its width.
- R: Tire construction code (Radial).
- 20: Rim diameter in inches.
- 105: Load Index, a numerical code associated with the maximum load the tire can carry.
- H: Speed Rating Symbol. See the speed rating chart in this section for additional information.

Wheel size designation

Wheels are also marked with important information that you need if you ever have to replace one. The following explains what the letters and numbers in the wheel size designation mean.

Example wheel size designation:

8.0JX20

- 8.0: Rim width in inches.
- J: Rim contour designation.
- 20: Rim diameter in inches.

Tire speed ratings

The chart below lists many of the different speed ratings currently being used for passenger vehicle tires. The speed rating is part of the tire size designation on the sidewall of the tire. This symbol corresponds to that tire's designed maximum safe operating speed.

Speed Rating Symbol	Maximum Speed
S	180 km/h (112 mph)
T	118 km/h (190 mph)
H	210 km/h (130 mph)
V	240 km/h (149 mph)
Z	Above 240 km/h (149 mph)

3. Checking tire life (TIN: Tire Identification Number)

Any tires that are over 6 years old, based on the manufacturing date, should be replaced by new ones. You can find the manufacturing date on the tire sidewall (possibly on the inside of the wheel), displaying the DOT Code. The DOT Code is a series of numbers on a tire consisting of numbers and English letters. The manufacturing date is designated by the last four digits (characters) of the DOT code.

DOT: XXXX XXXX OOOO

The front part of the DOT means a plant code number, tire size and tread pattern and the last four numbers indicate week and year manufactured.

For example:

DOT XXXX XXXX 1623 represents that the tire was produced in the 16th week of 2023.

WARNING

Tire Age

Replace tires within the recommended time frame. Failure to replace tires as recommended can result in sudden tire failure, which could lead to a loss of control and an accident.

4. Tire ply composition and material

The number of layers or plies of rubber-coated fabric in the tire. Tire manufacturers also must indicate the materials in the tire, which include steel, nylon, polyester, and others. The letter "R" means radial ply construction; the letter "D" means diagonal or bias ply construction; and the letter "B" means belted-bias ply construction.

5. Maximum permissible inflation pressure

This number is the greatest amount of air pressure that should be put in the tire. Do not exceed the maximum permissible inflation pressure. Refer to the Tire and Loading Information label for recommended inflation pressure.

6. Maximum load rating

This number indicates the maximum load in kilograms and pounds that can be carried by the tire. When replacing the tires on the vehicle, always use a tire that has the same load rating as the factory installed tire.

7. Uniform Tire Quality Grading

Quality grades can be found where applicable on the tire sidewall between tread shoulder and maximum section width.

For example:

- Treadwear 200
- Traction AA
- Temperature A

Tires degrade over time, even when they are not being used. Regardless of the remaining tread, we recommend that tires be replaced after approximately six (6) years of normal service. Heat caused by hot climate or frequent high loading conditions can accelerate the aging process.

Tread wear

The tread wear grade is a comparative rating based on the wear rate of the tire when tested under controlled conditions on a specified government test course. For example, a tire graded 150 would wear one-and-a-half times (1½) as well on the government course as a tire graded 100.

The relative performance of tires depends upon the actual conditions of their use, however, and may depart significantly from the norm due to variations in driving habits, service practices and differences in road characteristics and climate.

These grades are molded on the sidewalls of passenger vehicle tires. The tires available as standard or optional equipment on your vehicle may vary with respect to grade.

Traction - AA, A, B & C

The traction grades, from highest to lowest, are AA, A, B and C. Those grades represent the tire's ability to stop on wet pavement as measured under controlled conditions on specified government test surfaces of asphalt and concrete. A tire marked C may have poor traction performance.

The traction grade assigned to this tire is based on straight-ahead braking traction tests, and does not include acceleration, cornering, hydroplaning, or peak traction characteristics.

Temperature -A & B

The temperature grades are A (the highest), B and C representing the tire's resistance to the generation of heat and its ability to dissipate heat when tested under controlled conditions on a specified indoor laboratory test wheel.

Sustained high temperature can cause the material of the tire to degenerate and reduce tire life, and excessive temperature can lead to sudden tire failure. Grades B and A represent higher levels of performance on the laboratory test wheel than the minimum required by law.

Tire terminology and definitions

Refer to the following for detailed definitions of the terms that are found in the tire description.

Air Pressure The amount of air inside the tire pressing outward on the tire. Air pressure is expressed in pounds per square psi (inch) or kilopascal (kPa).

Accessory Weight This means the combined weight of optional accessories. Some examples of optional accessories

are automatic transaxle, power seats, and air conditioning.

Aspect Ratio The relationship of a tire's height to its width.

Belt A rubber coated layer of cords that is located between the plies and the tread. Cords may be made from steel or other reinforcing materials.

Bead The tire bead contains steel wires wrapped by steel cords that hold the tire onto the rim.

Bias Ply Tire A pneumatic tire in which the plies are laid at alternate angles less than 90 degrees to the centerline of the tread.

Cold Tire Pressure The amount of air pressure in a tire, measured in pounds per square psi (inch) or kilopascal (kPa) before a tire has built up heat from driving.

Curb Weight This means the weight of a motor vehicle with standard and optional equipment including the maximum capacity of fuel, oil and coolant, but without passengers and cargo.

DOT Markings The DOT code includes the Tire Identification Number (TIN), an alphanumeric designator which can also identify the tire manufacturer, production plant, brand and date of production.

GVWR Gross Vehicle Weight Rating

GAWR FRT Gross Axle Weight Rating for the Front Axle.

GAWR RR Gross Axle Weight Rating for the Rear axle.

Intended Outboard Sidewall The side of an asymmetrical tire that must always face outward when mounted on a vehicle.

Kilopascal (kPa) The metric unit for air pressure.

Light truck (LT) tire A tire designated by its manufacturer as primarily intended for use on lightweight trucks or multipurpose passenger vehicles.

Load ratings The maximum load that a tire is rated to carry for a given inflation pressure.

Load Index An assigned number ranging from 1 to 279 that corresponds to the load carrying capacity of a tire.

Maximum Inflation Pressure The maximum air pressure to which a cold tire may be inflated. The maximum air pressure is molded onto the sidewall.

Maximum Load Rating The load rating for a tire at the maximum permissible inflation pressure for that tire.

Maximum Loaded Vehicle Weight The sum of curb weight; accessory weight; vehicle capacity weight; and production options weight.

Normal Occupant Weight The number of occupants a vehicle is designed to seat multiplied by 68 kg (150 pounds).

Occupant Distribution Designated seating positions.

Outward Facing Sidewall The side of an asymmetrical tire that has a particular side that faces outward when mounted on a vehicle. The outward facing sidewall bears white lettering or bears manufacturer, brand, and/or model name molding that is higher or deeper than the same moldings on the inner facing sidewall.

Passenger (P-Metric) Tire A tire used on passenger cars and some light duty trucks and multipurpose vehicles.

Ply A layer of rubber-coated parallel cords.

Pneumatic tire A mechanical device made of rubber, chemicals, fabric and steel or other materials, that, when

mounted on an automotive wheel, provides the traction and contains the gas or fluid that sustains the load.

Production options weight The combined weight of installed regular production options weighing over 2.3 kg (5 lb.) in excess of the standard items which they replace, not previously considered in curb weight or accessory weight, including heavy duty brakes, ride levelers, roof rack, heavy duty battery, and special trim.

Recommended Inflation Pressure Vehicle manufacturer's recommended tire inflation pressure and shown on the tire placard.

Radial Ply Tire A pneumatic tire in which the ply cords that extend to the beads are laid at 90 degrees to the centerline of the tread.

Rim A metal support for a tire and upon which the tire beads are seated.

Sidewall The portion of a tire between the tread and the bead.

Speed Rating An alphanumeric code assigned to a tire indicating the maximum speed at which a tire can operate.

Traction The friction between the tire and the road surface. The amount of grip provided.

Tread The portion of a tire that comes into contact with the road.

Treadwear Indicators Narrow bands, sometimes called "wear bars," that show across the tread of a tire when only 1.6 mm (2/32 inch) of tread remains.

UTQGS Uniform Tire Quality Grading Standards, a tire information system that provides consumers with ratings for a tire's traction, temperature and treadwear. Ratings are determined by tire manufacturers using government test-

ing procedures. The ratings are molded into the sidewall of the tire.

Vehicle Capacity Weight The number of designated seating positions multiplied by 68 kg (150 lbs.) plus the rated cargo and luggage load.

Vehicle Maximum Load on the Tire Load on an individual tire due to curb and accessory weight plus maximum occupant and cargo weight.

Vehicle Normal Load on the Tire Load on an individual tire that is determined by distributing to each axle its share of the curb weight, accessory weight, and normal occupant weight and dividing by 2.

Vehicle Placard A label permanently attached to a vehicle showing the original equipment tire size and recommended inflation pressure.

All season tires

Kia specifies all season tires on some models to provide good performance for use all year round, including snowy and icy road conditions.

All season tires are identified by ALL SEASON and/or M+S (Mud and Snow) on the tire sidewall. Snow tires have better snow traction than all season tires and may be more appropriate in some areas.

Summer tires

Kia specifies summer tires on some models to provide superior performance on dry roads.

Summer tire performance is substantially reduced in snow and ice. Summer tires do not have the tire traction rating M+S (Mud and Snow) on the tire sidewall. If you plan to operate your vehicle in snowy or icy conditions, Kia recom-

mends the use of snow tires or all season tires on all four wheels.

Snow tires

If you equip your vehicle with snow tires, they should be the same size and have the same load capacity as the original tires.

Snow tires should be installed on all four wheels; otherwise, poor handling may result.

Snow tires should carry 28 kPa (4 psi) more air pressure than the pressure recommended for the standard tires on the tire label on the driver's side of the center pillar, or up to the maximum pressure shown on the tire sidewall, whichever is less.

Do not drive faster than 120 km/h (75 mph) when your vehicle is equipped with snow tires.

WARNING

Do not use summer tires at temperatures below 7 °C (45 °F) or when driving on snow or ice. At temperatures below 7 °C (45 °F), summer tires can lose elasticity, and therefore traction and braking power as well. Change the tires on your vehicle to winter or all-weather tires of the same size as the standard tires of the vehicle. Both types of tires are identified by the M+S (Mud and Snow) marking. Using summer tires at very cold temperatures could cause cracks to form, thereby damaging the tires permanently.

Radial-ply tires

Radial-ply tires provide improved tread life, road hazard resistance and smoother high speed ride.

The radial-ply tires used on this vehicle are of belted construction, and are

selected to complement the ride and handling characteristics of your vehicle. Radial-ply tires have the same load carrying capacity, as bias-ply or bias belted tires of the same size, and use the same recommended inflation pressure.

Mixing of radial-ply tires with bias-ply or bias belted tires is not recommended. Any combinations of radial-ply and bias-ply or bias belted tires when used on the same vehicle will seriously deteriorate vehicle handling. The best rule to follow is: Identical radial-ply tires should always be used as a set of four.

Longer wearing tires can be more susceptible to irregular tread wear. It is very important to follow the tire rotation interval shown in this section to achieve the tread life potential of these tires. Cuts and punctures in radial-ply tires are repairable only in the tread area, because of sidewall flexing. Consult your tire dealer for radial-ply tire repairs.

Low aspect ratio tire (if equipped)

Low aspect ratio tires, whose aspect ratio is lower than 50, are provided for sporty looks.

Because the low aspect ratio tires are optimized for handling and braking, it may be more uncomfortable to ride in and there is more noise compare with normal tires.

CAUTION

Because the sidewall of the low aspect ratio tire is shorter than the normal, the wheel and tire of the low aspect ratio tire is easier to be damaged. So, follow the instructions below.

- When driving on a rough road or off road, drive cautiously because tires

and wheels may be damaged. And after driving, inspect tires and wheels.

- When passing over a pothole, speed bump, manhole, or curb stone, drive slowly so that the tires and wheels are not damaged.
 - If the tire is impacted, we recommend that you inspect the tire condition or contact an authorized Kia dealer.
 - To prevent damage to the tire, inspect the tire condition and pressure every 3,000 km (1,900 miles).
-
- It is not easy to recognize the tire damage with your own eyes. But if there is the slightest hint of tire damage, even though you cannot see the tire damage with your own eyes, have the tire checked or replaced because the tire damage may cause air leakage from the tire.
 - If the tire is damaged by driving on a rough road, off road, pothole, manhole, or curb stone, it will not be covered by the warranty.
 - You can find out the tire information on the tire sidewall.

Fuses

A vehicle's electrical system is protected from electrical overload damage by fuses.

Blade type



Cartridge type



Multi fuse



BFT

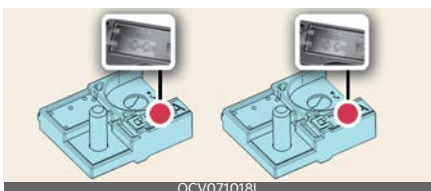

* Left side: Normal, Right side: Blown
 This vehicle has 2 (or 3) fuse panels, one located in the driver's side panel bolster, the other in the motor compartment near the battery.
 If any of your vehicle's lights, accessories, or controls do not work, check the

appropriate circuit fuse. If a fuse has blown, the element inside the fuse will melt.

If the electrical system does not work, first check the driver's side fuse panel.

If the replacement fuse blows, this indicates an electrical problem. Avoid using the system involved and immediately consult an authorized Kia dealer.

Three kinds of fuses are used: blade type for lower amperage rating, cartridge type, and multi fuse for higher amperage ratings.

⚠ WARNING

Fuse Replacement

- Never replace a fuse with anything but another fuse of the same rating.
- A higher capacity fuse could cause damage and possibly a fire.
- Never install a wire or aluminum foil instead of the proper fuse - even as a temporary repair. It may cause extensive wiring damage and a possible fire.
- Do not arbitrarily modify or add-on electric wiring to the vehicle.

⚠ CAUTION

Do not use a screwdriver or any other metal object to remove fuses because it may cause a short circuit and damage the system.

*** NOTICE**

- When replacing a fuse, change the EV button to the OFF position and turn off switches of all electrical devices; then remove the battery (-) terminal.
- The actual fuse/relay panel label may differ from equipped items.

⚠ WARNING**Electrical Fire**

Always ensure replacement fuses and relays are securely fastened when installed. Failure to do so can result in a vehicle fire.

Do not remove fuses, relays and terminals fastened with bolts or nuts. The fuses, relays and terminals may be fastened incompletely, and it may cause a possible fire. If fuses, relays and terminals fastened with bolts or nuts are blown, we recommend that you consult with an authorized Kia dealer.

⚠ CAUTION

When replacing a blown fuse or relay, make sure the new fuse or relay fits tightly into the clips. Failure to tightly install the fuse or relay may cause damage to the wiring and electric systems.

⚠ CAUTION

- Do not input any other objects except fuses or relays into fuse/relay terminals, such as a screwdriver or wiring. It may cause contact failure and system malfunction.
- Do not plug in screwdrivers or after-market wiring into the terminal originally designed for fuses and relays only. The electrical system and wiring of the vehicle interior may be damaged or burned due to contact failure.
- If you directly connect the wire on the taillight or replace the bulb which is over the regulated capacity to install trailers etc., the inner junction block can get burned.

⚠ WARNING**Electrical Wiring Repairs**

All electrical repairs should be performed by an authorized Kia dealership using approved Kia parts. Using other wiring components, especially when retrofitting multimedia or theft alarm system, car phone or radio may cause vehicle damage and increase the risk of a vehicle fire.

*** NOTICE****Rewiring Prohibited**

Do not rewire your vehicle in any way as doing so may affect the performance of several safety features in your vehicle. Rewiring your vehicle may also void your warranty and cause you to be responsible for any subsequent vehicle damage which may result.

Replacing inner panel fuse

1. Press the EV button to OFF position and turn off all the vehicle electrical devices.
2. Open the fuse panel cover.



If the switch is located in the "OFF" position, a caution indicator will be displayed in the cluster.

To identify the location of a specific fuse, please refer to the inside of the fuse panel cover and the description list in this section.

3. Pull the suspected fuse straight out.
Use the removal tool provided on the motor compartment fuse panel cover.



4. Check the removed fuse; replace it if it is blown.
Spare fuses are provided in the motor compartment fuse panel.
5. Push in a new fuse of the same rating, and make sure it fits tightly in the clips.

If it fits loosely, consult an authorized Kia dealer.

If you do not have a spare, use a fuse of the same rating from a circuit you may not need for operating the vehicle, such as the power outlet fuse.

If the head lamp, turn signal lamp, stop signal lamp, DRL, tail lamp, HMSL do not work and the fuses are OK, check the fuse panel in the motor compartment. If a fuse is blown, it must be replaced.

*** NOTICE**

If the headlamp, turn signal lamp, or tail lamp malfunctions even without any problem to the lamps, have the vehicle checked by an authorized Kia dealer for assistance.

Replacing motor compartment fuse

1. Press the EV button to OFF position and turn off all the vehicle electrical devices.
2. Remove the fuse panel cover by pressing the tab and pulling the cover up.



3. Check the removed fuse; replace it if it is blown. To remove or insert the fuse, use the fuse puller in the motor compartment fuse panel.
4. Push in a new fuse of the same rating, and make sure it fits tightly in the clips. If it fits loosely, consult an authorized Kia dealer.

⚠ CAUTION

Always securely install the fuse panel cover in the motor compartment to protect against electrical failure which may occur from water contact. Listen for the audible clicking sound to ensure fuse panel cover is securely fastened.

Multi fuse

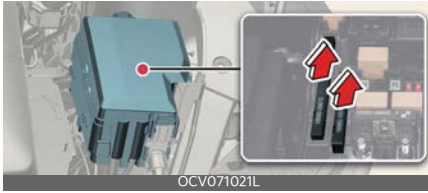

If the multi fuse is blown, it must be removed as follows:

1. Press the EV button to OFF position and turn off all the vehicle electrical devices.
2. Disconnect the negative battery cable.
3. Remove the nuts shown in the picture above.
4. Replace the fuse with a new one of the same rating.
5. Reverse these steps to reinstall the multi fuse.

⚠ DANGER

Do not disassemble nor assemble the multi fuse when it is secured with nuts and bolts. Incorrect or partial assembly torque may cause a fire. Have the vehicle checked by an authorized Kia dealer.

Main fuse



If the main fuse is blown, it must be removed as follows:

1. Turn the EV button and all other switches off.
2. Disconnect the negative battery cable.

3. Remove the nuts shown in the picture above.
4. Replace the fuse with a new one of the same rating.
5. Reverse these steps to reinstall the multi fuse.

*** NOTICE**

The electronic system may not function correctly even when the motor compartment and internal fuse box's individual fuses are not disconnected. In such a case, the cause of the problem may be disconnection of the main fuse (BFT type), which is located inside the positive battery terminal (+) cap.

Since the main fuse is designed more intricately than other parts, have the vehicle checked by an authorized Kia dealer.

⚠ CAUTION

Visually inspect the battery cap for secure closing. If the battery cap is not securely latched, the electrical system may be damaged to due influx of moisture into the system.

Fuse/relay panel description

Inside the fuse/relay panel covers, you can find the fuse/relay label describing fuse/relay name and capacity.

Driver's side fuse panel



* NOTICE

Not all fuse panel descriptions in this manual may be applicable to your vehicle. It is accurate at the time of printing. When you inspect the fuse panel in your vehicle, refer to the fuse panel label on the inside of the fuse cover. This diagram will provide you with the specific information for your vehicles.

CHILD LOCK	15A	AFCU			A/BAG IND	7.5A		2 MEMORY	10A	START	7.5A		HEATED MIRROR	10A
TAILGATE OPEN	15A	3 EPCU			3 MODULE	7.5A	CLUSTER	8 IG3	10A	7 IG3	10A	IAU	ECS	15A
8 MODULE	10A	S/HEATER FRT	20A	WASHER	15A		2 IBU	7.5A	10 IG3	10A	9 IG3	BATTERY MANAGEMENT	2 AIR BAG	10A
1 SUNROOF	30A	P/WINDOW LH	25A	20 SPARE	15A	3 E-SHIFTER	4 MODULE	10A	15A	1 MEMORY	10A	3 SPARE	2 A/C	10A
AMP	25A	P/WINDOW RH	25A	5 MODULE	7.5A	5 MODULE		1 SPARE	10A	E-CALL	15A	1 IBU	BRAKE SWITCH	10A
P/SEAT DRV	30A	E-LSD	20A	1 A/C	7.5A	1 AIR BAG	15A		2 MODULE	10A	MULTI MEDIA	15A	DOOR LOCK	20A
P/SEAT PASS	30A	S/HEATER REAR	25A	7 MODULE	7.5A									1 MODULE

91990-CV020
 USE THE DESIGNATED FUSE ONLY.
 UTILISEZ SEULEMENT LE FUSIBLE DÉSIGNÉS.

OCV071023N

ICU Junction Block

Refer to the following table for a description of the fuse.

Fuse Name	Fuse Rating	Circuit Protected
CHILD LOCK	15A	Child Lock Relay, Child Unlock Relay
AFCU	20A	AFCU
A/BAG IND	7.5A	Overhead Console
MEMORY2	10A	ADP, Head-Up Display, ADS Unit

Fuse Name	Fuse Rating	Circuit Protected
START	7.5A	VCU, IBU
TALGATE OPEN	15A	Liftgate Latch
³ EPCU	10A	Rear Inverter
MODULE3	7.5A	Multifunction Switch, IBU, Stop Lamp Switch, Driver Door Module
CLUSTER	7.5A	Head-Up Display, Instrument Cluster
IG3 8	10A	V2L Unit, ICCU, VCMS, SCU, Rear Electronic Oil Pump, CDM
IG3 7	10A	In-car Temperature Sensor, A/V & Navigation Head Unit, A/C PTC Heater, A/C Control Module, Instrument Cluster, Charger Indicator
IAU	10A	Driver/Passenger Door Outside Handle
ECS	15A	Electronic Control Suspension
MODULE8	10A	Driver/Passenger Power Seat Module, Driver/Passenger Manual Seat Switch
S/HEATER FRT	20A	Front Air Ventilation Seat Control Module, Front Seat Warmer Control Module
WASHER	15A	Multifunction Switch
IBU2	7.5A	IBU
IG3 10	10A	Rear Inverter, BMU
IG3 9	10A	Not Used
BATTERY MANAGEMENT	10A	BMU
AIR BAG2	10A	SRS Control Module
SUN ROOF1	25A	Sunroof Control Unit (Glass/Roller)
P/WINDOW LH	25A	Driver Safety Power Window Module, Rear Power Window Switch LH
SPARE2 (IG2)	15A	Not Used
E-SHIFTER3	10A	Electronic ATM Shift Dial
MODULE4	10A	Front/Rear Corner Radar LH/RH, Front/Rear Inverter, ADAS Unit (Driving), VESS Unit, Front Radar, Front View Camera, ADAS Unit (Parking), Console Upper Cover Switch
USB CHARGER	15A	Driver/Passenger Seat USB Charger, Front USB Charging Connector, Universal Island UBS Charger Connector
MEMORY1	15A	ICU Junction Block (Fuse Memory2), Instrument Cluster, A/C Control Module, Console Mood Lamp (Upper/Lower), Console Floor Switch, Driver/Passenger Door Mood Lamp, Rear Door Mood Lamp LH/RH, Instrument Cluster, Crash Pad Mood Lamp LH/RH, Mood Lamp Unit
SPARE3 (B+)	10A	Not Used
A/C2	10A	A/C Control Module, High Pressure Valve, Refrigerants Valve #1/#2, P/R Junction Block (Blower Relay), BSA Chiller #1, A/C Coolant Valve
AMP	25A	AMP
P/WINDOW RH	25A	Passenger Safety Power Window Module, Rear Power Window Switch RH
MODULE6	7.5A	IBU
MODULE5	10A	Data Link Connector, Electro Chromic Mirror, ADP, A/V & Navigation Head Unit, Crash Pad Switch, AMP, Front Air Ventilation Seat Control Module, Front Seat Warmer Control Module, Smart Phone Wireless Charger, Driver/Passenger Power Seat Module, Rear Seat Warmer Control Module, Console Floor Switch
SPARE1 (ACC)	10A	Not Used
E-CALL	10A	Not Used
IBU1	15A	IBU

Fuse Name	Fuse Rating	Circuit Protected
BRAKE SWITCH	10A	Stop Lamp Switch, IBU
P/SEAT DRV	30A	Driver Power Seat Switch, Driver Power Seat Module (With IMS)
E-LSD	20A	Electronic Limited-Slip Differential
A/C1	7.5A	A/C Control Module
AIR BAG1	15A	SRS Control Module
MODULE2	10A	AMP, ADP, P/E Junction Block (Power Outlet Relay), IBU, ADAS Unit, A/V & Navigation Keyboard, A/V & Navigation Head Unit
MULTI MEDIA	15A	A/V & Navigation Head Unit
DOOR LOCK	20A	Door Lock Relay, Door Unlock Relay, Two Turn Unlock Relay
MODULE1	10A	Hazard Lamp Switch, Multifunction Switch, Data Link Connector, Rain Sensor, Puddle Lamp, PTG Unit, Driver Door Module, Driver/Passenger Outside Mirror Unit
P/SEAT PASS	30A	Passenger Power Seat Switch, Passenger Power Seat Module
S/HEATER REAR	25A	Rear Seat Warmer Control Module
MODULE7	7.5A	Not Used
HEATED MIRROR	10A	Outside Mirror

Motor compartment fuse panel



OCV071067L



P/R Junction Block

Refer to the following table for a description of the fuse.

Fuse Name	Fuse Rating	Circuit Protected
MULTI FUSE-1	LDC	180A
	MDPS f ¹	100A
		P/R Junction Block (Fuse: POWER TAILGATE, EOP1, EOP2, POWER OUTLET1) EPS Unit

	Fuse Name	Fuse Rating	Circuit Protected
MULTI FUSE-3	B+5	60A	PCB Block (IG3 Main Relay, Fuse: EPCU1, VCU2, WIPER1, HORN)
	B+3	60A	ICU Junction Block (Fuse: EPCU3, P/SEAT DRV, P/SEAT PASS, P/WINDOW LH, P/WINDOW RH, AFCU, E-LSD, SUNROOF1, S/HEATER FRT, S/HEATER RR, AMP, MODULE8, TAILGATE OPEN, CHILD LOCK)
	B+2	60A	ICU Junction Block (IPS1, PS6, IPS8, IPS9, IPS10)
	B+1	50A	ICU Junction Block (IPS2, IPS3, IPS5, IPS7, IPS13)
	IEB1	60A	IEB Unit
	IEB2	60A	IEB Unit
	IG1	40A	P/R Junction Block (ACC Relay, IG1 Relay)
	IG2	40A	P/R Junction Block (IG2 Relay)
MULTI FUSE-2	COOLING FAN	80A	Cooling Fan Motor
	REAR HEATED	50A	P/R Junction Block (Rear Heated Relay)
	TRAILER1	50A	Trailer Connector Unit
	BLOWER	50A	P/R Junction Block (Blower Relay)
FUSE	B+4	40A	ICU Junction Block (Long Term Load Latch Relay, Fuse: IBU1, BRAKE SWITCH, AIR BAG2, A/C2, ECS, BATTERY MANAGEMENT, MODULE1, IAU, SPARE3(B+))
	E-SHIFTER1	40A	P/R Junction Block (E-Shifter Relay, Fuse: E-SHIFTER2)
	CHARGER1	10A	P/R Junction Block (Charger Lock/Unlock Relay), ICCU, VCMS
	CHARGER2	10A	CDM
	AMS	10A	12V Battery Sensor
	EWP1	20A	Electronic Water Pump #1
	EWP2	20A	Electronic Water Pump #2
	TRAILER2	20A	Not Used
	VESS	10A	VESS Unit
	VCU1	40A	VCU
	POWER OUTLET1	40A	P/R Junction Block (Power Outlet Relay)
	POWER TAILGATE	30A	PTG Unit
	EOP1	40A	Rear Electronic Oil Pump
	EOP2	40A	Front Electronic Oil Pump (AWD)
	E-SHIFTER2	10A	P/R Junction Block (E-Shifter Relay), SCU, Electronic ATM Shift Dial
	POWER OUTLET3	20A	Rear Power Outlet
POWER OUTLET2	20A	Front Power Outlet	

*1: MDPS (Motor Driven Power Steering) is the same as EPS (Electric Power Steering).

PCB Block

Refer to the following table for a description of the fuse.

Fuse Name	Fuse Rating	Circuit Protected
WIPER1	25A	PCB Block (Wiper Main Relay)
EPCU1	15A	Front Inverter (AWD)
SPARE	10A	Spare
HORN	15A	PCB Block (Horn Relay)
WIPER2	7.5A	IBU
VCU2	15A	VCU
IG3 1	20A	ICU Junction Block (Fuse: IG3 7, IG3 8, IG3 9, IG3 10)
IG3 3	15A	Electronic Water Pump
IG3 5	10A	BMS Coolant 3Way Valve
VCU3	10A	VCU
IG3 4	10A	Front Inverter (AWD), Electronic Water Pump #1, #2, Electronic A/C Compressor
IEB3	10A	IEB Unit
IG3 6	10A	Cooling Fan Motor, Front Electronic Oil Pump (AWD)
MDPS2 ^{*1}	10A	EPS Unit
IG3 2	15A	VCU

*1: MDPS (Motor Driven Power Steering) is the same as EPS (Electric Power Steering).

Relay

Refer to the following table for a description of the fuse.

Relay No.	Relay Name	Type
RLY. 1	CHARGER LOCK	MICRO
RLY. 2	E-SHIFTER	MICRO
RLY. 3	REAR HEATED	MINI
RLY. 5	ACC	MICRO
RLY. 7	IG1	MICRO
RLY. 9	BLOWER	MICRO
RLY. 10	IG2	MICRO
RLY. 11	POWER OUTLET	MICRO
RLY. 12	CHARGER UNLOCK	MICRO

Light bulbs

Light bulbs are installed in various parts of the vehicle to provide lighting inside and outside the vehicle as well as to alert other vehicles.

Bulb replacement precaution

Please keep extra bulbs on hand with appropriate wattage ratings in case of emergencies.

Refer to "Bulb wattage" on page 10-3.

When changing lamps, first turn off the vehicle at a safe place, firmly apply the parking brake and detach the battery's negative (-) terminal.

⚠ WARNING

Working on the Lights

Prior to working on the light, firmly apply the parking brake, ensure that the vehicle EV button is in the OFF position and turn off the lights to avoid sudden movement of the vehicle and burning your fingers or receiving an electric shock.

Use only bulbs of the specified wattage.

⚠ CAUTION

Light Replacement

Be sure to replace the burned-out bulb with one of the same wattage rating. Otherwise, it may cause damage to the fuse or electric wiring system.

⚠ CAUTION

Headlamp Lens

To prevent damage, do not clean the headlamp lens with chemical solvents or strong detergents.

*** NOTICE**

- If the light bulb or lamp connector is removed while the lamp is still on, the fuse box's electronic system may log it as a malfunction. Therefore, a lamp malfunction incident may be recorded as a Diagnostic Trouble Code (DTC) in the fuse box.
- It is normal for an operating lamp to flicker momentarily. This is due to a stabilization function of the vehicle's electronic control device. If the lamp lights up normally after momentarily blinking, then it is functioning as normal.
However, if the lamp continues to flicker several times or turns off completely, there may be an error in the vehicle's electronic control device. Please have the vehicle checked by an authorized Kia dealer immediately.

*** NOTICE**

We recommend that the headlight aiming be adjusted by an authorized Kia dealer after an accident or after the headlight assembly is reinstalled.

*** NOTICE**

You can find moisture inside the lens of lamps after a car wash or driving in the rain. It is a natural event caused by the temperature difference between the inside and the outside of the lamp and does not mean a problem with its functions. The moisture inside the lamp would disappear if you drive the vehicle with the headlamp turned on; however, the level at which the moisture is removed may differ depending on the size/location/condition of the lamp. If the moisture continues to stay inside the

lamp, have the vehicle checked by an authorized Kia dealer.

If you don't have the necessary tools, the correct bulbs and the expertise, consult an authorized Kia dealer. In many cases, it is difficult to replace vehicle light bulbs because other parts of the vehicle must be removed before you can get to the bulb. This is especially true if you have to remove the headlamp assembly to get to the bulb(s).

Removing/installing the headlamp assembly can result in damage to the vehicle. If non-genuine parts or substandard bulbs are used, it may lead to blowing a fuse or other wiring damages. Kia Genuine Parts we guarantee for quality and performance.

Do not install extra lamps or LEDs to the vehicle. If additional lights are installed, it may lead to lamp malfunctions and flickering. Additionally, the fuse box and other wiring may be damaged.

Light position (Front)

Head lamp

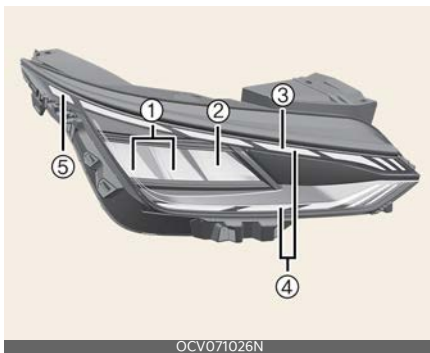

- 1 Headlamp (Low) (LED type)
- 2 Headlamp (High) (LED type)
- 3 Front turn signal lamp (LED type)

4 Day time running lamp/Position lamp (LED type)

5 Side marker (LED type)

If the LED lamp does not operate, have the system inspected by an authorized Kia dealer.

The LED lamps cannot be replaced as a single unit because it is an integrated unit. The LED lamps has to be replaced with the unit.

A skilled technician should check or repair the LED lamp, or it may damage related parts of the vehicle.

Light position (Rear)

Type A

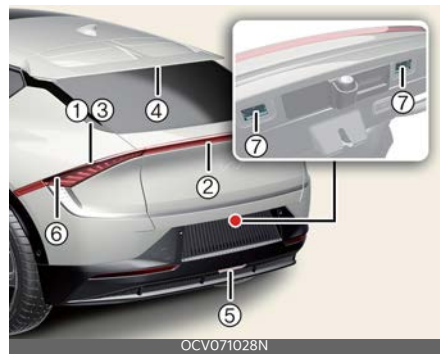

OCV071028N

Type B



OCV071068N

- 1 Stop and tail lamp (LED type)

- 2 Tail lamp (LED type)
- 3 Rear turn signal lamp (LED type)
- 4 High mounted stop lamp (LED type)
- 5 Back up lamp (LED type)
- 6 Rear side marker (LED type)
- 7 License plate lamp (LED type)

⚠ CAUTION

Be careful when opening and closing the liftgate, as you may be injured or damaged if your body or an object hits a sharp part such as a corner when opening or closing the liftgate or inserting or removing objects. In particular, children may be injured if their face or head hits the area around the liftgate, so please pay attention at all times.

Replacing lights (LED type, except glove box lamp)

If the LED lamp does not operate, have the system inspected by an authorized Kia dealer.

The LED lamps cannot be replaced as a single unit because it is an integrated unit. The LED lamps has to be replaced with the unit.

A skilled technician should check or repair the LED lamp, for it may damage related parts of the vehicle.

Side repeater lamp replacement



1 Side repeater lamp (LED type)

If the LED lamp does not operate, have the system inspected by an authorized Kia dealer.

The LED lamps cannot be replaced as a single unit because it is an integrated unit. The LED lamps has to be replaced with the unit.

A skilled technician should check or repair the LED lamp, for it may damage related parts of the vehicle.

Replacing high mounted stop lamp (LED type)



If the high mounted stop lamp (LED) does not operate, have your vehicle checked by an authorized Kia dealer.

The LED lamp cannot be replaced as a single component because it is an integrated unit. The LED lamp has to be replaced with the unit.

A skilled technician should check or repair the high mounted stop lamp (LED), for it may damage related parts of the vehicle.

Glove box lamp (Bulb type) replacement



1. Using a flat-blade screwdriver, gently pry the lamp assembly from interior.
2. Remove the cover from the lamp assembly.
3. Remove the bulb by pulling it straight out.
4. Install a new bulb in the socket.
5. Install the cover to the lamp assembly.
6. Install the lamp assembly to interior.

⚠ WARNING

Prior to working on the Interior lamps, ensure that the "OFF" button is depressed to avoid burning your fingers or receiving an electric shock.

Appearance care

Use the information in the following sections to keep the exterior and interior of your vehicle clean.

Exterior care

Use the information in the following sections to maintain the exterior of your vehicle. Keeping the exterior clean is not only aesthetically pleasing, but it also helps to prolong the life of the vehicle.

*** NOTICE**

If you park the vehicle around a stainless steel signboard or building windshield etc., the plastic exterior trim (bumper, spoiler, garnish, lamp, outside mirror etc.) may be damaged by reflected sunlight from the external structure. To avoid damaging the plastic exterior trim, park the vehicle away from the areas where the reflected light may occur or use a vehicle cover (Depending on the vehicle, the type of exterior trim applied such as spoiler may differ).

Exterior general caution

It is very important to follow the label directions when using any chemical cleaner or polish. Read all warning and caution statements that appear on the label.

Finish maintenance

Washing

To help protect your vehicle's finish from rust and deterioration, wash it thoroughly and frequently at least once a month with lukewarm or cold water.

If you use your vehicle for off-road driving, you should wash it after each off-

road trip. Pay special attention to the removal of any accumulation of salt, dirt, mud, and other foreign materials. Make sure the drain holes in the lower edges of the doors and rocker panels are kept clear and clean.

Insects, tar, tree sap, bird droppings, industrial pollution and similar deposits can damage your vehicle's finish if not removed immediately.

Even prompt washing with plain water may not completely remove all these deposits. A mild soap, safe for use on painted surfaces, may be used.

After washing, rinse the vehicle thoroughly with lukewarm or cold water. Do not allow soap to dry on the finish.

After washing the vehicle, test the brakes while driving slowly to see if they have been affected by water. If braking performance is impaired, dry the brakes by applying them lightly while maintaining a slow forward speed.

⚠ CAUTION

- Do not use strong soap, chemical detergents or hot water, and do not wash the vehicle in direct sunlight or when the body of the vehicle is warm.
- Be careful when washing the side windows and other gaps (between door and body structure, side windows and exterior) of your vehicle. Especially with high-pressure water. Water may leak through the windows and wet the interior.
- To prevent damage to the plastic parts and lamps, do not clean with chemical solvents or strong detergents.

High-pressure washing

When using high-pressure washers, make sure to maintain sufficient distance from the vehicle.

Insufficient clearance or excessive pressure can lead to component damage or water penetration.

Do not spray the camera, sensors or its surrounding area directly with a high pressure washer. Shock applied from high pressure water may cause the device to not operate normally.

Do not bring the nozzle tip close to boots (rubber including weather strips or plastic covers) or connectors as they may be damaged if they come into contact with high pressure water.

⚠ WARNING

After washing the vehicle, test the brakes while driving slowly to see if they have been affected by water. If braking performance is impaired, dry the brakes by applying them lightly while maintaining a slow forward speed.

⚠ CAUTION

Wetting motor compartment



- Water washing in the motor compartment including high pressure water washing may cause the failure of electrical circuits located in the motor compartment.
- Never allow water or other liquids to come in contact with electrical/elec-

tronic components inside the vehicle as this may damage them.

- To prevent damage to the charging door, make sure to close and lock the vehicle doors when washing (high-pressure washing, automatic car washing, etc.) the vehicle.

* NOTICE

Matte paint finish vehicle (if equipped)

Automatic car wash which uses rotating brushes should not be used as this can damage the surface of your vehicle. A steam cleaner which washes the vehicle surface at high temperature may cause the oil to adhere and leave stains that are difficult to remove.

Use a soft cloth (e.g. microfiber towel or sponge) when washing your vehicle and dry with a microfiber towel. When you hand wash your vehicle, you should not use a cleaner that finishes with wax.

Waxing

Wax the vehicle when water will no longer bead on the paint.

Always wash and dry the vehicle before waxing. Use a good quality liquid or paste wax, and follow the manufacturer's instructions. Wax all metal trim to protect it and to maintain its luster.

Removing oil, tar, and similar materials with a spot remover will usually strip the wax from the finish. Be sure to re-wax these areas even if the rest of the vehicle does not yet need waxing.

⚠ CAUTION

Drying vehicle

- Wiping dust or dirt off the body with a dry cloth will scratch the finish.
- Do not use steel wool, abrasive cleaners, acid detergents or strong detergents containing high alkaline or caustic agents on chrome-plated or anodized aluminum parts. This may result in damage to the protective coating and cause discoloration or paint deterioration.

* NOTICE

Matte paint finish vehicle (if equipped)

Do not use any polish protector such as a detergent, an abrasive or a polish. In case wax is applied, remove the wax immediately using a silicon remover and if any tar or tar contaminant is on the surface use a tar remover to clean. However, be careful not to apply too much pressure on the painted area.

Finish damage repair

Deep scratches or stone chips in the painted surface must be repaired promptly. Exposed metal will quickly rust and may develop into a major repair expense.

* NOTICE

If your vehicle is damaged and requires any metal repair or replacement, be sure the body shop applies anti-corrosion materials to the parts repaired or replaced.

* NOTICE

Matte paint finish vehicle (if equipped)

In case of matte paint finish vehicles, it is impossible to modify only the damaged area and repair of the whole part is necessary. If the vehicle is damaged and painting is required, have your vehicle maintained and repaired by an authorized Kia dealer. Take extreme care, as it is difficult to restore the quality after the repair.

Bright-metal maintenance

To remove road tar and insects, use a tar remover, not a scraper or other sharp object.

To protect the surfaces of bright metal parts from corrosion, apply a coating of wax or chrome preservative and rub to a high luster.

During winter weather or in coastal areas, cover the bright metal parts with a heavier coating of wax or preservative. If necessary, coat the parts with non-corrosive petroleum jelly or other protective compound.

Underbody maintenance

Road salt and other corrosive chemicals are used in cold weather states to melt snow and prevent ice accumulation. If these chemicals are not regularly removed, they will corrode the vehicle underbody and over time damage the vehicle suspension, and even the body frame.

Aluminum wheel maintenance

The aluminum wheels are coated with a clear protective finish.

- Do not use any abrasive cleaner, polishing compound, solvent, or wire brushes on aluminum wheels. They may scratch or damage the finish.
- Clean the wheel when it has cooled.
- Use only a mild soap or neutral detergent, and rinse thoroughly with water. Also, be sure to clean the wheels after driving on salted roads. This helps prevent corrosion.
- Avoid washing the wheels with high-speed vehicle wash brushes.
- Do not use any alkaline or acid detergents. It may damage and corrode the aluminum wheels coated with a clear protective finish.

Corrosion protection

Protecting your vehicle from corrosion

By using the most advanced design and construction practices to combat corrosion, we produce vehicles of the highest quality. However, this is only part of the job. To achieve the long-term corrosion resistance your vehicle can deliver, the owner's cooperation and assistance is also required.

Common causes of corrosion

The most common causes of corrosion on your vehicle are:

- Road salt, dirt and moisture that is allowed to accumulate underneath the vehicle.
- Removal of paint or protective coatings by stones, gravel, abrasion or minor scrapes and dents which leave

unprotected metal exposed to corrosion.

High-corrosion areas

If you live in an area where your vehicle is regularly exposed to corrosive materials, corrosion protection is particularly important. Some of the common causes of accelerated corrosion are road salts, dust control chemicals, ocean air and industrial pollution.

Moisture breeds corrosion

Moisture creates the conditions in which corrosion is most likely to occur. For example, corrosion is accelerated by high humidity, particularly when temperatures are just above freezing. In such conditions, the corrosive material is kept in contact with the vehicle's surface by moisture that evaporates slowly.

Mud is particularly corrosive because it dries slowly and holds moisture in contact with the vehicle. Although the mud appears to be dry, it can still retain the moisture and promote corrosion.

High temperatures can also accelerate corrosion of parts that are not properly ventilated so the moisture can be dispersed. For all these reasons, it is particularly important to keep your vehicle clean and free of mud or accumulations of other materials. This applies not only to the visible surfaces but particularly to the underside of the vehicle.

To help prevent corrosion

You can help prevent corrosion from beginning by observing the following:

Keep your vehicle clean

The best way to prevent corrosion is to keep your vehicle clean and free of corrosive materials. Attention to the underside of the vehicle is particularly important.

If you live in a high-corrosion area — where road salts are used, near the ocean, areas with industrial pollution, acid rain, etc.—, you should take extra care to prevent corrosion. In winter, hose off the underside of your vehicle at least once a month and be sure to clean the underside thoroughly when winter is over.

When cleaning underneath the vehicle, give particular attention to the components under the fenders and other areas that are hidden from view. Do a thorough job; just dampening the accumulated mud rather than washing it away will accelerate corrosion rather than prevent it. Water under high pressure and steam are particularly effective in removing accumulated mud and corrosive materials.

When cleaning lower door panels, rocker panels and frame members, be sure that drain holes are kept open so that moisture can escape and not be trapped inside to accelerate corrosion.

Keep your garage dry

Don't park your vehicle in a damp, poorly ventilated garage. This creates a favorable environment for corrosion.

This is particularly true if you wash your vehicle in the garage or drive it into the garage when it is still wet or covered with snow, ice or mud. Even a heated garage can contribute to corrosion unless it is well ventilated so moisture is dispersed.

Keep paint and trim in good condition

Scratches or chips in the finish should be covered with "touch-up" paint as soon as possible to reduce the possibility of corrosion. If bare metal is showing through, the attention of a qualified body and paint shop is recommended.

Bird droppings: Bird droppings are highly corrosive and may damage painted surfaces in just a few hours. Always remove bird droppings as soon as possible.

Don't neglect the interior

Moisture can collect under the floor mats and carpeting and cause corrosion. Check under the mats periodically to be sure the carpeting is dry. Use particular care if you carry fertilizers, cleaning materials or chemicals in the vehicle.

These should be carried only in proper containers and any spills or leaks should be cleaned up, flushed with clean water and thoroughly dried.

Interior care

Use the information in the following sections to maintain the interior of your vehicle.

Interior general precautions

⚠ CAUTION

Prevent chemicals such as perfume, cosmetic oil, sun cream, hand cleaner, and air freshener from contacting the interior parts because they may cause damage or discoloration. If they do contact the interior parts, wipe them off immediately. If necessary, use a mixture of warm water and mild non-detergent cleaner (test all cleaners on a concealed

area before use). Use proper car cleaner to clean interior parts.

⚠ CAUTION

Electrical components

Never allow water or other liquids to come in contact with electrical/electronic components inside the vehicle as this may damage them.

⚠ CAUTION

Leather

When cleaning leather products (steering wheel, seats etc.), use neutral detergents or low alcohol content solutions. If you use high alcohol content solutions or acid/alkaline detergents, the color of the leather may fade or the surface may get stripped off.

Taking care of leather seats

- Vacuum the seat periodically to remove dust and sand on the seat. It will prevent abrasion or damage of the leather and maintain its quality.
- Wipe the leather seat cover often with dry or soft cloth.
- Sufficient use of a leather protective may prevent abrasion of the cover and helps maintain the color. Be sure to read the instructions and consult a specialist when using leather coating or protective agents.
- Leather with bright colors (beige, cream beige) is easily contaminated and clear in appearance. Clean the seats frequently.
- Avoid wiping with wet cloth. It may cause the surface to crack.

Cleaning the leather seats

Remove all contaminations instantly. Refer to instructions below for removal of each contaminant.

- Cosmetic products (sunscreen, foundation, etc.)
 - Apply cleansing cream on a cloth and wipe the contaminated point. Wipe off the cream with a wet cloth and remove water with a dry cloth.
- Beverages (coffee, soft drink, etc.)
 - Apply a small amount of neutral detergent and wipe until contaminations do not smear.
- Oil
 - Remove oil instantly with absorbable cloth and wipe with stain remover for leather only.
- Chewing gum
 - Harden the gum with ice and remove gradually.

Fabric seat cover (if equipped)

Please clean the fabric seats regularly with a vacuum cleaner in consideration of fabric material characteristics. If they are heavily soiled with beverage stains, etc., use a suitable interior cleaner. To prevent damage to seat covers, wipe off the seat covers down to the seams with a large wiping motion and moderate pressure using a soft sponge or microfibre cloth.

Velcro closures on clothing or sharp objects may cause snagging or scratches on the surface of the seats.

Make sure not to rub such objects against the surface.

Cleaning the upholstery and interior trim

Car interior surfaces

Remove dust and loose dirt from interior surfaces with a whisk broom or a vacuum cleaner. If necessary, clean interior surfaces with a mixture of warm water and mild non-detergent cleaner (test all cleaners on a concealed area before use).

Fabric

Remove dust and loose dirt from fabric with a whisk broom or vacuum cleaner. Clean with a mild soap solution recommended for upholstery or carpets. Remove fresh spots immediately with a fabric spot cleaner. If fresh spots do not receive immediate attention, the fabric can be stained and its color can be affected. Also, its fire-resistant properties can be reduced if the material is not properly maintained.

Using anything but recommended cleaners and procedures may affect the fabric's appearance and fire-resistant properties.

Cleaning the lap/shoulder belt webbing

Clean the belt webbing with any mild soap solution recommended for cleaning upholstery or carpet. Follow the instructions provided with the soap. Do not bleach or re-dye the webbing because this may weaken it.

Cleaning the interior window glass

If the interior glass surfaces of the vehicle become fogged (that is, covered with an oily, greasy or waxy film), they should be cleaned with a glass cleaner. Follow the directions on the glass cleaner container.

CAUTION

Rear Window

Do not scrape or scratch the inside of the rear window. This may result in damage of the rear window defroster grid.

Specifications & Consumer information **10**

Dimensions	10-2
Electric vehicle specifications	10-2
Available front trunk weight.....	10-3
Bulb wattage	10-3
Tires and wheels	10-4
Vehicle weight	10-5
Luggage volume	10-5
Air conditioning system.....	10-5
Recommended lubricants and capacities	10-6
Vehicle identification number (VIN)	10-7
Vehicle certification label.....	10-7
Tire specification and pressure label.....	10-7
Motor number	10-8
Air conditioner compressor label	10-8
Reporting safety defects	10-8

Specifications & Consumer information

Dimensions

Item		inches (mm)	
Overall length	Type A	184.3 (4,680)	
	Type B (GT-Line)	184.8 (4,695)	
	Type C (GT)	184.8 (4,695)	
Overall width	Type A	74.0 (1,880)	
	Type B (GT-Line)	74.4 (1,890)	
	Type C (GT)	74.4 (1,890)	
Overall height	Type A, Type B (GT-Line), Type C (GT)	60.8 (1,545)	
Tread	Front	235/55 R19	64.2 (1,630)
		255/45 R20	64.0 (1,625)
		255/40 R21	64.1 (1,628)
	Rear	235/55 R19	64.6 (1,640)
		255/45 R20	64.4 (1,635)
		255/40 R21	64.4 (1,637)
Wheelbase		114.2 (2,900)	

Electric vehicle specifications

OBC: On-Board Battery Chargers

Items			Standard type		Extended type		Extended type (GT)
			2WD	AWD	2WD	AWD	AWD
Motor	Max. output (kW)	Front	-	53	-	74	160
		Rear	125	120	168	165	270
	Max. torque (Nm)	Front	-	255	-	255	350
		Rear	350	350	350	350	390
Battery (Lithium-ion)	Capacity (kWh)		58	-	77.4		77.4
	Power output (kW)		195	-	277		481(discharge) / 384(charge)
	Voltage (V)		523	-	697		697
Charger (OBC)	Max. output (kW)	AC single phase	10.9		10.9		10.9

Available front trunk weight

2WD	AWD
25 lbs. (10 kg)	25 lbs. (10 kg)

Bulb wattage

	Light bulb	Bulb type	Wattage (Watt)
Front	High beam	LED	LED
	Low beam	LED	LED
	Position and daytime running lamps	LED	LED
	Turn signal lamps	LED	LED
	Front side marker lamps	LED	LED
	Front trunk lamp	LED	LED
Rear	Stop and tail lamps	LED	LED
	Turn signal lamps	LED	LED
	Backup lamps	LED	LED
	Rear side marker lamps	LED	LED
	High mounted stop lamp	LED	LED
	License plate lamps	LED	LED
Interior	Map lamps	LED	LED
	Room lamps	LED	LED
	Vanity mirror lamps	LED	LED
	Glove box lamp	W5W	5W
	Luggage lamp	LED	LED

Tires and wheels

*1. Load Index

*2. Speed Symbol

Item	Tire size	Wheel size	Load capacity		Speed capacity		Inflation pressure [bar (psi, kPa)]		Wheel lug nut torque kg·m (lbf·ft, N·m)
			L ¹	kg	SS ²	km/h	Front	Rear	
Full size tire	235/55R19	7.5J X 19"	101	825	H	210	2.5 (36, 250)		11-13 (79-94, 107-127)
	255/45R20	8.0J X 20"	105	925					
	255/40R 21	8.5J X 21"	102	850	Y	300	2.35 (34, 235)	2.7 (39, 270)	

CAUTION

When replacing tires, use the same size as those originally supplied with the vehicle.

Using tires of a different size can damage the related parts or make them work irregularly.

NOTICE

- It is permissible to add 3 psi to the standard tire pressure specification if colder temperatures are expected soon.
Tires typically loose 1 psi for every 12 °F temperature drop. If extreme temperature variations are expected, recheck your tire pressure as necessary to keep them properly inflated.
- We recommend that when replacing tires, use the same originally supplied with the vehicles. If not, that affects driving performance.
- When driving in high altitude grades, it is natural for the atmospheric pressure to decrease. Therefore, please check the tire pressure and add more air when necessary.

Additionally required tire air pressure per km above sea level: 1.5 psi (10.5 kPa)/km

Vehicle weight

Item		Gross vehicle weight [lbs. (kg)]
Standard type	2WD	5,004 lbs. (2,270 kg)
	2WD	5,335 lbs. (2,420 kg)
Extended type	AWD	5,556 lbs. (2,520 kg)
	AWD	5,732 lbs. (2,600 kg)
Extended range (GT)		5,732 lbs. (2,600 kg)

Luggage volume

- MIN: Behind rear seat
- MAX: Behind front seat

Item		Luggage Volume		
		Type A	Type B (GT-Line)	Type C (GT)
Luggage volume (SAE) [cu ft (L)]	MIN.	24.4 cu ft. (690 L)		
	MAX.	46.7 cu ft. (1,322 L)	48.0 cu ft. (1,360 L)	

Air conditioning system

Have your vehicle inspected by an authorized Kia dealer.

Item		Weight of volume (g)	Classification
Refrigerant	With heat pump	850±25	R-1234yf
	Without heat pump	750±25	R-1234yf
Compressor lubricant		180±10	POE

Recommended lubricants and capacities

To help achieve proper vehicle performance and durability, use only lubricants of the proper quality. These lubricants and fluids are recommended for use in your vehicle.

Lubricant		Volume	Classification
Reduction gear fluid	2WD	Rear	3.59-3.70 US qt. (3.4 ~ 3.5 L)
	AWD	Front	3.38-3.49 US qt. (3.2 ~ 3.3 L)
		Rear	3.59-3.70 US qt. (3.4 ~ 3.5 L)
Brake fluid		As required	SAE J1704 DOT-4 LV, FMVSS 116 DOT-4, ISO4925 CLASS-6
Coolant	Standard type	2WD	18.70 US qt. (17.7 L)
		AWD	18.91 US qt. (17.9 L)
	Extended type	2WD	20.50 US qt. (19.4 L)
		AWD	20.71 US qt. (19.6 L)
			An Phosphate based ethylene glycol based coolant

Vehicle identification number (VIN)

The vehicle identification number (VIN) is the number used in registering your vehicle and in all legal matters pertaining to its ownership, etc.

The number is punched on the floor under the passenger seat. To check the number, open the cover.

Frame number



The VIN is also on a plate attached to the top of the dashboard. The number on the plate can easily be seen through the windshield from outside.

VIN label



Vehicle certification label

The vehicle certification label attached on the driver's side center pillar gives the vehicle identification number (VIN).



Tire specification and pressure label

The tire label located on the driver's side center pillar gives the tire pressures recommended for your vehicle.



The tires supplied on your new vehicle are chosen to provide the best performance for normal driving.

Motor number

The motor number is stamped on the motor block as shown in the drawing. The motor number can be seen from under the vehicle.

Rear



OCV081004L

Front (if equipped)



OCV081005L

Air conditioner compressor label

A compressor label informs you of the type of compressor your vehicle is equipped with such as model, supplier part number, production number, refrigerant (1) and refrigerant oil (2).



OCV081006L

Reporting safety defects

If you believe that your vehicle has a defect which could cause a crash or could cause injury or death, you should immediately inform Transport Canada (TC) in addition to notifying **Kia Canada Inc.**

Mailing Address:

Transport Canada - ASFAD

330 Sparks Street

Ottawa, ON

K1A 0N5

Telephone: 819-994-3328 (Ottawa-Gatineau area or internationally)

Toll free: 1-800-333-0510 (in Canada)

Online:

<http://www.tc.gc.ca/recalls>

If TC receives similar complaints, it may open an investigation, and if it finds that a safety defect exists in a group of vehicles, it may order a recall and remedy campaign. However, TC cannot become involved in individual problems between you, your dealer, or **Kia Canada Inc.**

Abbreviation **A**

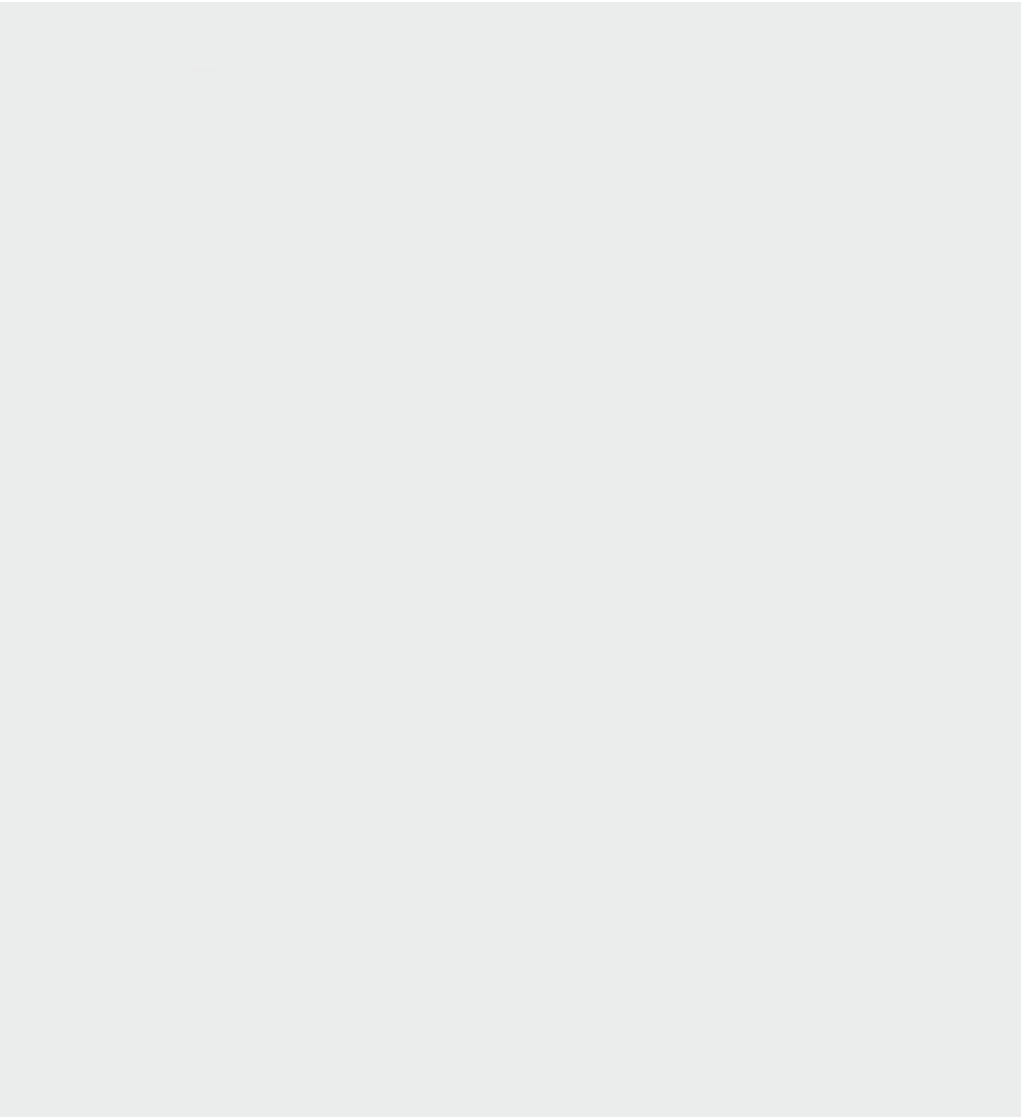

Abbreviation

ABS

Anti-lock Brake System

BCM

Body Control Module

BCW

Blind-spot Collision Warning

CRS

Child Restraint System

DAW

Driver Attention Warning

DRL

Day time Running Light

EBD

Electronic Brake force Distribution

ECM

Electric Chromic Mirror

EDR

Event Data Recorder

EFD

Emergency fastening device

EPB

Electronic Parking Brake

EPS

Electric Power Steering

ESC

Electronic Stability Control

EV

Electric Vehicle

FCA

Forward Collision-Avoidance Assist

FMVSS

Federal Motor Vehicle Safety Standards

HAC

Hill-start Assist Control

HBA

High Beam Assist

HMSL

High Mounted Stop Lamp

HV

High Voltage

ICCB

In-Cable Control Box

LATCH

Lower Anchors and Tether for Children

LDC

Low voltage DC-DC Converter

LFA

Lane Following Assist

LKA

Lane Keeping Assist

MIL

Malfunction Indicator Lamp

MMT

Methylcyclopentadienyl Manganese Tricarbonyl

OBC

On-board Battery Chargers

Abbreviation

ODS

Occupant Detection System

RCCA

Rear Cross-traffic Collision-avoidance Assist

RCCW

Rear Cross-traffic Collision Warning

SCC

Smart Cruise Control

SOC

State Of Charge

SRS

Supplemental Restraint System

SRSCM

SRS Control Module

TBT

Turn By Turn

TIN

Tire Identification Number

TMK

Tire Mobility Kit

TPMS

Tire Pressure Monitoring System

VCU

Vehicle Control Unit

VESS

Virtual Engine Sound System

VIN

Vehicle Identification Number

VSM

Vehicle Stability Management

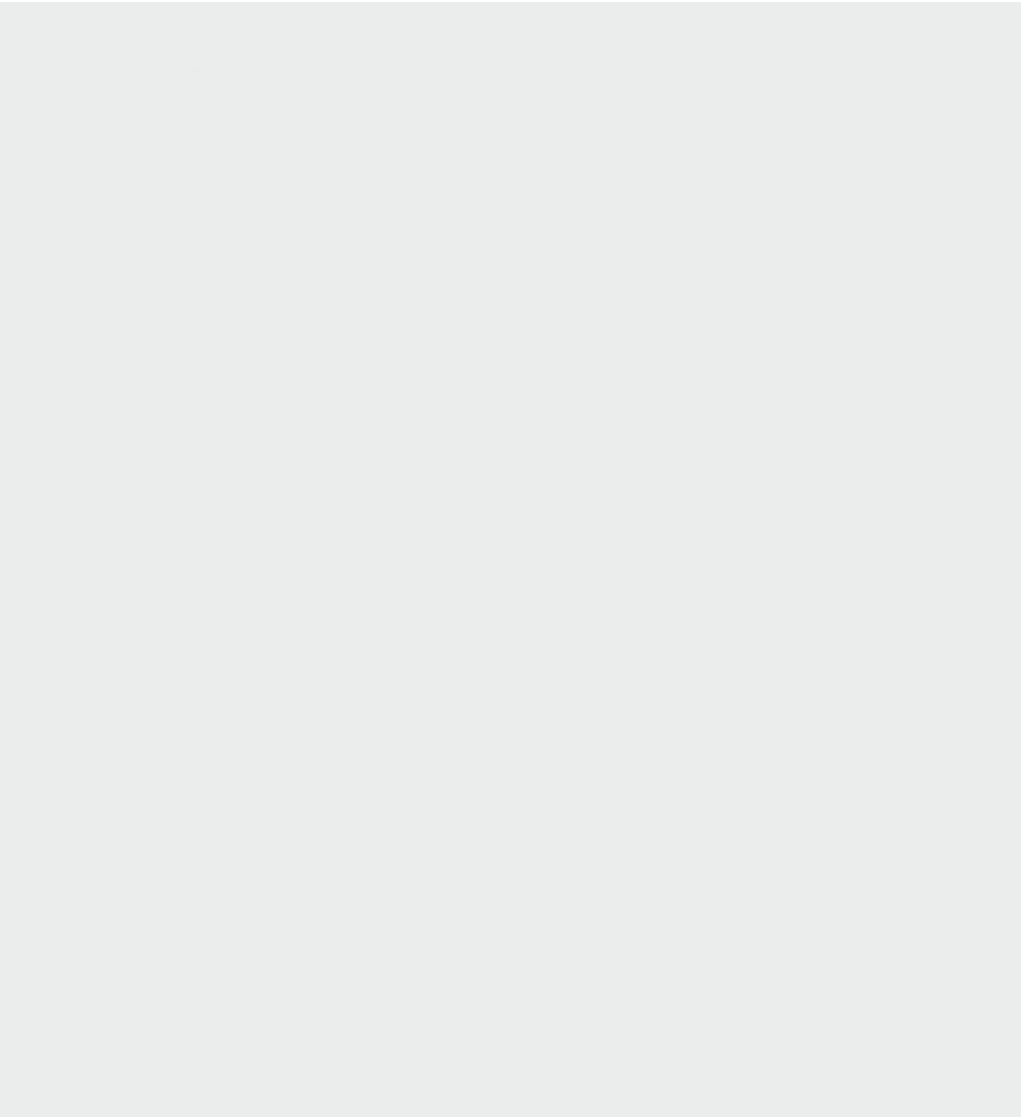

Index

Numerics

12v battery	9-16
360° camera monitoring system	7-99
malfunction and limitations	7-103
operation	7-101
settings	7-99

A

A/C automatic drying	5-111
active air flap	6-45
malfunction	6-45
air bag warning label	4-50
air bag warning light	4-34
air bags	4-32
adding equipment to or modifying your vehicle	4-50
air bag collision sensors	4-46
air bag warning label	4-50
air bag warning light	4-34
curtain air bag	4-45
driver's and passenger's front air bag	4-41
how air bags operate	4-33
inflation and non-inflation conditions	4-47
inflation conditions	4-47
non-inflation conditions	4-48
occupant detection system (ODS)	4-36
side air bag	4-43
SRS care	4-49
SRS components and functions	4-35
air conditioner compressor label	10-8
air ventilation seat	5-114
all wheel drive (AWD)	6-42
emergency precautions	6-44
for safe AWD operation	6-42
ambient light	5-113
anti-lock brake system (ABS)	6-30
appearance care	9-41
exterior care	9-41
interior care	9-46
armrest	4-16

audio system	5-121
how vehicle radio works	5-122
USB port	5-121
using the infotainment/climate switchable controller	5-122
augmented reality HUD	5-83
head-up display information	5-84
head-up display settings	5-83
precautions	5-84
auto defogging system (ADS)	5-110
auto hold	6-27
automatic climate control system	5-98
checking the amount of air conditioner refrigerant and compressor lubricant	5-107
climate control air filter	5-107
heating and air conditioning automatically	5-99
heating and air conditioning manually	5-101
system operation	5-105
using the infotainment/climate switchable controller	5-99
aux. battery saver+	1-43

B

battery	
for best battery service	9-16
recharging the battery	9-17
reset items	9-18
battery saver function	5-86
before driving	6-3
blind-spot collision-avoidance assist (BCA)	7-28
malfunction and limitations	7-35
operation	7-32
settings	7-30
blind-spot view monitor (BVM)	7-61
malfunction	7-62
operation	7-61
settings	7-61
Brake Assistant System (BAS)	6-34
brake fluid	9-12
checking the brake fluid level	9-12
brake system	6-20

anti-lock brake system (ABS)	6-30
auto hold	6-27
Brake Assistant System (BAS)	6-34
electronic parking brake (EPB)	6-22
electronic stability control (ESC)	6-31
hill-start assist control (HAC)	6-34
power brakes	6-20
vehicle stability management (VSM)	6-33
bulb replacement precaution	9-38

C

cargo security screen	5-121
center console storage	5-112
certification label	6-63
charge indicator lamp for electric vehicle	1-18
charging status	1-18
charge types for electric vehicle	1-16
charging information	1-16
charging time information	1-16
charging types	1-17
charging connector lock	1-19
locking charging cable	1-19
charging door	5-42
opening and closing the charging door	5-42
charging electric vehicle	1-21
ac charge	1-24
dc charge	1-28
electric charging door	1-21
portable charge	1-30
precautions for charging electric vehicle	1-22
unlock charging connector	
in emergency	1-23
charging electric vehicle (abrupt stop)	1-38
actions to be taken	1-38
charging inlet lamp	5-95
child restraint system (CRS)	4-25
children always in the rear	4-25
installing a CRS	4-27
selecting a CRS	4-26
child-protector rear door lock	5-21
climate control air filter	9-14

inspecting and replacing climate control air filter	9-14
coat hook	5-119
coolant	9-11
cup holder	5-113
curtain air bag	4-45

D

day/night rear view mirror	5-50
daytime running light (DRL)	5-86
declaration of conformity	5-125, 7-148
defroster	5-97
operating rear window defroster	5-97
outside mirror defroster	5-97
door locks	5-15
child-protector rear door lock	5-21
door lock/unlock features	5-20
electronic child safety lock	5-21
in case of an emergency	5-19
operating door locks from inside the vehicle	5-18
operating door locks from outside the vehicle	5-16
operating door unlocks from outside the vehicle	5-15
rear occupant alert (ROA)	5-22
drift mode	6-40
drive mode	6-37
drive mode integrated control system	6-37
drive mode	6-37
driver attention warning (DAW)	7-55
malfunction and limitations	7-59
operation	7-56
settings	7-56
driver position memory system	5-23
recalling memory positions	5-24
resetting memory positions	5-24
seat easy access	5-25
storing memory positions	5-23
driver's and passenger's front air bag	4-41
driving electric vehicle	1-39
aux. battery saver+	1-43
distance to empty	1-40

eco driving	1-41
electricity use	1-42
how to start the vehicle	1-39
how to stop the vehicle	1-39
lcd display messages (related to electric vehicle)	1-45
power/charge gauge	1-42
state of charge (soc) gauge for high voltage battery	1-42
virtual engine sound system (VESS)	1-39
warning and indicator lights (related to electric vehicle)	1-44

E

electric chromic mirror (ECM)	5-50
electric chromic mirror (ECM) with HomeLink® system	5-50
electronic child safety lock	5-21
electronic limited slip differential	6-35, 6-36
electronic parking brake (EPB)	6-22
electronic stability control (ESC)	6-31
emergency liftgate safety release	5-26
emergency starting	8-4
emergency while driving	8-2
EV button	6-4
starting the vehicle	6-5
turning off the vehicle	6-6
EV menu	1-5
charging and climate	1-8
energy information	1-7
EV mode screen	1-6
EV settings	1-13
nearby stations	1-13
next departure	1-7
vehicle to load (V2L)	1-9
ev settings	
battery conditioning mode	1-14
explanation of scheduled maintenance items	9-10
exterior overview	3-2

F

flat tire (with tire mobility kit)	8-10
checking the tire inflation pressure	8-15
components of the tire mobility kit	8-13
distributing the sealant	8-15
introduction	8-11
notes on the safe use of the tire mobility kit	8-11
technical data	8-16
using the tire mobility kit	8-14
floor mat anchor(s)	5-120
forward collision-avoidance assist (FCA)	7-4
malfunction and limitations	7-16
operation	7-9
settings	7-7
forward/reverse parking distance warning (PDW)	7-115
malfunction and precautions	7-118
operation	7-116
settings	7-116
front trunk	5-41
closing the front trunk	5-41
opening the front trunk	5-41
fuses	9-28
fuse/relay panel description	9-31
replacing inner panel fuse	9-29
replacing motor compartment fuse	9-30

G

gauges	5-62
glove box	5-112
glove box lamp	5-95

H

hazard warning flasher	8-2
headlight escort function	5-86
headrest (for front seat)	4-13
headrest (for rear seats)	4-15
heated steering wheel	5-48
high beam assist (HBA)	5-89
high voltage cut-off switch	1-52
highway driving assist (HDA)	7-86
malfunction and limitations	7-94

operation	7-88	seat warmer	5-113
settings	7-87	sun visor	5-115
hill-start assist control (HAC)	6-34	USB charger	5-116
hood	5-39	wireless smart phone charging system	5-117
closing the hood	5-40	interior lights	5-94
hood open warning	5-40	automatic turn off function	5-94
opening the hood	5-39	charging inlet lamp	5-95
horn	5-49	glove box lamp	5-95
		liftgate room lamp	5-95
		map lamp	5-94
		room lamp	5-94
		vanity mirror lamp	5-95
		interior overview	3-8
I		K	
if an accident occurs	1-50, 8-18	keys	5-6
immobilizer system	5-12	immobilizer system	5-12
important safety precautions	4-3	smart key	5-7
indicator lights	5-80	theft-alarm system	5-13
inside rear view mirror	5-49		
day/night rear view mirror	5-50	L	
electric chromic mirror (ECM)	5-50	lane following assist (LFA)	7-83
electric chromic mirror (ECM) with HomeLink® system	5-50	malfunction and limitations	7-85
installing a CRS	4-27	operation	7-84
securing a child restraint seat with tether anchor	4-29	settings	7-83
securing a child restraint with a lap/shoulder belt	4-30	lane keeping assist (LKA)	7-23
securing a child restraint with the LATCH anchors	4-28	malfunction and limitations	7-26
instrument cluster	5-61	operation	7-25
gauges	5-62	settings	7-23
instrument panel illumination control	5-62	LCD display	5-65
instrument panel illumination control	5-62	LCD display control	5-65
instrument panel overview	3-10	LCD display modes	5-65
intelligent speed limit assist (ISLA)	7-50	LCD display modes	5-65
malfunction and limitations	7-53	driver assistance settings (infotainment system)	5-69
operation	7-52	driving assist mode	5-66
settings	7-50	electric energy economy	5-66
interior features	5-113	information mode	5-68
air ventilation seat	5-114	master warning mode	5-68
ambient light	5-113	service Interval	5-69
cargo security screen	5-121	trip computer mode	5-67
coat hook	5-119	turn by turn (TBT) mode	5-68
cup holder	5-113	vehicle settings (infotainment system)	5-69
floor mat anchor(s)	5-120	liftgate	5-25
luggage net holder	5-120		
power outlet	5-115		

closing the liftgate	5-26
emergency liftgate safety release	5-26
opening the liftgate	5-25
liftgate room lamp	5-95
light bulbs	9-38
bulb replacement precaution	9-38
glove box lamp (bulb type)	
replacement	9-41
light position (front)	9-39
light position (rear)	9-39
replacing lights (LED type, except glove box lamp)	9-40
side repeater lamp replacement	9-40
lighting	5-86
battery saver function	5-86
daytime running light (DRL)	5-86
headlight escort function	5-86
high beam assist (HBA)	5-89
lighting control	5-87
one-touch lane change	5-89
operating high beam	5-88
operating turn signals and lane change signals	5-88
luggage board	5-112
luggage net holder	5-120

M

main components of electric vehicle	1-3
high voltage battery warmer system	1-5
high voltage (hv) battery (lithium-ion)	1-4
maintenance services	9-4
manual speed limit assist (MSLA)	7-48
operation	7-48
map lamp	5-94
maximum power output mode	6-41
mirrors	5-49
inside rear view mirror	5-49
outside rear view mirror	5-58
motor number	10-8
motor room compartment	3-12, 9-3

N

navigation-based smart cruise control (NSCC)	7-77
limitations	7-80
operation	7-78
settings	7-78

O

occupant detection system (ODS)	4-36
odometer	5-64
one-touch lane change	5-89
outside rear view mirror	5-58
adjusting the outside rear view mirrors	5-58
folding the outside rear view mirror	5-59
reverse parking aid function	5-59
outside temperature gauge	5-63
overview of electric vehicle	1-3
battery information	1-3
owner maintenance	9-5

P

power button	
power button position	6-4
power button position	6-4
power outlet	5-115
power window lock button	5-37
precautions for charging electric vehicle	1-22
pre-tensioner seat belt	4-21

R

rear cross-traffic collision-avoidance assist (RCCA)	7-104
malfunction and limitations	7-108
operation	7-105
settings	7-104
rear occupant alert (ROA)	5-22
rear view monitor (RVM)	7-96
malfunction and limitations	7-98
operation	7-97
settings	7-96

reduction gear	6-6	headrest (for front seat)	4-13
good driving practices	6-11	headrest (for rear seats)	4-15
LCD display messages	6-9	infotainment system	4-8
operation	6-6	seatback pocket	4-10
parking	6-9	seat belt precautions	4-22
remote smart parking assist (RSPA)	7-126	seat belt restraint system	4-17
malfunction and limitations	7-144	seat belt warning light	4-18
operation	7-129	seat belts	4-17
settings	7-128	care of seat belts	4-24
reporting safety defects	10-8	driver's 3-point system with emergency locking retractor	4-18
reverse parking collision-avoidance assist (PCA)	7-120	front passenger and rear seat 3-point system with combination locking retractor	4-20
malfunction and limitations	7-122	pre-tensioner seat belt	4-21
operation	7-121	seat belt precautions	4-22
settings	7-120	seat belt restraint system	4-17
reverse parking distance warning (PDW)	7-112	seat belt warning light	4-18
malfunction and precautions	7-113	seat warmer	5-113
operation	7-113	securing a child restraint seat with tether anchor	4-29
settings	7-112	securing a child restraint with a lap/shoulder belt	4-30
road warning	8-2	securing a child restraint with the LATCH anchors	4-28
room lamp	5-94	side air bag	4-43
<hr/>			
S		smart cruise control (SCC)	7-62
safe exit assist (SEA)	7-43	malfunction and limitations	7-72
malfunction and limitations	7-46	settings	7-63, 7-67
operation	7-44	smart key	5-7
settings	7-43	smart key precautions	5-11
safe exit warning (SEW)	7-39	smart key precautions	5-11
malfunction and limitations	7-41	smart liftgate with auto open	5-31
operation	7-40	deactivating smart liftgate	5-33
settings	7-39	detecting area	5-33
safety precautions for electric vehicle	1-50	using smart liftgate	5-32
high voltage cut-off switch	1-52	smart regeneration system	6-15
if an accident occurs	1-50	activation	6-15
other precautions for electric vehicle	1-51	limitation	6-17
scheduled charging	1-20	malfunction	6-17
scheduled maintenance service	9-7	resuming	6-16
seat	4-5	setting	6-15
armrest	4-16	turning off	6-16
feature of seat leather	4-7	smart ventilation	5-110
folding the rear seat	4-11	special driving conditions	6-47
front seat adjustment for manual seat	4-8	specifications	
front seat adjustment for power seat	4-9	air conditioning system	10-5

available front trunk weight	10-3	tire rotation	9-20
bulb wattage	10-3	tire sidewall labeling	9-21
dimensions	10-2	tire terminology and definitions	9-24
electric vehicle specifications	10-2	tire traction	9-21
luggage volume	10-5	wheel alignment and tire balance	9-20
recommended lubricants and capacities	10-6	wheel replacement	9-21
tires and wheels	10-4	towing	8-17
vehicle weight	10-5	removable towing hook	8-18
SRS components and functions	4-35	towing service	8-17
steering wheel	5-47	trailer towing	6-53
electric power steering (EPS)	5-47	driving with a trailer	6-55
heated steering wheel	5-48	hitches	6-54
horn	5-49	maintenance	6-58
tilt and telescopic steering wheel	5-48	pull a trailer	6-58
storage compartment	5-112	safety chains	6-55
center console storage	5-112	trailer brakes	6-55
glove box	5-112		
luggage board	5-112		
sun visor	5-115		
<hr/>			
T		U	
theft-alarm system	5-13	unlock charging connector in emergency	1-23
armed stage	5-13	USB charger	5-116
disarmed stage	5-14	USB port	5-121
theft-alarm stage	5-14	using the infotainment/climate switchable controller	5-122
tilt and telescopic steering wheel	5-48	utility mode	1-15
tire pressure indicator	8-6	<hr/>	
tire pressure monitoring system (TPMS)	8-6	V	
effective use of TPMS	8-6	vanity mirror lamp	5-95
low tire pressure position telltale	8-7	vehicle auto-shut off function	6-46
malfunction indicator	8-8	vehicle certification label	10-7
tire pressure indicator	8-6	vehicle data collection and event data recorders	2-2
tire replacement with TPMS	8-9	vehicle handling instructions	2-3
tire specification and pressure label	10-7	vehicle identification number (VIN)	10-7
tires and wheels	9-18	vehicle load limit	6-61
all season tires	9-26	certification label	6-63
checking tire inflation pressure	9-19	vehicle modifications	2-3
low aspect ratio tire	9-27	vehicle stability management (VSM)	6-33
radial-ply tires	9-26	vehicle to load (V2L)	1-9
snow tires	9-26	vehicle weight	6-64
summer tires	9-26	virtual engine sound system (vess)	1-39
tire maintenance	9-21		
tire replacement	9-20		

W

warning and indicator lights	5-75
indicator lights	5-80
warning lights	5-75
warning lights	5-75
washer fluid	9-13
checking the washer fluid level	9-13
welcome system	5-96
wide sunroof	5-43
automatic reversal	5-45
power sunshade	5-44
resetting the sunroof	5-45
slide open/close	5-44
sunroof open warning	5-46
tilt open/close	5-44
windows	5-35
power window lock button	5-37
remote window opening	5-38
window opening and closing	5-36
windshield defrosting and defogging	5-108
A/C automatic drying	5-111
auto defogging system (ADS)	5-110
automatic ventilation	5-110
defogging inside windshield with automatic climate control	5-109
defogging logic	5-109
defrosting outside windshield with the automatic climate control	5-109
smart ventilation	5-110
windshield washers	5-92
winter driving	6-51
wiper blades	9-15
blade inspection	9-15
replacing front windshield wiper blade	9-15
wipers and washers	5-92
auto control	5-92
operating windshield washer	5-93
windshield washers	5-92
wireless smart phone charging system	5-117

