



MODEL S

2021 +

OWNER'S MANUAL



Software version: 2023.6
North America

YOUR OWNER'S MANUAL

For the latest and greatest information that is customized to your vehicle, view the Owner's Manual on your vehicle's touchscreen by touching **Controls > Service > Owner's Manual**. The information is specific to your vehicle depending on the features you purchased, vehicle configuration, market region and software version. In contrast, owner information that is provided by Tesla elsewhere is updated as necessary and may not contain information unique to your vehicle.

RELEASE NOTES

Information about new features is displayed on the touchscreen after a software update, and can be viewed at any time by touching **Controls > Software > Release Notes**. If the content in the Owner's Manual on how to use your vehicle conflicts with information in the Release Notes, the Release Notes take precedence.

ILLUSTRATIONS AND PRODUCT SPECIFICATIONS

The illustrations provided in this document are for demonstration purposes only. Depending on vehicle options, software version and market region, the information displayed on the touchscreen in your vehicle may appear slightly different.

All specifications and descriptions contained in this document are verified to be accurate at the time of printing. However, because continuous improvement is a goal at Tesla, we reserve the right to make product modifications at any time. To communicate any inaccuracies or omissions in this document, please send an email to: ownersmanualfeedback@tesla.com.

SAFETY INFORMATION

You can find safety information in your Model S Owner's Manual on the touchscreen.

For detailed information about your Model S, go to the Tesla website for your region, log on to your Tesla account, or sign up to get an account.

If you have any questions or concerns about your Model S, call 1-877-79TESLA (1-877-798-3752).

© 2012-2023 TESLA, INC.

All information in this document and all vehicle software is subject to copyright and other intellectual property rights of Tesla, Inc. and its licensors. This material may not be modified, reproduced or copied, in whole or in part, without the prior written permission of Tesla, Inc. and its licensors. Additional information is available upon request. Shown here are trademarks or registered trademarks of Tesla, Inc. in the United States and other countries:

MODEL 3 MODEL S TESLA TESLA ROADSTER

MODEL Y MODEL X TESLA MOTORS T E S L A



Overview	3	Cabin Camera.....	118
Exterior Overview.....	3	Using the Touchscreen	119
Interior Overview.....	4	Climate Controls.....	119
Touchscreen Overview.....	6	Phone, Calendar, and Web Conferencing.....	126
Opening and Closing	12	Air Suspension.....	129
Keys.....	12	Voice Commands.....	131
Doors.....	17	Safety & Security Settings.....	133
Windows.....	19	Dashcam.....	135
Rear Trunk.....	20	Sentry Mode.....	136
Front Trunk.....	22	USB Drive Requirements for Recording Videos.....	138
Interior Storage and Electronics.....	25	Smart Garage Connectivity.....	139
Seating and Safety Restraints	29	Connecting to Wi-Fi.....	142
Front and Rear Seats.....	29	Software Updates.....	143
Seat Belts.....	32	Mobile App.....	145
Child Safety Seats.....	35	Navigation and Entertainment	147
Airbags.....	41	Maps and Navigation.....	147
Driving	47	Media.....	153
Driver Profiles.....	47	Theater, Arcade, and Toybox.....	156
Steering Yoke (or Steering Wheel).....	49	Charging and Energy Consumption	159
Mirrors.....	52	Electric Vehicle Components.....	159
Starting and Powering Off.....	53	High Voltage Battery Information.....	161
Shifting.....	55	Charging Instructions.....	163
Lights.....	58	Scheduled Charging and Scheduled Departure.....	168
Instrument Panel.....	61	Getting Maximum Range.....	169
Wipers and Washers.....	65	Maintenance	171
Braking and Stopping.....	66	Maintenance Service Intervals.....	171
Traction Control.....	69	Tire Care and Maintenance.....	173
Park Assist.....	70	Cleaning.....	178
Vehicle Hold.....	72	Windshield Wiper Blades, Jets and Fluid.....	182
Acceleration Modes.....	73	Jacking and Lifting.....	184
Track Mode.....	74	Parts and Accessories.....	185
Trip Information.....	76	Do It Yourself Maintenance.....	186
Rear Facing Camera(s).....	77	Specifications	187
Pedestrian Warning System.....	78	Identification Labels.....	187
Cold Weather Best Practices.....	79	Vehicle Loading.....	188
Autopilot	81	Dimensions.....	190
About Autopilot.....	81	Subsystems.....	192
Traffic-Aware Cruise Control.....	84	Wheels and Tires.....	194
Autosteer.....	88	Roadside Assistance	201
Navigate on Autopilot.....	93	Contacting Tesla Roadside Assistance.....	201
Traffic Light and Stop Sign Control.....	96	Instructions for Transporters.....	202
Autopark.....	103	Running Out of Range.....	206
Summon.....	105	Jump Starting.....	207
Smart Summon.....	108	Troubleshooting	209
Active Safety Features	111	Troubleshooting Alerts.....	209
Lane Assist.....	111		
Collision Avoidance Assist.....	114		
Speed Assist.....	117		



Contents

Consumer Information.....	259
About this Owner Information.....	259
Feature Availability Statement.....	260
Disclaimers.....	261
Reporting Safety Defects.....	263
Certification Conformity.....	264
Index.....	267



NOTE: Depending on market region, vehicle configuration, and options purchased, your vehicle may look slightly different than described.

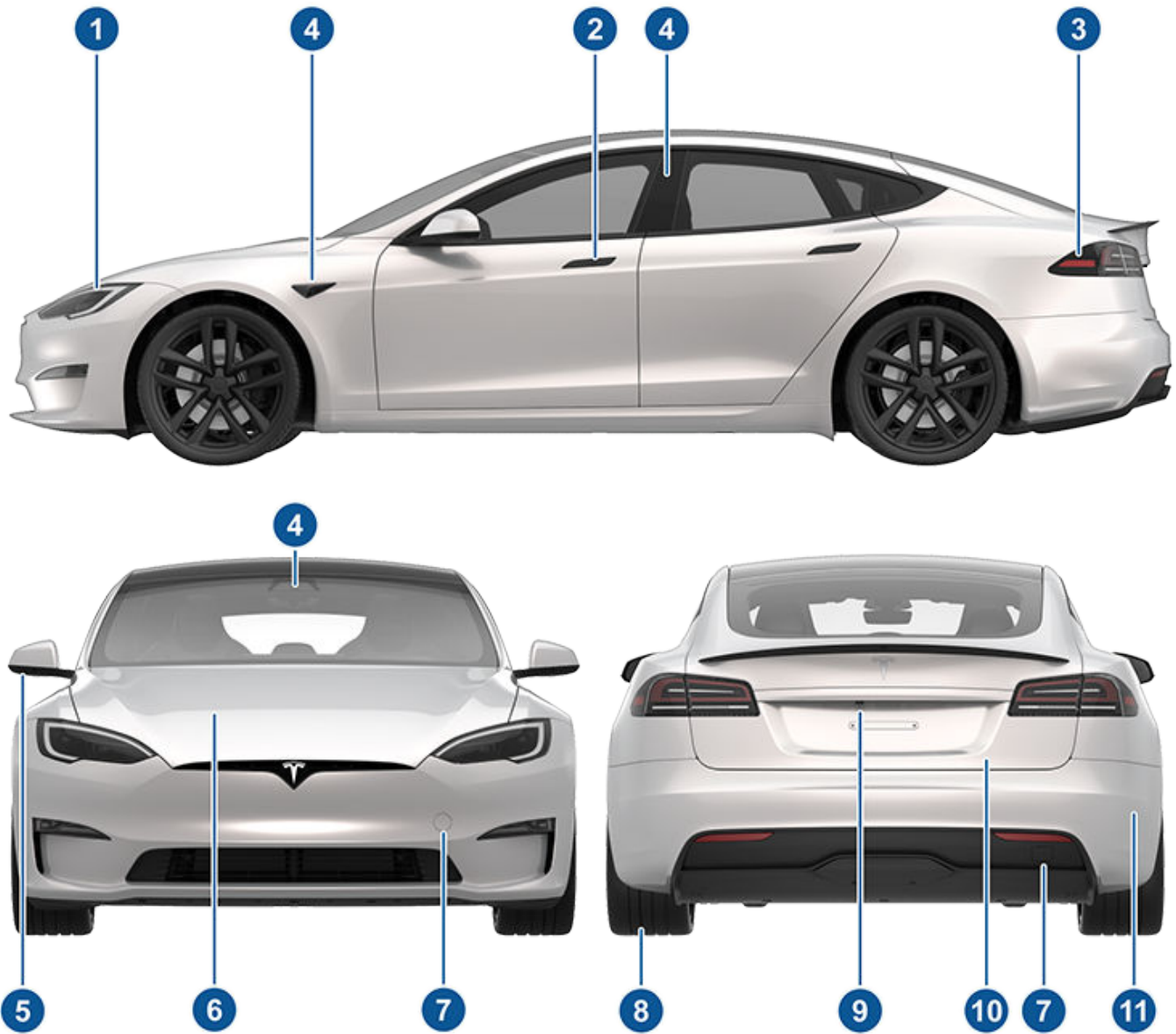

1. Exterior lights ([Lights on page 58](#))
2. Door handles ([Doors on page 17](#))
3. Charge port ([Charging Instructions on page 163](#))
4. Autopilot cameras ([About Autopilot on page 81](#))
5. Exterior mirrors ([Mirrors on page 52](#))
6. Hood/Front trunk ([Front Trunk on page 22](#))
7. Front/rear tow eye cover ([Instructions for Transporters on page 202](#))
8. Wheels and tires ([Wheels and Tires on page 194](#))
9. Rear view camera ([Rear Facing Camera\(s\) on page 77](#) and [About Autopilot on page 81](#))
10. Rear trunk/liftgate ([Rear Trunk on page 20](#))
11. Ultrasonic sensors, if equipped ([Park Assist on page 70](#) and [About Autopilot on page 81](#))



Interior Overview

NOTE: Illustrations are provided to improve conceptual understanding only. Depending on vehicle options purchased and market region, the design may differ but the function is the same.

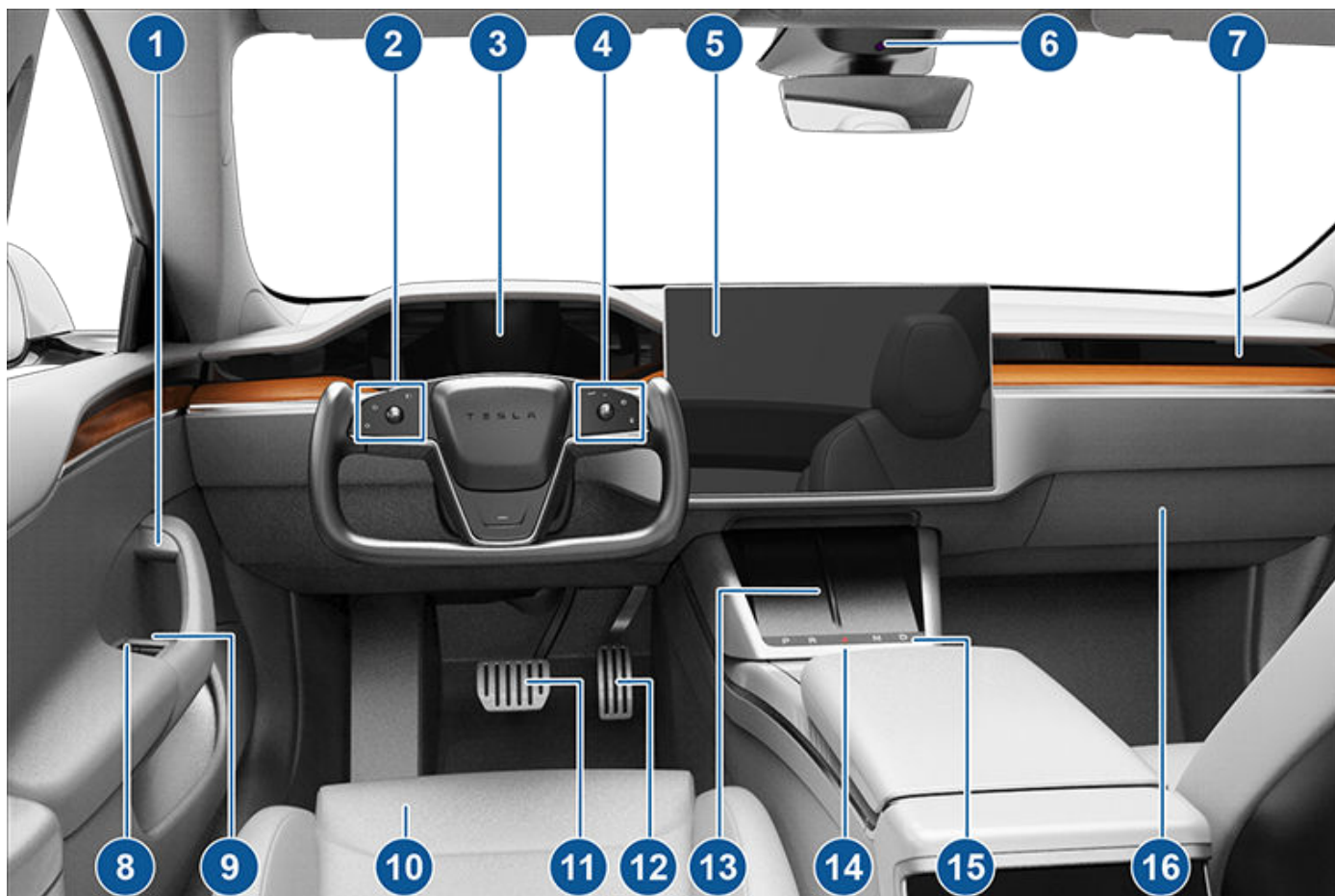

1. Interior door handles ([Doors on page 17](#))
2. Left steering yoke (or steering wheel) buttons
 - Left Scroll Button ([Left Scroll Button on page 49](#))
 - High Beam Headlights ([High Beam Headlights on page 58](#))
 - Turn Signals ([Turn Signals on page 60](#))
3. Instrument panel ([Instrument Panel on page 61](#))
4. Right steering yoke (or steering wheel) buttons
 - Right Scroll button to control Autopilot features ([Right Scroll Button on page 50](#))
 - Horn ([Horn on page 50](#))
 - Wipers ([Wipers and Washers on page 65](#))
 - Voice Commands ([Voice Commands on page 131](#))
5. Touchscreen ([Touchscreen Overview on page 6](#))
6. Camera ([Cabin Camera on page 118](#))
7. Cabin climate control ([Climate Controls on page 119](#))
8. Power window switches ([Opening and Closing on page 19](#))
9. Manual door release ([Doors on page 17](#))
10. Seats ([Front and Rear Seats on page 29](#))
11. Brake pedal ([Braking and Stopping on page 66](#))
12. Accelerator pedal ([Acceleration Modes on page 73](#))



13. Wireless phone chargers ([Wireless Phone Chargers on page 26](#))
14. Hazard warning lights ([Hazard Warning Flashers on page 60](#))
15. Secondary drive mode selector ([Shifting on page 55](#))
16. Glovebox ([Glovebox on page 25](#))

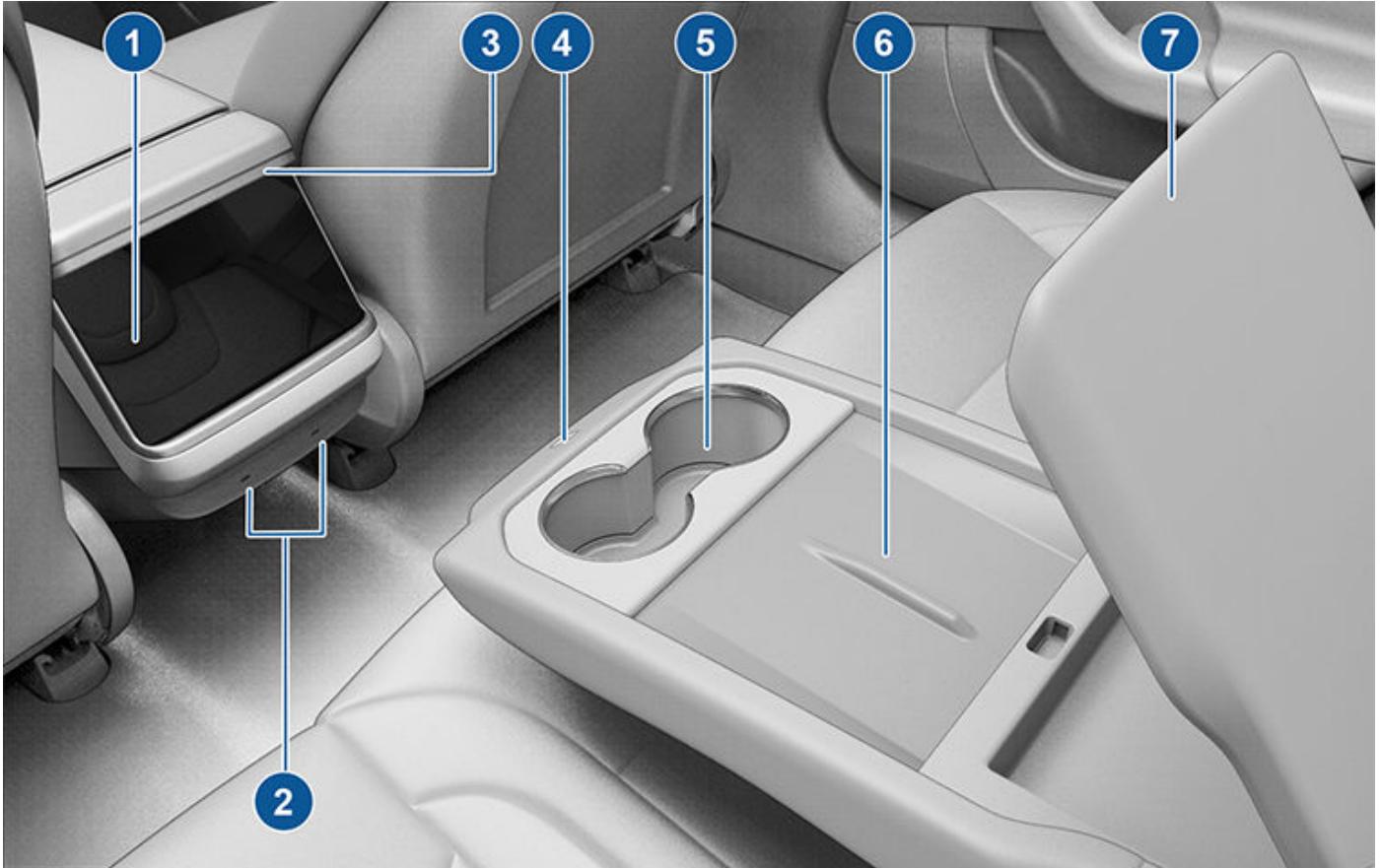

1. Rear touchscreen ([Rear Touchscreen on page 9](#))
2. USB ports ([USB Ports on page 25](#))
3. Adjustable climate control vents ([Climate Controls on page 119](#))
4. Console release button ([Second Row Console on page 25](#))
5. Cup holders ([Second Row Console on page 25](#))
6. Wireless phone chargers ([Wireless Phone Chargers on page 26](#))
7. Rear armrest ([Second Row Console on page 25](#))



Touchscreen Overview

In addition to the instrument panel, Model S is equipped with a front and rear touchscreen.

NOTE: Throughout this Owner's Manual, the front touchscreen is referred to as the "touchscreen" whereas the rear touchscreen is referred to as the "rear touchscreen".

⚠ WARNING: Always pay attention to road and traffic conditions when driving. To minimize driver distraction and ensure the safety of vehicle occupants as well as other road users, avoid using the touchscreen to adjust settings while the vehicle is in motion.

Use the touchscreen to control many features that, in traditional cars, are controlled using physical buttons (for example, adjusting the cabin heating and air conditioning, headlights, etc.). You also use the touchscreen to control media, navigate, use entertainment features, and customize Model S to suit your preferences. For hands-free access to common touchscreen controls, use voice commands (see [Voice Commands on page 131](#)).

If the touchscreen is unresponsive or demonstrates unusual behavior, you can restart it (see [Restarting the Touchscreen on page 8](#)).

NOTE: Illustrations are provided to improve conceptual understanding only. Depending on vehicle options, software version, market region and regional and language settings, the details displayed on the screen will differ.

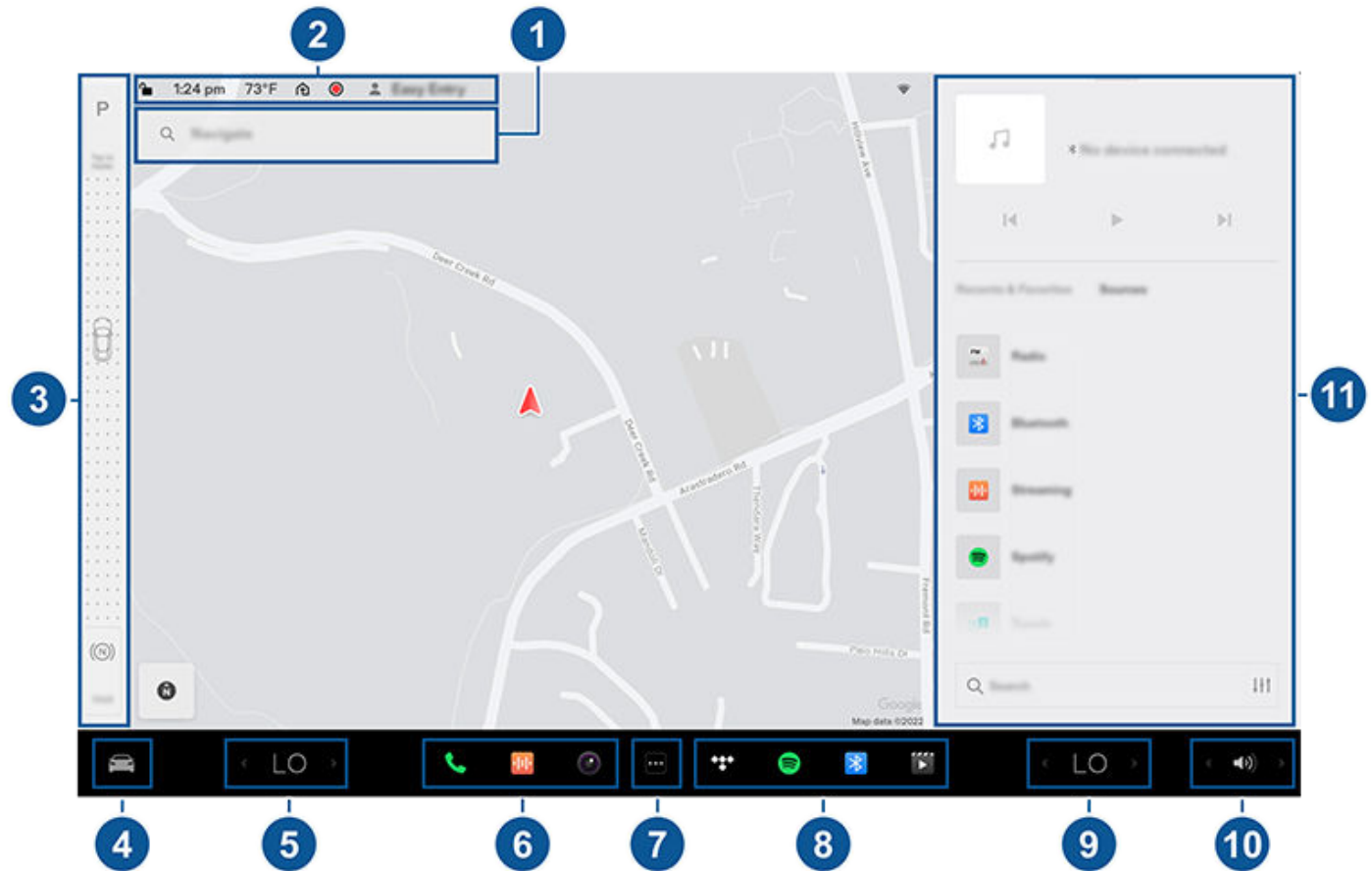

- 1. Navigation:** Change the orientation of the map, find or navigate to a destination, and change navigation settings (see [Maps and Navigation on page 147](#)).
- 2. Status bar:** This area on the top of the touchscreen displays the time of day, the outside temperature, and the following icons:



Touch to lock/unlock all doors and trunks.



4:20 pm

Your vehicle automatically updates the time. If the time is incorrect, confirm your vehicle has internet and GPS connectivity with the latest software.



Displays on the touchscreen status bar only when Model S detects a programmed HomeLink within range, and the touchscreen is not already displaying the HomeLink screen or popup. See [Smart Garage Connectivity on page 139](#).



Displays on the touchscreen status bar only when Model S is parked. Add, configure (including **Valet Mode** and **Use Easy Entry**), or quickly switch driver profiles. Driver profiles can also be accessed from the top of any Controls screen. See [Driver Profiles on page 47](#).



Available when Model S is parked, touch to manually enable or disable Sentry Mode for the current drive cycle. To automatically turn Sentry Mode on (or off) every time you leave your vehicle, enable the setting from **Controls > Safety > Sentry Mode**. See [Sentry Mode on page 136](#) for more information.

NOTE: If you turn Sentry Mode on or off from **Controls > Sentry Mode**, the shortcuts on the vehicle's touchscreen and mobile app will only work for the current drive cycle.



Displays when Model S is connected to a Wi-Fi network.



Displays when Model S cellular connectivity is very low or unavailable. Touch this icon for quick access to Wi-Fi settings.

3. **Drive mode strip:** Use to shift into Park, Reverse, Neutral, or Drive. The drive mode strip always displays on the touchscreen when you touch **Controls** (see [Shifting on page 55](#)).
4. **Controls:** Control various features and customize Model S to suit your preferences. The Controls screen appears over the map. Touch an option on the Controls screen to display the various settings and options associated with the chosen option. Swipe to close.



When an information icon displays beside a specific setting, touch it to display a popup that provides helpful details about the associated setting.

NOTE: You can also access Controls by touching anywhere on the side of the touchscreen closest to the driver and swiping open.

NOTE: Many vehicle controls, settings, and preferences (such as climate, media, and navigation) can be adjusted hands-free using voice commands (see [Voice Commands on page 131](#)).

5. **Climate controls (driver):** Use the left and right arrows to decrease/increase cabin temperature. Touch **Split** on the popup to display separate controls for the driver and passenger. Touch the temperature icon to customize climate control settings (see [Climate Controls on page 119](#)). The passenger climate controls display when temperature controls have been **Split** to provide separate controls for the driver and passenger.
6. **My Apps:** For one-touch access to frequently used apps and controls, you can choose what displays here. See [Customizing My Apps on page 10](#).
7. **App Launcher:** Touch the app launcher to open the app tray. Then touch any app to open it. The app you choose displays on top of the map. To close an app, drag it downward.

NOTE: You cannot completely close Media Player. When you drag Media Player down, it displays Mini-Player which allows you see what's playing, pause/play, and skip reverse/forward.

8. **Recent App(s)**: Displays the most recently used app(s). The number of recent apps displayed here depends on how many apps have been added to **My Apps**. If you add the maximum number of apps to **My Apps**, only the most recent app displays.
9. **Climate controls (passenger)**: Displays when temperature controls have been **Split** to provide separate controls for the driver and passenger.
10. **Volume Control**: Controls the volume of media player and phone calls (see [Volume Controls on page 153](#)). The volume of navigation instructions is controlled separately (see [Maps and Navigation on page 147](#)).
11. **Media Player**: See [Media on page 153](#).

The bottom of the touchscreen may also display the following:



Displays the status of the front passenger airbag (see [Airbags on page 41](#)).

Popup Messages and Vehicle Alerts

Popup messages appear at the bottom of the touchscreen. For example, a seat belt reminder appears if a seat belt is unfastened in an occupied seat, an alert appears to notify you of an incoming phone call, a text message appears (when applicable), and voice commands appear when in use. If applicable, touch options from these popup messages (for example, accept/decline a phone call, choose an option from the headlight menu, etc.). To dismiss a popup message, swipe it downward.

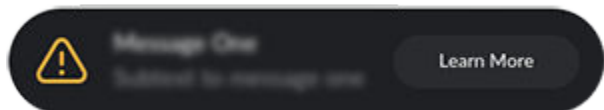

If an alert appears on your vehicle's touchscreen, touch **Learn More** for more details regarding the alert and how it can be resolved. You can view a list of vehicle alerts and notifications by touching the bell icon at the top of **Controls**.

NOTE: Not all alerts provide additional information at this time.

Tilt the Touchscreen (if equipped)

To tilt the touchscreen, navigate to **Controls**, then touch the display icon to choose the desired position.

 **WARNING:** When the center display is tilting, ensure that there are no objects (such as your fingers or jewelry) between the screen and instrument panel to reduce the risk of injury or damage.

Restarting the Touchscreen

You can restart your touchscreen if it is unresponsive or demonstrates unusual behavior.

NOTE: To ensure the safety of occupants as well as other road users, restart the touchscreen only when the vehicle is in Park.

1. Shift into Park.
2. Hold down both scroll buttons on the steering yoke (or steering wheel) until the touchscreen turns black. Pressing the brake pedal while holding down the scroll buttons does not have any impact and is not required.

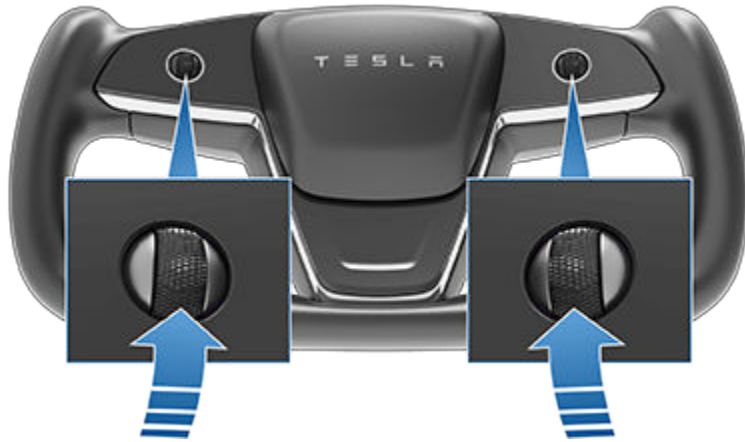

3. After a few seconds, the Tesla logo appears. Wait approximately 30 seconds for the touchscreen to restart. If the touchscreen is still unresponsive or demonstrating unusual behavior after a few minutes, try power cycling the vehicle (if possible). See [Power Cycling the Vehicle on page 53](#).

NOTE: Restarting the touchscreen also activates the drive mode selector on the center console.

NOTE: Pressing the scroll buttons only restarts the touchscreen. It does not restart any other vehicle component and does not power Model S off and on.

Rear Touchscreen

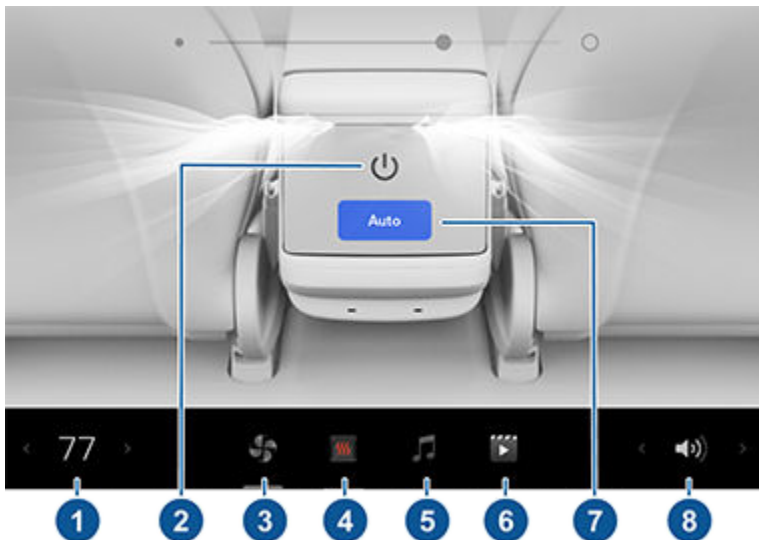

The rear touchscreen provides rear passengers with access to:

1. **Temperature:** Touch the arrows to decrease/increase cabin temperature.
NOTE: You can also use the front touchscreen to adjust climate settings in the rear cabin (see [Adjusting Climate Control Settings on page 119](#)).
2. **Power:** Touch to turn the rear climate control system on or off.
3. **Rear fan:** Touch to turn the rear fan on or off, to adjust fan speed and control the direction of air flow from the rear vents (see [Adjusting the Front and Rear Vents on page 122](#)).
4. **Seat heaters:** Control rear seat heaters.
5. **Media:** Play, pause, skip or rewind through the currently playing song (see [Media on page 153](#)).
6. **Video:** Access video streaming services.

7. **Auto:** If **Auto** is enabled and a passenger is detected, the set temperature is maintained for the rear cabin.

NOTE: Enable **Sync** on the rear tab of the front touchscreen's climate controls to set both the front and back cabin temperatures.

8. **Volume:** Touch to adjust the volume.

NOTE: Adjusting the media and volume controls also adjusts the front cabin settings.

Rear Screen Remote Control



To control the rear screen from the front display, open the rear screen remote control app in the bottom bar. Besides audio, video and climate controls, you can lock the rear display in the app or by touching **Controls** > **Display** > **Lock Rear Display**.

Customizing My Apps

For one-touch access to commonly used apps and controls, you can customize what displays in the **My Apps** area on the touchscreen's bottom bar:

1. Enter customization mode by touching and holding any app or control in the **My Apps** area. If this area is empty, touch the App Launcher.
2. Simply drag any app or control from the app tray onto the **My Apps** area in the bottom bar.

NOTE: Seat heaters selected from the app tray appear next to the temperature, instead of in the My Apps area.

NOTE: Controls (for example, defrosters and seat heaters) appear in the app tray only when you enter customization mode by touching and holding an app.

NOTE: When you've added the maximum number of apps or controls to **My Apps**, adding an additional app removes the rightmost app.

NOTE: Remove an app or control from the **My Apps** area by touching and holding, then touching its associated "X".

Customizing Display and Sound Settings

Touch **Controls** > **Display** to adjust display settings to suit your preferences:

- **Appearance:** Customize the display to be **Dark** or **Light**. When set to **Auto**, the brightness changes automatically based on ambient lighting conditions.
- **Brightness:** Drag the slider to manually control the brightness level. If **Display Mode** is set to **Auto**, the touchscreen further adjusts based on both the ambient lighting conditions and your brightness preference. Model S remembers your chosen brightness preference and adjusts the touchscreen accordingly.
- **Screen Clean Mode:** When enabled, your touchscreen darkens and temporarily disables to facilitate cleaning. Follow the onscreen instructions to exit Screen Clean Mode.
- **Touchscreen Language:** Select the language that the touchscreen displays.
NOTE: Model S must be in Park to change the language. When you change the language, you experience a brief delay as Model S shuts down and restarts the touchscreen.
- **Voice Recognition Language:** Choose the language to be used for voice commands.
- **Voice Navigation Language:** Choose the language that the navigation system uses for spoken instructions.
NOTE: For languages that require a download, select the language in the dropdown list to initiate the download (Wi-Fi connection required).



- **Lock Rear Display:** Lock access to the rear touchscreen.
- **Time:** Choose to display time in either 12 or 24 hour format.
- **Energy Display:** Choose to display remaining energy and charging units as either a percentage of battery energy remaining, or as an estimate of the distance you can drive.
NOTE: When anticipating when you need to charge, use energy estimate as a general guideline only. Many factors have an impact on energy consumption. See [Factors Affecting Energy Consumption on page 169](#).
- **Distance:** Choose to display range using miles or kilometers.
- **Temperature:** Choose to display temperature using Fahrenheit or Celsius.
- **Tire Pressure:** Choose to display tire pressures using BAR or PSI.

In addition to customizing the display, you can enable Joe Mode to reduce the volume of all chimes that are not related to critical safety issues. Touch **Controls** > **Safety** > **Joe Mode** to enable.

Naming your Vehicle

To further personalize your vehicle, you can name it. Touch **Controls** > **Software** > **Name Your Vehicle** located on the right side of the touchscreen below the image of your Model S. If your vehicle already has a name, simply touch the existing name to change it. Enter the new name in the popup and touch **Save**. The name of your Model S also appears in the Tesla mobile app.

Erasing Personal Data

You can erase all personal data (saved addresses, music favorites, HomeLink programming, etc.) and restore all customized settings to their factory defaults. This is useful when transferring ownership of Model S. Touch **Controls** > **Service** > **Factory Reset**. Before erasing, Model S verifies your credentials by prompting you to enter the user name and password associated with your Tesla account.

Three Types of Keys

Model S supports three types of keys:

- **Phone key** - You can set up your personal phone as a "phone key" that communicates with Model S using Bluetooth. A phone key supports automatic locking and unlocking.
- **Key card** - Tesla provides a key card that communicates with Model S using short range radio-frequency identification (RFID) signals. The key card is used to "authenticate" phone keys to work with Model S and to add or remove other key cards, phone keys, or key fobs. Unlike the phone key and key fob, the key card does not support automatic locking and unlocking. In situations where your phone key has a dead battery, or is lost or stolen, use your key card to unlock, drive, and lock Model S.
- **Key fob** - The key fob (if equipped) allows you to press buttons to open the front and rear trunks, and unlock, lock, and drive Model S. The key fob also supports automatic locking and unlocking, if available in your region (see [Passive Locking and Unlocking on page 14](#)) and can be used as a backup to your phone key.

Model S supports a total of 19 keys, which can include phone keys, key cards, and up to four key fobs.

 **CAUTION:** Remember to bring a key with you when you drive. Although you can drive Model S away from its key, you will be unable to power it back on after it powers off.

Phone Key

Using your phone as a key is a convenient way to access your Model S. As you approach, your phone's Bluetooth signal is detected and the doors unlock when you press a door handle. Likewise, when you exit and walk away with the phone key, doors automatically lock (provided the **Walk-Away Door Lock** feature is turned on; see [Walk-Away Door Lock on page 18](#)).

Before you can use a phone to access Model S, follow these steps to authenticate it:

1. Download the Tesla mobile app to your phone.
2. Log into the Tesla mobile app using your Tesla account username and password.

NOTE: You must remain logged in to your Tesla account to use your phone to access Model S.

NOTE: If multiple vehicles are linked to your Tesla account, you must ensure that the vehicle you want the mobile app to access is currently selected on the mobile app.

3. Ensure:

- Your phone's general Bluetooth settings are enabled.
- Bluetooth is enabled within your phone's settings for the Tesla mobile app. For example, on your phone, navigate to Settings, choose the Tesla mobile app, and ensure the Bluetooth setting is turned on.
- Access to your location is enabled. Open the Tesla mobile app in your phone's settings and select **Location > Always**. For the best experience, keep the mobile app running in the background.
- Allow Mobile Access is enabled on the vehicle touchscreen (**Controls > Safety > Allow Mobile Access**).

NOTE: Model S communicates with your phone using Bluetooth. Keep in mind that your phone must have enough battery power to run Bluetooth and that many phones disable Bluetooth when the battery is low.

4. While sitting inside the vehicle with a key card handy, open the Tesla mobile app and touch **Set Up Phone Key** on the main screen, or navigate to **Security > Set Up Phone Key**. Follow the prompts on the mobile app and vehicle touchscreen to set up your phone key.

To view a list of keys that can currently access Model S, or to remove a phone key, touch **Controls > Locks** (see [Managing Keys on page 15](#)).

Model S can connect to three phone keys simultaneously. Therefore, if more than three phone keys are detected and you want to authenticate or pair a different phone, move the other connected phone key(s) out of range or turn off its Bluetooth setting.

Once a phone has been authenticated, it no longer requires an internet connection to be used as a phone key for Model S. However, to use the phone hands-free, access your phone's contacts, play media from it, etc., you must also pair it and connect it as a Bluetooth device (see [Pairing a Bluetooth Phone on page 126](#)).

Some smartphones with NFC capability can be used to lock/unlock your vehicle, just like using a key card. Ensure the Tesla mobile app is correctly paired to your vehicle and enable the NFC function on your phone. Once enabled, simply hold the phone to the driver's side door pillar to lock or unlock the door. Refer to your smartphone's instructions for specific information on how to do this.

Key Card

Tesla provides you with two Model S key cards, designed to fit in your wallet.

To use a key card to unlock or lock Model S, position the card as shown and tap it against the card reader located approximately one third the way up of the driver's side door pillar. When Model S detects the key card, the exterior lights flash, the mirrors unfold or fold (if Fold Mirrors is on), the horn sounds (if Lock Confirmation Sound is on), and the doors unlock or lock.

NOTE: You may need to physically touch the wireless phone charger or driver's side door pillar with the key card, and you may need to hold it against the transmitter for one or two seconds.



Once inside, power up Model S by pressing the brake pedal within two minutes of scanning the key card (see [Starting and Powering Off on page 53](#)). If you wait longer than two minutes, you must re-authenticate by placing the key card near the card reader located in the wireless phone charger on the center console. When your key card is detected, your two minute authentication period restarts.

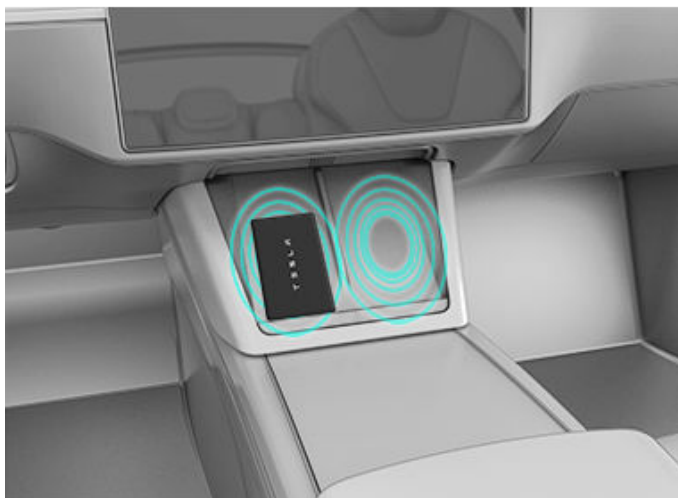

NOTE: If enabled, Walk-Away Door Lock (see [Walk-Away Door Lock on page 18](#)) operates only when you walk away using a phone key or passive key fob. When you walk away carrying your key card, Model S does not automatically unlock/lock.

Key Fob

NOTE: Depending on market region, vehicle configuration, or date of manufacture, your vehicle may not come with a key fob. Go to <http://shop.tesla.com> for more information.

You can quickly familiarize yourself with the key fob by thinking of it as a miniature version of Model S, with the Tesla badge representing the front. The key has buttons that feel like softer areas on the surface.



1. Rear trunk - Double-click to open or close the rear trunk. Hold down for one to two seconds to open the charge port door.
2. Lock/Unlock All - Single-click to lock doors and trunks (all doors and trunks must be closed). Double-click to unlock doors and trunks.
3. Front trunk - Double-click to unlatch the front trunk.

Once inside, power up Model S by pressing the brake pedal within two minutes of pressing the unlock button on the key fob (see [Starting and Powering Off on page 53](#)). If you wait longer than two minutes, you must press the unlock button again, or place the key fob near the card reader located in the lower half of the left wireless phone charger, facing downward, on the center console. When your key fob is detected, the two minute authentication period restarts.

When approaching or leaving Model S carrying the key fob, you do not need to point the key fob at Model S as you press a button, but you must be within operating range.



Keys

Radio equipment on a similar frequency can affect the key. If this happens, move the key at least one foot (30 cm) away from other electronic devices (phones, laptops, etc.).

In the event that the key fob's battery is dead, you can still use it. To unlock the vehicle, scan the key fob on the card reader located on the driver's side door pillar (like the key card).

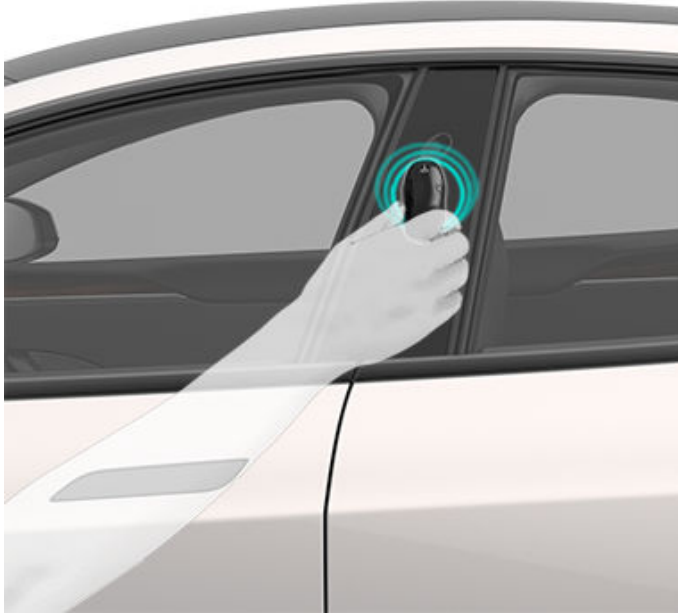

To drive the vehicle, scan the key fob on the phone charger.

1. Place it at the top of the left phone charger, **against the center divider**.
2. Point the front of the key fob down.
3. Swipe downwards.



Instructions for changing the battery are provided in [Replacing the Key Fob Battery on page 14](#).

NOTE: You can use the same key fob with multiple Model S vehicles provided you authenticate it (see [Managing Keys on page 15](#)). However, key fob works with only one Model S at a time. Therefore, to use a key fob for a different Model S, touch its flat side against the card reader on the driver's side door pillar.

NOTE: Model S supports up to four different key fobs.



CAUTION: Protect the key from impact, high temperatures, and damage from liquids. Avoid contact with solvents, waxes, and abrasive cleaners.

Passive Locking and Unlocking

Locking and unlocking Model S with your key fob is conveniently hands-free. Although you must be carrying a paired key fob, there is no need to use it. Model S has sensors around the vehicle that can recognize the presence of a key fob within a range of approximately six feet (two meters). Therefore, you can keep your key fob in your pocket or purse and press the door handle to unlock and extend the handle. When carrying your key fob with you, you can also open the trunk without having to use the key by pressing the liftgate's exterior switch. If **Walk-Away Door Lock** is enabled, Model S automatically locks when you exit and the key fob is no longer in range (see [Walk-Away Door Lock on page 18](#)). Passive locking and unlocking is automatically enabled when you pair your key fob to Model S.

Although you can use the same key fob with multiple vehicles, it can only be paired to one vehicle at a time. To activate a paired key fob to a different vehicle, touch the flat side onto the driver's side door pillar and click any button on the key fob to confirm.

NOTE: For increased security, passive locking and unlocking disables after being stationary for five minutes while within vehicle range when the vehicle is not in use (for example, you are standing outside your vehicle). In this situation, you must shake or press a button on the key fob to re-enable passive locking and unlocking.

Replacing the Key Fob Battery

Under normal use, the key fob has a battery that lasts for up to one year, depending on key fob version and selected vehicle settings. When the battery is low, a message displays on the touchscreen.

To replace the key fob battery:

1. With the key fob placed button side down on a soft surface, release the bottom cover, using a small flat-bladed tool.

Managing Keys

To display a list of all keys (phone keys, key cards, and key fobs) that can access your Model S, touch **Controls > Locks**. An icon displays next to each key to indicate whether the key is a phone key, key card, or key fob. Use this list to manage keys that have access to your Model S. To add or delete keys, see [Adding and Removing Keys on page 15](#).

Model S supports up to 19 keys. When you reach this limit, you must delete a key before adding a new one.

NOTE: You can use the same key for more than one Model S. This prevents you from having to deal with multiple keys when you switch vehicles. If you customize the name of an authenticated key card or key fob on one Model S (by touching the pencil icon), any other Model S to which the key card or key fob is authenticated also displays the changed name.

Adding and Removing Keys

To add a new key card or key fob:

NOTE: When adding a key fob, ensure it is at room temperature. Pairing a key fob that is very cold can be unsuccessful.

1. On the touchscreen, touch **Controls > Locks > Keys > Add Key**.
2. Scan your new key card or key fob on the card reader located on the wireless phone charger. To scan the key fob:
 - Place it at the top of the left phone charger, **against the center divider**.
 - Point the front of the key fob down.
 - Swipe downwards (as shown in the image).

When you hear a chime and the new key is recognized, remove it from the card reader.



3. Scan a key card or key fob that has already been paired to the vehicle to confirm new key pairing.



2. Remove the battery by lifting it away from the retaining clips.



3. While avoiding touching the battery's flat surfaces, insert the new battery (type CR2330) with the '+' side facing up.

NOTE: Wipe the battery clean before fitting and avoid touching the battery's flat surfaces. Finger marks on the flat surfaces of the battery can reduce battery life.

NOTE: CR2330 batteries can be purchased from any retailer that sells batteries.

4. Holding the bottom cover at an angle, align the tabs on the cover with the corresponding slots on the key fob, then press the cover firmly onto the key fob until it snaps into place.
5. Test that the key fob works by unlocking and locking Model S.

⚠ WARNING: Key fob batteries contain a chemical burn hazard and should not be ingested. The key fob contains a coin cell battery. If the coin cell battery is swallowed, it can cause severe internal burns within two hours and can lead to death. Keep new and used batteries away from children. If the battery compartment does not close securely, stop using the product and keep it away from children. If you think batteries might have been swallowed or placed inside any part of the body, seek immediate medical attention.

4. When complete, the key list includes the new key.
Touch the associated pencil icon to customize the name of the key.

Removing a key:

When you no longer want a key to access Model S (for example, you lost your phone or key card, etc.), follow these steps to remove it.

1. On the touchscreen, touch **Controls > Locks**.
2. In the key list, find the key that you would like to delete and touch its associated trash icon.
3. When prompted, scan an authenticated key card or key fob on the card reader to confirm the deletion.
When complete, the key list no longer includes the deleted key.

NOTE: Model S requires at least one authenticated key card or key fob at all times. If only one key card remains on the key list, you cannot delete it.

Using Exterior Door Handles

A light press on a door handle extends it provided Model S is unlocked and detects a phone key or key fob nearby. You can set door handles to extend automatically when you approach the driver's side carrying a phone key or key fob by touching **Controls > Locks > Auto-Present Handles**. Select **Exclude Home** to disable door handle presentation at home (set your home address by touching **Navigate > Set Home**).

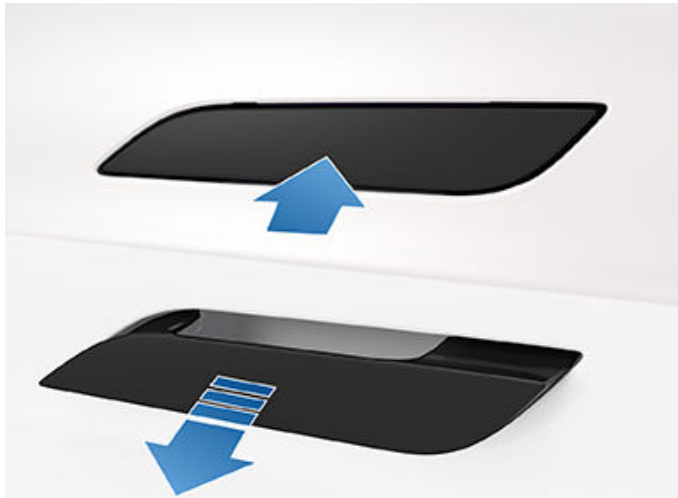

Insert your hand into the handle and pull to open the door.

Door handles retract if you do not use them within ten seconds after they extend. Just press a handle to extend it again. Door handles also retract ten seconds after the last door closes, when Model S begins moving, and when you lock Model S.

NOTE: To preserve battery life, Model S is designed to temporarily disable the **Auto-Present Handles** feature if the vehicle is unable to detect a phone key nearby.

In these cases, extend a door handle by pressing it, or by pressing the unlock button on the key fob. There is no need to reset the setting. The next time you approach Model S, provided the above conditions do not apply, handles automatically extend.

Opening Doors from the Interior

Model S doors are electrically powered. To open a door while sitting inside, press the button located at the top of the interior door handle and push the door open.

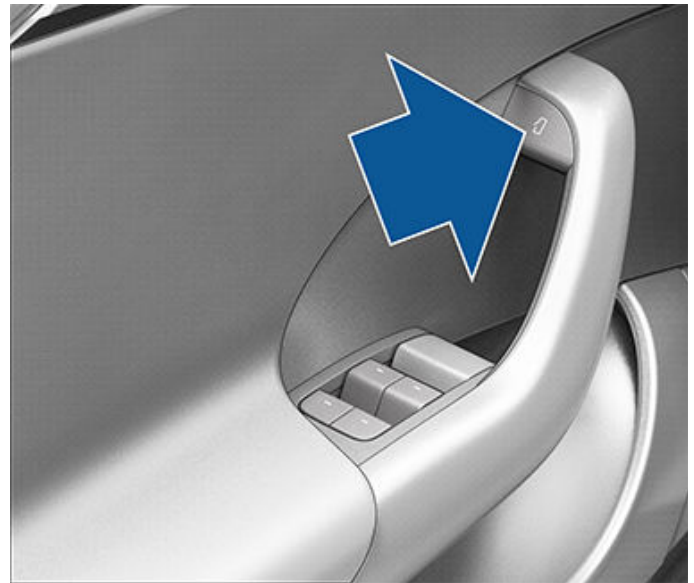

NOTE: To prevent children from opening the rear doors, turn on child locks (see [Child Locks on page 18](#)).

You can also use the touchscreen popup to open and close doors when inside Model S while the vehicle is in Park.

To open a front door in the unlikely situation when Model S has no power, pull up the manual door release located in front of the window switches.

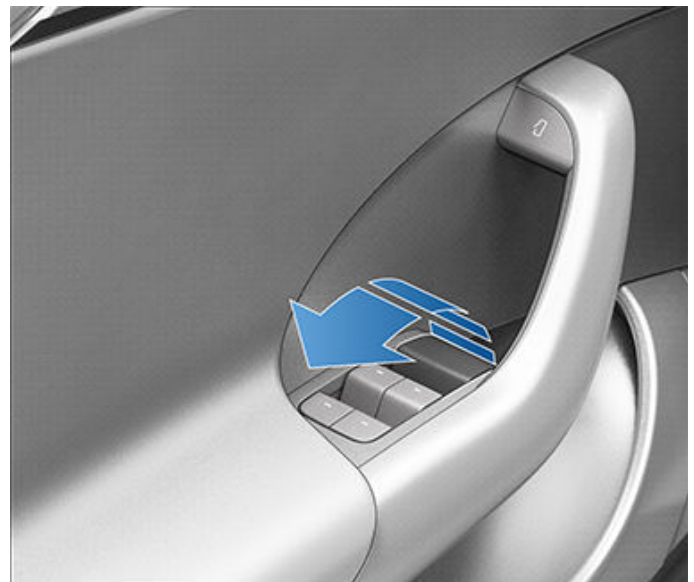

To open a rear door in the unlikely situation when Model S has no power, fold back the edge of the carpet below the rear seats to expose the mechanical release cable. Pull the mechanical release cable toward the center of the vehicle.

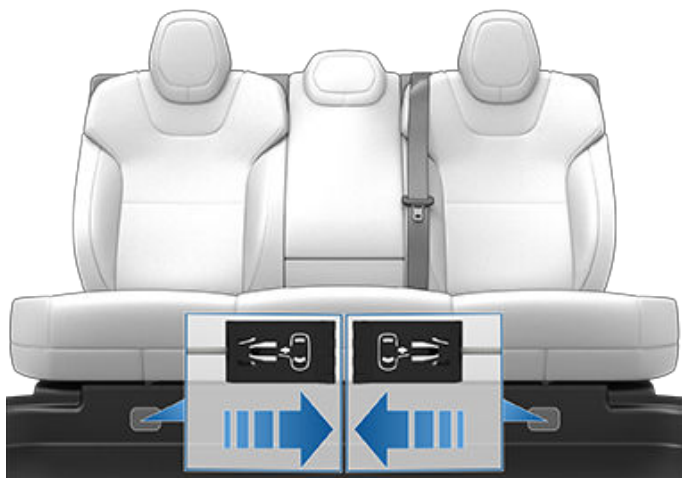

CAUTION: Manual door releases are designed to be used only in situations when Model S has no power. When Model S has power, use the button located at the top of the interior door handle.

Interior Locking and Unlocking

While sitting inside Model S, you can lock and unlock all doors and trunks by touching the lock icon in **Controls**.



The icon changes to indicate whether doors are locked or unlocked.

Walk-Away Door Lock

Doors and trunks can automatically lock when you walk away carrying your phone key or paired key fob. To turn this feature on or off, touch **Controls > Locks > Walk-Away Door Lock**.

When the doors lock, the exterior lights flash once and the mirrors fold (if **Fold Mirrors** is on). To also hear a confirmation sound when Model S locks, touch **Controls > Locks > Lock Confirmation Sound**.

Model S does not automatically lock if:

- You check the **Exclude Home** checkbox and Model S is parked at the location you have designated as Home. For details on how to designate a location as Home, see [Home, Work, and Favorite Destinations on page 149](#).
- A phone key or paired key fob is detected inside Model S.
- A door or trunk is not fully closed.
- The phone key's Bluetooth setting is turned off.
- A phone key remains within range for ten minutes or a key fob remains within range for five minutes after all doors have been closed.

- The driver does not use the driver door to get out of the vehicle.

NOTE: It is ultimately your responsibility to ensure your vehicle is locked, even when Walk-Away Door Lock is enabled.

Drive Away Locking

Model S automatically locks all doors (including the trunks) when your driving speed exceeds 5 mph (8 km/h) 8 km/h.

Driver Door Unlock Mode

Enabling **Controls > Locks > Driver Door Unlock Mode** only unlocks the driver door when you first unlock Model S. The driver door unlocks only if a key is present on the driver side of the vehicle and not the passenger side. To unlock the remaining doors, long press the button located at the top of the interior driver door handle, use the touchscreen, mobile app or press the key fob a second time.

Car Left Open Notifications

To receive a mobile notification if a door, trunk and/or window is left open or if Model S is left unlocked unexpectedly, touch **Controls > Locks > Car Left Open Notifications**.

Child Locks

Model S has child locks on the rear doors to prevent them from being opened using the interior release buttons. On the touchscreen, touch **Controls > Locks > Child Lock**. You can choose **Both** to engage the child lock on both rear doors, or you can choose **Left** or **Right** to engage it on just a specific door.

WARNING: It is recommended that you turn on child locks when children are seated in the rear seats.

Unlock on Park

When you stop Model S and engage Park, you can choose to unlock all doors. To turn this feature on or off, touch **Controls > Locks > Unlock on Park**.

Opening and Closing

NOTE: It is your responsibility to ensure windows are closed after locking the vehicle.

Press down on a switch to lower the associated window. Window switches operate at two levels:

- To lower a window fully, press the switch all the way down and immediately release.
- To lower a window partially, press the switch gently and release when the window is where you want it.

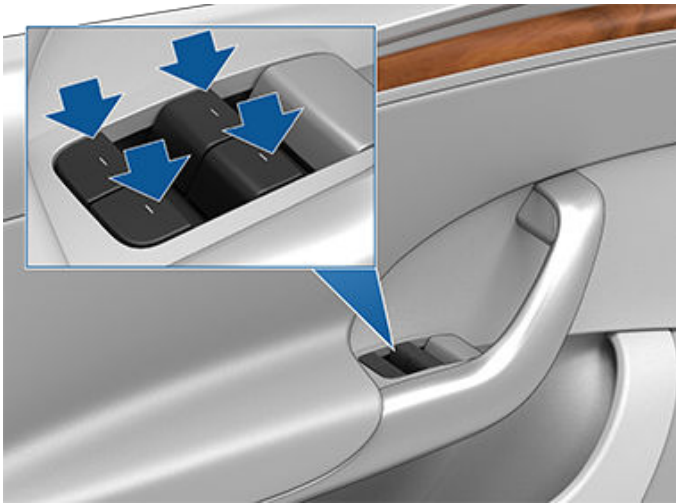

Similarly, pull a switch to raise the associated window:

- To raise a window fully, pull the switch all the way up and immediately release.
- To raise a window partially, pull the switch gently and release when the window is where you want it.

If a window is left open unintentionally, Model S can send a notification to the mobile app (touch **Controls** > **Locks** > **Car Left Open Notification**, then choose **Doors & Windows**).

You can also enable **Close Windows on Lock** by touching **Controls** > **Locks** > **Close Windows on Lock**. When enabled, your vehicle automatically closes the windows when Model S locks.

NOTE: See [Cold Weather Best Practices on page 79](#) for information on preparing windows for cold weather.

 **CAUTION:** To avoid damage, windows automatically lower slightly when you open or close a door. If you manually raise a window when the door is open, ensure it is slightly lowered before closing the door.

 **WARNING:** Before closing a window, it is the driver's responsibility to ensure that all occupants, especially children, do not have any body parts extended through the window's opening. Failure to do so can cause serious injury.

Locking Rear Windows

To prevent passengers from using the rear window switches, touch **Controls** > **Locks** > **Window Lock**. To unlock the rear windows, touch **Window Lock** again.

 **WARNING:** To ensure safety, it is recommended that you lock the rear window switches whenever children are seated in the rear seats.

 **WARNING:** Never leave children unattended in Model S.

UV Index Rating

The roof, windshields, and windows in Model S are excellent at protecting you from UV (ultraviolet) rays. The glass components score less than 2 on the UV Index scale. Review your region's UV Index specifications for more information. You are still responsible for taking the necessary precautions for sun protection.

Opening

To open the rear trunk, ensure Model S is in Park, then do one of the following:

- Touch **Controls** > **Trunk** on the touchscreen.
- Double-click the rear trunk button on the key fob.
- Touch the rear trunk button on the mobile app.
- Press the switch located under the liftgate's exterior handle (a valid key must be detected).

CAUTION: Before opening the liftgate in an enclosed area (such as a garage), ensure the opening height of the liftgate is properly adjusted to avoid low-hanging ceilings or objects (see [Adjusting Liftgate Opening Height on page 20](#)).

Model S must be unlocked or detect a key before you can use the switch to open the liftgate.

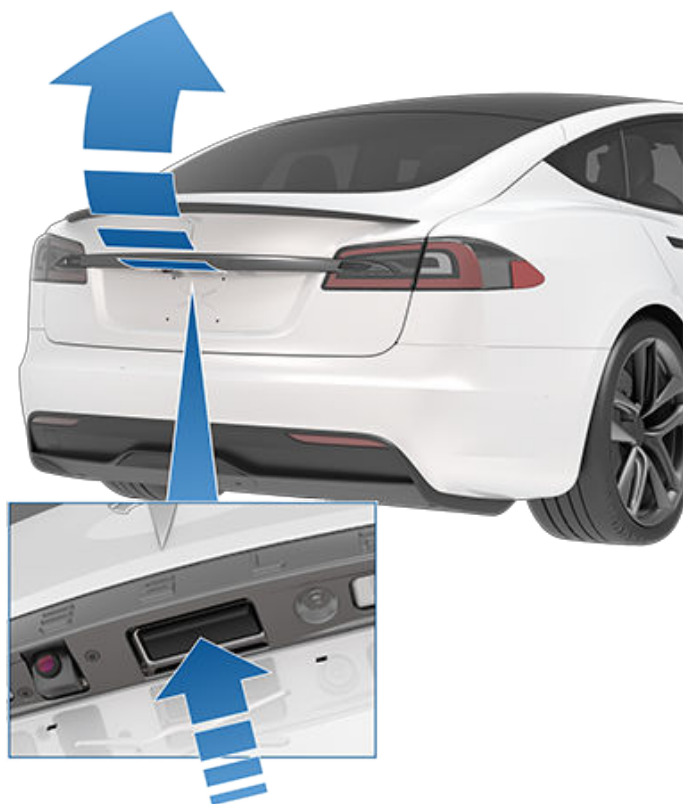

The instrument panel informs you when a door or trunk is open.

To stop a liftgate while it is moving, single-click the rear trunk button on the key fob. Then, when you double-click the rear trunk button, it moves again, but in the opposite direction (provided it was not almost entirely open or closed when you stopped it). For example, if you single-click to stop the liftgate while opening, when you double-click, it closes.

NOTE: In emergency situations, you can override an open or close command by grasping the liftgate to stop it in place.

WARNING: Before opening or closing the liftgate, check the surrounding area (for people and objects). You must proactively monitor the liftgate to ensure that it does not come into contact with a person or object. Failure to do so may result in damage or injury.

Adjusting Liftgate Opening Height

You can adjust the opening height of the liftgate to make it easier to reach or to avoid low-hanging ceilings or objects (for example, a garage door or light):

1. Open the trunk, then manually lower or raise the liftgate to the desired opening height.
2. Press and hold the button on the underside of the liftgate for three seconds until you hear a confirmation chime.



3. Confirm that you have set it to the desired height by closing the liftgate, then reopening it.

CAUTION: Depending on configuration (such as suspension height or wheel selection), your vehicle's liftgate can open up to approximately 7.5 feet (2.3 meters) high. Adjust the liftgate height to prevent it from coming into contact with low ceilings or other objects.

Closing

To close the liftgate, do one of the following:

- Touch **Controls** > **Trunk**.
- Double-click the rear trunk button on the key fob.



- Press the switch located on the underside of the liftgate

If the liftgate senses an obstruction when closing, it stops moving and chimes two times. Remove the obstruction and try closing it again.

If the liftgate loses its calibration when opened, the liftgate chimes three times and does not move. To restore calibration, manually pull the liftgate down to close it.

Accessing the Cargo Area

To access the cargo area inside the rear trunk, pull up the strap at the rear of the cargo cover. You can then fold the cargo cover forward or remove it from Model S.

Secure all cargo before moving Model S, and place heavy cargo in the upper trunk compartment.



The cargo weight should be distributed as evenly as possible between the front and rear trunks.

- CAUTION:** Never load more than 88 lbs (40 kg) in the lower tub compartment of the rear trunk or more than 287 lbs (130 kg) on the upper floor. Doing so can cause damage.
- WARNING:** When loading cargo, always consider the vehicle's Gross Vehicle Weight Rating (GVWR) (see [Vehicle Loading on page 188](#)). The GVWR is the maximum allowable total mass of the vehicle including all passengers, fluids, and cargo.

Opening

To open the front trunk, ensure Model S is in Park, and then do one of the following before pulling the hood open:

- Touch **Controls > Frunk** on the touchscreen.
- Double-click the front trunk button on the key fob.
- Touch the front trunk button in the mobile app.



The instrument panel displays when a door, trunk, or liftgate is open.

WARNING: Before opening or closing the hood, it is important to check that the area around the hood is free of obstacles (people and objects). Failure to do so may result in damage or serious injury.

The cargo weight should be distributed as evenly as possible between the front and rear trunks.

CAUTION: Never load more than 110 lbs (50 kg) in the front trunk. Doing so can cause damage.

WARNING: When loading cargo, always consider the vehicle's Gross Vehicle Weight Rating (GVWR) (see [Vehicle Loading on page 188](#)). The GVWR is the maximum allowable total mass of the vehicle including all passengers, fluids, and cargo.

Closing

The Model S hood is not heavy enough to latch under its own weight and applying pressure on the front edge or center of the hood can cause damage.

To properly close the hood:

1. Lower the hood until the striker touches the latches.
2. Place both hands on the front of the hood in the areas shown (in green), then press down firmly to engage the latches.

3. Carefully try to lift the front edge of the hood to ensure that it is fully closed.

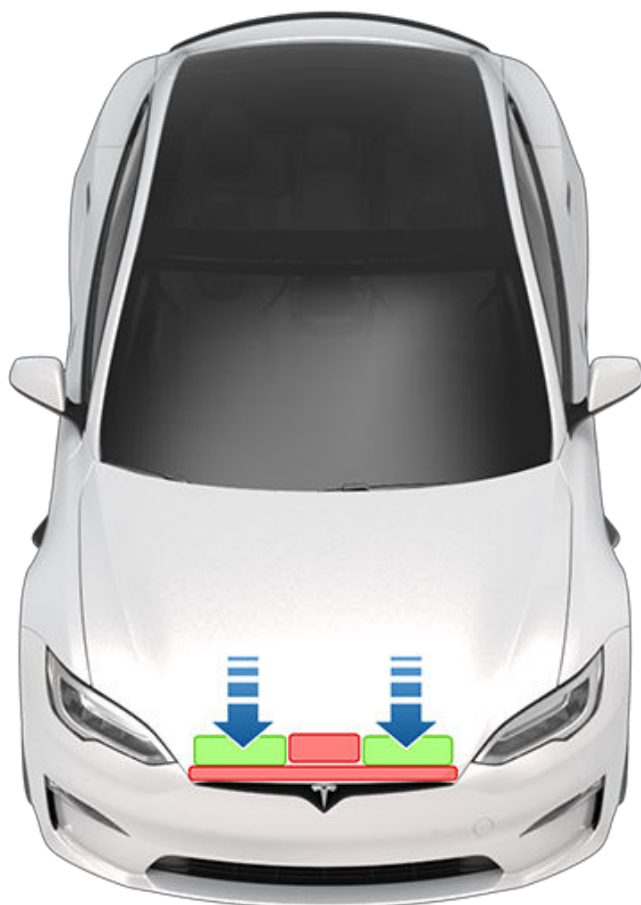

CAUTION: To prevent damage:

- Apply pressure only to the green areas shown. Applying pressure to the red areas can cause damage.
- Do not close the hood with one hand. Doing so applies concentrated force in one area and can result in a dent or crease.
- Do not apply pressure to the front edge of the hood. Doing so can crease the edge.
- Do not slam or drop the hood.
- To avoid scratches, don't have anything in your hands (keys). Jewelry can also cause scratches.

WARNING: Before driving, you must ensure that the hood is securely latched in the fully closed position by carefully trying to lift the front edge of the hood upward and confirming there is no movement.

The front trunk locks when:

- You lock Model S using the touchscreen, key or mobile app.

- You leave Model S carrying your key (if [Walk-Away Door Lock](#) on page 18 is turned on).
- Valet mode is active (see [Valet Mode](#) on page 48).



Interior Emergency Release

An illuminated interior release button inside the front trunk allows a person locked inside to get out.



Press the interior release button to open the front trunk, then push up on the hood.

NOTE: The interior release button glows following a brief exposure to ambient light.

-  **WARNING:** People should never climb inside the front trunk. Never shut the front trunk when a person is inside.
-  **WARNING:** Care should be taken to ensure that objects inside the front trunk do not bump against the release button, causing the hood to accidentally open.

Opening Hood with No Power

In the unlikely event that Model S has no low voltage power, you will be unable to open the front trunk using the touchscreen, key fob, or mobile app. To open the front trunk in this situation:

NOTE: The following steps do not open the front trunk if Model S is locked and has low voltage power.

1. Locate an external low voltage power supply (such as a portable jump starter).
2. Release the tow eye cover by pressing firmly on the top right perimeter of the cover until it pivots inward, then gently pulling the raised section toward you.

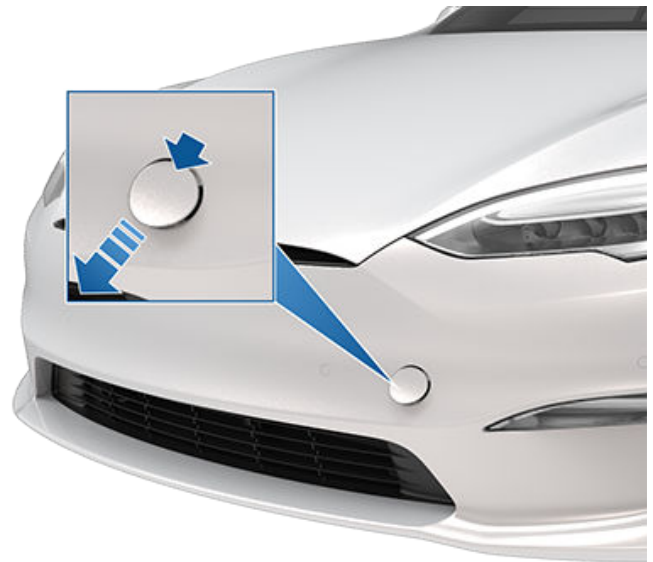

3. Pull the two wires out of the tow eye opening to expose both terminals.

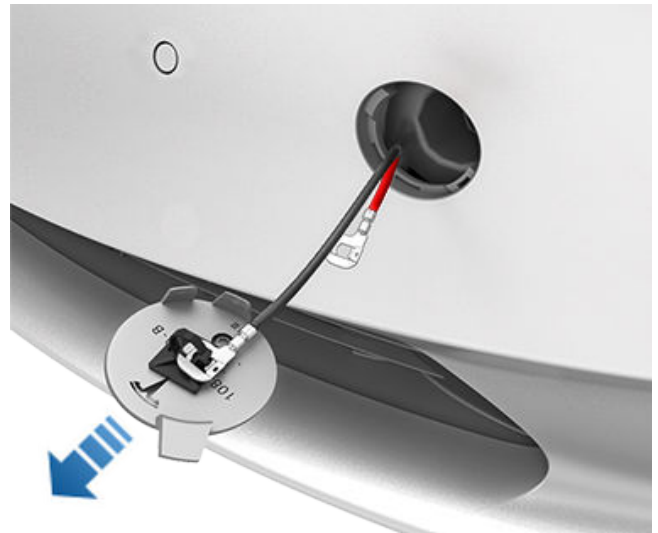

4. Connect the low voltage power supply's red positive (+) cable to the red positive (+) terminal.
5. Connect the low voltage power supply's black negative (-) cable to the black negative (-) terminal.



Front Trunk



NOTE: Applying external low voltage power to these terminals only releases the hood latches. You cannot charge the low voltage battery using these terminals.

6. Turn on the external power supply (refer to the manufacturer's instructions). The hood latches are immediately released and you can now open the hood to access the front trunk area.
7. Disconnect both cables, beginning with the black negative (-) cable.
8. If pulling the vehicle onto a flatbed truck, do not replace the tow eye cover yet. If necessary, install the tow eye cover by inserting the wires into the tow eye opening and aligning the tow eye cover into position and snapping it into place.

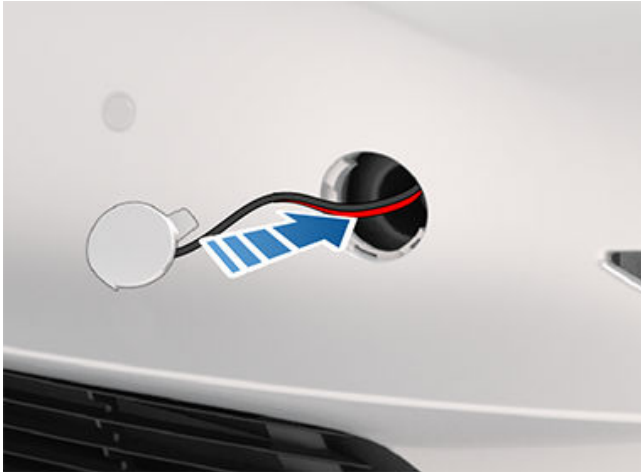



Center Console

In addition to housing an RFID transmitter that reads key fobs and key cards (see [Keys on page 12](#)), the center console includes cup holders, two storage compartments, wireless phone chargers, and a rear touchscreen.

To open the main storage compartment, pull its cover upward. Open the front storage compartment by sliding its cover forward.



Second Row Console

Your Model S has a rear console integrated in the center of the second row. This console can serve as an arm rest for rear passengers.

To lower the console, press the button on the top back of the center seat. To raise the console, push it all the way upwards.

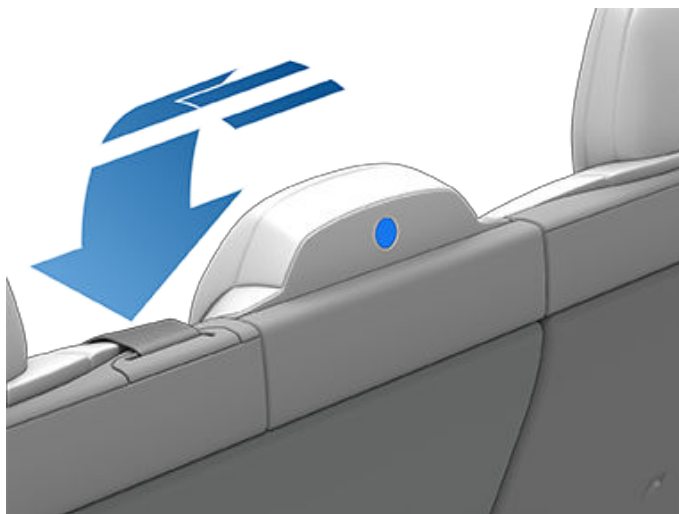

To access the storage tray and wireless phone charger (see [Wireless Phone Chargers on page 26](#)), raise the cover by pressing the latch on the underside of it and pulling it up.

Glovebox

To open the glovebox, touch **Controls** > **Glovebox**. The glovebox automatically opens and the light turns on.



To close the glovebox, push it upward until it latches into the closed position.

For additional glovebox security, touch **Controls** > **Safety** > **Glovebox PIN** to set a 4-digit PIN (see [Glovebox PIN on page 133](#)).

NOTE: If you leave the glovebox open, its light eventually turns off.

NOTE: The glovebox locks whenever closed and you lock Model S using the mobile app, key card, you leave Model S carrying your phone key (if Walk-Away Door Lock is turned on), or if Valet mode is active (see [Valet Mode on page 48](#)). It does not lock when Model S is locked by touching the lock icon on the touchscreen.

WARNING: When driving, keep the glovebox closed to prevent injury to a passenger if a collision or sudden stop occurs.

USB Ports

Model S has five USB ports:



Interior Storage and Electronics

- Two USB ports are located in the front compartment of the center console. These can be used to charge USB devices and to play audio files from a phone or USB device (see [Playing Media from Devices on page 154](#)).
- Two USB ports are located below the rear touchscreen that can be used to charge USB devices.
- One USB port is located inside the glovebox. This port is equipped with a USB flash drive. The secure location of this USB port makes it ideal for saving Sentry Mode and Dashcam video footage.

The USB ports can output power up to approximately 27W (which may vary depending on vehicle manufacture date).

See [USB Drive Requirements for Recording Videos on page 138](#) for information about formatting USB flash drives.

To access the front USB ports, open the front compartment of the center console. The front USB ports are located on the rear wall of the compartment:

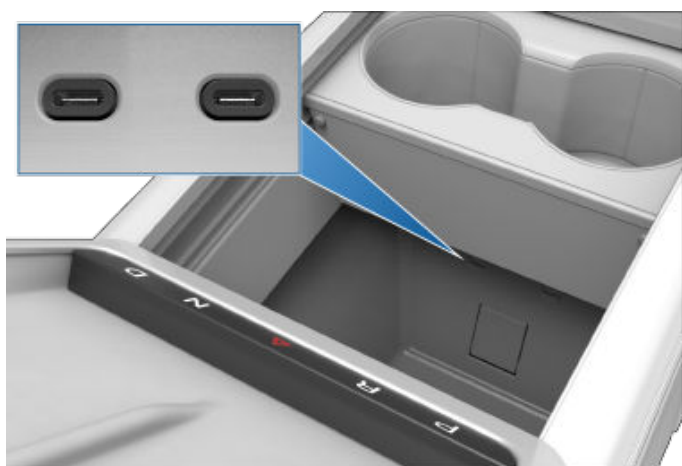

Rear USB ports are located below the rear touchscreen:

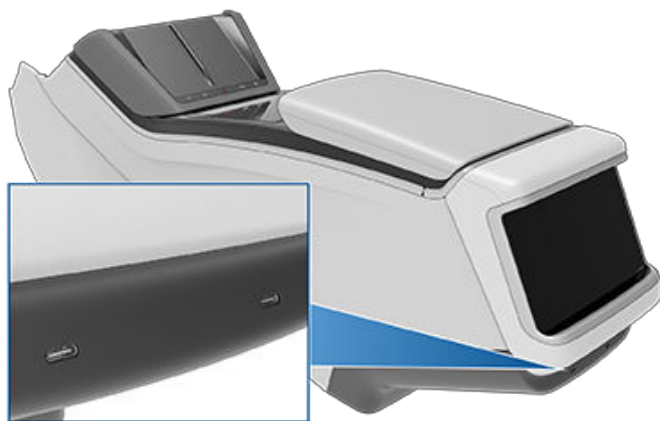

Glovebox USB port:

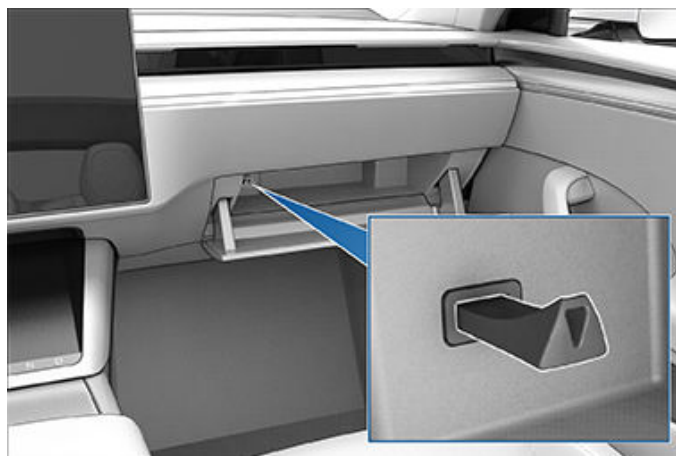

NOTE: Power is available whenever the vehicle is considered "awake". The vehicle may be awake for many reasons. For example, when using features such as Summon, or when features such as Preconditioning, Keep Climate On, Dog Mode, Camp Mode, or Sentry Mode are enabled. The vehicle is also awake whenever the low voltage battery is being charged or is in use, during high voltage charging, when the vehicle is communicating with the mobile app, etc. Leaving an accessory plugged in does not deplete the low voltage battery.

NOTE: Use USB 3.0 compliant cables to connect a device to a USB port. Using non-compliant cables can result in slower charging, potential connection problems or degraded performance.

NOTE: Do not connect multiple devices using a USB hub. This can prevent connected devices from charging or from being recognized by Media Player, Sentry Mode, Dashcam, etc.

Wireless Phone Chargers

Wireless phone chargers are integrated into both the front and rear consoles, each providing up to 15W of power to charge Qi-enabled phones. Simply place your phone on the charger. Your device may feel warm while charging, but this is a normal effect of inductive charging.





When placed on the wireless charger, your phone charges whenever the vehicle is powered on (the touchscreen is on and you are in the vehicle). Your phone does not charge when you leave the vehicle unless a feature, such as Sentry mode is enabled.

NOTE: The phone must be in direct contact with the wireless charger. Do not place objects between the phone and the charger (for example, credit cards, key cards, coins, keys, metal objects, etc.).

NOTE: The wireless phone charger may not work if your phone case is too large or is made of metal. Try removing the phone from its case before placing it on the charger.

NOTE: The wireless phone charger does not charge if the vehicle's high voltage Battery is discharged.

Low Voltage Power Socket

Your Model S has a power socket located in the center console's rear compartment. To access the low voltage socket, open the front compartment of the center console.

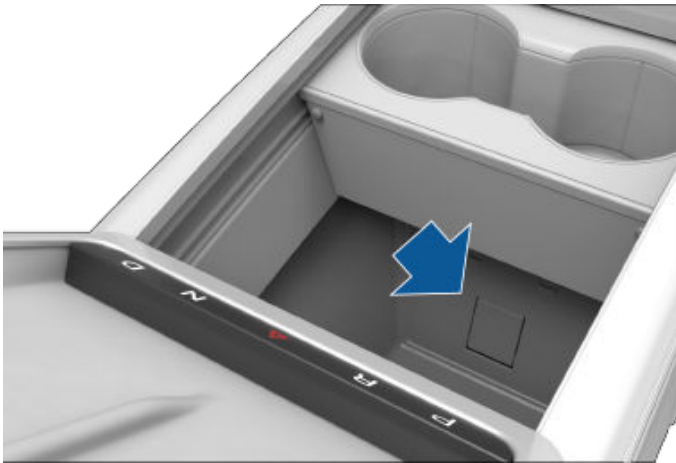

The power socket is suitable for accessories requiring up to 12A continuous draw (16A peak).

NOTE: Power is available whenever the vehicle is considered "awake". The vehicle may be awake for many reasons. For example, when using features such as Summon, or when features such as Preconditioning, Cabin Overheat Protection, Keep Climate On, Dog Mode, Camp Mode, Sentry Mode, etc. are enabled. The vehicle is also awake whenever the low voltage battery is being charged or is in use, during high voltage charging, when the vehicle is communicating with the mobile app, etc. Leaving an accessory plugged in does not deplete the low voltage battery.

WARNING: The power socket and an accessory's connector can become hot.

WARNING: To prevent excessive interference with the vehicle's electronics, Tesla recommends that you do not plug any non-Tesla accessories, including power inverters, into the low voltage power socket. However, if you do use a non-Tesla accessory and notice any malfunctions or unexpected behavior, such as indicator lights, alert messages, or excessive heat from the accessory, unplug the accessory from the low voltage power socket immediately.

NOTE: A power inverter plugged into the low voltage power socket must support 16V DC input to function.

CAUTION: Do not attempt to jump start Model S using the low voltage power socket. Doing so can result in damage.

Coat Hangers

Your Model S has a coat hanger on each side of the vehicle above the rear window in the second row, next to the reading light. Push the coat hanger to release it. Push it again to retract it.

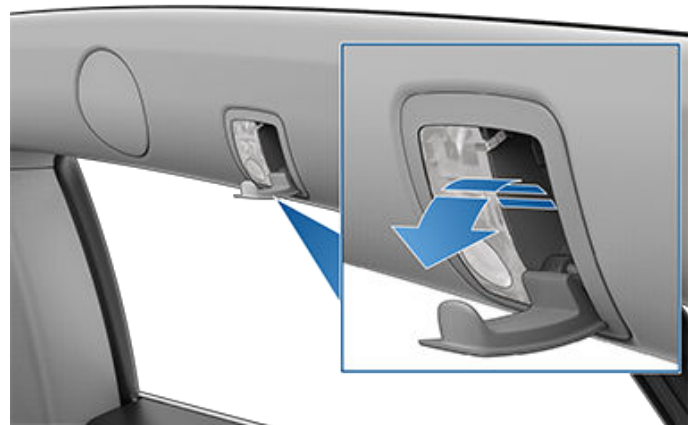

Active Road Noise Reduction

Model S is equipped with Active Road Noise Reduction which reduces low-frequency road noise while driving on rough surfaces. To accomplish this, the vehicle uses the seat microphones to measure noise in the cabin, then generates anti-noise through the speakers to intelligently create quiet zones around each occupant depending on vehicle and environmental factors.



To turn Active Road Noise Reduction on or off, open the Media Player and touch **Audio Settings icon > Options > Active Road Noise Reduction** (the audio settings icon shows an equalizer with three vertical lines). This may require several minutes of driving time to calibrate before enabling.

NOTE: To ensure active noise reduction operates effectively, avoid covering the microphones (with seat covers, etc.). Active Road Noise Reduction may disable if a window is rolled down, door is open, or the fan is turned up.

CAUTION: To prevent damage to these microphones when cleaning, do not over-saturate the area of the seats where the microphones are located.



Correct Driving Position

The seat, head support, seat belt and airbags work together to maximize your safety. Using these correctly ensures greater protection.



Position the seat so you can wear the seat belt correctly, while being as far away from the front airbag as possible:

1. Sit upright with both feet on the floor and the seat back reclined no more than 30 degrees.
2. Make sure you can easily reach the pedals and that your arms are slightly bent when holding the steering yoke (or steering wheel). Your chest should be at least 10 inches (25 cm) from the center of the airbag cover.
3. Place the shoulder section of the seat belt mid-way between your neck and your shoulder. Fit the lap section of the belt tightly across your hips, not across your stomach.

Model S front seats include integrated head supports that cannot be adjusted or removed.

Adjusting the Front Seats

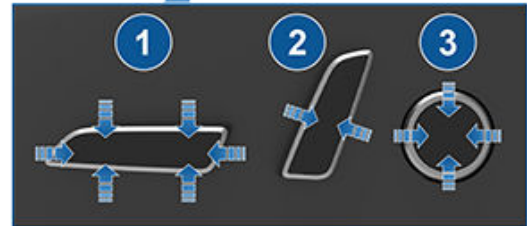

1. Move seat forward/backward and adjust the seat's height and tilt angle up/down.
2. Adjust backrest.
3. Adjust lumbar support.

⚠ WARNING: Before adjusting a front seat, check that the area around the seat is free of obstacles (people and objects).

⚠ WARNING: Do not adjust seats while driving. Doing so increases the risk of a collision.

⚠ WARNING: Riding in a moving vehicle with the seat back reclined can result in serious injuries in a collision, as you could slide under the lap belt or be propelled into the seat belt. Ensure your seat back is reclined no more than 30 degrees when the vehicle is moving.

Calibrating Seats

(If equipped) You can calibrate the driver seat. This is useful if you find your seat range limited or your driver profile does not automatically adjust the seat for you. Navigate to **Controls > Service > Driver Seat, Steering & Mirrors Calibration** and follow the instructions on the touchscreen.

WARNING: Ensure nothing is behind or underneath the driver seat during calibration. Failure to do so may cause serious injury.

Folding Rear Seats

Model S has a split rear seat that can fold forward.

Before folding, remove items from the seats and the rear footwell. To allow the rear seats to fold completely flat, you may need to move the front seats forward. To fold a rear seat, push the corresponding button on the back of the seat.

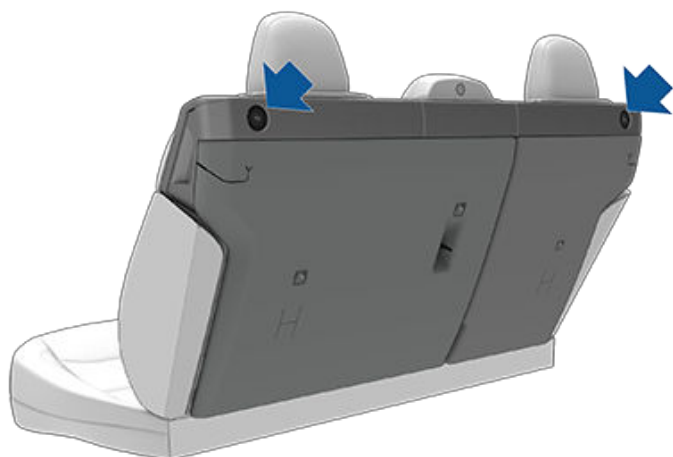

You can also fold the rear seats fully forward by pressing the corresponding switch located on the left side of the rear trunk. Pressing the switch causes the seat to unlatch. You can then push it downward to lay it fully flat.



To return the seats to their upright position, pull upwards until it locks into place. To confirm that the seat is locked in the upright position, try pulling it forward.

NOTE: Driving with the rear seats folded may increase noise in the cabin area (for example, you may hear vibration sounds coming from the rear of the vehicle such as the trunk, suspension, etc.).

CAUTION: While raising a rear seat back, hold the seat belt out of the way to ensure that the seat belt is not trapped behind the backrest or caught in the seat latch.

WARNING: Always ensure that the seats are locked in their upright position by attempting to push it forward or rearward, ensuring the latch is fully engaged. Failure to do so can increase the risk of injury.

Head Supports

The front seats include integrated head supports that you cannot adjust.

The rear outboard seating positions include an adjustable head support that can be raised/lowered or removed. The head support should always be raised and locked into position (so that the center is aligned with the center of the occupant's head) when occupied by a passenger that is not in a child safety seat.

Lift the head support to the desired position. To lower the head support, press and hold the button on the base of the outer post while pushing down on the head support.

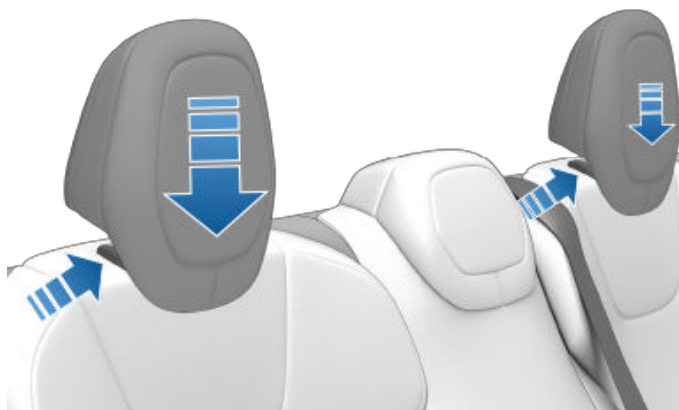

To remove a head support:

1. Lift the headrest to raise it.
2. Press and hold the button located at the base of the right post.
3. Insert a short, flat object (such as a small flat-head screwdriver) into the opening on the inside base of the opposite post and pull the head support upward.

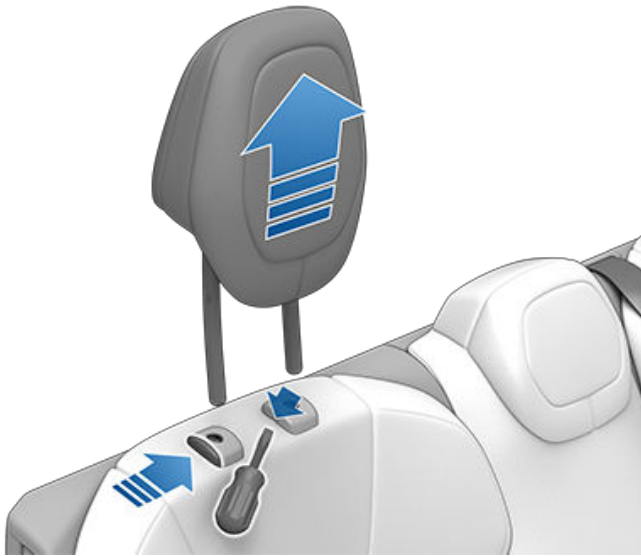

Seat Heaters

All seats contain heating pads. In addition, both front seats are ventilated. You can control seat heaters in all seating positions using the touchscreen.

- ⚠ WARNING:** To avoid burns resulting from prolonged use, individuals who have peripheral neuropathy, or whose capacity to feel pain is limited because of diabetes, age, neurological injury, or some other condition, should exercise caution when using the climate control system and seat heaters.

Seat Covers

- ⚠ WARNING:** Do not use seat covers in Model S. Doing so could restrict deployment of the seat-mounted side air bags if a collision occurs. Seat covers can also interfere with the occupant detection system that is used to determine the status of the passenger front airbag.



Seat Belts

Wearing Seat Belts

Using seat belts and child safety seats is the most effective way to protect occupants if a collision occurs. Therefore, wearing a seat belt is required by law in most jurisdictions.

Both the driver and passenger seats are equipped with three-point inertia reel seat belts. Inertia reel belts are automatically tensioned to allow occupants to move comfortably during normal driving conditions. To securely hold child safety seats, all passenger seating positions are equipped with an automatic locking retractor (ALR) feature that, by fully extracting the seat belt (beyond the length needed for a typical adult occupant), locks the belt into place until the seat belt is unbuckled.

The seat belt reel automatically locks to prevent movement of occupants if Model S experiences a force associated with hard acceleration, braking, cornering, or an impact in a collision.

Seat Belt Reminders



The seat belt reminder on the instrument panel alerts you if a seat belt for an occupied driver or passenger seat is unbuckled. If all occupants are buckled up and the reminder stays on, re-buckle seat belts to ensure they are correctly latched. Also remove any heavy objects (such as a briefcase) from an unoccupied seat. If the reminder light continues to stay on, contact Tesla.

You can temporarily disable a seat belt reminder associated with a rear seating position. This is useful when you are carrying an object in a rear seat that triggers the seat belt reminder alert. To disable the reminder, touch the associated seat on the seat belt reminder popup message that displays on the touchscreen when a seat belt reminder is active. When a reminder is disabled, the seat belt reminder icon is replaced by a seat icon, for the current drive only. Touch the seat again to re-enable the reminder.

⚠ WARNING: Seat belts must be worn by passengers in all seating positions. Do not disable a seat belt reminder when the seating position is occupied by a passenger.

To Fasten a Belt

1. Ensure correct positioning of the seat (see [Correct Driving Position on page 29](#)).
2. Draw the belt out smoothly, ensuring the belt lays flat across the pelvis, chest and mid-point of your collar bone, between the neck and shoulder.

3. Insert the latch plate into the buckle and press together until you hear a click indicating it is locked in place.

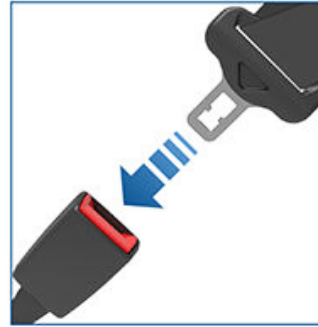

4. Pull the belt to check that it is securely fastened.
5. Pull the diagonal part of the belt toward the reel to remove excess slack.

To Release a Belt

Hold the belt near the buckle to prevent the belt from retracting too quickly, then press the button on the buckle. The belt retracts automatically. Ensure there is no obstruction that prevents the belt from fully retracting. The belt should not hang loose. If a seat belt does not fully retract, contact Tesla.

Wearing Seat Belts When Pregnant

Do not put the lap or shoulder sections of the seat belt over the abdominal area. Wear the lap section of the belt as low as possible across the hips, not the waist. Position the shoulder portion of the belt between the breasts and to the side of the abdomen. Consult your doctor for specific guidance.



⚠ WARNING: Never place anything between you and the seat belt to cushion the impact in the event of a collision.

Seat Belt Pre-tensioners

The front seat belts are equipped with pre-tensioners that work in conjunction with the airbags in a severe frontal collision. The pre-tensioners automatically retract both the seat belt anchor and the seat belt webbing, reducing slack in both the lap and diagonal portions of the belts, resulting in reduced forward movement of the occupant.

The rear outboard seats are equipped with shoulder pre-tensioners to retract the seat belt webbing to reduce forward movement of the occupant.



If the pre-tensioners and airbags did not activate in an impact, this does not mean they malfunctioned. It usually means that the strength or type of force needed to activate them was not present.

⚠ WARNING: Once the seat belt pre-tensioners have been activated, they must be replaced. After any collision, have the airbags, seat belt pre-tensioners and any associated components checked and, if necessary, replaced.

Testing Seat Belts

To confirm that seat belts are operating correctly, perform these three simple checks on each seat belt.















1. With the seat belt fastened, give the webbing nearest the buckle a quick pull. The buckle should remain securely locked.
2. With the belt unfastened, unreel the webbing to its limit. Check that unreeling is free from snags, and visually check the webbing for wear. Allow the webbing to retract, checking that retraction is smooth and complete.
3. With the webbing half unreeled, hold the tongue plate and pull forward quickly. The mechanism should lock automatically and prevent further unreeling.

If a seat belt fails any of these tests, contact Tesla immediately.

For information about cleaning seat belts, see [Seat Belts on page 180](#).





Seat Belt Warnings

-  **WARNING:** Seat belts should be worn by all occupants at all times, even if driving for a very short distance. Failure to do so increases the risk of injury or death if a collision occurs.
-  **WARNING:** Secure small children in a suitable child safety seat as described in the Child Safety Seat topic. Always follow the child safety seat manufacturer's instructions when installing.
-  **WARNING:** Ensure that all seat belts are worn correctly. An improperly worn seat belt increases the risk of injury or death if a collision occurs.
-  **WARNING:** Do not wear seat belts over hard, fragile or sharp items in clothing, such as pens, keys, eyeglasses, etc. The pressure from the seat belt on such items can cause injury.
-  **WARNING:** Seat belts should not be worn with any part of the strap twisted.
-  **WARNING:** Each seat belt assembly must be used by one occupant only. It is dangerous to put a seat belt around a child being carried on an occupant's lap.
-  **WARNING:** Seat belts that have been worn in a collision must be inspected or replaced by Tesla, even if damage to the assembly is not obvious.
-  **WARNING:** Seat belts that show signs of wear (such as fraying), or have been cut or damaged in any way, must be replaced by Tesla.
-  **WARNING:** Avoid contaminating a seat belt's components with any chemicals, liquids, grit, dirt or cleaning products. If a seat belt fails to retract or latch into the buckle, it must be replaced immediately. Contact Tesla.
-  **WARNING:** Do not make modifications or additions that can prevent a seat belt mechanism from taking up slack, or that can prevent a seat belt from being adjusted to remove slack. A slack seat belt greatly reduces occupant protection.
-  **WARNING:** Do not make modifications that can interfere with the operation of a seat belt, or that can cause a seat belt to become inoperable.
-  **WARNING:** Do not use after market comfort and convenience products that attach to the seat belts.
-  **WARNING:** When seat belts are not in use, they should be fully retracted and not hanging loose. If a seat belt does not fully retract, contact Tesla.
-  **WARNING:** The seat belt system has no user serviceable parts and may contain pyrotechnics. Do not disassemble, remove, or replace components.



Passenger Front Airbag Must Be OFF

Your Model S seat belts are designed for adults and larger children. You must restrain infants and small children in the rear seats only, and you must use a suitable child safety seat appropriate for the child's age, weight, and size.

-  **WARNING:** Never seat a child in the front passenger seat, even if using a child restraint system.
-  **WARNING:** Never seat a child on a seat with an ACTIVE AIRBAG in front of it. DEATH or SERIOUS INJURY to the child can occur.

Refer to the following label located on the sun visors.

NOTE: The image shown below is representative only and may not be identical to the label in your vehicle.





Model S has an occupancy sensor in the front passenger seat that controls the status of the passenger front airbag (see [Airbags on page 41](#)).



When driving with a child seated on the front passenger seat (if permitted), always double-check the status of the passenger front airbag to confirm that it is OFF.



To protect an adult subsequently occupying the front passenger seat, always double-check the passenger front airbag to confirm that it is ON.

-  **WARNING:** It is the driver's responsibility to confirm that the passenger front airbag is OFF when a child is seated in the front passenger seat. If the passenger front airbag fails to disable with a child seat in position, place the child and child restraint system in the rear seat and contact Tesla immediately.
-  **WARNING:** Always ensure that all Model S seats are locked in position before traveling. Failure to do so increases the risk of injury. Pay attention to all warnings displayed on the touchscreen.
-  **WARNING:** Do not associate the **Easy Entry** setting with the driver's profile when a child is seated in a rear seat. Doing so can cause the driver's seat to push against the child, especially when a child is seated in a forward-facing child seat or booster seat. Do not rely on Model S to recognize or accommodate a child seated in the rear seats while using this setting (see [Driver Profiles on page 47](#)).

Choosing a Child Safety Seat

All children age 12 and under should ride in the rear seats. Always use a child safety seat suitable for a young child's age and weight. The following table is based on child safety seat recommendations determined by National Highway Traffic Safety Administration (NHTSA). For more information, go to www.nhtsa.gov/ChildSafety/Guidance.

Category	Infants	Toddlers	Young children
Age	Birth to 1 year*	Over 1 year*	4 years and older, and less than 57 in. (145 cm) tall
Weight	Up to at least 20 lbs (9 kg)*	Over 20 lbs (9 kg) (minimum) and up to 40 lbs (18 kg)*	Over 40 lbs (18 kg)
Type of child safety seat	Rear facing (or convertible)	Forward facing (or convertible)*	Forward facing or seat belt retained booster seat****
Seat position	Rear facing only*	Rear facing as long as possible, then forward facing*	Forward facing
Recommended attachment method	If combined weight of child and safety seat is up to 65 lbs (29 kg), attach using either LATCH** (lower anchor only) or the seat belt only.*** If combined weight of child and safety seat is over 65 lbs (29 kg), attach using the seat belt only.***	If combined weight of child and safety seat is up to 65 lbs (29 kg), attach using either LATCH** (both lower anchors and top tether anchor), or the seat belt and upper tether strap.*** If combined weight of child and safety seat is over 65 lbs (29 kg), attach using the seat belt and upper tether strap.***	Attach booster seats using the seat belt only

* Many child safety seats currently available allow children to ride rear-facing using the child safety seat's integrated 5-point harness for a longer period of time **BASED UPON SPECIFIC HEIGHT AND WEIGHT LIMITS**. Keep your child in a rear facing seat for as long as possible. **CHECK THE CHILD SAFETY SEAT MANUFACTURER'S INSTRUCTIONS AND CAREFULLY FOLLOW ALL INSTRUCTIONS.**

** **LATCH** ("Lower Anchors and Tethers for Children") and **ISOFIX** are international standards for attachment points for [child safety seats](#) in passenger cars that enable compliant child safety seats to be quickly and safely secured. The system has other regional names including **LUAS** ("Lower Universal Anchorage System") or **Canfix** in Canada. It has also been called the "Universal Child Safety Seat System" or **UCSSS**.

*** Subject to instructions provided by the child safety seat manufacturer.

****Keep your child in a forward facing child safety seat with a harness and tether until the child reaches the child safety seat's maximum allowable height or weight as specified by the manufacturer of the child safety seat.

 **WARNING:** Do not use LATCH anchors with child safety seats or booster seats that have an integral safety belt where the combined weight of the child plus the child safety seat exceeds 65 lbs (29.5 kg).

 **WARNING:** Laws that govern how and where children should be carried when traveling in a vehicle are subject to change. It is the driver's responsibility to keep up to date on, and comply with, all current regulations in the region(s) where Model S is driven. To check the child passenger safety laws for states in the U.S., go to: http://www.ghsa.org/html/stateinfo/laws/childsafety_laws.html.



Seating Larger Children

If a child is too large to fit into a child safety seat, but too small to safely fit into the standard seat belts, use a booster seat appropriate for the child's age and size. Carefully follow the manufacturer's instructions to secure the booster seat.

Installing Child Safety Seats

There are two general methods used to install child safety seats:

- Seat belt retained - these seats are secured using the vehicle's seat belts. All passenger seating positions in Model S support the use of seat belt retained child safety seats.
- LATCH retained - these seats attach to anchor bars built into the vehicle's rear seats. The rear outboard seating positions in Model S support the use of LATCH retained child safety seats.

Check the child safety seat manufacturer's instructions and the table in this manual to determine which installation method to use. Some child safety seats can be installed using either method. Always follow the child safety seat manufacturer's instructions.

Installing Seat Belt Retained Child Seats

First, make sure that the child safety seat is appropriate for the weight, height, and age of the child.

Avoid dressing the child in bulky clothing and do not place any objects between the child and the restraint system.

Adjust harnesses for every child, every trip.

To securely hold child safety seats, all passenger seating positions are equipped with an automatic locking retractor (ALR) feature that, by fully extracting the seat belt (beyond the length needed for a typical adult occupant), locks the belt into place until the seat belt is unbuckled and the webbing is fully retracted. The ALR mechanism operates as a ratchet, winding in slack and preventing the seat belt from extending any further until it has been completely rewound. When installing a child safety seat with integrated restraints, engage the belt's automatic locking retractor by pulling the seat belt webbing until it is **fully** extended. The ALR system engages only when the seat belt is at its maximum extension point.

The automatic locking retractor (ALR) feature is not used for booster seats in which a large child is restrained by the vehicle's seat belts directly, and therefore not using a child safety seat's integrated restraints.

NOTE: An automatic locking retractor disengages only when the seat belt is unbuckled and fully retracted. The belt can then be worn as a normal belt, sliding freely in and out and locking tight only in an emergency. Once disengaged, the belt must be fully extended to re-engage the locking mechanism whenever you install a child safety seat.

Always follow the detailed instructions provided by the child safety seat manufacturer. General guidelines are provided below.

1. Place the child safety seat in Model S, and fully extend the seat belt. Route and buckle the seat belt in accordance with the child safety seat manufacturer's instructions.



2. Allow the seat belt to retract, and remove all slack in the seat belt while firmly pushing the child safety seat into the Model S seat.
3. Attach the upper tether strap(s), as required by the manufacturer of the child restraint system (see [Attaching Upper Tether Straps on page 39](#)).

Installing ISOFIX (LATCH) Child Seats

Lower LATCH anchors are provided in the rear outboard seats. The anchors are located between the seat's rear back rest and lower cushion. The exact location of each anchor is identified by a child safety seat identification button, illustrated below. The button is located on the seat back, directly above its associated anchor.

Child Safety Seats



In the rear seats, install LATCH child safety seats in the outboard seating positions only. Use only a seat belt retained seat in the center position.



Carefully read and follow the instructions provided by the manufacturer of the child restraint system. The instructions describe how to slide the child restraint system onto the seat's anchor bars until you hear it "click" into place. You may need to push the child restraint system firmly against the seat back to ensure it fits snugly. The flap (if equipped) remains open when the child seat is installed.

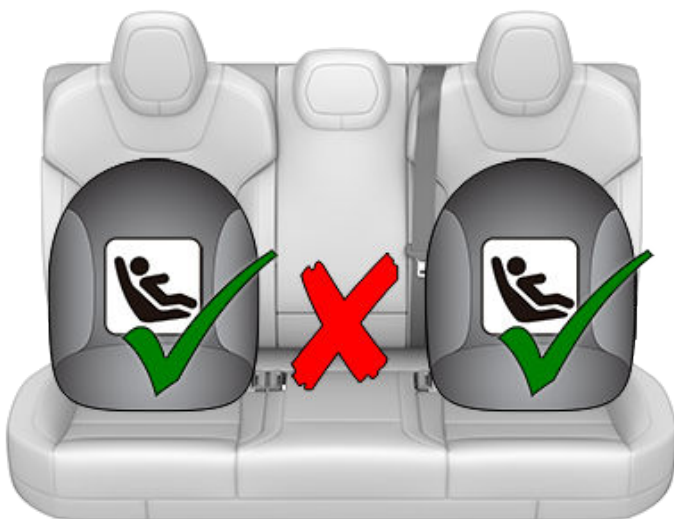

To install a LATCH child safety seat, lift the flap (if equipped) to allow access to the anchors.



Adjust until the child restraint system is fitted firmly against the seat back. Ensure the child restraint system fits snugly.



Before seating a child, ensure that the child restraint system is securely installed. Grasp the front of the child restraint system with one hand on each side, and attempt to:

- Twist the child restraint system from side to side.
- Pull the child restraint system away from the seat.

If the child restraint system moves away from the seat, both latches are not fully engaged onto the seat's anchor bars. You must reinstall it and try again. It is critical that both latches on the child restraint system are fully engaged.

⚠ WARNING: Do not use LATCH anchors with child seats or booster seats that have an integrated safety belt where the combined weight of the child plus the child restraint system exceeds 65 lbs (29.5 kg).

Attaching Upper Tether Straps

If an upper tether strap is provided, attach its hook to the anchor point located on the back of the rear seats.

NOTE: The location of anchor points may not be readily visible but can be found by identifying a slice in the seat's material.

⚠ WARNING: Tighten upper tether straps according to the instructions provided by the manufacturer of the child safety seat.

⚠ WARNING: USE ONLY SEAT BELT RETAINED CHILD SAFETY SEATS IN THE CENTER SEATING POSITION.

For dual-strap tethers, position the straps as shown.

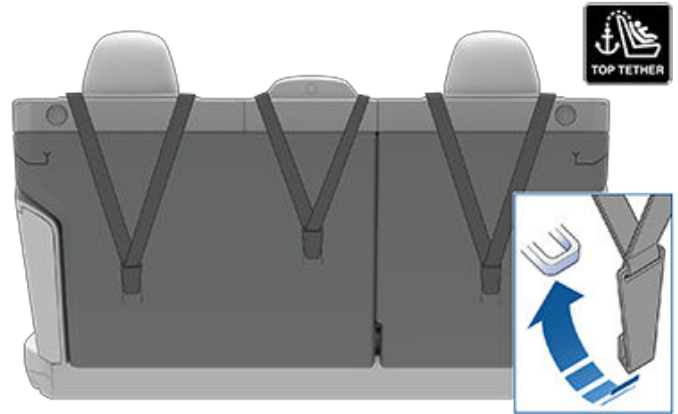

Position single-strap tethers for the outboard seating positions to run on the outside of the head support. Position a single strap in the center seating position to run over the top of the seat as illustrated.

NOTE: To prevent the single-strap tether in the center seating position from moving side to side, the top of the seat deforms.

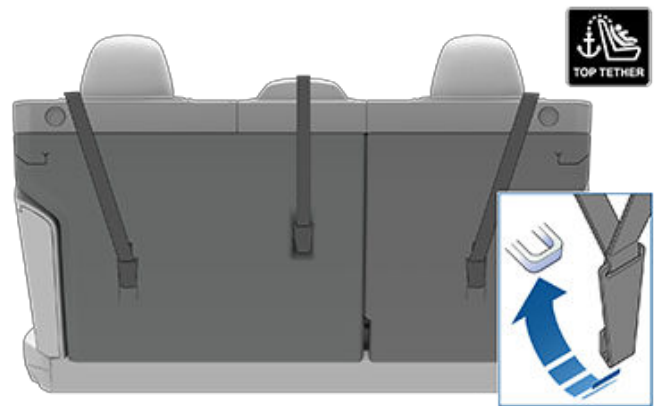

Testing a Child Safety Seat

Before seating a child, always make sure the child safety seat is not loose:













1. Hold the child safety seat by the belt path and try to slide the safety seat from side to side and front to back.
2. If the seat moves more than one inch (2.5 cm), it is too loose. Tighten the belt or reconnect the LATCH retained child safety seat.
3. If you are unable to reduce slack, try a different seat location or try another child safety seat.

Child Safety Seat Warnings

⚠ WARNING: Extreme hazard! Do not seat a child on the front passenger seat even if you are using a child safety seat. This seat has an airbag in front of it. Although this airbag is disabled when Model S detects a lightweight passenger, do not rely on technology to protect your child.



Child Safety Seats

-  **WARNING:** Child restraint systems are designed to be secured in vehicle seats by lap belts or the lap belt portion of a lap-shoulder belt. Children could be endangered in a crash if their child restraints are not properly secured in the vehicle.
-  **WARNING:** According to collision statistics, children are safer when properly restrained in the rear seating positions than in the front seating positions.
-  **WARNING:** Do not use a forward facing child safety seat until your child weighs over 20 lbs (9 kg) and can sit independently. Up to the age of two, a child's spine and neck are not sufficiently developed to avoid injury in a frontal impact.
-  **WARNING:** Do not allow a baby or infant to be held on a lap. All children should be restrained in an appropriate child safety seat at all times.
-  **WARNING:** To ensure children are safely seated, follow all instructions provided in this document and by the manufacturer of the child safety seat.
-  **WARNING:** Children should ride in a rear facing child safety seat using the seat's integrated 5-point harness for as long as possible.
-  **WARNING:** Do not use seat belt extenders on a seat belt that is being used to install a child safety seat or booster seat.
-  **WARNING:** When seating larger children, make sure the child's head is supported and the child's seat belt is properly adjusted and fastened. The shoulder portion of the belt must be away from the face and neck, and the lap portion must not be over the stomach.
-  **WARNING:** Never attach two child safety seats to one anchor point. In a collision, one anchor point may be incapable of securing both seats.
-  **WARNING:** Child restraint anchors are designed to withstand only those loads imposed by correctly fitted child restraints. Under no circumstances are they to be used for adult seat belts, harnesses, or for attaching other items or equipment to the vehicle.
-  **WARNING:** Always check harnesses and tether straps for damage and wear.
-  **WARNING:** Never leave a child unattended, even if the child is secured in a child safety seat.
-  **WARNING:** Never use a child safety seat that has been involved in a collision. Have the seat inspected or replaced as described in the child safety seat manufacturer's instructions.

Location of Airbags

Airbags are located in the approximate areas shown below. Airbag warning information is printed on the sun visors.

Model S is equipped with an airbag and lap/shoulder belt at both front seating positions. The airbag is a supplemental restraint at those seating positions. All occupants, including the driver, should always wear their seat belts whether or not an airbag is also provided at their seating position to minimize the risk of severe injury or death in the event of a crash.

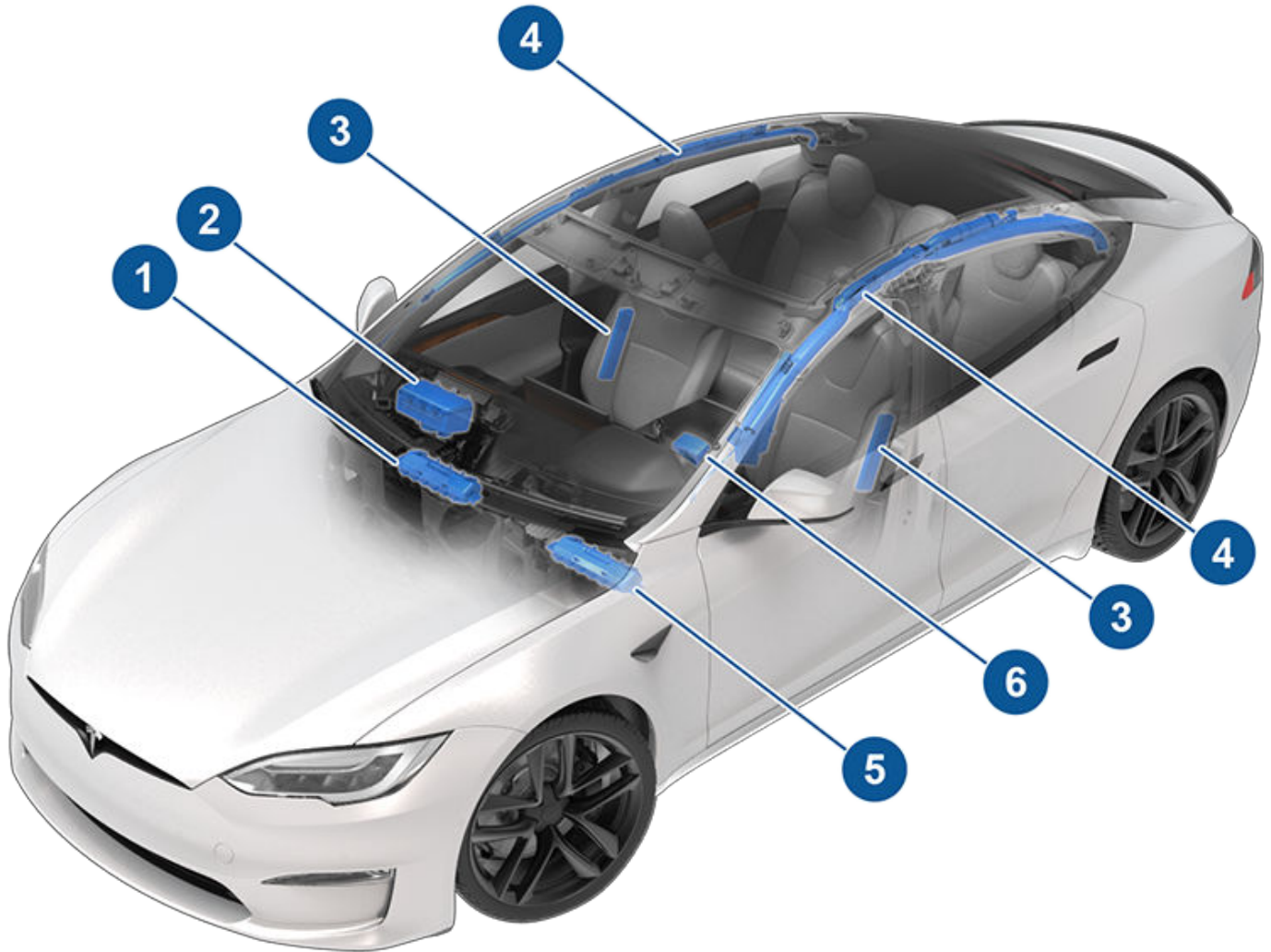

1. Passenger knee airbag
2. Passenger front airbag
3. Seat-mounted side airbags
4. Curtain airbags
5. Driver's knee airbag
6. Driver's front airbag

How Airbags Work

Airbags inflate when sensors detect an impact that exceeds deployment thresholds. These thresholds are designed to predict the severity of a crash in time for the airbags to help protect the vehicle's occupants. Airbags inflate instantly with considerable force accompanied by a loud noise. The inflated bag, together with the seat belts, limits movement of occupants to reduce the risk of injury.

Front airbags are not ordinarily designed to inflate in rear collisions, rollovers, side collisions and when braking heavily or driving over bumps and potholes. Likewise, front airbags may not inflate in all frontal collisions, such as minor front collisions, underride collisions, or minor impacts with narrow objects (such as posts or poles). Significant superficial damage can occur to the vehicle without the airbags inflating and, conversely, a relatively small amount of structural damage can cause airbags to inflate. Therefore, the external appearance of the vehicle after a collision does not represent whether or not the front airbags should have inflated.

 **WARNING:** Before modifying your vehicle to accommodate a person with disabilities in a way that may affect the airbag system, contact Tesla.

Types of Airbags

Model S has the following types of airbags:

- **Front airbags:** The front airbags are designed to reduce injuries if larger children or adults are riding in the front seats. Follow all warnings and instructions related to seating a child on the front passenger seat (if permitted in your market region).
- **Knee airbags:** Knee airbags and the front airbags work together. The knee airbags limit the forward motion of the front seat occupants by restricting leg movement, thereby positioning the occupants so that the front airbags work more effectively.
- **Side airbags:** Side airbags protect the thorax region of the torso and the pelvis. They inflate only if a severe side impact occurs. Side airbags on the non-impacted side of the vehicle do not inflate.
- **Curtain airbags:** Curtain airbags help protect the head. Curtain airbags on both the impacted and non-impacted side of the vehicle inflate only if a severe side impact occurs, or if the vehicle rolls over.

Airbag Status Indicator

The status of the passenger front airbag displays on the touchscreen:



The Passenger Airbag Off indicator displays on the touchscreen when the passenger front airbag is OFF. When the passenger front airbag is OFF, it does not inflate when a collision occurs. This indicator also displays when the seat is unoccupied. When driving with a child seat on the front passenger seat (if permitted in your market region), always double-check the status of the passenger front airbag to confirm that it is OFF.



To protect an adult occupying the front passenger seat, ensure the passenger front airbag is ON. When the passenger airbag is ON, it may inflate when a collision occurs.

Front Passenger Occupant Detection

Model S has an occupancy sensor in the front passenger seat that controls the status of the front airbag.

NOTE: The occupancy classification system (OCS) automatically detects when inflating the passenger front airbag would be unnecessary or potentially harmful.

 **WARNING:** Seating an infant in a rear facing child restraint system on a seat equipped with an operational airbag can cause serious injury or death.

Object Classification	OCS Passenger Airbag Status*	Indicator status	Notes
Empty	OFF	PASSENGER AIRBAG OFF	
Object	OFF or ON	PASSENGER AIRBAG OFF or PASSENGER AIRBAG ON	Depends on material/ contents.
Rear facing child seat designed for children up to a year old	OFF	PASSENGER AIRBAG OFF	20 lbs (9 kg) or less
Forward facing child seat	OFF	PASSENGER AIRBAG OFF	35 lbs (16 kg) or less
Child in a booster seat	OFF or ON	PASSENGER AIRBAG OFF or PASSENGER AIRBAG ON	20-100 lbs (9-45 kg)*
Large child	OFF or ON	PASSENGER AIRBAG OFF or PASSENGER AIRBAG ON	
5th percentile female or larger (by weight)	ON	PASSENGER AIRBAG ON	Over approximately 100 lbs (45 kg)

*If the passenger airbag status indicator does not match the situation, do not use the seat. The passenger must ride in a different seat. Contact Tesla Service.

NOTE: It takes approximately six seconds after you power on Model S for the occupant classification system (OCS) to report accurate status of the front passenger airbag. As a result, when you first power on Model S, even in situations when it should be OFF because the seat is occupied by a weight of 20 lbs (9 kg) or less, a delay of approximately six seconds can occur before the touchscreen displays the PASS AIRBAG OFF status. If it fails to do so, contact Tesla Service and do not seat a child in the front passenger seating position.

To make sure the sensing system can correctly detect occupancy status, eliminate the following:

- Objects lodged under the seat.
- Heavy objects sitting on the seat (briefcase, large purse).
- Objects wedged between the seat back and seat cushion.
- Cargo interfering with the seat.
- Aftermarket items attached to, or sitting on or between, the seat and occupant including but not limited to covers, mats, blankets, etc.

These conditions can interfere with the occupancy sensor. If you have eliminated the above possibilities, and the airbag status is still incorrect, ask passengers to ride in the rear seats and contact Tesla to have the airbag system checked.

NOTE: The front passenger occupancy sensor affects the operation of the passenger front airbags only. The side airbags are not affected.

 **WARNING:** If the front passenger airbag is not turning on or off as expected based on the weight thresholds previously described, contact Tesla immediately.

 **WARNING:** It is the driver's responsibility to confirm that the passenger front airbag is OFF when a child is seated in the front passenger seat (if permitted). If the passenger front airbag fails to disable with a child seated in position, place the child and child restraint system in the rear seat and contact Tesla immediately.



Airbags

- WARNING:** Never seat a child in the front passenger seat. DEATH or SERIOUS INJURY to the child can occur. Per recommendations by the National Highway Traffic Safety Administration, all occupants age 12 and under must ride in the rear seats.
- WARNING:** Do not use seat covers on Model S. Doing so could restrict deployment of the seat-mounted side air bags if a collision occurs. It can also reduce the accuracy of the occupant detection system and the noise-canceling microphones, if equipped.

Ensuring Accurate Occupant Detection

To help ensure an occupant in the front passenger seat can be accurately detected, the passenger must:

- Wear a seat belt.
- Sit upright on the center of the seat cushion, with shoulders resting against the seat back and legs extended comfortably in front with feet on the floor. See [Examples of Correct and Incorrect Seating Positions on page 44](#).
- Remain positioned on the seat cushion and not lift their weight off the seat (for example, by pushing their feet against the floor or pressing on the center console or armrest to lift up).
- Never wear thick, wet, or bulky clothing (such as ski wear or padded clothing).

In addition to the items listed above, the following situations can interfere with the accuracy of the occupant classification system:

- Placing a radio transmitter (for example, a hunting radio or walkie-talkie) on the front passenger seat.
- Placing an AC/DC inverter, or a device that is being powered by the inverter (for example, a cell phone, tablet, or computer) on the front passenger seat cushion.
- Placing liquid (such as a bottled drink) or food containers on a car seat when a child seat is present.
- Objects lodged under the seat or wedged between the seat back and cushion.
- Heavy objects sitting on the seat (briefcase, large purse).
- Cargo interfering with the seat.
- Aftermarket items attached to or placed between the seat and the occupant, such as covers, mats, blankets, etc.

These conditions can interfere with the occupancy sensor. If you have eliminated the above possibilities, and the airbag status is still incorrect, instruct passengers to ride in the rear seats and contact Tesla to have the airbag system checked.

NOTE: The front passenger occupancy sensor affects the operation of the passenger front and side airbags.

- WARNING:** Tesla follows NHTSA (National Highway Traffic Safety Administration) recommendations that all occupants age 12 and under be seated in a rear seat.
- WARNING:** Failure to follow the above instructions can adversely affect the Occupant Classification System (OCS) which can cause serious injury or death.
- WARNING:** If the front passenger airbag is not turning on or off as expected, do not seat a passenger in the front passenger seat. Contact Tesla Service.
- WARNING:** To ensure accuracy of the occupant detection system, do not make any modifications to the front passenger seat and do not use seat covers. Modifying the seat, or using seat covers, can restrict deployment of the seat-mounted side air bags if a collision occurs. It can also reduce the accuracy of the occupant classification system.

Examples of Correct and Incorrect Seating Positions

Correct seating position:



Incorrect seating position - the passenger's feet must be on the floor:



Incorrect seating position - the passenger must not slide forward on the seat cushion:



Incorrect seating position - the passenger must not recline the backrest to a laying down position when the vehicle is moving:



Inflation Effects

⚠ WARNING: When airbags inflate, a fine powder is released. This powder can irritate the skin and should be thoroughly flushed from the eyes and from any cuts or abrasions.

After inflation, the airbags deflate to provide a gradual cushioning effect for the occupants and to ensure the driver's forward vision is not obscured.

If airbags have inflated, or if your vehicle has been in a collision, always have the airbags, seat belt pretensioners and any associated components checked and, if necessary, replaced by Tesla.

In a collision, in addition to the airbags inflating:

- Doors unlock, and the door handles extend.
- Hazard warning lights turn on.
- Interior lights turn on.
- High voltage is disabled (you must contact Tesla Service to restore high voltage power).
- Seat belt pretensioners retract the seat belt anchor and seat belt webbing.

NOTE: Depending on the nature of the impact and the forces involved, doors may not unlock in a collision and/or damage may prevent them from opening. In such cases, the door may need to be opened using the interior manual release, or other means of extrication (for example, exiting through another door, breaking the window, etc.).

Airbag Warning Indicator



The airbag indicator on the instrument cluster remains lit if the airbag system is malfunctioning. The only time this indicator should illuminate is briefly when Model S first powers up, in which case it turns off within a few seconds. If it remains illuminated, contact Tesla immediately and do not drive.









Airbag Warnings

⚠ WARNING: Do not place objects over or near airbags because any such objects could cause harm if the vehicle is in a crash severe enough to cause the airbag to inflate.

⚠ WARNING: All occupants, including the driver, should always wear their seat belts, whether or not an airbag is also provided at their seating position, to minimize the risk of severe injury or death in the event of a collision.



Airbags

-  **WARNING:** Front seat occupants should not place their arms over the airbag module, as an inflating airbag can cause fractures or other injuries.
-  **WARNING:** Do not use seat covers on Model S. Doing so could restrict deployment of the seat-mounted side air bags if a collision occurs. It can also reduce the accuracy of the occupant detection system and the noise-canceling microphones, if equipped.
-  **WARNING:** Airbags inflate with considerable speed and force, which can cause injury. To limit injuries, ensure that occupants are wearing seat belts and are correctly seated, with the seat positioned as far back as possible. The National Highway Traffic Safety Administration (NHTSA) recommends a minimum distance of 10" (25 cm) between an occupant's chest and an airbag.
-  **WARNING:** Children should not be seated on the front passenger seat unless permitted by regulations in your market region. Follow all regulations in your region for the appropriate way to seat a child based on the child's weight, size, and age. The safest place to seat infants and young children is in a rear seating position. Seating an infant or child in a rear-facing child restraint system on a seat equipped with an operational airbag can cause serious injury or death.
-  **WARNING:** To ensure correct inflation of the side airbags, maintain an unobstructed gap between an occupant's torso and the side of Model S.
-  **WARNING:** Passengers shouldn't lean their heads against doors. Doing so can cause injury if a curtain airbag inflates.
-  **WARNING:** Do not allow passengers to obstruct the operation of an airbag by placing feet, knees or any other part of the body on or near an airbag.
-  **WARNING:** Do not attach or place objects on or near the front airbags, the side of the front seats, the headliner at the side of the vehicle, or any other airbag cover that could interfere with inflation of an airbag. Objects can cause serious injury if the vehicle is in a collision severe enough to cause the airbag to inflate.
-  **WARNING:** Following inflation, some airbag components are hot. Do not touch until they have cooled.



When you first adjust the driver's seat, steering yoke (or steering wheel) position, or exterior side mirrors, the touchscreen prompts you to create a driver profile to save these adjustments. Your profile also saves various preferences you make while customizing Model S. See [Using Tesla Profiles on page 47](#) to learn more about saving profile settings to the cloud for easy access across multiple Tesla vehicles.



To add a new driver profile, touch the driver profile icon at the top of the touchscreen. Then touch **Driver Profile Settings** > **Add New Driver**, type the driver's name and touch **Create Profile**. Follow the onscreen instructions to save mirror and steering wheel position to the driver profile. Check the **Use Easy Entry** checkbox if you want to save (or use existing) **Easy Entry** settings in which the driver's seat and the steering yoke (or steering wheel) are automatically adjusted to make it easy to enter and exit Model S.

If you change the position of the driver's seat, steering yoke (or steering wheel), or exterior side mirrors after you have saved or chosen a driver profile, the touchscreen prompts you to **Save** the new position or **Restore** the previously saved position (other settings are automatically saved). To change a setting without saving or restoring, just ignore the prompt.

To delete a driver profile, touch the driver profile icon at the top of the touchscreen, touch **Driver Profile Settings** and select the driver profile you would like to remove. Once selected, there is an option to **Delete** the driver profile.

NOTE: Valet mode is a built-in driver profile that limits speed and restricts access to some Model S features (see [Valet Mode on page 48](#)).

NOTE: To stop automatic adjustments that are in process based on a driver's profile, touch **Stop** on the Driver Profile dropdown menu. Automatic adjustments also stop if you manually adjust a seat, mirror, or the steering yoke (or steering wheel).

Selecting Between Driver Profiles



To adjust Model S based on a driver's profile, touch the driver profile icon at the top of the **Controls** screen. Then choose the driver, and Model S is adjusted based on the settings that have been saved to the chosen driver profile. See [Using Tesla Profiles on page 47](#) to learn more about saving profile settings to the cloud for easy access across multiple Tesla vehicles.

Using Tesla Profiles

Driver profile settings, such as seat adjustments, temperature preferences, navigation Recents and Favorites, media settings, and data sharing preferences can be saved into a Tesla Profile that is synced to every supported vehicle under your Tesla Account. This provides convenient access to your profile settings and preferences across all your Tesla supported vehicles.

To set up your Tesla Profile, navigate to **Driver Profile Settings** and select your Tesla Account name. You can choose to set it up as a New Profile or copy the settings from an existing driver profile that you were previously using.

To set up a Tesla Profile for additional drivers, share your vehicle with them from the mobile app and navigate to **Security** > **Add Driver**. Their Tesla Profile will appear in the Driver Profile settings after accepting the invitation from their Tesla Account. For more information on granting mobile app access, see [Granting Access to a Second Driver on page 146](#). In addition, you can change your profile picture from your Tesla Mobile App.

NOTE: Some vehicle settings, such as seat, mirror, steering wheel, and air vent positions are only synced between the same vehicle models. If the seat or steering positions do not restore as expected, touch **Controls** > **Service** > **Seat & Steering Calibration** on the affected vehicles.

NOTE: Tesla Profiles are supported on vehicles with software versions 2022.24 or higher.

Your Tesla Profile will be removed from any vehicle not associated with your Tesla Account.

Saved Settings

A subset of the settings that you choose to customize your Model S are automatically saved to your driver's profile. Once saved, a green check mark appears next to the driver profile icon on the touchscreen. Examples of automatically saved driver profile settings are:

- Navigation, temperature, lights and display settings.
- Autopilot and driving preferences.

Linking a Driver Profile to a Key

You can link a driver profile to a key (or keys) to allow Model S to automatically select the correct driver profile when the linked key is detected as you approach the vehicle and open the driver's door. To link a driver profile to a key, first ensure you are using your desired driver profile, then touch **Controls** > **Locks** > **Keys**. You can toggle the driver icon to link or delete a key to the desired driver profile. The name of the driver profile appears under the key to show that it is linked.



Driver Profiles

NOTE: Model S supports up to 10 driver profiles. You can link multiple keys to a driver profile, but you cannot link multiple driver profiles to a single key.

Easy Entry

You can define an Easy Entry setting that moves the steering yoke (or steering wheel) and driver's seat to make it easy to enter and exit Model S. Any driver can use the Easy Entry setting by associating it with their driver profile. When the Easy Entry setting is associated with a driver profile, the steering yoke (or steering wheel) and driver's seat automatically adjust when in Park and the driver's seat belt is unbuckled, allowing an easy exit from Model S. When returning to the vehicle and stepping on the brake pedal, settings automatically adjust back to the settings used by the most recent driver profile (or based on the key if it's linked to a driver profile).

To use **Easy Entry** with a driver profile, ensure the **Use Easy Entry** box is checked.

WARNING: Never use Easy Entry to move the driver's seat to the full rearward position when a child safety seat is installed on a rear seat located behind the driver's seat. With reduced clearance, the movement of the seat may impact a child's legs, cause injury, or dislodge the seat.

Valet Mode

When Model S is in Valet mode, the following restrictions apply:

- Key card must be used to access and drive Model S.
- Speed is limited to 70 mph (113 km/h).
- Maximum acceleration and power are limited.
- Front trunk and glovebox are locked.
- Home and Work locations are not available in the navigation system.
- Voice commands are disabled.
- Autopilot convenience features are disabled.
- The Allow Mobile Access setting cannot be changed.
- HomeLink (if available in your market region) is not accessible.
- Driver Profiles are not accessible.
- Wi-Fi and Bluetooth are disabled. When Model S is in Valet mode, you cannot pair new Bluetooth devices or view or delete existing paired devices. However, if a Bluetooth-paired device or a known Wi-Fi network is within range, Model S connects to it.

NOTE: Model S does not automatically shift when in Valet Mode.

Starting Valet Mode

With Model S in Park, touch the driver profile icon at the top of the **Controls** screen, then touch **Valet Mode**.

The first time you enter Valet mode, the touchscreen prompts you to create a 4-digit PIN you will use to cancel Valet mode.

When Valet mode is active, the instrument panel displays the word **Valet** while the driver profile changes to **Valet Mode** on the touchscreen.

You can also use the mobile app to start and cancel Valet mode (if Model S is in Park). When using the mobile app, you do not need to enter a PIN because you are already required to log into the app using your Tesla Account credentials.

NOTE: If the **PIN to Drive** setting is enabled (see [PIN to Drive on page 133](#)), you must enter the driving PIN before you can define or enter a Valet PIN. Once in Valet mode, Model S can be driven without the valet needing to enter the driving PIN.

NOTE: The **PIN to Drive** setting is not available when Valet mode is active.

If you forget your valet PIN, reset it from inside Model S by entering your Tesla Account credentials (which also cancels Valet mode). You can also reset your PIN using the mobile app.

Canceling Valet Mode

With Model S in Park, touch the **Valet Mode** driver profile icon at the top of the **Controls** screen, and enter your 4-digit PIN.

When you cancel Valet mode, all settings associated with the most recently used driver profile and climate control settings are restored, and all features are available.

NOTE: You do not need to enter a PIN to cancel Valet mode from the mobile app.



Adjusting the Steering Yoke (or Steering Wheel) Position

Depending on options purchased, you may have either a steering yoke or a steering wheel: the design may differ but the function is the same.

To adjust the steering yoke (or steering wheel), touch **Controls** and touch the **Steering** icon.

Use the left scroll button on the steering yoke (or steering wheel) to move the steering yoke (or steering wheel) to the desired position:

- To adjust the height/tilt angle of the steering yoke (or steering wheel), roll the left scroll button up or down.
- To move the steering yoke (or steering wheel) closer to you, or further away from you, press the left scroll button to the left or right.



WARNING: Do not make steering yoke (or steering wheel) adjustments while driving.

Adjusting Steering Effort

You can adjust the feel and sensitivity of the steering system to suit your personal preference:

1. On the touchscreen, touch **Controls** > **Pedals & Steering** > **Steering Mode**.
2. Choose a steering option:
 - **Comfort** - Reduces the effort required to turn the steering yoke (or steering wheel). In town, Model S feels easier to drive and park.
 - **Standard** - Tesla believes that this setting offers the best handling and response in most conditions.
 - **Sport** - Increases the effort required to turn the steering yoke (or steering wheel). When driving at higher speeds, Model S feels more responsive.

Overview of Buttons

Your Model S features stalkless driving in which all controls you need when driving are accessible on the steering yoke (or steering wheel).



1. Right turn signal (see [Turn Signals](#) on page 60).
2. High beam headlights* (see [High Beam Headlights](#) on page 58).
3. Left turn signal (see [Turn Signals](#) on page 60).
4. Left scroll button (see [Left Scroll Button](#) on page 49).
5. Horn (see [Horn](#) on page 50).
6. Identifier that is always illuminated to indicate that the right scroll wheel can be used with cruise control.
7. Wipers* (see [Wipers and Washers](#) on page 65).
8. Right scroll button (see [Right Scroll Button](#) on page 50).
9. Voice commands (see [Voice Commands](#) on page 131).

*The behaviors associated with the buttons for headlight high beams and wipers vary depending on whether you press or press and hold the button. Refer to the corresponding sections in this Owner's Manual for details.

NOTE: Simultaneously holding down both the left and right scroll buttons while Model S is parked causes the touchscreen to restart (see [Restarting the Touchscreen](#) on page 8).

Left Scroll Button

Use the scroll button on the left side of the steering yoke (or steering wheel) to adjust the position of the mirrors and steering yoke (or steering wheel). It also controls the wipers and media player.



Steering Yoke (or Steering Wheel)



- When using media player, push the button to the left to go back to the previous song or station or push it to the right to skip to the next song or station.
- To increase/decrease the volume of the sound system, roll the button up/down respectively.
NOTE: The scroll button adjusts the volume for media and phone calls based on what is currently in use. As you adjust the volume, the touchscreen displays the volume level and whether you are adjusting volume for media or phone.
- To mute the media volume, or to pause/play an audio file, push the scroll button.
- When adjusting mirrors, push the button to the left/right to move the associated mirror inward/outward and up/down to position the mirror upward or downward (see [Mirrors on page 52](#)).
- When adjusting the position of the steering yoke (or steering wheel), roll the button up/down to adjust the tilt/angle and press the button to the left or right to move the steering yoke (or steering wheel) closer or further (see [Adjusting the Steering Yoke \(or Steering Wheel\) Position on page 49](#)).
- When a menu displays on the instrument panel from which you can choose options (for example, wipers), use the scroll button to choose an option (up, down, left, or right).

Right Scroll Button

Use the scroll button on the right side of the steering yoke (or steering wheel) to control Autopilot features such as Autosteer and Traffic-Aware Cruise Control:

- When driving, push and release the button to engage Autosteer or Traffic-Aware Cruise Control (see [Autosteer on page 88](#)). If **Autosteer Activation** is set to **Double Click** (touch **Controls > Autopilot Activation > Autosteer Activation**), a single push engages Traffic-Aware Cruise Control (see [Traffic-Aware Cruise Control on page 84](#)) only and you must push and release twice to engage Autosteer. Once engaged, pushing the button cancels Autosteer and/or Traffic-Aware Cruise Control.
- When Model S is in Park, push the button twice to automatically engage Summon (if equipped) before exiting the vehicle (see [Starting Summon Before Exiting the Vehicle on page 106](#)).
- When Traffic-Aware Cruise Control is engaged, rolling the scroll button up/down increase/decreases the set cruising speed respectively.

NOTE: There is currently no action associated with pushing the right scroll button to the left and right.

Heated Steering Yoke (or Steering Wheel)

To warm up the steering yoke (or steering wheel), touch the temperature icon on the touchscreen to display climate controls (see [Overview of Climate Controls on page 119](#)), then touch the steering yoke (or steering wheel) icon. When turned on, radiant heat keeps the steering yoke (or steering wheel) at a comfortable temperature.

Horn

To sound the horn, press and hold the horn button on the right side of the steering yoke (or steering wheel).



Adjusting Exterior Mirrors

Adjust the exterior mirrors by touching **Controls** > **Mirrors**. Press the left scroll button on the steering yoke (or steering wheel) to choose whether you are adjusting the **Left** or **Right** mirror. Then use the left scroll button as follows to adjust the selected mirror to its desired position:

- To move the mirror up or down, roll the left scroll button up or down.
- To move the mirror inward or outward, press the left scroll button to the left or right.



Mirror Auto Tilt automatically tilts mirrors downward when backing up. To turn this feature on or off, touch **Controls** > **Mirrors** > **Mirror Auto Tilt**. To adjust the auto-tilt position, make mirror adjustments with Model S shifted into Reverse. When you shift out of Reverse, mirrors tilt back to their normal (upward) position. But now that you have adjusted them for backing up, they automatically tilt to the selected downward position whenever you shift into Reverse.

When certain environmental conditions are met, the rear view mirror and exterior side mirrors dim automatically (for example, in low light conditions or to reduce glare when driving at night). To enable or disable this feature, touch **Controls** > **Mirrors** > **Mirror Auto Dim**.

NOTE: Both exterior mirrors have heaters that turn on and off with the rear window defroster.

Folding Mirrors

To manually fold and unfold exterior mirrors (for example, parking in a narrow garage, tight space, etc.), touch **Controls** > **Fold/Unfold Mirrors**.

When you manually fold the mirrors, they remain folded until your driving speed reaches 31 mph (50 km/h) (or until you manually unfold them by touching **Controls** > **Unfold Mirrors**).

NOTE: You cannot fold a mirror when driving over 31 mph (50 km/h).

To set the mirrors to fold automatically whenever you exit and lock Model S touch **Controls** > **Mirrors** > **Mirror Auto Fold**. The mirrors unfold automatically when you unlock Model S.

You can also set mirrors to fold automatically whenever you arrive at a specific location, which saves you from having to manually fold them each time you arrive at a frequented place. To set this up, stop at the location you want to save (or drive at less than 3 mph (5 km/h)), and fold the mirrors. **Save Location** appears briefly below the **Fold Mirrors** control. Touch again if you no longer want mirrors to automatically fold at the location.

NOTE: When you leave the saved location, mirrors remain folded until your driving speed reaches 31 mph (50 km/h), or until you touch **Controls** > **Unfold Mirrors**.

CAUTION: Mirrors may not automatically fold if you return to a saved location and are driving faster than 3 mph/5 km/h.

NOTE: You can override the automatic folding/unfolding of mirrors at any time (for example, Model S has no power) by pushing the mirror assembly away from you to unfold, or pulling it toward you to fold.

NOTE: If you expect ice to accumulate when Model S is parked, turn off **Mirror Auto Fold**. Accumulation of ice can prevent exterior side mirrors from folding or unfolding. See [Cold Weather Best Practices on page 79](#) for information on how to ensure your mirrors function properly in cold weather.

You can integrate auto-folding mirrors with HomeLink (see [Smart Garage Connectivity on page 139](#)). To enable, go to **HomeLink** > **Auto-Fold Mirrors when Nearby**.

Rear View Mirror

Adjust the rear view mirror manually. When in Drive or Neutral, the rear view mirror automatically dims in low lighting conditions based on the time of day (for example, when driving at night).



Starting

When you open a door to enter Model S, the instrument panel and touchscreen power on and you can operate all controls. To shift Model S, press the brake pedal and swipe up for Drive or down for Reverse on the touchscreen's drive mode strip (see [Shifting on page 55](#)).

If **Auto Shift out of Park** is enabled, Model S automatically selects Drive or Reverse based on inputs from various sensors. Pressing the brake pedal shifts the vehicle into the selected drive mode displayed on the instrument panel (provided the driver's door is closed and the driver's seat belt is buckled), and pressing the accelerator moves the vehicle in that direction (see [Auto Shift out of Park on page 55](#)).

NOTE: To turn **Auto Shift out of Park** on or off, touch **Controls > Pedals & Steering > Auto Shift out of Park**.

Before accelerating when **Auto Shift out of Park** is enabled, check the instrument panel to make sure that Model S has shifted into the drive mode you want (Drive or Reverse). If the selection is not correct, or if **Auto Shift out of Park** is not enabled, swipe up for Drive or down for Reverse on the touchscreen's drive mode strip to choose a new drive mode. See [Shifting on page 55](#).

NOTE: If the **PIN to Drive** feature is enabled (see [PIN to Drive on page 133](#)), you must also enter a valid PIN on the touchscreen before you can drive Model S.

Everything you need to know when driving Model S displays on the instrument panel.

Drive Disabled - Requires Authentication

If Model S does not detect a key when you press the brake (a key fob or phone key is not detected or two minutes have passed since you used the key card), the touchscreen displays a message telling you that driving requires authentication.

If you see this message, place the key card in either phone dock where the RFID transmitter can read it. The two-minute authentication period restarts and you can start Model S by pressing the brake pedal.

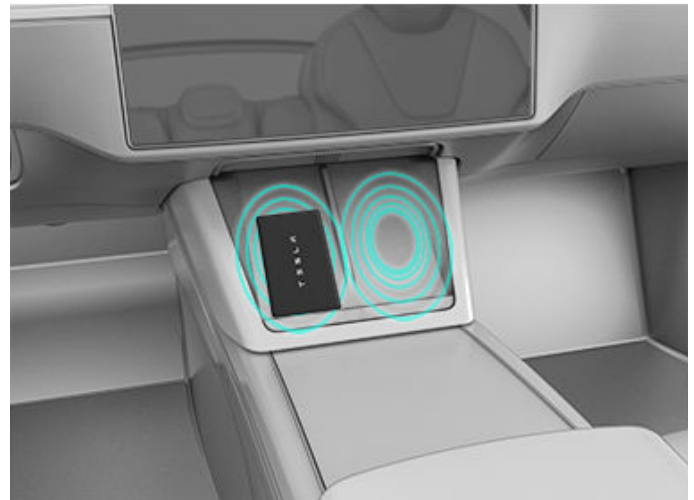

A number of factors can affect whether Model S can detect a phone key or key fob (for example, the device's battery is low or dead and is no longer able to communicate using Bluetooth).

Always keep your phone key, key fob, or a key card with you. After driving, your key is needed to restart Model S after it powers off. And when you leave Model S, you must bring your key with you to lock Model S, either manually or automatically.

Powering Off

When you finish driving, simply exit the vehicle. When you leave Model S with your phone key and key fob, it powers off automatically, turning off the instrument panel and touchscreen.

Model S also powers off automatically after being in Park for 30 minutes, even if you are sitting in the driver's seat.

Although usually not needed, you can power off Model S while sitting in the driver's seat, provided the vehicle is not moving. Touch **Controls > Safety > Power Off**.

Model S automatically powers back on again if you press the brake pedal or touch the touchscreen.

NOTE: Model S automatically shifts into Park whenever it determines that you are exiting the vehicle (for example, the driver's seat belt is unbuckled and the vehicle is almost at a standstill). If you shift into Neutral, Model S shifts into Park when you open the door to exit. To keep Model S in Neutral, see [Instructions for Transporters on page 202](#).

Power Cycling the Vehicle

You can power cycle Model S if it demonstrates unusual behavior or displays a nondescript alert.

NOTE: If the touchscreen is unresponsive or demonstrates unusual behavior, reboot it before you power cycle the vehicle (see [Restarting the Touchscreen on page 8](#)).



Starting and Powering Off

1. Shift into Park.
2. On the touchscreen, touch **Controls > Safety > Power Off**.
3. Wait for at least two minutes without interacting with the vehicle. Do not open the doors, touch the brake pedal, touch the touchscreen, etc.
4. After two minutes, press the brake pedal or open the door to wake the vehicle.

Auto Shift out of Park

NOTE: **Auto Shift out of Park** is a BETA feature and is disabled by default.

When **Auto Shift out of Park** is enabled, Model S is designed to use inputs from various sensors to automatically select Drive or Reverse. The instrument panel displays the selected drive mode when the driver's door is closed and seat belt is buckled.

To override the selection, press the brake pedal and use the drive mode strip on touchscreen to shift into your desired drive mode (Drive, Reverse, Park; see [Shifting Using the Touchscreen on page 55](#)).

Confirm the drive mode selection and follow the instructions on the instrument panel before you press the accelerator.



WARNING: As always, be aware of your vehicle and surroundings before driving. Never rely on Model S to automatically select a suitable drive mode without confirming the selection before you start to drive.

If **Auto Shift out of Park** is unavailable, the instrument panel displays a message.

Model S automatically selects a drive mode when:

- **Auto Shift out of Park** is enabled (touch **Controls** > **Pedals & Steering** > **Auto Shift out of Park**).
- Model S is in Park.
- The driver's seat belt is fastened.
- The brake pedal is pressed.
- All doors and trunks are closed.
- The drive mode selector on the center console is not activated (see [Shift Using the Center Console on page 56](#)).

NOTE: Model S does not automatically select drive modes in Valet Mode.

Auto Shift out of Park is disabled by default. When disabled, use the touchscreen or the center console to manually shift. To enable **Auto Shift out of Park**, touch **Controls** > **Pedals & Steering** > **Auto Shift out of Park**.

Shifting Using the Touchscreen

When you press the brake pedal when parked, the drive mode strip displays on one side of the touchscreen. Use the drive mode strip to shift Model S: swipe up for Drive, swipe down for Reverse or touch the P for Park. The drive mode strip is always available on the touchscreen when you touch **Controls**.



NOTE: To shift from Drive into Reverse or vice versa, the driving speed must be less than 5 mph (8 km/h).

NOTE: The touchscreen's drive mode strip displays the **Park** button at all times. When driving below 5 mph (8 km/h), simply touch the **Park** button on the drive mode strip to shift into Park. In emergency situations when driving above 5 mph (8 km/h), press and hold the **Park** button to engage the parking brake.

To shift into Neutral, open **Controls** to bring up the drive mode strip, then press and hold **Neutral** until Neutral engages.

NOTE: The touchscreen is the preferred method to manually shift. However, in the unlikely situation in which the touchscreen is unavailable and therefore can't be used, the drive mode selector on the center console automatically activates and must be used to shift (see [Shift Using the Center Console on page 56](#)).

If you try to shift when it is prohibited by the current driving speed, the instrument panel displays an alert, a chime sounds, and the drive mode does not change.

Shift Using the Center Console

In addition to manually shifting on the touchscreen, you can shift by pressing P, R, N or D located on the center console. In most situations, these buttons are not available until you press one of the buttons to activate it. When active, the LEDs associated with each button illuminate and when you select P, R, N or D, the associated LED illuminates amber.

In situations where the touchscreen is unavailable (for example, experiencing a technical issue), or Model S is in Valet or Transport Mode, the drive mode selector on the center console activates automatically and there is no need to touch it.

NOTE: You can also activate the drive mode selector on the center console by simultaneously and *briefly* pressing both scroll buttons on the steering yoke (or steering wheel). However, if you press and *hold* both buttons simultaneously, the drive mode selector activates *and* the touchscreen restarts (see [Restarting the Touchscreen on page 8](#)).

NOTE: The front trunk, rear trunk, and doors must be closed to shift using the center console.



1. Park
2. Reverse
3. Neutral
4. Drive

NOTE: When the touchscreen is available for shifting and you have manually activated the drive mode selector on the center console, the center console automatically deactivates if you don't shift within 10 seconds.

Park

Model S automatically shifts into Park whenever you connect a charge cable or if two or more of the following conditions are met simultaneously while traveling slower than approximately 1.5 mph (2 km/h):

- The driver's seat belt is unbuckled.
- The occupancy sensor in the driver's seat does not detect an occupant.
- The driver's door is opened.

To manually shift into Park, press the brake pedal and touch the **Park** button on the touchscreen's drive mode strip. If the touchscreen is unavailable, press Park on the drive mode selector located on the center console.

To engage the parking brake in emergency situations, such as when driving above 5 mph (8 km/h) and you need to stop immediately, press and hold the **Park** button on the drive mode strip.

NOTE: You must always press the brake pedal to shift *out of* Park.



CAUTION: Model S will not shift out of Park if a charge cable is plugged in, or if the charge port is unable to determine whether a charging cable is plugged in. In situations when Model S does not shift out of Park, check the instrument panel or touchscreen for instructions on how to proceed.



WARNING: It is the driver's responsibility to always ensure the vehicle is in Park before exiting. Never rely on Model S to automatically shift into Park for you; it may not work in all circumstances.

Drive

To manually shift into Drive, swipe up on the drive mode strip located on the touchscreen or, if the touchscreen is unavailable, press D on the drive mode selector located on the center console. You can shift into Drive when Model S is stopped or moving less than 5 mph (8 km/h) in Reverse.

Reverse

To manually shift into Reverse, swipe down on the drive mode strip located on the touchscreen or, if the touchscreen is unavailable, press R on the drive mode selector located on the center console. You can shift into Reverse when Model S is stopped or moving less than 5 mph (8 km/h) in Drive. You can manually close the park assist view on the touchscreen by touching the **X** in the upper corner.

Neutral

Neutral allows Model S to roll freely when you are not pressing the brake pedal. To shift into Neutral, do any of the following:

- Open **Controls**, then press and hold the **Neutral** icon on the drive mode strip until Model S engages Neutral.
- Choose **Neutral** from the drive mode selector on the center console.

NOTE: When Model S is traveling over 5 mph (8 km/h) and you swipe up or down on the touchscreen's drive mode strip, a **Neutral** icon displays at the bottom of the drive mode strip from which you can also choose to engage Neutral.

NOTE: You must press the brake pedal to shift out of Neutral if Model S is moving slower than approximately 5 mph (8 km/h).

Model S automatically shifts into Park when you open the driver's door to exit the vehicle. To stay in Neutral even when you leave Model S, you must engage Transport Mode (described next).

Keeping Your Vehicle in Neutral (Transport Mode)

Model S automatically shifts into Park whenever you finish driving and leave Model S. To keep Model S in Neutral when you exit, allowing it to roll freely (for example, pulling onto a flatbed truck), you must activate Transport mode:

1. Shift into Park.
2. Press the brake pedal.
3. Touch **Controls** > **Service** > **Towing**. The touchscreen displays a message reminding you how to properly transport Model S.
4. Press and hold the **Transport Mode** button until it turns blue. Model S is now free-rolling and can slowly be rolled (no faster than walking speed) for short distances or winched (for example, onto a flatbed truck).

For more information on Transport Mode, see [Activate Transport Mode on page 203](#).

NOTE: In Transport mode, Model S does not shift into a drive mode. You must first cancel Transport mode by touching **Transport Mode** again. Transport mode also cancels if you use the touchscreen or drive mode selector on the center console to shift into Park or if you manually apply the parking brake by touching **Controls** > **Safety** > **Parking Brake**.

Controlling Lights

Touch **Controls** > **Lights** to control the lights.

NOTE: You can also access an abbreviated lights menu while driving by touching the High Beam button on the steering yoke (or steering wheel). A lights menu displays on the touchscreen, providing quick access to headlight controls.

In addition to the lights that you can control from the touchscreen, Model S has convenience lights that turn on and off automatically based on what you are doing. For example, interior lights, marker lights, tail lights, and puddle lights turn on when you unlock Model S, when you open a door, and when you shift into Park. They turn off automatically after a minute or two or when you shift or lock Model S.

Exterior Lights

Exterior lights (headlights, tail lights, side marker lights, parking lights, and license plate lights) are set to **Auto** each time you start Model S. When set to **Auto**, exterior lights automatically turn on when driving in low lighting conditions. If you change to a different setting, lights always revert to **Auto** on your next drive.

Touch one of these options to change the exterior light setting:

- **Off:** Exterior lights turn off until you manually turn them back on or until the next time you drive. If daytime running lights are required in your region, the exterior lights used for this purpose are always on when Drive is engaged.
- **Parking:** Only the side marker lights, parking lights, tail lights and license plate lights turn on.

NOTE: If daytime running lights are required in your region, the exterior lights used for this purpose are always on whenever Drive or Reverse is engaged.

- **On:** Exterior lights turn on.

 **CAUTION:** Ensure the headlights and rear lights are on during low visibility conditions (for example, when it is dark, foggy, snowy, or the road is wet, etc.). The rear tail lights are off while daytime running lights are on. Failure to do so can cause damage or serious injury.

Fog Lights

If equipped, touch to turn the fog lights on or off. Fog lights operate only when low beam headlights are on. When headlights are turned off, fog lights also turn off.



The rear fog indicator displays on the instrument panel whenever rear fog lights (if equipped) are on.



The front fog indicator displays on the instrument panel whenever the optional front fog lights are on.

NOTE: Depending on the market region and vehicle options, your vehicle may not be equipped with front and/or rear fog lights.

Dome Lights

Turn the interior dome (map) lights on or off. If set to **Auto**, all interior dome lights turn on when you unlock Model S, open a door upon exiting, or shift into Park.

NOTE: You can also manually turn an individual dome light on or off by pressing its lens. If you turn a dome light on, it turns off when Model S powers off. If Model S was already powered off when you manually turned the light on, it turns off after 60 minutes.

Ambient Lights

When enabled, interior ambient lights turn on whenever the headlights are on.

Headlights after Exit

If you turn on **Headlights after Exit**, the exterior lights remain on for one minute after you stop driving and park Model S in low lighting conditions. See [Headlights After Exit on page 59](#).

NOTE: Model S has lights along the rim of the headlights, also referred to as "signature" lights. These lights automatically turn on whenever Model S is powered on and a drive mode is engaged.

High Beam Headlights

Use the high beam headlight button on the left side of the steering yoke (or steering wheel) to control the headlights:

- Press and quickly release to flash high beam headlights.
- Press and hold to turn on high beam headlights - the instrument panel displays a brief timer and you must hold for the duration of the timer to latch the high beam headlights to the on position. When headlights are on, press the button a second time to turn them off.



Auto High Beam (if equipped)

The high beam headlights can automatically switch to low beam when there is light detected in front of Model S (for example, from an oncoming vehicle). To turn this feature on or off, touch **Controls > Lights > Auto High Beam**. Your chosen setting is retained until you manually change it.

NOTE: When you touch or press the high beam headlight button on the left side of the steering yoke (or steering wheel), the touchscreen displays an abbreviated lights menu to provide quick access to control headlights, fog lights (if equipped), and the **Auto High Beam** setting. Use the touchscreen to choose options from this menu.

NOTE: **Auto High Beam** is automatically enabled when Autosteer is engaged. To switch to low beam headlights, press the high beam headlight button on the steering yoke (or steering wheel). **Auto High Beam** is re-enabled every time Autosteer is activated.

The following indicator lights are visible on the instrument panel to show the status of the headlights:

Low beam headlights are on.



High beam headlights are on. Illuminates when high beams are on but the **Auto High Beam** setting is turned off or if the **Auto High Beam** setting is turned on but is temporarily unavailable.



High beams are currently turned on, and **Auto High Beam** is ready to turn off the high beams if light is detected in front of Model S.



High beams are temporarily turned off because **Auto High Beam** is operating and light is detected in front of Model S. When light is no longer detected, high beam headlights automatically turn back on.

WARNING: **Auto High Beam** is a convenience only and is subject to limitations. It is the driver's responsibility to make sure that headlights are always appropriately adjusted for weather conditions and driving circumstances.

Rear Reading Lights

Model S is equipped with a reading light on each side of the rear seats, located above the door and next to the coat hangers (see [Coat Hangers](#) on page 27). To turn a reading light on or off, press its lens. If you leave a reading light turned on, it automatically turns off when Model S powers off.

Headlights After Exit

When you stop driving and park Model S in low lighting conditions, exterior lights temporarily remain illuminated. They automatically turn off after one minute or when you lock Model S whichever comes first.

To turn this feature on and off, touch **Controls > Lights > Headlights After Exit**. When **Headlights After Exit** is off, the headlights turn off immediately when you engage Park and open a door.

Adaptive Front Lighting System (AFS)

If equipped, the Adaptive Front Lighting System (AFS) automatically adjusts the beam of the headlights to improve your driving view. Electric sensors measure driving speed, steering angle and yaw (the rotation of the car around the vertical axis) to determine the optimum position of the headlights based on current driving conditions. For example, to improve visibility while driving on winding roads at night, the AFS casts the beam in the direction of the curve. When low beam headlights are turned on and when driving at lower speeds, AFS improves lateral illumination to increase the visibility of pedestrians and curbs, and to improve visibility when turning at a dark intersection, into a driveway, or when making a u-turn.



If the AFS fails, the instrument panel displays an alert. Contact Tesla Service.

Turn Signals

To engage a turn signal, press the corresponding arrow button on the left side of the steering yoke (or steering wheel). A turn signal cancels based on the angle of the steering yoke (or steering wheel) (for example, you finish making a turn). You can also cancel a turn signal by pressing the turn signal button a second time.

If **Controls > Lights > Automatic Turn Signals** is set to **Auto Cancel**, turn signals cancel automatically when Model S detects completion of a maneuver such as a merge, lane change, or a fork in the roadway. You can override automatic cancellation at any time (for example, you want the turn signal to remain on because you are making more than one lane change). To override, engage the turn signal by pressing and momentarily holding the turn signal button (instead of just pressing). Then, when the first maneuver is complete, the turn signal remains on. If **Automatic Turn Signals** is set to **Off**, you must cancel the turn signal manually by pressing the turn signal button after maneuvers such as a merge, lane change, or fork in the roadway.



NOTE: Hazard warning flashers operate even without a key nearby.

Condensation in Head or Tail Lights

Due to weather changes, humidity levels, or recent exposure to water (such as a car wash), condensation may occasionally accumulate in your vehicle's head or tail lights. This is normal— as the weather gets warmer and humidity decreases, condensation often disappears on its own. If you notice water buildup within the exterior lenses, or if the condensation affects the visibility of the exterior lights, contact Tesla Service.



When a turn signal is operating, the corresponding indicator lights up on the instrument panel and you can hear a clicking sound.



Hazard Warning Flashers

To turn on the hazard warning flashers, press the button on the drive mode selector located at the front of the center console. All turn signals flash. Press again to turn off.



Instrument Panel Overview

The instrument panel changes depending on whether Model S is:

- Off or Parked (shown below).
- Driving (see [Instrument Panel - Driving](#) on page 62).
- Charging (see [Charging Instructions](#) on page 163).

When Model S is off or Parked, the instrument panel shows remaining estimated range, vehicle status, and outside temperature.

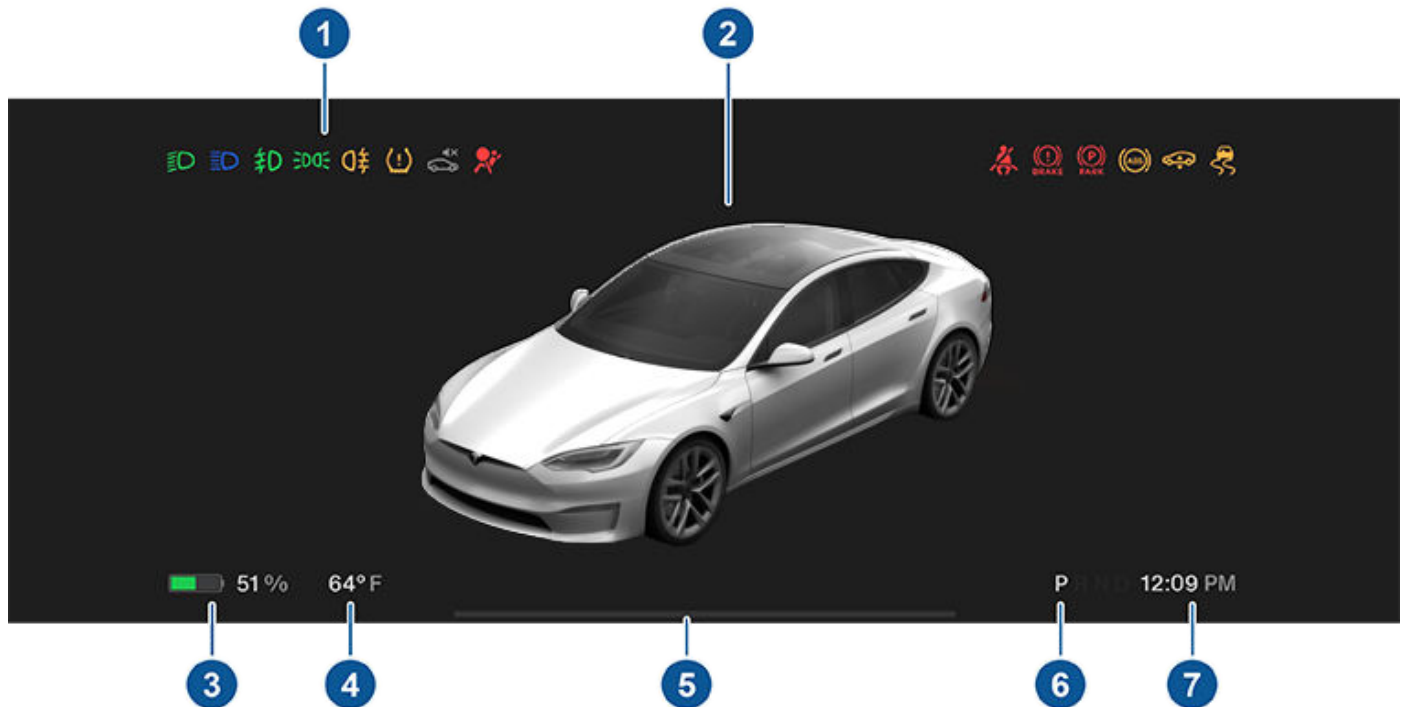

1. When the car is off and you initially press the brake, indicator lights flash briefly along the top of the instrument panel. Unless an indicator light applies to a current situation, it should turn off. If an indicator light fails to turn on or off, refer to [Indicator Lights](#) on page 63.
2. An image of your car and its accompanying status (such as lights on, door open, etc.).
3. Total estimated driving distance (or energy) available. Instead of driving distance, you can display the percentage of battery energy remaining. To do so, touch **Controls** > **Display** > **Energy Display**.
NOTE: When anticipating when you need to charge, use estimates as a general guideline only.
4. Estimated outside temperature.
5. Pay attention to instructions or important alert messages that display here. If any alerts are in effect, you can view information about them by touching **Controls** and then touching the bell icon located at the top of the screen.
6. Currently selected drive mode: Park, Reverse, Neutral, or Drive. If **Auto Shift out of Park** is enabled, Drive or Reverse is automatically selected (based on sensor input) and displayed on the instrument panel when the driver's door is closed and seatbelt is buckled (see [Auto Shift out of Park](#) on page 55).
7. Current time of day.

See [Popup Messages and Vehicle Alerts](#) on page 8 for more information about alert popups on your vehicle's touchscreen.



Instrument Panel - Driving

When Model S is driving (or ready to drive), the instrument panel shows your current driving status and a real-time visualization of the road as detected by the Autopilot components (see [About Autopilot on page 81](#)). The visualization automatically zooms in and out based on the detected road type.

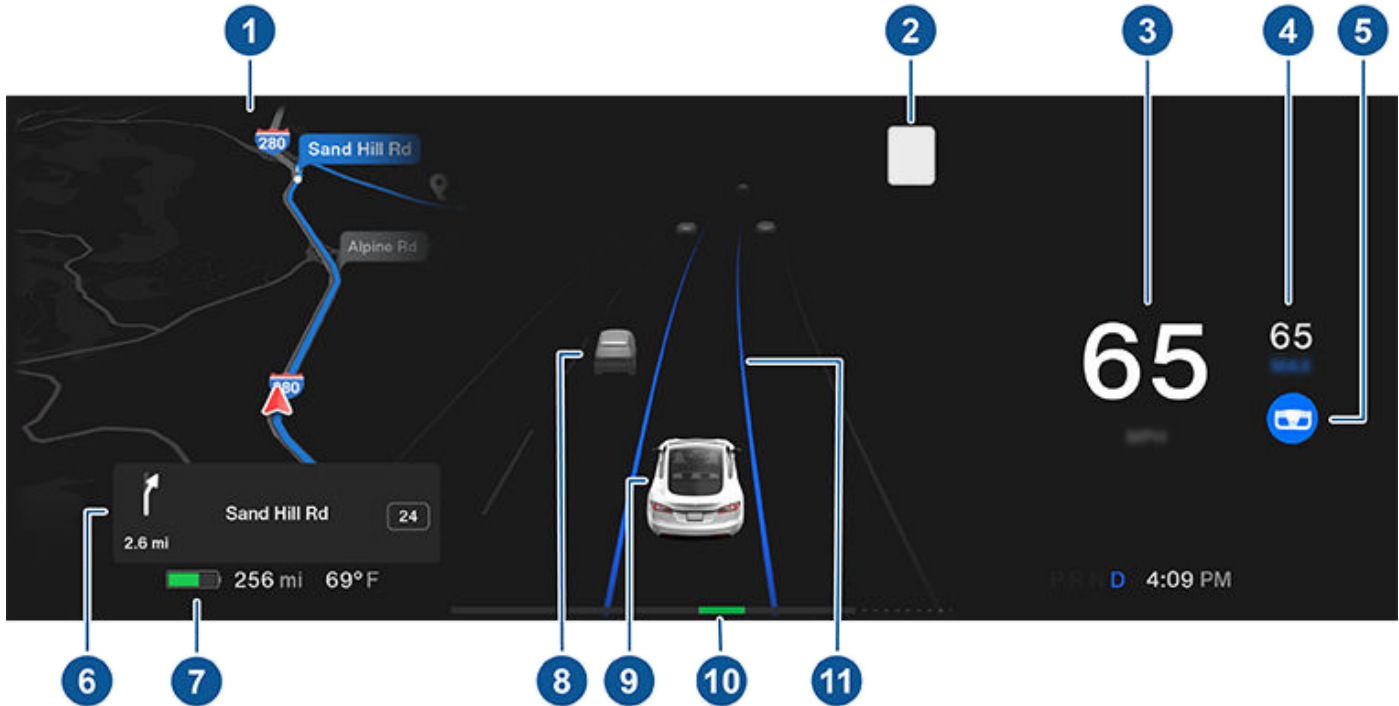

NOTE: Touch **Controls** > **Autopilot** > **Full Self-Driving Visualization Preview** (if equipped) to display more details about the roadway and its surroundings, such as road markings, stop lights, objects (such as trash cans and poles), etc.

1. The instrument panel displays your location on a map, a wiper menu, Auto Shift out of Park instructions, etc. When a navigation route is active, the upcoming portion of the route displays.
2. The speed limit (if available) that is currently being detected by Speed Assist (see [Speed Assist on page 117](#)).
3. Current driving speed.
4. The currently set cruising speed. When Traffic-Aware Cruise Control is available but you haven't set a cruising speed by engaging Traffic-Aware Cruise Control or Autosteer, the icon is gray (see [Traffic-Aware Cruise Control on page 84](#)).
5. Autosteer is actively steering Model S. When Autosteer is available but you haven't activated it, the icon is gray (see [Autosteer on page 88](#)).
6. When navigating, upcoming instructions in the navigation route appear here.
7. Total estimated driving distance (or energy) available. Instead of driving distance, you can display the percentage of battery energy remaining (touch **Controls** > **Display** > **Energy Display**).

NOTE: When anticipating when you need to charge, use estimates as a general guideline only.

8. Surrounding road users are shown in their corresponding locations.



WARNING: Although the instrument panel shows surrounding traffic, some vehicles may not be displayed. Never rely on the instrument panel to determine if a vehicle is present (for example, in your blind spot). Always use your mirrors and perform shoulder checks.

9. Your Model S.









10. The power meter displays real-time power usage. During acceleration, the bar fills to the right with a gray color (or white if the display is dark) to represent power being used. During deceleration (when Model S is moving and you release your foot from the accelerator pedal), the bar fills to the left with a green color to represent power being fed back to the Battery by regenerative braking (see [Regenerative Braking on page 67](#)).
11. When Autosteer is active and detects the driving lane, it is highlighted in blue (see [Autosteer on page 88](#)). Depending on the current driving scenario, you may see neighboring lanes.







NOTE: In situations where Autosteer is unable to detect lane markings, the driving lane is determined based on the vehicle you are following.

NOTE: If Navigate on Autopilot is active, the driving lane displays as a single blue line in front of Model S (see [Navigate on Autopilot on page 93](#)).

Indicator Lights









Indicator lights display along the top of the instrument panel to show status and alert you of specific vehicle conditions.

Indicator	Description
	A brake system fault is detected or the brake fluid level is low. See Braking and Stopping on page 66 . Contact Tesla immediately.
	A brake booster fault has been detected. See Braking and Stopping on page 66 .
	An ABS (Anti-lock Braking System) fault is detected. See Braking and Stopping on page 66 . Contact Tesla immediately.
	A parking brake fault is detected. Contact Tesla. See Parking Brake on page 68 .
	The parking brake is manually applied. See Parking Brake on page 68 .
	Tire pressure warning. The pressure of a tire is out of range. If a fault with the Tire Pressure Monitoring System (TPMS) is detected, the indicator flashes. For a TPMS fault, contact Tesla. See Tire Care and Maintenance on page 173 .
	A seat belt for an occupied seat is not fastened. See Seat Belts on page 32 .

Indicator	Description
	Airbag safety. If this red indicator does not flash on briefly when Model S prepares to drive, or if it remains on, contact Tesla immediately. See Airbags on page 41 .
	Front fog lights are on, if equipped. See Lights on page 58 .
	Parking lights (side marker lights, tail lights, and license plate lights) are on. See Lights on page 58 .
	Low beam headlights are on.
	High beam headlights are on. Illuminates when high beams are on but the Auto High Beam setting (if equipped) is turned off or if the Auto High Beam setting is turned on but is temporarily unavailable. See High Beam Headlights on page 58 .
	High beam headlights are currently turned on, and Auto High Beam (if equipped) is ready to turn off the high beams if light is detected in front of Model S. See High Beam Headlights on page 58 .
	High beam headlights are temporarily turned off because Auto High Beam (if equipped) is on and is detecting light in front of Model S. When light is no longer detected, the high beams automatically turn back on. See High Beam Headlights on page 58 .



Instrument Panel

Indicator	Description
	This indicator flashes amber when the electronic stability control systems are actively minimizing wheel spin by controlling brake pressure and motor power. See Traction Control on page 69 . If this indicator remains on, a fault is detected and you should immediately contact Tesla.
	If a fault is detected that reduces the performance of the air suspension system, this amber indicator light displays (see Air Suspension on page 129). If the problem persists, contact Tesla.
	If a fault is detected that disables the air suspension system, this red indicator light displays (see Air Suspension on page 129). Contact Tesla.
	Vehicle Hold is actively applying the brakes. See Vehicle Hold on page 72 .
	Electronic stability control systems are no longer minimizing wheel spin. See Traction Control on page 69 .
	Model S is in Transport mode and can roll freely. It does not automatically shift into Park when you exit. See Activate Transport Mode on page 203 .
	A blue snowflake appears when some of the energy stored in the Battery may not be available due to cold weather conditions. During these cold weather conditions, charging rates may also be limited. If Model S is plugged in, you can heat your Battery by turning on climate control with the mobile app. The snowflake disappears when the Battery is sufficiently warm.
	A green icon appears when regenerative braking is limited. See Regenerative Braking on page 67 for more information.
	Vehicle power is currently being limited because the energy remaining in the Battery is low, the vehicle's systems are being heated or cooled, or an error is detected by the drive inverter.



Wipers and Washers

You can access wiper settings by touching the wiper button on the steering yoke (or steering wheel) or touching **Controls > Wipers**.

Press the wiper button on the steering yoke (or steering wheel) to wipe the windshield.

Press and hold the wiper button to spray washer fluid onto the windshield. After releasing the button, the wipers perform two additional wipes then, depending on vehicle and environmental conditions, a third wipe a few seconds later. You can also press and hold the wiper button for a continuous spray of washer fluid—the wipers perform the wipes after you release.

Whenever you press the wiper button, the instrument panel displays the wiper menu, allowing you to adjust wiper settings. Roll the left scroll button on the steering yoke (or steering wheel) up or down to choose your desired setting.

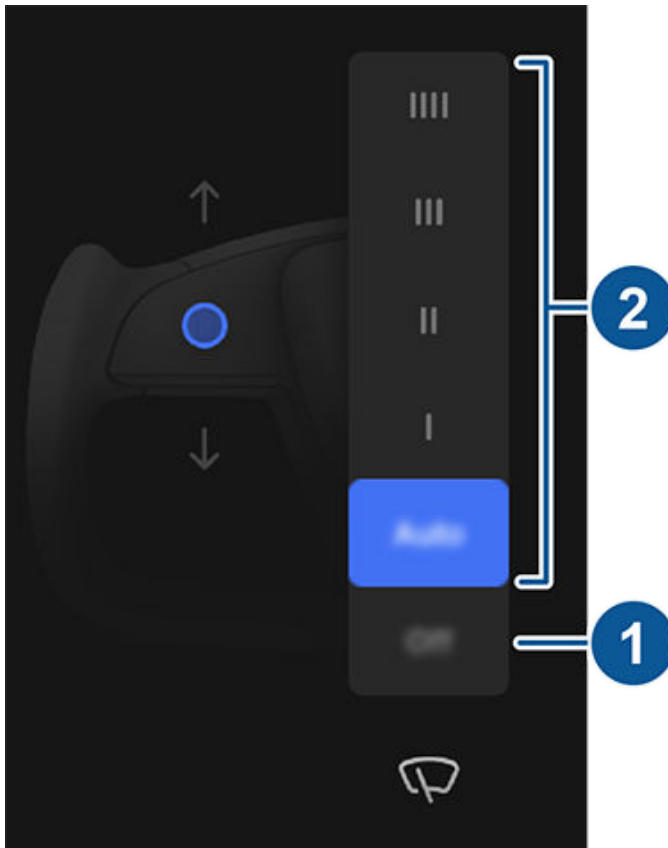

1. Turn the wipers off.
2. Choose how you want the wipers to operate:
 - **Auto** - Model S detects whether or not it is raining. When liquid is detected on the windshield, Model S determines the optimal frequency of the wipers. If Model S does not detect liquid on the windshield, the wipers do not operate.

NOTE: Autosteer and traffic-aware cruise control require wipers to be set to **Auto**. This setting is automatic and you cannot change it.

NOTE: The Auto setting is currently in BETA. If uncertain about using the Auto setting while in the BETA phase, Tesla recommends operating the wipers manually, as necessary.

- **I** - Intermittent, slow.
- **II** - Intermittent, fast.
- **III** - Continuous, slow.
- **IIII** - Continuous, fast.

NOTE: If you choose **Auto** and the ability to detect liquid on the windshield becomes unavailable, the wiper setting reverts to the most recently used manual setting. If a manual setting cannot be determined, the wipers turn off.

NOTE: You can also adjust the windshield wiper speed and frequency using voice commands (see [Voice Commands on page 131](#)).

CAUTION: To avoid the risk of damaging the wipers, do not leave the wipers set to **Auto** when washing Model S.

Periodically check and clean the edge of the wiper blades. If a blade is damaged, replace it immediately. For details on checking and replacing wiper blades, see [Windshield Wiper Blades, Jets and Fluid on page 182](#).

- CAUTION:** To avoid damaging the hood, ensure that the hood is fully closed before activating the windshield wipers.
- CAUTION:** Remove ice from the windshield before turning the wipers on. Ice has sharp edges that can damage the rubber on the wiper blades.
- CAUTION:** In harsh climates, ensure that the wiper blades are not frozen or adhered to the windshield.

Braking Systems

 **WARNING:** Properly functioning braking systems are critical to ensure safety. If you experience a problem with the brake pedal, brake calipers, or any component of a Model S braking system, contact Tesla immediately.

Model S has an anti-lock braking system (ABS) that prevents the wheels from locking when you apply maximum brake pressure. This improves steering control during heavy braking in most road conditions.

During emergency braking conditions, the ABS constantly monitors the speed of each wheel and varies the brake pressure according to the grip available.

The alteration of brake pressure can be felt as a pulsing sensation through the brake pedal. This demonstrates that the ABS is operating and is not a cause for concern. Keep firm and steady pressure on the brake pedal while experiencing the pulsing.



The ABS indicator briefly flashes amber on the instrument panel when you first start Model S. If this indicator lights up at any other time, an ABS fault has occurred and the ABS is not operating. Contact Tesla. The braking system remains fully operational and is not affected by an ABS failure. However, braking distances may increase. Drive cautiously and avoid heavy braking.



If the instrument panel displays this red brake indicator at any time other than briefly when you first start Model S, a brake system fault is detected, or the level of the brake fluid is low. Contact Tesla immediately. Apply steady pressure and keep the brakes firm to bring the vehicle to a stop when safe to do so.





The instrument panel displays this amber brake indicator if a brake booster fault is detected. Apply steady pressure and keep the brakes firm to stop the vehicle when safety permits. Hydraulic Boost Compensation will be active (see [Hydraulic Boost Compensation on page 67](#)).

 **WARNING:** When driving a Model S Plaid equipped with the optional Carbon Ceramic Brake Kit in temperatures below 14 degrees Fahrenheit (-10 degrees Celsius), the instrument panel displays an alert indicating that stability and braking performance may be degraded in cold weather. You may need to increase the amount of pressure you apply to the brake pedal when driving in cold weather. Be aware of this reduced performance and drive cautiously in cold weather conditions. The **Apply Brakes When Regenerative Braking is Limited** feature is not available on a Model S Plaid equipped with the optional Carbon Ceramic Brake Kit.

Emergency Braking

In an emergency, fully press the brake pedal and maintain firm pressure, even on low traction surfaces. The ABS varies the braking pressure to each wheel according to the amount of traction available. This prevents wheels from locking and ensures that you stop as safely as possible.

 **WARNING:** Do not pump the brake pedal. Doing so interrupts operation of the ABS and can increase braking distance.

 **WARNING:** Always maintain a safe distance from the vehicle in front of you and be aware of hazardous driving conditions. While the ABS can improve stopping distance, it cannot overcome the laws of physics. It also does not prevent the danger of hydroplaning (where a layer of water prevents direct contact between the tires and the road).

 **CAUTION:** Automatic Emergency Braking (see [Automatic Emergency Braking on page 115](#)) may intervene to automatically brake in situations where a collision is considered imminent. Automatic Emergency Braking is not designed to prevent a collision. At best, it can minimize the impact of a frontal collision by attempting to reduce your driving speed. Depending on Automatic Emergency Braking to avoid a collision can result in serious injury or death.

Dynamic Brake Lights (if equipped)

If you are driving over 30 mph (50 km/h) and brake forcefully (or if Automatic Emergency Braking engages), the brake lights flash quickly to warn other drivers that Model S is rapidly slowing down. If Model S stops completely, the hazard warning lights flash. Flashing continues until you press the accelerator or manually press the hazard lights button to turn them off (see [Hazard Warning Flashers on page 60](#)).

NOTE: When towing a trailer (if applicable), the brake lights on the trailer also operate as described above, even when the trailer is not equipped with a separate braking system.



⚠ WARNING: When towing a trailer (if applicable), always increase your following distance. Sudden braking may result in skidding, jack-knifing, and loss of control.

Brake Disc Wiping

To ensure brakes remain responsive in cold and wet weather, Model S is equipped with brake disc wiping. When cold and wet weather is detected, this feature repeatedly applies an imperceptible amount of brake force to remove water from the surface of the brake discs.

Hydraulic Fade Compensation

Model S is equipped with hydraulic fade compensation. This assists in monitoring brake system pressure and ABS activity for instances of reduced brake performance. If reduced brake performance is detected (for example, as a result of brake fade, or cold or wet conditions), you may hear a sound, feel the brake pedal pull away from your foot, and notice a strong increase in braking. Brake as you normally would and continue to press the brake pedal without releasing or pumping the brakes.

⚠ CAUTION: If brakes are not functioning properly, stop the vehicle when safety permits and contact Tesla Service.

⚠ WARNING: Always maintain a safe driving distance from the vehicle in front of you and exercise caution when driving conditions are hazardous. Brake disc wiping and hydraulic fade compensation is not a substitute for adequately applying the brakes.

Hydraulic Boost Compensation

Model S is equipped with a brake booster that activates the brakes when the brake pedal is pressed. Hydraulic boost compensation provides mechanical assistance if the brake booster fails. If a brake booster failure is detected, the brake pedal feels stiffer to press and you may hear a sound when you press the brake pedal. To stop Model S, apply steady force to the brake pedal without releasing or pumping. Drive cautiously and maintain a safe distance from other road users—brake pedal responsiveness and braking performance may be degraded.

Regenerative Braking

Whenever Model S is moving and your foot is off the accelerator, regenerative braking slows down the vehicle and feeds any surplus power back to the Battery. By anticipating your stops and reducing or removing pressure from the accelerator pedal to slow down, you can take advantage of regenerative braking to increase driving range.

Vehicle deceleration due to regenerative braking may vary depending on the current state of the Battery. For example, regenerative braking may be limited if the Battery is cold or is already fully charged.

To experience the same amount of deceleration whenever you release the accelerator pedal, regardless of the state of the Battery, you can choose to have the regular braking system automatically engage whenever regenerative braking is limited. Touch **Controls > Pedals & Steering > Apply Brakes When Regenerative Braking is Limited**.

NOTE: If **Apply Brakes When Regenerative Braking is Limited** is enabled and applying the brakes, the brake pedal may move and it may feel stiffer when pressed. This is expected and does not change your ability to slow down Model S.

The power meter (a thin horizontal line centered at the bottom of the instrument panel) displays real-time power usage:



1. The left side of the power meter represents power generated from regenerative braking, or power that is used to slow down the vehicle. Power being fed back to the Battery displays in green whereas power used by the regular braking system displays in gray.
2. The right side of the power meter shows power that is used to accelerate the vehicle. During acceleration, the power meter fills to the right with gray to represent the amount of power being used.

NOTE: To ensure visibility when the display is dark, power represented by the gray color displays as white.

NOTE: Installing winter tires with aggressive compound and tread design may result in temporarily-reduced regenerative braking power. However, your vehicle is designed to continuously recalibrate itself, and after changing tires it will increasingly restore regenerative braking power after some straight-line accelerations. For most drivers this occurs after a short period of normal driving, but drivers who normally accelerate lightly may need to use slightly harder accelerations while the recalibration is in progress.

NOTE: If regenerative braking is aggressively slowing Model S (such as when your foot is completely off the accelerator pedal at highway speeds), the brake lights turn on to alert others that you are slowing down.

⚠ WARNING: In snowy or icy conditions, Model S may experience loss of traction during regenerative braking.

Parking Brake

To engage the parking brake, touch **Controls > Safety > Parking Brake**. Follow the onscreen instructions.

Use the touchscreen to manually release the parking brake (which also shifts Model S into Neutral):

1. Touch **Controls > Safety**.
2. Press the brake pedal, then touch **Parking Brake**. If Model S was previously in Park, it shifts into Neutral.





When you manually apply the parking brake using the touchscreen, the red parking brake indicator lights up on the instrument panel.



If the parking brake experiences an electrical issue, the amber parking brake indicator lights up and a fault message displays on the instrument panel.

NOTE: The parking brake operates on the rear wheels only, and is independent of the pedal-operated brake system.

 **CAUTION:** In the unlikely event that Model S loses electrical power, you cannot access the touchscreen and are therefore unable to release the parking brake without first jump starting (see [Jump Starting on page 207](#)).

 **WARNING:** In snowy or icy conditions the rear wheels may not have sufficient traction to prevent Model S from sliding down a slope, particularly if not using winter tires. Avoid parking on hills in snowy or icy conditions. You are always responsible for parking safely.

 **WARNING:** Your Model S may display an alert if the road is too steep to safely park on, or if the parking brakes are not properly engaged. These alerts are for guidance purposes only and are not a substitute for the driver's judgment of safe parking conditions, including specific road or weather conditions. Do not depend on these alerts to determine whether or not it is safe to park at any location. You are always responsible for parking safely.

Brake Wear

Model S brake pads are equipped with wear indicators. A wear indicator is a thin metal strip attached to the brake pad that squeals as it rubs against the rotor when the pad wears down. This squealing sound indicates that the brake pads have reached the end of their service life and require replacement. To replace the brake pads, contact Tesla Service.

Brakes must be periodically inspected visually by removing the tire and wheel. For detailed specifications and service limits for rotors and brake pads, see [Subsystems on page 192](#). Additionally, Tesla recommends cleaning and lubricating the brake calipers every year or 12,500 miles (20,000 km) if in an area where roads are salted during winter months.

 **WARNING:** Neglecting to replace worn brake pads damages the braking system and can result in a braking hazard.



How It Works

The traction control system constantly monitors the speed of the front and rear wheels. If Model S experiences a loss of traction, the system minimizes wheel spin by controlling brake pressure and motor power. By default, the traction control system is on. Under normal conditions, it should remain on to ensure maximum safety.



This yellow indicator flashes on the instrument panel whenever the traction control system is actively controlling brake pressure and motor power to minimize wheel spin. If the indicator stays on, a fault is detected with the traction control system. Contact Tesla Service.

WARNING: Traction control cannot prevent collisions caused by driving dangerously or turning too sharply at high speeds.

Allowing Wheel Slip

To allow the wheels to spin at a limited speed, you can enable Slip Start. Slip Start can be enabled only when Model S is moving 30 mph (48 km/h) or slower. Slip Start automatically disables when the speed exceeds 50 mph (80 km/h).

Under normal conditions, Slip Start should not be enabled. Enable it only in circumstances where you deliberately want the wheels to spin, such as:

- Starting on a loose surface, such as gravel or snow.
- Driving in deep snow, sand or mud.
- Rocking out of a hole or deep rut.

To allow the wheels to spin, touch **Controls > Pedals & Steering > Slip Start**.



The instrument panel displays an alert message when Slip Start is enabled.

Although Slip Start is automatically disabled the next time you start Model S, it is strongly recommended that you disable it immediately after the circumstances that required you to enable it have passed.

NOTE: Slip Start can not be enabled when you are actively using cruise control.



How Park Assist Works

Model S is designed to detect the presence of objects. When driving slowly in Drive or Reverse (for example, when parking), the vehicle alerts you if an object is detected in close proximity of your Model S. Objects are only detected in your chosen direction; front objects in Drive, rear objects in Reverse.

⚠ WARNING: You may not be alerted if Model S rolls freely in the opposite direction (for example, Park Assist does not display an alert if Model S rolls backwards down a hill while in Drive).



Park Assist is activated when driving slower than 5 mph (8 km/h).

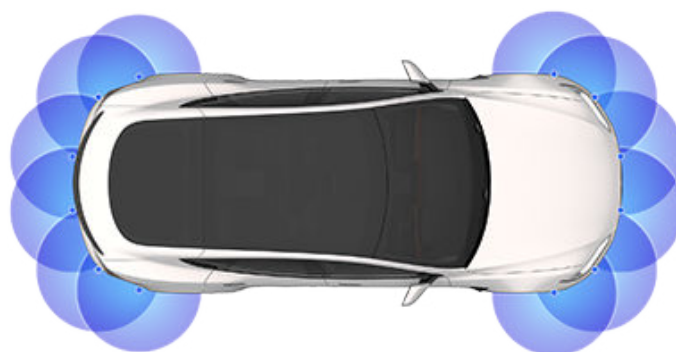

⚠ WARNING: Never depend on Park Assist to inform you if an area you are approaching is free of objects and/or people. Several external factors can reduce the performance of Park Assist, causing either no readings or false readings (see [Limitations and False Warnings on page 71](#)). Therefore, depending on Park Assist to determine if Model S is approaching an obstruction can result in damage to the vehicle and/or objects, and can potentially cause serious injury. Always inspect the area with your own eyes. When reversing, perform shoulder checks and use all mirrors. Park assist does not detect children, pedestrians, bicyclists, animals, or objects that are moving, protruding, located too far above or below the sensors (if equipped) or cameras, or too close or too far from the sensors or cameras. Park Assist is for guidance purposes only and is not intended to replace your own direct visual checks. It is not a substitute for careful driving.

Visual and Audio Feedback

When you shift to Reverse, the Park Assist view displays on the left side of the instrument panel, showing objects that are in close proximity to the front and rear of Model S. This view closes when you shift into Drive unless an object is detected close to the front of Model S, in which case the Park Assist view closes automatically when your driving speed exceeds 5 mph (8 km/h). When reversing, visual feedback also displays on the touchscreen (see [Rear Facing Camera\(s\) on page 77](#)). You can manually close the park assist view on the touchscreen by touching the **X**.

When driving with the Camera app displayed on the touchscreen, you can switch to the Park Assist view when driving at speeds below 5 mph (8 km/h). Touch the button located in the upper left corner of the Camera app screen. This is useful if you need assistance with parallel parking.

If chimes are turned on (see [Controlling Audible Feedback on page 71](#)), an audible beep sounds as you approach an object. You can temporarily mute the chime by touching the speaker icon on the bottom corner of the Park Assist view.

NOTE: If Park Assist is unable to provide feedback, the instrument panel displays an alert message.

 **CAUTION:** Keep sensors (if equipped) and cameras clean from dirt, debris, snow, and ice. Avoid using a high pressure power washer on the sensors and cameras, and do not clean a sensor or camera with a sharp or abrasive object that can scratch or damage its surface.

 **CAUTION:** Do not install accessories or stickers on or near the sensors (if equipped) or cameras.

Controlling Audible Feedback

You can use Park Assist with or without audible feedback. To turn chimes on or off, touch **Controls** > **Safety** > **Park Assist Chimes**.

To mute the chimes temporarily, touch the speaker icon in the bottom corner of the Park Assist view. The chimes are muted until you shift or drive over 5 mph (8 km/h).

Limitations and False Warnings

Park Assist may not function correctly in these situations:

- One or more of the sensors (if equipped) or cameras is damaged, dirty, or obstructed (such as by mud, ice, or snow, or by a vehicle bra, excessive paint, or adhesive products such as wraps, stickers, rubber coating, etc.).
- The object is located below approximately 8 inches (20 cm) (such as a curb or low barrier).

 **CAUTION:** Shorter objects that are detected (such as curbs or low barriers) can move into a blind spot. Model S cannot alert you about an object while it is in a blind spot.

- Weather conditions (heavy rain, snow, or fog).
- The object is thin (such as a sign post).
- Park Assist's operating range has been exceeded.
- The object is sound-absorbing or soft (such as powder snow).
- The object is sloped (such as a sloped embankment).
- Model S has been parked in, or being driven in, extremely hot or cold temperatures.
- The sensors (if equipped) are affected by other electrical equipment or devices that generate ultrasonic waves.
- You are driving in a location where the sensors' (if equipped) waves are deflected away from the vehicle (such as driving next to a wall or pillar).
- The object is located too close to the bumper.
- A bumper is misaligned or damaged.
- An object that is mounted to Model S is interfering with and/or obstructing Park Assist (such as a bike rack or bumper sticker).

- Model S rolls freely in the opposite direction you selected (for example, Park Assist does not display an alert if Model S rolls backwards down a hill while in Drive).

Other Parking Aids

In addition to Park Assist, when shifted into Reverse, the backup camera displays a view of the area behind Model S (see [Rear Facing Camera\(s\)](#) on page 77).



Vehicle Hold

When Model S is stopped, Vehicle Hold can continue to apply the brakes even after you remove your foot from the brake pedal.

When the vehicle's stopping mode is set to **Hold**, Vehicle Hold is automatically enabled any time the vehicle comes to a complete stop.



This indicator displays on the instrument panel whenever Vehicle Hold is actively braking Model S.

To disengage Vehicle Hold, press the accelerator pedal or press and release the brake pedal.

NOTE: Shifting into Neutral also disengages Vehicle Hold.

NOTE: After actively braking Model S for approximately ten minutes, Model S shifts into Park and Vehicle Hold cancels. Model S also shifts into Park if it detects that the driver has left the vehicle.



Touch **Controls > Pedals & Steering > Acceleration** to choose a preferred acceleration mode:

- **Chill** limits acceleration for a slightly smoother and gentler ride.

NOTE: When Chill is selected, **Chill** displays on the instrument panel, above the driving speed.

- **Sport** provides the normal level of acceleration.
- **Insane** (called **Plaid** on performance vehicles, if equipped) provides the maximum level of acceleration immediately available.

NOTE: Using the increased torque and power available in Insane or Plaid mode can reduce range and efficiency.

NOTE: Insane or Plaid strives to keep the Battery within an optimal temperature range. In addition to heating the Battery, these settings also cool the Battery when necessary (for example, while driving at high speeds, during rapid acceleration, driving for long periods, etc.).

NOTE: You can improve the efficiency of the cabin heating by reducing your selected acceleration mode. This allows the heat pump system to take more heat from the Battery to efficiently heat the cabin, instead of maintaining the Battery's ability to provide peak acceleration performance. This helps to maximize driving efficiency in colder weather. Note that when subsequently increasing the acceleration mode, the Battery requires time to warm up before the increased level of acceleration is available.

In addition, Model S features Drag Strip Mode. Using Drag Strip Mode to precondition your Model S is useful before a short distance race.

Drag Strip Mode

Drag Strip Mode preconditions the Battery and drive unit to ideal operating temperatures for timed acceleration. Model S stays in Drag Strip Mode for three hours, even if you leave the vehicle. After three hours, the feature times out to prevent unnecessary energy consumption (for example, you leave the vehicle and forget to cancel Drag Strip Mode).

When using Drag Strip Mode, Model S consumes more energy to keep the Battery within an optimal temperature range.

Cancel Drag Strip Mode at any time by toggling **Drag Strip Mode** off.

NOTE: Drag Strip Mode automatically disables Slip Start when enabled.



WARNING: Drag Strip Mode is designed for use on closed circuit driving courses only. It is the driver's responsibility to ensure that driving style and acceleration do not endanger or inconvenience other road users.

How to Launch the Vehicle

The touchscreen provides visual instructions on how to launch:

1. Touch **Controls > Pedals & Steering > Drag Strip Mode**.
2. Wait for the instrument panel to indicate that the vehicle is Peak Performance Ready.
3. With Model S shifted into Drive and at a complete stop, firmly hold the brake pedal with your left foot, then fully press the accelerator pedal.
4. Once step 3 is complete, the front suspension begins lowering into a "cheetah stance".

NOTE: Suspension lowering for "cheetah stance" significantly reduces ground clearance.

5. Wait for the instrument panel to indicate that Drag Strip Mode is Ready to Launch.
6. Once you see "Cheetah Stance Enabled" and "Ready to launch" on the instrument panel, release the brake pedal to launch the vehicle.

Track Mode

Track Mode, available only on Plaid Model S vehicles, is designed to modify the stability control, traction control, regenerative braking, and cooling systems to increase performance and handling while driving on closed circuit courses. Track Mode improves cornering ability by intelligently using the motors, and regenerative and traditional braking systems. When enabled, the cooling system runs at an increased level during and after aggressive driving sessions to allow your vehicle's systems to withstand the surplus heat.

In Track Mode, adaptive suspension damping is optimized for handling and vehicle body control to promote driver confidence in dynamic maneuvers. Ride height is automatically set to **Low** and the suspension no longer automatically raises for comfort over rough surfaces.

 **WARNING:** Track Mode is designed for use on closed circuit driving courses only. It is the driver's responsibility to drive safely and ensure others are not endangered.

 **WARNING:** Track Mode is designed for use by experienced track drivers familiar with the course. Do not use on public roads. It is the driver's responsibility to be in control of the vehicle at all times, including on the track. Because vehicle behavior (including traction and stability control) differs when using Track Mode, always use caution.

Using Track Mode

Track Mode is always disabled when you start Model S. To enable Track Mode for your current drive, shift into Park and follow these steps:

1. Touch **Controls** > **Pedals & Steering** > **Track Mode**.

When enabled, **TRACK** displays on the instrument panel above the driving speed, and a Track Mode popup appears on the map. The instrument panel displays a color-coded image of your Model S that provides you with important at-a-glance status information about the Battery, the motors, and the brakes. See [Monitoring Vehicle Health on page 75](#).

2. If desired, customize the Track Mode settings by touching **Track Mode Settings** on the Track Mode popup (see [Customizing Track Mode on page 74](#)). You can also access the Track Mode settings by touching **Pedals & Steering** > **Driving**, then touching **Customize** next to the Track Mode setting.
3. To use the Lap Timer, follow the onscreen instructions to drop a pin on the map to define the lap's start/finish location. Then press **START** on the Lap Timer to begin your driving session. Once started, the Lap Timer starts counting when you drive Model S past the lap's start/finish location where you dropped the pin. See [Using the Lap Timer on page 75](#).
4. Shift into gear and **GO!**

If you started the Lap Timer, each time you pass the start/finish location, the timer resets for the next lap. See [Using the Lap Timer on page 75](#).

A real-time accelerometer (G-meter) appears on the instrument panel. See [G-Meter on page 75](#).

When Track Mode is on:

- Autopilot features are unavailable.
- The Slip Start setting is overridden.
- Energy usage increases.
- Entertainment features are unavailable.

Use the touchscreen setting to turn Track Mode off at any time. Powering off Model S also turns off Track Mode (although it may still appear on the touchscreen if Post-Drive cooling is in progress). When Track Mode is off, all settings return to their previous state and all features return to their normal operating state.

Customizing Track Mode

To customize Track Mode, touch **Track Mode Settings** on the Track Mode popup that appears on the map when you enable Track Mode. You can also access the Track Mode settings by touching **Controls** > **Pedals & Steering**, then touching **Customize** next to the Track Mode setting. Choose an existing Track Mode setting from the list of pre-defined profiles provided by Tesla. Or create a new settings profile by touching **Add New Settings**, entering a name for the settings profile, then adjusting these settings to suit your preferences or driving scenario, or customize for a specific track:

- **Handling Balance** - Drag the slider to customize the balance of Model S in a turn. If Model S is too loose, you can choose a front-biased under-steering setup. Difficult to get the vehicle through a turn? Try a rear-biased setup to increase rotation. You can select any value, in 5% increments, between 100/0 (for 100% front biased used for under-steering) and 0/100 (for 100% rear biased used for over-steering).
- **Stability Assist** - Drag the slider to choose the level at which the stability control systems assist in controlling the vehicle. You can choose any level from -10 to +10. Choosing +10 engages all stability assist systems for controllable driving in which stability systems remain engaged, whereas -10 disables all stability systems and the stability of the drive rests solely on the driver. The default setting of 0 represents a balance which provides some stability being automatically controlled and leaving some control up to the driver.

- **Regenerative Braking** - Drag the slider to choose how much regenerative braking is available. You can choose any value, in 5% increments, between 0 and 100%. Tesla recommends the 100% setting to prevent overheating the brakes.
- **Post-Drive Cooling** - Enable if you want the cooling systems to continue cooling the vehicle's components even after you leave the vehicle. Cooling stops automatically when the components are sufficiently cool, or when you power Model S off and back on again. Post-Drive Cooling is useful if you want to quickly cool the components between driving sessions. If Post-Drive Cooling is set to OFF, the components eventually cool, but it takes longer.
- **Brake Temperatures** - Enable to display temperature warnings associated with the braking system. You may want to disable warnings if you have installed an aftermarket high performance braking system.
- **Save Dashcam for Laps** - Enable if you want to save a video and data on a USB flash drive when using the Lap Timer. A USB flash drive must be set up and inserted as described (see [USB Drive Requirements for Recording Videos on page 138](#)). The USB flash drive must contain a folder named **TeslaTrackMode**. When enabled, Track Mode stores a video and associated data for each lap. Track Mode also stores the car status and telemetry data with details about the vehicle's position, speed, acceleration, use of accelerator, etc. You can then view the video recordings and analyze this data, which is saved as a .CSV file on the USB flash drive, to determine where time is being lost or gained.

Track Mode allows you to save up to 20 settings profiles. To delete a chosen profile, touch **Delete** at the bottom of the settings screen.

NOTE: You can not change or delete a pre-defined profile provided by Tesla.

Using the Lap Timer

When you enable Track Mode, the map displays a Lap Timer. Follow the onscreen instructions to place a start/finish pin on the map. Once the pins are placed, press **START** to initiate the driving (lapping) session. When you drive Model S through the start/finish location, the Lap Timer automatically starts timing the duration of the lap, resetting the timer whenever you pass the start/finish location, and displaying the real-time delta between the current lap and the fastest lap so far in the driving session. The map highlights the track in blue.

At the completion of each lap, the Lap Timer displays the duration of the lap. It also displays the times associated with the previous and best laps in the driving session.

If **Save Dashcam for Laps** is enabled (see [Customizing Track Mode on page 74](#)), and a properly formatted USB flash drive is inserted, Track Mode saves a video of the driving session (as recorded by the front cameras), along with a .CSV file that provides detailed information about the lap.

NOTE: To stop the timer at the end of your driving session, touch **STOP** on the Lap Timer.

Monitoring Vehicle Health

You can easily monitor the health of Model S when using Track Mode by glancing at the instrument panel. The colors indicate the status of the various components, allowing you to determine the current operating state and make decisions accordingly. The components are displayed in green when operating within their ideal temperature range. Colors change as follows:

- The Battery displays blue when cold and red when hot.
- A brake displays blue when cold and orange when hot (an early warning for overheating brakes, which are shown in red).
- A motor displays blue when it's cold or red when it's hot.
- Dynamic readings of the tire pressures displays on the touchscreen. A tire displays blue when under-used or red when the peak grip is exceeded.

NOTE: A component displayed in red may indicate a need to stop driving and allow the component to cool.



CAUTION: Any vehicle damage or injuries caused by using Track Mode is the driver's responsibility. The vehicle warranty does not cover damage caused by excessive overuse of vehicle components. It also does not cover racing, autocross, or driving in competition.

G-Meter

In Track Mode, a real-time G-Meter displays on the instrument panel. The G-Meter graphically displays peak lateral, acceleration, and deceleration values in the form of a circular meter. The history of your drive is represented in the shaded area. The G-Meter resets at the start of each driving session.



Displaying Trip Information

Trip information displays on the touchscreen when you touch **Controls > Trips**. For the current trip, you can display distance, duration and average energy usage. You can also show distance and total and average energy used since your last charge and for additional trips.

To name or rename a trip, touch the trip's name, enter a new name for the trip, then press **Save**. To reset a particular trip meter, touch its associated **Reset** button.

Odometer

To display the odometer, do either of the following:

- Touch **Controls > Software**.
- Touch **Controls > Trips**.
- Open the mobile app and scroll down to the bottom of the main screen.



Camera Location

Model S is equipped with a rear view camera located above the rear license plate.

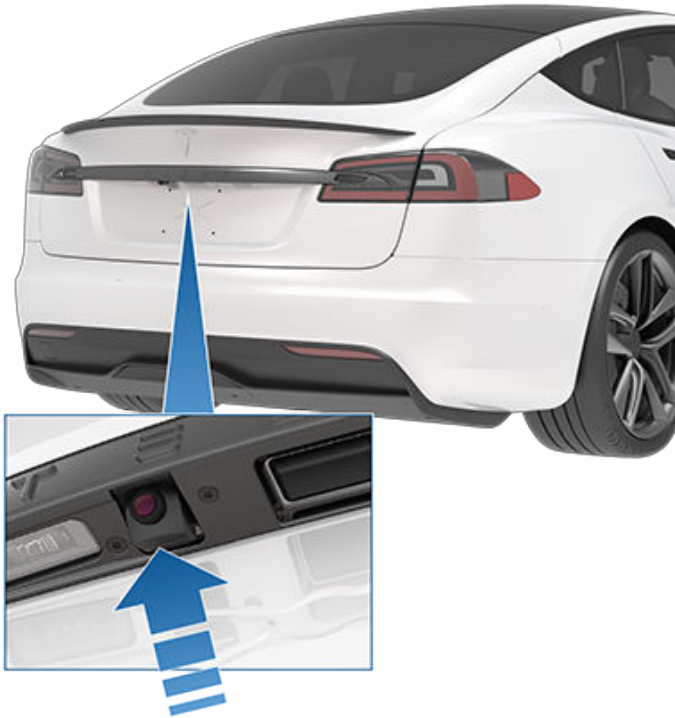

Whenever you shift into Reverse, the touchscreen displays the view from the camera. Lines show your driving path based on the position of the steering yoke (or steering wheel). These lines adjust as you move the steering yoke (or steering wheel).

Model S also displays images from the side cameras (if equipped). Simply swipe up or down to hide or show the side camera views.

NOTE: Visual feedback from Park Assist also appears on the instrument panel (see [Park Assist on page 70](#)).



To display the view from the rear view cameras at any time, open the app launcher and touch the Camera app.

If a black screen appears on the touchscreen instead of the rear view camera feed when in Reverse, use the rear view mirrors and ensure your surroundings are safe before continuing to Reverse. If inoperability of the rear view camera persists, use the mobile app to schedule a service appointment.

WARNING: Never depend on the cameras to inform you if the area behind you is free of objects and/or people. The cameras may not detect objects or barriers that can potentially cause damage or injury. In addition, several external factors can reduce the performance of the cameras, including a dirty or obstructed lens. Therefore, depending on the cameras to determine if Model S is approaching an obstruction can result in damage to the vehicle and/or objects and can potentially cause serious injury. Always inspect the area with your own eyes. When reversing, perform shoulder checks and use all mirrors. Use the cameras for guidance purposes only. It is not intended to replace your own direct visual checks and is not a substitute for careful driving.

Cleaning a Camera

To ensure a clear picture, the camera lens must be clean and free of obstructions. Remove any build-up of dirt or debris by spraying water onto the camera lens with a spray bottle.

CAUTION: Do not attempt to remove dirt or debris by wiping an exposed lens with your hands or a cloth. This debris can damage the surface of the lens when rubbed against it during wiping.

CAUTION: Do not use chemical-based or abrasive cleaners. Doing so can damage the surface of the lens.



Pedestrian Warning System

The Pedestrian Warning System causes Model S to emit sound when driving below approximately 32 km/h (19 mph), or while driving in reverse. Electric vehicles operate quietly and this sound helps to alert pedestrians of your oncoming vehicle. The sound, which activates whenever Model S is shifted out of Park, gets louder as speed increases.

 **WARNING:** If sound cannot be heard, pedestrians may not be aware of your oncoming vehicle, which may increase the likelihood of a collision resulting in serious injury or death. If the Pedestrian Warning System is not operating, immediately contact Tesla.



To ensure that Model S provides you with the best ownership experience possible in harsh cold weather conditions, follow these best practices.

Before Driving

When snow and ice accumulate on your vehicle, moving parts, such as the door handles, windows, mirrors, and wipers can freeze in place. To achieve maximum range and performance, it is helpful to warm the cabin and Battery before you leave. There are several ways to do so:

- Touch **Schedule**, available on both the charging and climate control screens, to set a time when you want your vehicle to be ready to drive (see [Scheduled Charging and Scheduled Departure on page 168](#)).
- In the mobile app, navigate to **Climate** to customize the temperature at which you want to heat the cabin. This also warms the high voltage Battery as needed.
- In the mobile app, navigate to **Climate > Defrost Car** to melt snow, ice, and frost on the windshield, windows, and mirrors. This also warms the high voltage Battery as needed.

NOTE: Tesla recommends activating climate settings at least 30-45 minutes before departure (see [Climate Controls on page 119](#)). Preconditioning times depend on outside temperature and other factors. The mobile app will notify you once your vehicle has reached the desired preconditioning temperature.

Charge Port

- If your charge port latch freezes in place and a charging cable becomes stuck in the charge port, try manually releasing the charge cable. See [Manually Releasing Charge Cable on page 167](#).
- In extremely cold weather or icy conditions, it is possible that your charge port latch may freeze in place. In cases where you cannot remove or insert the charge cable, or the vehicle is not Supercharging due to the latch being frozen in place, use the **Defrost Car** setting in the mobile app. This can help thaw ice on the charge port latch so the charge cable can be removed or inserted.

NOTE: You can also prevent the occurrence of a charge port latch freezing in place by using the **Schedule** settings (see [Scheduled Charging and Scheduled Departure on page 168](#)).

NOTE: If your charge port latch is frozen in place, it may not lock the charging cable in place when inserted, but it can still charge at a slow AC rate even if the latch is not engaged.

Charging

By using Trip Planner (if available in your market region) to navigate to a Tesla charging location, Model S preheats the high voltage battery to ensure when you arrive at the charger, the temperature of the battery is optimal and ready to charge. This reduces the amount of time it takes to charge. See (see [Trip Planner on page 151](#)).

NOTE: Tesla recommends using Trip Planner to navigate to a charging location for at least 30-45 minutes before arrival to ensure optimal battery temperature and charging conditions. If the drive to the charging location is less than 30-45 minutes, consider preconditioning the battery before driving (see [Before Driving on page 79](#)).

NOTE: The thermal system may produce steam under certain conditions. For example, odorless steam can come from the front of your vehicle while charging at a Supercharger in cold temperature. This is normal and not a cause for concern.

Windows

- In the mobile app, go to **Climate**, swipe up from the bottom and select **Defrost Car**, which helps melt snow, ice, and frost on the windshield, windows, and mirrors.
- In cold temperatures, Model S automatically makes a slight adjustment to the position of the windows to make it easier to open doors.

NOTE: Always connect to an external, low voltage power supply before opening a door when the vehicle has no power to avoid breaking a window.

- Use the mobile app to schedule a service appointment for Tesla to provide hydrophobic coating to the side and rear windows (not the front) for a nominal fee.

Mirrors

If ice buildup is expected when parking, turn off **Auto-Fold Mirrors**. Touch **Controls > Auto-Fold**. Ice can prevent exterior side mirrors from folding or unfolding.

NOTE: Side mirrors automatically heat as needed during preconditioning, or when the rear defroster is turned on.

Wipers

If you expect snow or ice to build up when parked, touch **Controls > Service > Wiper Service Mode**. This raises wipers against the windshield so they can defrost when the windshield defrosts (see [Wipers and Washers on page 65](#)). You can also turn on wiper defrosters (if equipped). See [Climate Controls on page 119](#).



Cold Weather Best Practices

Tires and Tire Chains

- Use winter tires to increase traction in snowy or icy conditions. You can purchase winter tires on <http://www.tesla.com> (see [Seasonal Tire Types on page 176](#)).
- Tire chains provide additional traction when driving in snowy or icy conditions. Check local regulations to determine if tire chains are recommended or required during winter months. See [Using Tire Chains on page 177](#) for more information.

Your vehicle's tire pressures will drop in cold ambient temperatures. If the TPMS indicator light appears, inflate the tires before driving. The tires will lose one PSI for every 10° F (6° C) drop in outside temperature (see [Tire Care and Maintenance on page 173](#)). Proper tire pressures help protect tires from potholes and improve range when properly inflated.

While Driving

Cold weather can increase energy consumption because more power is required for driving, cabin and Battery heating. Follow these suggestions to reduce energy consumption:

- Use seat heaters to keep warm. Seat heaters use less energy than the cabin heater. Lowering the cabin temperature and using seat heaters reduces energy consumption (see [Climate Controls on page 119](#)).
- Slow down your driving and avoid frequent and rapid acceleration.
- You can improve the efficiency of the cabin heating by reducing your selected acceleration mode (see [Acceleration Modes on page 73](#)). This allows the heat pump system to take more heat from the Battery to efficiently heat the cabin, instead of maintaining the Battery's ability to provide peak acceleration performance. This helps to maximize driving efficiency in colder weather. Note that when subsequently increasing the acceleration mode, the Battery requires time to warm up before the increased level of acceleration is available.

Regenerative Braking

Regenerative braking can be limited if the Battery is too cold. As you continue to drive, the Battery warms up and regenerative power increases (see [Regenerative Braking on page 67](#)).

NOTE: Limited regenerative braking can be avoided if you allow enough time to precondition your vehicle or if you use **Schedule** to precondition Model S before your departure time (see [Scheduled Charging and Scheduled Departure on page 168](#)).

Blue Snowflake Icon



A blue snowflake icon appears on your instrument panel when some of the stored energy in the Battery is unavailable because the Battery is cold. This portion of unavailable energy displays in blue on the Battery meter. Regenerative braking, acceleration, and charging rates may be limited. The snowflake icon no longer displays when the Battery is sufficiently warm.

After Driving

Leave Model S plugged in when not in use. This uses the charging system, rather than the battery itself, to keep the battery warm (see [High Voltage Battery Information on page 161](#)).

Scheduled Departure

When parked, plug in Model S and use the **Schedule** settings, available on both the charging and climate control screens, to set a time when you want to precondition Model S (see [Scheduled Charging and Scheduled Departure on page 168](#)). Your vehicle determines the appropriate time to begin charging so it is complete during off-peak hours and the cabin and Battery are warm by your set departure time. For more information, see [Scheduled Charging and Scheduled Departure on page 168](#).

Storage

If you leave Model S parked for an extended period of time, plug the vehicle into a charger to prevent normal range loss and to keep the Battery at an optimal temperature. Your vehicle is safe to stay plugged in for any length of time.

When not in use, Model S enters a sleep mode to conserve energy. Reduce the number of times you check your vehicle's status on the mobile app, as this automatically wakes up your vehicle and starts normal energy consumption.



How It Works

Your Model S includes the following components that actively monitor the surrounding area:

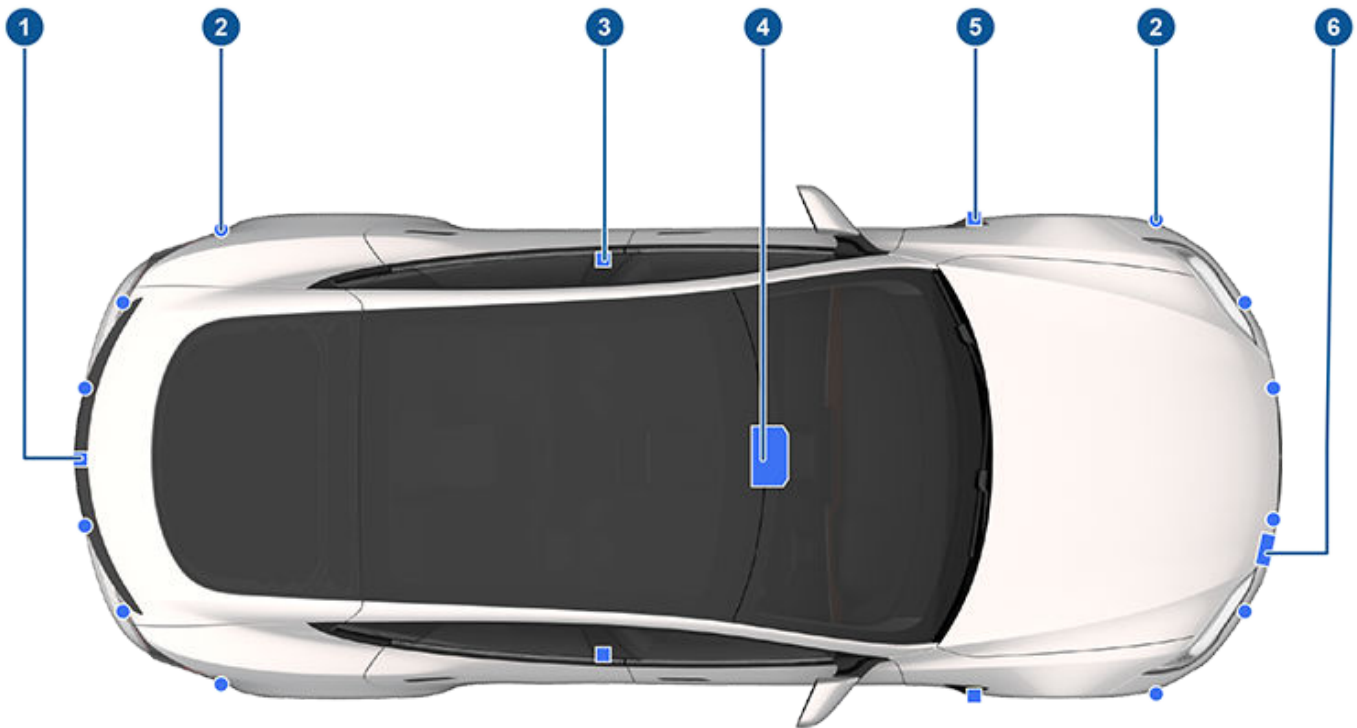

1. A camera is mounted above the rear license plate.
2. Ultrasonic sensors (if equipped) are located in the front and rear bumpers.
3. A camera is mounted in each door pillar.
4. Three cameras are mounted to the windshield above the rear view mirror.
5. A camera is mounted to each front fender.
6. Radar (if equipped) is mounted behind the front bumper.

Model S is also equipped with high precision electronically-assisted braking and steering systems.

In addition, the cabin camera (if equipped) can determine driver inattentiveness and provide alerts when Autopilot is engaged. By default, data from the camera does not leave the vehicle itself. In other words, data is not saved or transmitted unless you enable data sharing. To enable data sharing, touch **Controls > Software > Data Sharing > Allow Cabin Camera Analytics**. Cabin Camera Analytics helps Tesla continue to develop even safer vehicles in the future. See [Cabin Camera on page 118](#).

NOTE: Ensure all cameras and sensors (if equipped) are clean before each drive. See [Cleaning Cameras and Sensors on page 83](#) for more information. Dirty cameras and sensors, as well as environmental conditions such as rain and faded lane markings, can affect Autopilot performance.



Active Safety Features

These Active Safety features are designed to increase your safety:

- Lane Assist (see [Lane Assist on page 111](#))
- Collision Avoidance Assist (see [Collision Avoidance Assist on page 114](#))
- Speed Assist (see [Speed Assist on page 117](#))
- Cabin Camera (see [Cabin Camera on page 118](#))

You can enable/disable some of these features and in some cases, control how they work. To access settings for these features, touch **Controls** > **Autopilot**.

Autopilot Features

NOTE: Depending on market region, vehicle configuration, options purchased, software version and build date, your vehicle may not be equipped with all features listed below, or a feature may not operate as described.

These Autopilot convenience features are designed to reduce driver workload:

- Traffic-Aware Cruise Control (see [Traffic-Aware Cruise Control on page 84](#))
- Autosteer (see [Autosteer on page 88](#))
- Auto Lane Change (see [Auto Lane Change on page 90](#))
- Autopark (see [Autopark on page 103](#))
- Summon (see [Summon on page 105](#))
- Smart Summon ([Smart Summon on page 108](#))
- Stop Light and Stop Sign Warning (see [Stop Light and Stop Sign Warning on page 91](#))
- Navigate on Autopilot (see [Navigate on Autopilot on page 93](#))
- Traffic Light and Stop Sign Control (see [Traffic Light and Stop Sign Control on page 96](#))

You can enable/disable some of these features and in some cases, control how they work. To access settings associated with these features, touch **Controls** > **Autopilot**.

Drive to Calibrate Cameras

Model S must maneuver with precision when Autopilot features are being used. Therefore, before some features can be used for the first time or after some types of service repairs, cameras must complete a self-calibration process. For your convenience, the instrument panel displays a progress indicator.

When calibration is complete, Autopilot features are available for use. Calibration typically completes after driving 20-25 miles (32-40 km), but the distance varies depending on road and environmental conditions. For example, calibration completes quicker when driving on a straight road with multiple lanes (such as a controlled-access highway), with highly-visible lane markings (in the driving lane as well as the adjacent lanes). Contact Tesla only if your Model S has not completed the calibration process after driving 100 miles (160 km) in the described conditions.

If a camera has shifted from its calibrated position (for example, the camera or windshield was replaced), you must clear the calibration. To do so, touch **Controls** > **Service** > **Camera Calibration** > **Clear Calibration**. When the calibration is cleared, Model S repeats the calibration process. While this helps re-calibrate the cameras in many cases, **Clear Calibration** may not resolve all camera and sensor concerns.

NOTE: To calibrate, cameras require highly-visible lane markings in both the driving lane and adjacent lanes (at least two lanes over on each side of the vehicle). For best results, drive in the middle lane of a multi-lane highway (ideally with at least five lanes) that has clear lane markings and minimal traffic.

NOTE: If you attempt to use a feature that is not available until the calibration process is complete, the feature is disabled and the instrument panel displays a message.

NOTE: Model S must repeat the calibration process if the cameras are serviced by Tesla, and in some cases, after a software update.

Limitations

Many factors can impact the performance of Autopilot components, causing them to be unable to function as intended. These include (but are not limited to):

- Poor visibility (due to heavy rain, snow, fog, etc.).
- Bright light (due to oncoming headlights, direct sunlight, etc.).
- Damage or obstructions caused by mud, ice, snow, etc.
- Interference or obstruction by object(s) mounted onto the vehicle (such as a bike rack).
- Obstruction caused by applying excessive paint or adhesive products (such as wraps, stickers, rubber coating, etc.) onto the vehicle.
- Traffic signs that do not conform to standard recognizable formats, such as digital or temporary speed signs.
- Narrow or winding roads.
- A damaged or misaligned body panel.
- Use of gray or aftermarket glass.



- Interference from other equipment that generates ultrasonic waves.
- Extremely hot or cold temperatures.

 **CAUTION:** If a windshield replacement is needed, take your vehicle to Tesla Service. This ensures appropriate handling and mounting of the camera(s). Failure to do so can cause one or more Autopilot features to malfunction.

 **WARNING:** The list above does not represent an exhaustive list of situations that may interfere with proper operation of Autopilot components. Never depend on these components to keep you safe. It is the driver's responsibility to stay alert, drive safely, and be in control of the vehicle at all times.

 **WARNING:** Advanced safety features may not be available during the calibration period.

 **WARNING:** Re-calibrating the cameras or sensors (if equipped) on the touchscreen is not a substitute for checking the physical positioning and condition of these components. Walk around your vehicle and inspect the cameras and sensors for physical damage. Incorrectly calibrated or positioned cameras and sensors may limit or disable the use of safety features. Contact Tesla if you suspect lingering issues.

Cleaning Cameras and Sensors

To ensure the various Autopilot components can provide information that is as accurate as possible, keep cameras and sensors (if equipped) clean and free of obstructions, condensation, or damage (see [Cleaning on page 178](#)).

Condensation can form inside the camera enclosures, especially if you park your vehicle outside in cold or wet conditions. The instrument cluster may display an alert stating that a camera is blocked and that some or all Autopilot features may be temporarily restricted until the camera vision is clear. To proactively dry the condensation, precondition the cabin by setting it to a warm temperature, turning the windshield defroster on, and directing the front air vents toward the door pillars (see [Mobile App on page 145](#)).

 **CAUTION:** Do not wipe an exposed lens with your hands or a cloth in an attempt to remove dirt or debris. The debris can damage the surface of the lens when wiped.

 **CAUTION:** Do not use chemical-based or abrasive cleaners. Doing so can damage surfaces.

 **CAUTION:** Do not clean an ultrasonic sensor (if equipped) or camera lens with a sharp or abrasive object that can scratch or damage its surface.



Traffic-Aware Cruise Control

NOTE: Depending on market region, vehicle configuration, options purchased, and software version, your vehicle may not be equipped with Traffic-Aware Cruise Control, or the feature may not operate exactly as described. If your vehicle is not equipped, refer to the owner's manual on your vehicle's touchscreen for instructions on how to use Cruise Control.

NOTE: Traffic-Aware Cruise Control is a BETA feature.

Traffic-Aware Cruise Control determines when there is a vehicle in front of you in the same lane. If the area in front of Model S is clear, Traffic-Aware Cruise Control maintains a set driving speed. When a vehicle is detected, Traffic-Aware Cruise Control is designed to slow down Model S as needed to maintain a selected time-based distance from the vehicle in front, up to the set speed. Traffic-Aware Cruise Control does not eliminate the need to watch the road in front of you and to manually apply the brakes when needed.

Traffic-Aware Cruise Control is primarily intended for driving on dry, straight roads, such as highways.

CAUTION: Ensure all cameras and sensors (if equipped) are clean before each drive. Dirty cameras and sensors, as well as environmental conditions such as rain and faded lane markings, can affect Autopilot performance.

WARNING: Traffic-Aware Cruise Control is designed for your driving comfort and convenience and is not a collision warning or avoidance system. It is your responsibility to stay alert, drive safely, and be in control of the vehicle at all times. Never depend on Traffic-Aware Cruise Control to adequately slow down Model S. Always watch the road in front of you and be prepared to take corrective action at all times. Failure to do so can result in serious injury or death.

WARNING: Although Traffic-Aware Cruise Control is capable of detecting pedestrians and cyclists, never depend on Traffic-Aware Cruise Control to adequately slow Model S down for them. Always watch the road in front of you and be prepared to take corrective action at all times. Failure to do so can result in serious injury or death.

WARNING: Do not use Traffic-Aware Cruise Control on winding roads with sharp curves, on icy or slippery road surfaces, or when weather conditions (such as heavy rain, snow, fog, etc.) make it inappropriate to drive at a consistent speed. Traffic-Aware Cruise Control does not adapt driving speed based on road and driving conditions.

To Use Traffic-Aware Cruise Control

To initiate Traffic-Aware Cruise Control when no vehicle is detected ahead of you, you must be driving at least 18 mph (30 km/h), unless certain vehicle and environmental conditions are met, in which case, you may be able to initiate it at lower speeds. If a vehicle is

detected ahead of you, you can initiate Traffic-Aware Cruise Control at any speed, even when stationary, provided Model S is at least 5 feet (1.5 m) behind the detected vehicle and certain vehicle and environmental conditions are met.

NOTE: The maximum cruising speed is 90 mph (150 km/h). It is the driver's responsibility to cruise at a safe speed based on road conditions and speed limits.

40
MAX

When Traffic-Aware Cruise Control is available but not engaged, the instrument panel displays the cruising speed in gray. The number shown represents the cruising speed that will be set when you engage Traffic-Aware Cruise Control.

40
MAX

When Traffic-Aware Cruise Control is actively cruising at a set cruising speed, the cruising speed is highlighted with blue text.

1. Touch **Controls > Autopilot > Autosteer Activation** and choose **Double Click** to allow you to use Traffic-Aware Cruise Control independently of Autosteer when you single press the right scroll wheel.
NOTE: If **Autosteer Activation** is set to single-click, pressing the right scroll wheel once also activates Autosteer (which includes Traffic-Aware Cruise Control).
2. You can choose whether Traffic-Aware Cruise Control engages at the currently detected speed limit or your current driving speed. Touch **Controls > Autopilot > Set Speed** and choose either **Speed Limit** or **Current Speed**. If you choose to engage Traffic-Aware Cruise Control at the currently detected speed limit, you can specify an offset. Touch **Set Speed Offset**. You can choose a **Fixed** offset, in which the cruising speed adjusts by a specific number of mph (km/h) on all roads, or a **Percentage** offset, in which the cruising speed is adjusted as a percentage of the road's detected speed limit.
WARNING: When cruising at the speed limit, there may be situations where the cruising speed may not change when the speed limit changes.
WARNING: Do not rely on Traffic-Aware Cruise Control or Speed Assist to determine an accurate or appropriate cruising speed. It is the driver's responsibility to cruise at a safe speed based on road conditions and applicable speed limits.
3. To engage Traffic-Aware Cruise Control, press the right scroll wheel.

NOTE: If the setting for **Autosteer Activation** is set to **Single Click** (touch **Controls > Autopilot > Autosteer Activation**), Autosteer engages.



- To change your speed while using Traffic-Aware Cruise Control, you can roll the right scroll wheel on the steering wheel up or down. For more details, see [Changing the Cruising Speed on page 85](#).
- To cancel Traffic-Aware Cruise Control, press the right scroll wheel, or press the brake pedal. See [Canceling and Resuming on page 87](#) for more information.

Set Traffic-Aware Cruise Control Chime

If you want a chime to sound when you engage or cancel Traffic-Aware Cruise Control, touch **Controls** > **Autopilot** > **Traffic-Aware Cruise Control Chime**.

NOTE: Model S must be in Park.

Changing the Cruising Speed

Roll the right scroll wheel up to increase, or down to decrease, the set speed. Slowly rolling the scroll wheel changes the set speed in 1 mph (1 km/h) increments and quickly rolling the scroll wheel changes the set speed to the closest 5 mph (5 km/h) increment. For example, if you are traveling at 57 mph and quickly roll the scroll wheel, the speed increases to 60 mph.



NOTE: It may take a few seconds for Model S to reach the new cruising speed, assuming Model S is not cruising behind a vehicle that is driving slower than your set speed.

Cruising at the Set Speed

Traffic-Aware Cruise Control maintains your set cruising speed whenever a vehicle is not detected in front of Model S. When cruising behind a detected vehicle, Traffic-Aware Cruise Control accelerates and decelerates Model S as needed to maintain a chosen following distance (see [Adjust the Following Distance on page 86](#)), up to the set speed.

Traffic-Aware Cruise Control also adjusts the cruising speed when entering and exiting curves.

You can manually accelerate at any time when cruising at a set speed, but when you release the accelerator, Traffic-Aware Cruise Control resumes cruising at the set speed.

NOTE: When Traffic-Aware Cruise Control is actively slowing down Model S to maintain the selected distance from the vehicle ahead, brake lights turn on to alert other road users that you are slowing down. You may notice slight movement of the brake pedal. However, when Traffic-Aware Cruise Control is accelerating Model S, the accelerator pedal does not move.

WARNING: Traffic-Aware Cruise Control may occasionally cause Model S to brake when not required or when you are not expecting it. This can be caused by closely following a vehicle ahead, detecting vehicles or objects in adjacent lanes (especially on curves), etc.

WARNING: Due to limitations inherent in the onboard GPS (Global Positioning System), you may experience situations in which Model S slows down, especially near exits or off-ramps where a curve is detected and/or you are navigating to a destination and not following the route.

WARNING: Traffic-Aware Cruise Control may not detect all objects and, especially when cruising over 50 mph (80 km/h), may not brake/decelerate when a vehicle or object is only partially in the driving lane or when a vehicle you are following moves out of your driving path and a stationary or slow-moving vehicle or object is in front of you. Always pay attention to the road ahead and stay prepared to take immediate corrective action. Depending on Traffic-Aware Cruise Control to avoid a collision can result in serious injury or death. In addition, Traffic-Aware Cruise Control may react to vehicles or objects that either do not exist, or are not in your lane of travel, causing Model S to slow down unnecessarily or inappropriately.

WARNING: Traffic-Aware Cruise Control may be unable to provide adequate speed control because of limited braking capability and hills. It can also misjudge the distance from a vehicle ahead. Driving downhill can increase driving speed, causing Model S to exceed your set speed (and potentially the road's speed limit). Never depend on Traffic-Aware Cruise Control to slow down Model S enough to prevent a collision. Always keep your eyes on the road when driving and be prepared to take corrective action as needed. Depending on Traffic-Aware Cruise Control to reduce your driving speed enough to prevent a collision can result in serious injury or death.



HOLD State

When following a vehicle, Traffic-Aware Cruise Control remains active at low speeds, even when Model S comes to a full stop. When the vehicle is moving again, Traffic-Aware Cruise Control resumes operating at the set speed. However, under the following circumstances, Traffic-Aware Cruise Control goes into a **HOLD** state, in which case, you need to briefly press the accelerator pedal to resume cruising. When the **HOLD** status is active, the instrument panel displays the **HOLD** icon and a message that indicates that you need to resume cruise control. The following circumstances can cause Traffic-Aware Cruise Control to go into the **HOLD** state:

- Model S has been at a standstill for 5 minutes.
- Model S detects a pedestrian (the **HOLD** state may clear when the pedestrian is no longer detected).
- Model S suddenly loses visibility of the vehicle in front of you.
- An obstacle is detected in front of Model S.

Cruising Near or On Exits

When cruising near an exit on a controlled-access highway and engaging the turn signal toward the off-ramp, Traffic-Aware Cruise Control assumes you are exiting and begins to slow down Model S. If you do not drive onto the off-ramp, Traffic-Aware Cruise Control resumes cruising at the set speed. In a region with right hand traffic, this occurs only when you engage the right turn signal when driving in the right-most lane within 164 feet (50 meters) of an exit. Likewise in regions with left hand traffic; when engaging the left turn signal when driving in the left-most lane within 164 feet (50 meters) of an exit.

When cruising onto an on-ramp to a controlled-access highway, Traffic-Aware Cruise Control automatically adjusts the set cruising speed to the speed limit of the highway, plus any offset you have specified.

NOTE: The on-board Global Positioning System (GPS) determines if you are driving in a region with right or left hand traffic. In situations where GPS data is unavailable (for example, if there is inadequate signal), engaging the turn signal near an exit does not cause Traffic-Aware Cruise Control to slow down Model S.

When enabled while on a highway interchange or off-ramp, Traffic-Aware Cruise Control may reduce your set speed in 5 mph (5 km/h) increments – to as slow as 25 mph (40 km/h) – to better match the reported speeds of other Tesla vehicles that have driven at that specific location. To override this and continue cruising at your set speed, tap the accelerator pedal. The new set speed is maintained for the duration of the interchange or off-ramp (unless you override it or cancel Traffic-Aware Cruise Control). After the interchange or off-ramp, the set speed may revert or change as necessary

based on the new location. For example, if you merged onto a different highway, the set cruising speed reverts back to what it was before driving on the interchange.

 **WARNING:** In some cases (such as having insufficient data), Traffic-Aware Cruise Control may not automatically reduce the set speed on the highway interchange or off-ramp. Do not rely on Traffic-Aware Cruise Control to determine an appropriate driving speed. Tesla recommends driving at a speed that is safe for road conditions and within posted speed limits.

Adjust the Following Distance

To adjust the following distance you want to maintain between Model S and a vehicle traveling ahead of you, touch **Controls** > **Autopilot** > **Cruise Follow Distance**. Each setting corresponds to a time-based distance that represents how long it takes for Model S, from its current location, to reach the location of the rear bumper of the vehicle ahead of you. Your setting is retained until you manually change it.

The closest following distance is 2.

 **WARNING:** It is the driver's responsibility to determine and maintain a safe following distance at all times. Do not rely on Traffic-Aware Cruise Control to maintain an accurate or appropriate following distance.

 **WARNING:** Never depend on Traffic-Aware Cruise Control to adequately slow down Model S to avoid a collision. Always watch the road in front of you and stay prepared to take immediate corrective action.

Overtake Acceleration

When following a vehicle with Traffic-Aware Cruise Control active, engaging the turn signal (to indicate a move into the passing lane) accelerates Model S towards the vehicle ahead. By momentarily holding the turn signal, you can quickly accelerate up to your set speed without having to press the accelerator pedal. The turn signal causes acceleration only when all of the following conditions are met:

- Traffic-Aware Cruise Control is operating and detects a vehicle in front of you.
- No obstacles or vehicles are detected in the target lane.
- Model S is traveling below the set speed, but over 45 mph (72 km/h).

Overtake Acceleration is intended as an aid when passing a vehicle ahead of you. When the turn signal is engaged, Traffic-Aware Cruise Control continues to maintain distance from the vehicle ahead, but allows you to drive slightly closer than your selected distance.



Acceleration cancels when one of the conditions happen:

- You reach your set cruising speed.
- Changing lanes takes too long.
- Model S gets too close to the vehicle ahead.

OR

- You disengage the turn signal.

NOTE: Overtake Acceleration occurs when you fully press and hold the turn signal. When you release the turn signal, Model S stops accelerating (in the same way as when you release the accelerator pedal) and resumes the set speed.

 **WARNING:** Overtake Acceleration can cancel for many unforeseen reasons in addition to those listed above (for example, lack of GPS data). Stay alert and never depend on Overtake Acceleration to increase your driving speed.

 **WARNING:** Overtake Acceleration increases your driving speed whenever the appropriate turn signal is engaged, and accelerates Model S closer to the vehicle ahead. Although Traffic-Aware Cruise Control continues to maintain distance from the vehicle ahead, it is important to be aware that your selected following distance is reduced when Overtake Acceleration is active, particularly in cases where it may not be your intention to overtake the vehicle you are following.

Canceling and Resuming

To manually cancel Traffic-Aware Cruise Control, press the brake pedal or press the right scroll wheel on the steering yoke (or steering wheel).

To resume cruising, press the right scroll button.

NOTE: When Traffic-Aware Cruise Control cancels, Model S does not coast. Instead, regenerative braking slows down Model S in the same way as when you move your foot off the accelerator when driving without Traffic-Aware Cruise Control (see [Regenerative Braking on page 67](#)).

 **WARNING:** Traffic-Aware Cruise Control cancels, or may not be available, in the following situations:

- You press the brake pedal.
- Your driving speed exceeds the maximum cruising speed of 90 mph (150 km/h).
- You shift Model S.
- A door is opened.
- A camera or sensor (if equipped) is obstructed. This could be caused by dirt, mud, ice, snow, fog, etc.
- The traction control setting is manually disabled or is repeatedly engaging to prevent wheels from slipping.

- The wheels are spinning while at a standstill.
- The Traffic-Aware Cruise Control system is failing or requires service.

When Traffic-Aware Cruise Control is unavailable or cancels, Model S no longer drives consistently at a set speed and no longer maintains a specified distance from the vehicle ahead.

 **WARNING:** Traffic-Aware Cruise Control can cancel unexpectedly at any time for unforeseen reasons. Always watch the road in front of you and stay prepared to take appropriate action. It is the driver's responsibility to be in control of Model S at all times.

Summary of Cruise Indicators

 Traffic-Aware Cruise Control is available but is not actively controlling your speed until you activate it. The number shown in gray is the cruising speed that will be set when you engage Traffic-Aware Cruise Control.

 Traffic-Aware Cruise Control is actively cruising and is either maintaining the set speed (no vehicle in front) or is maintaining a chosen following distance from a vehicle ahead (up to the set speed).

 Model S has fully stopped but is in a **HOLD** state. If safe, press the accelerator pedal to resume cruising at the set speed.

Limitations

Traffic-Aware Cruise Control is particularly unlikely to operate as intended in the following types of situations:

- The road has sharp curves.
- Visibility is poor (due to heavy rain, snow, fog, etc.).
- Bright light (such as from oncoming headlights or direct sunlight) is interfering with the view of the camera(s).
- A camera or sensor (if equipped) is obstructed (fogged over, dirty, covered by a sticker, etc.).

 **WARNING:** The list above does not represent an exhaustive list of situations that may interfere with proper operation of Traffic-Aware Cruise Control.



Autosteer

NOTE: Depending on market region, vehicle configuration, options purchased, and software version, your vehicle may not be equipped with Autosteer, or the feature may not operate exactly as described.

NOTE: Autosteer is a BETA feature.

Autosteer builds upon Traffic-Aware Cruise Control (see [Traffic-Aware Cruise Control on page 84](#)), intelligently keeping Model S in its driving lane when cruising at a set speed. Autosteer also allows you to use the turn signals to move Model S into an adjacent lane (see [Auto Lane Change on page 90](#)). Autosteer detects lane markings and the presence of vehicles and objects to steer Model S.

NOTE: To display more details about the roadway and its surroundings, such as road markings, stop lights, objects (such as trash cans and poles), etc., touch **Controls** > **Autopilot** > **Full Self-Driving Visualization Preview** (if equipped).

 **CAUTION:** Ensure all cameras and sensors (if equipped) are clean. Dirty cameras and sensors, as well as environmental conditions such as rain and faded lane markings, affect performance.

 **WARNING:** Autosteer is a hands-on feature. You must keep your hands on the steering yoke (or steering wheel) at all times.

 **WARNING:** Autosteer is intended for use on controlled-access highways with a fully attentive driver. When using Autosteer, hold the steering yoke (or steering wheel) and be mindful of road conditions and surrounding traffic. Do not use Autosteer in construction zones, or in areas where bicyclists or pedestrians may be present. Never depend on Autosteer to determine an appropriate driving path. Always be prepared to take immediate action. Failure to follow these instructions could cause damage, serious injury or death.

Operating Autosteer

Before you can operate Autosteer, you must enable it by touching **Controls** > **Autopilot** > **Autosteer (Beta)**.



To indicate that Autosteer is available (but not actively steering Model S), the instrument panel displays a gray Autosteer icon.



Steering yoke option

To initiate Autosteer, press the right scroll wheel.

NOTE: If the setting for **Autosteer Activation** is set to **Single Click** (touch **Controls** > **Autopilot** > **Autosteer Activation**), Autosteer engages when you single-press the right scroll wheel. If set to **Double Click**, you must double-press the right scroll wheel to engage Autosteer.



To indicate that Autosteer is now actively steering Model S, the instrument panel displays the Autosteer icon in blue. When Autosteer is able to detect lane markings, it also displays the driving lane in blue.

Steering yoke option



Autosteer briefly displays a message on the instrument panel reminding you to pay attention to the road and be ready to take over at any time.

The speed at which you can initiate Autosteer can vary depending on various conditions and whether or not a vehicle is detected ahead of you. When no vehicle is detected ahead of you, you must be driving at least 18 mph (30 km/h), unless certain vehicle and environmental conditions are met, in which case, you may be able to initiate it at lower speeds. When a vehicle is detected ahead of you, you can initiate Autosteer at any speed, even when stationary, provided Model S is at least 5 feet (150 cm) behind the detected vehicle.

NOTE: Auto High Beam is automatically enabled when Autosteer is engaged and the maximum cruising speed is 85 mph (140 km/h).

 **CAUTION:** If available in your market region, Model S detects lights from an emergency vehicle when using Autosteer at night on a high speed road, the driving speed is automatically reduced and the instrument panel displays a message informing you of the slowdown. You will also hear a chime and see a reminder to keep your hands on the steering yoke (or steering wheel). When the light detections pass by or cease to appear, Autopilot resumes your cruising speed. Alternatively, you may tap the accelerator to resume your cruising speed.

 **WARNING:** Never depend on Autopilot features to determine the presence of emergency vehicles. Model S may not detect lights from emergency vehicles. Keep your eyes on your driving path and always be prepared to take immediate action.

In situations where Autosteer is temporarily unavailable, the Autosteer icon disappears. For example, your driving speed is not within the speed required for Autosteer to operate. Autosteer may also be unavailable if it is not receiving adequate data from the camera(s).

NOTE: In low light conditions (dusk or dark), Autosteer aborts or is unavailable if headlights are set to **Off**. For best results, set headlights to **Auto**.

If unable to detect lane markings, Autosteer may determine the driving lane based on a vehicle you are following.

In most cases, Autosteer attempts to center Model S in the driving lane. However, there may be situations in which Autosteer may steer Model S in a driving path that is offset from the center of the lane (for example, detection of guard rails).

 **WARNING:** Autosteer is not designed to, and will not, steer Model S around objects partially in a driving lane and in some cases, may not stop for objects that are completely blocking the driving lane. Always watch the road in front of you and stay prepared to take immediate action. It is the driver's responsibility to be in control of Model S at all times.

Restricted Speed

On a controlled-access highway, the cruising speed reflects the speed limit, taking into consideration any offset you've specified using Speed Assist. However, if you choose to use Autosteer on residential roads, a road without a center divider, or a road where access is not limited, Autosteer may limit the maximum allowed cruising speed and the instrument panel displays a message indicating that speed is restricted. The restricted speed will be the speed limit of the road plus 5 mph (10 km/h).

In situations where the speed limit cannot be detected when Autosteer is engaged, Autosteer reduces your driving speed and limits the set cruising speed to 45 mph (70 km/h). Although you can manually accelerate to exceed the limited speed, Model S may not brake for detected obstacles. Autosteer slows down to the limited speed when you release the accelerator pedal. When you leave the road, or disengage Autosteer by using the steering yoke (or steering wheel), you can increase your set speed again, if desired.

Hold Steering Yoke (or Steering Wheel)

Autosteer determines how best to steer Model S. When active, Autosteer requires you to hold the steering yoke (or steering wheel). If it does not detect your hands on the steering yoke (or steering wheel) for a period of time, a flashing light appears along the top of the instrument panel and the following message displays:

Steering yoke alert:



Apply slight turning force to steering yoke

Steering wheel alert:



Apply slight turning force to steering wheel

Autosteer detects your hands by recognizing slight resistance as the steering yoke (or steering wheel) turns, or from you manually turning the steering yoke (or steering wheel) very lightly (without enough force to take over steering). Autosteer also qualifies your hands as being detected if you engage a turn signal or use a button or scroll wheel on the steering yoke (or steering wheel).

NOTE: When your hands are detected, the message disappears and Autosteer resumes normal operation.

Autosteer requires that you pay attention to your surroundings and remain prepared to take control at any time. If Autosteer still does not detect your hands on the steering yoke (or steering wheel), the flashing light on the instrument panel increases in frequency and a chime sounds.

If you repeatedly ignore Autosteer's prompts to apply slight force to the steering yoke (or steering wheel), Autosteer disables for the rest of the drive and displays the following message requesting you to drive manually. If you don't resume manual steering, Autosteer sounds a continuous chime, turns on the warning flashers, and slows the vehicle to a complete stop.



Autosteer unavailable for the rest of this drive. Hold steering yoke (or steering wheel) to drive manually.

For the rest of the drive, you must steer manually. Autosteer is available again on your next drive (after you stop and shift Model S into Park).

Take Over Immediately

In situations where Autosteer is unable to steer Model S, Autosteer sounds a warning chime and displays the following message on the instrument panel:



Take over immediately

When you see this message, **TAKE OVER STEERING IMMEDIATELY.**

Canceling Autosteer

Autosteer cancels when:

- You press the brake pedal.
- You start steering manually.
- You exceed the maximum speed at which Autosteer operates – 90 mph (150 km/h).
- You shift.
- A door is opened.
- An Automatic Emergency Braking event occurs (see [Collision Avoidance Assist on page 114](#)).

When Autosteer cancels, it sounds a chime and the Autosteer icon either turns gray to indicate that Autosteer is no longer active, or disappears to indicate that it is not currently available.

NOTE: If **Autosteer Activation** is set to **Double Click** and Autosteer cancels because you started steering manually, Traffic-Aware Cruise Control remains active. If **Autosteer Activation** is set to **Single Click** and Autosteer cancels because you started steering manually, Traffic-Aware Cruise Control also cancels.

To disable Autosteer so it is no longer available, touch **Controls > Autopilot > Autosteer (Beta)**.

Auto Lane Change

NOTE: Depending on market region, vehicle configuration, options purchased, and software version, your vehicle may not be equipped with Auto Lane Change, or the feature may not operate exactly as described.

When Autosteer is active, engage a turn signal to move Model S into an adjacent lane (moving the steering yoke (or steering wheel) would cancel Autosteer).



WARNING: It is the driver's responsibility to determine whether a lane change is safe and appropriate. Therefore, before initiating a lane change, always check blind spots, lane markings, and the surrounding roadway to confirm it is safe and appropriate to move into the target lane.

WARNING: Never depend on Auto Lane Change to determine an appropriate driving path. Drive attentively by watching the road and traffic ahead of you, checking the surrounding area, and monitoring the instrument panel for warnings. Always be prepared to take immediate action.

WARNING: Do not use Auto Lane Change on roads where traffic conditions are constantly changing and where bicycles and pedestrians are present.

WARNING: The performance of Auto Lane Change depends on the ability of the camera(s) to recognize lane markings.

WARNING: Do not use Auto Lane Change on winding roads with sharp curves, on icy or slippery roads, or when weather conditions (such as heavy rain, snow, fog, etc.) may be obstructing the view from the camera(s) or sensors (if equipped).

WARNING: Failure to follow all warnings and instructions can result in property damage, serious injury or death.

Operating Auto Lane Change

Auto Lane Change is available whenever Autosteer is active. To change lanes using Auto Lane Change:

1. Perform visual checks to make sure it is safe and appropriate to move into the target lane.
2. Engage the appropriate turn signal, keeping your hands on the steering yoke (or steering wheel).
3. If needed, cancel the turn signal once you are in the target lane.

NOTE: The minimum speed at which Auto Lane Change operates may vary depending on region, adjacent lane speeds, and other factors. Always be ready to manually steer and change lanes as necessary.

Auto Lane Change moves Model S into the adjacent lane in the direction indicated by the turn signal, provided the following conditions are met:

- The turn signal is engaged.
- Model S does not detect a vehicle in its blind spot, or a vehicle or obstacle up to the center of the target lane.
- Lane markings indicate that a lane change is permitted.
- Midway through the lane change, Model S must detect the target lane's outside lane marking. If this lane marking is not detected, the lane change is aborted and Model S returns to its original driving lane.
- The view of the camera(s) is not obstructed.

When an automatic lane change is in progress, Overtake Acceleration is activated, allowing Model S to accelerate closer to a vehicle in front (see [Overtake Acceleration on page 86](#)).

NOTE: Auto Lane Change moves Model S one lane at a time. Moving into an additional lane requires you to engage the turn signal a second time after the first lane change is complete.

When using Auto Lane Change, it is important to monitor its performance by watching the driving path in front of you and the surrounding area. Stay prepared to take over steering at any time. As you are crossing over into the adjacent lane, the instrument panel displays the location in the lane that Model S is moving into.

In situations where Auto Lane Change is unable to operate at optimal performance, or cannot operate due to inadequate data, the instrument panel displays a series of warnings. Therefore, when using Auto Lane Change, always pay attention to the instrument panel and be prepared to manually steer Model S.

Adjacent Lane Speed

NOTE: Depending on market region, vehicle configuration, options purchased, and software version, your vehicle may not be equipped with Adjacent Lane Speed, or the feature may not operate exactly as described.

When moving significantly faster than vehicles in adjacent lanes, Model S automatically reduces the driving speed. This is especially helpful in heavy traffic situations or when vehicles are constantly merging into different lanes. When Model S detects other vehicles driving significantly slower, the instrument panel highlights the adjacent lanes with arrows and detected vehicles in gray, and Model S reduces the driving speed as appropriate. To temporarily override this feature, press the accelerator pedal.

 **WARNING:** Never depend on Autopilot to determine a safe driving speed; you are responsible for driving safely and according to traffic laws in your market region.

Stop Light and Stop Sign Warning

NOTE: Depending on market region, vehicle configuration, options purchased, and software version, your vehicle may not be equipped with Stop Light and Stop Sign Warning, or the feature may not operate exactly as described.

While Autosteer is in use, Model S displays a warning on the instrument panel and sounds a chime if it detects that you are likely to run through a red stop light or stop sign. If this happens, **TAKE IMMEDIATE CORRECTIVE ACTION!**

The visual and audible warnings cancel after a few seconds, or when you press the brake pedal, whichever comes first.

Stop Light and Stop Sign Warning provides warnings only. It does not slow down or stop Model S at red traffic lights, stop signs, road markings, etc. If equipped with Traffic Light and Stop Sign Control, you can enable this feature to automatically stop Model S at traffic lights and stop signs (see [Traffic Light and Stop Sign Control on page 96](#)).

 **CAUTION:** Stop Light and Stop Sign Warning requires on-board maps to know that a particular stop light or stop sign exists at a location. In some cases, map data is inaccurate or outdated and may not include all stop lights or stop signs. Therefore, Stop Light and Stop Sign Warning may not detect all stop lights and stop signs.

 **WARNING:** The Stop Light and Stop Sign Warning feature does not apply the brakes or decelerate Model S and may not detect all stop lights and stop signs. Stop Light and Stop Sign Warning is designed for guidance purposes only and is not a substitute for attentive driving and sound judgment. Keep your eyes on the road when driving and never depend on Stop Light and Stop Sign Warning to warn you of a stop light or stop sign.

 **WARNING:** Stop Light and Stop Sign Warning is designed to warn you only when approaching a visible red stop sign, solid red or later portion of a yellow traffic light. It may not warn you of intersections with flashing lights and it does not warn you of yield signs or temporary stop and yield signs (such as those used in construction areas). Additionally, Stop Light and Stop Sign Warning does not warn you of approaching stop lights or stop signs when you are pressing the accelerator pedal or brake pedal (which disables Autosteer).

Limitations

Autosteer and its associated functions are particularly unlikely to operate as intended when:

- Autosteer is unable to accurately determine lane markings. For example, lane markings are excessively worn, have visible previous markings, have been adjusted due to road construction, are changing quickly (lanes branching off, crossing over, or merging), objects or landscape features are casting strong shadows on the lane markings, or the road surface contains pavement seams or other high-contrast lines.
- Visibility is poor (heavy rain, snow, fog, etc.) or weather conditions are interfering with sensor operation.
- A camera(s) or sensor(s) is obstructed, covered, or damaged.



Autosteer

- Driving on hills.
- Approaching a toll booth.
- Driving on a road that has sharp curves or is excessively rough.
- Bright light (such as direct sunlight) is interfering with the view of the camera(s).
- The sensors (if equipped) are affected by other electrical equipment or devices that generate ultrasonic waves.
- A vehicle is detected in your blind spot when you engage the turn signal.
- Model S is being driven very close to a vehicle in front of it, which is blocking the view of the camera(s).

 **WARNING:** Many unforeseen circumstances can impair the operation of Autosteer. Always keep this in mind and remember that as a result, Autosteer may not steer Model S appropriately. Always drive attentively and be prepared to take immediate action.



NOTE: Depending on market region, vehicle configuration, options purchased, and software version, your vehicle may not be equipped with Navigate on Autopilot, or the feature may not operate exactly as described.

NOTE: Navigate on Autopilot is a BETA feature.

When using Autosteer on a controlled-access highway (a main highway on which road users enter and exit using on-ramps and off-ramps). Navigate on Autopilot guides Model S to off-ramps and interchanges based on your navigation route. Along the highway portion of a navigation route, Navigate on Autopilot also changes lanes to prepare for exits (route-based lane changes) and to minimize the driving time to your destination (speed-based lane changes).

⚠ WARNING: Navigate on Autopilot does not make driving autonomous. You must pay attention to the road, keep your hands on the steering yoke (or steering wheel) at all times, and remain aware of your navigation route.

⚠ WARNING: As is the case with normal driving, be extra careful around blind corners, interchanges, and on-ramps and off-ramps - obstacles can appear quickly and at any time.

⚠ WARNING: Navigate on Autopilot may not recognize or detect oncoming vehicles, stationary objects, and special-use lanes such as those used exclusively for bikes, carpools, emergency vehicles, etc. Remain alert at all times and be prepared to take immediate action. Failure to do so can cause damage, injury or death.

Enabling and Customizing Navigate on Autopilot

To enable Navigate on Autopilot, touch **Controls > Autopilot > Navigate on Autopilot (Beta)**. Then, to customize how you want Navigate on Autopilot to operate, touch **Customize Navigate on Autopilot**:

- **Enable At Start Of Every Trip:** Choose whether or not you want to automatically enable Navigate on Autopilot for every navigation route. When enabled, the Navigate on Autopilot button on the turn-by-turn direction list is already enabled at the start of every trip.
- **Speed Based Lane Changes:** Navigate on Autopilot is designed to perform both route-based and speed-based lane changes. Route-based lane changes are designed to keep you on your navigation route (for example, moving you into an adjacent lane to prepare for an upcoming off-ramp) whereas speed-based lane changes are designed to maintain a driving speed (not to exceed your cruising speed) that allows you to minimize the time it takes to reach your destination (for example, moving into an adjacent lane to pass a vehicle in front of you). Speed-based lanes changes are optional. You can use this setting to disable speed-based lane changes or to specify

how aggressively you want Navigate on Autopilot to change lanes to achieve the set cruising speed. The **Mild** setting is more conservative about lane changes and may result in a slightly longer driving time whereas **Mad Max** is designed to allow you to reach your destination in the shortest driving time possible, but changes lanes only when safe to do so.

- **Exit Passing Lane:** Choose whether you want Navigate on Autopilot to maneuver out of a passing lane when navigating to a destination.

NOTE: In addition to route-based and speed-based lane changes, Navigate on Autopilot requests a lane change out of a passing lane as a reminder to stay in a slower lane when you are not passing other vehicles. Choose **NO** to disable this and keep Model S in a passing lane except when needed to stay on the navigation route.

- **Require Lane Change Confirmation** (if equipped): By default, Navigate on Autopilot requires your confirmation before proceeding with a lane change by pressing the appropriate turn signal. However, if you want Navigate on Autopilot to change lanes without requiring this confirmation, turn this setting off. When you turn the setting off, you can specify if or how you want to be notified of lane changes (**Off, Chime, Vibrate, or Both**).

⚠ WARNING: If you turn off **Require Lane Change Confirmation**, Navigate on Autopilot notifies you of upcoming lane changes and off-ramps, but it remains your responsibility to monitor the environment and maintain control of Model S at all times. Lane changes can occur quickly and suddenly. Always keep your hands on the wheel and your eyes on the driving path in front of you.

NOTE: The touchscreen displays route-based lane changes at the top of the map's turn-by-turn direction list to notify you that an upcoming lane change is needed to stay on the navigation route.

Operating Navigate on Autopilot

Once enabled, the Navigate on Autopilot button appears on the map's turn-by-turn direction list whenever a navigation route is active and the route includes at least one controlled-access highway. When enabled, the Navigate on Autopilot button is blue and the turn-by-turn direction displays the Autosteer icon next to the maneuvers (such as off-ramps) that Navigate on Autopilot will handle.

NOTE: If **Enable At Start Of Every Trip** is turned off, you must touch the **Navigate on Autopilot** button to enable it for each navigation route.



Navigate on Autopilot

Navigate on Autopilot activates and deactivates as appropriate, based on the type of road you are driving on. For example, if Autosteer is active and Navigate on Autopilot is enabled, Navigate on Autopilot automatically becomes active when you reach a controlled-access highway on your navigation route.

Whenever Navigate on Autopilot is active, the instrument panel displays the driving lane as a single blue line in front of Model S:



When Navigate on Autopilot is active and you approach an off-ramp or interchange along your navigation route, the appropriate turn signal engages and Autosteer maneuvers Model S onto the off-ramp or interchange.

WARNING: Never depend on Navigate on Autopilot to determine an appropriate lane at an off-ramp. Stay alert and perform visual checks to ensure that the driving lane is safe and appropriate.

When you leave a controlled-access highway (for example, you take an exit or you enter a section of the navigation route that is no longer supported), Navigate on Autopilot reverts back to Autosteer—a chime sounds and the instrument panel displays the driving lane lines in blue (instead of the single blue in front of Model S).

NOTE: When determining navigation routes, and maneuvers at interchanges, Navigate on Autopilot considers whether or not you want to use High Occupancy Vehicle (HOV) lanes. Therefore, ensure the **Use HOV Lanes** setting is appropriate for your circumstances (see [Maps and Navigation on page 147](#)). If the setting is off, Navigate on Autopilot never uses a HOV lane, regardless of time of day. If the setting is on, Navigate on Autopilot uses HOV lanes, whenever applicable.

WARNING: When Navigate on Autopilot deactivates, Autosteer remains active. Always be prepared to take appropriate action.

WARNING: Navigate on Autopilot may not always attempt to exit at an off-ramp or change lanes, even when an exit or lane change is determined by the navigation route. Always remain alert and be prepared to manually steer onto an off-ramp, or make a lane change to prepare for, or to exit at, an off-ramp or interchange.

You can cancel Navigate on Autopilot at any time by touching **Navigate on Autopilot** on the map's turn-by-turn direction list (Model S reverts back to Autosteer), or by canceling Autosteer entirely (see [Canceling Autosteer on page 90](#)).

Lane Changes

Navigate on Autopilot changes lanes to either prepare Model S for an upcoming off-ramp, to increase your driving speed (not to exceed your set cruising speed), or to move Model S out of a passing lane when you are not actively passing other road users. A message displays at the top of the map's turn-by-turn direction list to notify you when an upcoming lane change is required to stay on your navigation route. The instrument panel displays the upcoming driving path:



If **Require Lane Change Confirmation** is turned **off**, Navigate on Autopilot engages the appropriate turn signal, checks for vehicles and objects, and when appropriate, maneuvers Model S into the adjacent lane.

If **Require Lane Change Confirmation** is turned **on**, you must engage the appropriate turn signal to confirm that you want Navigate on Autopilot to proceed with the lane change. If you do not confirm the lane change within three seconds, a chime sounds to remind you that Navigate on Autopilot requires your confirmation to change lanes.

NOTE: If you ignore a route-based lane change suggestion (for example, you are driving in the left lane while approaching an off-ramp on the right side of the highway), Navigate on Autopilot is unable to maneuver onto the off-ramp and as a result, you are re-routed to your destination.



⚠ WARNING: Navigate on Autopilot may not always attempt to exit at an off-ramp or change lanes, even when an exit or lane change is determined by the navigation route. Always remain alert and be prepared to manually steer onto an off-ramp, or make a lane change to prepare for, or to exit at, an off-ramp or interchange.

Be Ready to Assist

When attempting to change lanes or maneuver Model S, or when approaching construction zones, Navigate on Autopilot may be unable to determine the appropriate driving lane (for example, complex clover leafs and multi-lane off-ramps) and the instrument panel displays an alert indicating that Navigate on Autopilot is trying to maneuver and may require assistance. When you see the message, be prepared to take immediate action to ensure that it is safe and appropriate to complete the lane change or maneuver.



Traffic Light and Stop Sign Control

NOTE: Depending on market region, vehicle configuration, options purchased, and software version, your vehicle may not be equipped with Traffic Light and Stop Sign Control, or the feature may not operate exactly as described.

NOTE: Traffic Light and Stop Sign Control is a BETA feature and works best on roads that are frequently driven by Tesla vehicles. Traffic Light and Stop Sign Control attempts to stop at all traffic lights and may also stop at green lights.

Traffic Light and Stop Sign Control is designed to recognize and respond to traffic lights and stop signs, slowing Model S to a stop when using Traffic-Aware cruise control or Autosteer. This feature uses the vehicle's forward-facing cameras, in addition to GPS data, and slows the car for all detected traffic lights, including green, blinking yellow, and off lights in addition to stop signs and some road markings. As Model S approaches an intersection, the instrument panel displays a notification indicating the intention to slow down. You must confirm that you want to continue or Model S stops at the red line displayed on the instrument panel's driving visualization.

⚠ WARNING: NEVER make assumptions and predict when and where Traffic Light and Stop Sign Control will stop or continue through an intersection or road marking. From a driver's perspective, the behavior of Traffic Light and Stop Sign Control may appear inconsistent. Always pay attention to the roadway and be prepared to take immediate action. It is the driver's responsibility to determine whether to stop or continue through an intersection. Never depend on Traffic Light and Stop Sign Control to determine when it is safe and/or appropriate to stop or continue through an intersection.

Before Using

Before using Traffic Light and Stop Sign Control, you must:

- Ensure that forward-facing cameras are unobstructed (see [Cleaning Cameras and Sensors on page 83](#)) and calibrated (see [Drive to Calibrate Cameras on page 82](#)). Traffic Light and Stop Sign Control depends on the ability of the cameras to detect traffic lights, stop signs, and road markings.
- Ensure that the latest version of maps has been downloaded to Model S. Although Traffic Light and Stop Sign Control primarily uses visual data received from the vehicle's cameras, greater accuracy is achieved when using the most recent map data. To check which version of maps is currently downloaded, touch **Controls > Software > Additional vehicle information**. You must connect to a Wi-Fi network to receive updated maps (see [Map Updates on page 152](#)).

- Enable the feature. With the vehicle in Park, touch **Controls > Autopilot > Traffic Light and Stop Sign Control**. Once enabled, Traffic Light and Stop Sign Control operates whenever Traffic-Aware Cruise Control or Autosteer is active.

How it Works

When Traffic Light and Stop Sign Control is enabled and you are using Autosteer or Traffic-Aware Cruise Control, the instrument panel displays a popup message to inform you that an upcoming traffic light, stop sign, or road marking has been detected. As it approaches the stop location, **even at an intersection where the traffic light is green**, Model S slows down and displays a red line to indicate where Model S will stop. To continue through the intersection—even if the traffic light is green—you must briefly press the accelerator pedal to give the vehicle permission to proceed. When you've confirmed that you want to proceed, the red stop line turns gray and Model S continues through the intersection and resumes your set cruising speed.

NOTE: If Model S is approaching a green light and detects that a vehicle in front of you is continuing through the intersection, Model S continues through the intersection without requiring your confirmation, provided you are not in a turning lane and your hands are detected on the steering yoke (or steering wheel).

NOTE: If, after you briefly press the accelerator pedal to confirm that you want to continue through the intersection, the traffic signal changes before you enter the intersection (for example, the light changes from green to yellow or from yellow to red), Model S may determine that it is not appropriate to proceed. Therefore, Model S stops and you must press the accelerator to proceed. At all times, it is your responsibility to ensure the vehicle stops or accelerates appropriately and safely.

⚠ WARNING: Traffic Light and Stop Sign Control DOES NOT turn Model S through an intersection. When in a turning lane, Model S stops at the red stop line. To proceed, briefly press the accelerator pedal—Model S continues *straight* through the intersection (even when in a turning lane), so you MUST manually steer Model S through the intersection (which cancels Autosteer).

Traffic Light and Stop Sign Control is designed to operate as described only when the following conditions are met:

- Autosteer or Traffic-Aware Cruise Control is engaged.
- The cameras can detect an upcoming traffic light, stop sign or road marking (for example, cameras are unobstructed and have a clear line-of-sight to the traffic light, stop sign, or road marking).



- The instrument panel on Model S is displaying an upcoming traffic light in "bold" format. Model S does not acknowledge traffic lights that the instrument panel shows as faded. If a traffic light is not directly ahead of the camera (for example, it is located at an angle of the camera's view, or located in an adjacent lane) the instrument panel displays it as faded and Model S does not slow down and stop for it.



WARNING: Traffic Light and Stop Sign Control is not a substitute for attentive driving and sound judgment.



WARNING: If the instrument panel is not displaying a red stop line at an upcoming intersection, Model S does not slow down or stop. It is the driver's responsibility to pay attention to upcoming intersections and monitor traffic conditions to determine when and if the vehicle should stop and then to take appropriate action as needed.



WARNING: Never depend on Traffic Light and Stop Sign Control to determine whether to stop at, or proceed through, an intersection. Drive attentively by watching the road and paying attention to the roadway, upcoming intersections, traffic conditions, crosswalks, and other road users. It is always the driver's responsibility to determine whether to stop or proceed. Be prepared to take immediate action. Failure to do so can result in injury or death.



WARNING: In some situations, Traffic Light and Stop Sign Control may inaccurately detect a traffic light or stop sign, causing Model S to slow down unexpectedly. Be prepared to take immediate action at all times.



WARNING: You must briefly press the accelerator pedal to confirm that you want to proceed through an intersection, regardless of the status of the traffic light. If you do not confirm, Model S stops at the red stop line displayed on the instrument panel, even if stopping may be inappropriate. Stopping at a green light may confuse other drivers and may result in a collision, injury or death. Therefore, always pay attention to upcoming intersections and be prepared to manually brake or accelerate in response to surroundings.



WARNING: Never assume that your ability to see a traffic light, stop sign, or road marking (especially at a complex intersection, or an intersection in which a traffic light or sign is partially obstructed, etc.) means that Model S can also see it and respond appropriately.







WARNING: Even the most recent map data does not include all traffic lights and stop signs. Therefore, Traffic Light and Stop Sign Control relies heavily on the ability of the cameras to detect traffic lights, stop signs, road markings, etc. As a result, Model S may ignore an intersection that is blocked from the camera's view (for example, obstructed by a tree or a large vehicle or object, or located near a steep hill or sharp curve).





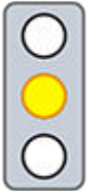
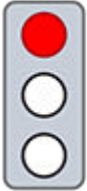

Traffic Light and Stop Sign Control

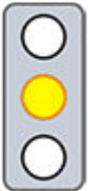
Traffic Lights

When driving with Autosteer or Traffic-Aware Cruise Control engaged, and Traffic Light and Stop Sign Control enabled, Model S is designed to respond as follows when approaching intersections controlled by a traffic light:

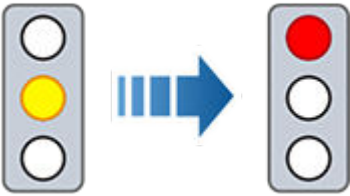
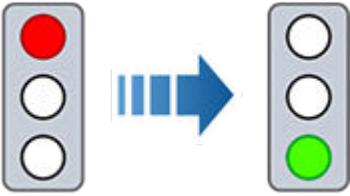
Type of Traffic Light	Vehicle Intended Response
 	<p>At a solid green traffic light, or at a traffic light that is currently off (not illuminated), Model S slows down.</p> <p>If you are following a car in front of you that continues through the intersection, the instrument panel displays a green stop line and provided your hands are detected on the steering yoke (or steering wheel), Model S also continues. If a car is not in front of you, the instrument panel displays a red stop line and you must confirm that you want to continue through the intersection by briefly pressing the accelerator pedal. If you don't confirm, Model S stops at the red stop line.</p> <p>NOTE: Model S resumes the set cruising speed when it continues through the intersection, taking into consideration the speed of a vehicle in front of you.</p>
 	<p>Model S slows down and comes to a complete stop at the red stop line displayed on the instrument panel. When you want to continue through the intersection (for example, the light turns green again, or once Model S has come to a complete stop), you must briefly press the accelerator pedal.</p>
  	<p>Model S slows down and comes to a complete stop at the red stop line displayed on the instrument panel. When you want to proceed through the intersection (for example, the light turns green again), you must briefly press the accelerator pedal.</p> <p>NOTE: If the traffic light changes <i>after</i> you've confirmed that you want to proceed (for example, a green traffic light turns yellow), Model S may stop instead of continuing, especially if Model S determines that it can safely stop before entering the intersection.</p> <p>NOTE: Model S is not designed to proceed through an intersection when the traffic light is red or if the light turns yellow in situations when there is adequate distance to safely stop before entering the intersection.</p> <p>NOTE: You can take over driving at any time by manually braking to cancel Autosteer or Traffic-aware Cruise Control.</p>

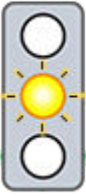



Type of Traffic Light	Vehicle Intended Response
 	
 	<p>Model S slows down. To proceed, you must briefly press the accelerator pedal. If you don't, Model S stops at the red stop line displayed on the instrument panel.</p> <p>NOTE: To prevent Model S from stopping, and to minimize how much it slows down as it approaches, you can confirm that you want to proceed by briefly pressing the accelerator pedal at any time after the instrument panel displays the red stop line. Model S resumes your set cruising speed immediately after you confirm (taking into consideration the speed of a vehicle in front of you).</p> <p>⚠ WARNING: Approach attentively and be prepared to press the brake pedal to slow down or stop.</p>
	<p>Model S slows down and comes to a complete stop at the red stop line displayed on the instrument panel. When you want to proceed through the intersection (for example, traffic laws and conditions indicate it is safe and legal to proceed), you must briefly press the accelerator pedal.</p>



Traffic Light and Stop Sign Control

Stop Signs and Road Markings

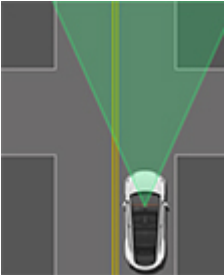
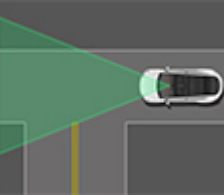
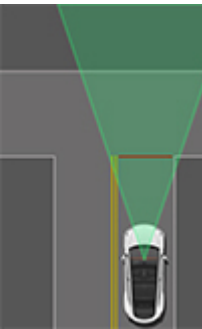
When driving with Autosteer or Traffic-aware Cruise Control engaged, and Traffic Light and Stop Sign Control enabled, Model S is designed to respond as follows when approaching intersections controlled by stop signs, stop lines, or road markings:

Type of Intersection	Vehicle Intended Response
 <p data-bbox="168 747 381 779">No Traffic Control</p>  <p data-bbox="168 1031 381 1062">Arm of T-junction</p>	<p data-bbox="459 443 1435 501">Model S assumes the right of way and continues straight without slowing down or stopping.</p>
 <p data-bbox="172 1461 378 1493">End of T-junction</p>	<p data-bbox="459 1104 1419 1190">If Model S detects a T-junction based on the map data, Model S slows down and comes to a complete stop at the red stop line displayed on the instrument panel. When you want to proceed, you must take over steering and acceleration.</p> <p data-bbox="459 1205 1471 1291">⚠ WARNING: Model S may not stop at a T-junction that does not have a stop sign or stop line, or if the T-junction is not included in the map data. Drive attentively and be prepared to stop (when necessary and/or appropriate).</p>
 <p data-bbox="217 1892 332 1923">Stop Sign</p>	<p data-bbox="459 1535 1463 1621">Model S slows down and comes to a complete stop at the red stop line displayed on the instrument panel. When you want to proceed through the intersection, you must briefly press the accelerator pedal.</p> <p data-bbox="459 1635 1471 1749">NOTE: If you confirm that you want to proceed through an intersection controlled by a stop sign by briefly pressing the accelerator pedal before Model S has stopped, your confirmation is ignored. Model S is not designed to proceed through a stop sign without stopping.</p> <p data-bbox="459 1764 1446 1850">NOTE: Even when using Autosteer, and even if you have engaged a turn signal, you must turn the steering yoke (or steering wheel) yourself (which cancels Autosteer) to complete a turn at an intersection.</p>

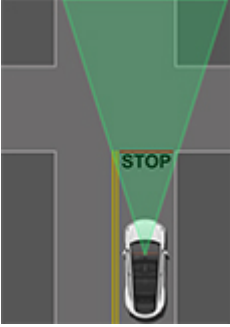

Type of Intersection	Vehicle Intended Response
 <p data-bbox="152 569 490 596">Stop Sign and Road Marking</p>	
 <p data-bbox="240 978 402 1005">Road Marking</p>	

- ⚠ WARNING:** Model S also slows down and stops at a roundabout. You must take over steering (which cancels Autosteer) and briefly press the accelerator pedal to confirm that you want to continue through the roundabout.
- ⚠ WARNING:** At crosswalks, Model S may slow down and may stop, depending on whether the crosswalk is controlled by a traffic light and whether the cameras detect pedestrians, bicyclists, etc. in the crosswalk. Pay particular attention at crosswalks and be prepared to take over at any time. Failure to do so can result in injury or death.

Limitations

Depending on many different circumstances and environmental conditions, Traffic Light and Stop Sign Control *may* or *may not* stop at:

- Railroad crossings.
- Keep-out zones.
- Toll booths.
- Crosswalk systems.
- Yield signs or temporary traffic lights and stop signs (such as at construction areas).
- Miscellaneous traffic U-turn lights, bicycle and pedestrian crossing lights, lane availability lights, etc.

In addition, Traffic Light and Stop Sign Control is particularly unlikely to operate as intended, can disengage, or may not operate, when one or more of the following conditions are present:

- Driving through consecutive light-controlled intersections that are very close to each other.
- Visibility is poor (heavy rain, snow, fog, etc.) or weather conditions are interfering with camera or sensor operation.



Traffic Light and Stop Sign Control

- Bright light (such as direct sunlight) is interfering with the view of the camera(s).
- A camera is obstructed, covered, damaged, or not properly calibrated.
- Driving on a hill or on a road that has sharp curves on which the cameras are unable to see upcoming traffic lights or stop signs.
- A traffic light, stop sign, or road marking is obstructed (for example, a tree, a large vehicle, etc.).
- Model S is being driven very close to a vehicle in front of it, which is blocking the view of a camera.

 **WARNING:** The limitations listed above are not an exhaustive list of reasons why Model S may not operate as expected. Many unforeseen circumstances can adversely impact the accurate operation of Traffic Light and Stop Sign Control. Using this feature does not reduce or eliminate the need to drive attentively and responsibly. You must be prepared to take appropriate and immediate action at all times.

NOTE: Depending on market region, vehicle configuration, options purchased, and software version, your vehicle may not be equipped with Autopark.

Autopark uses data to simplify parking on public roads by maneuvering Model S into parallel and perpendicular parking spaces.

 **CAUTION:** Ensure all cameras and sensors (if equipped) are clean. Dirty cameras and sensors, as well as environmental conditions such as rain and faded lane markings, can affect Autopilot performance.

 **WARNING:** Autopark's performance depends on the ability of the cameras and sensors (if equipped) to determine the vehicle's proximity to curbs, objects, and other vehicles.

 **WARNING:** Do not use Autopark if anything, such as a ball hitch, bike rack, or trailer, is attached to the tow hitch. Autopark may not stop for hitches when parking between or in front of other vehicles.

Parameters

Autopark detects potential parking spaces based on the following parameters:

Perpendicular Parking

- Your driving speed must be below 8 mph (13 km/h). If driving too fast, Autopark may not be able to accurately detect your desired parking space.
- The parking space must be at least 7.2 feet (2.2 meters) wide.
- The parking space must have at least three visible lines for the vehicle to park into, such as parking lines, road markings, or distinct curbs. Autopark may not work in a garage, for example, without three visible parking lines.
- Autopark may not work with textured road surfaces such as cobblestone or brick.

Parallel Parking

- Your driving speed must be below 13 mph (21 km/h). If driving too fast, Autopark may not be able to accurately detect your desired parking space.
- There must be a vehicle in front of the space you want to park in.
- A distinct curb or edge must be visible. Autopark may not correctly identify the parking space if the curb is not distinct, such as grass or dirt.

NOTE: Autopark does not operate on angled parking spaces.

To Use Autopark

When driving, follow these steps to allow Autopark to maneuver Model S into a parking space:

1. While driving slowly on a public road, monitor the instrument panel to determine when Autopark has detected a parking space. The instrument panel will display a parking icon if the vehicle detects a potential parking spot.

NOTE: The parking icon appears only if the vehicle's position and/or the circumstances of the surrounding area are such that Autopark can determine an appropriate driving path. If Autopark cannot determine an appropriate path (for example, when driving on a narrow street where moving into the parking space causes the front of the vehicle to extend into the adjacent lane), you can either reposition the vehicle, find a different parking space, or park manually.

2. Check to determine if the detected parking space is appropriate and safe. Pull forward and stop approximately one car length ahead of the parking space (as you normally would when parallel parking or when backing into a perpendicular parking space).
3. Release the steering yoke (or steering wheel), then touch and hold **Autopark** in the drive mode strip on the touchscreen. You can release the button once Autopark engages.
4. Autopark displays a message when parking is complete.

NOTE: If you press the brake pedal when Autopark is actively parking Model S, the parking process pauses until you touch **Resume** on the touchscreen.

 **WARNING:** Never depend on Autopark to find a parking space that is legal, suitable, and safe. Autopark may not always detect objects in the parking space. Always perform visual checks to confirm that a parking space is appropriate and safe.

 **WARNING:** When Autopark is actively steering Model S, the steering yoke (or steering wheel) moves in accordance with Autopark's adjustments. Do not interfere with the movement of the steering yoke (or steering wheel). Doing so cancels Autopark.

 **WARNING:** During the parking sequence, continually check your surroundings. Be prepared to apply the brakes to avoid vehicles, pedestrians, or objects.

 **WARNING:** When Autopark is active, monitor the touchscreen and instrument panel to ensure that you are aware of the instructions that Autopark is providing.

To Pause Parking

To pause Autopark, press the brake pedal once. Model S stops and remains stopped until you touch **Resume** on the touchscreen.

To Cancel Parking

Autopark cancels the parking sequence when you manually move the steering yoke (or steering wheel), shift, or touch **Cancel** on the touchscreen. Autopark also cancels parking when:

- The parking sequence exceeds seven moves.
- Model S detects that the driver is exiting the vehicle.
- A door is opened.
- You press the accelerator pedal.
- You press the brake pedal while Autopark is paused.
- An Automatic Emergency Braking event occurs (see [Collision Avoidance Assist on page 114](#)).

Limitations

Autopark is particularly unlikely to operate as intended in these situations:

- The road is sloped. Autopark is designed to operate on flat roads only.
- Visibility is poor (due to heavy rain, snow, fog, etc.).
- The curb is constructed of material other than stone, or the curb cannot be detected.
- The target parking space is directly adjacent to a wall or pillar (for example, the last parking space of a row in an underground parking structure).
- One or more of the sensors (if equipped) or cameras is damaged, dirty, or obstructed (such as by mud, ice, or snow, or by a vehicle bra, excessive paint, or adhesive products such as wraps, stickers, rubber coating, etc.).
- Weather conditions (heavy rain, snow, fog, or extremely hot or cold temperatures) are interfering with sensor (if equipped) operation.
- The sensors (if equipped) are affected by other electrical equipment or devices that generate ultrasonic waves.

 **WARNING:** Many unforeseen circumstances can impair Autopark's ability to park Model S. Keep this in mind and remember that as a result, Autopark may not steer Model S appropriately. Pay attention when parking Model S and stay prepared to immediately take control.

NOTE: Depending on market region, vehicle configuration, options purchased, and software version, your vehicle may not be equipped with Summon, or the feature may not operate exactly as described.

Summon allows you to automatically park and retrieve Model S while you are standing outside the vehicle. Summon moves Model S forward and reverse up to 39 feet (12 meters) in, or out of, a parking space.

To move Model S a longer distance while steering around objects, you can use Smart Summon (if equipped) and your mobile phone. Smart Summon allows your vehicle to find you (or you can send your vehicle to a chosen location). See [Smart Summon on page 108](#).

 **CAUTION:** Ensure all cameras and sensors (if equipped) are clean. Dirty cameras and sensors, as well as environmental conditions such as rain and faded lane markings, can affect Autopilot performance.

 **WARNING:** Summon is designed and intended for use only on parking lots and driveways on private property where the surrounding area is familiar and predictable.

 **WARNING:** Summon is a BETA feature. You must continually monitor the vehicle and its surroundings and stay prepared to take immediate action at any time. It is the driver's responsibility to use Summon safely, responsibly, and as intended.

 **WARNING:** Summon's performance depends on the ability of the cameras and sensors (if equipped) to determine the vehicle's proximity to objects, people, animals, and other vehicles.

Before Using Summon

Before operating Summon, use the touchscreen to enable it and customize how you want it to work. Touch **Controls > Autopilot > Customize Summon** and adjust the following settings to suit your preferences:

- **Bumper Clearance:** Set the distance that you want Summon to stop from a detected object (for example, you may want Summon to stop within just a few inches of a garage wall). Note that this distance applies only to objects that Summon detects directly in front of Model S when moving forward, or directly behind Model S when reversing.
- **Summon Distance:** Set a maximum distance that Model S can travel when entering or exiting a parking space.
- **Side Clearance:** Choose an option to specify how much side clearance you want to allow. **Tight** allows Model S to enter and exit very narrow parking spaces.

 **WARNING:** Parking in a narrow space limits the ability of the cameras and sensors (if equipped) to accurately detect the location of obstacles, increasing the risk of damage to Model S and/or surrounding objects.

- **Require Continuous Press:** By default, Summon requires that you press and hold a button on the mobile app to move Model S during the parking process. When **Require Continuous Press** is set to **No**, you can press and release the button—you don't need to hold it down to keep the vehicle moving. Also, when **Require Continuous Press** is set to **No**, you can operate Summon using the key fob instead of the mobile app (see [Operating Summon with the Key Fob on page 106](#)) and you can start a parking sequence from inside the vehicle (see [Starting Summon Before Exiting the Vehicle on page 106](#)).

- **Use Auto HomeLink** (if equipped): Set to **ON** if you want to activate HomeLink to open/close a programmed HomeLink device (such as a gate or a garage door) during the parking process when using Summon. If enabled, the device automatically opens and closes when Model S enters or exits during a Summon session. In a Smart Summon session (if equipped), the device automatically opens when, at the beginning of a session, Smart Summon detects that Model S is parked in a garage.

 **WARNING:** Always ensure that Model S is fully in or out of a garage before HomeLink lowers the garage door. Summon and Smart Summon (if equipped) cannot detect where an overhead door will lower.

NOTE: When enabled, the HomeLink device automatically opens and closes when using Summon, and automatically opens as needed when using Smart Summon (if equipped). To automate HomeLink in other situations (such as normal driving), you must adjust the HomeLink device's main settings by touching the HomeLink icon at the top of the **Controls** screen (see [Smart Garage Connectivity on page 139](#)).

NOTE: The above settings, with the exception of HomeLink, apply only to Summon—not Smart Summon (if equipped) (see [Before Using Smart Summon on page 108](#)). You cannot customize Smart Summon's bumper clearance, distance, and side clearance. And when using Smart Summon, you must always hold down the button on the mobile app to keep Model S moving. Also, Smart Summon operates with the mobile app only—not the key fob.

NOTE: All settings are retained until you manually change them.

Using Summon to Park and Retrieve your Vehicle

Follow these steps to use Summon to park your Model S:

- Align Model S within 39 feet (12 meters) of the parking space so Model S can follow a straight path into or out of the space in either Drive or Reverse.
- From outside the vehicle, initiate the parking maneuver by touching **Summon** on the mobile app, then holding down the **Forward** or **Reverse** button.

NOTE: If the **Require Continuous Press** setting is **No**, you do not need to hold down the button, just press and release.

NOTE: You can also initiate the parking maneuver from inside the vehicle (see [Starting Summon Before Exiting the Vehicle on page 106](#)).

Summon shifts Model S into Drive or Reverse (based on the direction you specified) and drives into or out of the parking space. When parking is complete, or if an obstacle is detected, Summon shifts Model S into Park. Summon shifts Model S into Park when:

- Model S detects an obstacle in its driving path (within the **Bumper Clearance** setting that you specified).
- Summon has moved Model S the maximum distance of 39 feet (12 meters).
- You release the **Forward** or **Reverse** button (when Require Continuous Press is turned on).
- You press any button to manually stop Summon.

If you used Summon to park Model S, you can then use Summon to return Model S back to its original position (provided Model S has remained in Park), or to the maximum **Summon Distance** that you have specified (whichever comes first). Simply specify the opposite direction on the mobile app and Summon moves Model S along the original path, provided no obstructions have been introduced. If an obstacle is detected, Model S attempts to avoid the obstacle while staying very close to its original path (Summon does not steer around obstacles).

NOTE: To use Summon to move Model S multiple times in the same direction (not to exceed the maximum of 39 feet (12 meters), cancel Summon and then restart the parking process using the same direction.

NOTE: Although Summon can move Model S a short distance laterally to avoid an obstacle, it does not attempt to steer around an obstacle to return Model S to its original driving path. Only Smart Summon (if equipped) can steer Model S around objects.

NOTE: Summon requires that Model S can detect a valid key nearby.

 **WARNING:** Model S cannot detect obstacles that are located lower than the bumper, are very narrow, or are hanging from a ceiling (for example, bicycles). In addition, many unforeseen circumstances can impair Summon's ability to move in or out of a parking space and, as a result, Summon may not move Model S appropriately. Therefore, you must continually monitor the vehicle's movement and its surroundings and remain prepared to stop Model S at any time.

Operating Summon with the Key Fob

NOTE: Summon may not operate if the battery is low on the key fob.

Follow these steps to park Model S from outside the vehicle using the key fob:

1. On the touchscreen, ensure that **Require Continuous Press** is disabled (touch **Controls** > **Autopilot** > **Customize Summon** > **Require Continuous Press**).
2. With Model S in Park, stand within 10 feet (three meters) and press and hold the top center button on the key fob (Lock/Unlock All button) until the hazard lights blink continuously.

NOTE: The hazard lights flash once as Model S locks, then within five seconds, Model S powers on and the hazard lights flash continuously. Do not proceed to the next step until the hazard lights are flashing. If, after five seconds, the hazard lights are not flashing, release the button on the key fob, move closer to Model S, and try again. If Summon receives no further input within ten seconds, Summon cancels.

3. Press the Front Trunk button on the key fob to move Model S forward into the parking space, or press the Rear Trunk button to reverse Model S into the parking space.

Starting Summon Before Exiting the Vehicle

To start a Summon parking sequence before exiting Model S:

1. On the touchscreen, ensure that **Require Continuous Press** is disabled (touch **Controls** > **Autopilot** > **Customize Summon** > **Require Continuous Press**).
2. Close all doors and trunks.
3. With Model S powered on and Park engaged, double press the scroll button on the right side of the steering yoke (or steering wheel).. The touchscreen displays a popup screen.
4. On the touchscreen, choose the direction of travel.
5. Exit Model S and close the driver's door.

Summon now moves Model S according to the direction you specified on the touchscreen.

NOTE: To cancel the parking maneuver before exiting the vehicle, touch **Cancel** on the popup screen.

NOTE: If you do not choose a direction of travel on the touchscreen, Summon does not start a parking maneuver when you exit.

Stopping or Canceling Summon

Stop Model S at any time while Summon is active by using the mobile app or by pressing any button on the key fob. Summon also cancels when:

- A door handle is engaged or a door is opened.
- You interact with the steering yoke (or steering wheel), brake pedal, accelerator pedal, or shift.
- Model S detects an obstacle.
- Summon has moved Model S the maximum distance of approximately 39 feet (12 meters).
- Your phone enters sleep mode or loses connectivity to Model S.

Limitations

Summon is unlikely to operate as intended in the following types of situations:

- The driving path is sloped. Summon is designed to operate on flat roads only (up to 10% grade).
- A raised concrete edge is detected. Summon does not move Model S over an edge that is higher than approximately 1 in (2.5 cm).
- One or more of the sensors (if equipped) or cameras is damaged, dirty, or obstructed (such as by mud, ice, or snow, or by a vehicle bra, excessive paint, or adhesive products such as wraps, stickers, rubber coating, etc.).
- Weather conditions (heavy rain, snow, fog, or extremely hot or cold temperatures) are interfering with sensor operation.
- The sensors (if equipped) are affected by other electrical equipment or devices that generate ultrasonic waves.

NOTE: Summon is disabled if Model S is in Valet mode (see [Valet Mode on page 48](#)).





WARNING: The list above does not represent an exhaustive list of situations that may interfere with proper operation of Summon. It is the driver's responsibility to remain in control of Model S at all times. Pay close attention whenever Summon is actively moving Model S and stay prepared to take immediate action. Failure to do so can result in serious property damage, injury or death.

NOTE: Depending on market region, vehicle configuration, options purchased, and software version, your vehicle may not be equipped with Smart Summon, or the feature may not operate exactly as described.

Smart Summon is designed to allow you to move Model S to your location (using your phone's GPS as a target destination) or to a location of your choice, maneuvering around and stopping for objects as necessary. Smart Summon works with the Tesla mobile app when your phone is located within approximately 213 feet (65 meters) of Model S. Smart Summon maneuvers Model S out of parking spaces and around corners. This is useful for moving Model S out of a tight parking spot, through puddles, or helping you retrieve your car while carrying packages. You must maintain a clear line of sight between you and Model S and closely monitor the vehicle and its surroundings at all times.

 **CAUTION:** Ensure all cameras and sensors (if equipped) are clean. Dirty cameras and sensors, as well as environmental conditions such as rain and faded lane markings, can affect Autopilot performance.

 **WARNING:** Smart Summon is designed and intended for use only on parking lots and driveways located on private property where the surrounding area is familiar and predictable. Do not use Smart Summon on public roads.

 **WARNING:** Smart Summon must only be used on paved surfaces.

 **WARNING:** Smart Summon is a BETA feature. You must continually monitor the vehicle and its surroundings and stay prepared to take immediate action at any time. It is the driver's responsibility to use Smart Summon safely, responsibly, and as intended.

 **WARNING:** Smart Summon may not stop for all objects (especially very low objects such as some curbs, or very high objects such as a shelf) and may not react to all traffic. Smart Summon does not recognize the direction of traffic, does not navigate around empty parking spaces, and may not anticipate crossing traffic.

 **WARNING:** Smart Summon's performance depends on the sensors (if equipped), the visibility of the cameras, and the availability of an adequate cellular signal and GPS data.

 **WARNING:** When using Smart Summon, you must maintain a clear line of sight between you and Model S and stay prepared to stop the vehicle at any time by releasing the button on the mobile app.

Before Using Smart Summon

- Download the latest version of the Tesla mobile app to your phone, and ensure your phone has cellular service and GPS enabled.

- Your phone must be connected to Model S and located within approximately 213 feet (65 meters).
- The vehicle's cameras must be fully calibrated (see [Drive to Calibrate Cameras on page 82](#)).
- You must have a clear line of sight to Model S.
- Model S must be in Park, not charging, and all doors and trunks must be closed.

Using Smart Summon

1. Open the Tesla mobile app, and press **Summon**.
2. Press the **Smart Summon** icon located in the center of the image of your Model S. It may take several seconds for Smart Summon to start up.

NOTE: You can use Standby Mode to eliminate the delay that occurs when Smart Summon is starting up (see [Standby Mode on page 109](#)).

The mobile app displays a map with a blue circle, which represents the maximum proximity of 213 feet (65 meters) that you must maintain between your phone and Model S. The blue dot on the map represents your location, and the red arrow represents the location of Model S.

3. Position yourself anywhere within the blue circle where you have a clear line of sight to Model S.
4. You can now operate Smart Summon using either of these modes:
 - **Come to Me** mode: Press and hold the **Come to Me** button. Model S moves to your GPS location. As you move, Model S follows you. When Model S reaches you, it stops and shifts into park.
 - **Go to Target** mode: Touch the crosshair icon then drag the map to position the pin on a chosen destination. Press and hold the **Go to Target** button. Model S moves to the destination. When reaching the location, Model S stops and shifts into Park and the mobile app displays a message indicating that Summon has completed.

NOTE: To subsequently change the location, lift your finger, reposition the map, then press and hold **Go to Target** again.

To stop Model S at any time, simply release the **Come to Me** or **Go to Target** button.



The map's crosshair icon toggles between **Go to Target** and **Come to Me** modes. When **Come to Me** mode is selected, the icon is blue.

NOTE: The map also has an icon that allows you to display/hide satellite imagery.



Immediately after initiating Smart Summon in either mode, hazard lights briefly flash, mirrors fold, and Model S shifts into Drive or Reverse. Model S then slowly moves to within 3 feet (1 meter) of you (COME TO ME) or your chosen destination (GO TO TARGET), navigating obstacles as needed. As Model S moves, the corresponding red arrow on the map also moves to show the vehicle's location. As you move, the corresponding blue dot also moves to show your location.



In either mode, Model S stops moving and shifts into park when:

- You release the button on the mobile app.
- The maximum proximity of 213 feet (65 meters) between your phone and Model S is exceeded (if moving Model S to a destination away from you, you may need to follow the car to maintain this distance).
- The driving path is blocked.
- Model S has moved the maximum distance of 475 feet (145 meters) since the start of the Smart Summon session, or has moved 492 feet (150 meters) away from the location from which the vehicle was last driven manually.

NOTE: If Smart Summon moves Model S forward three feet and then backwards two feet, this is considered five feet of travel.

NOTE: There is no need to look at the mobile app—just hold down the button while keeping your eye on Model S and its driving path at all times, remaining ready to release the button to stop the vehicle if needed.

If equipped and Auto HomeLink is enabled for Summon (touch **Controls** > **Autopilot** > **Customize Summon** > **Use Auto HomeLink**), Smart Summon automatically opens a HomeLink device if you start the Smart Summon maneuver when Model S is located inside a garage. The mobile app informs you that the door has opened.

-  **WARNING:** When you release the button to stop Model S, a slight delay occurs before the vehicle stops. Therefore, it is critical that you pay close attention to the vehicle's driving path at all times and proactively anticipate obstacles that the vehicle may be unable to detect.
-  **WARNING:** Use extreme caution when using Smart Summon in environments where movement of obstacles can be unpredictable. For example, where people, children or animals are present.
-  **WARNING:** Smart Summon may not stop for all objects (especially very low objects such as some curbs, or very high objects such as a shelf) and may not react to all oncoming or side traffic. Pay attention and be ready to stop Model S at all times by releasing the button on the mobile app.

Standby Mode

To keep Model S ready to Summon and reduce the time it takes to warm up, turn on Standby Mode. Touch **Controls** > **Autopilot** > **Standby Mode**. When Standby Mode is turned on, you can conserve Battery energy by disabling Standby Mode at these locations:

- **Exclude Home** - Disables Standby Mode at the location you set as Home in your Favorites list.
- **Exclude Work** - Disables Standby Mode at the location you set as Work in your Favorites list.
- **Exclude Favorites** - Disables Standby Mode at any location in your Favorites list.

NOTE: To conserve energy, Smart Summon automatically exits Standby mode from midnight to 6:00 am. During these hours, a delay occurs as Smart Summon starts up.

NOTE: Additional battery power may be consumed while Standby Mode is active.

NOTE: For details on how to designate a location as Home, Work, or Favorites, see [Home, Work, and Favorite Destinations](#) on page 149.

Stopping or Canceling Smart Summon

Smart Summon stops Model S whenever you release the button on the mobile app. To resume the Smart Summon session, simply press the **Come to Me** or **Go to Target** button again.

 **WARNING:** Always anticipate when you need to stop Model S. Depending on the quality of the connectivity between the phone and Model S, there may be a slight delay between when you release the button and when the car stops.

Smart Summon cancels, and requires you to restart it, when:

- You press any button on the key fob.
- A door handle is engaged or a door is opened.
- You interact with the steering yoke (or steering wheel), brake pedal, accelerator pedal, or shift.
- Model S is blocked by an obstacle.
- Smart Summon has moved Model S the maximum distance of approximately 475 feet (145 meters) within a 213 foot (65 meter) radius of the phone's location. To move further than this distance, you must shift Model S into Drive or Reverse and then re-initiate an Smart Summon session.
- Your phone enters sleep mode or loses connectivity to Model S.

Limitations

Smart Summon is unlikely to operate as intended in the following types of situations:

- GPS data is unavailable due to poor cellular coverage.
- The driving path is sloped. Smart Summon is designed to operate on flat roads only (up to 10% grade).
- A raised concrete edge is detected. Depending on the height of the concrete edge, Smart Summon may not move Model S over it.
- One or more of the sensors (if equipped) or cameras is damaged, dirty, or obstructed (such as by mud, ice, or snow, or by a vehicle bra, excessive paint, or adhesive products such as wraps, stickers, rubber coating, etc.).
- Weather conditions (heavy rain, snow, fog, or extremely hot or cold temperatures) are interfering with sensor (if equipped) or camera operation.
- The sensors (if equipped) are affected by other electrical equipment or devices that generate ultrasonic waves.

NOTE: Smart Summon is disabled if Model S is in Valet mode (see [Valet Mode on page 48](#)).

 **WARNING:** The list above does not represent an exhaustive list of situations that may interfere with proper operation of Smart Summon. It is the driver's responsibility to remain in control of Model S at all times. Pay close attention whenever Smart Summon is actively moving Model S and stay prepared to take immediate action. Failure to do so can result in serious property damage, injury or death.

Model S monitors the markers on the lane you are driving in as well as the surrounding areas for the presence of vehicles or other objects.

When an object is detected in your blind spot or near the side of Model S (such as a vehicle, guard rail, etc.), the instrument panel displays colored lines radiating from the image of your vehicle. The location of the lines correspond to the location of the detected object. The color of the lines (white, yellow, orange, or red) represent the object's proximity to Model S, with white being the farthest and red being the closest and requiring your immediate attention. These colored lines only display when driving between approximately 7 and 85 mph (12 and 140 km/h). When Autosteer is active, these colored lines also display if driving slower than 7 mph (12 km/h). However, the colored lines do not display if Model S is at a standstill (for example, in heavy traffic).

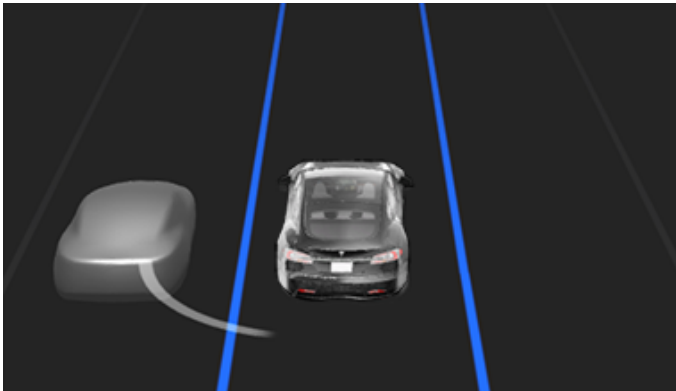

CAUTION: Ensure all cameras and sensors (if equipped) are clean. Dirty cameras and sensors, as well as environmental conditions such as rain and faded lane markings, can affect Autopilot performance.

WARNING: Lane Assist features are for guidance purposes only and is not intended to replace your own direct visual checks. Before changing lanes, always use side mirrors and perform the appropriate shoulder checks to visually determine if it is safe and appropriate to change lanes.

WARNING: Never depend on Lane Assist to inform you if you unintentionally drive outside of the driving lane, or to inform you that there is a vehicle beside you or in your blind spot. Several external factors can reduce the performance of Lane Assist (see [Limitations and Inaccuracies on page 112](#)). It is the driver's responsibility to stay alert and pay attention to the driving lane and other road users. Failure to do so can result in serious injury or death.

Steering Interventions

Lane Assist provides steering interventions if Model S drifts into (or close to) an adjacent lane in which an object, such as a vehicle, is detected. In these situations, Model S automatically steers to a safer position in the driving lane. This steering is applied only when Model S

is traveling between 30 and 85 mph (48 and 140 km/h) on major roads with clearly visible lane markings. When a steering intervention is applied, the instrument panel briefly displays a warning message.

Lane Departure Avoidance

Lane Departure Avoidance is designed to warn you if Model S is drifting out of, or nears the edge of, your driving lane.

Lane Departure Avoidance operates when driving between 40 and 90 mph (64 and 145 km/h) on roads with clearly visible lane markings. You can choose if and how you want Lane Departure Warning to operate by touching **Controls > Autopilot > Lane Departure Avoidance** and selecting between these options:

- **Off:** You are not warned of lane departures or potential collisions with a vehicle in an adjacent lane.
- **Warning:** If a front wheel passes over a lane marking, the steering yoke (or steering wheel) vibrates.
- **Assist:** Corrective steering is applied to keep Model S in a safe position if Model S drifts into an adjacent lane or near the edge of the road.

When Lane Departure Avoidance is enabled and Traffic-Aware Cruise Control is active, if Model S drifts out of the driving lane when the associated turn signal is off, Lane Assist also checks to see whether your hands are on the steering yoke (or steering wheel). If hands are not detected, the instrument panel displays a series of alerts, similar to those that are used when driving with Autosteer. If hands are repeatedly not detected Model S gradually slows down to 15 mph (25 km/h) below the detected speed limit, or below the set cruising speed, and the hazard lights start flashing.

NOTE: Lane Departure Avoidance does not warn you of lane departures, or provide steering interventions, if the associated turn signal is on, which indicates an intentional lane change.

WARNING: Lane Departure Avoidance is intended to help keep you safe, but it does not work in every situation and does not replace the need to remain attentive and in control.

WARNING: Keep your hands on the steering yoke (or steering wheel) and drive attentively at all times.

WARNING: Steering interventions are minimal and are not designed to move Model S out of its driving lane. Do not rely on steering interventions to avoid side collisions.



Emergency Lane Departure Avoidance

Emergency Lane Departure Avoidance automatically applies steering to avoid a potential collision in situations where:

- Model S is departing a lane and may collide with a vehicle traveling in the same direction in the adjacent lane (regardless of the status of the turn signal).
- Model S is departing a lane into an oncoming lane, the turn signal is off, and an oncoming vehicle is detected.
- Model S is departing the road and the turn signal is off (for example, very close to the edge of the road and a collision may occur).

To turn this feature on or off, touch **Controls > Autopilot > Emergency Lane Departure Avoidance**.

When Emergency Lane Departure Avoidance applies steering, a chime sounds and the instrument panel displays a warning and highlights the lane marking in red.

Emergency Lane Departure Avoidance operates when Model S is traveling between 64 and 145 km/h (40 and 90 mph) on a road with clearly visible lane markings, curbs, etc.

WARNING: Emergency Lane Departure Avoidance is not a substitute for attentive driving and sound judgment. Keep your eyes on the road when driving and never depend on Emergency Lane Departure Avoidance to prevent a collision. Several factors can reduce or impair performance. Depending on Emergency Lane Departure Avoidance to prevent a potential collision can result in serious injury or death.

Automatic Blind Spot Camera

To display the image from the corresponding side repeater camera whenever you engage a turn signal to change lanes, touch **Controls > Autopilot > Automatic Blind Spot Camera**.

When the turn signal is engaged and the touchscreen is displaying the image from the side repeater camera, you can move the image to a different location on the touchscreen. To do so, touch and drag the image to the new location (valid locations are indicated by shaded areas that display when you touch and hold the image).

WARNING: Automatic Blind Spot Camera does not eliminate the need to drive attentively and manually perform shoulder checks when changing lanes.

Blind Spot Collision Warning Chime

If you want a chime to sound when a vehicle is in your blind spot and a possible collision is detected, touch **Controls > Autopilot > Blind Spot Collision Warning Chime**.

WARNING: Blind Spot Camera does not eliminate the need to drive attentively and manually perform shoulder checks when changing lanes.

WARNING: Blind Spot Collision Warning Chime cannot detect every collision. It is the driver's responsibility to remain alert and perform the appropriate shoulder checks when changing lanes.

Limitations and Inaccuracies

Lane Assist features cannot always detect lane markings and you may experience unnecessary or invalid warnings in these situations:

- Visibility is poor and lane markings are not clearly visible (due to heavy rain, snow, fog, etc.).
- Bright light (such as from oncoming headlights or direct sunlight) is interfering with the view of the camera(s).
- A vehicle in front of Model S is blocking the view of the camera(s).
- The windshield is obstructing the view of the camera(s) (fogged over, dirty, covered by a sticker, etc.).
- Lane markings are excessively worn, have visible previous markings, have been adjusted due to road construction, or are changing quickly (for example, lanes branching off, crossing over, or merging).
- The road is narrow or winding.
- Objects or landscape features are casting strong shadows on lane markers.

Lane Assist may not provide warnings, or may apply inappropriate warnings, in these situations:

- One or more of the sensors (if equipped) or cameras is damaged, dirty, or obstructed (by mud, ice, or snow, or by a vehicle bra, excessive paint, or adhesive products such as wraps, stickers, rubber coatings, etc.).
- Weather conditions (heavy rain, snow, fog, or extremely hot or cold temperatures) are interfering with sensor operation.
- The sensors (if equipped) are affected by other electrical equipment or devices that generate ultrasonic waves.
- An object that is mounted to Model S is interfering with and/or obstructing a sensor (such as a bike rack or a bumper sticker).

In addition, Lane Assist may not steer Model S away from an adjacent vehicle, or may apply unnecessary or inappropriate steering, in these situations:

- You are driving Model S on sharp corners or on a curve at a relatively high speed.
- Bright light (such as from oncoming headlights or direct sunlight) is interfering with the view of the camera(s).
- You are drifting into another lane but an object (such as a vehicle) is not present.
- A vehicle in another lane cuts in front of you or drifts into your driving lane.
- Model S is not traveling within the speeds at which the Lane Assist feature is designed to operate.
- One or more of the sensors (if equipped) is damaged, dirty, or obstructed (such as by mud, ice, or snow, or by a vehicle bra, excessive paint, or adhesive products such as wraps, stickers, rubber coating, etc.).
- Weather conditions (heavy rain, snow, fog, or extremely hot or cold temperatures) are interfering with sensor operation.
- The sensors (if equipped) are affected by other electrical equipment or devices that generate ultrasonic waves.
- An object mounted to Model S (such as a bike rack or a bumper sticker) is interfering with or obstructing a sensor.
- Visibility is poor and lane markings are not clearly visible (due to heavy rain, snow, fog, etc.).
- Lane markings are excessively worn, have visible previous markings, have been adjusted due to road construction or are changing quickly (for example, lanes branching off, crossing over, or merging).

 **WARNING:** The lists above do not represent every possible situation that may interfere with Lane Assist features. There are many reasons why Lane Assist may not operate as intended. To avoid a collision, stay alert and always pay attention to the road so you can anticipate the need to take corrective action as early as possible.



Collision Avoidance Assist

The following collision avoidance features are designed to increase the safety of you and your passengers:

- **Forward Collision Warning** - provides visual, audible, and haptic feedback warnings in situations when Model S detects that there is a high risk of a frontal collision (see [Forward Collision Warning on page 114](#)).
- **Automatic Emergency Braking** - automatically applies braking to reduce the impact of a frontal collision (see [Automatic Emergency Braking on page 115](#)).
- **Obstacle-Aware Acceleration** - reduces acceleration if Model S detects an object in its immediate driving path (see [Obstacle-Aware Acceleration on page 115](#)).

CAUTION: Ensure all cameras and sensors (if equipped) are clean. Dirty cameras and sensors, as well as environmental conditions such as rain and faded lane markings, can affect performance.

WARNING: Forward Collision Warning is for guidance purposes only and is not a substitute for attentive driving and sound judgment. Keep your eyes on the road when driving and never depend on Forward Collision Warning to warn you of a potential collision. Several factors can reduce or impair performance, causing either unnecessary, invalid, inaccurate, or missed warnings. Depending on Forward Collision Warning to warn you of a potential collision can result in serious injury or death.

WARNING: Automatic Emergency Braking is not designed to prevent all collisions. In certain situations, it can minimize the impact of a frontal collision by attempting to reduce your driving speed. Depending on Automatic Emergency Braking to avoid a collision can result in serious injury or death.

WARNING: Obstacle-Aware Acceleration is not designed to prevent a collision. In certain situations, it can minimize the impact of a collision. Depending on Obstacle-Aware Acceleration to avoid a collision can result in serious injury or death.

Forward Collision Warning

Model S monitors the area in front of it for the presence of an object such as a vehicle, motorcycle, bicycle, or pedestrian. If a collision is considered likely unless you take immediate corrective action, Forward Collision Warning is designed to sound a chime and highlight the vehicle in front of you in red on the instrument panel. If this happens, **TAKE IMMEDIATE CORRECTIVE ACTION!**



Visual, audible, and haptic feedback warnings cancel automatically when the risk of a collision has been reduced (for example, you have decelerated or stopped Model S, or the object in front of your vehicle has moved out of your driving path).

If immediate action is not taken when Model S issues a Forward Collision Warning, Automatic Emergency Braking (if enabled) may automatically apply the brakes if a collision is considered imminent (see [Automatic Emergency Braking on page 115](#)).

By default, Forward Collision Warning is turned on. To turn it off or adjust its sensitivity, touch **Controls > Autopilot > Forward Collision Warning**. Instead of the default warning level of **Medium**, you can turn the warning **Off**, or you can choose to be warned **Late** or **Early**.

NOTE: Forward Collision Warning automatically resets to **Medium** at the beginning of each drive.

WARNING: The camera(s) and sensors (if equipped) associated with Forward Collision Warning are designed to monitor an approximate area of up to 525 feet (160 meters) in your driving path. The area being monitored by Forward Collision Warning can be adversely affected by road and weather conditions. Use appropriate caution when driving.

WARNING: Forward Collision Warning is designed only to provide visual and audible alerts. It does not attempt to apply the brakes or decelerate Model S. When seeing and/or hearing a warning, it is the driver's responsibility to take immediate corrective action.

WARNING: Forward Collision Warning may provide a warning in situations where the likelihood of collision may not exist. Stay alert and always pay attention to the area in front of Model S so you can anticipate whether any action is required.

Forward Collision Warning operates only when driving between approximately 3 mph (5 km/h) and 90 mph (150 km/h).



WARNING: Forward Collision Warning does not provide a warning when the driver is already applying the brake.

Automatic Emergency Braking

Model S is designed to determine the distance from a detected object traveling in front of it. When a frontal collision is considered unavoidable, Automatic Emergency Braking is designed to apply the brakes to reduce the vehicle's speed and therefore, the severity of the impact. The amount of speed that is reduced depends on many factors, including driving speed and environment.

When Automatic Emergency Braking applies the brakes, the instrument panel displays a visual warning and sounds a chime. You may also notice abrupt downward movement of the brake pedal. The brake lights turn on to alert other road users that you are slowing down.



Emergency braking in progress

Automatic Emergency Braking operates only when driving between approximately 3 mph (5 km/h) and 90 mph (150 km/h).

Automatic Emergency Braking does not apply the brakes, or stops applying the brakes, when:

- You turn the steering yoke (or steering wheel) sharply.
- You press and release the brake pedal while Automatic Emergency Braking is applying the brakes.
- You accelerate hard while Automatic Emergency Braking is applying the brakes.
- The vehicle, motorcycle, bicycle, or pedestrian is no longer detected ahead.

Automatic Emergency Braking is always enabled when you start Model S. To disable it for your current drive, touch **Controls > Autopilot > Automatic Emergency Braking**. Even if you disable Automatic Emergency Braking, your vehicle may still apply the brakes after detecting an initial collision to reduce further impact (see [Multi-Collision Braking on page 115](#)).

WARNING: It is strongly recommended that you do not disable Automatic Emergency Braking. If you disable it, Model S does not automatically apply the brakes in situations where a collision is considered likely.

WARNING: Automatic Emergency Braking is designed to reduce the severity of an impact. It is not designed to avoid a collision.

WARNING: Several factors can affect the performance of Automatic Emergency Braking, causing either no braking or inappropriate or untimely braking, such as when a vehicle is partially in the path of travel or there is road debris. It is the driver's responsibility to drive safely and remain in control of the vehicle at all times. Never depend on Automatic Emergency Braking to avoid or reduce the impact of a collision.

WARNING: Automatic Emergency Braking is designed to reduce the impact of frontal collisions only and does not function when the vehicle is in Reverse.

WARNING: Automatic Emergency Braking is not a substitute for maintaining a safe traveling distance between you and the vehicle in front of you.

WARNING: The brake pedal moves downward abruptly during automatic braking events. Always ensure that the brake pedal can move freely. Do not place material under or on top of the driver's floor mat (including an additional mat) and always ensure that the driver's floor mat is properly secured. Failure to do so can impede the ability of the brake pedal to move freely.

Multi-Collision Braking

In addition to Automatic Emergency Braking, your vehicle may apply the brakes to prevent or mitigate a subsequent impact after an initial collision if airbag deployment is detected. The brakes may be applied regardless of driving speed.

Obstacle-Aware Acceleration

Obstacle-Aware Acceleration is designed to reduce the impact of a collision by reducing motor torque and in some cases applying the brakes, if Model S detects an object in its driving path. The instrument panel displays a visual warning and sounds a chime when the brakes are automatically applied. For example, Model S, while parked in front of a closed garage door with Drive engaged, detects that you have pressed hard on the accelerator pedal. Although Model S still accelerates and hits the garage door, the reduced torque may result in less damage.







Obstacle-Aware Acceleration is designed to operate only when all of these conditions are simultaneously met:

- Drive or Reverse is engaged.
- Model S is stopped or traveling less than 10 mph (16 km/h).
- Model S detects an object in its immediate driving path.

To disable Obstacle-Aware Acceleration, touch **Controls > Autopilot > Obstacle-Aware Acceleration**.



Collision Avoidance Assist

-  **WARNING:** Obstacle-Aware Acceleration is designed to reduce the severity of an impact. It is not designed to avoid a collision.
 -  **WARNING:** Obstacle-Aware Acceleration may not limit torque in all situations. Several factors, including environmental conditions, distance from an obstacle, and a driver's actions, can limit, delay, or inhibit Obstacle-Aware Acceleration.
 -  **WARNING:** Obstacle-Aware Acceleration may not limit torque when performing a sharp turn, such as into a parking space.
 -  **WARNING:** Do not rely on Obstacle-Aware Acceleration to control acceleration or to avoid, or limit, the severity of a collision, and do not attempt to test Obstacle-Aware Acceleration. Doing so can result in serious property damage, injury, or death.
 -  **WARNING:** Several factors can affect the performance of Obstacle-Aware Acceleration, causing an inappropriate or untimely reduction in motor torque and/or undesired braking. It is the driver's responsibility to drive safely and remain in control of Model S at all times.
-  **CAUTION:** If a fault occurs with a Collision Avoidance Assist feature, Model S displays an alert. Contact Tesla Service.

Limitations and Inaccuracies

Collision Avoidance features cannot always detect all objects, vehicles, bikes, or pedestrians, and you may experience unnecessary, inaccurate, invalid, or missed warnings for many reasons, particularly if:

- The road has sharp curves.
- Visibility is poor (due to heavy rain, snow, fog, etc.).
- Bright light (such as from oncoming headlights or direct sunlight) is interfering with the view of the camera(s).
- A camera or sensor is obstructed (dirty, covered, fogged over, covered by a sticker, etc.).
- One or more of the sensors (if equipped) is damaged, dirty, or obstructed (such as by mud, ice, or snow, or by a vehicle bra, excessive paint, or adhesive products such as wraps, stickers, rubber coating, etc.).
- Weather conditions (heavy rain, snow, fog, or extremely hot or cold temperatures) are interfering with sensor operation.
- The sensors (if equipped) are affected by other electrical equipment or devices that generate ultrasonic waves.

-  **WARNING:** The limitations previously described do not represent an exhaustive list of situations that may interfere with proper operation of Collision Avoidance Assist features. These features may fail to provide their intended function for many other reasons. It is the driver's responsibility to avoid collisions by staying alert, paying attention, and taking corrective action as early as possible.

How Speed Assist Works

Model S displays a speed limit on the instrument panel and you can choose if and how you are warned when you exceed the speed limit. Also, instead of using the detected speed limit, you can base warnings on an arbitrary speed limit that you enter manually.

In situations where Model S is unable to determine a speed limit, or if Speed Assist is uncertain that an acquired speed limit is accurate, the instrument panel may not display a speed limit sign and warnings do not take effect.

NOTE: Speed limit warnings go away after ten seconds, or when Model S slows down below the specified limit.

 **WARNING:** Do not rely on Speed Assist to determine the appropriate speed limit or driving speed. Always drive at a safe speed based on traffic and road conditions.

Controlling Speed Assist

To adjust the Speed Limit Warning setting, touch **Controls > Autopilot > Speed Limit Warning**, then choose one of these options:

- **Off** - Speed limit warnings do not display and chimes are not sounded.
- **Display** - Speed limit signs display on the instrument panel and the sign increases in size when you exceed the determined limit.
- **Chime** - In addition to the visual display, a chime is sounded when you exceed the determined speed limit.

You can also specify how the speed limit is determined:

- **Relative** - You can set a speed limit offset (+ or -) if you want to be alerted only when you exceed the offset speed limit by a specified amount. For example, you can increase the offset to +10 mph (10 km/h) if you only want to be warned when you exceed the speed limit by 10 mph (10 km/h).

NOTE: The offset from speed limit also affects the number shown in the gray speed icon on the instrument panel.

- **Absolute** - Manually specify any speed limit between 20 and 140 mph (30 and 240 km/h).

NOTE: Speed Assist is not always accurate. In some situations, the location of a road can be miscalculated and Speed Assist can display a speed for a directly adjacent road that may have a different speed limit. For example, Speed Assist can assume Model S is on a controlled-access highway when it is actually on a nearby surface street, and vice versa.

NOTE: Your chosen setting is retained until you manually change it.

Limitations and Inaccuracies

Speed Assist may not be fully functional or may provide inaccurate information in these situations:

- Visibility is poor and speed limit signs are not clearly visible (due to heavy rain, snow, fog, etc.).
- Bright light (such as from oncoming headlights or direct sunlight) is interfering with the view of the camera(s).
- Model S is being driven very close to a vehicle in front of it which is blocking the view of the camera(s).
- The windshield is obstructing the view of the camera(s) (fogged over, dirty, covered by a sticker, etc.).
- Speed limit signs are concealed by objects.
- The speed limits stored in the map database are incorrect or outdated.
- Model S is being driven in an area where GPS or map data is not available or where speed limit signs can not be detected.
- Traffic signs that do not conform to standard recognizable formats, such as digital or temporary speed signs.
- A road or a speed limit has recently changed.

 **WARNING:** The list above does not represent an exhaustive list of situations that may interfere with proper operation of Speed Assist. Speed Assist may fail to provide warnings for many other reasons.



Cabin Camera

Your Model S is equipped with a cabin camera located above the rear view mirror.

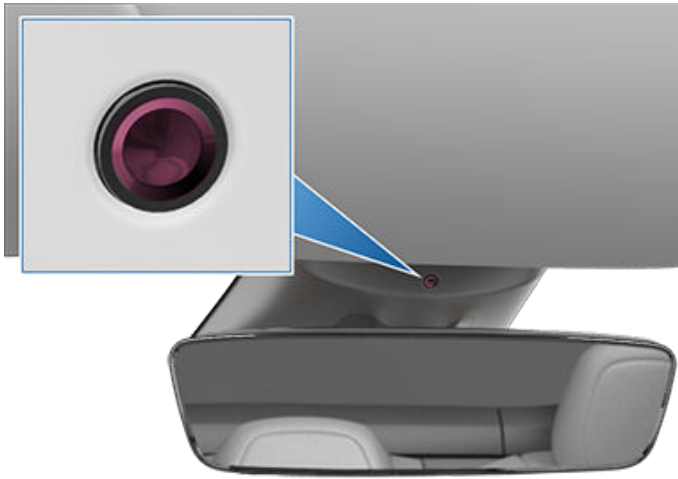

NOTE: Keep the camera lens clean and free of obstructions. Remove any buildup of dirt or dust by occasionally wiping the camera lens with a clean cloth.



CAUTION: Do not use chemical-based or abrasive cleaners. Doing so can damage the surface of the camera lens.

The cabin camera can determine driver inattentiveness and provide you with audible alerts, to remind you to keep your eyes on the road when Autopilot is engaged.

By default, images and video from the camera do not leave the vehicle itself and are not transmitted to anyone, including Tesla, unless you enable data sharing. If you enable data sharing and a safety critical event occurs (such as a collision), Model S shares short cabin camera video clips with Tesla to help us develop future safety enhancements and continuously improve the intelligence of features that rely on the cabin camera. Data may also be shared if diagnostics are required on cabin camera functionality. Cabin camera does not perform facial recognition or any other method of identity verification. To protect your privacy, cabin camera data is not associated with your vehicle identification number.

To adjust your data sharing preferences touch **Controls** > **Software** > **Data Sharing** > **Allow Cabin Camera Analytics**. You can change your data sharing settings at any time.



Overview of Climate Controls

Climate controls are available at the bottom of the touchscreen. By default, climate control is set to **Auto**, which maintains optimum comfort in all but the most severe weather conditions. When you adjust the cabin temperature while in the **Auto** setting, the system automatically adjusts the heating, air conditioning, air distribution, and fan speed to maintain the cabin at your selected temperature.

Touch the displayed temperature at the bottom of the touchscreen to access the main climate controls screen, where you can adjust your climate preferences. You can revert back to Auto at any time by touching **Auto**. Touch the power button on the main climate controls screen to toggle on or off. For quick access to common controls, touch **<** or **>** to display the climate popup.

NOTE: The climate control system is powered by the high voltage Battery. Therefore, prolonged use decreases driving range.

⚠ WARNING: To avoid burns resulting from prolonged use, individuals who have peripheral neuropathy, or whose capacity to feel pain is limited because of diabetes, age, neurological injury, or some other condition, should exercise caution when using the climate control system and seat heaters.

Adjusting Climate Control Settings

NOTE: Easily adjust your climate preferences, such as turning on the seat heater or changing the cabin temperature, hands-free by using voice commands (see [Voice Commands on page 131](#)).

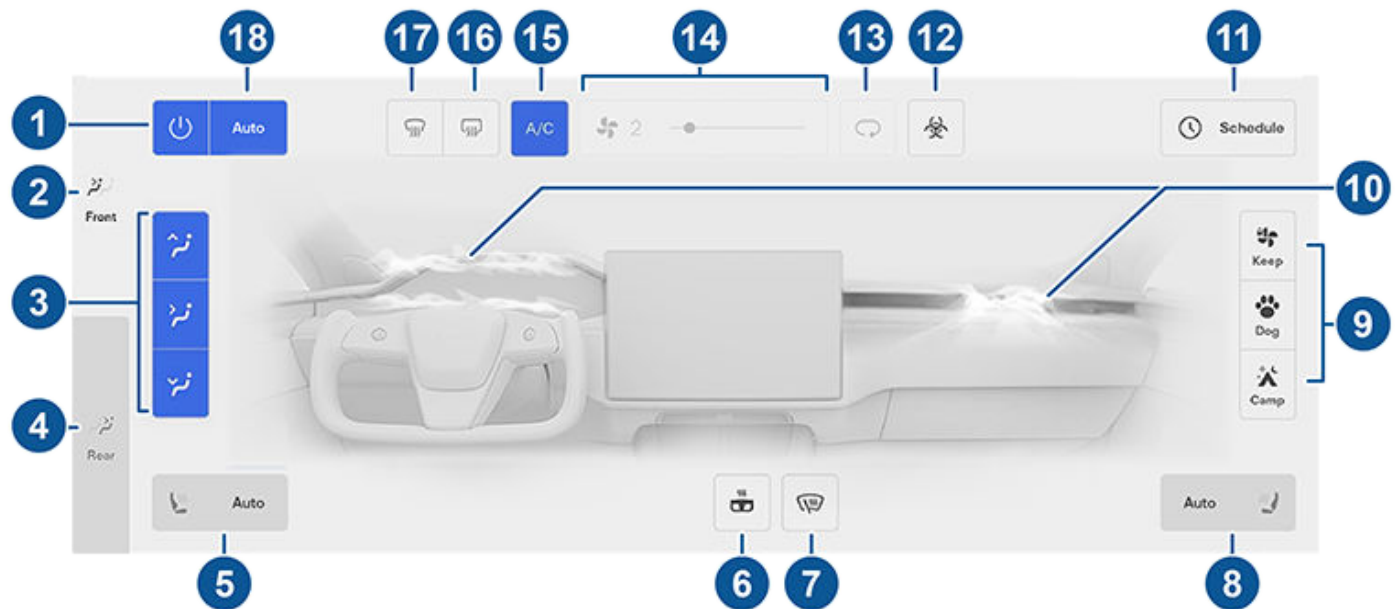

NOTE: For one-touch access to seat heaters and defrosters, you can add these controls to My Apps. See [Customizing My Apps on page 10](#).

1. Touch to turn the climate control system on or off.
2. Touch to adjust the climate settings for the front cabin.
3. Choose where air flows into the front cabin (windshield, face-level, or foot-level vents). You can choose one or more vents.
4. Touch to adjust the climate settings for the rear cabin. If **Auto** is enabled and a passenger is detected, the set temperature is maintained for the rear cabin (see [Adjusting the Front and Rear Vents on page 122](#)).

NOTE: Enable **Sync** to set the same temperature for the front and back cabins.



Climate Controls

5. Touch the driver's side seat icon to adjust seat heaters for the driver. The seat operates at three levels from 3 (highest) to 1 (lowest). The seat icon displays twisting lines that turn red (heating) or blue (cooling) corresponding with the set level. **Auto**, which displays when the climate control system is set to **Auto**, warms or cools the front seats based on cabin temperature. For one-touch access to seat heaters, you can add them to the touchscreen's bottom bar (see [Customizing My Apps on page 10](#)).
6. Touch to control the heated steering yoke (or steering wheel). The icon displays red twisting lines that correspond to the set level. If set to **Auto**, the steering wheel is heated as needed, based on cabin temperature, whenever the climate control system is set to **Auto**. For one-touch access, you can add this control to the touchscreen's bottom bar (see [Customizing My Apps on page 10](#)).
7. Touch to turn on the wiper defrosters. Wipers defrost for 15 minutes then turn off automatically.
8. Touch the passenger's side seat icon to adjust seat heaters for the front passenger. The seat operates at three levels from 3 (highest) to 1 (lowest). The seat icon displays twisting lines that turn red (heating) or blue (cooling) to corresponding with the set level. **Auto**, which displays when the climate control system is set to **Auto**, warms or cools the front seats based on cabin temperature. For one-touch access to seat heaters, you can add them to the touchscreen's bottom bar (see [Customizing My Apps on page 10](#)).
9. When in Park, these settings display to allow you to keep the climate control system operating, even when you leave Model S (see [Keep Climate On, Dog, and Camp on page 123](#)).
10. Touch to adjust how air flows from the front vents. See [Adjusting the Front and Rear Vents on page 122](#).
11. When Model S is in Park, touch **Schedule** to set a recurring daily time when you want Model S to be ready to drive by preconditioning the Battery and cabin climate and/or charging during off-peak hours (see [Scheduled Charging and Scheduled Departure on page 168](#)).
12. If your Model S is equipped with the medical-grade HEPA (High Efficiency Particulate Air) filter, this filter ensures the best quality air inside the cabin whenever the climate control system is on and outside air is entering the cabin (recirculate is off). The HEPA filter is extremely effective at removing particles, including pollution, allergens, bacteria, pollen, mold spores, and viruses. Both the HEPA filter and the secondary filtration system also contain activated carbon to remove a broad spectrum of odors and gases. When you engage Bioweapon Defense Mode, the positive pressure inside the cabin minimizes the amount of outside air that can enter the vehicle.
NOTE: Some gases, such as carbon monoxide, are not effectively removed by activated carbon.
13. Touch to control the flow of air inside the cabin. Air can be drawn into Model S from outside or air can be recirculated inside the cabin.
14. Use the slider to adjust the fan speed. When in **Auto**, the fan speed levels change to **Low/ Medium/ High**.
NOTE: Adjusting the fan speed may change the selected setting for how air is drawn into Model S in order to increase or reduce air flow.
15. Touch to turn the air conditioning system on or off. Turning it off reduces cooling, but saves energy.
NOTE: Because Model S runs much quieter than a gasoline-powered vehicle, you may notice the sound of the air conditioning compressor as it is operating. To minimize noise, reduce the fan speed.
16. Touch to warm up the rear windshield. After 15 minutes, the rear window defroster automatically turns off. The exterior side mirrors are also heated whenever the rear window defroster is operating.
17. The windshield defroster distributes air flow to the windshield. Touch once to *defog* the windshield (the icon turns blue). Touch a second time to *defrost* the windshield. Touch a third time to turn off and restore the air distribution, heating, and fan to their previous settings. In cold ambient temperatures, the exterior side mirrors are also heated whenever the windshield defroster is operating. See [Cold Weather Best Practices on page 79](#) for more information on preparing for cold weather.
18. Touch **Auto** to turn the Auto setting on or off.

Climate Popup

Touch the temperature arrows on the bottom of the touchscreen to display a popup for easy access to some of the most common climate controls:

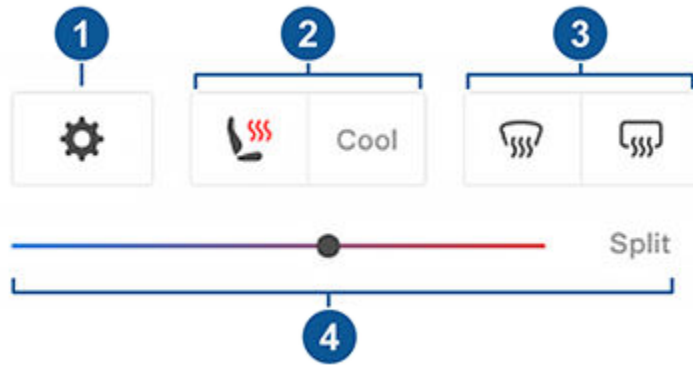

NOTE: For one-touch access to seat heaters and defrosters, you can add these controls to My Apps. See [Customizing My Apps on page 10](#).

1. Touch to access the main climate controls screen.
2. Enable or disable heated or cooling seats.
3. Enable or disable the front or rear windshield defrosters.
4. Modify the cabin temperature by dragging along the slider. You can also enable temperature splitting which allows the driver and front passenger to customize their own climate preferences. The front passenger can touch the temperature icon on the bottom of the touchscreen or the main climate controls screen to adjust. Touch **Split** again to disable climate splitting.



Adjusting the Front and Rear Vents

Model S has a unique horizontal face-level vent that spans the width of the dashboard. It also has vents at the top and bottom of the rear console.

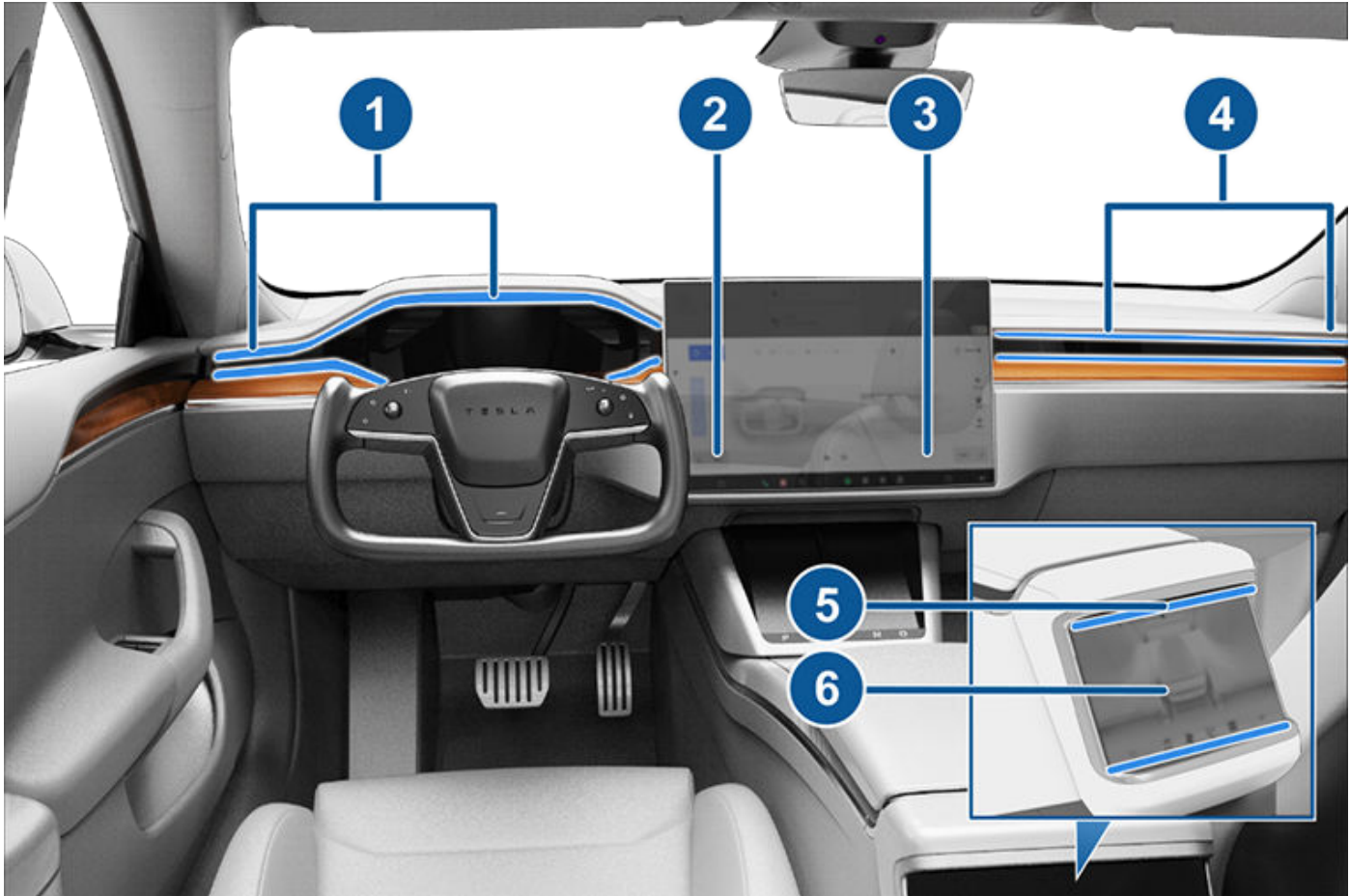

1. Driver vents
2. Driver controls
3. Passenger controls
4. Passenger vents
5. Rear vents
6. Rear controls

Using the touchscreens, you can pinpoint exactly where you want to direct the air flowing from this vent when heating or cooling the cabin. When the face-level vent is on you can adjust the direction of the air flow from each vent. To adjust the direction of the air flow, touch the radiating air waves from the corresponding vent on the touchscreen. The air flows in a single stream when centered or splits into mirrored air streams when air is directed outward or inward from the center of the vent.



NOTE: When you split a vent into two separate air flows, the air flow in each direction is not as strong as when all air is flowing in a single direction.

NOTE: Outside air is drawn into Model S through the grill in front of the windshield. Keep the grill clear of obstructions, such as leaves and snow.

Keep Climate On, Dog, and Camp

The **Keep Climate On**, **Dog**, and **Camp** settings allow you to keep the climate control system running when in Park, even after you've left Model S or choose to stay inside the vehicle. These settings are useful when it is important to maintain the cabin temperature in hot or cold weather conditions. For example, when leaving groceries in Model S on hot days, you may want to use Keep Climate On to prevent spoilage.

Dog is designed to maintain a comfortable cabin temperature for your pet while you actively and frequently monitor this temperature using the mobile app (which requires both your phone and the vehicle to have cellular connectivity). When in Dog, the touchscreen displays the current cabin temperature to inform people passing by that your pet is safe. This setting is not intended for people, and should only be used for short periods of time while you stay in close proximity should you need to return to the vehicle in situations where the temperature can no longer be maintained.

NOTE: To avoid accidentally pressing the window switch (such as your dog stepping on it), the windows cannot be rolled down while Dog is enabled.

NOTE: If Dog and Sentry are enabled at the same time, Sentry defaults to **Disable Sentry Sounds** to protect your pet. See [Sentry Mode on page 136](#) for more information.

Live Camera view is now available if Sentry Mode or Dog Mode, or both, are enabled. When Sentry Mode is on, the cameras show a live view of the vehicle's surroundings. When Dog Mode is on, the interior cabin camera shows the inside of the vehicle so you can check on your pet at any time. If both are enabled, switch the camera views by touching the gray circles or the interior icon that correspond to different cameras on the mobile app. See [Sentry Mode on page 136](#) for more information.

NOTE: Enabling the interior cabin camera for Dog or Sentry Mode requires the mobile app version 4.15.0 or higher. This feature is not supported in vehicles with Autopilot computer 2.0 or 2.5. Touch **Controls** > **Service** > **Autopilot computer** to find out which computer your vehicle has.

NOTE: View Live Camera is limited to approximately one hour (or 15 minutes for some regions) of cumulative usage per day

Camp allows you to power electronics through the USB ports and low voltage outlet in addition to maintaining the cabin temperature. The touchscreen remains on so you can play music, browse the internet, play games in the arcade, or watch shows in Tesla Theater. You can also control media and climate settings from a paired phone. Camp is ideal for remaining inside your vehicle, such as camping or staying with a child. While active, Sentry Mode and the vehicle alarm system are disabled.

To operate Keep Climate On, Dog, or Camp:

1. Make sure the Battery's charge level is at least 20%.



Climate Controls





2. Engage Park. The **Keep Climate On, Dog,** and **Camp** settings are available only when Model S is in Park.
3. If necessary, adjust the climate settings.
4. On the climate controls screen, touch **Keep Climate On, Dog,** or **Camp**.

NOTE: You can also control **Dog** and **Camp** from the mobile app, by swiping up from the gray bar on the Climate screen.

The climate control system attempts to maintain your climate settings until you shift out of Park or manually turn it off. Avoid using Keep Climate On, Dog, or Camp when the Battery's charge level is low. If the Battery's charge level drops below 20%, the Tesla mobile app attempts to repeatedly send notifications reminding you to check on anything that you have left in Model S.

NOTE: Software updates cannot be performed when Keep Climate On, Dog, or Camp is active.

NOTE: The intrusion sensor (if equipped) automatically disables when Keep Climate On, Dog, or Camp is active. However, you can override this behavior and keep the intrusion sensor enabled. To do so, touch **Controls > Safety > Tilt/Intrusion** after enabling Keep Climate On, Dog, or Camp. However, note that keeping the intrusion sensor enabled while Keep Climate On, Dog, or Camp is active can trigger an alarm event as a result of air movement inside the cabin.

-  **WARNING:** Never leave a child unattended in your vehicle.
-  **WARNING:** Check local laws for any restrictions on leaving pets unattended in your vehicle.
-  **WARNING:** You are responsible for the safety of your dog or pet. Never leave them in Model S for long periods of time. Constantly monitor the vehicle temperature and their well-being. Make sure you have sufficient cellular coverage on your phone and time to return to the vehicle, if necessary.
-  **WARNING:** In the unlikely event that your climate control system needs service or is not working as expected, avoid using Keep Climate On, Dog, and Camp. Never rely on your vehicle to protect something irreplaceable.
-  **WARNING:** You can adjust and monitor the climate control system remotely using the mobile app. However, if you use the mobile app to turn off the climate control system, Keep Climate On, Dog, and Camp stop operating.

Cabin Air Filter(s)

Model S has one or more air filters to prevent pollen, industrial fallout, road dust and other particles from entering through the vents.

NOTE: Cabin air filter(s) require periodic replacement. See [Service Intervals on page 171](#).

Cabin Overheat Protection



Cabin Overheat Protection prevents the cabin from getting too hot in scorching ambient conditions. While not necessary to activate whenever you leave Model S, the climate control system can reduce and maintain the temperature of your vehicle's cabin. This can prevent the cabin from getting too hot after leaving it parked in the sun, making the vehicle more comfortable when you return. Cabin Overheat Protection may take up to 15 minutes to enable once you exit the vehicle. This feature is intended for passenger comfort and has no impact on the reliability of your vehicle's components.

To turn on, touch **Controls > Safety > Cabin Overheat Protection** and choose:

- **On:** The air conditioning operates when the cabin temperature exceeds 105° F (40° C), or the selected temperature if available, on the touchscreen or mobile app. Customizing temperatures may require the most recent version of the mobile app.
- **Off:** Disables Cabin Overheat Protection.

You can also enable Cabin Overheat Protection remotely through the mobile app by touching **Climate**. Swipe up on the bottom menu and select a setting under **Cabin Overheat Protection** (see [Mobile App on page 145](#)).

Cabin Overheat Protection operates until 12 hours has elapsed once you exit Model S, or until the Battery energy drops below 20%, whichever comes first. Using Cabin Overheat Protection requires energy from the Battery, which may decrease range.

-  **WARNING:** Due to automatic shut-off, extreme outside conditions, or other potential inability to maintain the selected temperature, the inside of the vehicle can become dangerously hot, even when Cabin Overheat Protection is enabled. If you experience temperatures exceeding the selected temperature repeatedly, contact Tesla service.
-  **WARNING:** Never leave children or pets in the vehicle unattended. Due to automatic shut-off or extreme outside conditions, the inside of the vehicle can become dangerously hot, even when Cabin Overheat Protection is enabled.

Climate Control Operating Tips

- When you use the mobile app to turn on the climate control system, it automatically turns off when the charge level drops to 20%, or if two hours has passed. To cool or heat the cabin for a longer period of time, charge the vehicle and re-enable your climate control preference through the mobile app.



- You may hear the sound of the climate system inside the cabin of Model S when Parked. It makes a low fan noise. The climate system attempts to dry itself out to minimize additional moisture or musty odors. This is a normal operation and not a cause for concern.
- You can improve the efficiency of the cabin heating by reducing your selected acceleration mode (see [Acceleration Modes on page 73](#)). This allows the heat pump system to take more heat from the Battery to efficiently heat the cabin, instead of maintaining the Battery's ability to provide peak acceleration performance. This helps to maximize driving efficiency in colder weather. Note that when subsequently increasing the acceleration mode, the Battery requires time to warm up before the increased level of acceleration is available.
- If the climate control system is louder than you prefer, manually reduce the fan speed.
- In addition to cooling the interior, the air conditioning compressor also cools the Battery. Therefore, in hot weather, the air conditioning compressor can turn on even if you turned it off. This is normal because the system's priority is to cool the Battery to ensure it stays within an optimum temperature range to support longevity and optimum performance.
- Even when not in use, you may hear Model S emit a whining noise or the sound of water circulating. These sounds are normal and occur when the internal cooling systems turn on to support various vehicle functions, such as maintaining the low voltage battery and balancing the temperature of the high voltage Battery.
- To ensure the climate control system operates efficiently, close all windows and ensure that the exterior grille in front of the windshield is free of ice, snow, leaves, and other debris.
- In very humid conditions, it is normal for the windshield to fog slightly when you first turn on the air conditioning.
- It is normal for a small pool of water to form under Model S when parked. Extra water produced by the dehumidifying process is drained underneath.
- To reduce the temperature in the cabin in hot weather conditions, the fan may turn on to vent the cabin when the vehicle is parked. This occurs only if the battery's charge level is above 20%.



Bluetooth® Compatibility



You can use your Bluetooth-capable phone hands-free in Model S provided your phone is within operating range. Although Bluetooth typically supports wireless communication over distances of up to approximately 30 feet (nine meters), performance can vary based on the phone you are using.

Before using your phone with Model S, you must pair it. Pairing sets up Model S to work with your Bluetooth-capable phone (see [Pairing a Bluetooth Phone on page 126](#)).

NOTE: Authenticating your phone to use as a key (see [Keys on page 12](#)) does not also allow you to use the phone hands-free, play media from it, etc. You must also pair it as described below.

You can pair up to ten Bluetooth phones. Unless you've specified a specific phone as a **Priority Device** or if the phone specified as **Priority Device** is not within range, Model S always connects to the last phone that was used (provided it is within range). To connect to a different phone, see [Bluetooth® Compatibility on page 126](#).

NOTE: On many phones, Bluetooth turns off if the phone's battery is low.

NOTE: In addition to phones, you can pair other Bluetooth-enabled devices with Model S. For example, you can pair an iPod Touch, an iPad, an Android tablet, etc. from which you can play music.

Pairing a Bluetooth Phone

Pairing allows you to use your Bluetooth-capable phone hands-free to make and receive phone calls, access your contact list, recent calls, etc. It also allows you to play media files from your phone. Once a phone is paired, Model S can connect to it whenever the phone is within range.

To pair a phone, follow these steps while sitting inside Model S:

1. Ensure both the touchscreen and the phone are powered on.
2. On your phone, enable Bluetooth and ensure it is discoverable.

NOTE: On some phones, this may require you to go to Bluetooth Settings for the remainder of the procedure.

3. Touch the Bluetooth icon located at the top of the **Controls** screen.

4. On the touchscreen, touch **Add New Device > Start Search**. A list of all available Bluetooth devices within operating distance displays on the Bluetooth settings screen.
5. Choose the phone with which you want to pair. Within a few seconds, the Bluetooth settings screen displays a randomly generated number. Your phone also display a number.
6. Check that the number displayed on your phone matches the number on the Bluetooths settings screen. Then, on your phone, confirm that you want to pair.
7. If prompted on your phone, specify whether you want to allow Model S to access your personal information, such as calendar, contacts and media files.

When paired, Model S automatically connects to the phone, and the Bluetooth settings screen displays the Bluetooth symbol next to the phone's name to indicate that the connection is active.

You can display the Bluetooth settings screen at any time and change the settings associated with a connected device. For example, you can designate a connected phone as the **Priority Device**. This is useful in situations where you have connected more than one phone, and both phones are frequently used in Model S at the same time. Model S automatically attempts to connect to the priority device before others. If a priority device is not specified, or is not within range, Model S connects to the most recently used phone (if applicable).

NOTE: Model S can only support up to two Bluetooth devices at a time (such as two controllers, or one phone and one controller).

Importing Contacts and Recent Calls

Once paired, use the Bluetooth settings screen to specify whether you want to allow access to your phone's contacts, recent calls and text messages. If you allow access, you can use the phone app to make calls and send messages to people in your list of contacts and on your recent calls list (see [Bluetooth® Compatibility on page 126](#)). Before contacts can be imported, you may need to either set your phone to allow syncing, or respond to a popup on your phone to confirm that you want to sync contacts. This varies depending on the type of phone you are using. For details, refer to the documentation provided with your phone.

NOTE: You can turn access to your contacts and recent calls on or off at any time by touching the Bluetooth icon on the touchscreen, choosing your phone, and then changing the associated access settings.



Unpairing a Bluetooth Phone

If you want to disconnect your phone and use it again later, simply touch **Disconnect** on the Bluetooth settings screen. If you no longer want to use your phone with Model S, touch **Forget This Device**. Once you forget a device, you must pair it again if you want to use it with Model S (see [Pairing a Bluetooth Phone on page 126](#)).

NOTE: Your phone automatically disconnects when you leave Model S.

NOTE: Unpairing the phone has no effect on using the phone as a key. To forget an authenticated phone, see [Managing Keys on page 15](#).

Connecting to a Paired Phone

Model S automatically connects to a phone that you designated as **Priority Device** on the Bluetooth settings screen. If you have not set a phone as a priority, Model S connects to the last phone to which it was connected, provided it is within operating range and has Bluetooth turned on. If the last phone is not within range, it attempts to connect with the next phone that it has been paired with.

To connect to a different phone, touch the Bluetooth icon at the top of the **Controls** screen. The Bluetooth settings screen displays a list of paired phones. Choose the phone you want to connect to, then touch **Connect**. If the phone you want to connect to is not listed, you must pair the phone. See [Pairing a Bluetooth Phone on page 126](#).

When connected, the Bluetooth settings screen displays the Bluetooth symbol next to the phone's name to show that Model S is connected to the phone.

Using the Phone App



When your phone is connected to Model S using Bluetooth, and you have allowed access to information on your phone (see [Importing Contacts and Recent Calls on page 126](#)), you can use the phone app to display and make a hands-free call to anyone listed on your phone.

- **Calls:** Displays recent calls in chronological order with the most recent call listed first.
- **Messages:** Displays message in chronological order with the most recent message listed first. You can view, send, and receive text messages. Instead of typing a text message, touch the microphone button on the right side of the steering yoke (or steering wheel) to enter text using your voice.



WARNING: To minimize distraction and ensure the safety of occupants as well as other road users, do not view or send text messages when the vehicle is in motion. Pay attention to road and traffic conditions at all times when driving.

- **Contacts:** Contacts are listed in alphabetical order and can be sorted by first name or last name. You can also choose a letter on the right side of the list to quickly scroll to the names that begin with the selected character. When you touch a name on your contacts list, the contact's available number(s) displays on the right pane, along with other available information (such as address). Touch the contact's number to make a call.
- **Favorites:** Displays the contacts from your phone that you have identified as Favorites.
- **Calendar:** Displays calendar entries from your phone (see [Calendar on page 128](#)). If an entry includes a phone number or an address, you can make a phone call, or navigate to a destination, by touching the corresponding information in the calendar entry.

Making a Phone Call

You can make a phone call by:

- Speaking a voice command (see [Voice Commands on page 131](#)). Voice commands are a convenient, hands-free way to call or text your contacts.
- Touching a phone number shown in a list in the phone app - Contacts, Calls, or Calendar.
- Using the Model S on-screen dialer in the Phone app's Calls list.

NOTE: If it is safe and legal to do so, you can also initiate a call by dialing the number or selecting the contact directly from your phone.

NOTE: You can also make a phone call by touching a pin on the map and choosing the phone number (if available) on the popup screen.

Receiving a Phone Call

When your phone receives an incoming call, the touchscreen displays the caller's number or name (if the caller is in your phone's contact list and Model S has access to your contacts).

Touch one of the options on the touchscreen to **Answer** or **Ignore** the call. Depending on the phone you are using and what speakers you used for your most recent call, your phone may prompt you to choose which speakers you want to use for the incoming call.



WARNING: Stay focused on the road at all times while driving. Using or programming a phone while driving, even with Bluetooth enabled, can result in serious injury or death.



Phone, Calendar, and Web Conferencing

WARNING: Follow all applicable laws regarding the use of phones while driving, including, but not limited to, laws that prohibit texting and require hands-free operation at all times.

In Call Options

When a call is in progress, the call menu displays on the touchscreen. Then roll the right scroll button to choose an option. To adjust the call volume, roll left scroll button during a call.

Calendar



The calendar displays scheduled events from your phone's (iPhone® or Android™) calendar for the current and next day. The calendar is conveniently integrated with the phone app so you can dial into your meeting from a Calendar entry. It is also integrated with the navigation system so you can navigate to the event's location.

1. Ensure your phone is paired to Model S.
2. Ensure you are logged into the Tesla mobile app.
3. In your Tesla mobile app, touch **Profile > Settings > Calendar Sync**.

NOTE: To ensure you have access to all of the calendar's features, it is recommended that you use the most recent version of the mobile app.

4. On your phone, go to **Settings** and allow access/give permission to share your calendar with the Tesla mobile app. The mobile app can then periodically (and automatically) send calendar data from your phone to Model S.

If a calendar event includes an address, a navigation arrow displays to indicate that you can touch the address to navigate to the event's location. When an event on your calendar takes place within the next hour and has a uniquely specified address, the touchscreen notifies you if there is a better route due to traffic, even when you're not actively using navigation.

If an event has a uniquely specified address and takes place within two hours of you entering your vehicle and preparing to drive, Model S automatically routes you to the event's address (see [Automatic Navigation on page 149](#)).

Touch an event's information icon to display all notes associated with the event. If the notes include one or more phone numbers, the information icon shows a phone icon and the calendar displays the first phone number found. Touch to initiate a phone call. You can also initiate a phone call by touching any number in an event's notes popup screen (this is especially useful for conference calls). If notes include a web link, you can touch the link to open it in the Web browser.

Zoom



Seamlessly take meetings and calls through your vehicle's touchscreen. To set up, touch the Zoom app and sign in or enter the meeting ID. You can even access meetings shown on your calendar or in text messages by touching the Zoom link. Your vehicle's cabin camera can be used in calls over Zoom only when Model S is Parked. When the vehicle is shifted out of Park in the middle of a Zoom call, the meeting switches to audio only. Use the touchscreen to turn on/off the video, mute/unmute yourself, and customize various preferences for your meeting.



NOTE: When Model S starts, you may hear the sound of the compressor as the air suspension system's reservoir fills with air.

Your Model S is equipped with Adaptive Air Suspension that offers superior ride quality and allows you to choose a softer or firmer ride based on your preference. When carrying loads, the system also maintains a level height between the front and rear. You can manually adjust the ride height to suit your circumstances (for example, you can raise Model S when you need extra ground clearance, such as when driving on a steep driveway or ramp, in deep snow, over large speed bumps, parking curbs, etc.).



If a fault is detected that reduces the performance of the adaptive air suspension system, a yellow indicator lights up on the instrument panel. If the problem persists, contact Tesla.



If a fault is detected that disables the adaptive air suspension system, a red indicator lights up on the instrument panel. Contact Tesla.

Adjusting Ride Height



CAUTION: Before adjusting the suspension height, ensure Model S is clear of all obstacles, above and below.

You can manually adjust the ride height by pressing the brake pedal and touching **Controls > Suspension** on the touchscreen. The ride height settings that are available depend on your driving speed and other conditions (for example, the suspension does not lower if a door is open). Drag the slider to choose from these options:

- **Very High** - When set to **Very High**, the suspension automatically lowers to the default ride height*, which is **Medium or Low**, after driving approximately 100 feet (30 meters) or when driving speed reaches 15 mph (24 km/h). To maintain the Very High setting for an unlimited distance until your driving speed reaches the speed threshold, touch **Keep until 15 mph**.
- **High** - When set to **High**, the suspension automatically lowers to the default ride height*, which is **Medium or Low**, after driving approximately 100 feet (30 meters) or when driving speed reaches 35 mph (56 km/h). To maintain the **High** setting for an unlimited distance until your driving speed reaches the speed threshold, touch **Keep until 35 mph**.

NOTE: You can also raise the suspension to **High** by touching the **Raise Suspension** shortcut on the main Controls window.

- **Medium** - The **Medium** setting ensures optimum comfort and handling under all loading conditions.

- **Low** - Lowering the height can improve aerodynamics, make it easier to load or unload cargo and passengers, and improve handling.

*If the **Default Ride Height to Low** setting is turned off, the ride height is adjusted between **Medium** and **Low** to balance ride comfort with handling and range. To optimize handling and range, turn on the **Default Ride Height to Low** setting.



CAUTION: Avoid driving aggressively (hard accelerations, sharp turns, etc.) when the suspension is set to **High** or **Very High**. Doing so can cause vibration and increase the possibility of damage.

Adaptive Suspension Damping

The settings associated with **Adaptive Suspension Damping** provide real-time adjustments to the suspension system to optimize both ride and handling. Choose from:

- **Comfort** - Provides a gentler ride for a relaxed driving experience.
- **Auto** - Adjusts to a wide range of roads and driving styles, providing a fluid yet well controlled ride.
- **Sport** - Provides a firmer, more controlled ride that increases driver engagement and connection to the road.
- **Advanced** - Can be used to fine tune the suspension by dragging individual sliders that adjust **Ride Comfort** and **Handling**.

Touch **Show Suspension Data** to display detailed information about the dampers for each wheel, including ride height, compression and rebound values, and body accelerations.

NOTE: When Adaptive Suspension Damping is set to **Comfort** or **Auto**, the suspension may raise to improve ride comfort on rough roads. This feature depends on the availability of up-to-date map data that includes data indicating rough road sections.

Use Comfort Damping in Autopilot (if equipped) - By default, damping automatically sets to the Comfort setting when using Autopilot, and reverts back to your chosen setting when Autopilot is no longer in use. Turn this setting off to disable this feature.

NOTE: Settings for Adaptive Suspension Damping are disabled when Track Mode (if equipped) is engaged. Track Mode automatically optimizes adaptive damping settings to support aggressive driving on a closed circuit driving course (see [Track Mode on page 74](#)).

Real-time Visualization

The image of your Model S on the Suspension screen provides a real-time visualization of the status of the air suspension system. In addition to visually showing changes to the ride height, it displays Compression and Rebound lines that reflect how the suspension system is controlling the dampers for each wheel based on your chosen settings and changing road conditions. Both are controlled simultaneously. Touch **Show Suspension Data** to display detailed information about the dampers for each wheel, including ride height, compression and rebound values, and body accelerations.

Auto-Raising Locations

Whenever you raise the suspension to **High** or **Very High**, the location is automatically saved. By saving the location, you do not need to manually raise the suspension every time you arrive at a frequently-used location where you have previously raised the suspension. When you return to the saved location, Model S raises the suspension and the instrument panel displays a message indicating that the suspension is being raised.

When saving locations, Model S also saves the **Keep until XX mph** setting (if specified).

NOTE: When returning to a saved location and driving faster than the **High** and **Very High** suspension settings allow, the suspension does not raise until Model S slows down.

NOTE: After leaving a saved location, the suspension automatically lowers. However, it may not lower until Model S meets the speed and distance threshold at which the suspension lowers.

NOTE: If Model S reaches a saved location and the existing suspension setting is already higher than the level that has been saved for that location, the ride height is not adjusted.

To remove an auto-raising location

If you do not want the suspension to automatically raise at a location, touch to deselect **Always raise at this location** in the popup that appears when you arrive at a saved location. Or, when using the **Raise Suspension** shortcut on the main Controls window, touch to deselect **Location Saved**.

Self-Leveling

Model S equipped with air suspension automatically self-levels, even when power is off. To prevent damage when jacking or lifting the vehicle, you must activate **Jack Mode** to disable self-leveling (press the brake pedal and touch **Controls** > **Service** > **Jack Mode**). For more details, see [Jack Mode on page 184](#).



Use voice commands to easily control settings and preferences without using the touchscreen. You can ask Model S to do just about anything, such as adjusting climate controls and media preferences. Available commands include most features that are managed by the touchscreen except driving-related commands, for example shifting drive modes.

Voice commands are designed to understand natural requests. You can use voice commands to:

- Adjust climate preferences.
- Tweak the windshield wiper speed and frequency.
- Control various aspects of your vehicle.
- Navigate to a location.
- Call a contact.
- Interact with apps and settings.

To initiate a voice command, fully press the microphone button on the right side of the steering yoke (or steering wheel). When you hear a chime, make your request and the vehicle responds.



Examples of Voice Commands

Here is a list of example voice commands. This is not an exhaustive list. Tesla is constantly working to improve voice commands.

NOTE: To choose the language you want to use for voice commands, touch **Controls > Display > Voice Recognition Language**. Voice commands are not available in all languages.

Climate Controls

Adjust your climate preferences using voice commands:

- "Make it cooler"
- "Make it warmer"

- "Turn on/off the driver's seat heater"
- "Cool down the passenger"
- "Direct airflow to my face"
- "Sync climate"
- "Increase/decrease the fan speed"
- "Turn on/off rear defroster"
- "Set the temperature/fan..."
- "Turn on recirculate"

Windshield Wipers

Update the windshield wiper speed and frequency based on changing road and weather conditions:

- "Speed up the wipers"
- "Increase/decrease windshield wiper speed by..."
- "Turn on/off the wipers"

Vehicle Controls

You can also modify various controls in your vehicle using voice commands:

NOTE: Your vehicle must be in Park to enable some voice commands (such as Sentry Mode, Dog Mode, etc.).

- "Sentry Mode on/off"
- "Keep my car safe"
- "Lock/unlock the doors"
- "Turn on Dog Mode"
- "Fold/unfold the mirrors"
- "Open/close charge port"
- "Start/stop charging"
- "Open service settings"
- "Open the glovebox"

Navigation

To search for, or navigate to, a location, say:

- "Where is [location]?"
- "Drive to [location]"
- "Navigate to [location]"
- "Show nearby Superchargers"
- "I'm feeling hungry/lucky" (see [Maps and Navigation on page 147](#)).
- "Stop navigation"
- "Mute voice guidance"



Voice Commands

If you have defined a navigation address for your home or work locations, you can use a voice command to navigate there by saying "Navigate home" or "Take me to work".

Contacts

To call or text a contact on your Bluetooth-connected phone (see [Phone, Calendar, and Web Conferencing on page 126](#)), say:

- "Call [contact name/phone number]"
- "Text [contact name/phone number]"

Media

To listen to and adjust your media preferences, say:

- "Listen to [song name]"
- "Lower/raise the volume"
- "Skip to next"
- "Pause/play song"
- "Change the source to [media source]"

To improve voice command recognition accuracy, provide multiple cues in your command, such as artist and song.

Apps and Settings

Easily navigate through your apps and settings using voice commands:

- "Open [Toybox/browser/theater/phone]"
- "Search for..."
- "The screen is too bright"
- "Show me the Owner's Manual"

Some apps and settings are only accessible while in Park.

You can also file a bug report by saying "Report", "Feedback", or "Bug report".

For a complete list of voice commands, go to <https://www.tesla.com/support/voice-commands>.

NOTE: Tesla is continuously improving the ability of Model S to recognize voice commands. To support these ongoing quality improvements, Tesla captures short voice recordings anonymously. To protect your privacy, these short recordings are not associated with your personal information or with your vehicle's identification number. Tesla assures that it is not possible to search any system for a recording associated with a specific customer or vehicle.



About the Security System

If Model S does not detect a key nearby and a locked door or trunk is opened, an alarm sounds. The headlights and turn signals also flash. To deactivate the alarm, press any button on the key fob.

To manually enable or disable the alarm system, touch **Controls > Safety > Security Alarm**. When enabled, Model S activates its alarm one minute after you exit, the doors lock, and a recognized key is no longer detected.

A battery-backed siren (if equipped) sounds in situations where a locked door or trunk is opened and Model S does not detect a key nearby. If you also want this siren to sound in situations where the vehicle detects motion inside the cabin, enable **Tilt/Intrusion** (see [Tilt/Intrusion \(if equipped\)](#) on page 133).

NOTE: If Model S is in Sentry Mode (see [How to Use Sentry Mode \(Camera + App\)](#) on page 136), you must disable Sentry Mode before you can disable the Security alarm or the Tilt/Intrusion alarm.

Tilt/Intrusion (if equipped)

Depending on configuration, market region, and date of manufacture, your vehicle may not be equipped with this feature.

The **Security Alarm** must be on to enable **Tilt/Intrusion**.

Tilt/Intrusion sounds the alarm in your vehicle if Model S detects motion inside the cabin, or is moved or tilted (for example, with a tow truck or jack). To enable, touch **Controls > Safety > Tilt/Intrusion**.

The intrusion sensor automatically disables in situations where the climate control system is operating when you leave your vehicle. To override, you can manually turn the Tilt/Intrusion Sensor on again after choosing Keep Climate On, Dog, or Camp Mode.

The tilt/intrusion sensor automatically re-enables at the start of every drive cycle.

NOTE: If you plan to leave something that moves inside your locked vehicle, remember to turn off **Tilt/Intrusion**. If this setting is on, any motion detected inside Model S activates the intrusion alarm.

Enhanced Anti-Theft Upgrade (if equipped)

If your vehicle is equipped with the Enhanced Anti-Theft upgrade, the horn sounds in situations where a locked door or trunk is opened and Model S does not detect a key nearby. If **Tilt/Intrusion** is on, the horn also sounds if Model S detects motion inside the cabin or if the vehicle is moved or tilted (for example, with a tow truck or jack). To turn the Tilt/Intrusion detection system on or off, touch **Controls > Safety > Tilt/Intrusion**.

PIN to Drive

To increase security, you can prevent Model S from being driven until a 4-digit PIN (Personal Identification Number) is entered. To enable this setting, touch **Controls > Safety > PIN to Drive** and follow the on-screen prompts to create a driving PIN.

When enabled, in addition to entering the 4-digit driving PIN to drive, you must also use it to enter Valet mode for the first time and create the 4-digit valet PIN to enter and exit Valet mode. In Valet mode, Model S can be driven without the need for the valet to enter a driving PIN. The **PIN to Drive** setting is disabled whenever Valet mode is active.

If you forget your driving PIN, touch the link to enter your Tesla login credentials on the PIN to Drive popup, then follow the on-screen prompts.

NOTE: In the unlikely event that your touchscreen is unresponsive, you may be unable to enter the PIN. In this case, first try to restart the touchscreen (see [Restarting the Touchscreen](#) on page 8). If the touchscreen is still unresponsive, you can still bypass PIN to Drive by turning on Keyless Driving in the Tesla mobile app.

Glovebox PIN

For additional security, you can protect the contents in your glovebox with a 4-digit PIN. To enable this setting, touch **Controls > Safety > Glovebox PIN** and follow the on-screen prompts. When enabled, you are prompted to enter the PIN to open the glovebox. To disable this setting, select the toggle to disable and then enter the PIN.

If you forget your glovebox PIN, reset it by entering your Tesla login credentials, then follow the on-screen prompts.

NOTE: Using a **Glovebox PIN** allows the glovebox to be opened even when Model S is in Valet mode.

Speed Limit Mode

Speed Limit Mode allows you to limit acceleration and limit the maximum driving speed to a chosen value between 50 and 120 mph (80 and 193 km/h). The first time you use this feature, you must create a 4-digit PIN that you must use to enable and disable Speed Limit Mode. When enabled and the driving speed approaches within approximately 3 mph (5 km/h) of the maximum speed, a chime sounds, the instrument cluster displays a message, and Model S sends a notification to the mobile app. You can also touch **Security > Speed Limit Mode** to enable from the Tesla mobile app. To enable Speed Limit Mode:

1. Ensure Model S is in Park.





Safety & Security Settings

2. Touch **Controls** > **Safety** > **Speed Limit Mode** on the touchscreen.
3. Select the maximum driving speed.
4. Drag the slider to the **On** position.
5. Enter the 4-digit PIN that you want to use to enable and disable Speed Limit Mode.

NOTE: If you forget the PIN, you can disable Speed Limit Mode by entering login credentials for your Tesla account.

NOTE: While Speed Limit Mode is enabled, the acceleration setting (**Controls** > **Pedals & Steering** > **Acceleration**) automatically sets to **Chill**.

 **WARNING:** Driving downhill can increase driving speed and cause Model S to exceed your chosen maximum speed.

 **WARNING:** Speed Limit Mode is not a replacement for good judgment, driver training, and the need to closely monitor speed limits and driving conditions. Accidents occur at any speed.

NOTE: Depending on market region, vehicle configuration, options purchased, and software version, your vehicle may not be equipped with Dashcam or the features may not operate exactly as described. It is your sole responsibility to consult and comply with all local regulations and property restrictions regarding the use of cameras.

Dashcam records video footage of your vehicle's surroundings when Model S is powered on (see [Starting and Powering Off on page 53](#)) and driving. Use Dashcam to record driving incidents or other notable events, like you would for an external Dashcam on other vehicles.

The Dashcam icon is located in the app launcher. You can add the Dashcam app to the bottom bar for easy access (see [Customizing My Apps on page 10](#)). When your vehicle is in Park, touching the Dashcam icon brings up the Viewer.



To protect your privacy, video recordings are saved locally to a formatted USB flash drive's onboard memory. Recordings are not sent to Tesla. Your vehicle does not record videos when Dashcam is **Off**.

How to Use Dashcam

- Format a USB flash drive. Dashcam requires a properly formatted USB drive inserted in your vehicle's USB port (Tesla recommends using the glovebox USB port, if equipped) to store and retrieve footage. Vehicles manufactured beginning approximately 2020 are equipped with a pre-formatted USB flash drive in the glove box. There are two ways to format the flash drive:
 - Insert the flash drive into the USB port and navigate to **Controls > Safety > Format USB Drive**. Your vehicle automatically formats the flash drive for you.
 - Format the flash drive on a computer. See [USB Drive Requirements for Recording Videos on page 138](#) for more information.
- Insert the USB flash drive into your vehicle's USB port.
- Enable Dashcam by touching **Controls > Safety > Dashcam**. Dashcam allows you to choose how and when footage is saved. You can choose between:
 - Auto:** Dashcam automatically saves a recording to the USB drive when Model S detects a safety-critical event, such as a collision or airbag deployment. When **Auto** is selected, detection can vary and is subject to your vehicle's power, sleep, and Autopilot state.
 - Manual:** You must manually touch the Dashcam icon to save a recording of the most recent 10 minutes of footage.
 - On Honk:** When you press the horn, Dashcam saves a recording of the most recent 10 minutes of footage. This can be enabled along with **Auto** or **Manual**.
- Once Dashcam is enabled, you are free to drive. The Dashcam icon indicates when footage is saved. You can also view the status of Dashcam with the icon in **Controls**:
 - RECORDING:** Dashcam is recording. To save video footage, touch the icon. To pause recording, press and hold the icon.
 - PAUSED:** Dashcam is paused. To resume recording, touch the icon. To avoid losing video footage, pause Dashcam before removing the flash drive.
 - SAVED:** Footage is saved. You can also save Dashcam clips by touching the Dashcam icon in the app launcher while Driving.
- Once your desired footage is saved, view the clips on the touchscreen or a computer:
 - Touchscreen:** Ensure your vehicle is in Park and touch the Dashcam icon in the app launcher. Videos are organized by timestamp. See [Viewing Video Recordings on page 138](#) for more information.
 - Computer:** Insert the USB flash drive into a computer and navigate to the TeslaCam folder. Videos are organized by timestamp. See [Viewing Video Recordings on page 138](#) for more information.
- To turn Dashcam off, navigate to **Controls > Safety > Dashcam > Off**. If set to **Auto**, **On Honk**, or **Manual**, Dashcam will automatically enable every time you drive your vehicle.



Sentry Mode

NOTE: Depending on market region, vehicle configuration, options purchased, and software version, your vehicle may not be equipped with Sentry Mode or the features may not operate exactly as described. It is your sole responsibility to consult and comply with all local regulations and property restrictions regarding the use of cameras.

When enabled, your vehicle's cameras and sensors (if equipped) remain powered on and ready to record suspicious activity around your vehicle when Model S is locked and in Park. Think of Sentry Mode as an intelligent vehicle security system that alerts you when it detects possible threats nearby.

If a threat is detected, Sentry Mode pulses the headlights, sounds the alarm, and displays a message on the touchscreen indicating that the cameras may be recording to inform individuals outside of the vehicle. You will receive an alert on your phone through the mobile app and footage of the event is saved to USB drive (if installed).

Sentry Mode is disabled by default. You can use voice commands or the Tesla mobile app to easily enable or disable Sentry Mode. To enable Sentry Mode using voice commands, say "Keep Tesla safe," "Keep my car safe," "Sentry on," or "Enable Sentry" (see [Voice Commands on page 131](#)).

Sentry Mode requires your Battery to be at least 20% charged. If the Battery falls below 20%, Sentry Mode turns off and the mobile app sends you a notification. Power consumption may increase when Sentry Mode is active.

NOTE: Software updates cannot be installed when Sentry Mode is turned on.

CAUTION: Do not rely on Sentry Mode to protect Model S from all possible security threats. Sentry Mode uses many factors to determine whether to activate the security alarm-- all impacts may not be detected and the alarm may not activate in all situations. While it may help deter some threats, no security system can prevent all attacks.

How to Use Sentry Mode (Camera + App)

1. Sentry Mode requires a properly formatted USB drive inserted in your vehicle's USB port (Tesla recommends using the glovebox USB port, if equipped) to store and retrieve footage. Vehicles manufactured from approximately 2020 are equipped with a pre-formatted USB drive in the glove box. There are two ways to format the USB drive:
 - Insert the USB drive into the USB port and navigate to **Controls > Safety > Format USB Drive**. Your vehicle automatically formats the USB drive for you.

- Format the USB drive on a computer. See [USB Drive Requirements for Recording Videos on page 138](#) for more information.

2. Insert the USB drive into the vehicle's USB port.
3. With your vehicle in Park, enable Dashcam by navigating to **Controls > Safety > Dashcam**.
4. Touch **Controls > Safety > Sentry Mode > On**. Once enabled, the Sentry Mode icon in the **Controls** tab turns red.



When enabled, Sentry Mode is idle, ready to sound the alarm and save a recording of the security event if triggered. See [Viewing Video Recordings on page 138](#) for information on viewing footage.

5. To silence the security alarm and audio system when the alarm is triggered, navigate to **Controls > Safety > Disable Sentry Sounds**. When enabled, Sentry Mode still sends a notification through the mobile app and saves the last 10 minutes footage.
6. To manually enable/disable Sentry Mode until the next drive, touch the Sentry Mode icon in **Controls**. Sentry Mode is Off when the icon is no longer red.



Turn Sentry Mode **Off** in **Controls > Safety > Sentry Mode** to disable for more than one drive cycle.

How to Use Sentry Mode (App Only)

When Sentry mode is enabled and a security event is detected but without a USB drive plugged into a USB port, your vehicle alerts you through the mobile app, without any camera recordings.

Sentry Mode Settings

- **Exclude specific locations**

In **Controls > Safety > Sentry Mode**, you can determine if you want Sentry Mode to *not* enable in certain locations (see [Home, Work, and Favorite Destinations on page 149](#) for more information):

- **Exclude Home:** Sentry Mode does not automatically enable at the location set as Home in your Favorites list.

- **Exclude Work:** Sentry Mode does not automatically enable at the location set as Work in your Favorites list.
- **Exclude Favorites:** Sentry Mode does not automatically enable at any location in your Favorites list.

NOTE: To recognize a location listed as Home, Work, or a Favorite, Model S must be parked within approximately 1,640 feet (500 meters) of the saved location.

To set up your Home or Work location, touch **Navigate > Set Home/Set Work**. To set up a **Favorite**, touch the star when viewing an address on the map. Manually turning Sentry Mode on or off using the touchscreen or the mobile app overrides your Home, Work, or Favorite exclusion preferences until the next time you drive.

• Set Camera-Based Detection

When **Camera-Based Detection** is enabled, Sentry Mode uses the vehicle's external cameras in addition to vehicle sensors to detect a security event while parked. If disabled, your vehicle only saves clips to the USB drive if a physical threat is detected. To adjust, touch **Controls > Safety > Sentry Mode > Camera-Based Detection**.

• View Live Camera

NOTE: View Live Camera requires premium connectivity and version 4.2.1 (or newer) of the Tesla mobile app installed on a phone that has been paired as a key to Model S.

When Sentry Mode is enabled, use the mobile app to remotely view the area surrounding Model S as seen through the exterior cameras. To enable, touch **Controls > Safety > Sentry Mode > View Live Camera via Mobile App** on the touchscreen to see what Sentry Mode records in real-time. Ensure there are no occupants in the vehicle and all doors are locked. Then, on the mobile app, navigate to **Safety > Sentry Mode > View Live Camera**.

When **View Live Camera** is actively in use, Model S periodically flashes its exterior lights and displays a message on the touchscreen to notify others that the area surrounding the vehicle is being viewed through the cameras.

View Live Camera is limited to approximately one hour (or 15 minutes for some regions) of cumulative usage per day.

If Model S is equipped with a pedestrian warning speaker (see [Pedestrian Warning System on page 78](#)), you can press and hold the microphone button on the mobile app to transmit your voice through this speaker.

You can also enable Dog Mode at the same time and switch the live camera view to see through the interior camera on the mobile app. See [Keep Climate On, Dog, and Camp on page 123](#) for more information. This feature is not supported in vehicles with Autopilot computer 2.0 or 2.5. Touch **Controls > Service > Autopilot computer** to find out which computer your vehicle has.

NOTE: If Dog and Sentry are enabled at the same time, Sentry defaults to **Disable Sentry Sounds** to protect your pet.

NOTE: Video quality can vary depending on network connectivity. No audio is captured.

NOTE: The live camera feed is fully encrypted and cannot be accessed by Tesla.

See [Viewing Video Recordings on page 138](#) for more information on viewing Sentry Mode footage.

NOTE: When the internal storage reaches full capacity, new recordings from Alert and Alarm events overwrite the older recordings.



USB Drive Requirements for Recording Videos

NOTE: The ability to format, and view video footage on, USB drives may not be available on your vehicle depending on date of manufacture and vehicle configuration.

Some features on your Model S requires the use of a USB drive (for example, Dashcam, Sentry Mode and Track Mode, if equipped) that meet these requirements:

- Minimum storage capacity of 64 GB. Use a USB drive with as much available storage as possible. Video footage can occupy a large amount of space.
- A **sustained** write speed of at least 4 MB/s. Note that *sustained* write speed differs from *peak* write speed.
- USB 2.0 compatible. If using a USB 3.0 drive, it must also support USB 2.0.
- Properly formatted (described below).

NOTE: In some market regions you can purchase recommended USB drives on <http://www.tesla.com>.

Automatically Formatting a USB Drive

Insert the USB drive into a front USB port and touch **Controls > Safety > Format USB Drive**. This automatically formats the USB drive as exFAT and creates a folder for TeslaCam and TeslaTrackMode (if equipped). The USB drive is now ready to record and save video footage.

Format USB Drive is available only when a USB drive (with one or fewer partitions) is inserted into a front USB port. Choosing **Format USB Drive** erases any existing content on the USB drive—before using this feature, move any content you want to keep to a different device.

Manually Formatting a USB Drive

If Model S is unable to format the USB drive, format it using a computer:

1. Format the USB drive as exFAT, MS-DOS FAT (for Mac), ext3, or ext4 (NTFS is currently not supported).
2. Create a base-level folder titled **TeslaCam** and for use with Track Mode (if equipped), the USB drive must contain a base-level folder called **TeslaTrackMode**. You can use one USB drive for Dashcam, Sentry Mode, Track Mode (if equipped), and audio files, but you must create separate partitions for each folder on an exFAT USB drive.
3. Once formatted, insert the USB drive into a front (or glovebox, if equipped) USB port. Do not use a rear USB port because they are only for charging devices. It may take a few seconds for the vehicle to recognize the USB drive.

4. Once recognized, ensure icons for Dashcam and Sentry Mode are available when you touch **Controls**. Your vehicle is now ready to record videos.

NOTE: You may need to first enable Sentry Mode (if equipped) by touching **Controls > Sentry**.

Viewing Video Recordings

If footage is saved, you can view the clips on the touchscreen or a computer.

When the USB drive runs out of storage space, video footage can no longer be saved. To prevent the USB drive from getting full, regularly move saved videos to another device and delete them from the USB drive.

Viewing on the Touchscreen

You can view recorded footage on the touchscreen when Model S is in Park. Touch the Dashcam icon located in the app launcher or the Dashcam icon on the **Controls** screen. Touch the menu icon in the top corner of the screen. The tabs display a list of all video clips, organized by location and timestamp. Pause, rewind, fast forward, and delete clips as needed.

Navigate to **Controls > Safety > Delete Dashcam Clips** to delete all Dashcam and Sentry Mode footage.

NOTE: Dashcam recording pauses when you launch the Viewer.

Viewing on a Computer

Insert the USB drive into a computer and navigate to the TeslaCam or TeslaTrackMode (if equipped) folder.

The TeslaCam folder contains sub-folders:

- **Saved Clips:** Contains all recordings that are saved using Dashcam.
- **Sentry Clips:** Contains camera recordings from all Sentry Mode security events. If storage space on the USB drive becomes limited, the oldest Sentry Clips are deleted to provide space for new ones. Once deleted, you cannot retrieve them.



myQ

(If equipped) Model S can intelligently connect to your myQ smart garage, which allows you to remotely monitor and control your garage door through the vehicle's touchscreen. This is convenient if you forget to close your garage door, want to allow friends and family inside, or need the garage to open or close automatically when your vehicle is detected nearby.

Follow these steps to set up myQ on your vehicle:

1. Your garage door must be myQ compatible. Use the myQ Compatibility tool (<https://www.myq.com/app/myq-compatibility>) to determine this.
2. Ensure your garage is Wi-Fi compatible. myQ uses Wi-Fi to communicate with your smart phone and vehicle. Some garages will have a Wi-Fi or myQ symbol on the hub. Your garage must have a strong Wi-Fi signal to control and monitor your garage through your vehicle.

NOTE: If your garage is not compatible, you may be able to purchase an external myQ hub to use this functionality.
3. Download the myQ app from your smart phone's app store. Use the app to set up your account information and pair the garage to your phone. myQ requires a paid subscription for use, which you can purchase in the app.
4. Check that your vehicle is running the latest available software version and has Wi-Fi or LTE connectivity.
5. Touch the garage icon at the top of the touchscreen or navigate to **Controls > Locks > myQ Connected Garage > Link Account** and follow the instructions to pair the garage with Model S. Once paired, monitoring and controlling the garage becomes available on the touchscreen, where you can customize myQ further.

For more information, questions, or troubleshooting assistance, visit www.myQ.com/Tesla.

HomeLink® Universal Transceiver

If your vehicle is equipped with the HomeLink® Universal Transceiver, you can operate up to three Radio Frequency (RF) devices, including garage doors, gates, lights, and security systems.

NOTE: Depending on date of manufacture, market region, and options selected at time of purchase, some vehicles are not equipped with a HomeLink Universal Transceiver.

WARNING: Do not use the HomeLink Universal Transceiver with a device that does not have safety stop and reverse features. Using a device without these safety features increases the risk of injury or death.

Supported Modes

HomeLink supports three different transmit modes, which is how your vehicle and the RF device communicate. Selecting a transmit mode is determined by your RF device's compatibility:

- **Standard Mode:** Use Standard Mode if your RF device is equipped with a remote control that must be used to operate the device (for example, a remote-controlled garage door). This mode is the most commonly used transmit mode for HomeLink devices.
- **D-Mode or UR-Mode:** Use D-Mode or UR-Mode if the RF device does not have a remote control, and the receiver has a "Learn" button (may also be called "Program" or "Smart"). D-Mode and UR-Mode function similarly in that Model S communicates directly with the device's receiver as opposed to the remote control.

NOTE: D-Mode is used primarily in North America whereas UR-Mode is popular in Europe, the Middle East, and Asia. To determine the mode your device is compatible with, contact HomeLink (www.homelink.com or call 1-800-355-3515).

Each of your devices can be set to a different mode. For example, your garage door can be set to Standard Mode, your front gate can be set to D-Mode, etc. To change a transmit mode, touch the HomeLink icon at the top of the **Controls** screen and select the device you want to change. Then, select **Program** and choose the desired mode for your device. Confirm by touching **Set Mode** and follow the onscreen instructions.

NOTE: Check the product information for your HomeLink device to determine which mode is compatible with your device.

Programming HomeLink

To program HomeLink®:

1. Park Model S so that the front bumper is in front of the device you want to program.

CAUTION: Your device might open or close during programming. Therefore, before programming, make sure that the device is clear of any people or objects.

2. Check that the device's remote control has a healthy battery. Tesla recommends replacing the battery in the device's remote control before Programming HomeLink.



3. Touch the HomeLink icon at the top of the **Controls** screen.
4. Touch **Create HomeLink**.
5. On the HomeLink screen, enter a name for the device, then touch **Enter** or **Add New HomeLink**.
6. Choose the mode you wish to use (Standard, D-Mode, or UR-Mode), then touch **Set Mode**.
7. Touch **Start** and follow the onscreen instructions.

NOTE: If you see a screen called “Train the receiver” while programming the device, remember that this is a time-sensitive step. After pressing the Learn/Program/Smart button on the device’s remote control, you have only approximately 30 seconds to return to your vehicle and press **Continue**, and then press the trained HomeLink device name twice. Consider having an assistant to ensure you can complete this step within 30 seconds.

8. Once your device is programmed, touch **Save** to complete the programming.
9. Ensure HomeLink works as expected. In some cases, you may need to repeat the programming process multiple times before succeeding.

Once programmed, you can operate the device by touching its corresponding HomeLink icon on the touchscreen. HomeLink remembers the location of your programmed devices. When you approach a known location, the HomeLink control on the touchscreen automatically appears. When you drive away, it disappears.

NOTE: For additional assistance or compatibility questions, contact HomeLink (www.homelink.com or call 1-800-355-3515).

Auto Opening and Closing

To operate a HomeLink device without using the touchscreen, you can automate the device to open as you approach, and close as you drive away:

1. Touch the HomeLink icon at the top of the **Controls** screen, touch **HomeLink Settings**, then choose the device you want to automate.
2. Adjust the device’s HomeLink settings as needed:
 - Select the **Auto-open when arriving** checkbox if you want the device to open as you approach.
 - Touch the arrows to specify the distance you want Model S to be from the device before it opens.
 - Select the **Auto-close when leaving** checkbox if you want the device to close as you drive away.
 - Select the **Auto-fold mirrors** checkbox if you want mirrors to fold when you arrive at the HomeLink location. This is useful for narrow garages.

- Select the **Chime for Auto-open and Auto-close** checkbox if you want Model S to sound a chime when a signal has been sent to open or close the device.

As you approach (or drive away from) a device that is set to operate automatically, the HomeLink status icon displays a count-down message to let you know when the device automatically opens or closes. In situations where you don’t want the device to automatically open or close, touch **Skip Auto-Open** or **Skip Auto-Close** at any time during the count-down message.

NOTE: Do not rely on HomeLink to ensure the device fully closes.

Resetting the Location of the HomeLink Device

If you experience situations in which you sometimes drive up to your HomeLink device and it doesn’t open, or the touchscreen does not display a notification as you approach a programmed device, you may need to reset the device’s location. To do so, park as close as possible to the HomeLink device (garage door, gate, etc.) and display the HomeLink settings page by touching the HomeLink icon at the top of the **Controls** screen. Touch the name of the device you want to reset, then touch **Reset Location**.

Deleting a Device

To delete a HomeLink device, touch the HomeLink icon at the top of the **Controls** screen, then touch **HomeLink Settings**. Touch the name of the device you want to delete, then touch **Delete**.

NOTE: You can also perform a factory reset to erase your HomeLink settings, along with all other personal data (saved addresses, music favorites, imported contacts, etc.). See [Erasing Personal Data on page 11](#).

NOTE: For security reasons, delete your HomeLink devices if you sell your Model S.

Troubleshooting HomeLink

Standard Mode

In Standard Mode, Model S records the RF signal from your HomeLink device’s remote control. The touchscreen instructs you to stand in front of the vehicle, point the device’s remote control at the front bumper, and press and hold the button until the headlights flash. When the headlights flash, Model S has learned the remote control and you can touch **Continue** on the touchscreen. If the headlights do not flash:



- Check the batteries in the remote control. It is a good idea to replace the batteries before you start programming.
- Ensure you are standing in front of Model S with the device's remote control positioned within two inches (five cm) of the Tesla emblem.
- Press and hold the button on your device's remote control until the headlights flash. In some cases you must hold the button on the remote control for up to three minutes.

NOTE: Some HomeLink remote controls require multiple short presses (approximately one second each press) instead of one long duration press. If you are unsuccessful after multiple attempts of using long presses, try repeated presses of one second each.

D-Mode and UR-Mode

In D Mode and UR-Mode, the device's receiver learns Model S. The touchscreen instructs you to press the "Learn" button (may also be called "Program" or "Smart") on the device's receiver. If this does not work, refer to the following guidelines:

- Park Model S with its bumper as close as possible to the garage door, gate, etc. that you are trying to program.
- Make sure you are pressing the receiver's Learn/Program/Smart button. For instructions on how to put the receiver into learning mode, refer to the product details provided with your RF device that you are trying to program.
- If you see a screen called "Train the receiver" while programming the device, remember that this is a time-sensitive step. After pressing the Learn/Program/Smart button on the device's remote control or receiver, you only have approximately 30 seconds to return to your vehicle, press **Continue**, then press the trained HomeLink device name twice. Consider having someone assist you with this step.
- Most devices stay in learning mode for only three to five minutes. Immediately after pressing the device's Learn/Program/Smart button, follow the instructions displayed on the vehicle's touchscreen.

For additional assistance or compatibility questions, contact HomeLink (www.homelink.com or call 1-800-355-3515).



Connecting to Wi-Fi

Wi-Fi is available as a data connection method and is often faster than cellular data networks. Connecting to Wi-Fi is especially useful in areas with limited or no cellular connectivity. To ensure fast, reliable delivery of software and map updates, Tesla recommends leaving Model S connected to a Wi-Fi network whenever possible (for example, when parked overnight).

To connect to a Wi-Fi network:

1. Touch **Controls** > **Wi-Fi icon** at the top of the **Controls** screen. Model S begins to scan and display detected Wi-Fi networks that are within range.

NOTE: If a known Wi-Fi network does not appear in the list, move Model S closer to the access point or consider using a range extender.

NOTE: When connecting to a 5GHz network (if available), check which channels are supported in your region.

5GHz Network Channels Supported

36-48	52-64	100-140	149-165
✓	✓	✓	✓

2. Select the Wi-Fi network you want to use, enter the password (if necessary), then touch **Confirm**.
3. Model S connects to the Wi-Fi network. Whenever the network is within range, Model S connects to it automatically.

You can also connect to a hidden network that isn't shown on the list of scanned networks. Just touch **Wi-Fi Settings**, enter the name of the network in the resulting dialog box, select the security setting, then touch **Add Network**.

NOTE: If more than one previously connected network is within range, Model S connects to the one most recently used.

NOTE: At Tesla Service Centers, Model S automatically connects to the Tesla Service Wi-Fi network.

Hotspots and Connectivity

You can also use a mobile hotspot or your phone's Internet connection via Wi-Fi tethering (subject to fees and restrictions of your mobile carrier) to access the internet. To remain connected to Wi-Fi when shifting into Drive or Reverse, choose the connection from the Wi-Fi settings screen, then touch **Remain connected in Drive**.



Loading New Software

Tesla updates your vehicle's software wirelessly, constantly providing new features. Tesla recommends you install software updates at the earliest opportunity on your vehicle. To ensure the fastest and most reliable delivery of software updates, leave Wi-Fi turned on and connected whenever possible. In most cases, your vehicle must be connected to Wi-Fi to start an update (see [Connecting to Wi-Fi on page 142](#)).

Software updates are not performed when the following features are active:

- Smart Preconditioning
- Keep Climate On, Dog Mode, or Camp Mode
- Sentry Mode

NOTE: On an as-needed basis, Tesla also sends software updates using a cellular connection.

 **WARNING:** Do not attempt to use the vehicle while the software is being updated. Vehicle functions, including some safety systems, may be limited or disabled when a software update is in progress and you could damage the vehicle.

When a software update is available, a yellow clock icon appears at the top of the **Controls** screen. There are three ways you can install software updates:

- Touch the yellow clock icon to display the scheduling screen, which prompts you to select a time to install the update (**Set For This Time**) or install it now (**Install Now**). Once scheduled, the yellow clock icon changes to a white clock icon until the update begins. At any time before the update begins, you can touch this clock icon to reschedule the update.
- Touch **Controls > Software** to determine if an update is available for your vehicle. If available, touch **Software Update Available** to navigate to the scheduling screen, as mentioned above.
- Start updates using the Tesla mobile app.

NOTE: Some software updates can take up to three hours to complete. Model S must be in Park while the software is being updated. To ensure the fastest and most reliable delivery of software updates, leave the Wi-Fi turned on and connected whenever possible (see [Connecting to Wi-Fi on page 142](#)).

There are two phases to a software update:

- **Download phase:** During this phase, the new update is sent wirelessly to the vehicle. If a software update is available but cannot be downloaded because the vehicle is not connected to Wi-Fi, the top of the touchscreen displays a yellow download icon. The next time the vehicle connects to Wi-Fi, the download occurs automatically. When the download is in progress, the download icon turns green.

Although you can drive while the software update is downloaded, doing so can interrupt the download if your vehicle loses the Wi-Fi connection. When the software update is fully downloaded and ready to install, a yellow clock icon displays at the top of the touchscreen.

- **Install phase:** During the install phase, you cannot drive. If plugged in, your vehicle will stop charging until the installation is complete. To start the install phase, touch the yellow clock icon at the top of the touchscreen. Touch **Install Now** to begin the installation immediately or touch **Set For This Time** to choose a start time for the installation. If you schedule the software update to install at a future time, the yellow clock icon changes to a white clock icon until the installation begins. At any time before the update installs, you can touch this clock icon to reschedule.

NOTE: Software updates will not install if Keep, Dog, or Camp mode are enabled (see [Keep Climate On, Dog, and Camp on page 123](#)).

Software Update Preferences

Tesla determines how, when, and where to send updates to vehicles based on various factors unique to each release. You can choose how quickly and often you receive software updates. To change your preference, touch **Controls > Software > Software Update Preferences** and choose either of these options:

- **Standard:** Receive software updates using the normal rollout timeframe for your region and vehicle configuration. When a software release is made available it has generally been running on other customer vehicles for a period of time.
- **Advanced:** Receive the latest software updates for your region and vehicle configuration at the earliest opportunity they are available. Keep in mind that although you receive updates at the earliest opportunity, you may not be in the first group of Tesla owners to receive the update. Choosing Advanced does not enroll your vehicle in Tesla's early access program.

NOTE: Tesla does not update software upon request for those wanting to receive the latest features and improvements. Selecting **Advanced** and consistently connecting to Wi-Fi (see [Connecting to Wi-Fi on page 142](#)) is the best way to receive the latest software updates.

NOTE: The software update screen persists until you install the update. You must install a software update as soon it becomes available. Any harm resulting from failure to install a software update is not covered by the vehicle's warranty. Failure or refusal to install updates can cause some vehicle features to become inaccessible, digital media devices to become incompatible.



Software Updates

NOTE: Tesla may update or reinstall your vehicle's software as part of the normal diagnostic, repair, and maintenance process within Service.

NOTE: Reverting to a previous software version is not possible.

If the touchscreen displays a message indicating that a software update was not successfully completed, contact Tesla.

Charging

If Model S is charging when the software update begins, charging stops. Charging resumes automatically when the software update is complete. If you are driving Model S at the scheduled update time, the update is canceled and must be rescheduled.

Viewing Release Notes

When a software update is complete, read the release notes displayed on the touchscreen to learn about changes or new features. To display release notes about the current version of your vehicle's software at any time, touch **Controls > Software > Release Notes**.

Tesla strongly recommends reading all release notes. They may contain important safety information or operating instructions for your Model S.

The Tesla mobile app allows you to communicate with Model S remotely using your iPhone® or Android™ phone.

NOTE: The information below may not represent an exhaustive list of the functions available on the Tesla mobile app. To ensure access to new and improved features, download updated versions of the mobile app as they become available.

To Use the Mobile App

To set up the Tesla mobile app to communicate with your Model S:

1. Download the Tesla mobile app to your phone.
2. Log in to the Tesla mobile app by entering your Tesla account credentials.
3. Enable mobile access to your Model S by touching **Controls > Safety > Allow Mobile Access**.

Your phone and vehicle must both be actively connected to cellular service to allow the mobile app to communicate with your vehicle. Tesla recommends that you always have a functional physical key readily available if parking in an area with limited or absent cellular service, such as an indoor parking garage.

NOTE: In the event that you require lockout assistance from Tesla due to a non-warranty issue, such as having limited cellular connectivity and having no secondary key available, your expenses are not covered under the Roadside Assistance policy.

NOTE: Tesla does not support the use of third party applications to contact Model S.

Overview

The Tesla mobile app's home screen allows you to:

- See the name of your vehicle (if you have one).
- View your vehicle's estimated range.
- See which drive mode the vehicle is in (Park, Reverse, Neutral, Drive).
- Lock or unlock your vehicle.
- Enable maximum defrost to warm your vehicle in cold conditions.
- Check your vehicle's charging information and open or close the charge port.

NOTE: Twisting red lines next to the battery icon indicate that the Battery is actively heating up (including while charging or preparing to charge).

- Open the front trunk.
- View your vehicle's odometer, VIN, and current firmware version.

Media settings appear on the mobile app to pause, play, rewind, fast forward, and adjust the volume of the media currently playing in the vehicle.

For supported video sources, send videos to Tesla Theater by sharing the link through the mobile app. Navigate to the movie, show, or video you want to play on your phone and touch the share button. Share the video with the Tesla app and it appears on the touchscreen if Model S is in Park.

Profile

In the Profile tab located at the top corner of your phone's screen (shown as an avatar icon), you can:

- Switch to a different vehicle associated with your Tesla account, if you have access to more than one.
- Navigate the Tesla Shop.
- Access the Tesla inbox.
- Manage your account information and view your order history.
- View and customize notifications you receive under the Settings tab, such as Calendar sync, when your security alarm has been triggered, charging updates, and new software updates. You can start updates from afar and check its progress.

Controls

The Controls tab allows you to do the following:

- Open the front or rear trunk.
- Lock or unlock Model S from afar.
- Open or close the charge port.
- Flash the lights or honk the horn to find where Model S is parked.
- Enable Keyless Driving.

NOTE: Keyless Driving can be used when you do not have your key or to bypass PIN to Drive in cases where you forgot your PIN or your touchscreen is unresponsive (see [PIN to Drive on page 133](#)).

- Open and close your garage door if your vehicle has a programmed HomeLink connection, if available (see [Smart Garage Connectivity on page 139](#)).
- Vent the windows.

Climate

You can check the interior temperature and heat or cool the cabin before driving (even if it's in a garage), control the seat heaters, and defrost the windshield:



Mobile App

- Enable or disable **Defrost Car** by swiping up the from bottom , which helps melt snow, ice, and frost on the windshield, windows, and mirrors.
- Enable or disable **Dog Mode** or **Camp Mode**.
- **Cabin Overheat Protection** prevents the cabin from getting too hot in scorching ambient conditions. You can choose whether you want the A/C or just the fan to run when the temperature in the cabin exceeds 105 ° F (40 °C), or the selected temperature if available. See [Climate Controls on page 119](#) for more information.
- Customizing climate controls allows you to precondition the cabin to your desired temperature and turn on or off the steering yoke (or steering wheel) and seat heaters.
- Vent the windows.
- Enable or disable Valet Mode (see [Valet Mode on page 48](#)).
- Enable or disable Speed Limit Mode and receive notifications when the vehicle's driving speed is within approximately 3 mph (5 km/h) of your selected maximum speed (see [Speed Limit Mode on page 133](#)).

Upgrades

View and purchase the latest upgrades available for your vehicle, such as full self-driving.

Service

See [Schedule Service on page 171](#) for information on how to schedule service through the mobile app.

Roadside

View roadside resources and request roadside assistance (where applicable). For more information on Roadside Assistance, see [Contacting Tesla Roadside Assistance on page 201](#).

Granting Access to a Second Driver

Add and remove access permission for an additional driver from the Tesla mobile app.

NOTE: Tesla mobile app version 4.3.1 or higher is required. Additional drivers can either use a previously registered Tesla Account or use the app to create a new Tesla Account.

To add an additional driver, in the Tesla mobile app from the vehicle home screen, go to **Security > Add Driver** and follow the onscreen instructions.

NOTE: The additional driver has access to all app features except purchasing upgrades.

To remove access, use the mobile app and go to **Security > Manage Drivers** and follow the onscreen instructions.

Using the mobile app to precondition Model S also warms the Battery as needed. The mobile app will notify you once your vehicle has reached the desired preconditioning temperature.

NOTE: In extremely cold weather or icy conditions, it is possible that your charge port latch may freeze in place. In cases where you cannot remove or insert the charge cable, or the vehicle is not Supercharging due to the latch being frozen in place, use your Tesla mobile app to enable **Defrost Car** for approximately 30-45 minutes. This can help thaw ice on the charge port latch so the charge cable can be removed or inserted.

Location

Locate Model S with directions, or track its movement across a map.

Summon

You can park or retrieve Model S using Summon (see [Summon on page 105](#)) or Smart Summon (see [Smart Summon on page 108](#)).

Schedule

Enable scheduled charging or departure, and precondition the vehicle. See [Scheduled Charging and Scheduled Departure on page 168](#) for more information.

Security

The Security tab allows you to do the following:

- Pair your phone to the vehicle (see [Phone Key on page 12](#)).
- Enable or disable Sentry Mode (see [How to Use Sentry Mode \(Camera + App\) on page 136](#)).



Map Overview

The touchscreen displays a map at all times (except when Model S is shifted into Reverse).

Use your finger(s) to interact with the map:

- To move the map in any direction, hold and drag a finger.
- To rotate the map in any direction, hold and turn two fingers.
- To zoom the map in or out, expand or pinch two fingers, respectively.

NOTE: When you rotate or move the map, your current location is no longer tracked. The message "Tracking Disabled" displays briefly next to the map orientation icon and the icon turns gray. To re-enable tracking, touch the map's orientation icon and choose North Up or Heading Up.

NOTE: The map zooms in and out automatically when a navigation route is active.

To change the orientation of the map, toggle between these options:



North Up - North is always at the top of the screen.



Heading Up - The direction you are driving is always at the top of the screen. The map rotates as you change direction. This icon has an integrated compass that indicates the direction you are driving.

NOTE: Touching this icon while navigating to a destination displays the route overview.



The route overview is available when you are navigating to a destination. The route overview also displays when you expand the turn-by-turn direction list (by swiping it downward). When you collapse the turn-by-turn direction list by swiping it upward, the map reverts back to displaying your previously chosen orientation.

Your current location is shown on the map. When you rotate or move the map, your current location is no longer tracked. To re-enable tracking, touch the map's orientation icon to choose North Up or Heading Up. Touch anywhere on the map to re-display it.

Map Display

When Model S is in Park, the following icons display on the map to allow you to customize the type of information the map displays. To access these icons when driving, touch anywhere on the map (they disappear after a few seconds).



Display/hide satellite imagery (if equipped with premium connectivity).



Display/hide traffic conditions (if equipped with premium connectivity).



Display/hide map details (such as points of interest).

Drop a pin anywhere on the map by pressing and holding your finger on a desired location. When you drop a pin, or touch an existing pin, the chosen location is centered on the map, and a popup screen provides information about the location. From this popup, you can navigate to the location, call the location (if a phone number is available) and add or remove the location from your list of favorite destinations (see [Home, Work, and Favorite Destinations on page 149](#)).



Display/hide all charging locations and a popup list that includes the city and proximity of the corresponding stations on the map. Charging locations include Tesla Superchargers, destination charging sites, third-party fast chargers, and public chargers that you have used previously. See [Charging Locations on page 150](#).

Touch the lightning bolt icons in the popup list to filter by the types of chargers based on max power.

NOTE: In some market regions, third-party fast chargers are also included on the map as dark gray pins when you display chargers.



Navigation Settings



The navigation settings icon displays when you touch ... once you start navigating to a destination.

NOTE: You can also access navigation settings by touching **Controls** > **Navigation**.

Touch the navigation settings icon to customize the navigation system to suit your preferences (the available settings vary depending on your market region and vehicle configuration):

- **Navigation Guidance:** Touch **Voice** or **Chime** to choose the type of audio you want the navigation system to use for navigation instructions.
 - Touch **-** or **+** to increase or decrease the volume of spoken navigation instructions. Decreasing all the way to the left, or touching the speaker icon, mutes the instructions. You can also mute/unmute navigation instructions by touching the speaker icon. This volume setting applies only to the navigation system's spoken instructions. Volume for Media Player and Phone is not changed.
- NOTE:** Your Model S automatically adjusts the volume based on driving speed and climate settings.
- Enable **Automatic Navigation** if you want Model S to automatically initiate a navigation destination when you get in your vehicle. Destinations are predicted based on commonly driven routes, time of day, and calendar entries (see [Automatic Navigation on page 149](#)).
 - Enable **Trip Planner** (if available in your market region) to add supercharger stops as needed. Supercharging stops are added to navigation routes with the goal of minimizing the amount of time you spend driving and charging (see [Trip Planner on page 151](#)).
 - Enable **Online Routing** to be automatically rerouted to avoid heavy traffic (see [Online Routing on page 151](#)).
 - Touch **Avoid Ferries** to be automatically routed to avoid ferries.
 - Touch **Avoid Tolls** to be automatically routed to avoid tolls.
 - Touch **Use HOV Lanes** to include High Occupancy Vehicle (HOV) lanes on navigation routes. This is particularly useful when using Navigate on Autopilot (see [Navigate on Autopilot on page 93](#)).

NOTE: *The navigation settings available can vary depending on region and vehicle configuration.*

Navigating to a Destination

To navigate to a location, touch the search bar in the corner of the map and enter a destination, send the destination from your phone, or speak a voice command (see [Voice Commands on page 131](#)). You can enter or speak an address, landmark, business, etc. When you touch the search bar, you can also choose from the following types of locations:

- A saved **Home** or **Work** location (see [Home, Work, and Favorite Destinations on page 149](#)).
- A **Charging** destination (see [Charging Locations on page 150](#)).
- A **Recent** destination (the most recent destination is listed at the top).
- A destination you have marked as a **Favorite** (see [Home, Work, and Favorite Destinations on page 149](#)).
- A popular restaurant when you're feeling **Hungry** or a popular destination (such as museums and amusement parks) when you're feeling **Lucky** (see [Lucky and Hungry on page 149](#)).

NOTE: If a data connection is not available, onboard maps allow you to navigate to any destination, but you must enter the exact and complete address.

NOTE: You can start navigation remotely from your iOS® or Android™ device using the "share" functionality on your device after allowing access to the Tesla mobile app.

When you specify a location, the touchscreen zooms out to provide an overview of the route you need to travel and displays a turn-by-turn direction list. Estimated arrival time, driving time, and mileage displays at the bottom of the direction list. Note the following about the turn-by-turn direction list:

- The Battery icon on the turn list provides a visual representation showing an estimate of how much energy will remain when you reach your destination, and how much will remain if you make a round trip back to your current location. See [Predicting Energy Usage on page 151](#).
- If charging is needed to reach your destination and Trip Planner is enabled (and available in your market region), the navigation route automatically includes Supercharger stops (see [Trip Planner on page 151](#)).
- If you won't have enough energy to reach your destination and there is no Supercharger on the route, an alert tells you that charging is needed to reach your destination.
- Each turn is preceded by the distance to the maneuver.
- To see the bottom of the list, you may need to drag the list upward.
- Touch the top of the list to minimize it.



While navigating, the map tracks your location and displays the current leg of your trip. You can display the entire route at any time by swiping down to expand the turn-by-turn direction list or touching the route overview icon.

To stop navigating, touch **Cancel**, located in the bottom corner of the turn-by-turn direction list.



If **Navigate on Autopilot** (if available in your market region) is enabled, you can turn it on for the navigation route by touching **Navigate on Autopilot** in the turn-by-turn direction list (when the feature is active, the icon is blue). **Navigate on Autopilot** is a full self-driving (Beta) feature that automatically changes lanes and steers Model S on controlled-access roads (like highways and freeways), along a navigation route. For details, see [Navigate on Autopilot on page 93](#).

Selecting an Alternate Route

Depending on market region and vehicle configuration, this feature may not be available on your vehicle. Your vehicle must be equipped with Premium Connectivity.

After you have entered a destination with one stop, the map displays up to three alternate routes. This allows you to easily compare total travel time and traffic information for each route. If you do not select a preferred route within the timeout period, the fastest route is automatically selected.

Adding Stops to a Route

After you have entered a destination, you can edit your route by adding, deleting or reordering stops. Touch the three dots at the bottom of the turn-by-turn direction list to view options to edit your route.



Add Stop allows you to add a stop by searching for a location or adding a Home, Recent or Favorite destination. You can also add a stop by touching any pin on the map and selecting **Add** from the popup.



Edit Stop allows you to set up a complex trip by adding or deleting stops on your route. Drag and drop stops by touching the equal sign to reorder your trip.

Automatic Navigation

NOTE: *Automatic Navigation may not be available in all market regions and on all vehicle configurations.*

Automatic Navigation can predict a destination when you get in your vehicle. When your phone's calendar is synced to Model S, and the calendar includes an event that takes place within two hours of when you get in your vehicle to drive, Automatic Navigation suggests the location of the event (assuming a valid address is associated with the event).

In addition, if you are Home and get in your vehicle on weekdays (Monday to Friday) from 5:00 AM to 11:00 AM, Automatic Navigation can automatically route you to your specified Work location (see [Home, Work, and Favorite Destinations on page 149](#)). Likewise, if you are at work on weekdays from 3:00 PM to 11:00 PM, Automatic Navigation can automatically route you to your specified Home location.

To enable Automatic Navigation, touch **Controls** > **Navigation** > **Automatic Navigation**. You must have your phone's calendar synced to Model S and the event must include a uniquely specified and valid address (see [Phone, Calendar, and Web Conferencing on page 126](#)).

NOTE: Navigation instructions that you enter manually, or send to Model S, override routes suggested by Automatic Navigation.

Lucky and Hungry

NOTE: *"Lucky" and "Hungry" may not be available in all market regions and on all vehicle configurations.*

In addition to navigating to a destination of your choice, Model S can also suggest nearby locations based on whether you are feeling **Hungry** or **Lucky**. In the navigation search bar, touch **Hungry** or **Lucky**. **Hungry** suggests a list of popular restaurants, whereas **Lucky** suggests a list of popular destinations (such as museums and amusement parks). Once you discover a destination that interests you, touch **Navigate** to proceed to the destination.

This feature requires the latest version of Navigation maps. To download, connect Model S to Wi-Fi and touch **Controls** > **Software** to check if an update is available (see [Map Updates on page 152](#)).

Home, Work, and Favorite Destinations

If you frequently drive to a destination, you can add it as a favorite to avoid entering the location's name or address each time. When you add a destination as a Favorite, you can easily navigate to it by touching the navigation search bar and then touching **Favorites** and choosing it from your list of favorite destinations.



Maps and Navigation



To add a destination to your Favorites list touch its pin on the map, then touch the star icon on the popup screen that appears. Enter a name (or leave as-is to accept the default name), then touch **Add to Favorites**. The star becomes solid and the destination is included on your Favorites list.

To delete a Recent or Favorite destination, touch it on the destination list and hold it down briefly until the **X** appears. Then touch the **X** to delete it from the list.

Home and **Work** locations also display under the navigation search bar. Touch to set an address to the corresponding location. After entering the address, touch **Save as Home** or **Save as Work**. Then simply touch these shortcuts whenever you want to navigate home or to work.

To change or delete the corresponding address, press and hold the **Home** or **Work** icon. A popup allows you to enter a new address and **Save as Home** or **Save as Work**. Or touch **Clear Home** or **Clear Work** to remove associated addresses entirely.

NOTE: Based on your usage patterns, Model S may prompt you to save a location as Home or Work.

NOTE: Once a Home or Work location is saved, Model S may prompt you to navigate to your Work location in the mornings and to your Home location in the evenings and provide an estimated driving time based on current traffic conditions. See [Automatic Navigation on page 149](#).

For security reasons, if you sell Model S, it is recommended that you delete your Home and Work locations. You can delete these individually or you can perform a factory reset to erase all personal data (touch **Controls** > **Service** > **Factory Reset**).

Charging Locations

To display charging locations on the map, touch the map's search bar, then touch **Charging**. Charging locations are shown in a list (with the closest charging location at the top of the list) and represented by corresponding pins on the map. Touch a pin to display more information, navigate to it, or mark it as a favorite.

Touch the lightning bolt icons to specify the types of charging locations you want the map to include (by default, the map displays only superchargers):



Touch to include destination chargers.



Touch to include standard superchargers.



Touch to include high-powered superchargers.

NOTE: In some market regions, third-party fast chargers are also included as dark gray pins when you choose to display all charging stations.

The appearance of a charging location's pin reveals status information about the location. Touch the pin to display details.



The Supercharger location is operational and the number displayed on the pin represents the number of available Supercharger stalls.

NOTE: A Supercharger located on your current navigation route is colored black (or white, if the touchscreen is in night mode).



The Supercharger location is experiencing a high volume of users and you may need to wait before charging.



The Supercharger location may be operating at a reduced capacity.



The Supercharger location may be closed.



The Supercharger location has no data available but should be operational.



The location is either a destination charging location, a third-party fast charger, or a public charging station that you have previously used. Touch to display more information such as usage restrictions and available charge current.



NOTE: When the map is zoomed out and more than one destination charging location is available in an area, the pin is round and displays the number of stations. Touch the pin to zoom in. Then you can touch an individual pin for details about a specific location.

Touch a charging location's pin to display a popup from which you can:

- Determine its exact location and approximate distance from your current location.
- View amenities that are available at the charging location, including restrooms, restaurants, lodging, shopping, and Wi-Fi. On a supercharger popup, touch an amenity icon to search the surrounding area for the associated amenity.
- Touch the arrow icon to navigate to the charging location.

NOTE: When navigating to a Supercharger (or third-party fast charger in some regions), Model S preconditions the Battery to prepare for charging. This ensures you arrive with an optimal Battery temperature, reducing the amount of time it takes to charge. In some circumstances (such as cold weather), it is normal for the motor(s) and components to make noise as it generates heat to warm the Battery (see [Charging on page 79](#)).

- View how busy a Supercharger location typically is during different times of the day, along with corresponding charging fees.

Predicting Energy Usage

When navigating to a destination, Model S helps you anticipate your charging needs by calculating the amount of energy that remains when you reach your destination. When navigating, the map displays this calculation next to the Battery icon on the turn-by-turn direction list (see [Navigating to a Destination on page 148](#)). When the turn-by-turn direction list is compressed, touch the top of the list to expand it.

The calculation that predicts how much energy you will use is an estimate based on driving style (predicted speed, etc.) and environmental factors (elevation changes, wind speed and direction, ambient and forecasted temperatures, air density and humidity, etc.). As you drive, Model S continuously learns how much energy it uses, resulting in improved accuracy over time. It is important to note that Model S predicts energy usage based on the driving style of the individual vehicle. For example, if you drive aggressively for a period of time, future range predictions will assume higher consumption. Also, if you purchase a used Tesla vehicle, it is recommended that you perform a factory reset (**Controls > Service > Factory Reset**) to ensure the predicted energy is as accurate as possible.

Throughout your route, Model S monitors energy usage and updates the estimate of energy remaining at the end of your trip. A popup warning displays on the turn-by-turn direction list in these situations:

NOTE: Some factors that contribute to predicted energy (such as forecasted temperatures and wind speed) are available only when Model S has internet connectivity.

- A yellow warning displays when you have very little energy remaining to reach your destination, requiring you to drive slowly to conserve energy. For tips on conserving energy, see [Getting Maximum Range on page 169](#).
- A red warning displays when you must charge to reach your destination.

To determine if you have enough energy for a round trip, touch the Battery icon on the turn-by-turn direction list to display an estimated calculation of your round trip energy usage.

Online Routing

Model S detects real-time traffic conditions and automatically adjusts the estimated driving and arrival times. In situations where traffic conditions will delay your estimated time of arrival and an alternate route is available, the navigation system can reroute you to your destination. You can also specify the minimum number of minutes that must be saved before you are rerouted. To turn this feature on or off, touch the map's settings icon (see [Navigation Settings on page 148](#)), then touch **Online Routing**.

Trip Planner

Trip Planner (if available in your market region) helps you take longer road trips with confidence. If reaching your destination requires charging, Trip Planner routes you through the appropriate Supercharger locations. Trip Planner selects a route and provides charging times to minimize the amount of time you spend driving and charging. To enable Trip Planner, touch the map's settings icon (see [Navigation Settings on page 148](#)), then touch **Trip Planner**.

When Trip Planner is enabled and charging is required to reach your destination, the turn-by-turn direction list includes Supercharger stops, recommended charging times at each Supercharger, and an estimate of how much energy will be available when you arrive at the Supercharger location.

NOTE: When navigating to a Supercharger or, in some regions, a third-party fast charger using Trip Planner, Model S may allocate some energy to pre-heat the Battery to arrive at the Supercharger or third-party fast charger with an optimal Battery temperature. This reduces charging time (see [Charging on page 79](#)).



Maps and Navigation

To remove Supercharger stops and display directions only, touch **Remove all charging stops** at the bottom of the turn-by-turn direction list. If you remove charging stops, the turn-by-turn direction list may display an alert indicating that charging is needed to reach your destination. To add Supercharger stops back to the turn-by-turn direction list, touch **Add charging stops**.

While charging at a Supercharger, the charging screen displays the remaining charging time needed to drive to your next Supercharger stop, or destination (if no further charging is needed). If you charge for a shorter or longer length of time, charging time at subsequent Supercharger stops is adjusted accordingly.

NOTE: You can also use the mobile app to monitor remaining charging time needed.

NOTE: If a Supercharger on your navigation route experiences an outage, Trip Planner displays a notification and attempts to reroute you to a different Supercharger location.

If Trip Planner estimates that you won't have enough energy for your round trip, and there are no Superchargers available on your route, Trip Planner displays an alert at the top of the turn-by-turn direction list notifying you that charging is needed to reach your destination.

Map Updates

As updated maps become available, they are automatically sent to Model S over Wi-Fi. To ensure you receive them, periodically connect Model S to a Wi-Fi network (see [Connecting to Wi-Fi on page 142](#)). The touchscreen displays a message informing you when new maps are installed.

Overview

The Media Player displays on the touchscreen and is used to play various types of media. You can drag Media Player upward to expand it (allowing you to browse), and downward to minimize it so that just the Miniplayer displays. The convenient Miniplayer, which occupies the least amount of space on the touchscreen, displays what's currently playing and provides only the basic functions associated with what's playing. You can also drag Media Player to display on the left or right side of the touchscreen.

Media Player displays content and options associated with the app (or source) you choose from the app launcher, or from the dropdown list that displays on the Media Player when you expand it:

NOTE: *Media apps vary depending on market region and vehicle configuration. Some apps described may not be available in your market region, or may be replaced by different ones.*



Radio: Choose from a list of available radio stations or touch the numeric keypad to directly tune the radio to a specific frequency. Touch the next or previous arrows to move from one frequency to the next (or previous).



Bluetooth: Play audio from a bluetooth-connected phone or USB device (see [Playing Media from Devices on page 154](#)).



Streaming: Play the audio streaming service available in your market region (for example, Slacker Radio), if equipped.



Spotify: Play audio available on Spotify.



Apple Music: Play audio available on Apple Music.

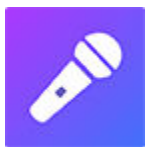

Karaoke (if equipped): Sing along with various songs (see [Karaoke on page 154](#)).



Tuneln: Play audio available on Tuneln.

Tidal: Play audio available on Tidal.



NOTE: You can show or hide any media app/source. See [Media Settings on page 153](#).

When listening to internet radio or a music streaming service, the options available on the Media Player screen vary depending on what you are listening to. Touch the next (or previous) arrows to play the next (and in some cases previous) available station, episode, or track. You can also play next/previous using the left scroll button on the steering yoke (or steering wheel).

Streaming services are available only when a data connection is available (for example, Wi-Fi or Premium Connectivity). For some media services, you can use a default Tesla account. For others, you may need to enter account credentials the first time you use it.

NOTE: Instead of launching a different media app, you can change the source from within the Media Player screen by choosing a source from the dropdown list.

NOTE: You can use voice commands to adjust media settings and preferences, such as volume control, playing certain songs, or switching the media source (see [Voice Commands on page 131](#)).

Volume Controls

Roll the scroll button on the left side of the steering yoke (or steering wheel) up or down to increase or decrease volume respectively. The scroll button adjusts the volume for media, voice commands, and phone calls.

NOTE: Your Model S automatically adjusts the volume based on driving speed and climate settings.

You can also adjust the volume by touching the arrows associated with the speaker icon on the bottom corner of the touchscreen.

To mute the volume, press the left scroll button. Press again to unmute.

NOTE: Pressing the left scroll button during a phone call mutes both the sound and your microphone.

NOTE: If you're playing media and you receive a phone call, or the navigation system is speaking directions, the volume of what you are listening to is temporarily muted.

Media Settings

NOTE: *The settings available vary depending on market region. Also, a setting may not be applicable to all audio sources.*



Media



When displaying an audio source screen, press the settings icon located in the search bar to access audio settings.

You can adjust these settings:

- **Tone:** Drag the sliders to adjust the subwoofer and any of the five frequency bands (Bass, Bass/Mid, Mid, Mid/Treble, and Treble). If equipped with premium audio, you can adjust the level of sound immersion to make your music experience more engaging by dragging the immersive sound slider according to your preferences.
- **Balance:** Drag the center circle to the location in Model S where you want to focus the sound.
- **Options:** Set preferences for optional features. For example, you can turn **DJ Commentary**, **Explicit Content** and **Allow Mobile Control** on or off.
- **Sources:** Displays all available media sources and allows you to choose whether you want to show or hide each source. You may want to hide media sources that you never use. Once hidden, the media source does not appear on the drop down list in Media Player, nor will it appear in the app tray when you touch the App Launcher. You can re-display a hidden media source at any time by returning to this settings screen.

Searching Audio Content



Touch Media Player's magnifying glass icon to search for a particular song, album, artist, podcast, or station. You can also use voice commands to search hands-free (see [Voice Commands on page 131](#)).

SiriusXM Satellite Radio (if equipped)

If equipped, you can listen to SiriusXM, a subscription-based satellite radio service. To receive satellite radio channels, you must provide the radio service provider with the radio ID for your touchscreen.

To display the radio ID:

1. Touch the radio source icon, then select SiriusXM from the list.
2. Move the channel selector to channel 0.
3. The Radio ID displays in the station information area.

To select a SiriusXM channel, you can either manually scroll through channel numbers, or you can browse channels by category.

Caraoke

In addition to various streaming services, your vehicle may be equipped with Caraoke. To access Caraoke, navigate to Media Player and select the drop down menu to change the media source to Caraoke. Or add Caraoke as an app in the app launcher. You can browse through various songs and select the song you want to sing. Touch the microphone icon to enable or disable the song's main vocals. Disabling the microphone leaves only the song's instrumentals and background vocals. Touch the lyrics icon (located next to the microphone icon) to enable or disable the song's lyrics.

NOTE: Depending on vehicle configuration and market region, Caraoke may not be available on your vehicle.

 **WARNING:** Never read Caraoke lyrics while driving. You must always pay attention to the road and traffic conditions. When driving, the Caraoke lyrics are intended only for use by a passenger.

Recents and Favorites

For most source content, recents and favorites display at the top for easy access.



To add a currently playing station, podcast, or audio file to your Favorites list, touch the **Favorites** icon on Media Player.



To remove an item as a favorite, touch the highlighted **Favorites** icon. You can also remove multiple favorites by expanding Media Player to show all favorites for the applicable type of source content. Then press and hold any favorite. An **X** appears on all favorites and you can then touch the **X** to remove them from your Favorites list.



Your recently played selections are updated continuously so you don't need to remove them.

NOTE: Selections you play on FM (if equipped) radio are not included in the Recents list.

Playing Media from Devices

You can play audio files from a Bluetooth-connected device (like a phone) or a USB-connected flash drive. When you connect a Bluetooth or USB device, Media Player includes the device as a media source.

USB Connected Flash Drives

Insert a flash drive into a front USB port (see [USB Ports on page 25](#)). Touch **Media Player > USB**, and then touch the name of the folder that contains the song you want to play. After you display the contents of a folder on the USB connected flash drive, you can touch any song in the list to play it. Or use the previous and next arrows in Media Player to scroll through your songs. You can also scroll to next/previous songs using the left scroll button on the steering yoke (or steering wheel).

NOTE: To play media from a USB connection, Model S recognizes flash drives only. To play media from other types of devices (such as an iPod), you must connect the device using Bluetooth.

NOTE: Media Player supports USB flash drives with exFAT formatting (NTFS is not currently supported).

NOTE: Use a USB port located at the front of the center console. The USB connections at the rear of the console are for charging only.

Bluetooth Connected Devices

If you have a Bluetooth-capable device such as a phone that is paired and connected to Model S (see [Pairing a Bluetooth Phone on page 126](#)), you can play audio files stored on it. Choose Media Player's **Phone** source, touch the name of your Bluetooth-connected device, then touch **CONNECT**.

Your Bluetooth device begins playing the audio file that is currently active on your device. If no audio file is playing, use your device to choose the audio file you want to listen to. When the chosen file begins to play, you can then use Media Player's next and previous icons (or use the left scroll button on the steering yoke (or steering wheel)) to play other tracks.

NOTE: To play media from a Bluetooth-connected device, ensure that access to the device's media is turned on (see [Pairing a Bluetooth Phone on page 126](#)).

Overview

NOTE: Entertainment options vary by market region.

The touchscreen displays the Entertainment screen when you choose any of the following apps:



Theater: Play various video streaming services (such as Netflix, YouTube, Hulu, etc.) while parked. Available only if Model S is connected to WiFi, or is equipped with premium connectivity and a cellular signal is available.



Arcade: Want to game? Depending on the game, you may need to use the steering yoke (or steering wheel) buttons or a Bluetooth or USB controller to play. See [Gaming Controllers on page 157](#).



Toybox: Play in the Toybox while parked.

WARNING: Use these features only when Model S is parked. Always pay attention to road and traffic conditions when driving. Using these features while driving is illegal and very dangerous.

NOTE: You can also use voice commands to access these features (see [Voice Commands on page 131](#)).

Toybox

Your vehicle's toybox includes features that can be fun to use. Here's an example of the types of features you can find in Toybox:

Select This...	To Do This...
Boombox	If Model S is equipped with a Pedestrian Warning System, delight pedestrians with a variety of sounds from your vehicle's external speaker while in Park. See Boombox on page 157 for more details. NOTE: Check local laws before using Boombox in public areas.
Emissions	Fun can come in surprising ways. Select your preferred fart style and target seat. Use your turn signal or press the left scroll wheel when you're ready to "release" your prank. For those lucky vehicles equipped with a Pedestrian Warning System, you can choose to broadcast externally when your vehicle is parked. But wait-- the fun doesn't stop there! Use the mobile app to conduct remote emissions testing by touching and holding any of the four quick control buttons and selecting the fart button.
Light Show	Park outside, turn the volume up, roll down your windows, then enjoy the show. Schedule the light show for a future time and customize the song to surprise your loved ones.
Mars	The map shows your Model S as a rover on the Martian landscape, and the About Your Tesla box displays SpaceX's interplanetary spaceship.
Rainbow Charge Port	When Model S is locked and charging, press the button on the mobile connector ten times in quick succession. Neat, huh?
Romance	You can't roast chestnuts by an open fire in your car, but you can still cozy up with your loved ones by this virtual fireplace. Cue the music and get your romance on!
Sketchpad	Channel your inner Picasso. Show us what you got! Touch Publish to submit your artistic compositions to Tesla for critiquing.



TRAX	It's never too late to follow your dream of becoming a world-famous DJ. With TRAX, you can turn your vehicle into your own personal music studio. While in Park, choose from an array of instruments and unique sounds to create the next hit song. Microphone and headset are not included.
The Answer to the Ultimate Question of Life, The Universe, and Everything	Rename your vehicle to 42 (touch Controls > Software and touch the vehicle's name). Notice the new name.
Car Colorizer	Change the color of your Model S on the touchscreen. Touch the color swatch next to the vehicle name and customize the paint, tone, and more.

Boombox

NOTE: Boombox is available only on vehicles equipped with the Pedestrian Warning System (PWS).

NOTE: Check local laws before using Boombox in public places.

Using Boombox, you can play sound externally through the Pedestrian Warning System (PWS) speaker when Model S is in Park. For example:

- **Play current media.**
- Use **Megaphone** to project a modulated version of your voice.
- Play the first five seconds of any sound from a compatible USB device.

NOTE: If Camp mode is enabled in Climate Controls, you can exit the car and use the Tesla app to control the volume.

Prepare a USB drive for Boombox

Follow these steps to add up to five custom Boombox sounds:

1. On a computer, format a USB drive to exFAT, MS-DOS FAT (for Mac), ext3, or ext4 (NTFS is currently not supported).
2. Create a folder on the USB drive called **Boombox**.
NOTE: The USB drive can only contain one folder. For example, it cannot be shared with Dashcam.
3. Add .wav and .mp3 audio files to the folder. Although you can add as many files as the USB drive's capacity allows, you can only select from the first five, as listed alphabetically. File names, of any length, can contain upper or lower case alpha characters (a-z/A-Z), numbers from 0-9, periods (.), dashes (-), and underscores (_).
4. Plug the USB drive into a front USB port.
5. Choose a sound from the USB drive by selecting from the **Boombox** dropdown menu.

Uninstall Games

Uninstalling games is useful if you want to free up your vehicle's onboard storage. To uninstall a game, navigate to **Arcade**, select the game you wish to uninstall, then touching **Uninstall**. Once you uninstall a game, you must download it before you can play the game again. to play the game again.

Gaming Controllers

You can pair Bluetooth Classic gaming controllers to Model S by following the same steps as pairing your phone (see [Pairing a Bluetooth Phone on page 126](#)). After pairing, the controller automatically connects to the vehicle. Once connected, you can the controller to play select games. Model S supports up to two Bluetooth devices at a time (such as two controllers, or one phone and one controller).



Theater, Arcade, and Toybox

For vehicles manufactured prior to approximately November 1, 2021, you can connect USB-compatible game controllers to the front USB ports in the vehicle's center console. For vehicles manufactured after approximately November 1, 2021, you must use the glovebox USB port.



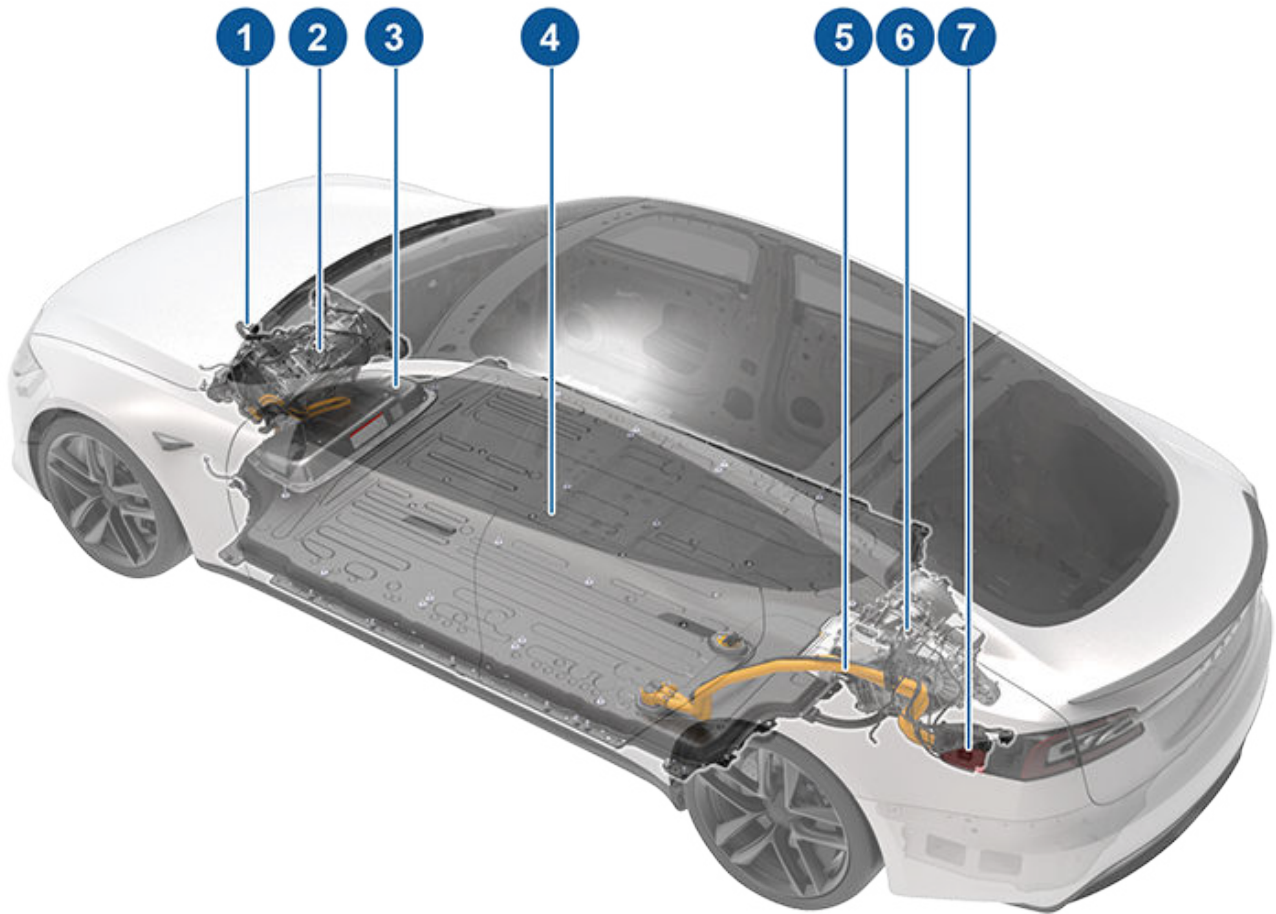

High Voltage Components



1. Heat Pump Assembly
2. Front Drive Unit
3. Service Access Panel for High Voltage Components (Penthouse)
4. High Voltage Battery
5. High Voltage Busbars
6. Rear Drive Unit
7. Charge Port

NOTE: Plaid version not shown.

-  **WARNING:** The high voltage system has no user serviceable parts. Do not disassemble, remove or replace high voltage components, cables or connectors. High voltage cables are typically colored orange for easy identification.
-  **WARNING:** Read and follow all instructions provided on the labels that are attached to Model S. These labels are there for your safety.
-  **WARNING:** In the unlikely event that a fire occurs, immediately contact your local fire emergency responders.



Charging Equipment

Charging equipment designed specifically to charge your Model S is available from Tesla.

For information on the charging equipment **available for your region**, go to <http://shop.tesla.com>.

- A Wall Connector, which installs in your parking space, is the fastest way to charge your vehicle for daily use.
- A Mobile Connector allows you to plug into most commonly used power outlets. When using the Mobile Connector, attach the smart adapter (if required) to the Mobile Connector before plugging it in to the power outlet, and then plug in your vehicle.
- Tesla also offers adapters that allow you to plug into the most commonly used public charging stations in your region. At a public charge station, first attach the adapter to the station's charging connector and then plug in your vehicle.



About the High Voltage Battery

Model S has one of the most sophisticated battery systems in the world. The most important way to preserve the high voltage Battery is to **LEAVE YOUR VEHICLE PLUGGED IN** when you are not using it. This is particularly important if you are not planning to drive Model S for several weeks.

NOTE: When left idle and unplugged, your vehicle periodically uses energy from the Battery for system tests and recharging the low voltage battery when necessary.

There is no advantage to waiting until the Battery's level is low before charging. In fact, the Battery performs best when charged regularly.

NOTE: If you allow the Battery to discharge to 0%, other components may become damaged or require replacement (for example, the low voltage battery). In these cases, you are responsible for repair and/or transporting expenses. Discharge-related expenses are not covered by the warranty or under the Roadside Assistance policy.

The peak charging rate of the Battery may decrease slightly after a large number of DC Fast Charging sessions, such as those at Superchargers. To ensure maximum driving range and Battery safety, the Battery charge rate is decreased when the Battery is too cold, when the Battery's charge is nearly full, and when the Battery conditions change with usage and age. These changes in the condition of the Battery are driven by battery physics and may increase the total Supercharging duration by a few minutes over time. You can minimize the amount of charge time by using Trip Planner (if available in your market region) to warm the Battery while driving to a Supercharger. See [Trip Planner on page 151](#) for more information.

Battery Care

Never allow the Battery to fully discharge. Even when Model S is not being driven, its Battery discharges very slowly to power the onboard electronics. The Battery can discharge at a rate of approximately 1% per day, though the discharge rate may vary depending on environmental factors (such as cold weather), vehicle configuration, and your selected settings on the touchscreen. Situations can arise in which you must leave Model S unplugged for an extended period of time (for example, at an airport when traveling). In these situations, keep the 1% in mind to ensure that you leave the Battery with a sufficient charge level. For example, over a two week period (14 days), the Battery may discharge by approximately 14%.

Discharging the Battery to 0% may result in damage to vehicle components. To protect against a complete discharge, Model S enters a low-power consumption mode when the displayed charge level drops to approximately 0%. In this mode, the Battery stops

supporting the onboard electronics and auxiliary low voltage battery. Once this low-power consumption mode is active, immediately plug in Model S to prevent a jump start and low voltage battery replacement.

NOTE: If Model S is unresponsive and does not unlock, open, or charge, the low voltage battery may be discharged. In this situation, try jump starting the low voltage battery (see [Jump Starting on page 207](#)). If the vehicle is still unresponsive, contact Tesla.

Temperature Limits

For better long-term performance, avoid exposing Model S to ambient temperatures above 140° F (60° C) or below -22° F (-30° C) for more than 24 hours at a time.

Energy Saving Feature

Model S has an energy-saving feature that reduces the amount of energy being consumed by the displays when Model S is not in use. On newer vehicles, this feature is automated to provide an optimal level of energy saving. However, on older vehicles, you can control the amount of energy being consumed by the displays by touching **Controls > Display > Energy Saving**. For more information on maximizing range and saving energy, see [Getting Maximum Range on page 169](#).

Submerged Vehicle

As with any electric vehicle, if your Tesla has been exposed to flooding, extreme weather events or has otherwise been submerged in water (especially in salt water), treat it as if it's been in an accident and contact your insurance company for support. Do not attempt to operate the vehicle before Tesla Service has inspected it, but you should tow or move it away from any structures.

NOTE: Damage caused by water is not covered under warranty.

Battery Warnings and Cautions

 **WARNING:** The Battery has no parts that an owner or a non-Tesla authorized service technician can service. Under no circumstances should you open or tamper with the Battery. Always contact Tesla to arrange for Battery servicing.

 **CAUTION:** If the Battery's charge level falls to 0%, you must plug it in. If you leave it unplugged for an extended period, it may not be possible to charge or use Model S without jump starting or replacing the low voltage battery. Leaving Model S unplugged for an extended period can also result in permanent Battery damage. If you are unable to charge Model S after attempting to jump start the low voltage battery, contact Tesla immediately.



High Voltage Battery Information

 **CAUTION:** The Battery requires no owner maintenance. Do not remove the coolant filler cap and do not add fluid. If the instrument panel warns you that the fluid level is low, contact Tesla immediately.

 **CAUTION:** Do not use the Battery as a stationary power source. Doing so voids the warranty.



Opening the Charge Port

The charge port is located on the left side of Model S, behind a door that is part of the rear tail light assembly. Park Model S to ensure that the charge cable easily reaches the charge port.

With Model S in Park, press and release the button on the Tesla charge cable to open the charge port door.

NOTE: If the charge cable is close to the charge port door, you can press the button on the charge cable to open the charge port door even when Model S is locked or a recognized key is not within range.



You can also open the charge port door using any of these methods:

- On the touchscreen, touch **Controls** and touch the Charge Port icon (lightning bolt).
- On the touchscreen, navigate to **Controls > Charging > Open Charge Port**.
- Press the charge port door when Model S is unlocked.
- On the key fob, hold down the rear trunk button for 1-2 seconds.
- Use voice commands to open the charge port door (see [Voice Commands on page 131](#)). You can also use voice commands to close the charge port door, and begin or stop charging.

NOTE: The following image is provided for demonstration purposes only. Depending on market region and date of manufacture, your charge port may be slightly different.



NOTE: The charge port lights up white when you open the charge port door. If you do not insert a charge cable into the charge port within a few minutes after opening the charge port door, the charge port door closes. If this happens, use the touchscreen to open the charge port door again.

NOTE: In extremely cold weather or icy conditions, it is possible that your charge port latch may freeze in place. In cases where you cannot remove or insert the charge cable, or the vehicle is not Supercharging due to the latch being frozen in place, use your Tesla mobile app to precondition your vehicle on **HI** for approximately 30-45 minutes (you must use your mobile app to precondition the vehicle; setting your climate to **HI** using the touchscreen is not effective). This can help thaw ice on the charge port latch so the charge cable can be removed or inserted.

CAUTION: Do not try to force the charge port door open.

Plugging In

If desired, use the touchscreen to change the charge limit and the charging current (see [Charge Settings on page 165](#)).

To charge at a public charging station, plug the appropriate adapter into the vehicle's charging port, and then connect the station's charging connector to the adapter. The most commonly used adapter(s) for each market region are provided. Depending on the charging equipment you are using, you may need to start and stop charging using a control on the charging equipment.

If you are using the Mobile Connector, plug into the power outlet before plugging in Model S.

Align the connector to the charge port and insert fully. When the connector is properly inserted, charging begins automatically after Model S:

- Engages a latch that holds the connector in place;
- Shifts into Park (if it was in any other drive mode);
- Heats or cools the Battery, if needed. If the Battery requires heating or cooling, you may notice a delay before charging begins.

NOTE: Whenever Model S is plugged in but not actively charging, it draws energy from the wall outlet instead of using energy stored in the Battery. For example, if you are sitting in Model S and using the touchscreen while parked and plugged in, Model S draws energy from the wall outlet instead of the Battery.

CAUTION: The connector end of the charge cable can damage the paint if you drop it onto Model S.

Charging Instructions

Charge Port Light

- **WHITE (OR LIGHT BLUE):** The charge port door is open. Model S is ready to charge and the connector is not inserted, or the charge port latch is unlocked and the connector is ready to be removed.
- **BLUE:** Model S detects that a connector has been plugged in.
- **BLINKING BLUE:** Model S is communicating with the connector. Either Model S is preparing to charge, or a charging session is scheduled to begin at a specified future time.
- **BLINKING GREEN:** Charging is in progress. As Model S approaches a full charge, the frequency of the blinking slows.
- **SOLID GREEN:** Charging is complete.
- **SOLID AMBER:** The connector is not fully plugged in. Realign the connector to the charge port and insert fully.
- **BLINKING AMBER:** Model S is charging at a reduced current (AC charging only).
- **RED:** A fault is detected and charging has stopped. Check the instrument panel or touchscreen for an alert.

Charging Status

Charging status displays on the instrument panel when the charge port door is open.



1. **Time remaining:** The estimated time remaining to charge to your set limit (see [Charge Settings on page 165](#)).
NOTE: When charging to 100%, the vehicle may continue to charge with low power when charging is displayed as complete. This is expected operation. Because the added energy beyond this point is low, it is usually not beneficial to continue charging.
2. **Charging:** The current power of the charger.
3. **Charging rate:** The maximum current available from the attached charge cable.
4. **Range gained:** Estimated increase in driving distance achieved in the charging session.
5. **Driving distance:** Displays the total estimated driving distance or energy percentage (depending on your display setting) available.
NOTE: To change how energy units are displayed, touch **Controls > Display > Energy Display**.
6. **Charge status:** Charge status messages (such as Supercharging, Scheduled Charging) display here (see [Scheduled Charging and Scheduled Departure on page 168](#)).



During Charging

During charging, the charge port light pulses green, and the touchscreen displays real-time charging status. The frequency at which the green charge port light pulses slows down as the charge level approaches full. When charging is complete, the light stops pulsing and is solid green.

NOTE: If Model S is locked, the charge port light does not light up.

If the charge port light turns red while charging, a fault is detected. Check the instrument panel or touchscreen for an alert describing the fault. A fault can occur due to something as common as a power outage. If a power outage occurs, charging resumes automatically when power is restored.

NOTE: The thermal system may produce steam under certain conditions. For example, odorless steam can come from the front of your vehicle while charging at a Supercharger in cold temperature. This is normal and not a cause for concern.

NOTE: It is normal to hear sounds during charging. Particularly at high currents, the refrigerant compressor and fan operate as needed to keep the Battery cool.

NOTE: Air conditioning performance is generally not affected by charging. However, in some circumstances (for example, charging at high currents during a particularly warm day), the air coming from the vents may not be as cool as expected and a message displays on the instrument panel. This is normal and ensures that the Battery stays within an optimum temperature range while charging to support longevity and optimum performance.

⚠ WARNING: Never spray liquid at a high velocity (for example, a pressure washer) towards the charge port while charging. Doing so can result in serious injury or damage to the vehicle, charging equipment, or property.

Stopping Charging

Stop charging at any time by disconnecting the charge cable or touching **Stop Charging** on the touchscreen.

NOTE: To prevent unauthorized unplugging of the charge cable, the charge cable latch remains locked and Model S must be unlocked or able to recognize your key before you can disconnect the charge cable.

To disconnect the charge cable:

1. Press and hold the button on the connector handle to release the latch.

NOTE: You can also release the latch using the touchscreen or mobile app, or by pressing and holding the rear trunk button on the key fob. If your vehicle is equipped with a motorized charge port, you can also press the button to the left of the charge port to release the latch.

2. Pull the connector from the charge port. The charge port door automatically closes.

To disconnect the charge cable when using an adapter at a public charge station:

1. Unlock Model S.
2. While holding the public charging handle in one hand and the adapter in the other hand, press and hold the button on the public charging handle and pull both outwards, removing the handle and adapter at the same time.

NOTE: If the charging station handle separates from the adapter, leaving the adapter in Model S, use the touchscreen to unlock the charge port.

3. Press and hold the button on the charging handle again to release the adapter from the public charging handle.

NOTE: The charge port door automatically closes within approximately 10 seconds of removing the connector from the charge port.

⚠ CAUTION: Tesla strongly recommends leaving Model S plugged in when not in use. This maintains the Battery at the optimum level of charge.

Charge Settings

Access charge settings by touching **Controls > Charging** when Model S is in Park.

When charging, you can also touch the charge icon on the touchscreen to access charge settings.

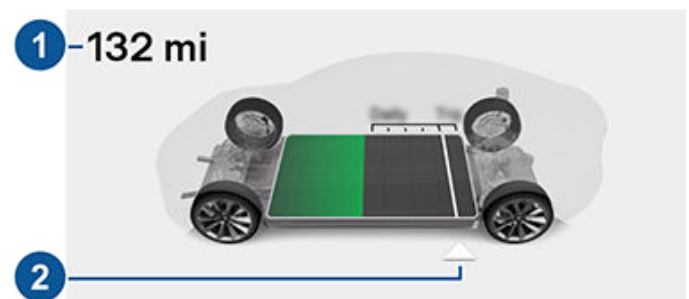

1. **Driving distance:** Displays the total estimated driving distance available.



Charging Instructions

2. **Set limit:** Adjust the charge limit by dragging the arrow below the battery to indicate the level of charging you want. The setting you choose applies to immediate and scheduled charging sessions.

NOTE: A portion of the battery image may appear blue. This indicates that a small portion of the energy stored in the battery is not available because the battery is cold. This is normal and no reason for concern. When the battery warms up, the blue portion no longer displays.

You can further adjust charge settings:

- **Open Charge Port, Unlock Charge Port and Stop Charging:** When not charging, touch **Open Charge Port** or **Unlock Charge Port** to open the charge port door or to unlock the charge cable from the charge port. Use **Stop Charging** when you are finished charging.
- **Charge current at this location:** The current automatically sets to the maximum current available from the attached charge cable, unless it was previously reduced to a lower level. If needed, touch **-** or **+** to change the current (for example, you may want to reduce the current if you are concerned about overloading a domestic wiring circuit shared by other equipment). It is not possible to set the charging current to a level that exceeds the maximum available from the attached charge cable. When you change the current, Model S remembers the location. If you charge at the same location, you do not need to change it again.

NOTE: If Model S is charging and detects unexpected fluctuations in input power, the charging current is automatically reduced by 25%. For example, a 40 amp current is reduced to 30 amps. This automatic current reduction increases robustness and safety in situations when an external problem exists (for example, a home wiring system, receptacle, adapter or cord is unable to meet its rated current capacity). As a precaution, when Model S automatically reduces current, it saves the reduced current at the charging location. Although you can manually increase it, Tesla recommends charging at the lower current until the underlying problem is resolved and the charging location can provide consistent power.

- **Schedule:** Depending on the setting you select by touching **Switch to Scheduled Departure/Scheduled Charging**, this displays either a departure time for when the vehicle should be preconditioned and/or charged by or a time to start charging (see [Scheduled Charging and Scheduled Departure on page 168](#)).
- **Supercharging:** Displays supercharger usage fees, the location, the time that charging started, and a cost estimate for the session (see [Supercharger Usage Fees and Idle Fees on page 166](#)).

NOTE: To reduce congestion at high-usage supercharger sites, you may be limited to a maximum charge of 80% when not using Trip Planner (if available in your market region). See [Trip Planner on page 151](#)).

Supercharger Usage Fees and Idle Fees

When charging at a Tesla supercharger, information about the charging session displays at the bottom of the charging screen. This includes the location, the time that charging started, and a cost estimate for the session. When you stop supercharging, the estimated cost of the session displays until a new supercharging session begins. If free charging is applicable, the estimated cost displays as zero.

NOTE: Estimated cost may not reflect the final cost of the supercharging session. Final pricing for supercharging sessions can be found in your Tesla account.

When charging at a Tesla supercharger, you are subject to idle fees. Idle fees are designed to encourage drivers to move their vehicle from the Supercharger when charging is complete. Idle fees are in effect only when half or more of the Superchargers at a site are occupied. The Tesla mobile app notifies you when charging is almost complete, and again when charging is complete. Additional notifications are sent if idle fees are incurred. Idle fees are waived if you move your vehicle within five minutes of when charging completed.

Log into your Tesla account to view fees and details about Supercharger sessions, track the remaining balance of free credits, set up a payment method, and make payments. Once a payment method is saved, fees are automatically paid from your account.

Charging Best Practices

- If you are able, maintain a regular charging routine using a low-voltage charger such as a Wall Connector at your home.
- Avoid allowing the battery to get too low.
- Only use DC Fast Charging (such as Supercharging) when necessary, such as during long road trips.
- Charge the battery to the appropriate charge limit for Model S based on the installed battery (see [Electric Vehicle Components on page 159](#)). To adjust the charge limit, navigate to the charging screen and select **Set Limit** or use the mobile app to drag the charging slider.



- For RWD vehicles: Tesla recommends you keep your charge limit to 100%, even for daily use, and you regularly charge your vehicle to 100%. If Model S has been parked for longer than a week, drive your vehicle as you normally would and charge to 100% at your earliest convenience.
- For AWD vehicles: keep the full charge limit of the battery to under 90% for **Daily** use. If you need 100% of your battery for a long-distance trip, increase the limit for **Trip** as needed.

⚠ WARNING: Do not perform this procedure when your vehicle is charging, or if any orange high voltage conductors are exposed. Failure to follow these instructions can result in electric shock and serious injury or damage to the vehicle. If you are uncertain as to how to safely perform this procedure, contact your nearest Service Center.

Manually Releasing Charge Cable

If the usual methods for releasing a charge cable from the charge port (using the charge handle release button, touchscreen, or mobile app) do not work, try pressing and holding down the rear trunk button on the key fob (if equipped) for 1-2 seconds. If it still doesn't release, carefully follow these steps:

1. Ensure that Model S is not actively charging by displaying the charging screen on the touchscreen. If necessary, touch **Stop Charging**.
2. Open the rear trunk.
3. Pull the charge port's release cable downwards to unlatch the charge cable.

⚠ WARNING: Do not pull the release cable while simultaneously attempting to remove the charge cable from the charge port. Always pull the release cable *before* attempting to remove the charge cable. Failure to follow these instructions can result in electric shock and serious injury.



NOTE: The release cable may be recessed within the opening of the trim.

4. Pull the charge cable from the charge port.

⚠ CAUTION: Use the release cable **only** in situations where you can not release the charge cable using the usual methods. Continuous use can damage the release cable or charging equipment.



Scheduled Charging and Scheduled Departure

Toggle between Scheduled Departure and Scheduled Charging by touching **Controls** > **Charging** > **Switch to Scheduled Charging/Scheduled Departure** when Model S is in Park.

NOTE: Scheduled Charging/Scheduled Departure settings are also available on the Climate Controls screen and in the Tesla mobile app.

Think of **Scheduled Charging** as "When do I want charging to start?" and think of **Scheduled Departure Off-Peak Charging** which is "When do I want charging to be complete?"

Scheduled Charging can be used together with **Scheduled Departure Preconditioning** but not with **Scheduled Departure Off-Peak Charging**.

Scheduled Charging/Scheduled Departure settings are automatically saved for each location.

NOTE: If you plug in Model S with both **Off-Peak Charging** and **Scheduled Charging** deselected, your vehicle charges immediately.

Using Scheduled Charging

Use **Scheduled Charging** to specify a daily time in which you want Model S to **start** charging.

With **Scheduled Charging** selected, enable the feature then set a daily time to start charging.

NOTE: Scheduled Charging starts charging immediately if Model S is plugged in up to six hours after the scheduled start time. However, if Model S is plugged in after six hours of the scheduled charging time, charging may not start until the scheduled time on the next day.

Using Scheduled Departure

Use **Scheduled Departure** to set a daily time when you want Model S to be ready to drive. Model S automatically calculates when it needs to start preconditioning and/or charging. This ensures that charging is complete and/or the cabin climate and Battery are preconditioned by your departure time.

When **Scheduled Departure** is displayed, touch **Schedule** to set a daily time when you want Model S to be ready to drive. Specify a time, then touch **Settings** to enable one or both of the following departure features. When plugging in with **Off-Peak Charging** enabled, the vehicle briefly draws power (you may hear clicking) to calculate the necessary charging start time.

After you've specified your desired settings, touch **Set**. The touchscreen displays your scheduled departure time.

- **Preconditioning** warms the Battery for improved performance and ensures a comfortable cabin climate at your set departure time.

NOTE: When Model S is not plugged in, preconditioning operates but only when the Battery's charge level is above 20%.

- **Off-Peak Charging** delays charging and automatically starts charging in order to finish before your scheduled departure time while also ensuring to charge the Battery during off-peak hours to reduce energy costs. Touch **Change Off-Peak Hours** to customize the time when off-peak utility rates end.

NOTE: Choosing **Off-Peak Charging** can reduce energy costs even in market regions where off-peak utility rates are not applicable. For example, if charging starts as soon as you plug in, charging may complete much sooner. This causes the Battery to cool down to ambient temperatures and requires energy to warm it back up by your departure time. Therefore, even if off-peak utility rates are not applicable to you, it is recommended that you set Off-Peak Hours to the same time as your departure time in order to reduce energy consumption.

NOTE: If there is not enough time to reach the charge limit, charging starts immediately in order to charge as much as possible.

NOTE: Once charging has started and there is not enough time to complete charging during off-peak hours, charging continues until the charge limit is reached.

You can limit **Preconditioning** and **Off-Peak Charging** to weekdays only.



Factors Affecting Energy Consumption

While driving:

- Elevated driving speed.
- Environmental conditions such as cold or hot weather and wind.
- Using climate controls to heat or cool the cabin.
- Uphill travel: Driving uphill requires more energy and depletes range at a faster rate. However, driving downhill allows your vehicle to regain a portion of its expended energy through regenerative braking (see [Regenerative Braking on page 67](#)).
- Short trips or stop-and-go traffic: It takes energy to bring the cabin and Battery to a specified temperature when starting the vehicle. You may see a higher average consumption when the vehicle is used for very short trips or in heavy traffic.
- Heavy cargo load.
- Windows rolled down.
- Wheels and tires not maintained.
- Customized settings or third-party accessories (roof or trunk racks, third-party wheels).

While parked and not plugged in to a charger:

- Preconditioning the cabin or using climate controls.
- Summon.
- Vehicle infotainment and climate controls system.
- Sentry mode.
- Tesla or third-party mobile app requests.

Tips to Maximize Range

You can maximize your driving range using the same driving habits you use to conserve fuel in a gasoline-powered vehicle. To achieve maximum range:

- Slow down your driving and avoid frequent and rapid acceleration. Consider using Chill Mode (touch **Controls > Pedals & Steering > Acceleration**) and Speed Assist (see [Speed Assist on page 117](#)) to assist in controlling your acceleration and speed.
- If safe to do so, modulate the accelerator pedal instead of using the brake pedal when gradually slowing down. Whenever Model S is moving and you are not pressing the accelerator pedal, regenerative braking slows down the vehicle and feeds surplus energy back to the Battery (see [Regenerative Braking on page 67](#)).

- Limit the use of resources such as heating and air conditioning. Using seat and steering yoke (or steering wheel) heaters (if equipped) to keep warm is more efficient than heating the cabin using climate controls.
- With your vehicle plugged in, use the mobile app to precondition your vehicle to ensure the cabin is at a comfortable temperature and windows are defrosted (if needed) before your drive by touching **Climate > On** and customizing your preferences (see [Mobile App on page 145](#)).
- Touch **Schedule**, available on both the charging and climate control screens, to set a time when you want your vehicle to be ready to drive (see [Scheduled Charging and Scheduled Departure on page 168](#)).
- Ensure the wheels are aligned to specification, the tires are kept at the recommended inflation pressures (see [Tire Care and Maintenance on page 173](#)), and are rotated when needed (see [Maintenance Service Intervals on page 171](#)).
- Lighten your load by removing any unnecessary cargo.
- Fully raise all windows.
- Features such as Sentry Mode and Cabin Overheat Protection can impact range. Disable features when not needed.
- To prevent an excessive amount of energy consumption while the vehicle is idle, keep the vehicle plugged in when not in use.
- Minimize the use of DC chargers (such as Superchargers) for optimal Battery health.

It is normal for estimated range to decrease slightly over the first few months before leveling off. Over time, you may see a gradual, but natural, decrease in range at full charge - this depends on factors such as Supercharging regularly or the mileage and age of the Battery. Your Model S will inform you in the unlikely event a hardware issue is causing excessive Battery or range degradation.

Range Assurance

The driving range displayed in Model S is an estimate of the remaining battery energy based on EPA-rated consumption. It may not account for your personal driving patterns or external conditions. The displayed range on the instrument panel may decrease faster than the actual distance driven.

NOTE: Rated driving range is based on EPA-rated consumption in the United States, which deviates from tests advertised and performed in other jurisdictions.

Model S helps protect you against running out of energy. Your vehicle continuously monitors its energy level and proximity to known charging locations.



Getting Maximum Range



Touch **Chargers** in the Navigation search bar to toggle between types of chargers, including Superchargers and destination charging sites.

When you are at risk of driving beyond the range of known charging locations, the touchscreen displays a message giving you the opportunity to display a list of charging locations that are within range. When you select a charging location from the list, Model S provides navigation instructions and the turn-by-turn direction list displays the predicted amount of energy that will remain when you arrive at the charging destination.

Trip Planner (if available in your market region) routes you through Supercharger locations to minimize the amount of time you spend charging and driving. To enable, touch **Controls** > **Navigation** > **Trip Planner** (see [Trip Planner on page 151](#)).

Energy App

The Energy app provides a visual representation of your vehicle's real-time and projected energy usage.



1. Locate the Energy app in the bottom bar by touching the app launcher (the three dots).
2. Touch to open the Energy app and choose from the different tabs. The energy chart's colored line represents your actual driving energy consumption whereas the gray line represents predicted usage.

NOTE: You can customize the chart values by touching **Controls** > **Display** > **Energy Display**.

- **Drive:** Monitor the amount of energy being used while driving. You can track the real-time energy consumption broken down by categories, compare against different baseline projections, and view range tips tailored to your drive to understand how to improve energy efficiency.
 1. Choose **Trip** while navigating to a destination to compare the actual usage against the estimated projection.
 2. Choose **Rated** to compare the actual energy or range usage against the estimated driving distance (or energy) available.
 3. Choose between **Current Drive** to view data from your current drive or **Since Last Charged** to include data since the vehicle was last charged.

4. View **Range Tips** to understand impacts on battery consumption and suggestions to maximize range and efficiency.

- **Park:** Monitors the amount of energy lost while Model S is parked.
 1. Choose between **Since Last Drive** or **Since Last Charge**.
 2. View how much idle energy has been consumed while your vehicle is parked and suggestions to decrease energy loss.



Service Intervals

Your vehicle should generally be serviced on an as-needed basis. However, Tesla recommends the following maintenance items and intervals, as applicable to your vehicle, to ensure continued reliability and efficiency of your Model S.

For more do-it-yourself maintenance procedures and information, see <https://www.tesla.com/support/do-it-yourself-guides>.

For more information on vehicle alerts, see [Troubleshooting Alerts on page 209](#).

- Brake fluid health check every 2 years (replace if necessary).
- A/C desiccant bag replacement every 3 years.
- Cabin air filter replacement every 3 years.
- HEPA filters replacement every 3 years.
- Clean and lubricate brake calipers every year or 12,500 miles (20,000 km) if in an area where roads are salted during winter
- Rotate tires every 6,250 miles (10,000 km) or if tread depth difference is 2/32 in (1.5 mm) or greater, whichever comes first

NOTE: Any damage caused by opening the Battery coolant reservoir is excluded from the warranty.

NOTE: The above intervals are based on typical driving behaviors and scenarios. However, Model S should generally be serviced on an as-needed basis; depending on various circumstances such as driving behavior, usage, environmental conditions, etc., the above maintenance items may need to be replaced more or less frequently than specified. Additionally, the above list should not be considered comprehensive and does not include consumable parts such as windshield wipers, brake pads, etc.

NOTE: Damages or failures caused by maintenance or repairs performed by non-Tesla certified technicians are not covered by the warranty.

Schedule Service

Scheduling a service visit through the mobile app is easy. After touching **Schedule Service**, select the type of service needed and follow the directions in the mobile app. Provide as much detail as possible, such as:

- Photos, sound recordings, or videos.
- Date(s), time(s), and time zone when the issue occurred.
- Country of use and location.
- Approximate speed the vehicle was traveling (if applicable).
- Environmental conditions (rain, snow, cold, etc.).

- Road name and type of road (if applicable).
- Quality of lane markings (if applicable).
- Applicable vehicle settings.
- Identifiable symptoms.

Visit <https://www.tesla.com/support/service-visits> for more information on scheduling service.

Daily Checks

- Check the Battery's charge level, displayed on the instrument panel or mobile app.
- Check the condition and pressure of each tire (see [Tire Care and Maintenance on page 173](#)).
- Check that all exterior lights, horn, turn signals, and wipers and washers are working.
- Check for any unexpected indicator lights or vehicle alerts on the touchscreen or instrument panel.
- Check the operation of the brakes, including the parking brake.
- Check the operation of the seat belts (see [Seat Belts on page 32](#)).
- Look for abnormal fluid deposits underneath Model S that might indicate a leak. It is normal for a small pool of water to form (caused by the air conditioning system's dehumidifying process).
- Look around the exterior of Model S and immediately remove any corrosive substances (such as bird droppings, tree resin, tar spots, dead insects, industrial fallout, etc.) to prevent damage to the paint (see [Cleaning on page 178](#)).

Monthly Checks

- Check windshield washer fluid level and top up if necessary (see [Topping Up Windshield Washer Fluid on page 182](#)).
- Check that the air conditioning system is operating correctly (see [Climate Controls on page 119](#)).

NOTE: In addition to cooling the interior, the air conditioning compressor also cools the Battery. Therefore, in hot weather, the air conditioning compressor can turn on even if you turned it off. This is normal because the system's priority is to cool the Battery to ensure it stays within an optimum temperature range to support longevity and optimum performance. Also, even when not in use, you may hear Model S emit a whining noise or the sound of water circulating. These sounds are normal and occur when the internal cooling systems turn on to support various vehicle functions, such as maintaining the low voltage battery and balancing the temperature of the high voltage Battery.



Maintenance Service Intervals

WARNING: Contact Tesla immediately if you notice any significant or sudden drop in fluid levels or uneven tire wear.

WARNING: Some fluids (battery acid, Battery coolant, brake fluid, windshield washer additives, etc.) used in vehicles are poisonous and should not be inhaled, swallowed, or brought into contact with open wounds. For your safety, always read and follow instructions printed on fluid containers.

Fluid Replacement Intervals

Battery coolant and brake fluid levels should only be checked by Tesla or a professional automotive repair shop. Specific service information is available in the Service Manual.

- **Battery coolant:** Your Battery coolant does not need to be replaced for the life of your vehicle under most circumstances.

NOTE: Any damage caused by opening the Battery coolant reservoir is excluded from the warranty.

- **Brake fluid:** Do not top up your brake fluid.

Software

Updating software is important to ensure proper operation and longevity of your vehicle's components. You must install a software update at the earliest opportunity. See [Software Updates on page 143](#).

Tesla may update or reinstall your vehicle's software as part of the normal diagnostic, repair, and maintenance process within Service.

High Voltage Safety

Your Model S has been designed and built with safety as a priority. However, be aware of these precautions to protect yourself from the risk of injury inherent in all high-voltage systems:

- Read and follow all instructions provided on the labels that are attached to Model S. These labels are there for your safety.
- The high voltage system has no user-serviceable parts. Do not disassemble, remove or replace high voltage components, cables or connectors. High voltage cables are colored orange for easy identification.
- If a collision occurs, do not touch any high voltage wiring, connectors, or components connected to the wiring.
- In the unlikely event that a fire occurs, immediately contact your local fire emergency responders.

WARNING: Always disconnect the charge cable before working underneath Model S, even if charging is not in progress.

WARNING: Keep your hands and clothing away from cooling fans. Some fans operate even when Model S is powered off.



Displaying Tire Pressures

Tire pressures display on the touchscreen by touching **Controls > Service**. The pressure of each tire displays in the visualization of your Model S, in addition to what time your tire pressures were last measured. You can choose whether you want to display tire pressures using Bar or PSI by touching **Controls > Display > Tire Pressure**. The touchscreen also displays your vehicle's recommended cold tire pressures so you can easily determine how much to inflate your tires.

NOTE: You may need to drive briefly before the visualization displays the tire pressure values.

Maintaining Tire Pressures

Keep tires inflated to the pressures shown on the Tire and Loading Information label, even if it differs from the pressure printed on the tire itself. The Tire and Loading Information label is located on the center door pillar and is visible when the driver door is open.



The Tire Pressure indicator light on the instrument panel alerts you if one or more tires is under- or over-inflated.

The Tire Pressure indicator light does not immediately turn off when you adjust tire pressure. After inflating the tire to the recommended pressure, you must drive over 15 mph (25 km/h) for a short amount of time to activate the Tire Pressure Monitoring System (TPMS), which turns off the Tire Pressure indicator light.

If the indicator light flashes for one minute whenever you power on Model S, a fault with the TPMS is detected (see [TPMS Malfunction](#) on page 176).

NOTE: Your vehicle's tire pressures will drop in cold ambient temperatures. If the TPMS indicator light appears, inflate the tires before driving. The tires will lose one PSI for every 10° F (6° C) drop in outside temperature. Proper tire pressures help protect tires from potholes and improve range when properly inflated.



WARNING: Under-inflation is the most common cause of tire failures and can cause a tire to overheat, resulting in severe tire cracking, tread separation, or blowout, resulting in unexpected loss of vehicle control and increased risk of injury. Under-inflation also reduces the vehicle's range and tire tread life.



WARNING: Check tire pressures using an accurate pressure gauge when tires are cold. It takes only about one mile (1.6 km) of driving to warm up the tires sufficiently to affect tire pressures. Parking the vehicle in direct sunlight or in hot weather can also affect tire pressures. If you must check warm tires, expect increased pressures. Do not let air out of warm tires in an attempt to match recommended cold tire pressures. A hot tire at or below the recommended cold tire inflation pressure is dangerously under-inflated.

Checking and Adjusting Tire Pressures

Follow these steps when tires are cold and Model S has been stationary for over three hours:

1. Refer to the Tire and Loading Information label located on the driver's center door pillar for the target tire pressure.
2. Remove the valve cap.
3. Firmly press an accurate tire pressure gauge onto the valve to measure pressure.
4. If required, add or remove air to reach the recommended pressure.

NOTE: You can release air by pressing the metal stem in the center of the valve.

5. Re-check pressure using the accurate tire gauge.
6. Repeat steps 3 and 4 as necessary until the tire pressure is correct.
7. Reinstall the valve cap to prevent dirt from entering. Periodically check the valve for damage and leaks.

Inspecting and Maintaining Tires

Regularly inspect the tread and side walls for any sign of distortion (bulges), foreign objects, cuts or wear.



WARNING: Do not drive Model S if a tire is damaged, excessively worn, or inflated to an incorrect pressure. Check tires regularly for wear, and ensure there are no cuts, bulges or exposure of the ply/cord structure.



Tire Care and Maintenance

Tire Wear

Adequate tread depth is important for proper tire performance. Tires with a tread depth less than 4/32" (3 mm) are more likely to hydroplane in wet conditions and should not be used. Tires with a tread depth less than 5/32" (4 mm) do not perform well in snow and slush and should not be used when driving in winter conditions.

Model S is originally fitted with tires that have wear indicators molded into the tread pattern. When the tread has been worn down to 4/32" (3 mm), the indicators start to appear at the surface of the tread pattern, producing the effect of a continuous band of rubber across the width of the tire. For optimal performance and safety, Tesla recommends replacing tires before the wear indicators are visible.

To improve vehicle handling characteristics and minimize hydroplaning in wet conditions, put tires with the most tread on the rear of the car.

Tire Rotation, Balance, and Wheel Alignment

Tesla recommends rotating the tires every 6,250 miles (10,000 km) or if tread depth difference is 2/32 in (1.5 mm) or greater, whichever comes first.

Tire rotation is an essential part of tire maintenance. It helps maintain an even treadwear pattern which enhances the tire's overall wear quality, decreases road noise and maximizes tire life.

Vehicles with staggered wheels and non-directional tires can be rotated side-to-side (left-to-right) but not front-to-back as the front and rear tire size is different. Left-to-right rotation can increase tread life by changing the direction of rotation for each tire and balancing shoulder wear.

Unbalanced wheels (sometimes noticeable as vibration through the steering yoke (or steering wheel)) affect vehicle handling and tire life. Even with regular use, wheels can get out of balance. Therefore, they should be balanced as required.

If tire wear is uneven (on one side of the tire only) or becomes abnormally excessive, check the wheel alignment.

Punctured Tires

A puncture eventually causes the tire to lose pressure, which is why it is important to check tire pressures frequently. Permanently repair or replace punctured or damaged tires as soon as possible.

Your tubeless tires may not leak when penetrated, provided the object remains in the tire. If, however, you feel a sudden vibration or ride disturbance while driving, or you suspect a tire is damaged, immediately reduce your speed. Drive slowly, while avoiding heavy braking or sharp steering and, when safe to do so, stop the vehicle. Arrange to have Model S transported to a Tesla Service Center, or to a nearby tire repair center.

NOTE: In some cases, you can temporarily repair small tire punctures (under 1/4" (6 mm)) using an optional tire repair kit available from Tesla. This allows you to slowly drive Model S to Tesla or to a nearby tire repair facility.



WARNING: Do not drive with a punctured tire that has not been repaired, even if the puncture has not caused the tire to deflate. A punctured tire can deflate suddenly at any time.

Flat Spots

If Model S is stationary for a long period, tires can form flat spots. When Model S is driven, these flat spots cause a vibration which gradually disappears as the tires warm up and regain their original shape.

To minimize flat spots during storage, inflate tires to the maximum pressure indicated on the tire wall. Then, before driving, release air to adjust tire pressure to the recommended levels.

Improving Tire Mileage

To improve the mileage you get from your tires, maintain tires at the recommended tire pressures, observe speed limits and advisory speeds, and avoid:

- Pulling away quickly, or hard acceleration.
- Fast turns and heavy braking.
- Potholes and objects in the road.
- Hitting curbs when parking.
- Contaminating tires with fluids that can cause damage.

Replacing Tires and Wheels

Tires degrade over time due to the effects of ultraviolet light, extreme temperatures, high loads, and environmental conditions. It is recommended that tires are replaced every six years, or sooner if required, even if tread depth is above the minimum.

When a tire set becomes worn, replace all four tires at the same time. Choose a Tesla-approved tire which is designed specifically for your vehicle. Most Tesla-approved tires can be identified with a Tx specification (for example, T0, T1, T2). Tesla-approved tires are designed to reduce road noise and optimize handling, ride, and range. Contact Tesla Service for information.



If tires need to be replaced early, for example due to a flat tire, we recommend replacing the tires in pairs unless the other tires are within 2/32 in (1.5 mm) of tread depth of the new tire. When replacing tires, it is important to match the brand and model of the older tires. Always place a pair of new tires on the rear if all four tires are the same size. Always balance the wheel and tire after replacing a tire. Consult with a professional tire retailer and installer for further guidance.

NOTE: Regardless of the number of tires replaced, a complete set of matching tires is recommended for optimum performance.

If tires other than those specified are used, ensure that the load and speed ratings marked on the tire (see [Understanding Tire Markings on page 195](#)) equal or exceed those of the original specification.

For the specification of the original wheels and tires installed on Model S, see [Wheels and Tires on page 194](#).

If you replace a wheel, the TPMS (Tire Pressure Monitoring System) sensors need to be reset to ensure they provide accurate warnings when tires are under- or over-inflated (see [Automatic Reset of TPMS Sensors on page 176](#)).

WARNING: For your safety, use only tires and wheels that match the original specification. Tires that do not match the original specification can affect the operation of the TPMS.

WARNING: Never exceed the speed rating of your vehicle's tires. The speed rating is shown on the sidewall of your tires (see [Understanding Tire Markings on page 195](#)).

Asymmetric Tires

Model S tires are asymmetric and must be mounted on the wheel with the correct sidewall facing outward. The sidewall of the tire is marked with the word **OUTSIDE**. When new tires are installed, make sure that the tires are correctly mounted on the wheels.



WARNING: Road holding is seriously impaired if the tires are incorrectly installed on the wheels.

Removing and Installing Aero Covers

If your Model S is equipped with aero covers, you must remove them to access the lug nuts.

To remove an aero cover:

1. Grasp the aero cover firmly with both hands.
2. Pull the aero cover toward you to release the retaining clips.

To install an aero cover:

1. Align the aero cover into position so that the notch at the base of the Tesla "T" is aligned with the tire's valve stem.
2. Push firmly around the perimeter of the aero cover until it fully snaps into place.

For Gemini wheels, press on the perimeter of the cover until it aligns with the wheel surface. Press on the Tesla "T" in the center until the cap snaps into place. See [Parts and Accessories on page 185](#) for more information.



CAUTION: To prevent the aero cover from falling off, ensure that it is fully secured before driving.

Wheel Configuration

If you are installing new wheels or swapping them for different ones, update your vehicle's wheel configuration by touching **Controls > Service > Wheel Configuration > Wheels**. This allows Model S to learn the new wheels and provide more accurate status updates on your vehicle. Select a wheel from the drop down menu that matches the new wheels you plan to install on Model S. Selecting new wheels in the wheel configuration also changes the wheels that appear on your vehicle's avatar on the touchscreen.

Ensure you are aware if your vehicle is equipped with staggered wheels, meaning the wheels are different sizes in the front and rear. Check the front and rear tire sizes marked on the tire sidewall to see if they match or are different sizes. If the wheels are staggered, take extra precaution to ensure the new wheels you install are staggered in the same way as the previous wheels.

NOTE: Changing your vehicle's wheel configuration can impact range estimates, tire pressure warning levels, and vehicle visualization.



WARNING: Only use Tesla-approved wheels when installing or swapping wheels. Using non Tesla-approved wheels can cause serious damage. Tesla is not liable for damage caused by using wheels not approved by Tesla.

Tire Pressure Monitoring

Each tire should be checked monthly when cold and inflated to the recommended pressures that are printed on the Tire and Loading Information label located on the driver's door pillar (see [Maintaining Tire Pressures on page 173](#)). If your vehicle has tires of a different size than



Tire Care and Maintenance

the size indicated on the vehicle placard or tire inflation pressure label, determine the proper tire inflation pressure for those tires.

As an added safety feature, your vehicle has been equipped with a TPMS that displays a tire pressure telltale (Tire Pressure Warning) on the instrument panel when one or more of your tires is significantly under- or over-inflated. Accordingly, when the Tire Pressure indicator light displays on the instrument panel to alert you about tire pressure, stop and check your tires as soon as possible, and inflate them to the proper pressure (see [Maintaining Tire Pressures on page 173](#)). Driving on a significantly under-inflated tire causes the tire to overheat and can lead to tire failure. Under-inflation also reduces range efficiency and tire tread life, and may affect the vehicle's handling and stopping ability.



If Model S detects a fault with the TPMS, this indicator flashes for one minute whenever you power on Model S.

NOTE: Installing accessories that are not approved by Tesla can interfere with the TPMS.

WARNING: The TPMS is not a substitute for proper tire maintenance, including manually checking tire pressures and regularly inspecting the condition of tires. It is the driver's responsibility to maintain correct tire pressure, even if under- or over-inflation has not reached the level for the TPMS to trigger the Tire Pressure Warning on the instrument panel.

Automatic Reset of TPMS Sensors

After replacing one or more wheels (but not after replacing a tire), the TPMS sensors are relearned to ensure tire pressure warnings are accurate. TPMS sensors reset automatically within two minutes of driving over 15 mph (25 km/h).

WARNING: If your Model S is equipped with aftermarket tires that differ in size from those printed on the Tire and Loading Information Label (see [Vehicle Loading on page 188](#)), it is the driver's responsibility to determine the correct tire pressure. Do not drive on public roads when tires are not inflated to the correct pressure.

WARNING: Do not depend on TPMS sensors to accurately determine pressures and trigger alerts. It is the driver's responsibility to maintain correct tire pressures (see [Maintaining Tire Pressures on page 173](#)). Over or under-inflated tires can result in loss of control or tire damage, which can lead to serious injury.

Replacing a Tire Sensor

If the Tire Pressure warning indicator displays frequently, contact Tesla to determine if a tire sensor needs to be replaced. If a non-Tesla Service Center repairs or replaces a tire, the tire sensor may not work until Tesla performs the setup procedure.

TPMS Malfunction

Model S has also been equipped with a TPMS malfunction indicator to indicate when the system is not operating properly.



The TPMS malfunction indicator is combined with the tire pressure indicator light. When the system detects a malfunction, the indicator flashes for approximately one minute, then remains continuously lit. This sequence continues upon subsequent vehicle start-ups as long as the malfunction exists. When the TPMS malfunction indicator is on, the system might not be able to detect or signal under- or over-inflated tires as intended.

TPMS malfunctions can occur for a variety of reasons, including installing replacement or alternate tires or wheels that prevent the TPMS from functioning properly. Always check the TPMS malfunction indicator light after replacing one or more tires or wheels on your vehicle to ensure that the replacement tires or wheels allow the TPMS to continue to function properly.

NOTE: If a tire has been replaced or repaired using a different tire sealant than the one available from Tesla, and a low tire pressure is detected, it is possible that the tire sensor has been damaged. Contact Tesla to have the fault repaired as soon as possible.

Seasonal Tire Types

Understand Your Tire Type

The type of tires that your vehicle is originally equipped with depends on vehicle model and market region. It is important to understand the capabilities of your vehicle's tires and whether they are suited for summer, all-season, or winter driving. Check the information on the sidewall of a tire for information about a tire's performance characteristics (see [Understanding Tire Markings on page 195](#))



Summer and All-Season Tires

Summer tires and all season tires are designed for maximum dry and wet road performance but are not designed to perform well in winter conditions. All-season tires are designed to provide adequate traction in most conditions year-round, but may not provide the same level of traction as winter tires in snowy or icy conditions. All-season tires can be identified by "ALL SEASON" and/or "M+S" (mud and snow) on the tire sidewall.

If driving in cold temperatures or on roads where snow or ice may be present, Tesla recommends using winter tires. If not equipped with winter tires, contact Tesla for winter tire recommendations.

⚠ WARNING: In cold temperatures or on snow or ice, summer and all-season tires do not provide adequate traction. Selecting and installing the appropriate tires for winter conditions is important to ensure the safety and optimum performance of your Model S.

Winter Tires

Use winter tires to increase traction in snowy or icy conditions. When installing winter tires, always install a complete set of four tires at the same time. Winter tires must be the same diameter, brand, construction and tread pattern on all four wheels. Contact Tesla for winter tire recommendations.



Winter tires can be identified by a mountain/snowflake symbol on the tire's sidewall.

When driving with winter tires, you may experience more road noise, shorter tread life, and less traction on dry roads.

Driving in Low Temperatures

Tire performance is reduced in low ambient temperatures, resulting in reduced grip and an increased susceptibility to damage from impacts. Performance tires (summer applications) have reduced traction in ambient temperatures below 40° F (5° C), and are not recommended in snow/ice conditions. Performance tires can temporarily harden when cold, causing you to hear rotational noise for the first few miles (kilometers) until the tires warm up.

Using Tire Chains

Tesla has tested and approved the following tire chains to increase traction in snowy conditions. Tire chains should only be installed on the rear tires. The approved tire chains can be purchased from Tesla.

Tire Size	Recommended Chain
19"	KONIG K-SUMMIT

Do not use tire chains on 21" tires.

When installing tire chains, follow the instructions and warnings provided by the tire chain manufacturer. Mount them evenly and as tight as possible.

When using tire chains:

- Inspect the tire chains for loose fittings and damaged links before each use.
- Set air suspension (if equipped) to Medium and turn off the **Default Ride Height to Low** setting (see [Air Suspension on page 129](#)).
- Set air suspension to **Medium** and turn off the **Default Ride Height to Low** setting.
- Avoid heavily loading Model S (heavy loads can reduce the clearance between the tires and the body).
- Do not drive the vehicle without the chains properly installed.
- Drive slowly. Do not exceed 30 mph (48 km/h).
- Remove the tire chains as soon as conditions allow.

NOTE: Tire chains are prohibited in some jurisdictions. Check local laws before installing tire chains.

⚠ CAUTION: Using non-recommended tire chains, or using tire chains on other sized tires can damage the suspension, body, wheels, and/or brake lines. Damage caused by using non-recommended tire chains, or incorrectly installing tire chains, is not covered by the warranty.

⚠ CAUTION: Never deflate your tires to put on tire chains. When re-inflated, the chains might fit too tightly and cause tire damage.

⚠ CAUTION: Ensure that the tire chains cannot touch suspension components or brake lines. If you hear the chains making unusual noises that would indicate contact with Model S, stop and investigate immediately.

Cleaning the Exterior

To prevent damage to the paint, immediately remove corrosive substances (bird droppings, tree resin, dead insects, tar spots, road salt, industrial fallout, etc.). Do not wait until Model S is due for a complete wash. If necessary, use denatured alcohol to remove tar spots and stubborn grease stains, then immediately wash the area with water and a mild, non-detergent soap to remove the alcohol.

Keep the exterior cameras free of dirt, condensation, or obstructions. These substances can cause unclear pictures or Autopilot and safety features to stop working (see [Cleaning a Camera on page 178](#)).

Follow these steps when washing the exterior of Model S:

1. Rinse Thoroughly

Before washing, flush grime and grit from the vehicle using a hose. Flush away accumulations of mud in areas where debris easily collects (such as wheel wells and panel seams). If salt has been used on the highways (such as during winter months), thoroughly rinse all traces of road salt from the underside of the vehicle, wheel wells, and brakes.

2. Hand Wash

Hand wash Model S using a clean soft cloth and cold or lukewarm water containing a mild, high-quality car shampoo.

 **CAUTION:** Some cleaners and car shampoos contain chemicals that can cause damage or discoloration, especially to plastic trim pieces, lamps, or camera lenses. For example, some car cleaning formulas contain hydroxide or other highly alkaline or caustic ingredients that can damage exterior components. Damage or discoloration resulting from cleaning products is not covered by the warranty.

3. Rinse with Clean Water

After washing, rinse with clean water to prevent soap from drying on the surfaces.

4. Dry Thoroughly and Clean Exterior Glass

After washing and rinsing, dry thoroughly with a chamois. If necessary, dry the brakes by going on a short drive and applying the brakes multiple times.

Window Cleaning and Treatments

Clean windows and mirrors using an automotive glass cleaner. Do not scrape or use any abrasive cleaning fluid on glass or mirrored surfaces. Follow the directions in [Cleaning the Exterior on page 178](#) for best practices in cleaning the exterior glass.

To add a hydrophobic coating to your vehicle's windows, apply the coating only to the side and rear windows, not the front windshield—doing so may affect the visibility of the autopilot cameras. Follow the hydrophobic coating manufacturer's instructions for application details.

NOTE: Tesla is not responsible for any damage associated with applying window treatments on your vehicle.

Car Wash Mode

When taking Model S to a car wash, Car Wash Mode closes all windows, locks the charge port, and disables windshield wipers, Sentry Mode, walk-away door locking, and parking sensor chimes. To enable, touch **Controls > Service > Car Wash Mode**. Your vehicle must be stationary and not actively charging.

If using an automatic car wash, **Enable Free Roll** keeps your vehicle in Neutral and activates free roll for the duration of the wash, while preventing Model S from applying the Parking brake if you leave the driver's seat. To enable, press on the brake pedal and touch **Enable Free Roll**; or shift into Neutral.

Car Wash Mode disables if the vehicle's speed exceeds 9 mph (15 km/h) or by touching **Exit** on the touchscreen.

 **CAUTION:** Failure to put Model S in Car Wash Mode may result in damage (for example, to the charge port or windshield wipers). Damage caused by car washes is not covered by the warranty.













Cleaning a Camera

To ensure a clear picture, the camera lens must be clean and free of obstructions. Remove any build-up of dirt or debris by spraying water onto the camera lens with a spray bottle.

 **CAUTION:** Do not attempt to remove dirt or debris by wiping an exposed lens with your hands or a cloth. This debris can damage the surface of the lens when rubbed against it during wiping.

 **CAUTION:** Do not use chemical-based or abrasive cleaners. Doing so can damage the surface of the lens.

Cautions for Exterior Cleaning

-  **CAUTION:** Do not wash in direct sunlight.
-  **CAUTION:** Do not use windshield treatment fluids. Doing so can interfere with wiper friction and cause a chattering sound.
-  **CAUTION:** Do not use hot water, detergents, or highly alkaline or caustic cleaning products, especially those containing hydroxide.
-  **CAUTION:** If using a pressure washer, maintain a distance of at least 12" (30 cm) between the nozzle and the surface of Model S. Avoid aiming the water jet directly at parking sensors (if equipped). Keep the nozzle moving and do not concentrate the water jet on any one area.
-  **CAUTION:** Do not aim water hoses directly at windows, door, or hood seals or at electronic modules or exposed cabling.
-  **CAUTION:** To avoid corrosive damage that may not be covered by the warranty, rinse away any road salt from the underside of the vehicle, wheel wells, and brakes. After cleaning the vehicle, dry the brakes by going on a short drive and applying the brakes multiple times.
-  **CAUTION:** Avoid using tight-napped or rough cloths, such as washing mitts. A high-quality microfiber cleaning cloth is recommended.
-  **CAUTION:** If washing in an automatic car wash, use touchless car washes only. These car washes have no parts (brushes, etc.) that touch the surfaces of Model S. Some touchless car washes use caustic solutions that, over time, can cause discoloration of decorative exterior trim. Avoid exposure to soaps and chemicals above pH 13. If unsure, check the product label or ask the staff at the car wash. Damage caused by improper washing is not covered by the warranty.
-  **CAUTION:** If washing in an automatic car wash, make sure the vehicle is locked. In addition, avoid using controls on the touchscreen that can result in accidentally opening doors or trunks while the vehicle is being washed. Any damage caused is not covered by the warranty.
-  **CAUTION:** Ensure the wipers are off before washing Model S to avoid the risk of damaging the wipers.
-  **CAUTION:** Do not use chemical based wheel cleaners or pre-wash products. These can damage the finish on the wheels.
-  **WARNING:** Never spray liquid at a high velocity (for example, if using a pressure washer) towards the charge port while Model S is charging. Failure to follow these instructions can result in serious injury or damage to the vehicle, charging equipment, or property.

Cleaning the Interior

Frequently inspect and clean the interior to maintain its appearance and to prevent premature wear. If possible, immediately wipe up spills and remove marks. For general cleaning, wipe interior surfaces using a soft cloth (such as microfiber) dampened with a mixture of warm water and mild non-detergent cleaner (test all cleaners on a concealed area before use). To avoid streaks, dry immediately with a soft lint-free cloth.

Interior Glass

Do not scrape, or use any abrasive cleaning fluid on glass or mirrored surfaces. This can damage the reflective surface of the mirror and the heating elements in the rear window.

Airbags

Do not allow any substance to enter an airbag cover. This could affect correct operation.

Dashboard and Plastic Surfaces

Do not polish the upper surfaces of the dashboard. Polished surfaces are reflective and could interfere with your driving view.

Seats

Wipe spills and chemical residues from interior surfaces as soon as possible using a soft cloth moistened with warm water and non-detergent soap. Wipe gently in a circular motion. Then wipe dry using a soft, lint-free cloth.

Although seating surfaces are designed to repel stains, Tesla recommends regular cleaning to maintain performance and an as-new appearance. Promptly treat dye transfer from clothing, such as indigo-dyed denim. Avoid contact with harsh chemicals, including certain cosmetics. Never use cleaners containing alcohol or bleach. Spot-test cleaners on an inconspicuous area before applying to visible surfaces.

If equipped with leather seats, note that leather is prone to dye-transfer which can cause discoloration, particularly on light colored leather. White and tan leather is coated with an anti-soiling treatment. Using detergents or commercially available leather cleaners and conditioners is not recommended because they can discolor or dry out the leather.

Vacuum cloth seats as needed to remove any loose dirt.

-  **CAUTION:** Aftermarket, non-Tesla seat covers may inhibit the sensitivity of a seat's occupancy sensors and may cause staining or damage.



Cleaning

CAUTION: The front seats are equipped with microphones (see [Active Road Noise Reduction on page 27](#)) that must not be exposed to liquids. To prevent damage to these microphones when cleaning, do not over-saturate the area of the seats where these microphones are located.

Carpets

Avoid over-wetting carpets. For heavily soiled areas, use a diluted upholstery cleaner.

Seat Belts

Extend the belts to wipe. Do not use any type of detergent or chemical cleaning agent. Allow the belts to dry naturally while extended, preferably away from direct sunlight.

Door Seals

Wipe door seals with a damp cloth to remove any debris. Excessive debris on the door seals can cause paint damage when contacting surrounding surfaces. Avoid using alcohol wipes or any chemical products that can potentially deteriorate the coating on the door seals.

Touchscreen, Rear Touchscreen, and Instrument Panel

Clean the touchscreen and instrument panel using a soft lint-free cloth specifically designed to clean monitors and displays. Do not use cleaners (such as a glass cleaner) or alcohol-based gel products (such as hand sanitizer) and do not use a wet wipe or a dry statically-charged cloth (such as a recently washed microfiber). To wipe the touchscreen without activating buttons and changing settings, you can enable Screen Clean Mode. Touch **Controls > Display > Screen Clean Mode**. The display darkens to make it easy to see dust and smudges. To exit Screen Clean Mode, press and hold **HOLD TO EXIT**.

Chrome and Metal Surfaces

Polish, abrasive cleaners, alcohol-based gel products (such as hand sanitizer), and hard cloths can damage the finish on chrome and metal surfaces.

Cautions for Interior Cleaning

CAUTION: Using solvents (including alcohol), alcohol-based gel products (such as hand sanitizer), bleach, citrus, naphtha, or silicone-based products or additives on interior components can cause damage.

CAUTION: Statically-charged materials can cause damage to the touchscreen or instrument panel.

WARNING: If you notice any damage on an airbag or seat belt, contact Tesla immediately.

WARNING: Do not allow any water, cleaners, or fabric to enter a seat belt mechanism.

WARNING: Exposure to chemical cleaners can be hazardous and can irritate eyes and skin. Read and observe the instructions provided by the manufacturer of the chemical cleaner.

Polishing, Touch Up, and Body Repair

To preserve the cosmetic appearance of the body, you can occasionally treat the paint surfaces with an approved polish containing:

- Very mild abrasive to remove surface contamination without removing or damaging the paint.
- Filling compounds that fill scratches and reduce their visibility.
- Wax to provide a protective coating between the paint and environmental elements.

Regularly inspect the exterior paint for damage. Treat minor chips and scratches using a paint touch-up pen (available for purchase from Tesla). Use the touch-up pen after washing but before polishing or waxing.

Repair rock chips, fractures or scratches. Refer to <https://www.tesla.com/support/body-shop-support> for more information on repair locations and available services.

CAUTION: Do not use cutting pastes, color restoration compounds, or polishes containing harsh abrasives. These can scour the surface and permanently damage the paint.

CAUTION: Do not use chrome polish or other abrasive cleaners.

Using a Car Cover

To preserve the cosmetic appearance of the body when Model S is not being used, use a genuine Tesla car cover. Car covers can be purchased from Tesla. See [Parts and Accessories on page 185](#).

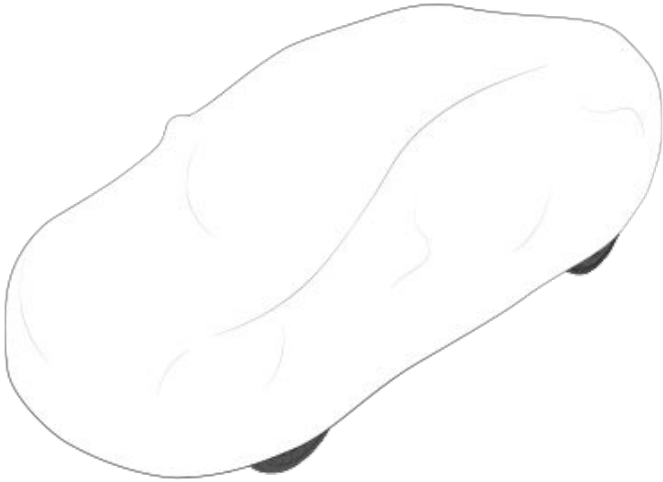

⚠ CAUTION: Use only a Tesla-approved car cover when Model S is plugged in. Using a non-Tesla car cover can prevent the Battery from being adequately cooled during charging.

Floor Mats

To extend the life of your carpet and make them easier to clean, use genuine Tesla floor mats (see [Parts and Accessories on page 185](#)). Maintain floor mats by regularly cleaning them and checking that they are properly attached. Replace floor mats if they become excessively worn.

⚠ WARNING: To avoid potential interference with a foot pedal, ensure that the driver's floor mat is securely fastened, and never place an additional floor mat on top of it. Floor mats should always rest on top of the vehicle carpeting surface and not on another floor mat or other covering.



Windshield Wiper Blades, Jets and Fluid

Topping Up Windshield Washer Fluid

The only reservoir into which you can add fluid is the windshield washer fluid reservoir, which is located behind the front trunk. When the level is low, a message displays on the instrument panel.

To top up the washer fluid:

1. Open the hood.
2. Clean around the filler cap before opening it to prevent dirt from entering the reservoir.
3. Open the filler cap.
4. While avoiding spilling, fill the reservoir until the fluid level is visible just below the filler neck.

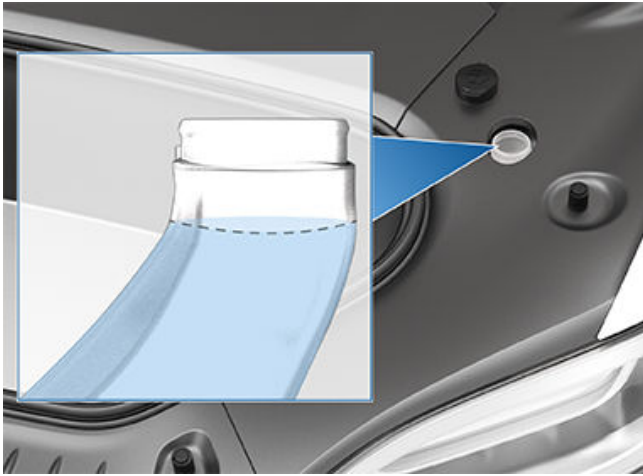

5. Wipe up any spills immediately and wash the affected area with water.
6. Reinstall the filler cap.

CAUTION: Use only windshield washer fluid meant for automotive vehicles. Using other substances, such as untreated water, can result in bacterial growth within the climate control system resulting in odor or potential damage that is not covered by warranty.

NOTE: Some national or local regulations restrict the use of Volatile Organic Compounds (VOCs). VOCs are commonly used as antifreeze in washer fluid. Use a washer fluid with limited VOC content only if it provides adequate freeze resistance for all climates in which you drive Model S.

CAUTION: Do not add formulated washer fluids that contain water repellent or bug wash. These fluids can cause streaking, smearing, and squeaking or other noises.

WARNING: In temperatures below 40° F (4° C), use a washer fluid with antifreeze. In cold weather, using a washer fluid without antifreeze can impair visibility through the windshield.

WARNING: Windshield washer fluid can irritate eyes and skin. Read and observe the instructions provided by the washer fluid manufacturer.

Checking and Cleaning Wiper Blades

Periodically clean the edge of the wiper blades and check the rubber for cracks, splits, and roughness. If damaged, replace the blade immediately to prevent damage to the glass and improve visibility.

Contaminants on the windshield, or on the wiper blades, can reduce the effectiveness of the wipers. Contaminants include ice, wax spray from car washes, washer fluid with bug and/or water repellent, bird droppings, tree sap, and other organic substances.

Follow these guidelines for cleaning:

- Clean the windshield and wiper blades using washer fluid, isopropyl (rubbing) alcohol, or non-abrasive glass cleaner approved for use on automotive glass and rubber. Inappropriate products can cause damage or smears, and create glare on the windshield.
- Lift the wiper arm a short distance away from the windshield, just far enough to access the wiper blade. Do not lift a wiper arm beyond its intended position.

If the wipers remain ineffective after cleaning, replace the wiper blades.

Replacing Wiper Blades

For optimum performance, replace the wiper blades at least once a year. Replacement blades must meet the following criteria:

- The blade on the driver's side must be 26 inches (650 mm) long and 20 inches (500 mm) long for the blade on the passenger's side.
- Ensure the connector on the replacement blade is the same as the original blade. Different connectors may prevent the replacement blade from connecting to the wiper arm on the vehicle.

You can purchase replacement wiper blades on the [Tesla Shop](#).

NOTE: Only install replacement blades that are identical to the original blades. Using inappropriate blades can damage the wiper system and windshield.

To replace the wiper blades:

1. Shift into Park and turn off the wipers.
2. Touch **Controls** > **Service** > **Wiper Service Mode** to move the wipers to the service position.



- Lift the wiper arm a short distance away from the windshield, just far enough to access the wiper blade.

⚠ CAUTION: Wiper blades do not lock into a lifted position. Do not lift a wiper arm beyond its intended position.

- Place a towel between the wiper arm and windshield to avoid scratching or cracking the windshield.
- Hold the wiper arm and press the locking tab while sliding the blade down the arm.

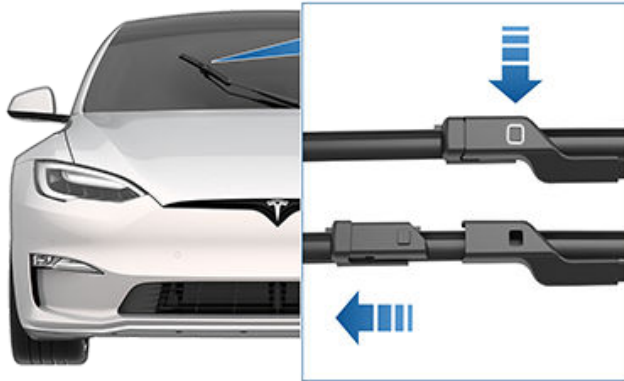

- Align the new wiper blade on the wiper arm and slide it toward the end of the wiper arm until it locks into place.
- Turn Wiper Service Mode off to return the wipers to their normal position.

Cleaning Washer Jets

The position of the windshield washers is set at the factory and should never need adjusting.

If a windshield washer becomes blocked, use a thin strand of wire to clear any blockages from the nozzles.

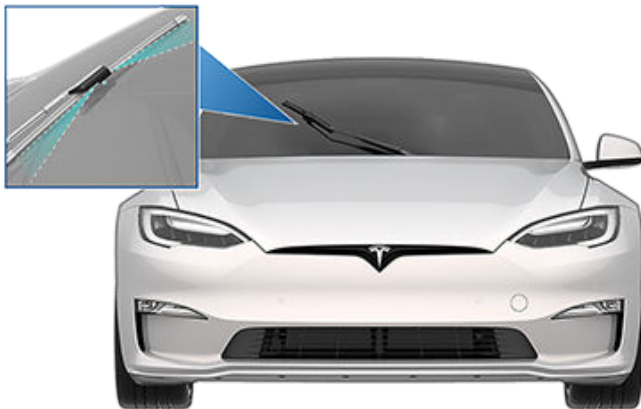

⚠ WARNING: Do not operate the washers while cleaning Model S. Windshield washer fluid can irritate eyes and skin. Read and observe the washer fluid manufacturer's instructions.



Jacking and Lifting

Jacking Procedure

Follow the steps below to lift Model S. Ensure that any non-Tesla repair facility is aware of these lifting points.

1. Position Model S centrally between the lift posts.
2. If your Model S is equipped with air suspension, it automatically self-levels, even when power is off (see [Jack Mode on page 184](#)). Use the touchscreen to set the suspension as follows:
 - Touch **Controls** > **Suspension**.
 - Press the brake pedal, then touch **Very High** to maximize the height of the suspension.
 - Touch **Controls** > **Service** > **Jack Mode** to disable self-leveling.
3. Position the lift arm pads under the designated body lift points at the locations shown.

WARNING: DO NOT position the lift arm pads under the Battery or side rails.

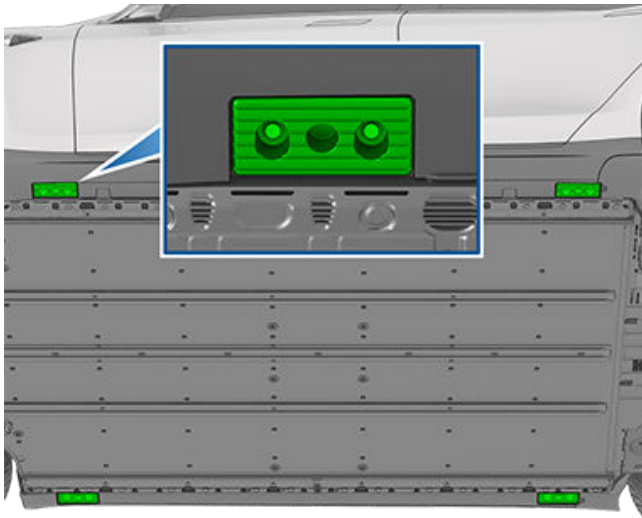

4. Adjust the height and position of the lift arm pads to ensure that they are correctly located.
5. With assistance, raise the lift to the desired height, ensuring the lift arm pads remain in their correct positions.
6. Engage any lift safety locks. Follow the lift manufacturer's instructions.

NOTE: Jack mode cancels when Model S is driven over 4 mph (7 km/h).

NOTE: Jack mode may be unexpectedly enabled in situations where an object is supporting the vehicle's weight (for example the bumper of the vehicle is resting on a curb).

WARNING: The air suspension system automatically self-levels, even when power is off. You MUST disable this system by engaging Jack mode before lifting or jacking. If you do not disable the air suspension, Model S can attempt to self-level, causing serious damage, bodily injury, or death.

WARNING: Never raise Model S when the charge cable is connected, even if charging is not in progress.

WARNING: Do not work on an incorrectly supported vehicle. Doing so can cause serious damage, bodily injury, or death.

CAUTION: DO NOT lift from under the Battery or side rails. Place the lift arm pads under the designated body lift points only. The locations shown are the only approved lifting points for Model S. Lifting at any other points can cause damage. Damage caused by incorrectly lifting Model S is not covered by the warranty.

Jack Mode

If Model S is equipped with air suspension, it automatically self-levels, even when power is off. To prevent damage when jacking or lifting the vehicle, you must activate Jack mode to disable self-leveling. Jack mode prevents the self-leveling that occurs even when Model S is powered off.

Press the brake pedal, then touch **Controls** > **Service** > **Jack Mode**.

To deactivate, touch **Jack Mode** again.

NOTE: Jack Mode automatically cancels when you drive over 4 mph (7 km/h).

NOTE: Model S also sets Jack mode automatically if it detects that the vehicle cannot lower to its target height, or if it detects that an object is supporting the vehicle's weight (for example the bumper of the vehicle is resting on a curb).



Parts, Accessories, and Modifications

Use only genuine Tesla parts and accessories. Tesla performs rigorous testing on parts to ensure their suitability, safety, and reliability. Purchase these parts from Tesla, where they are professionally installed and where you can receive expert advice about modifications to Model S. Accessories are available for purchase from Tesla stores or online at www.tesla.com.

NOTE: Some accessories may not be available in your market region.

Tesla is unable to assess parts manufactured by other distributors and therefore accepts no responsibility if you use non-Tesla parts on Model S.

⚠ WARNING: Installing non-approved parts and accessories, or performing non-approved modifications, can affect the performance of Model S and the safety of its occupants. Any damage caused by using or installing non-approved parts, or by performing non-approved modifications, is not covered by the warranty.

⚠ WARNING: Tesla does not accept liability for death, personal injury or damage that occurs if you use or install non-approved accessories or make non-approved modifications.

Body Repairs

If your Model S is in a collision, contact Tesla or a Tesla-approved Body Shop to ensure that it is repaired with genuine Tesla parts. Tesla has selected and approved body shops that meet strict requirements for training, equipment, quality, and customer satisfaction.

Some repair shops and insurance companies might suggest using non-original equipment or salvaged parts to save money. However, these parts do not meet Tesla's high standards for quality, fit and corrosion resistance. In addition, non-original equipment and salvaged parts (and any damage or failures they might cause) are not covered by the warranty.

Replacing Cabin Air Filters

Model S has an air filter that prevents pollen, industrial fallout, road dust, and other particles from entering the cabin through the vents. Tesla recommends replacing these filters every 2 years (every year in China). Cabin filters can be purchased at the [Tesla Shop](#).

To replace the cabin filter:

1. Turn off the climate control system.
2. Move the front passenger seat fully rearwards.

3. Slowly and gently pull down the footwell cover to release the magnets, then disconnect the electrical harness on the right side of the cover. Set the footwell cover aside.
4. Squeeze the cabin filter door lock to release it, and then remove and set the door aside.
5. Note the direction of air flow printed on the cabin filter. The arrows on the filter should face toward the rear of the vehicle.
6. Slide the filter out of the HVAC module.
7. Ensuring that the arrows on the new filter face toward the rear of the vehicle, insert the new cabin filter into the HVAC module.
8. Slide the cabin filter door onto the HVAC module, and then push the door to lock it.

NOTE: Ensure the lock is fully engaged and the door is sealed shut.
9. Position the front passenger footwell cover on the vehicle and connect the electrical harness to the cover.
10. Install the front passenger footwell cover, making sure the magnets (x3) are locked into position.
11. Move the front passenger seat back to its original position.

Using RFID Transponders

When attaching an RFID transponder (used by many automated toll systems) inside Model S, place the transponder on the bottom corner of the passenger side of the windshield as shown. This ensures best results and minimizes any obstruction to your driving view.

NOTE: You can also attach a weather-proof transponder to the front license plate.

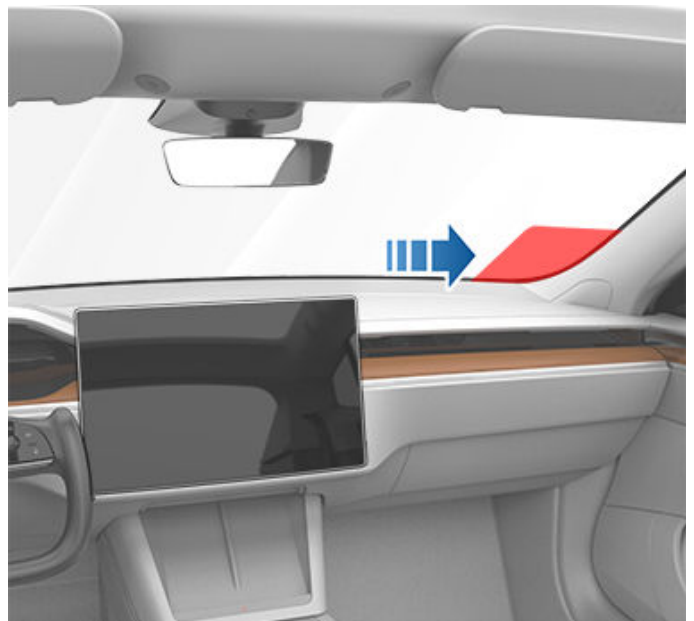



Do It Yourself Maintenance

Learn how to perform simple Do It Yourself procedures, such as replacing wiper blades and cabin filters, or installing the paint protection film kit. See <https://service.tesla.com/docs/Public/diy/index-model-s.html> for instructions, animations, and videos of these procedures.

NOTE: Due to market region or vehicle configuration specifics, some parts and procedures may not be available for your vehicle. When navigating to <http://www.tesla.com>, select your region and language to see an updated list of parts and accessories available for your region.

 **CAUTION:** Perform each procedure in this guide in a dry and well-lit area. For your safety, only perform a procedure if you feel comfortable doing so, and always follow all provided instructions.



Vehicle Identification Number

You can find the VIN at the following locations:

- Touch **Controls** > **Software**.
- Stamped on a plate located at the top of the dashboard. Can be seen by looking through the windshield on the driver's side of the vehicle.



- Printed on the Vehicle Certification label, located on the door pillar. Can be seen when the driver's door is open.



Emission Control Label

The emission control label is located on the opening face of the liftgate.

NOTE: For vehicles with a model year of 2022 or newer, the emission control label is now located on the inside of the front hood and may not match the label shown.



Vehicle Loading

Vehicle Labeling

It is important to understand your vehicle's original tire sizes and pressures, and the GVWR (Gross Vehicle Weight Rating) and GAWR (Gross Axle Weight Rating). This information can be found on two labels attached to Model S.



1. Tire and Loading Information Label
2. Tire Information Label
3. Vehicle Certification Label

WARNING: Overloading Model S has an adverse effect on braking and handling, which can compromise your safety or cause damage.

CAUTION: Never store large amounts of liquid in Model S. A significant spill can cause electrical components to malfunction.

Tire and Loading Information Label

The Tire and Loading Information label provides:

- The maximum number of occupant seating positions.
- The maximum vehicle capacity weight.
- The size of the original tires.
- The cold inflation pressures for the original front and rear tires. These pressures are recommended to optimize ride and handling characteristics.

United States/Canada:

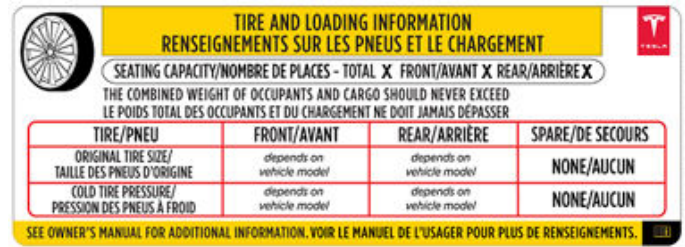

Mexico:

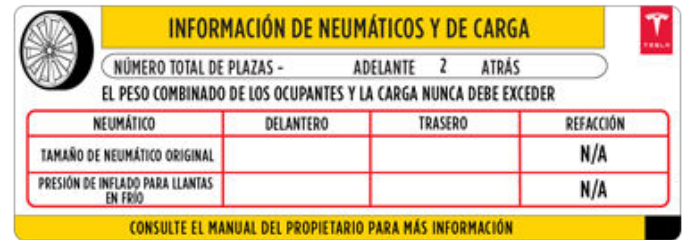

Never change this label, even if you use different tires in the future.

NOTE: If Model S is loaded to its full capacity, double check all tires to ensure they are inflated to their recommended pressure levels.

Vehicle Certification Label

The Vehicle Certification label provides:

- GVWR - Gross Vehicle Weight Rating. The maximum allowable total mass of Model S. This is calculated as the weight of Model S equipped with the heaviest factory selectable options, all passengers, fluids, and cargo.
- GAWR FRT and GAWR RR - Gross Axle Weight Rating for the front and rear axles. The GAWR is the maximum distributed weight that each axle can support.

United States:

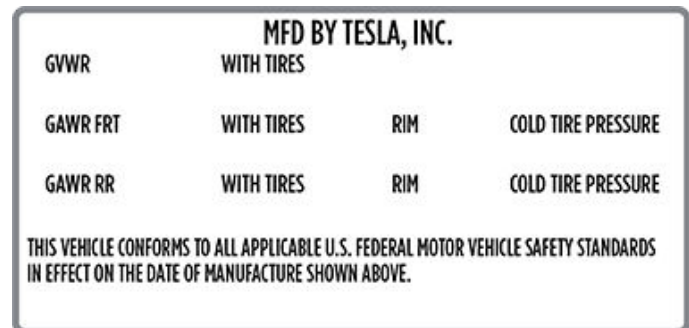

Canada:



Mexico:



CAUTION: To prevent damage, never load Model S so that it is heavier than GVWR or exceeds the individual GAWR weights.

Roof Racks

A Model S equipped with a glass roof can carry up to 165 lbs (75 kg) using a Tesla-approved roof rack (see [Parts and Accessories on page 185](#)).

Calculating Load Limits

1. Locate the statement “The combined weight of occupants and cargo should never exceed XXX lbs or XXX kg” on the “Tire and Loading Information” label.
2. Determine the combined weight of all occupants that will ride in the vehicle.
3. Subtract the combined weight of the occupants from XXX lbs or XXX kg (see Step 1).
4. The resulting figure equals the available cargo load capacity. For example, if the “XXX” amount equals 1400 lbs (635 kg) and there will be five 150 lb (68 kg) passengers in the vehicle, the amount of available cargo capacity is 650 lbs (1400 - 750 (5 x 150) = 650 lbs) or 295 kg (635 - 340 (5 x 68) = 295 kg).
5. Determine the combined cargo weight being loaded on the vehicle. That weight must not exceed the available cargo load capacity calculated in Step 4.

WARNING: Trunks are the preferred places to carry objects. In a collision, or during hard braking and sharp turns, loose items in the cabin could injure occupants.

Example Load Limit Calculations

How much cargo Model S can carry depends on the number and weight of passengers. The following calculated load limit examples assume passengers weigh 150 lbs (68 kg). If passengers weigh more or less, available cargo weight decreases or increases respectively.

Driver and one passenger

Description	Total
Vehicle capacity weight	954 lbs (433 kg)
Subtract occupant weight (2 x 150 lbs/68 kg)	300 lbs (136 kg)
Available cargo weight	654 lbs (297 kg)

Driver and four passengers

Description	Total
Vehicle capacity weight	954 lbs (433 kg)
Subtract occupant weight (5 x 150 lbs/68 kg)	750 lbs (340 kg)
Available cargo weight	204 lbs (93 kg)

The cargo weight should be distributed as evenly as possible between the front and rear trunks.

CAUTION: Never load more than 110 lbs (50 kg) in the front trunk. Doing so can cause damage.

CAUTION: Never load more than 88 lbs (40 kg) in the lower tub compartment of the rear trunk or more than 287 lbs (130 kg) on the upper floor. Doing so can cause damage.



Dimensions

Exterior Dimensions

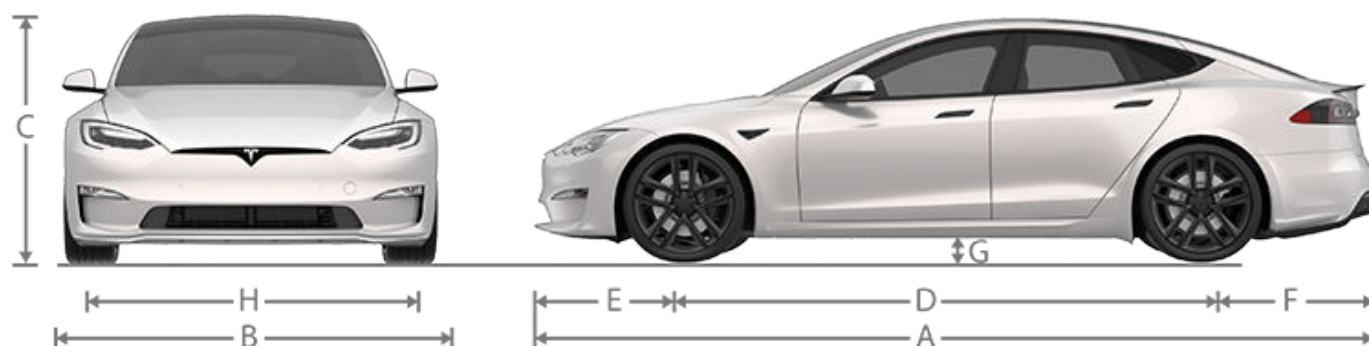

Callout	Description	Measurement (in)	Measurement (mm)
A	Overall Length	197.7	5,021
B	Overall Width (including mirrors)	86.2	2,189
	Overall Width (excluding mirrors)	78.2	1,987
C	Overall Height*: - suspension set to medium - suspension set to highest**	56.3	1,431
		58.1	1,478
D	Wheel Base	116.5	2,960
E	Overhang - Front	37.8	961
F	Overhang - Rear	43.3	1,100
G	Ground Clearance*: - suspension set to lowest - suspension set to medium - suspension set to highest**	4.6	117
		5.0	126
		6.2	158
H	Track - Front and Rear	66.5	1,690

*Values are approximate and based on 19" wheels. Values can vary depending on a vehicle's options and various other factors.

**When vehicle is in Transport Mode, the suspension is automatically set to the highest setting.

CAUTION: Depending on configuration (such as suspension height or wheel selection), your vehicle's liftgate can open up to approximately 7.5 feet (2.3 meters) high. See [Adjusting Liftgate Opening Height on page 20](#) to adjust the liftgate height and prevent it from coming into contact with low ceilings or other objects.

Interior Dimensions

Area	Location	Measurement (in)	Measurement (mm)
Head Room	Front	39.7	1,008

Area	Location	Measurement (in)	Measurement (mm)
	Rear	38.1	968
Leg Room	Front	42.4	1,077
	Rear	35.5	901
Shoulder Room	Front	58.4	1,484
	Rear	55.1	1,399
Hip Room	Front	54.8	1,393
	Rear	50.3	1,278

Cargo Volume

Area	Volume (liters)	Volume (cubic feet)
Front trunk	89	3.1
Behind first row, second row folded flat	1,739	61.4
Behind second row	709	25.0
Maximum total cargo volume with driver and front passenger	1,828	64.6
Maximum total cargo volume with driver and 4 passengers	798	28.2

Motor Type

Motor Type	Model S Model X	Model S Plaid Model X Plaid
Front and rear motor	AC permanent magnet synchronous motor, liquid-cooled, with variable frequency drive	AC permanent magnet synchronous motor, carbon-fiber-wrapped rotor, liquid-cooled, with variable frequency drive (2x motors in the rear)

Transmission

Type	Model S	Model S Plaid
Front transmission	Single speed fixed gear, 7.56:1	Single speed fixed gear, 7.56:1. Enhanced lubrication
Overall Final Drive Ratio	Front unit motor: 7.56:1 Rear unit motor: 9.04:1	Front unit motor: 7.56:1 Rear unit motor: 7.56:1
Rear transmission	Single speed fixed gear, 9.04:1	Independent single speed fixed gear, 7.56:1. Dry sump lubrication

Steering

Steering	Specifications
Type	Variable ratio rack and pinion with electronic power steering, speed sensitive
Number of turns lock to lock	2.33
Turning Circle (curb to curb)	40.3 ft/12.3 m

Brakes

Brakes	Specifications
Type	4-wheel anti-lock braking system (ABS) with Electronic Brake Force Distribution, Integrated Advanced Stability Control and Electronic Accelerator pedal actuated regenerative braking system
Calipers	Front: Four piston, fixed Rear: Single piston, floating
Rotor Diameters (ventilated)	Front: 15.59"/395 mm Rear: 14.37"/365 mm
Front Rotor thickness	New: 1.26"/32 mm Service limit: 1.18"/30 mm
Rear Rotor thickness	New: 1.10"/28 mm Service limit: 1.02"/26 mm

Brakes	Specifications
Front Brake Pad Thickness (excluding back plate)	New: 0.41"/10.5 mm (MIN)
	Service limit: 0.09"/ 2.3 mm
Rear Brake Pad Thickness (excluding back plate)	New: 0.33"/8.5 mm (MIN)
	Service limit: 0.11"/ 2.7 mm
Parking brake	Electrically actuated parking brake calipers

Suspension

Suspension	Specifications
Front	Independent, double wishbone, air spring with adaptive damper, stabilizer bar
Rear	Independent, multi-link, air spring with adaptive damper, stabilizer bar

Battery - Low Voltage

Battery - Low Voltage	Specifications
Rating	6.9 amp hour
Voltage	15.5V

Battery - High Voltage

Battery - High Voltage	Specifications
Type	Liquid-cooled lithium ion (Li-ion)
Nominal Voltage	407 V DC
Temperature Range	Do not expose Model S to ambient temperatures above 149° F (65° C) or below -22° F (-30° C) for more than 24 hours at a time.



Wheel Specifications (Factory)

Wheel Type	Location	Size	Offset (mm)
19"	Front	9.5J x 19	40
	Rear	10.5J x 19	45
21"	Front	9.5J x 21	40
	Rear	10.5J x 21	45
Lug Nut Torque		129 lb. ft (175 Nm)	
Lug Nut Socket Size		21 mm	

NOTE: For instructions on how to jack/lift Model S, see [Jacking and Lifting on page 184](#).

Tire Specifications (Factory)

Tire Type	Location	Size
In U.S., Canada, Puerto Rico and Korea:		
19" All-Season	Front	255/45R19
	Rear	285/40R19
19" Summer	Front	255/45R19
	Rear	285/40R19
21" Summer	Front	265/35ZR21
	Rear	295/30ZR21
21" All-Season	Front	265/35R21
	Rear	295/30R21
In Mexico:		
19" Summer	Front	255/45R19
	Rear	285/40R19
21" Summer	Front	265/35ZR21
	Rear	295/30ZR21
Tire pressures vary depending on the type of tires fitted. Refer to the tire pressures printed on the Tire and Loading Information label. This label is located on the center door pillar and is visible when the driver's door is open (see Maintaining Tire Pressures on page 173).		
Winter tires can be purchased from a Tesla service center or may be available for purchase on the Tesla web site.		



Understanding Tire Markings

Laws require tire manufacturers to place standardized information on the sidewall of all tires. This information identifies and describes the fundamental characteristics of the tire. It also provides the tire identification number (TIN) for certification of safety standards, and in case of a recall.



1. **Tire category:** P indicates that the tire is for passenger vehicles.
2. **Tire width:** This 3-digit number is the width (in millimeters) of the tire from sidewall edge to sidewall edge.
3. **Aspect ratio:** This 2-digit number is the sidewall height as a percentage of the tread width. So, if the tread width is 205 mm, and the aspect ratio is 50, the sidewall height is 102 mm.
4. **Tire construction:** R indicates that the tire is of Radial ply construction.
5. **Wheel diameter:** This 2-digit number is the diameter of the wheel rim in inches.
6. **Load index:** This 2 or 3-digit number is the weight each tire can support. This number is not always shown.
7. **Speed rating:** When stated, indicates the maximum speed (in mph) at which the tire can be used for extended periods. Q=99 mph (160 km/h), R=106 mph (170 km/h), S=112 mph (180 km/h), T=118 mph (190 km/h), U=124 mph (200 km/h), H=130 mph (210 km/h), V=149 mph (240 km/h), W=168 mph (270 km/h), Y=186 mph (300 km/h), (Y)=vehicle's top speed (exceeds the "Y" rating).



Wheels and Tires

8. **Tire composition and materials:** The number of plies in both the tread area and the sidewall area indicates how many layers of rubber coated material make up the structure of the tire. Information is also provided on the type of materials used.
9. **Maximum tire load:** The maximum load which can be carried by the tire.
10. **Maximum permissible inflation pressure:** This pressure should not be used for normal driving.
11. **U.S. DOT Tire Identification Number (TIN):** Begins with the letters DOT and indicates that the tire meets all federal standards. The next 2 digits/letters represent the plant code where it was manufactured, and the last 4 digits represent the week and year of manufacture. For example, the number 1712 is used to represent the 17th week of 2012. The other numbers are marketing codes used at the manufacturer's discretion. This information can be used to contact consumers if a tire defect requires a recall.
12. **Treadwear grade:** This number indicates the tire's wear rate. The higher the treadwear number is, the longer it should take for the tread to wear down. A tire rated at 400, for example, lasts twice as long as a tire rated at 200.
13. **Traction grade:** Indicates a tire's ability to stop on wet roads. A higher graded tire should allow you to stop your vehicle in a shorter distance than a tire with a lower grade. Traction is graded from highest to lowest as AA, A, B, and C.
14. **Temperature grade:** The tire's resistance to heat is grade A, B, or C, with A indicating the greatest resistance. This grading is provided for a correctly inflated tire, which is being used within its speed and loading limits.



Uniform Tire Quality Grading

The following information relates to the tire grading system developed by the National Highway Traffic Safety Administration (NHTSA), which grades tires by tread wear, traction and temperature performance. Tires that have deep tread, and winter tires, are exempt from these marking requirements.

Where applicable, quality grades are found on the tire's sidewall between the tread shoulder and maximum section width. For example:

- TREADWEAR 180
- TRACTION AA
- TEMPERATURE A

The quality grades are described next.

NOTE: In addition to the marking requirements, passenger car tires must conform to Federal Safety Requirements.

Treadwear

The treadwear grade is a comparative rating based on the wear rate of the tire when tested under controlled conditions on a specified government test course.

For example, a tire graded 150 wears one and a half times better on a government test course than a tire graded 100. The relative performance of tires depends on the actual conditions of their use, however, and can depart significantly from the norm due to variations in driving habits, service practices, road characteristics, and climate.

Traction

The traction grades, from highest to lowest, are: AA, A, B, and C. These grades represent a tire's ability to stop on wet pavement as measured under controlled conditions on test surfaces of asphalt and concrete. A tire marked C might have poor traction performance.



WARNING: Defective tires are dangerous. Do not drive if a tire is damaged, excessively worn, or is inflated to an incorrect pressure. The safety of the vehicle and occupants can be adversely affected. Check tires regularly for wear and to ensure there are no cuts, bulges or exposure of the ply/cord structure.



WARNING: The traction grade assigned to the tire is based on straight-ahead braking tests, and does not include: acceleration, cornering, hydroplaning or peak traction characteristics.

Temperature

The temperature grades are A (the highest), B, and C, representing the tire's resistance to the generation of heat and its ability to dissipate heat when tested under controlled conditions on a specified indoor laboratory test wheel. Sustained high temperature can cause the tire to degenerate and reduce tire life, and excessive temperature can lead to sudden tire failure.

The grade C corresponds to the minimum level of performance that all passenger car tires must meet under the Federal Motor Safety Standard No. 109. Grades B and A represent levels of performance on the laboratory test wheel that exceed the minimum requirements.



WARNING: A tire's temperature grade is established for a tire that is properly inflated and not overloaded. Excessive speed, under-inflation, or excessive loading, either separately or in combination, can cause heat buildup and possible tire failure.

Tire and Loading Glossaries

General Wheel and Tire Terms

Accessory Weight	The combined weight (in excess of those items replaced) of items available as factory installed equipment.
Bead	The inner edge of a tire that is shaped to fit to the rim and form an air tight seal. The bead is constructed of steel wires which are wrapped, or reinforced, by the ply cords.
Cold Tire Pressure	The air pressure in a tire that has been standing in excess of three hours, or driven for less than one mile.
Curb Weight	The weight of a standard vehicle, including any optional equipment fitted, and with the correct fluid levels.
Gross Vehicle Weight	The maximum permissible weight of a vehicle with driver, passengers, load, luggage, and equipment.
kPa (kilo pascal)	A metric unit used to measure pressure. One kilo pascal equals approximately 0.145 psi.
Maximum Inflation Pressure	The maximum pressure to which the tire should be inflated. This pressure is given on the tire side wall in psi (lbf/in ²).  CAUTION: This pressure marked on the tire is the maximum allowed by the tire manufacturer. It is not the pressure Tesla recommends using for Model S.
Maximum Loaded Vehicle Weight	The sum of curb weight, accessory weight, vehicle capacity weight, and production options weight.
Production Options Weight	The combined weight of options installed which weigh in excess of 3 lb (1.4 kg) more than the standard items that they replaced, and are not already considered in curb or accessory weights.
PSI (lbf/in ²)	Pounds per square inch (the unit used to measure tire pressure).
Recommended Tire Inflation Pressure	Tire inflation pressure, established by Tesla, which is based on the type of tires that are mounted on the vehicle at the factory. This information can be found on the Tire and Loading Information label located on the door pillar.
Rim	The metal support for a tire, or tire and tube, upon which the tire beads are seated.
Vehicle Capacity Weight	The number of seats multiplied by 150 lbs (68 kg) plus the rated amount of load/luggage.

Load Carrying Definitions

Normal occupant weight	68 kilograms (150 lbs) times the number of occupants specified in the second column of the tables for calculating load limits (see Vehicle Loading on page 188).
Occupant distribution	Distribution of occupants in a vehicle.
Passenger car tire	A tire intended for use on passenger cars, multipurpose passenger vehicles, and trucks, that have a Gross Vehicle Weight Rating (GVWR) of 10,000 lbs (4536 kg) or less.
Rim diameter	Nominal diameter of the bead seat.
Rim size designation	Rim diameter and width.
Rim type designation	The manufacturing industry's designation for a rim by style or code.
Rim width	Nominal distance between the rim's flanges.
Vehicle maximum load on the tire	Load on an individual tire that is determined by distributing to each axle its share of the maximum loaded vehicle weight and dividing by two.



Vehicle normal load on the tire	Load on an individual tire that is determined by distributing to each axle its share of the curb weight, accessory weight, and normal occupant weight and dividing by two.
---------------------------------	--

Pneumatic Radial Tire Definitions

Bead separation	A breakdown of the bond between components in the bead.
Bias ply tire	A pneumatic tire in which the ply cords that extend to the beads are laid at alternate angles substantially less than 90 degrees to the center line of the tread.
Carcass	The tire structure, except tread and sidewall rubber which, that when inflated, bears the load.
Chunking	The breaking away of pieces of the tread or sidewall.
Cord	The strands forming the plies in the tire.
Cord separation	The parting of cords from adjacent rubber compounds.
Cracking	Any parting within the tread, sidewall, or inner liner of the tire extending to cord material.
Extra load tire	A tire designed to operate at higher loads and higher inflation pressure than the corresponding standard tire.
Groove	The space between two adjacent tread ribs.
Inner liner	The layer(s) forming the inside surface of a tubeless tire that contains the inflating medium within the tire.
Inner liner separation	The parting of the inner liner from cord material in the carcass.
Load rating	The maximum load that a tire is rated to carry for a given inflation pressure.
Maximum load rating	The load rating for a tire at the maximum permissible inflation pressure for that tire.
Measuring rim	The rim on which a tire is fitted for physical dimension requirements.
Open splice	Any parting at any junction of tread, sidewall, or inner liner that extends to the cord material.
Outer diameter	The overall diameter of an inflated new tire.
Overall width	The linear distance between the exteriors of the sidewalls of an inflated tire, including elevations due to labeling, decorations, or protective bands or ribs.
Ply	A layer of rubber-coated parallel cords.
Ply separation	A parting of rubber compound between adjacent plies.
Pneumatic tire	A mechanical device made of rubber, chemicals, fabric and steel or other materials, that, when mounted on an automotive wheel, provides the traction and contains the gas or fluid that sustains the load.
Radial ply tire	A pneumatic tire in which the ply cords that extend to the beads are laid at substantially 90 degrees to the center line of the tread.
Reinforced tire	A tire designed to operate at higher loads and at higher inflation pressures than the corresponding standard tire.
Section width	The linear distance between the exteriors of the sidewalls of an inflated tire, excluding elevations due to labeling, decoration, or protective bands.
Sidewall	The portion of a tire between the tread and bead.
Sidewall separation	The parting of the rubber compound from the cord material in the sidewall.



Wheels and Tires

Snow tire	A tire that attains a traction index equal to or greater than 110, compared to the ASTM E1136-93 (re-approved 2003, incorporated by reference, see §571.5) Standard Reference Test Tire when using the snow traction test as described in ASTM F1805-00 (incorporated by reference, see §571.5), and that is marked with an Alpine Symbol specified in S5.5(i) on at least one sidewall.
Test rim	The rim on which a tire is fitted for testing, and may be any rim listed as appropriate for use with that tire.
Tread	The portion of a tire that comes into contact with the road.
Tread rib	A tread section running around the circumference of a tire.
Tread separation	The pulling away of the tread from the tire carcass.
Tread wear indicators (TWI)	The projections within the principal grooves designed to give a visual indication of the degrees of wear of the tread.
Wheel-holding fixture	The fixture used to hold the wheel and tire assembly securely during testing.



Tesla Roadside Assistance is available to you 24 hours a day, 365 days a year, for the duration of your warranty period. Tesla Roadside Assistance is also available to speak with roadside service professionals to answer any questions and explain the proper procedure for transporting your vehicle.

When contacting Tesla Roadside Assistance, please provide:

- The Vehicle Identification Number (VIN). The VIN is displayed when you touch **Controls > Software**. The VIN can also be seen on the upper dashboard by looking through the driver's side of the windshield.
- Your exact location.
- The nature of the problem.

If available in your region, you can also expedite your request, by choosing the Roadside Assistance option in the Tesla mobile app.

NOTE: For a detailed description of Tesla's Roadside Assistance policy, go to the support page on the Tesla web site for your region.

Regional Phone Number(s)

Canada: [1-877-79TESLA \(1-877-798-3752\)](tel:1-877-79TESLA)

Mexico: [1-800-228-8145](tel:1-800-228-8145)

United States: [1-877-79TESLA \(1-877-798-3752\)](tel:1-877-79TESLA)

NOTE: The phone number is also available by touching **Controls > Service**.



Instructions for Transporters

DO NOT TRANSPORT WITH WHEELS ON THE GROUND

The front and rear motors in Model S generate power when the wheels spin. Always transport Model S with all four tires off the ground. Ensure that the tires are unable to spin at any time during transport.

WARNING: NEVER TRANSPORT YOUR VEHICLE WITH THE TIRES IN A POSITION WHERE THEY CAN SPIN. DOING SO CAN LEAD TO SIGNIFICANT DAMAGE AND OVERHEATING. IN RARE CASES EXTREME OVERHEATING MAY CAUSE THE SURROUNDING COMPONENTS TO IGNITE.

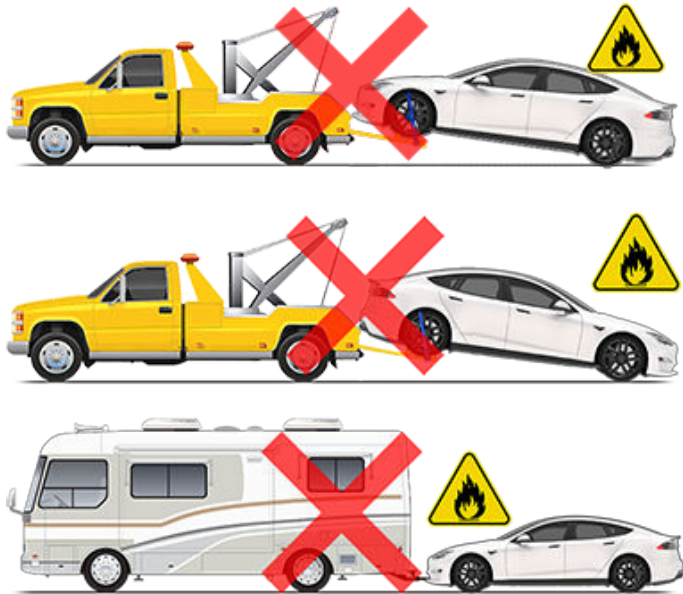

Do not transport Model S using any method that is not specified by Tesla. Adhere to the instructions provided in the following sections and observe all warnings and cautions provided. Damage caused by improper transporting of your vehicle is not covered by the warranty.

NOTE: Tesla is not liable or responsible for reimbursing services not dispatched through Tesla Roadside Assistance.

Approved Methods for Transporting

A flatbed truck or comparable transport vehicle is the recommended method of transporting Model S. The vehicle can face either direction when using a flatbed.



If Model S must be transported without a flatbed truck, then wheel lifts and dollies must be used to ensure that all four wheels are off the ground. This method may only be used for a maximum of 35 miles (55 km), and must not exceed the manufacturer speed rating of the dollies. With this method, Tesla recommends the vehicle faces forward so that the front wheels are lifted and the rear wheels are on dollies.

NOTE: Transporting Model S with the front wheels on dollies is not recommended, but may be done if an external steering yoke (or steering wheel) lock is applied and care is taken to prevent the front wheels from spinning.

CAUTION: DO NOT TRANSPORT YOUR VEHICLE IF THERE IS ANY CHANCE OF ANY OF THE WHEELS SPINNING.



CAUTION: Enable Transport Mode (see [Activate Transport Mode on page 203](#)) before winching Model S onto a flatbed truck. If Transport Mode is not available or the touchscreen is not accessible, self-loading dollies or tire skates must be used to load the vehicle into the approved transportation position. Tesla is not responsible for any damage caused by or during the transport of Model S, including personal property damage or damage caused by using self-loading dollies or tire skates.

NOTE: Transport Mode is only intended to allow for winching Model S onto a flatbed truck or repositioning the vehicle out of a parking space. While in Transport Mode, the tires are allowed to rotate slowly (under 3 mph or 5 km/h) and for a very short distance (less than 30 feet or 10 meters). See [Activate Transport Mode on page 203](#). Exceeding these boundaries can lead to significant damage and overheating that is not covered by the warranty.

WARNING: Model S is equipped with high voltage components that may be compromised as a result of a collision (see [High Voltage Components on page 159](#)). Before transporting Model S, it is important to assume these components are energized. Always follow high voltage safety precautions (wearing personal protection equipment, etc.) until emergency response professionals have evaluated the vehicle and can accurately confirm that all high voltage systems are no longer energized. Failure to do so may result in serious injury.



Disable the Self-Leveling Air Suspension System

NOTE: If Model S has no low voltage power, you need an external low voltage power supply to use the touchscreen. See [If Vehicle Has No Power on page 205](#).

Your Model S is equipped with an air suspension system that automatically self-levels the vehicle, even when power is off. To prevent damage, you must activate Jack mode to disable self-leveling:

1. Touch **Controls** > **Suspension** on the touchscreen.
2. Press the brake pedal, and then touch **Very High** to maximize height.
3. Touch **Controls** > **Service** > **Jack Mode**.

NOTE: Jack mode cancels when driving speed exceeds 4 mph (7 km/h).

Activate Transport Mode

Transport Mode keeps the parking brake disengaged while winching Model S onto a flatbed truck. When active, Transport Mode displays a message indicating that the vehicle will remain free-rolling. The following are required to enable Transport Mode:

- Low voltage power. You are unable to use the touchscreen to activate Transport Mode if Model S has no power.
- Model S must detect a key. Transport Mode is available only when a key is detected.

To activate Transport Mode:

1. Ensure the vehicle is in Park.
2. Chock the tires and make sure Model S is secure.
3. Press and hold the brake pedal, and then on the touchscreen, touch **Controls** > **Service** > **Towing**. The touchscreen displays a message reminding you how to properly transport Model S.
4. Press and hold the **Transport Mode** button until it turns blue. Model S is now free-rolling and can slowly be rolled (no faster than walking speed) for short distances or winched.

To cancel Transport Mode, shift Model S into Park.

NOTE: If the electrical system is not working, and you therefore cannot use the touchscreen to activate Transport Mode, use self-loading dollies or tire skates. Before doing so, always check the manufacturer's specifications and recommended loading capacity.

Pull Onto Flatbed Truck From Front (Using Tow Eye)

NOTE: If Model S has no low voltage power, you need an external low voltage power supply to open the hood or use the touchscreen. See [If Vehicle Has No Power on page 205](#).



CAUTION: To avoid damage, only pull the vehicle onto a flatbed truck using a properly-installed tow eye. Using the chassis, frame, or suspension components to pull the vehicle can result in damage.

1. Locate the tow eye. The tow eye is located in the front trunk.



2. Release the front tow eye cover by pressing firmly on its top right perimeter until it pivots inward, then gently pulling the raised section toward you.

NOTE: The front tow eye cover is connected to the vehicle's black negative (-) terminal.

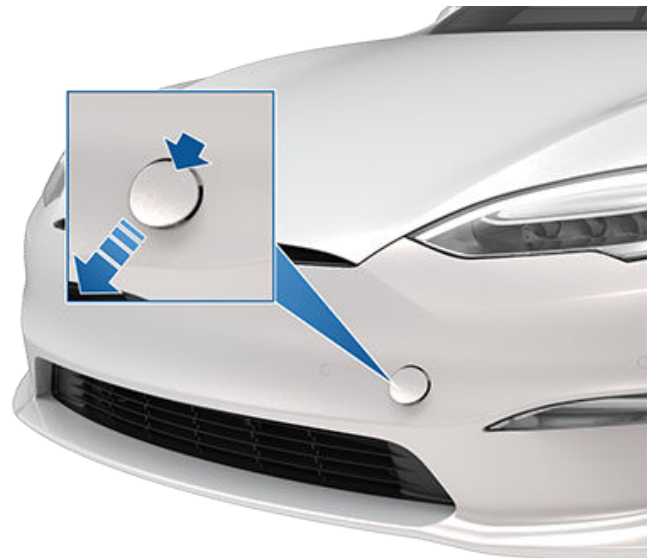

3. Fully insert the tow eye into the opening, then turn it **counter-clockwise** until securely fastened.



Instructions for Transporters

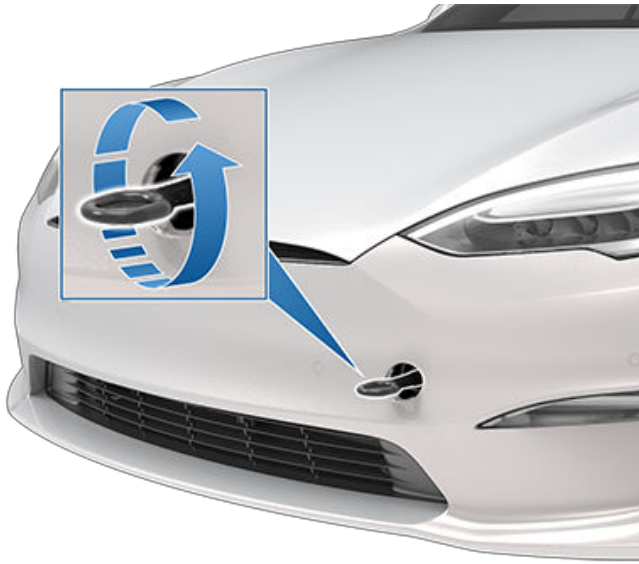

4. Attach the winch cable to the tow eye.

CAUTION: Before pulling, make sure the tow eye is securely tightened.

5. Activate Transport Mode.
6. Pull Model S slowly onto the flatbed truck.

Pull Onto Flatbed Truck From Rear (Using Tow Eye)

NOTE: If Model S has no low voltage power, you need an external low voltage power supply to open the hood or use the touchscreen. See [If Vehicle Has No Power](#) on page 205.

NOTE: Vehicles equipped with a hitch receiver cannot be pulled from the rear tow eye. Use the tow bar or hitch receiver only to pull the vehicle to a safe location, such as onto a flatbed truck. Do not transport the vehicle with wheels on the ground.

CAUTION: To avoid damage, only pull the vehicle onto a flatbed truck using a properly-installed tow eye. Using the chassis, frame, or suspension components to pull the vehicle can result in damage.

1. Locate the tow eye. The tow eye is located in the front trunk.

2. Release the rear tow eye cover by pressing firmly on its bottom perimeter until it pivots inward, then gently pulling the raised section toward you.

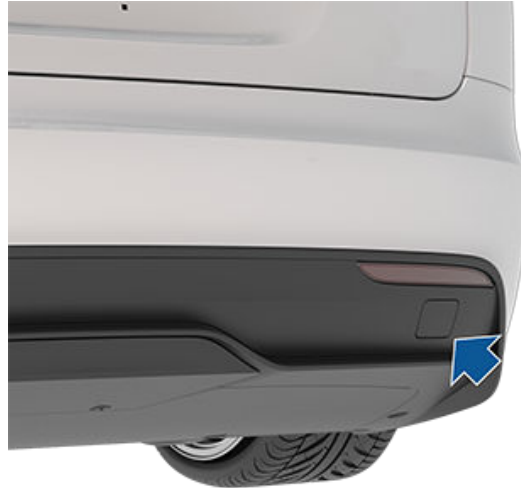

3. Fully insert the tow eye into the opening, then turn it **counter-clockwise** until securely fastened.

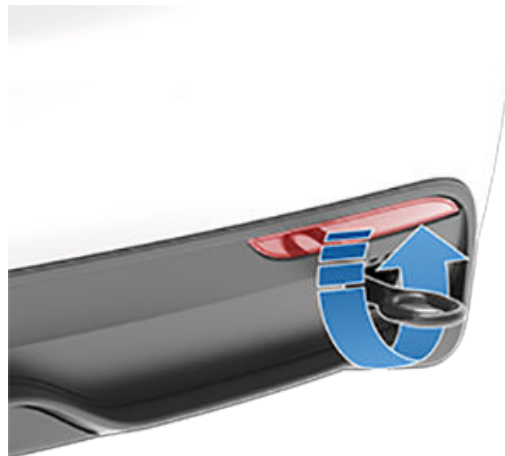

4. Attach the winch cable to the tow eye.

CAUTION: Before pulling, make sure the tow eye is securely tightened.

5. Activate Transport Mode.
6. Pull Model S slowly onto the flatbed truck.



Pull onto the Flatbed Truck From Front (Without Tow Eye)

CAUTION: To avoid damage, only pull the vehicle onto a flatbed truck using a properly-installed tow eye. Using the chassis, frame, or suspension components to pull the vehicle can result in damage.

WARNING: If the vehicle is pulled onto the flatbed truck using this method, all suspension fasteners should be checked for proper torque and all components should be visually inspected for damage prior to driving the vehicle again. If a fastener is loose, or if any damage is found, the affected component(s) should be replaced.

It is strongly recommended that you connect the winch to your vehicle's tow eye, as described previously. However, if a situation arises in which the tow eye is not available (lost, misplaced, etc.), the following instructions describe how to attach tow straps.

1. Attach the tow straps to each of the lower suspension arms underneath the front of the vehicle.

CAUTION: Do not attach the tow straps to any other suspension component. Only attach tow straps to the lower suspension arms, as shown below.



2. To protect the underbody from damage, place a protective barrier (such as a piece of wood) between the tow strap and underbody.
3. Activate Transport Mode.
4. Pull Model S slowly onto the flatbed truck.

Secure the Tires

The vehicle's tires must be secured onto the truck using the eight-point tie-down method.

- Ensure any metal parts on the tie-down straps do not contact painted surfaces or the face of the wheels.

- Do not place tie-down straps over body panels or through the wheels.

CAUTION: Attaching the tie-down straps to the chassis, suspension or other parts of the vehicle's body may cause damage.



If Vehicle Has No Power

If Model S has no low voltage power, perform the following steps to open the hood or jump start the low voltage battery.

1. Open the hood. See [Opening Hood with No Power on page 23](#) for more information on opening the hood if the vehicle does not have power.
2. Jump start the low voltage battery (see [Jump Starting on page 207](#)).

NOTE: Tow providers: See [Running Out of Range on page 206](#) for more information on transporting the vehicle to a charging station and preparing the vehicle to charge.



Running Out of Range

NOTE: In the unlikely event your vehicle runs out of range while driving, pull over when safe to do so and contact [Tesla Roadside Assistance on page 201](#) or your preferred tow provider.

If Model S runs out of range, the low voltage battery is no longer supported – and when low voltage is not supported, the vehicle cannot charge. Therefore, the low voltage battery must be supported by an external power supply to allow you to charge the high voltage (HV) Battery. Once the vehicle begins charging, the external power supply is no longer required.

In the case of running out of range away from a charger, the tow provider should transport Model S to the nearest charging station and unload the vehicle within the charging cable's reach. Once the vehicle is positioned next to a charger, follow these instructions:

NOTE: If the vehicle is being transported to a charger, make sure the tow provider does not leave until confirming that the vehicle's high voltage Battery is successfully charging.



1. Jump start the low voltage battery (see [Jump Starting on page 207](#)). The low voltage battery must be jump started to support the high voltage Battery.
2. Wait a few minutes. Once the touchscreen powers on, plug the charge cable into Model S to begin charging the high voltage Battery.
3. When Model S begins to charge, disconnect the external power supply from the low voltage battery.

Before transporting to a non-Tesla charger, ensure your vehicle is equipped with an adapter that accommodates the specific type of charging station you will be using. Even at a non-Tesla charger, you will need to jump start the low voltage battery before you can begin charging.

 **CAUTION:** Always ensure Model S has enough range for your drive, or for being stored for an extended period. Do not rely on the range estimates displayed on the touchscreen or mobile app as range can decrease faster than projected due to ambient temperature, driving habits, wind, vehicle settings (such as Sentry Mode), etc.

NOTE: Towing your vehicle as a result of running out of range is not covered by the warranty.

The following instructions assume you are using an external low voltage power supply (such as a portable jump starter). If jump starting Model S using another vehicle, refer to the vehicle manufacturer's instructions.

-  **CAUTION:** Model S cannot be used to jump start another vehicle. Doing so can result in damage.
-  **CAUTION:** Avoid short circuits when jump starting Model S. Connecting cables to the wrong jump post, touching leads together, etc., can damage Model S.

Follow these steps:

1. Open the hood.
2. Remove the maintenance panel by pulling it upwards to release the trim clips that hold it in place.



3. On top of the low voltage battery, lift the locking tab that attaches the electrical connector to the connector housing.

NOTE: The appearance of the electrical connector and connector housing may vary, but the procedure remains the same.

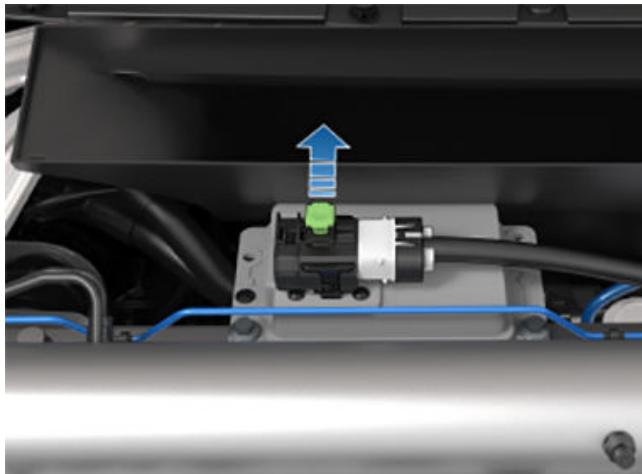

4. On top of the low voltage battery, pull the connector housing to the left. The electrical connector releases from the low voltage battery.

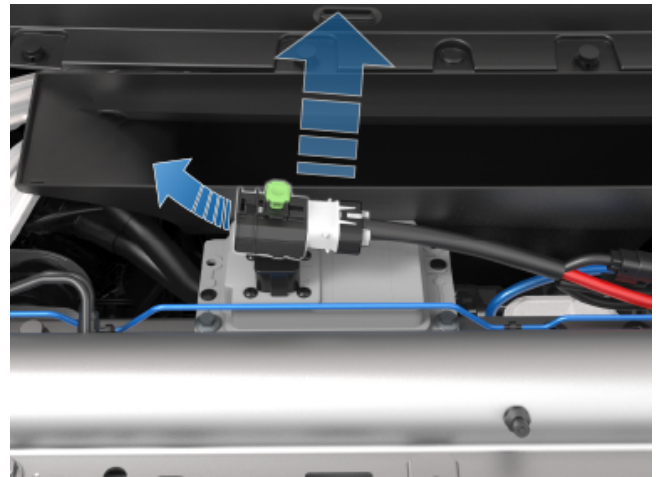

5. Release the cover from the red positive (+) jump post, and then connect the low voltage power supply's red positive (+) cable to the red positive (+) jump post.

 **CAUTION:** To avoid damaging Model S, do not allow the positive cable to contact other metal components.

NOTE: Depending on date of manufacture, the cover and the red positive (+) jump post location may differ slightly.

For vehicles manufactured prior to approximately January 2023:



For vehicles manufactured after approximately January 2023:



Jump Starting

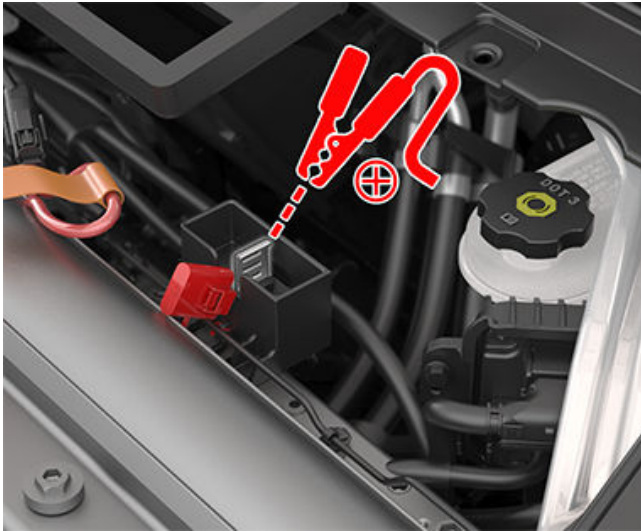

6. Connect the low voltage power supply's black negative (-) cable to the vehicle in the location shown.

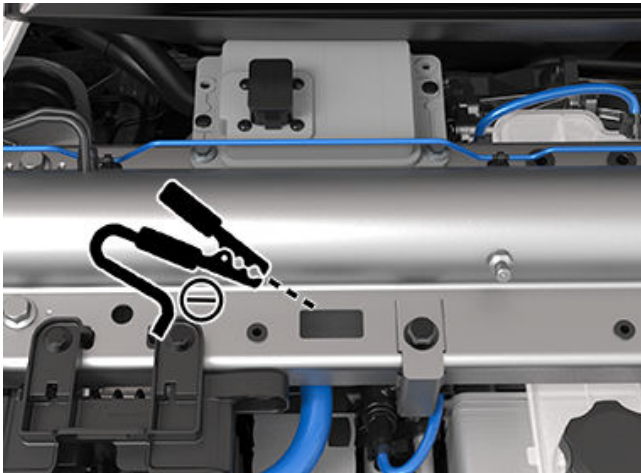

7. Turn on the external power supply (refer to the manufacturer's instructions). Touch the touchscreen to wake it up.
NOTE: It may take several minutes to receive enough power to wake up the touchscreen.
8. When external low voltage power is no longer required, disconnect both cables, beginning with the black negative (-) cable.
9. On top of the low voltage battery, push the connector housing towards the electrical connector so that the electrical connector engages the low voltage battery.
10. On top of the low voltage battery, push down the locking tab that attaches the electrical connector to the connector housing.
11. Replace the maintenance panel by placing it back in its original location and pressing down until it is secure.
12. Close the hood.



APP_w048

Autopilot features temporarily unavailable

Features may be restored on next drive

What this alert means:

Autopilot features are currently unavailable on your vehicle. Depending on the configuration of your vehicle, Autopilot features that are disabled may include:

- Autosteer
- Traffic-Aware Cruise Control
- Automatic Emergency Braking
- Forward Collision Warning
- Lane Departure Warning

What to do:

This alert can be set for several reasons. Check for additional alerts that indicate the cause of this condition.

Typically, Autopilot features are restored on your next drive. If this alert persists across multiple drives, schedule service at your earliest convenience.

For more information and the full list of Autopilot features, see [About Autopilot on page 81](#).

APP_w207

Autosteer temporarily unavailable

What this alert means:

Autosteer is temporarily unavailable. This could be a temporary condition caused by an external factor, such as:

- Missing or faded lane markers.
- Narrow or winding roads.
- Poor visibility due to rain, snow, fog, or other weather.
- Extremely hot or cold temperatures.
- Bright light due to other vehicle headlights, direct sunlight, or other light sources.

This alert will also be present if you exceeded the maximum speed limit for Autosteer with Autosteer active. In this case, Autosteer will not be available for the rest of your current drive.

What to do:

Continue to your destination. If Autosteer is not available by the time you reach your destination, and remains unavailable during your next planned drive, check for the following:

- Damage or obstruction caused by mud, ice, snow, or other environmental factors
- Obstruction caused by an object mounted on the vehicle, like a bike rack
- Obstructions caused by adding paint or adhesive products like wraps, stickers, or rubber coatings to your vehicle
- A damaged or misaligned bumper

If there are no obvious obstructions, or if you find damage to the vehicle, schedule service at your convenience. Your vehicle is OK to drive in the meantime.

For more information, see [Autosteer on page 88](#).

APP_w218

Autosteer speed limit exceeded

Take control of steering wheel

What this alert means:

Autosteer is unavailable because your vehicle has exceeded the maximum speed limit for this driver assistance feature.

What to do:

Take immediate control of the steering yoke (or steering wheel) and maintain control until you reach your destination.

In most cases, Autosteer will not be available for the rest of your current drive. To reset it, bring the vehicle to a complete stop and shift into Park. When you shift into Drive to travel to your next destination, Autosteer should be available again.

NOTE: If this alert becomes active while you are driving in Germany, Autosteer should be available again once your vehicle is traveling below the Autosteer speed limit.

If Autosteer is not available during your next drive, and remains unavailable throughout subsequent drives, schedule service at your convenience. Your vehicle is OK to drive in the meantime.

For more information, see [Autosteer on page 88](#).

APP_w221

Cruise control unavailable

Reduced front radar visibility

What this alert means:

Traffic-Aware Cruise Control and Autosteer are unavailable because the radar located in the front bumper area of your vehicle has no or low visibility.

This could be a temporary obstruction caused by factors like snow, ice, dirt, or mud.

What to do:

Continue to your destination. Your vehicle is OK to drive. Traffic-Aware Cruise Control and Autosteer will remain unavailable as long as the radar lacks adequate visibility.

If the alert persists throughout your drive, examine the front bumper before your next planned drive and attempt to clear any obstruction. See the [About Autopilot on page 81](#) sections “How It Works” and “Cleaning Cameras and Sensors” for more information on clearing dirt or debris from that area of the vehicle.

If this alert persists throughout subsequent drives but no obstruction is visible on the front bumper where the radar is located, schedule service at your earliest convenience. Your vehicle is OK to drive in the meantime.

APP_w222

Cruise control unavailable

Reduced front camera visibility

What this alert means:

Traffic-Aware Cruise Control and Autosteer are unavailable because one or more of the front cameras in your vehicle is blocked or blinded by external conditions.

Traffic-Aware Cruise Control and Autosteer will remain unavailable while a front camera lacks adequate visibility. Cameras can be blocked or blinded by:



- Dirt or debris on the camera surface.
- Environmental conditions like rain, fog, snow, or dew.
- Bright sunlight or glare from another light source.
- Condensation (water droplets or mist) on the camera surface.

What to do:

Continue to your destination. Your vehicle is OK to drive.

This is often a temporary issue that clears up on its own. If the alert does not clear by the end of your drive:

- Inspect and clean the front camera area at the top center of the windshield before your next planned drive.
- Check the camera surface for condensation, dirt, or other debris and attempt to clear any obstruction.

See the [About Autopilot on page 81](#) sections “How It Works” and “Cleaning Cameras and Sensors” for more information on clearing dirt or debris from that area of the vehicle.

Although condensation on the inside of the front camera enclosure cannot be wiped clean, you can usually clear it quicker by following these steps:

1. Pre-condition the cabin with the temperature set to High and A/C turned ON.
2. Turn on the front windshield defroster.

If this alert persists throughout subsequent drives but no front camera obstruction is visible, schedule service at your earliest convenience. Your vehicle is OK to drive in the meantime.

APP_w224**Cruise control unavailable****Continue driving to allow cameras to calibrate****What this alert means:**

Traffic-Aware Cruise Control and Autosteer are unavailable because the cameras on your vehicle are not fully calibrated.

Your vehicle must maneuver with great precision when features like Traffic-Aware Cruise Control and Autosteer are active. Before these features can be used for the first time, the cameras must complete an initial self-calibration. Occasionally, one or more cameras can become uncalibrated.

What to do:

Continue to your destination. Your vehicle is OK to drive.

Traffic-Aware Cruise Control and Autosteer will remain unavailable until camera calibration is complete.

When calibration is complete, Traffic-Aware Cruise Control and Autosteer should be available.

For your convenience, a calibration progress indicator is displayed on the touchscreen. Calibration typically completes after your vehicle has driven 20-25 miles (32-40 km), but the distance varies depending on road and environmental conditions. For example, driving on a straight road with highly visible lane markings helps the cameras calibrate quicker.

If the alert persists and camera calibration has not completed after your vehicle has driven 100 miles (160 km) or more, or Traffic-Aware Cruise Control and Autosteer remain unavailable despite successful camera calibration, schedule service at your earliest convenience. Your vehicle is OK to drive in the meantime.

APP_w304

Camera blocked or blinded

Clean camera or wait for it to regain visibility

What this alert means:

One or more of the vehicle cameras is blocked or blinded due to external conditions. When the cameras cannot provide accurate visual information, some or all Autopilot features may be temporarily unavailable.

Cameras can be blocked or blinded by:

- Dirt or debris on the camera surface.
- Environmental conditions like rain, fog, snow, or dew.
- Bright sunlight or glare from another light source.
- Condensation (water droplets or mist) on the camera surface.

What to do:

Continue to your destination. Your vehicle is OK to drive. This is often a temporary issue that will be resolved when condensation evaporates or a particular environmental condition is no longer present.

If the alert does not clear by the time you reach your destination, check camera surfaces for condensation, dirt, or other debris. For camera locations, see [About Autopilot on page 81](#).

Clean the cameras as necessary before your next planned drive. For recommended cleaning procedures, see [Cleaning Cameras and Sensors on page 83](#).

If you continue to see this alert after cleaning the cameras, check the inside surfaces of the door pillar camera enclosures for condensation. Although condensation inside the camera enclosures cannot be wiped clean, you can usually clear it faster by following these steps:

1. Pre-condition the cabin with the temperature set to High and A/C turned ON.
2. Turn on the front windshield defroster.
3. Direct the air vents toward the door pillar cameras.

For more information on clearing condensation from camera enclosures, see [Cleaning Cameras and Sensors on page 83](#).

If the alert does not clear by the end of your next planned drive, despite cleaning the indicated camera(s) and following recommended steps to clear condensation, schedule service at your next convenient opportunity. Your vehicle is OK to drive in the meantime.

BMS_a066

Maximum charge level and range may be reduced

OK to drive - Schedule service soon

What this alert means:

Your vehicle has detected a condition internal to the high voltage battery that is limiting the battery's performance. As a result, maximum charge level and range may be reduced. Service is required to restore full performance.

What to do:

Your vehicle is OK to drive.

If this alert persists, schedule service at your earliest convenience. Without service, you may notice further reductions in your vehicle's maximum charge level and range.



For more information on the high voltage battery, see [High Voltage Battery Information on page 161](#).

BMS_a067 **High voltage battery performance limited** **OK to drive - Schedule service soon**

What this alert means:

Your vehicle has detected a condition internal to the high voltage battery that is limiting the battery's performance. Service is required to restore full performance.

Your vehicle's maximum range may be reduced, and your vehicle may take longer to charge than before. Maximum charge rate varies, as always, based on location, power source, and charging equipment.

What to do:

Your vehicle is OK to drive.

It is recommended that you schedule service at your earliest convenience. Without service, your vehicle may continue to show further reductions in maximum range and charging performance and may also begin to show reduced power and acceleration when driving.

While this alert remains present, keep your vehicle charged to 30% capacity or higher to avoid any discrepancy between the estimated range displayed on your vehicle's touchscreen and the actual high voltage battery charge level.

For more information on the high voltage battery, see [High Voltage Battery Information on page 161](#).

BMS_a068 **High voltage battery requires service** **Acceleration and charging performance reduced**

What this alert means:

Your vehicle has detected a condition internal to the high voltage battery that is limiting the battery's performance.

You may notice that your vehicle's top speed is reduced and it responds slower than previously to acceleration requests.

Your vehicle's maximum range may be reduced, and your vehicle may take longer to charge than before. Maximum charge rate varies, as always, based on location, power source, and charging equipment.

Service is required to restore full performance.

What to do:

Your vehicle is OK to drive.

It is recommended that you schedule service at your earliest opportunity. Without service, your vehicle may continue to show reduced power, acceleration, range, and charging performance.

While this alert remains present, keep your vehicle charged to 30% capacity or higher to avoid any discrepancy between the estimated range displayed on your vehicle's touchscreen and the actual high voltage battery charge level.

For more information on the high voltage battery, see [High Voltage Battery Information on page 161](#).

BMS_a069

Battery charge level low

Charge now

What this alert means:

Your vehicle has detected that the high voltage battery does not have enough energy remaining to support driving. This alert is usually present because your vehicle's high voltage battery charge level has been reduced through normal operation.

Your vehicle will be unable to drive or continue driving until charged.

If this alert is present while you are driving, your vehicle needs to shut down. A separate vehicle alert should be present to indicate this condition. It is also possible your vehicle may shut down unexpectedly.

If this alert is present when your vehicle is parked, you may be unable to drive.

What to do:

Charge your vehicle immediately. Charging your vehicle should restore your vehicle's ability to drive.

If this alert occurs during subsequent drives, despite a displayed battery charge level of 5% or higher, schedule service at your earliest convenience.

For more information on the high voltage battery, see [High Voltage Battery Information on page 161](#).

For more information on charging, see [Charging Instructions on page 163](#).

CC_a001

Unable to charge - Insufficient grounding

Proper wiring or outlet grounding must be verified

What this alert means:

No ground connection detected in the Wall Connector.

What to do:

Have the Wall Connector inspected by an electrician to make sure it is properly grounded. Your electrician should ensure there is proper grounding at your circuit breaker or power distribution box and also ensure that appropriate connections are made to the Wall Connector.

For more information, see the [installation guide](#) for your Wall Connector.

CC_a002

Unable to charge - Insufficient grounding

Disconnect and retry or use different equipment

What this alert means:

Ground fault. Current is leaking through an unsafe path. Possible Line to ground or Neutral to ground fault.

What to do:

Try charging again by disconnecting the Wall Connector from the vehicle and reconnecting. If the issue persists, turn OFF the circuit breaker servicing the Wall Connector, wait 10 seconds, turn the circuit breaker ON again, then try reconnecting the Wall Connector to the vehicle. If the issue persists, consult your electrician or contact Tesla.

For more information, see the [installation guide](#) for your Wall Connector.

**CC_a003****Unable to charge - Wall Connector GFCI tripped
Disconnect and retry or use different equipment****What this alert means:**

Ground fault. Current is leaking through an unsafe path. Possible Line to ground or Neutral to ground fault.

What to do:

Try charging again by disconnecting the Wall Connector from the vehicle and reconnecting. If the issue persists, turn OFF the circuit breaker servicing the Wall Connector, wait 10 seconds, turn the circuit breaker ON again, then try reconnecting the Wall Connector to the vehicle. If the issue persists, consult your electrician or contact Tesla.

For more information, see the [installation guide](#) for your Wall Connector.

CC_a004**Unable to charge - Wall Connector issue
Wall Connector needs service****What this alert means:**

Wall Connector hardware issue. Possible issues include:

1. Contactor not working
2. Self-test of internal ground fault monitoring circuit failed
3. Thermal sensor disconnected
4. Other hardware component issues

What to do:

An internal issue was detected by the Wall Connector.

1. Try charging again by disconnecting the Wall Connector from the vehicle and reconnecting.
2. If the issue persists, turn OFF the circuit breaker for the Wall Connector, wait 10 seconds, and turn the circuit breaker ON again. Then try reconnecting the Wall Connector to the vehicle.
3. If the issue persists, have an electrician make sure all wires are properly connected and torqued according to the instructions in the Wall Connector Installation Manual.
4. Once your electrician has completed all work and restored power to the Wall Connector, try charging again by reconnecting the Wall Connector to the vehicle.
5. If the issue persists, the Wall Connector requires service.

For more information, see the [installation guide](#) for your Wall Connector.

CC_a005**Unable to charge - Wall Connector GFCI tripped
Disconnect and retry or use different equipment****What this alert means:**

Ground fault. Current is leaking through an unsafe path. Possible Line to ground or Neutral to ground fault.

What to do:



Troubleshooting Alerts

Try charging again by disconnecting the Wall Connector from the vehicle and reconnecting. If the issue persists, turn OFF the circuit breaker servicing the Wall Connector, wait 10 seconds, turn the circuit breaker ON again, then try reconnecting the Wall Connector to the vehicle. If the issue persists, consult your electrician or contact Tesla.

For more information, see the [installation guide](#) for your Wall Connector.

CC_a006

Unable to charge - Wall Connector overcurrent Disconnect and retry or use different equipment

What this alert means:

Over current protection.

What to do:

Reduce the vehicle's charge current setting. If the issue persists, service is required.

For more information, see the [installation guide](#) for your Wall Connector.

CC_a007

Unable to charge - Input voltage too high Voltage must be within Wall Connector rating

What this alert means:

Over or under voltage protection.

What to do:

Consult your electrician to ensure appropriate voltage on the circuit breaker that services the Wall Connector.

For more information, see the [installation guide](#) for your Wall Connector.

CC_a008

Unable to charge - Input voltage too low Voltage must be within Wall Connector rating

What this alert means:

Over or under voltage protection.

What to do:

Consult your electrician to ensure appropriate voltage on the circuit breaker that services the Wall Connector.

For more information, see the [installation guide](#) for your Wall Connector.

CC_a009

Unable to charge - Input wired incorrectly Input wiring to Wall Connector must be corrected

What this alert means:

Input miswired: possibly Line and Neutral are swapped.

What to do:



The wiring between the wall power and the Wall Connector has been incorrectly installed. Consult your electrician.

For more information, see the [installation guide](#) for your Wall Connector.

CC_a010 **Unable to charge - Wall Connector issue** **Wall Connector needs service**

What this alert means:

Wall Connector hardware issue. Possible issues include:

1. Contactor not working
2. Self-test of internal ground fault monitoring circuit failed
3. Thermal sensor disconnected
4. Other hardware component issues

What to do:

An internal issue was detected by the Wall Connector.

1. Try charging again by disconnecting the Wall Connector from the vehicle and reconnecting.
2. If the issue persists, turn OFF the circuit breaker for the Wall Connector, wait 10 seconds, and turn the circuit breaker ON again. Then try reconnecting the Wall Connector to the vehicle.
3. If the issue persists, have an electrician make sure all wires are properly connected and torqued according to the instructions in the Wall Connector Installation Manual.
4. Once your electrician has completed all work and restored power to the Wall Connector, try charging again by reconnecting the Wall Connector to the vehicle.
5. If the issue persists, the Wall Connector requires service.

For more information, see the [installation guide](#) for your Wall Connector.

CC_a011 **Unable to charge - Wall Connector too hot** **Let Wall Connector cool and try again**

What this alert means:

Over temperature protection (latchoff).

What to do:

Make sure the Wall Connector is not covered by anything and that there is no heat source nearby. If the problem persists in normal ambient temperatures (under 100°F or 38°C) , service is required.

For more information, see the [installation guide](#) for your Wall Connector.

CC_a012 **Unable to charge - Wall connection too hot** **Outlet or Wall Connector wiring must be checked**

High temperature detected by Wall Connector alerts indicate the building connection to the Wall Connector is getting too warm, so charging has stopped to protect the wiring and Wall Connector.

Troubleshooting Alerts

This is not typically an issue with your vehicle or your Wall Connector, but rather an issue with the building wiring. This may be caused by a loose building wiring connection to the Wall Connector and can be fixed quickly by an electrician.

To regain normal charge operation, try the following steps.

If the Wall Connector is plugged into a wall outlet, make sure:

- The plug is fully inserted into the receptacle / outlet
- The plug / outlet area is not blocked or covered by anything
- There is no heat source nearby

If the issue persists or the Wall Connector is hard-wired, contact an electrician to inspect the building wiring connection to the Wall Connector. They should make sure that all wires are properly connected and torqued according to the installation guide for the Wall Connector.

For more information, see the [installation guide](#) for your Wall Connector.

CC_a013

Unable to charge - Charge handle too hot Check charge handle or charge port for debris

What this alert means:

Over temperature protection (latchoff).

What to do:

Make sure the connector is fully inserted into the charge inlet in the vehicle's charging port, is not covered by anything, and there is no heat source nearby. If the issue persists in normal ambient temperatures (under 100°F or 38°C), service is required.

For more information, see the [installation guide](#) for your Wall Connector.

CC_a014

Unable to charge - Wall Connector issue Wall Connector needs service

What this alert means:

Wall Connector hardware issue. Possible issues include:

1. Contactor not working
2. Self-test of internal ground fault monitoring circuit failed
3. Thermal sensor disconnected
4. Other hardware component issues

What to do:

An internal issue was detected by the Wall Connector.

1. Try charging again by disconnecting the Wall Connector from the vehicle and reconnecting.
2. If the issue persists, turn OFF the circuit breaker for the Wall Connector, wait 10 seconds, and turn the circuit breaker ON again. Then try reconnecting the Wall Connector to the vehicle.
3. If the issue persists, have an electrician make sure all wires are properly connected and torqued according to the instructions in the Wall Connector Installation Manual.



4. Once your electrician has completed all work and restored power to the Wall Connector, try charging again by reconnecting the Wall Connector to the vehicle.
5. If the issue persists, the Wall Connector requires service.

For more information, see the [installation guide](#) for your Wall Connector.

CC_a015

Unable to charge - Vehicle connection issue Insert charge handle fully into charge port

What this alert means:

A communication error occurred between the Wall Connector and the vehicle.

What to do:

Try charging again by disconnecting the Wall Connector from the vehicle and reconnecting.

1. If the issue persists, turn OFF the circuit breaker servicing the Wall Connector, wait 10 seconds, turn the circuit breaker ON again, then try reconnecting the Wall Connector to the vehicle.
2. If the issue persists and other charging equipment is available, plug the vehicle into another Wall Connector or a Mobile Connector to determine if the vehicle is able to communicate with other charging equipment.
3. If the issue persists, service is required.

For more information, see the [installation guide](#) for your Wall Connector.

CC_a016

Unable to charge - Vehicle connection issue Insert charge handle fully into charge port

What this alert means:

A communication error occurred between the Wall Connector and the vehicle.

What to do:

Try charging again by disconnecting the Wall Connector from the vehicle and reconnecting.

1. If the issue persists, turn OFF the circuit breaker servicing the Wall Connector, wait 10 seconds, turn the circuit breaker ON again, then try reconnecting the Wall Connector to the vehicle.
2. If the issue persists and other charging equipment is available, plug the vehicle into another Wall Connector or a Mobile Connector to determine if the vehicle is able to communicate with other charging equipment.
3. If the issue persists, service is required.

For more information, see the [installation guide](#) for your Wall Connector.

CC_a017

Unable to charge - Vehicle connection issue Insert charge handle fully into charge port

What this alert means:

A communication error occurred between the Wall Connector and the vehicle.

What to do:



Troubleshooting Alerts

Try charging again by disconnecting the Wall Connector from the vehicle and reconnecting.

1. If the issue persists, turn OFF the circuit breaker servicing the Wall Connector, wait 10 seconds, turn the circuit breaker ON again, then try reconnecting the Wall Connector to the vehicle.
2. If the issue persists and other charging equipment is available, plug the vehicle into another Wall Connector or a Mobile Connector to determine if the vehicle is able to communicate with other charging equipment.
3. If the issue persists, service is required.

For more information, see the [installation guide](#) for your Wall Connector.

CC_a018

Unable to charge - Vehicle connection issue

Insert charge handle fully into charge port

What this alert means:

A communication error occurred between the Wall Connector and the vehicle.

What to do:

Try charging again by disconnecting the Wall Connector from the vehicle and reconnecting.

1. If the issue persists, turn OFF the circuit breaker servicing the Wall Connector, wait 10 seconds, turn the circuit breaker ON again, then try reconnecting the Wall Connector to the vehicle.
2. If the issue persists and other charging equipment is available, plug the vehicle into another Wall Connector or a Mobile Connector to determine if the vehicle is able to communicate with other charging equipment.
3. If the issue persists, service is required.

For more information, see the [installation guide](#) for your Wall Connector.

CC_a019

Unable to charge - Vehicle connection issue

Insert charge handle fully into charge port

What this alert means:

A communication error occurred between the Wall Connector and the vehicle.

What to do:

Try charging again by disconnecting the Wall Connector from the vehicle and reconnecting.

1. If the issue persists, turn OFF the circuit breaker servicing the Wall Connector, wait 10 seconds, turn the circuit breaker ON again, then try reconnecting the Wall Connector to the vehicle.
2. If the issue persists and other charging equipment is available, plug the vehicle into another Wall Connector or a Mobile Connector to determine if the vehicle is able to communicate with other charging equipment.
3. If the issue persists, service is required.

For more information, see the [installation guide](#) for your Wall Connector.

CC_a020

Unable to charge - Wall Connector issue

Wall Connector needs service

What this alert means:



Wall Connector hardware issue. Possible issues include:

1. Contactor not working
2. Self-test of internal ground fault monitoring circuit failed
3. Thermal sensor disconnected
4. Other hardware component issues

What to do:

An internal issue was detected by the Wall Connector.

1. Try charging again by disconnecting the Wall Connector from the vehicle and reconnecting.
2. If the issue persists, turn OFF the circuit breaker for the Wall Connector, wait 10 seconds, and turn the circuit breaker ON again. Then try reconnecting the Wall Connector to the vehicle.
3. If the issue persists, have an electrician make sure all wires are properly connected and torqued according to the instructions in the Wall Connector Installation Manual.
4. Once your electrician has completed all work and restored power to the Wall Connector, try charging again by reconnecting the Wall Connector to the vehicle.
5. If the issue persists, the Wall Connector requires service.

For more information, see the [installation guide](#) for your Wall Connector.

CC_a021

Unable to charge - No primary Wall Connector Check that primary unit is powered and available

What this alert means:

Load sharing (circuit breaker sharing) network: Need one (and only one) Wall Connector set as primary.

What to do:

Only one Wall Connector can be set to a primary configuration. Have your electrician confirm:

1. Only one of the Wall Connectors is set as primary.
2. All other Wall Connectors linked to the primary unit are set to paired position (position F).

For more information, see the [installation guide](#) for your Wall Connector.

CC_a022

Unable to charge - More than 1 primary unit Ensure only 1 Wall Connector is set as primary

What this alert means:

Load sharing (circuit breaker sharing) network: Need one (and only one) Wall Connector set as primary.

What to do:

Only one Wall Connector can be set to a primary configuration. Have your electrician confirm:

1. Only one of the Wall Connectors is set as primary.
2. All other Wall Connectors linked to the primary unit are set to paired position (position F).

For more information, see the [installation guide](#) for your Wall Connector.

CC_a023

Unable to charge - Too many Wall Connectors Ensure no more than 3 units paired with primary

What this alert means:

Load sharing (circuit breaker sharing) network: More than three Wall Connectors are paired with the same primary unit.

What to do:

Consult your electrician to have one or more paired Wall Connectors moved to a different circuit and disconnected (unpaired) from this load sharing (circuit breaker sharing) network.

For more information, see the [installation guide](#) for your Wall Connector.

CC_a024

Unable to charge - Low Wall Connector current Primary unit current setting must be increased

What this alert means:

Incorrect rotary switch setting.

What to do:

Have your electrician adjust the Wall Connector's internal rotary switch to a valid operating current setting. They should first make sure there is no power to the Wall Connector. The correlation between switch setting and current should be printed on the inside of the Wall Connector. Your electrician should also refer to the Set the Operating Current section in the Wall Connector Installation Manual.

If the Wall Connector is set up for load sharing (circuit breaker sharing) and paired with other Wall Connectors, the rotary switch of the primary unit must be set to an operating current setting that allows each paired Wall Connector to receive at least 6A of charge current.

Example: Three Wall Connectors are paired for load sharing. The primary unit needs to be set to a current of at least $3 * 6A = 18A$ or greater.

For more information, see the [installation guide](#) for your Wall Connector.

CC_a025

Unable to charge - Wall Connector issue Wall Connector needs service

What this alert means:

Wall Connector hardware issue. Possible issues include:

1. Contactor not working
2. Self-test of internal ground fault monitoring circuit failed
3. Thermal sensor disconnected
4. Other hardware component issues

What to do:

An internal issue was detected by the Wall Connector.

1. Try charging again by disconnecting the Wall Connector from the vehicle and reconnecting.



2. If the issue persists, turn OFF the circuit breaker for the Wall Connector, wait 10 seconds, and turn the circuit breaker ON again. Then try reconnecting the Wall Connector to the vehicle.
3. If the issue persists, have an electrician make sure all wires are properly connected and torqued according to the instructions in the Wall Connector Installation Manual.
4. Once your electrician has completed all work and restored power to the Wall Connector, try charging again by reconnecting the Wall Connector to the vehicle.
5. If the issue persists, the Wall Connector requires service.

For more information, see the [installation guide](#) for your Wall Connector.

CC_a026

Unable to charge - Wall Connector issue

Wall Connector needs service

What this alert means:

Wall Connector hardware issue. Possible issues include:

1. Contactor not working
2. Self-test of internal ground fault monitoring circuit failed
3. Thermal sensor disconnected
4. Other hardware component issues

What to do:

An internal issue was detected by the Wall Connector.

1. Try charging again by disconnecting the Wall Connector from the vehicle and reconnecting.
2. If the issue persists, turn OFF the circuit breaker for the Wall Connector, wait 10 seconds, and turn the circuit breaker ON again. Then try reconnecting the Wall Connector to the vehicle.
3. If the issue persists, have an electrician make sure all wires are properly connected and torqued according to the instructions in the Wall Connector Installation Manual.
4. Once your electrician has completed all work and restored power to the Wall Connector, try charging again by reconnecting the Wall Connector to the vehicle.
5. If the issue persists, the Wall Connector requires service.

For more information, see the [installation guide](#) for your Wall Connector.

CC_a027

Unable to charge - Wall Connector issue

Wall Connector needs service

What this alert means:

Wall Connector hardware issue. Possible issues include:

1. Contactor not working
2. Self-test of internal ground fault monitoring circuit failed
3. Thermal sensor disconnected
4. Other hardware component issues

What to do:

An internal issue was detected by the Wall Connector.

1. Try charging again by disconnecting the Wall Connector from the vehicle and reconnecting.
2. If the issue persists, turn OFF the circuit breaker for the Wall Connector, wait 10 seconds, and turn the circuit breaker ON again. Then try reconnecting the Wall Connector to the vehicle.
3. If the issue persists, have an electrician make sure all wires are properly connected and torqued according to the instructions in the Wall Connector Installation Manual.
4. Once your electrician has completed all work and restored power to the Wall Connector, try charging again by reconnecting the Wall Connector to the vehicle.
5. If the issue persists, the Wall Connector requires service.

For more information, see the [installation guide](#) for your Wall Connector.

CC_a028

Unable to charge - Incorrect switch setting Wall Connector rotary switch must be adjusted

What this alert means:

Incorrect rotary switch setting.

What to do:

Have your electrician adjust the Wall Connector's internal rotary switch to a valid operating current setting. They should first make sure there is no power to the Wall Connector. The correlation between switch setting and current should be printed on the inside of the Wall Connector. Your electrician should also refer to the Set the Operating Current section in the Wall Connector Installation Manual.

If the Wall Connector is set up for load sharing (circuit breaker sharing) and paired with other Wall Connectors, the rotary switch of the primary unit must be set to an operating current setting that allows each paired Wall Connector to receive at least 6A of charge current.

Example: Three Wall Connectors are paired for load sharing. The primary unit needs to be set to a current of at least $3 * 6A = 18A$ or greater.

For more information, see the [installation guide](#) for your Wall Connector.

CC_a029

Unable to charge - Vehicle connection issue Insert charge handle fully into charge port

What this alert means:

A communication error occurred between the Wall Connector and the vehicle.

What to do:

Try charging again by disconnecting the Wall Connector from the vehicle and reconnecting.

1. If the issue persists, turn OFF the circuit breaker servicing the Wall Connector, wait 10 seconds, turn the circuit breaker ON again, then try reconnecting the Wall Connector to the vehicle.
2. If the issue persists and other charging equipment is available, plug the vehicle into another Wall Connector or a Mobile Connector to determine if the vehicle is able to communicate with other charging equipment.
3. If the issue persists, service is required.

For more information, see the [installation guide](#) for your Wall Connector.

**CC_a030****Unable to charge - Primary / paired unit mismatch
Wall Connector current ratings must match****What this alert means:**

Load sharing (circuit breaker sharing) network: The paired Wall Connectors have different maximum current capabilities.

What to do:

Only Wall Connectors with the same maximum current capabilities can be paired in a load sharing (circuit breaker sharing) network. Have your electrician inspect the type labels on the Wall Connectors and make sure the current capabilities match. It is further recommended that your electrician only pair Wall Connectors with the same part number, as an easy way to make sure paired units are compatible.

For more information, see the [installation guide](#) for your Wall Connector.

CC_a041**Charge rate reduced - Wall connection hot
Outlet or Wall Connector wiring must be checked****What this alert means:**

High temperature detected by Wall Connector alerts indicate the building connection to the Wall Connector is getting too warm, so charging has been slowed to protect the wiring and Wall Connector.

This is not typically an issue with your vehicle or your Wall Connector, but rather an issue with the building wiring. This may be caused by a loose building wiring connection to the Wall Connector and can be fixed quickly by an electrician.

What to do:

Contact an electrician to inspect the building wiring connection to the Wall Connector. They should make sure that all wires are properly connected and torqued according to the installation guide for the Wall Connector.

For more information, see the [installation guide](#) for your Wall Connector.

CC_a043**Wall Connector configuration must be completed
Refer to Installation Guide to enable charging****What this alert means:**

Wall Connector configuration is incomplete.

What to do:

The Wall Connector needs to be commissioned to appropriately configure the circuit breaker size and protective earth connection type.

For more information, refer to Commissioning Procedure in the Wall Connector Installation Manual. If the issue persists, contact an electrician to inspect the building wiring connection to the Wall Connector. They should make sure the power output and grounding connections are properly configured according to the installation guide for the Wall Connector.

For more information, see the [installation guide](#) for your Wall Connector.

CP_a004

Charging equipment not recognized

Try again or try different equipment

What this alert means:

The charge port is unable to detect whether a charge cable is inserted, or the type of charge cable connected.

This alert is usually specific to external charging equipment and power sources and does not typically indicate an issue with your vehicle that can be resolved by scheduling service.

What to do:

If this alert appears while a charge cable **is** connected, determine whether the issue is caused by the charging equipment or the vehicle. Try charging the vehicle using different external charging equipment (including charge cable, charging station, or charging stall).

- If the vehicle begins charging, the issue was likely with the equipment.
- If the vehicle still does not charge, the issue may be with the vehicle.

If this alert appears while a charge cable is **not** connected or if the issue is suspected to be with the vehicle, inspect the charge port inlet and the charge cable connector for any obstructions, such as debris, moisture, and/or foreign objects. Make sure any charge port inlet obstruction has been removed and any moisture has been allowed to dry, then try re-inserting the cable into the charge port.

You can also try charging your vehicle using a Tesla Supercharger or Destination Charging location, all of which can be located through the map on your vehicle's touchscreen display. See [Maps and Navigation on page 147](#) for more details.

For more information on troubleshooting Mobile Connector or Wall Connector status lights, refer to the product's Owner's Manual at [Charging & Adapter Product Guides](#).

For more information on charging, see [Charging Instructions on page 163](#).

CP_a010

Charging equipment communication error

Try again or try different equipment

What this alert means:

Your vehicle is unable to charge because it cannot communicate effectively with the external charging equipment. It cannot sense a valid control pilot signal coming from the charging equipment.

This alert is usually specific to external charging equipment and power sources and does not typically indicate an issue with your vehicle that can be resolved by scheduling service.

What to do:

First, confirm the lack of effective communication is caused by the external charging equipment rather than an issue with your vehicle. This is usually the case.

Try charging the vehicle using different external charging equipment (including charge cable, charging station, or charging stall).

- If the vehicle begins charging, the issue was likely with the equipment.
- If the vehicle still does not charge, the issue may be with the vehicle.

If the issue is suspected to be with the vehicle, inspect the charge port inlet and the charge cable connector for any obstructions, such as debris, moisture, and/or foreign objects. Make sure any charge port inlet obstruction has been removed and any moisture has been allowed to dry, then try re-inserting the cable into the charge port.



You can also try charging your vehicle using a Tesla Supercharger or Destination Charging location, all of which can be located through the map on your vehicle's touchscreen display. See [Maps and Navigation on page 147](#) for more details.

For more information on troubleshooting Mobile Connector or Wall Connector status lights, refer to the product's Owner's Manual at [Charging & Adapter Product Guides](#).

For more information on charging, see [Charging Instructions on page 163](#).

CP_a043 Charge port door sensor fault Charge port may not operate as expected

What this alert means:

One of the charge port door sensors is not functioning normally. When this occurs, the charge port may be unable to accurately sense the charge port door position and the charge port may not operate as expected.

- The charge port latch may intermittently remain engaged when the charge port door is opened.
- The charge port light may illuminate only intermittently when the charge port door is opened.

What to do:

Try closing the charge port door and then opening it again.

For more information, see [Opening the Charge Port on page 163](#).

For more information on charging, see [Charging Instructions on page 163](#).

CP_a046 Charging equipment communication lost Check power source and charging equipment

What this alert means:

Charging stopped because communication between the vehicle and the external charging equipment was interrupted.

This alert is usually specific to external charging equipment and power sources and does not typically indicate an issue with your vehicle that can be resolved by scheduling service.

What to do:

Confirm whether the external charging equipment is powered by looking for any status lights, displays, or other indicators on the equipment.

If the equipment is **not** powered, try to restore the external charging equipment's power source.

- If attempting to charge at a public station and power is unable to be restored, contact the station operator.
- If attempting to charge at a private station (for example: charging at home) and power is unable to be restored, contact an electrician.

If the equipment is powered, try charging the vehicle using different external charging equipment.

- If the vehicle begins charging, the issue was likely with the equipment.
- If the vehicle still does not charge, the issue may be with the vehicle.

You can also try charging your vehicle using a Tesla Supercharger or Destination Charging location, all of which can be located through the map on your vehicle's touchscreen display. See [Maps and Navigation on page 147](#) for more details.

For more information on troubleshooting Mobile Connector or Wall Connector status lights, refer to the product's Owner's Manual at [Charging & Adapter Product Guides](#).

CP_a051

Charge port may not open when pressed

Use another method to open the charge port

What this alert means:

One of the charge port door sensors is not communicating properly. The charge port may not recognize the request to open when the charge port door is pressed.

What to do:

You can still use all other usual methods to open the charge port door:

- Use the vehicle touchscreen.
- Use the Tesla Mobile App.
- With your vehicle unlocked, press the charge handle button on any Tesla charge cable, including a Wall Connector, Mobile Connector, or Supercharger.
- Hold and press the trunk button on your key fob.

For more information, see [Opening the Charge Port on page 163](#).

CP_a053

Unable to charge - Charge station not powered

Check power source or try a different station

What this alert means:

Charging cannot begin because the charging equipment is not ready. A charge handle is detected, but the charging station is not communicating with the vehicle. This issue could occur because:

- The charging station is not powered.
- The control pilot signal between the charging station and the vehicle is interrupted.

This alert is usually specific to external charging equipment and power sources and does not typically indicate an issue with your vehicle that can be resolved by scheduling service.

What to do:

Try charging the vehicle with different charging equipment or at a different charging station.

- If the vehicle begins charging, the issue was likely with the equipment.
- If the vehicle still does not charge, the issue may be with the vehicle.

If using a Mobile Connector or Wall Connector, first check the status lights on the front. If no status lights are visible, check the power source and contact an electrician to inspect the building wiring connection to the wall outlet or the Wall Connector to confirm that all wires are properly connected and torqued.

If using other external charging equipment, consult the product's owner's manual to learn how to confirm that the station is powered. Contact an electrician to inspect the building wiring and charging equipment as necessary.



For more information on troubleshooting Mobile Connector or Wall Connector status lights, refer to the product's Owner's Manual at [Charging & Adapter Product Guides](#).

You can also try charging your vehicle using a Tesla Supercharger or Destination Charging location, all of which can be located through the map on your vehicle's touchscreen display. See [Maps and Navigation on page 147](#) for more details.

CP_a054 Charge port latch not engaged Fully insert charge cable or check for obstruction

What this alert means:

The charge port latch is unable to latch the charge cable in the charge port inlet. If the latch is not engaged, AC charging (for example, charging with a Mobile Connector or Wall Connector) will be limited to 16A and DC Fast Charging / Supercharging will be unavailable.

The charge port light will pulse amber if this alert appears during AC charging and will be solid amber if this alert appears when attempting to DC Fast Charge / Supercharge.

This alert is usually specific to external charging equipment and power sources and does not typically indicate an issue with your vehicle that can be resolved by scheduling service.

What to do:

Try re-inserting the charge cable fully into the charge port inlet.

If your vehicle begins charging and the charge port light pulses green, the charge cable may not have been fully inserted before. AC charging should no longer be limited, and DC Fast Charging / Supercharging should be available.

If charging is still limited or the vehicle will not charge at all, inspect the charge port inlet and the charge cable connector for any obstructions, such as debris, moisture, and/or foreign objects. Make sure any charge port inlet obstruction has been removed and any moisture has been allowed to dry, then try re-inserting the cable into the charge port.

If charging is still limited or the vehicle will not charge at all, make sure the charge port latch manual release cable (located on the left-hand side in the trunk) has not been pulled. Make sure the handle (usually ring-shaped or a strap) for the manual release cable is free of obstructions and that nothing is attached to it (like a cargo net or umbrella). For more information on the charge port latch manual release, see [Manually Releasing Charge Cable on page 167](#).

You can also try charging your vehicle using a Tesla Supercharger or Destination Charging location, all of which can be located through the map on your vehicle's touchscreen display. See [Maps and Navigation on page 147](#) for more details.

For more information on troubleshooting Mobile Connector or Wall Connector status lights, refer to the product's Owner's Manual at [Charging & Adapter Product Guides](#).

For more information on charging, see [Charging Instructions on page 163](#).

CP_a055 Charging equipment communication lost Check power source and charging equipment

What this alert means:

Charging stopped because communication between the vehicle and the external charging equipment was interrupted.

This alert is usually specific to external charging equipment and power sources and does not typically indicate an issue with your vehicle that can be resolved by scheduling service.

What to do:

Confirm whether the external charging equipment is powered by looking for any status lights, displays, or other indicators on the equipment. For more information on troubleshooting Mobile Connector or Wall Connector status lights, refer to the product's Owner's Manual at [Charging & Adapter Product Guides](#).

If the equipment is **not** powered, try to restore the external charging equipment's power source.

- If attempting to charge at a public station and power is unable to be restored, contact the station operator.
- If attempting to charge at a private station (for example: charging at home) and power is unable to be restored, contact an electrician.

If the equipment is powered, try charging the vehicle using different external charging equipment.

- If the vehicle begins charging, the issue was likely with the equipment.
- If the vehicle still does not charge, the issue may be with the vehicle.

You can also try charging your vehicle using a Tesla Supercharger or Destination Charging location, all of which can be located through the map on your vehicle's touchscreen display. See [Maps and Navigation on page 147](#) for more details.

CP_a056**Charging stopped - Charge cable disconnected
Close charge port - Press brake pedal and retry****What this alert means:**

Charging has stopped because your vehicle has detected that the connection between the charge port and charge cable has been unexpectedly interrupted.

What to do:

Before disconnecting a charge cable, make sure you first stop charging.

With some external charging equipment, charging may be stopped by pressing the button on the charge handle.

You can also stop charging from your vehicle touchscreen, your Tesla Mobile App, or the charging station.

For more information, see [Stopping Charging on page 165](#).

CP_a058**Unable to AC charge - Unplug and retry
Or try DC Fast Charging / Supercharging****What this alert means:**

Your vehicle is unable to AC charge because it has detected one of the following conditions and has tried to charge too many times without success:

- The charge port is unable to detect whether a charge cable is inserted or detect the type of charge cable connected.
- Your vehicle is unable to sense a valid pilot control signal coming from the charging station, so it cannot communicate effectively with the external charging equipment.
- Communication between your vehicle and the external charging equipment has been interrupted.
- The external charging equipment has reported an error that prevents your vehicle from charging.

When this alert is present, there will always be at least one other alert present that identifies a more specific condition.



What to do:

For more information and troubleshooting suggestions, check in your vehicle touchscreen for other recent alerts that involve charging.

CP_a066

Charging equipment not ready

See equipment instructions to start charging

What this alert means:

Charging cannot begin because the charging station is communicating to your vehicle that either the external charging equipment is not ready or charging is not authorized. The control pilot signal that communicates between the charging station and your vehicle indicates that your vehicle is not allowed to start charging.

This could occur because:

- The charging station is actively delaying charging. For example, this can happen because the station has a scheduled charging feature activated.
- The charging station requires further activation before the charge session can begin. Some additional authentication may be needed before the station starts charging your vehicle, such as a charging card, a mobile app, or a credit card.

This alert is usually specific to external charging equipment and power sources and does not typically indicate an issue with your vehicle that can be resolved by scheduling service.

What to do:

Check the charging station for any instructions that explain the steps necessary to enable charging. For example, look for a touchscreen terminal, LED status indicators, printed instructions, or a payment interface that might provide guidance. If you cannot enable charging on the current charging station, try charging the vehicle with different charging equipment or at a different charging station.

- If the vehicle begins charging, the issue was likely with the equipment.
- If the vehicle still does not charge, the issue may be with the vehicle.

You can also try charging your vehicle using a Tesla Supercharger or Destination Charging location, all of which can be located through the map on your vehicle's touchscreen display. See [Maps and Navigation on page 147](#) for more details.

For more information on troubleshooting Mobile Connector or Wall Connector status lights, refer to the product's Owner's Manual at [Charging & Adapter Product Guides](#).

For more information on charging, see [Charging Instructions on page 163](#).

CP_a078

Cable blocked - Charge port latch may be frozen

Try using Defrost Car button in Mobile App

What this alert means:

The charge port latch cannot unlatch the charge cable, and cold ambient temperature is detected.

What to do:

To remove any strain on the cable, re-insert the charge cable fully into the charge port inlet. Try again to unlatch the charge cable.

If the charge cable still cannot be removed, the charge port latch may be frozen.

To help thaw any ice on the charge port latch, press the Defrost Car button in your Tesla Mobile App to defrost your vehicle for approximately 30 to 45 minutes.

NOTE: Be sure to use Defrost Car in your Mobile App to defrost your vehicle. Adjusting the climate control settings in your vehicle's touchscreen is not as effective.

If the charge cable still cannot be removed, try the charge port manual release cable in your vehicle's trunk.

1. Make sure your vehicle is not actively charging.
 - In your vehicle touchscreen, access the charging screen.
 - If necessary, press Stop Charging.
2. Open the rear trunk.
3. Pull the charge port release cable downwards to unlatch the charge cable.
 - Note: The release cable is located on the left hand side of the rear trunk. It may be recessed within a small opening of the trunk interior trim.
4. Pull the charge cable from the charge port.

For more information on the charge port latch manual release, see [Manually Releasing Charge Cable on page 167](#).

For more information on charging, see [Charging Instructions on page 163](#).

CP_a079

Charge rate reduced - Charge port may be frozen Try using Defrost Car button in Mobile App

What this alert means:

The charge port latch is unable to secure the charge cable in the charge port inlet, and cold ambient temperature is detected. If the latch is not engaged, AC charging (for example, charging with a Mobile Connector or Wall Connector) will be limited to 16A and DC Fast Charging / Supercharging will be unavailable.

The charge port light will pulse amber if this alert appears during AC charging and will be solid amber if this alert appears when attempting to DC Fast Charge / Supercharge.

This alert is usually specific to external charging equipment and power sources and does not typically indicate an issue with your vehicle that can be resolved by scheduling service.

What to do:

Try re-inserting the charge cable fully into the charge port inlet. If your vehicle begins charging and the charge port light pulses green, the charge cable may not have been fully inserted before. AC charging should no longer be limited, and DC Fast Charging / Supercharging should be available.

If charging is still limited or the vehicle will not charge at all, make sure the charge port latch manual release cable (located on the left-hand side in the trunk) has not been pulled. Make sure the handle (usually ring-shaped or a strap) for the manual release cable is free of obstructions and that nothing is attached to it (like a cargo net or umbrella). For more information on the charge port latch manual release, see [Manually Releasing Charge Cable on page 167](#).

If charging is still limited or the vehicle will not charge at all, inspect the charge port inlet and the charge cable connector for any obstructions, such as debris, moisture, and/or foreign objects. Make sure any charge port inlet obstruction has been removed and any moisture has been allowed to dry, then try re-inserting the cable into the charge port.

If you have checked for and cleared any debris or foreign objects, but charging is still limited or your vehicle will not charge at all, the charge port latch may be frozen. To help thaw any ice on the charge port latch, press the Defrost Car button in your Tesla Mobile App to defrost your vehicle for approximately 30 to 45 minutes.

NOTE: Be sure to use Defrost Car in your Mobile App to defrost your vehicle. Adjusting the climate control settings in your vehicle's touchscreen is not as effective.



If the alert remains present, limited AC charging should still be available.

For more information on charging, see [Charging Instructions on page 163](#).

CP_a101

Charge rate reduced - Wall connection hot Outlet or Wall Connector wiring must be checked

What this alert means:

High temperature detected by Wall Connector alerts indicate the building connection to the Wall Connector is getting too warm, so charging has been slowed to protect the wiring and Wall Connector.

This is not typically an issue with your vehicle or your Wall Connector, but rather an issue with the building wiring. This may be caused by a loose building wiring connection to the Wall Connector and can be fixed quickly by an electrician.

What to do:

Contact an electrician to inspect the building wiring connection to the Wall Connector. They should make sure that all wires are properly connected and torqued according to the installation guide for the Wall Connector.

Wall Connector installation guides can be found [here](#).

CP_a102

Unable to charge - Wall connection too hot Outlet or Wall Connector wiring must be checked

What this alert means:

High temperature detected by Wall Connector alerts indicate the building connection to the Wall Connector is getting too warm, so charging has been slowed to protect the wiring and Wall Connector.

This is not typically an issue with your vehicle or your Wall Connector, but rather an issue with the building wiring. This may be caused by a loose building wiring connection to the Wall Connector and can be fixed quickly by an electrician.

What to do:

Contact an electrician to inspect the building wiring connection to the Wall Connector. They should make sure that all wires are properly connected and torqued according to the installation guide for the Wall Connector.

For more information, see the [installation guide](#) for your Wall Connector.

CP_a143

Charging adapter has electric arc flash hazard Use different charging equipment

What this alert means:

Charging is unavailable because your vehicle has detected an electric arc flash hazard in the third-party charging adapter used to connect a Combined Charging System (CCS) charge handle to your vehicle's charge port.

An electric arc flash can occur if you attempt to unplug **while actively charging with the third-party charging adapter**, and an electric arc flash can cause serious bodily injury and/or property damage.

What to do:

Follow the steps below to mitigate this risk:



Troubleshooting Alerts

- Make sure charging is completely stopped.
 1. Use your vehicle touchscreen to confirm charging has stopped, or to stop charging if necessary.
 2. Use the charging station display and controls to confirm charging has stopped, or to end any active charging session.
- Make sure no flashing green or blue light (LED) is visible on your vehicle's charge port.
- Unplug the charging adapter from your vehicle's charge port.
- Confirm again that the charging station indicates no active charging session.
- Unplug the charging adapter from the charge handle.

Use different charging equipment to charge your vehicle. For more information on charging, see [Charging Instructions on page 163](#).

You can also try charging your vehicle using a Tesla Supercharger or Destination Charging location, all of which can be located through the map on your vehicle's touchscreen display. See [Maps and Navigation on page 147](#) for more details.

CP_a151

Charge port error detected - Service is required AC charging may not function / OK to Supercharge

What this alert means:

Your vehicle's charge port requires service. The charge port is unable to establish a valid control pilot signal and communicate effectively with some AC charging equipment and power sources.

While this alert remains present, AC charging and DC Fast Charging with non-Tesla charging stations may be limited or unavailable.

What to do:

It is recommended that you schedule service to have your vehicle's charge port inspected at your earliest convenient opportunity.

In the meantime, Supercharging should continue to be available. Supercharging locations can be displayed through the map on your vehicle's touchscreen. See [Maps and Navigation on page 147](#) for more details.

AC charging may also be available using a Gen 2 Mobile Connector or Gen 3 Wall Connector. However, it is recommended that you make sure your vehicle's charge port can communicate with your Tesla charging product. Try charging with your Gen 2 Mobile Connector or Gen 3 Wall Connector, and confirm your vehicle is charging as expected, before relying on it.

For more information on troubleshooting Mobile Connector or Wall Connector status lights, refer to the product's Owner's Manual at [Charging & Adapter Product Guides](#).

For more information on charging, see [Charging Instructions on page 163](#).

DI_a138

Front motor disabled - OK to drive Vehicle power may be limited

What this alert means:

Your vehicle's front motor is unavailable. Power, speed, and acceleration may be reduced as your vehicle uses the rear motor(s) to continue driving.

What to do:



In some cases, your vehicle may be unable to continue driving. If this occurs, another vehicle alert should also be present to provide more information and recommended actions.

This alert may be caused by a temporary condition that will be resolved automatically. If this alert clears during your current drive, or is no longer present when you start your next drive, it was likely caused by a temporary condition. No action is required.

This alert may also indicate a condition requiring front motor inspection and service. If this alert persists throughout subsequent drives, it is recommended that you schedule service. Your vehicle is OK to drive in the meantime.

DI_a166

Vehicle automatically parked to prevent rollaway Fasten seatbelt and close door to stay in gear

What this alert means:

Your vehicle has automatically shifted into Park (P) because it determined the driver was leaving or no longer present. This is expected vehicle behavior under various circumstances.

Your vehicle will automatically shift into Park if **all** of these conditions are true:

- Autopark is not active
- Your vehicle is traveling slower than 1.4 mph (2.25 km/h) in Drive or Reverse
- The last driver activity was detected more than 2 seconds ago. Driver activity includes:
 - Pressing the brake and/or accelerator pedal
 - Manually steering the vehicle.

And at least **two** of these conditions are true:

1. Driver seatbelt is detected as unbuckled
2. Driver is not detected as present
3. Driver door is detected as open
4. One or more of the sensors used to detect the three conditions above (seatbelt buckle, seat occupancy, door latch) is not working as expected

Your vehicle will also automatically shift into Park if **any** of these conditions is true:

- Door is detected as open
- Seatbelt is detected as unbuckled while speed is less than 0.1mph (0.15 km/h) in Drive or Reverse
- No driver activity is detected for 60 seconds

NOTE: Your vehicle will also automatically shift into Park when a charge cable is connected to the charge port.

What to do:

For more information on automatic shifting into Park, see [Shifting on page 55](#).

DI_a175

Cruise control unavailable

What this alert means:

Cruise Control, including Traffic-Aware Cruise Control, is currently unavailable.

Cruise Control might be unavailable because:



Troubleshooting Alerts

- The driver canceled the request.
- The driver unbuckled their seatbelt.
- The front trunk, trunk, or a door is open.
- The vehicle is traveling below the Cruise Control minimum speed of 18 mph (30 km/h).
- There is an environmental condition, such as limited visibility.
- Valet mode is active.

What to do:

Take control and drive your vehicle manually.

When any condition preventing Cruise Control activation is no longer present, Cruise Control should be available. If this alert persists throughout subsequent drives, schedule service at your earliest convenience. Your vehicle is OK to drive in the meantime.

For more information, see [Traffic-Aware Cruise Control on page 84](#).

DI_a184 **Autopark canceled** **Take control**

What this alert means:

Autopark has been canceled.

Autopark might have been canceled because:

- The driver pressed the Cancel button on the touchscreen.
- The driver moved the steering yoke (or steering wheel).
- The driver pressed the accelerator pedal, pressed the brake pedal, or opened a door.
- There is a steep slope / grade.
- There is a weather condition affecting visibility.
- The curb cannot be detected.
- A trailer is attached to the vehicle.

What to do:

Park, or finish parking, your vehicle manually. Once you have finished parking, apply the brakes and shift into Park. Your vehicle will otherwise remain free-rolling.

Autopark should be available again during your next drive.

For more information, see [To Cancel Parking on page 104](#) and [Limitations on page 104](#).

DI_a185 **Autopark Aborted**

What this alert means:

Autopark has aborted and the Electronic Parking Brake has been applied.

Autopark might have been canceled because:

- The driver pressed the Cancel button on the touchscreen.
- The driver moved the steering yoke (or steering wheel).



- The driver pressed the accelerator pedal, pressed the brake pedal, or opened a door.
- There is a steep slope / grade.
- There is a weather condition affecting visibility.
- The curb cannot be detected.
- A trailer is attached to the vehicle.

What to do:

Park, or finish parking, your vehicle manually.

Autopark should be available again during your next drive.

For more information, see [To Cancel Parking on page 104](#) and [Limitations on page 104](#).

DI_a190 Rear tire tread depth low - Schedule service Inspect tires for rotation/replacement

What this alert means:

NOTE: This alert does NOT indicate that there is a flat tire.

Your vehicle has detected that the rear tires have experienced more wear over time than the front tires, exceeding the recommended difference.

What to do:

It is recommended that the tread depth on all tires be inspected. As your tires wear during normal driving, the rear tires generally wear more quickly than the front tires.

Tire rotation is important to balance tire wear evenly across all tires.

Failure to rotate tires as recommended poses a risk of hydroplaning and losing control of the vehicle on wet roads. Failure to rotate tires also decreases the life of your tires, requiring premature replacement.

It is recommended that you schedule service via your Tesla Mobile App or with an independent service provider to have your tires rotated when:

- The difference in tire tread depth between any front and rear tire exceeds 1.5mm
- Your vehicle has been driven for more than 6,250 miles (10,000 km) since the last rotation

Upon completion of tire inspection and any necessary tire service, update your vehicle's tire configuration to optimize your vehicle settings to your tires and clear the alert for at least 6,250 miles. For more information, see [Tire Care and Maintenance on page 173](#).

It is not recommended that you rely on this alert instead of routine checks of tire tread depth. This alert should only be present when your vehicle estimates the tires are far beyond the recommended service interval.

This alert is calibrated for Tesla tires and is not expected to work with tires of different types or sizes, including combinations of different tire brands or models. It may not display, or may display prematurely, on vehicles using tires not recommended by Tesla. For more information on recommended tires, see [Wheels and Tires on page 194](#).

DI_a245 Vehicle Hold feature unavailable Keep brake pedal pressed while stopped

What this alert means:



Troubleshooting Alerts

Vehicle Hold is currently unavailable due to system constraints. When stopping, use the brake pedal to bring your vehicle to a complete stop and keep your vehicle stationary.

What to do:

Continue to your destination. Your vehicle is OK to drive.

If this alert persists throughout subsequent drives, schedule service at your earliest convenience. Your vehicle is OK to drive in the meantime.

For more information, see [Vehicle Hold on page 72](#).

DI_a250

Adaptive ride control disabled Drive with caution

What this alert means:

The speed of your vehicle is limited to 90 mph (144 km/h) due to an issue with the Adaptive Suspension Damping system.

The system cannot provide real-time adjustments to the suspension system to optimize both ride and handling, and as a result your ride may be softer than usual.

What to do:

If this alert persists throughout subsequent drives, schedule service at your earliest convenience. Your vehicle is OK to drive in the meantime.

This alert is accompanied by a red indicator light on the instrument panel. For more information, see [Air Suspension on page 129](#).

ESP_a118

Assist for low brake performance activated To stop, keep brake pedal firmly pressed

What this alert means:

Hydraulic Fade Compensation is active. This brake assist function activates temporarily to make sure you have full braking capability in conditions where reduced braking performance is detected by your vehicle.

When this assist function activates, you may feel the brake pedal pull away from your foot and notice a strong increase in brake pressure. You may also hear a pumping sound coming from the brake hydraulic unit at the front of the vehicle. This will usually last for a few seconds, depending on road surface and vehicle speed. This is completely normal and does not indicate any issue with your vehicle.

What to do:

Continue to press the brake pedal as you normally would, and do not "pump" (repeatedly press and release) the pedal as this will interrupt the function.

This alert will clear when your vehicle comes to a stop or you are no longer pressing the brake pedal. It may still be displayed for up to 5 seconds afterward.

Reduced braking performance is usually temporary, and can occur for a number of reasons including high brake temperatures after heavy brake use, or driving in extremely cold or wet conditions. It can also indicate that your brake pads or rotors have worn to the point that normal replacement is needed.

If you continue to experience reduced braking performance which does not improve over time, please contact Tesla service at your convenience for a brake inspection.

For more information, see [Hydraulic Fade Compensation on page 67](#).

**PCS_a016****Cannot charge - Poor grid power quality possible
Retry / Try other charge location or Supercharging****What this alert means:**

Charging has stopped due to a condition that prevents your vehicle from charging with AC power. DC fast charging / Supercharging should still function as expected.

This may be due to power supply disturbances caused by the external charging equipment or by the electrical power grid. In some cases, this condition may be the result of using nearby electric devices that draw a lot of power.

If these possible causes can be ruled out, then a condition with your vehicle itself may also be affecting AC charging.

What to do:

If this alert is accompanied by another alert that specifies the condition affecting AC charging, start by investigating that alert.

Further troubleshooting tips based on equipment type:

- If using a Mobile Connector, try charging the vehicle with a different wall outlet.
 - If the vehicle starts to charge, the issue was likely with the original wall outlet.
 - If the vehicle still does not charge, the issue may be with the Mobile Connector.
- If using a Wall Connector, try charging the vehicle with different charging equipment like a Mobile Connector powered by a separate wall outlet.
 - If the vehicle starts to charge, the issue was likely with the Wall Connector.

If the issue is with the original wall outlet or the Wall Connector, contact an electrician to inspect the wiring connection.

You can also try charging your vehicle using a Tesla Supercharger or Destination Charging location, all of which can be located through the map on your vehicle's touchscreen display. See [Maps and Navigation on page 147](#) for more details.

If this alert persists when attempting to charge at multiple locations and with different charging equipment, it is recommended that you schedule service.

For more information on troubleshooting Mobile Connector or Wall Connector status lights, refer to the product's Owner's Manual at [Charging & Adapter Product Guides](#).

PCS_a017**Charging stopped - Power lost while charging
Check power source and charging equipment****What this alert means:**

Power has been lost during charging. This could result from the charging equipment losing power from the source (for example, a wall outlet) or from an issue with the charging equipment.

What to do:

This alert is often accompanied by other alerts that can help you identify and troubleshoot the issue. Start by investigating any other displayed alerts that relate to charging issues.

Alternatively, you can check Mobile Connector or Wall Connector status lights to confirm power to the device, and also refer to the product owner's manual for troubleshooting information based on blink codes. If using other (non-Tesla) external charging equipment, check for a display or other user interface that provides troubleshooting help.

Troubleshooting Alerts

If there is clearly no power to the charging equipment, check the circuit breaker for the wall outlet / Wall Connector to make sure it has not tripped.

Further troubleshooting tips based on equipment type:

- If using a Mobile Connector, try charging the vehicle with a different wall outlet.
 - If the vehicle starts to charge, the issue was likely with the original wall outlet.
 - If the vehicle still does not charge, the issue may be with the Mobile Connector.
- If using a Wall Connector, try charging the vehicle with different charging equipment like a Mobile Connector powered by a separate wall outlet.
 - If the vehicle starts to charge, the issue was likely with the Wall Connector.

If the issue is with the original wall outlet or the Wall Connector, contact an electrician to inspect the wiring connection.

This alert is usually specific to external charging equipment and power sources and does not typically indicate an issue with your vehicle that can be resolved by scheduling service.

You can also try charging your vehicle using a Tesla Supercharger or Destination Charging location, all of which can be located through the map on your vehicle's touchscreen display. See [Maps and Navigation on page 147](#) for more details.

For more information on troubleshooting Mobile Connector or Wall Connector status lights, refer to the product's Owner's Manual at [Charging & Adapter Product Guides](#).

PCS_a019 **Power grid or vehicle issue limiting AC charging** **Unplug and retry / Try different charging location**

What this alert means:

Charging speed has been reduced due to a condition that affects your vehicle's ability to charge with AC power. DC fast charging / Supercharging should still function as expected.

This may be due to power supply disturbances caused by the external charging equipment or by the electrical power grid. In some cases, this condition may be the result of using nearby electric devices that draw a lot of power.

If these possible causes can be ruled out, then a condition with your vehicle itself may also be affecting AC charging.

What to do:

If this alert is accompanied by another alert that specifies the condition affecting AC charging, start by investigating that alert.

Further troubleshooting tips based on equipment type:

- If using a Mobile Connector, try charging the vehicle with a different wall outlet.
 - If the vehicle starts to charge, the issue was likely with the original wall outlet.
 - If the vehicle still does not charge, the issue may be with the Mobile Connector.
- If using a Wall Connector, try charging the vehicle with different charging equipment like a Mobile Connector powered by a separate wall outlet.
 - If the vehicle starts to charge, the issue was likely with the Wall Connector.

If the issue is with the original wall outlet or the Wall Connector, contact an electrician to inspect the wiring connection.

You can also try charging your vehicle using a Tesla Supercharger or Destination Charging location, all of which can be located through the map on your vehicle's touchscreen display. See [Maps and Navigation on page 147](#) for more details.



If this alert persists when attempting to charge at multiple locations and with different charging equipment, it is recommended that you schedule service.

For more information on troubleshooting Mobile Connector or Wall Connector status lights, refer to the product's Owner's Manual at [Charging & Adapter Product Guides](#).

PCS_a032

Poor electric grid power quality detected

Try different charging station or location

What this alert means:

Charging speed has been reduced or charging has been interrupted due to a condition that affects your vehicle's ability to charge with AC power. DC fast charging / Supercharging should still function as expected.

The onboard charger in your vehicle has detected power supply disturbances in the electrical power grid. These disturbances interfere with your vehicle's charging process.

Typical causes of these power supply disturbances include:

- Issues with the building wiring and/or the wall outlet.
- Issues with the external charging equipment.
- Other large electric devices, such as washing machines or air conditioning units, that temporarily draw a lot of power or otherwise disturb the electrical power grid.
- External conditions affecting the electrical power grid.

What to do:

As this alert is usually specific to external charging equipment and power sources, and it does not typically indicate an issue with your vehicle that can be resolved by scheduling service, it is recommended that you:

- Try charging with different wall outlets.
- Try charging again (disconnect and reconnect to retry) when other large electric devices are not drawing power.
- Try charging with multiple, different types of charging equipment at different locations.

You can also try charging your vehicle using a Tesla Supercharger or Destination Charging location, all of which can be located through the map on your vehicle's touchscreen display. See [Maps and Navigation on page 147](#) for more details.

For more information on troubleshooting Mobile Connector or Wall Connector status lights, refer to the product's Owner's Manual at [Charging & Adapter Product Guides](#).

PCS_a052

External charging equipment not providing power

Check power source or try different equipment

What this alert means:

Charging cannot begin due to a condition that prevents your vehicle from charging with AC power. DC fast charging / Supercharging should still function as expected.

Your vehicle has requested AC power from the external charging equipment, but the onboard charger does not detect any supply voltage coming from the equipment.

This can sometimes be caused by a hardware issue specific to the external charging equipment, which prevents the charging equipment from switching power to the vehicle on or off when requested. It could also occur due to another condition affecting the external charging equipment, the power source it is connected to, or your vehicle itself.

What to do:

This alert is usually specific to external charging equipment and power sources and does not typically indicate an issue with your vehicle that can be resolved by scheduling service.

Try charging with multiple, different types of charging equipment.

You can also try charging your vehicle using a Tesla Supercharger or Destination Charging location, all of which can be located through the map on your vehicle's touchscreen display. See [Maps and Navigation on page 147](#) for more details.

For more information on troubleshooting Mobile Connector or Wall Connector status lights, refer to the product's Owner's Manual at [Charging & Adapter Product Guides](#).

PCS_a053

Charge rate reduced - Unexpected voltage drop Remove extension cords / Have wiring inspected

What this alert means:

Charging speed has been reduced because the onboard charger in your vehicle has detected a large voltage drop during charging.

Likely causes of this issue include:

- Problems with the building wiring and/or the wall outlet.
- An extension cord or other wiring that cannot support the requested charge current.

This issue can also result from turning on electric devices that draw a lot of power from the same branch circuit while the vehicle is charging.

What to do:

If this issue has occurred multiple times at your normal charging location, contact an electrician to inspect the electrical installation. They should check the following:

- Any installed charging equipment and its connection to the building wiring.
- The building wiring, including any wall outlet used with a Mobile Connector.
- The electrical connection to the power utility line where it enters the building.

Discuss with the electrician whether the charge current on the vehicle should be lowered, or if the installation should be upgraded to support a higher charge current.

This alert is usually specific to external charging equipment and power sources and does not typically indicate an issue with your vehicle that can be resolved by scheduling service.

You can also try charging your vehicle using a Tesla Supercharger or Destination Charging location, all of which can be located through the map on your vehicle's touchscreen display. See [Maps and Navigation on page 147](#) for more details.

For more information on troubleshooting Mobile Connector or Wall Connector status lights, refer to the product's Owner's Manual at [Charging & Adapter Product Guides](#).

PCS_a054

Charging stopped due to large voltage drop Remove extension cords / Have wiring inspected

What this alert means:

Charging has been interrupted because the onboard charger in your vehicle has detected an unusually large voltage drop.

Likely causes of this issue include:

- Problems with the building wiring and/or the wall outlet.
- An extension cord or other wiring that cannot support the requested charge current.

This issue can also result from turning on electric devices that draw a lot of power from the same branch circuit while the vehicle is charging.

What to do:

If this issue has occurred multiple times at your normal charging location, contact an electrician to inspect the electrical installation. They should check the following:

- Any installed charging equipment and its connection to the building wiring.
- The building wiring, including any wall outlet used with a Mobile Connector.
- The electrical connection to the power utility line where it enters the building.

Discuss with the electrician whether the charge current on the vehicle should be lowered, or if the installation should be upgraded to support a higher charge current.

This alert is usually specific to external charging equipment and power sources and does not typically indicate an issue with your vehicle that can be resolved by scheduling service.

You can also try charging your vehicle using a Tesla Supercharger or Destination Charging location, all of which can be located through the map on your vehicle's touchscreen display. See [Maps and Navigation on page 147](#) for more details.

For more information on troubleshooting Mobile Connector or Wall Connector status lights, refer to the product's Owner's Manual at [Charging & Adapter Product Guides](#).

PCS_a073

External charging equipment error detected Try different charging equipment

What this alert means:

AC charging cannot begin due to a condition that prevents your vehicle from charging with AC power. DC fast charging / Supercharging should still function as expected.

Your vehicle's onboard charger is detecting input voltage at the charge port when no power has been requested from the external charging equipment, which indicates the external charging equipment is not functioning as expected.

This can sometimes be caused by a hardware issue specific to the external charging equipment, which prevents the charging equipment from switching power to the vehicle on or off when requested. It could also occur due to another condition affecting the external charging equipment, or a condition affecting your vehicle itself.

What to do:

This alert is usually specific to external charging equipment and power sources and does not typically indicate an issue with your vehicle that can be resolved by scheduling service.

Try charging with multiple, different types of charging equipment.

You can also try charging your vehicle using a Tesla Supercharger or Destination Charging location, all of which can be located through the map on your vehicle's touchscreen display. See [Maps and Navigation on page 147](#) for more details.

For more information on troubleshooting Mobile Connector or Wall Connector status lights, refer to the product's Owner's Manual at [Charging & Adapter Product Guides](#).

PCS_a090

Charging slowed - Some AC phases not powered **Check power source and charging equipment**

What this alert means:

Charging speed has been reduced due to a condition that affects your vehicle's ability to charge with AC power. DC fast charging / Supercharging should still function as expected.

Your vehicle's onboard charger has detected that one or more power converters is not receiving the necessary AC input voltage. For example: during three-phase charging, one phase might be missing from the AC input power provided by the external source. This could occur due to a condition affecting the external charging equipment, the power source it is connected to, or your vehicle itself.

What to do:

This alert is usually specific to external charging equipment and power sources and does not typically indicate an issue with your vehicle that can be resolved by scheduling service.

Try charging with multiple, different types of charging equipment.

You can also try charging your vehicle using a Tesla Supercharger or Destination Charging location, all of which can be located through the map on your vehicle's touchscreen display. See [Maps and Navigation on page 147](#) for more details.

For more information on troubleshooting Mobile Connector or Wall Connector status lights, refer to the product's Owner's Manual at [Charging & Adapter Product Guides](#).

TAS2_a313

Adaptive ride control degraded **Ride comfort may be reduced**

What this alert means:

There is an issue with your vehicle's Adaptive Suspension Damping system. As a result, the system cannot provide real-time adjustments to the suspension system to optimize both ride and handling.

Instead, all dampers are receiving fixed current. Your ride may be softer or firmer than usual.

What to do:

If this alert persists throughout subsequent drives, schedule service at your earliest convenience. Your vehicle is OK to drive in the meantime.

This alert is accompanied by a yellow indicator light on the instrument panel. For more information, see [Air Suspension on page 129](#).

TAS2_a314

Adaptive ride control degraded **Drive with caution**

What this alert means:

There is an issue with your vehicle's Adaptive Suspension Damping system. As a result, the system cannot provide real-time adjustments to the suspension system to optimize both ride and handling, and your ride may be softer than usual.



What to do:

If this alert persists throughout subsequent drives, schedule service at your earliest convenience. Your vehicle is OK to drive in the meantime.

This alert is accompanied by a red indicator light on the instrument panel. For more information, see [Air Suspension on page 129](#).

UI_a006
Service is required
Schedule service now

What this alert means:

This alert is set remotely by Tesla when a condition requiring service is detected on your vehicle.

This alert can be set due to various conditions. When you schedule service, more information should be available.

This alert can only be cleared by a service technician after your vehicle has been serviced.

What to do:

As this alert can be present due to various conditions, it is recommended that you schedule service at your earliest convenience.

UI_a137
Active service connection to vehicle
Service performing remote diagnostics

What this alert means:

A service technician is remotely logged into your vehicle for diagnosis or repair. You may notice some loss of Infotainment functionality while the connection persists, but this alert does not indicate an issue with your vehicle.

Your vehicle is OK to drive.

What to do:

This alert should clear automatically after the technician completes vehicle diagnosis or repair. You may find it necessary to restart your touchscreen to restore full Infotainment functionality after the alert has cleared. For more information, see [Restarting the Touchscreen](#) in your vehicle's [Do It Yourself Guide](#).

If this alert does not clear after 24 hours, it is recommended that you schedule service via your Tesla Mobile App or with an independent service provider. Please note that independent service provider options may vary, based on your vehicle configuration and your location.

UMC_a001
Unable to charge with Mobile Connector
Inadequate outlet grounding - Try another outlet

What this alert means:

The Mobile Connector has detected that the electrical outlet has insufficient grounding, likely caused by an inadequate or missing ground connection.

This does not indicate an issue with your Mobile Connector or vehicle, but instead points to an issue with the wall outlet / electrical installation the Mobile Connector is connected to.

What to do:



Troubleshooting Alerts

Have the electrical installation inspected by an electrician. Your electrician should make sure there is proper grounding at your circuit breaker or power distribution box, and also make sure that appropriate connections are made to the outlet, before you attempt to plug in the Mobile Connector again.

If you need to charge in the meantime, try charging using a different outlet, at another location, or with another type of charging station.

You can also try charging your vehicle using a Tesla Supercharger or Destination Charging location, all of which can be located through the map on your vehicle's touchscreen display. See [Maps and Navigation on page 147](#) for more details.

For more information on troubleshooting Mobile Connector status lights and charging issues, refer to the [product's owner's manual](#).

UMC_a002

Unable to charge - Mobile Connector GFCI tripped Unplug charge handle from charge port and retry

What this alert means:

The vehicle cannot charge because the ground-fault circuit interrupter (GFCI) in the Mobile Connector has tripped.

Like the GFCI in a wall outlet, this feature is designed to stop the flow of electricity when there is a problem. It has interrupted charging to protect your vehicle and the charging equipment.

This could happen for many reasons. The problem could be in the charge cable, the charge handle, the charge port, or even an onboard vehicle component.

What to do:

Inspect the charge port and the charge handle for pooled water or unusual levels of moisture. If you find excessive moisture, wait and let both the inside area of the charge port and the exposed portion of the charge handle dry sufficiently before trying again.

Inspect the charge equipment for damage.

- If the cable is in any way damaged or deteriorated, **do not use it**. Try different charging equipment instead.
- If the cable is in good condition, try charging again with the same Mobile Connector.

If the issue persists and prevents charging, try charging with different charging equipment.

This alert is usually specific to external charging equipment and power sources and does not typically indicate an issue with your vehicle that can be resolved by scheduling service.

You can also try charging your vehicle using a Tesla Supercharger or Destination Charging location, all of which can be located through the map on your vehicle's touchscreen display. See [Maps and Navigation on page 147](#) for more details.

For more information on troubleshooting Mobile Connector status lights and charging issues, refer to the [product's owner's manual](#).

UMC_a004

Unable to charge with Mobile Connector Voltage too high / Try a different wall outlet

What this alert means:

The vehicle cannot charge, or charging is interrupted, because **either** the Mobile Connector:

- Detects the wall outlet voltage is too high, **or**



- Detects an unexpected increase in supply voltage from the wall outlet.

What to do:

Try charging the vehicle with a different wall outlet. If the vehicle starts to charge, the issue was likely with the original wall outlet. Contact an electrician to inspect the building wiring connection to that outlet.

If the vehicle still does not charge when you try a different wall outlet, try charging at a different location.

You can also try charging your vehicle using a Tesla Supercharger or Destination Charging location, all of which can be located through the map on your vehicle's touchscreen display. See [Maps and Navigation on page 147](#) for more details.

For more information on troubleshooting Mobile Connector status lights and charging issues, refer to the [product's owner's manual](#).

UMC_a005 Unable to charge with Mobile Connector Voltage too low / Try a different wall outlet

What this alert means:

The vehicle cannot charge, or charging is interrupted, because **either** the Mobile Connector:

- Does not detect enough supply voltage from the wall outlet, **or**
- Detects an unexpected drop in supply voltage from the wall outlet.

What to do:

Try charging the vehicle with a different wall outlet. If the vehicle starts to charge, the issue was likely with the original wall outlet. Contact an electrician to inspect the building wiring connection to that outlet.

If the vehicle still does not charge when you try a different wall outlet, try charging at a different location.

This alert is usually specific to external charging equipment and power sources and does not typically indicate an issue with your vehicle that can be resolved by scheduling service.

You can also try charging your vehicle using a Tesla Supercharger or Destination Charging location, all of which can be located through the map on your vehicle's touchscreen display. See [Maps and Navigation on page 147](#) for more details.

For more information on troubleshooting Mobile Connector status lights and charging issues, refer to the [product's owner's manual](#).

UMC_a007 Mobile Connector control box temperature high Let Mobile Connector cool to resume charging

What this alert means:

Charging has been interrupted because the Mobile Connector has detected a high temperature inside its control box housing.

What to do:

Make sure the Mobile Connector is not covered by anything, and that there is no heat source nearby. If the problem persists in normal ambient temperatures (under 100°F or 38°C), service is required.



Troubleshooting Alerts

You can also try charging your vehicle using a Tesla Supercharger or Destination Charging location, all of which can be located through the map on your vehicle's touchscreen display. See [Maps and Navigation on page 147](#) for more details.

For more information on troubleshooting Mobile Connector status lights and charging issues, refer to the [product's owner's manual](#).

UMC_a008

Unable to charge - Wall plug temperature high Wall outlet and wiring inspection recommended

What this alert means:

High temperature detected by Mobile Connector alerts indicate the outlet used to charge is becoming too warm, so charging has stopped to protect the outlet.

This does not indicate an issue with your Mobile Connector or vehicle, but instead points to an issue with the wall outlet / electrical installation the Mobile Connector is connected to.

A warm outlet may be caused by a plug that is not fully inserted, a loose building wiring connection to the outlet, or an outlet that is beginning to wear out.

What to do:

Make sure your adapter is fully plugged into the outlet. If charging speed does not return to normal, contact an electrician to inspect the outlet and building wiring connections to the outlet and complete any repairs needed.

If the outlet is worn, it should be replaced with a high-quality outlet. Consider upgrading to a Tesla Wall Connector for greater convenience and highest charging speed.

UMC_a009

Cannot charge - Charge handle temperature high Check charge handle or charge port for debris

What this alert means:

Charging has been interrupted because the Mobile Connector has detected a high temperature in the charge handle that connects to your vehicle's charge port.

What to do:

Make sure the Mobile Connector is fully inserted into your vehicle's charge port inlet.

Inspect the charge port inlet and the Mobile Connector handle for any obstructions or moisture. Make sure any obstruction in the charge port or Mobile Connector handle has been removed and any moisture has been allowed to dry, then try re-inserting the Mobile Connector handle into the charge port.

Also make sure the charge handle of the Mobile Connector is not covered by anything, and that there is no heat source nearby.

If the alert persists in normal ambient temperatures (under 100°F or 38°C), and occurs during multiple charging attempts, this may indicate a condition affecting the Mobile Connector or your vehicle. It is recommended that you schedule service at your convenience.

You can also try charging your vehicle using a Tesla Supercharger or Destination Charging location, all of which can be located through the map on your vehicle's touchscreen display. See [Maps and Navigation on page 147](#) for more details.

For more information on troubleshooting Mobile Connector status lights and charging issues, refer to the [product's owner's manual](#).

**UMC_a010****Mobile Connector to adapter connection hot
Let cool - Plug adapter fully into Mobile Connector****What this alert means:**

Charging has been interrupted because the Mobile Connector has detected a high temperature at the connection between the wall plug adapter and the control box.

What to do:

Make sure the wall plug adapter is fully connected to the Mobile Connector control box.

Also make sure the wall plug adapter is not covered by anything, and that there is no heat source nearby.

After unplugging from the power source (wall outlet), inspect the wall plug adapter connection and the Mobile Connector control box connection for any obstructions or moisture. Make sure any obstruction has been removed and any moisture has been allowed to dry, then try re-inserting the wall plug adapter into the Mobile Connector and then connecting to the power source (wall outlet).

Once the Mobile Connector control box temperature has decreased and any obstruction has been removed, the alert should clear and charging should be possible.

You can also try charging your vehicle using a Tesla Supercharger or Destination Charging location, all of which can be located through the map on your vehicle's touchscreen display. See [Maps and Navigation on page 147](#) for more details.

For more information on troubleshooting Mobile Connector status lights and charging issues, refer to the [product's owner's manual](#).

UMC_a011**Charging equipment communication error
Try again or try different equipment****What this alert means:**

Your vehicle is unable to charge because it cannot communicate effectively with the Mobile Connector. The Mobile Connector cannot confirm via proximity detection that the charge handle is fully connected to your vehicle.

What to do:

First, confirm the lack of effective communication is caused by the Mobile Connector rather than an issue with your vehicle. This is usually the case.

To confirm this, try charging the vehicle using different external charging equipment.

- If the vehicle begins charging, the issue was likely with the Mobile Connector.
- If the vehicle still does not charge, the issue may be with the vehicle.

Inspect the charge port inlet and the Mobile Connector handle for any obstructions (use a flashlight as necessary). Make sure any obstruction has been removed and any moisture has been allowed to dry, then try re-inserting the Mobile Connector handle into the charge port.

This alert is usually specific to external charging equipment and power sources and does not typically indicate an issue with your vehicle that can be resolved by scheduling service.

You can also try charging your vehicle using a Tesla Supercharger or Destination Charging location, all of which can be located through the map on your vehicle's touchscreen display. See [Maps and Navigation on page 147](#) for more details.



Troubleshooting Alerts

For more information on troubleshooting Mobile Connector status lights and charging issues, refer to the [product's owner's manual](#).

For more information on charging, see [Charging Instructions on page 163](#).

UMC_a012

Charging equipment communication error

Try again or try different equipment

What this alert means:

Your vehicle is unable to charge because it cannot communicate effectively with the Mobile Connector. The Mobile Connector detects that it cannot generate or maintain a valid control pilot signal.

What to do:

First, confirm the lack of effective communication is caused by the Mobile Connector rather than an issue with your vehicle. This is usually the case.

To confirm this, try charging the vehicle using different external charging equipment.

- If the vehicle begins charging, the issue was likely with the Mobile Connector.
- If the vehicle still does not charge, the issue may be with the vehicle.

Inspect the charge port inlet and the Mobile Connector handle for any obstructions (use a flashlight as necessary). Make sure any obstruction has been removed and any moisture has been allowed to dry, then try re-inserting the Mobile Connector handle into the charge port.

This alert is usually specific to external charging equipment and power sources and does not typically indicate an issue with your vehicle that can be resolved by scheduling service.

You can also try charging your vehicle using a Tesla Supercharger or Destination Charging location, all of which can be located through the map on your vehicle's touchscreen display. See [Maps and Navigation on page 147](#) for more details.

For more information on troubleshooting Mobile Connector status lights and charging issues, refer to the [product's owner's manual](#).

For more information on charging, see [Charging Instructions on page 163](#).

UMC_a013

Wall plug adapter error - Charge rate reduced

Plug adapter fully into Mobile Connector and retry

What this alert means:

Your Mobile Connector is unable to communicate with the wall plug adapter. Because your Mobile Connector cannot monitor the wall plug adapter temperature, charge current is automatically reduced to 8A.

What to do:

1. Unplug your Mobile Connector, including the wall plug adapter, completely from the wall outlet.
2. Make sure the connection between the wall plug adapter and the main body of your Mobile Connector is secure.
 - a. Disconnect the wall plug adapter completely from the main body of your Mobile Connector.
 - b. Fully reinsert the wall plug adapter into the main body of your Mobile Connector by pushing it into the socket until it snaps into place.
3. Try charging again by plugging the Mobile Connector, including wall plug adapter, fully into the wall outlet.



4. If the alert persists, try using a different wall plug adapter (see steps above to make sure the adapter is fully connected to your Mobile Connector).
 - a. If the alert is no longer present, the issue is likely with the wall plug adapter you were using previously.
 - b. If the alert persists, the issue is likely with your Mobile Connector.

If needed, obtain another wall plug adapter or Mobile Connector.

In the meantime, you can continue to charge with the same equipment. The charge rate will be reduced, as charge current will be limited to 8A while this condition persists.

You can also try charging your vehicle using a Tesla Supercharger or Destination Charging location, all of which can be located through the map on your vehicle's touchscreen display. See [Maps and Navigation on page 147](#) for more details.

For more information on troubleshooting Mobile Connector status lights and charging issues, refer to the [product's owner's manual](#).

UMC_a014

Wall plug adapter error - Charge rate reduced Plug adapter fully into Mobile Connector and retry

What this alert means:

Your Mobile Connector is unable to communicate with the wall plug adapter. Because your Mobile Connector cannot identify the type of wall outlet the wall plug adapter is connected to, charge current is automatically reduced to 8A.

What to do:

1. Unplug your Mobile Connector, including the wall plug adapter, completely from the wall outlet.
2. Make sure the connection between the wall plug adapter and the main body of your Mobile Connector is secure.
 - a. Disconnect the wall plug adapter completely from the main body of your Mobile Connector.
 - b. Fully reinsert the wall plug adapter into the main body of your Mobile Connector by pushing it into the socket until it snaps into place.
3. Try charging again by plugging the Mobile Connector, including wall plug adapter, fully into the wall outlet.
4. If the alert persists, try using a different wall plug adapter (see steps above to make sure the adapter is fully connected to your Mobile Connector).
 - a. If the alert is no longer present, the issue is likely with the wall plug adapter you were using previously.
 - b. If the alert persists, the issue is likely with your Mobile Connector.

If needed, obtain another wall plug adapter or Mobile Connector. In the meantime, you can continue to charge with the same equipment. The charge rate will be reduced, as charge current will be limited to 8A while this condition persists.

You can also try charging your vehicle using a Tesla Supercharger or Destination Charging location, all of which can be located through the map on your vehicle's touchscreen display. See [Maps and Navigation on page 147](#) for more details.

For more information on troubleshooting Mobile Connector status lights and charging issues, refer to the [product's owner's manual](#).

UMC_a015

Wall plug adapter error - Charge rate reduced Plug adapter fully into Mobile Connector and retry

What this alert means:

Troubleshooting Alerts

Your Mobile Connector is unable to communicate with the wall plug adapter. Because your Mobile Connector cannot identify the type of wall outlet the wall plug adapter is connected to, charge current is automatically reduced to 8A.

What to do:

1. Unplug your Mobile Connector, including the wall plug adapter, completely from the wall outlet.
2. Make sure the connection between the wall plug adapter and the main body of your Mobile Connector is secure.
 - a. Disconnect the wall plug adapter completely from the main body of your Mobile Connector.
 - b. Fully reinsert the wall plug adapter into the main body of your Mobile Connector by pushing it into the socket until it snaps into place.
3. Try charging again by plugging the Mobile Connector, including wall plug adapter, fully into the wall outlet.
4. If the alert persists, try using a different wall plug adapter (see steps above to make sure the adapter is fully connected to your Mobile Connector).
 - a. If the alert is no longer present, the issue is likely with the wall plug adapter you were using previously.
 - b. If the alert persists, the issue is likely with your Mobile Connector.

If needed, obtain another wall plug adapter or Mobile Connector. In the meantime, you can continue to charge with the same equipment. The charge rate will be reduced, as charge current will be limited to 8A while this condition persists.

You can also try charging your vehicle using a Tesla Supercharger or Destination Charging location, all of which can be located through the map on your vehicle's touchscreen display. See [Maps and Navigation on page 147](#) for more details.

For more information on troubleshooting Mobile Connector status lights and charging issues, refer to the [product's owner's manual](#).

UMC_a016 **Mobile Connector control box temperature high** **Maximum charge rate reduced**

What this alert means:

Charge current has been temporarily reduced because the Mobile Connector has detected increased temperature inside its control box housing.

What to do:

Make sure the Mobile Connector is not covered by anything, and that there is no heat source nearby. If the problem persists in normal ambient temperatures (under 100°F or 38°C), service is required.

You can also try charging your vehicle using a Tesla Supercharger or Destination Charging location, all of which can be located through the map on your vehicle's touchscreen display. See [Maps and Navigation on page 147](#) for more details.

For more information on troubleshooting Mobile Connector status lights and charging issues, refer to the [product's owner's manual](#).

UMC_a017 **Charge rate reduced - Wall plug temperature high** **Wall outlet and wiring inspection recommended**

What this alert means:

High temperature detected by Mobile Connector alerts indicate the outlet used to charge is becoming too warm, so charging has been slowed to protect the outlet.



This is not typically an issue with your vehicle or your Mobile Connector, but rather an issue with the outlet. A warm outlet may be caused by a plug that is not fully inserted, a loose building wiring connection to the outlet, or an outlet that is beginning to wear out.

What to do:

Make sure your adapter is fully plugged into the outlet. If charging speed does not return to normal, contact an electrician to inspect the outlet and building wiring connections to the outlet and complete any repairs needed.

If the outlet is worn, it should be replaced with a high-quality outlet. Consider upgrading to a Tesla Wall Connector for greater convenience and highest charging speed.

UMC_a018

Charge rate reduced - Handle temperature high Check charge handle or charge port for debris

What this alert means:

Charge current has been temporarily reduced because the Mobile Connector has detected increased temperature in the charge handle that connects to your vehicle's charge port.

What to do:

Make sure the Mobile Connector is fully inserted into your vehicle's charge port inlet.

Inspect the charge port inlet and the Mobile Connector handle for any obstructions or moisture. Make sure any obstruction in the charge port or Mobile Connector handle has been removed and any moisture has been allowed to dry, then try re-inserting the Mobile Connector handle into the charge port.

Also make sure the charge handle of the Mobile Connector is not covered by anything, and that there is no heat source nearby.

If the alert persists in normal ambient temperatures (under 100°F or 38°C), and occurs during multiple charging attempts, this may indicate a condition affecting the Mobile Connector or your vehicle. It is recommended that you schedule service at your convenience.

You can also try charging your vehicle using a Tesla Supercharger or Destination Charging location, all of which can be located through the map on your vehicle's touchscreen display. See [Maps and Navigation on page 147](#) for more details.

For more information on troubleshooting Mobile Connector status lights and charging issues, refer to the [product's owner's manual](#).

UMC_a019

Mobile Connector to adapter connection hot Maximum charge rate reduced

What this alert means:

Charge current has been reduced because the Mobile Connector has detected a high temperature at the connection between the wall plug adapter and the control box.

What to do:

Make sure the wall plug adapter is fully connected to the Mobile Connector control box.

After unplugging from the power source (wall outlet), inspect the wall plug adapter connection and the Mobile Connector control box connection for any obstructions or moisture.

It is recommended that any debris / foreign objects be removed. Make sure any obstruction has been removed and any moisture has been allowed to dry, then try re-inserting the wall plug adapter into the Mobile Connector and then connecting to the power source (wall outlet).



Troubleshooting Alerts

Also make sure the wall plug adapter is not covered by anything, and that there is no heat source nearby. If the alert persists in normal ambient temperatures (under 100°F or 38°C), and occurs during multiple charging attempts, this may indicate a condition affecting the Mobile Connector or your vehicle. It is recommended that you schedule service at your convenience.

You can also try charging your vehicle using a Tesla Supercharger or Destination Charging location, all of which can be located through the map on your vehicle's touchscreen display. See [Maps and Navigation on page 147](#) for more details.

For more information on troubleshooting Mobile Connector status lights and charging issues, refer to the [product's owner's manual](#).

VCBATT_a180 **Electrical system power reduced** **Vehicle may shut down unexpectedly**

What this alert means:

The electrical system cannot maintain the voltage required to support all vehicle features.

If this alert is present while you are driving, it is possible your vehicle will shut down unexpectedly.

If this alert is present when your vehicle is in Park or when it first wakes, it is possible your vehicle may not have adequate electrical power to start driving. A separate vehicle alert may be present to indicate that condition.

What to do:

It is recommended that you eliminate or reduce your use of any non-essential features. This can help your vehicle maintain adequate electrical power for essential functions.

If this alert remains active, schedule service immediately. Without service, your vehicle may shut down unexpectedly or may not restart.

VCBATT_a182 **Schedule service to replace low voltage battery** **Software will not update until battery is replaced**

What this alert means:

The low voltage battery is showing degraded performance and needs to be replaced. Until the low voltage battery is replaced, vehicle software updates will not complete.

What to do:

It is recommended that you have the low voltage battery replaced at your earliest convenient opportunity.

You can schedule service via your Tesla Mobile App, or with an independent service provider that offers low voltage battery replacement for your vehicle. Please note that independent service provider options may vary, based on your vehicle configuration and your location.

If the low voltage battery does not have enough electrical power to turn on your vehicle or open the doors, follow the instructions in [If Vehicle Has No Power on page 205](#).

For more information on the battery system, see [High Voltage Battery Information on page 161](#).

VCBATT_a191 **Electrical system power reduced** **Vehicle shutting down**

What this alert means:



The low voltage battery cannot provide the electrical support necessary to drive or continue driving. Your vehicle is shutting down to preserve energy for essential functions other than driving.

Your vehicle cannot be driven or continue driving while this condition continues.

What to do:

If this alert is present while you are driving, your vehicle needs to come to a stop immediately. It is recommended that you:

- Pull over safely immediately
- Use your Mobile App to contact Tesla Roadside Assistance immediately, or seek other roadside assistance if preferred

If you do not pull over safely within a short time, your vehicle may shut down unexpectedly. It is also possible that your vehicle will not restart once parked.

When this alert is present, the electrical system cannot maintain the voltage required to support all vehicle features. Many vehicle functions may no longer work.

It is possible your vehicle may lose all electrical power. If this occurs, you can still use the manual door releases to exit the vehicle if necessary. For more information, see [Opening Doors from the Interior on page 17](#).

This alert may be present due to various vehicle conditions. For more information and further recommended actions, check for other active vehicle alerts.

If this alert remains present, it is recommended that you schedule service immediately. Without service, your vehicle may not drive, may shut down unexpectedly, or may not restart.

VCFRONT_a192

Electrical system is unable to support all features Switching off features to conserve energy

What this alert means:

The electrical system cannot support all vehicle features. Your vehicle is shutting down nonessential features to preserve energy for essential functions.

If you are driving when this alert is present, it is possible your vehicle may shut down unexpectedly. It is also possible that your vehicle will not restart once parked.

Nonessential features may be unavailable, including seat heaters, cabin climate control, and in-vehicle entertainment. This is expected behavior intended to help your vehicle maintain adequate electrical power for essential functions, including the ability to operate headlights, windows and doors, hazard lights, and the front trunk (frunk).

It is possible your vehicle may lose all electrical power. If this occurs, you can still use the manual door releases to exit the vehicle if necessary. For more information, see [Opening Doors from the Interior on page 17](#).

What to do:

This alert may be present due to various vehicle conditions. For more information and further recommended actions, check for other active vehicle alerts.

VCBATT_a220

Electrical system is unable to support all features Schedule service

What this alert means:

The low voltage battery cannot provide the electrical support necessary to drive or continue driving.



Troubleshooting Alerts

It is possible your vehicle will shut down unexpectedly. It is also possible that your vehicle will not restart after the current drive.

You may notice that some nonessential features are not available. This is expected behavior due to your vehicle preserving energy for essential functions.

What to do:

If this alert is present while you are driving, your vehicle needs to come to a stop as soon as possible. Pull over safely at your earliest opportunity.

It is recommended that you eliminate or reduce your use of any nonessential features. This can help your vehicle maintain adequate electrical power for essential functions other than driving, until it can be serviced.

If this alert remains present, it is recommended that you schedule service immediately. Without service, your vehicle may not drive, may shut down unexpectedly, or may not restart.

VCBATT_a402

Electrical system backup power is unavailable Vehicle will consume more energy while idle

What this alert means:

The backup power source for the electrical system, the low voltage battery, is not available or cannot provide the voltage required to support all vehicle features.

The primary source of electrical power, the high voltage battery system, will continue to support vehicle functions, even when your vehicle is idle. For more information on the high voltage battery, see [About the High Voltage Battery on page 161](#).

You may notice that some nonessential features are not available. This is expected behavior due to your vehicle preserving energy for essential functions.

You may also notice that your vehicle consumes more energy than usual when you are not driving it, or that your vehicle displays a lower projected range than you would normally expect after charging. This is normal vehicle behavior when this alert is present, and it will continue until the backup power source is restored.

There is a chance that an issue affecting the primary power source could cause your vehicle to shut down unexpectedly.

What to do:

It is recommended that you limit or avoid the use of any nonessential features. This can help your vehicle maintain adequate electrical power for essential functions.

It is recommended that you schedule service at your earliest opportunity, so the backup power source for the electrical system can be restored.

VCBATT_a496

Vehicle is preparing to shut down PULL OVER SAFELY

What this alert means:

The electrical system cannot provide adequate support to drive or continue driving. Your vehicle is preparing to shut down to preserve energy for essential functions other than driving.

Your vehicle cannot be driven or continue driving while this condition continues.

What to do:



If this alert is present while you are driving, your vehicle needs to come to a stop as soon as possible. It is recommended that you:

- Pull over safely at your earliest opportunity
- Use your Mobile App to contact Tesla Roadside Assistance immediately, or seek other roadside assistance if preferred

If you do not pull over safely within a short time, your vehicle may shut down unexpectedly. It is also possible that your vehicle will not restart once parked.

It is possible your vehicle may lose all electrical power. If this occurs, you can still use the manual door releases to exit the vehicle if necessary. For more information, see [Opening Doors from the Interior on page 17](#).

This alert may be present due to various vehicle conditions. For more information and further recommended actions, check for other active vehicle alerts.

VCSEC_a221

Air pressure below recommendation for tires Check pressure and refill air as needed

What this alert means:

This alert does NOT indicate that there is a flat tire.

The tire pressure monitoring system (TPMS) has detected that the air pressure in one or more of your tires is at least 20% lower than the recommended cold tire pressure.

See [Maintaining Tire Pressures on page 173](#) for detailed information on where to find the recommended cold pressure (RCP) for your vehicle's tires, how to check tire pressures, and how to keep your tires properly inflated.

This alert may appear in cold weather because the air in your tires naturally contracts when it becomes cold, decreasing tire pressures.

What to do:

Add air to maintain the recommended cold tire pressure. Although drops in tire pressure are expected in colder weather, the recommended cold tire pressure should be maintained at all times.

The alert may clear as the vehicle is driven. This is because the tires will warm up and the tire pressure will increase. Even if the alert clears, the tires should still be refilled with air once they have cooled.

The alert will clear once the Tire Pressure Monitoring System detects that each of your tires is inflated to the recommended cold pressure.

- The alert and Tire Pressure indicator light may still be present immediately after you have filled your tires to the recommended cold pressure, but both should clear once you have driven a short distance.
- You may need to drive over 15 mph (25 km/h) for at least 10 minutes for the Tire Pressure Monitoring System to measure and report your updated tire pressures.

If you repeatedly see this alert for the same tire, have the tire inspected for a slow leak. You can visit a local tire shop or schedule service using your Tesla Mobile App.

For more information on tire pressure and inflation, see [Tire Care and Maintenance on page 173](#).

VCSEC_a228

Air pressure in tires very low PULL OVER SAFELY - Check for flat tire

What this alert means:



Troubleshooting Alerts

This alert indicates that one or more of the tires on your vehicle is extremely low or flat.

The tire pressure monitoring system (TPMS) has detected that the air pressure in one or more of your tires is significantly lower than the recommended cold tire pressure.

What to do:

You should pull over carefully as soon as possible. In a safe location, check for a flat tire.

You can request Tesla roadside assistance options (mobile tire, loaner wheel, tow) if required. See [Contacting Tesla Roadside Assistance on page 201](#) for more information.

In a non-emergency situation, it is recommended that you visit a local tire shop for assistance or schedule service using your Tesla Mobile App.

See [Maintaining Tire Pressures on page 173](#) for detailed information on where to find the recommended cold pressure (RCP) for your vehicle's tires, how to check tire pressures, and how to keep your tires properly inflated.

The alert should clear once the Tire Pressure Monitoring System has a consistent tire pressure measurement for each of your tires of at least 30 psi.

- The alert and Tire Pressure indicator light may still be present immediately after you have filled your tires to the recommended cold pressure, but both should clear once you have driven a short distance.
- You may need to drive over 15 mph (25 km/h) for at least 10 minutes for the Tire Pressure Monitoring System to measure and report your updated tire pressures.

For more information on tire pressure and inflation, see [Tire Care and Maintenance on page 173](#).



Document Applicability

For the latest and greatest information that is customized to your vehicle, view the Owner's Manual on your vehicle's touchscreen by touching **Controls** > **Service** > **Owner's Manual**. The information is specific to your vehicle depending on the features you purchased, vehicle configuration, market region and software version. In contrast, owner information that is provided by Tesla elsewhere is updated as necessary and may not contain information unique to your vehicle.

Information about new features is displayed on the touchscreen after a software update, and can be viewed at any time by touching **Controls** > **Software** > **Release Notes**. If the content in the Owner's Manual on how to use your vehicle conflicts with information in the Release Notes, the Release Notes take precedence.

Illustrations

The illustrations provided in this document are for demonstration purposes only. Depending on vehicle options, software version and market region, the information displayed on the touchscreen in your vehicle may appear slightly different.

Feature Availability

Some features are available only on some vehicle configurations and/or only in specific market regions. Options or features mentioned in the Owner's Manual does not guarantee they are available on your specific vehicle. See [Feature Availability Statement on page 260](#) for more information.

Errors or Inaccuracies

All specifications and descriptions are known to be accurate at time of publishing. However, because continuous improvement is a goal at Tesla, we reserve the right to make product modifications at any time. To communicate any inaccuracies or omissions, or to provide general feedback or suggestions regarding the quality of the Owner's Manual, send an email to ownersmanualfeedback@tesla.com.

Location of Components

Owner information may specify the location of a component as being on the left or right side of the vehicle. As shown, left (1) and right (2) represent the side of the vehicle when sitting inside.

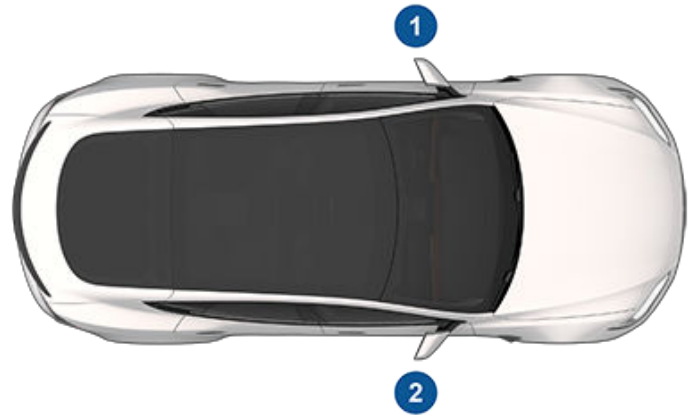

Copyrights and Trademarks

© 2012-2023 Tesla, Inc. All information in this document and all vehicle software is subject to copyright and other intellectual property rights of Tesla, Inc. and its licensors. This material may not be modified, reproduced or copied, in whole or in part, without the prior written permission of Tesla, Inc. and its licensors. Additional information is available upon request. Tesla uses software created by the Open Source community. Please visit Tesla's Open Source software website at <http://www.tesla.com/opensource>. HD Radio is a registered trademark of iBiquity Digital Corporation. The following are trademarks or registered trademarks of Tesla, Inc. in the United States and other countries:

TESLA



TESLA MOTORS

TESLA ROADSTER



MODEL S

MODEL X

MODEL 3

MODEL Y



T E S L A

All other trademarks contained in this document are the property of their respective owners and their use herein does not imply sponsorship or endorsement of their products or services. The unauthorized use of any trademark displayed in this document or on the vehicle is strictly prohibited.



Feature Availability Statement

Your Tesla is constantly changing, with new features being added and improved upon with every software update. However, depending on the firmware release operating on your vehicle, your vehicle may not be equipped with all features or may not operate exactly as described in this Owner's Manual. The features on your vehicle vary depending on market region, vehicle configuration, options purchased, software updates, and more.

Referencing options or features mentioned in this Owner's Manual does not guarantee they are available on your specific vehicle. The best way to ensure you are getting the latest and greatest features is update your vehicle's software as soon as you receive the notification to do so. You can also set your preferences to **Controls > Software > Software Preferences > Advanced**. See [Software Updates on page 143](#) for more information. For the features available on your vehicle, always comply with local laws and limits to ensure the safety of you, your passengers, and those around you.

Event Data Recorder (EDR)

Model S is equipped with an event data recorder (EDR). The main purpose of an EDR is to record, in certain crash or near crash-like situations, such as an air bag deployment or hitting a road obstacle, data to better understand how the vehicle's systems performed. The EDR is designed to record data related to vehicle dynamics and safety systems for a short period of time, typically 30 seconds or less. The EDR in Model S is designed to record data such as:

- How various systems in your vehicle were operating;
- Whether or not the driver and passenger safety belts were buckled/fastened;
- How far (if at all) the driver was depressing the accelerator and/or brake pedal; and,
- How fast the vehicle was traveling.

The data can help provide a better understanding of the circumstances in which crashes and injuries occur.

NOTE: EDR data is recorded by your vehicle only if a non-trivial crash situation occurs; no data is recorded by the EDR under normal driving conditions and no personal data (for example, name, gender, age, and crash location) is recorded. However, other parties, such as law enforcement, could combine the EDR data with the type of personally identifying data routinely acquired during a crash investigation.

To read data recorded by an EDR, special equipment is required, and access to the vehicle or the EDR is needed. In addition to the vehicle manufacturer, other parties, such as law enforcement, that have the special equipment, can read the information if they have access to the vehicle or the EDR. Tesla may also access the EDR remotely in some crash circumstances.

Vehicle Telematics

Model S is equipped with electronic modules that monitor and record data from various vehicle systems, including the motor, Autopilot components, Battery, braking and electrical systems. The electronic modules record information about various driving and vehicle conditions, including braking, acceleration, trip and other related information regarding your vehicle. These modules also record information about the vehicle's features such as charging events and status, the enabling/disabling of various systems, diagnostic trouble codes, VIN, speed, direction and location.

The data is stored by the vehicle and may be accessed, used and stored by Tesla service technicians during vehicle servicing or periodically transmitted to Tesla wirelessly through the vehicle's telematics system. This data may be used by Tesla for various purposes, including, but not limited to: providing you with Tesla telematics services; troubleshooting; evaluation of your vehicle's quality, functionality and performance; analysis

and research by Tesla and its partners for the improvement and design of our vehicles and systems; to defend Tesla; and as otherwise may be required by law. In servicing your vehicle, Tesla can potentially resolve issues remotely simply by reviewing your vehicle's data log.

Tesla's telematics system wirelessly transmits vehicle information to Tesla on a periodic basis. The data is used as previously described and helps ensure the proper maintenance of your vehicle. Additional Model S features may use your vehicle's telematics system and the information provided, including features such as charging reminders, software updates, and remote access to, and control of, various systems of your vehicle.

Tesla does not disclose the data recorded in your vehicle to any third party except when:

- An agreement or consent from the vehicle's owner (or the leasing company for a leased vehicle) is obtained.
- Officially requested by the police or other authorities.
- Used as a defense for Tesla.
- Ordered by a court of law.
- Used for research purposes without disclosing details of the vehicle owner or identification information.
- Disclosed to a Tesla affiliated company, including their successors or assigns, or our information systems and data management providers.

For additional information regarding how Tesla processes data collected from your vehicle, please review Tesla's Privacy Notice at <http://www.tesla.com/about/legal>.

Data Sharing

For quality assurance and to support the continuous improvement of advanced features such as Autopilot, your Model S may collect analytics, road segment, diagnostic, and vehicle usage data and send to Tesla for analysis. This analysis helps Tesla improve products and services by learning from the experience of billions of miles that Tesla vehicles have driven. Although Tesla shares this data with partners that contribute similar data, the collected information does not identify you personally and can be sent to Tesla only with your explicit consent. In order to protect your privacy, personal information is either not logged at all, is subject to privacy preserving techniques, or is removed from any reports before being sent to Tesla. You have control over what data you share by touching **Controls > Software > Data Sharing**.

For additional information regarding how Tesla processes data collected from your vehicle, please review Tesla's Privacy Notice at <http://www.tesla.com/about/legal>.



NOTE: Although Model S uses GPS in connection with driving and operation, as discussed in this owner's manual, Tesla does not record or store vehicle-specific GPS information, except the location where a crash occurred. Consequently, Tesla is unable to provide historical information about a vehicle's location (for example, Tesla is unable to tell you where Model S was parked/traveling at a particular date/time).

Quality Control

You might notice a few miles/km on the odometer when you take delivery of your Model S. This is a result of a comprehensive testing process that ensures the quality of your Model S.

The testing process includes extensive inspections during and after production. The final inspection takes place at Tesla and includes a road test conducted by a technician.

California Proposition 65

⚠ WARNING: Operating, servicing and maintaining a passenger vehicle or off-highway motor vehicle can expose you to chemicals including phthalates and lead, which are known to the State of California to cause cancer and birth defects or other reproductive harm. To minimize exposure, wear gloves or wash your hands frequently when servicing your vehicle. For more information go to: www.P65Warnings.ca.gov/passenger-vehicle.

⚠ WARNING: Certain components of this vehicle such as airbag modules and seat belt pretensioners may contain Perchlorate Material. Special handling may be required for service or vehicle end of life disposal. See www.dtsc.ca.gov/hazardouswaste/perchlorate.

⚠ WARNING: Battery posts, terminals, and related accessories contain lead and lead compounds. Wash hands after handling.



Contacting Tesla

For detailed information about your Model S, go to <http://www.tesla.com> and log on to your Tesla account or sign up to get an account.

If you have any questions or concerns about your Model S, in the United States, Canada or Puerto Rico, call 1-877-79TESLA (1-877-798-3752) and in Mexico, call 1-800-228-8145.

NOTE: You can also use voice commands to provide feedback to Tesla. Say "Report", "Feedback", or "Bug report" followed by brief comments. Model S takes a snapshot of its systems, including your current location, vehicle diagnostic data, and screen captures of the touchscreen and instrument panel. Tesla periodically reviews these notes and uses them to continue improving Model S.

Reporting Safety Defects - US

If you believe that Model S has a defect which could cause a crash or could cause injury or death, you should immediately inform the National Highway Traffic Safety Administration (NHTSA) in addition to notifying Tesla.

If NHTSA receives similar complaints, it may open an investigation. If it finds that a safety defect exists in a group of vehicles, it may order a recall and remedy campaign. However, NHTSA cannot become involved in individual problems between you, your dealer, or Tesla.

To contact NHTSA, you may call the Vehicle Safety Hotline toll-free at 1-888-327-4236 (TTY: 1-800-424-9153); go to www.safercar.gov; or write to: Administrator, National Highway Traffic Safety, 1200 New Jersey Avenue SE., Washington, DC 20590. You can also obtain other information about motor vehicle safety from www.safercar.gov.

Reporting Safety Defects - Canada

If you believe that your Model S has a defect which could cause a crash or could cause injury or death, you should immediately inform Transport Canada, in addition to notifying Tesla. To contact Transport Canada, call their toll-free number: 1-800-333-0510.



FCC and ISED Certification

Component	Manufacturer	Model	Operating Frequency (MHz)	FCC ID	IC
B Pillar Endpoint	Tesla	1614291	13.56 2400-2483.5 6000-8500	2AEIM-1614291	20098-1614291
Security Controller	Tesla	1614280	2400-2483.5	2AEIM-1614280	20098-1614280
Fascia Endpoint	Tesla	1613851	2400-2483.5 6000-8500	2AEIM-1613851	20098-1613851
Fascia Endpoint	Tesla	1733130	2400-2483.5 6000-8500 315 or 433.9	2AEIM-1733130	20098-1733130
Key fob	Tesla	1614283	2400-2483.5 6000-8500	2AEIM-1614283	20098-1614283
TPMS	Tesla	1472547G	2400-2483.5	2AEIM-1472547G	20098-1472547G
Tire, Michelin PS4S Summer T2	Michelin	1420298-00-B 1420299-00-B	2400- 2483.5	F15TMSAF02	5056ATMSAF02
Radar (if equipped)	Continental	ARS 4-B	76000-77000	OAYARS4B	4135A-ARS4B
Homelink (if equipped)	Gentex	ADHL5C	286-440	NZLADHL5C	4112A-ADHL5C
CarPC	Tesla	1960000	--	XMR2020AG525RGL YZP-ATC5CPC001	10224A-2020AG525R 7414C-ATC5CPC001
Wireless Charger	Tesla	WC4	127.72 KHz 13.56 2400-2483.5	2AEIM-WC4	20098-WC4
Wireless Charger	Tesla	WC3	127.72KHz	2AEIM-WC3	20098-WC3
BT USB hub	Tesla	1642783	2400-2483.5	2AEIM-1642783	20098-1642783
In-cabin radar*	Tesla	1616631	60000-64000	2AEIM-1616631	20098-1616631

* The in-cabin radar is restricted to factory installation.

The devices listed above comply with Part 15 of the FCC rules and Industry Canada's license-exempt RSS Standard(s) and EU Directive 2014/53/EU.

Operation is subject to the following two conditions: (1) this device may not cause harmful interference, and (2) this device must accept any interference received, including interference that may cause undesired operation.

Changes or modifications not expressly approved by Tesla could void your authority to operate the equipment.



Le présent appareil est conforme aux CNR d'Industrie Canada applicables aux appareils radio exempts de licence. L'exploitation est autorisée aux deux conditions suivantes : (1) l'appareil ne doit pas produire de brouillage, et (2) l'utilisateur de l'appareil doit accepter tout brouillage radioélectrique subi, même si le brouillage est susceptible d'en compromettre le fonctionnement.

Radiation Exposure Statement

The products comply with the FCC/ISED RF Exposure for Low Power Consumer Wireless Power Transfer. RF exposure limits are set forth for an uncontrolled environment and are safe for intended operation as described in this manual. The farthest RF exposure demonstrated by compliance was at 20cm and farther from the user's body; set the device to low output power if such function is available.

Cet équipement est conforme aux limites d'exposition aux rayonnements ISED établies pour un environnement non contrôlé.

Déclaration d'exposition aux radiations

Le produit est conforme à l'exposition RF ISED pour le transfert de puissance sans fil de consommateurs de faible puissance. La limite d'exposition RF fixée pour un environnement non contrôlé est sans danger pour le fonctionnement prévu tel que décrit dans ce manuel. L'exposition RF supplémentaire que la conformité a été démontrée à 20cm et plus de séparation du corps de l'utilisateur ou de mettre l'appareil à la puissance de sortie inférieure si une telle fonction est disponible.

Mexico

IFT-008-SCFI-2015 / NOM-208-SCFI-2016

Key fob, model: 1614283, IFT#: RLVTE1621-3394

TPMS, model: 1472547G, IFT#: RCPTE1421-4384

La operación de este equipo está sujeta a las siguientes dos condiciones:

1. Es posible que este equipo o dispositivo no cause interferencia perjudicial.
2. Este equipo debe aceptar cualquier interferencia, incluyendo la que pueda causar su operación no deseada.

Radio Frequency Information

This equipment has been tested and found to comply with the limits for a Class B digital device, pursuant to Part 15 of the FCC Rules. These limits are designed to provide reasonable protection against harmful interference in a residential installation. This equipment generates, uses and can radiate radio frequency energy and, if not installed and used in accordance with the instructions, may cause harmful interference to radio communications. However, there is no guarantee that interference will not occur in a particular installation. If this equipment does cause harmful interference to radio or television reception, which can be determined by turning the equipment off and on, try to correct the interference by one or more of the following measures:

- Reorient or relocate the receiving antenna.
- Increase the separation between the equipment and receiver.
- Connect the equipment into an outlet on a circuit different from that to which the receiver is connected.
- Consult the dealer or an experienced radio/TV technician to help.



CAUTION: This equipment and its antennas must not be co-located or operated with another antenna or transmitter.



Canada

CAN ICES-003 (B)/NMB-003(B)

Le présent appareil est conforme aux CNR d'Industrie Canada applicables aux appareils radioexempts de licence. L'exploitation est autorisée aux deux conditions suivantes : (1) l'appareil ne doit pas produire de brouillage, et (2) l'utilisateur de l'appareil doit accepter tout brouillage radioélectrique subi, même si le brouillage est susceptible d'en compromettre le fonctionnement.

Cet équipement est conforme aux limites d'exposition aux rayonnements ISED établies pour un environnement non contrôlé.

Déclaration d'exposition aux radiations

Le produit est conforme à l'exposition RF ISED pour le transfert de puissance sans fil de consommateurs de faible puissance. La limite d'exposition RF fixée pour un environnement non contrôlé est sans danger pour le fonctionnement prévu tel que décrit dans ce manuel. L'exposition RF supplémentaire que la conformité a été démontrée à 20cm et plus de séparation du corps de l'utilisateur ou de mettre l'appareil à la puissance de sortie inférieure si une telle fonction est disponible.

A

ABS (Anti-lock Braking System): [66](#)
absolute speed limit: [117](#)
accessories, plugging into power socket: [27](#)
Active Road Noise Reduction: [27](#)
adaptive headlights: [59](#)
adjacent lane speed: [88](#)
adjustment (lumbar): [29](#)
aero covers: [175](#)
air circulation: [119](#)
air conditioning: [119](#)
air distribution: [119](#)
air filter: [124](#)
air vents: [122](#)
airbags: [41](#)
alarm: [133](#), [136](#)
all-season tires: [177](#)
Always Show Estimated Round Trip Energy: [151](#)
anti-lock braking (ABS): [66](#)
apps: [6](#)
Arcade: [156](#)
audio: [153](#), [156](#)
 playing files: [153](#), [156](#)
 settings: [153](#)
 volume control: [153](#)
auto fold: [52](#)
Auto Lane Change: [90](#)
auto tilt: [52](#)
AUTO wipers: [65](#)
automatic emergency braking: [115](#)
automatic navigation: [147](#)
 navigating: [147](#)
Autopark: [103](#)
autopilot: [111](#)
 side collision warning: [111](#)
Autopilot: [81](#), [84](#), [88](#), [90](#), [103](#), [105](#), [114](#), [117](#)
 Auto Lane Change: [90](#)
 automatic emergency braking: [114](#)
 Autopark: [103](#)
 Autosteer: [88](#)
 collision avoidance assist: [114](#)
 forward collision warning: [114](#)
 overtake acceleration: [84](#)
 overview: [81](#)
 speed assist: [117](#)
 speed limit warning: [117](#)
 staying within speed limits: [117](#)
 Summon: [105](#)
 Traffic-Aware Cruise Control: [84](#)

Autopilot components: [81](#)

Autosteer: [88](#)

average range: [170](#)

B

backup camera: [77](#)
Battery (high voltage): [161](#), [194](#)
 care of: [161](#)
 specifications: [194](#)
 temperature limits: [161](#)
battery (key), replacing: [14](#)
battery (low voltage): [161](#), [194](#)
 complete discharge: [161](#)
 specifications: [194](#)
Blind Spot Camera: [111](#)
Blind Spot Collision Warning: [111](#)
Blind Spot Collision Warning Chime: [111](#)
Bluetooth: [126](#), [154](#)
 devices, playing audio files from: [154](#)
 general information: [126](#)
 phone, pairing and using: [126](#)
body repairs: [185](#)
body touch up: [180](#)
Boombox: [156](#), [157](#)
brakes: [66](#), [115](#), [192](#)
 automatic in emergencies: [115](#)
 overview of: [66](#)
 specifications: [192](#)
Bumper Clearance (Summon): [105](#)

C

cabin air filter: [124](#)
cabin camera: [118](#)
cabin temperature control: [119](#)
Calendar: [126](#), [128](#)
California Proposition 65: [262](#)
camera, rear-facing: [77](#)
cameras (autopilot): [81](#)
Camp: [123](#)
car cover: [180](#)
car wash mode: [178](#)
car washes: [179](#)
Caraoke): [154](#)
card: [12](#)
cargo area: [21](#)
cargo volume information: [192](#)
carpets, cleaning: [180](#)
CCS (Combo): [160](#)
CE certifications: [264](#)
CHAdEMO: [160](#)



- chains: [177](#)
- change of ownership: [11](#)
- charge port: [163](#)
- charge port light: [164](#)
- charge port manual release: [167](#)
- charge port release cable: [167](#)
- charging: [159](#), [160](#), [163](#)
 - components and equipment: [159](#)
 - instructions: [163](#)
 - public charging stations: [160](#)
- charging locations, finding: [150](#)
- charging stations, displaying on map: [147](#)
- child protection: [19](#)
 - disabling rear window switches: [19](#)
- child safety seats, installing and using: [35](#)
- cleaning: [178](#)
- climate controls: [119](#)
- coat hangers, rear: [27](#)
- cold weather best practices: [79](#)
- collision avoidance assist: [114](#)
- Colorizer: [156](#)
- connecting to Wi-Fi: [142](#)
- console, low voltage power socket: [27](#)
- console, rear: [25](#)
- consumption chart: [170](#)
- contact information: [202](#), [264](#)
 - roadside assistance: [202](#)
 - Tesla: [264](#)
- copyrights: [259](#)
- covers, seat: [31](#)
- cruise control: [84](#)

D

- dashboard overview: [4](#)
- Dashcam: [135](#)
- data recording: [261](#)
- data sharing: [261](#)
- declarations of conformity: [264](#)
- delivery mileage: [262](#)
- devices: [154](#)
 - Bluetooth, playing audio files: [154](#)
- dimensions (vehicle exterior): [190](#)
- dimensions (vehicle interior): [190](#)
- dimensions (vehicle): [190](#)
- display settings: [6](#)
- Dog: [123](#)
- door handles: [17](#)
- door labels: [188](#)
- door seals: [180](#)
 - cleaning: [180](#)

- doors: [17](#), [18](#)
 - Child Lock: [18](#)
 - interior locking and unlocking: [18](#)
 - locking: [17](#)
 - opening from interior: [17](#)
 - Unlock on Park: [18](#)
 - unlocking: [17](#)
- doors function: [18](#)
 - Walk-Away Door Lock: [18](#)
- Drag Strip Mode: [73](#)
- Drive: [56](#)
- drive away locking: [18](#)
- drive modes: [55](#)
- driver: [47](#)
 - profiles: [47](#)
- driving: [53](#), [169](#)
 - starting: [53](#)
 - tips to maximize range: [169](#)

E

- easy entry, driver profile: [47](#)
- EDR (event data recorder): [261](#)
- electric parking brake: [68](#)
- emergency braking: [114](#)
- Emergency Lane Departure Avoidance: [111](#)
- emergency lights: [60](#)
- emission control label: [187](#)
- energy: [61](#), [67](#)
 - gained from regenerative braking: [67](#)
 - range information: [61](#)
- Energy app: [170](#)
- energy use predictions (navigating): [151](#)
- Entertainment: [156](#)
- Erase & Reset: [11](#)
- event data recording: [261](#)
- exterior: [3](#), [178](#), [180](#)
 - car cover: [180](#)
 - cleaning: [178](#)
 - overview: [3](#)
 - polishing, touch up, & repair: [180](#)

F

- factory defaults, restoring: [11](#)
- factory reset: [11](#)
- fan speed, interior: [119](#)
- favorites (Media Player): [154](#)
- Favorites (navigation): [147](#)
- FCC certifications: [264](#)
- feature availability: [260](#)
- features, downloading new: [143](#)

firmware (software) updates: [143](#)
flash drive: [135](#), [136](#)
flashers, hazard warning: [60](#)
floor mats: [181](#)
fluids: [172](#)
 replacement intervals: [172](#)
folding and raising rear seats: [30](#)
forward collision warning: [114](#)
front passenger detection: [43](#)
front trunk: [22](#)
front, rear seats: [29](#)

G

G-meter: [74](#)
gaming controllers: [156](#)
garage doors, opening: [139](#)
gates, opening: [139](#)
GAWR: [188](#)
Glovebox PIN: [133](#)
glovebox, open: [25](#)
Gross Axle Weight Rating: [188](#)
Gross Vehicle Weight Rating: [188](#)
ground clearance (vehicle): [190](#)
GVWR: [188](#)

H

Handling Balance (Track Mode): [74](#)
hazard lights: [60](#)
hazards: [60](#)
head restraints: [30](#)
head supports: [30](#)
headlights, adaptive: [59](#)
headlights, after exit: [59](#)
headlights, Auto High Beam: [58](#)
headlights, high beam: [58](#)
headlights, high beams: [58](#)
heating: [119](#)
height adjustments (suspension): [184](#)
 disabling (Jack mode): [184](#)
height adjustments, air suspension: [129](#)
high voltage: [159](#), [172](#), [194](#)
 Battery specifications: [194](#)
 components: [159](#)
 safety: [172](#)
Home: [6](#)
 button: [6](#)
 screen: [6](#)
Home location: [149](#)
HomeLink: [105](#), [139](#)
 programming and using: [139](#)

 when using Summon: [105](#)
hood: [22](#)
horn: [50](#)
hub caps: [175](#)

I

I'm Feeling Lucky, Hungry: [147](#)
IC certifications: [264](#)
instant range: [170](#)
instrument panel: [61](#), [180](#)
 cleaning: [180](#)
 overview of: [61](#)
interior: [4](#), [119](#), [179](#)
 cleaning: [179](#)
 overview: [4](#)
 temperature control: [119](#)
interior cabin camera: [118](#)
intrusion detection: [133](#)
ISOFIX child seats, installing: [37](#)

J

J1772: [160](#)
Jack mode: [184](#)
jacking: [184](#)
jump start: [206](#), [207](#)
jump starting: [205](#)

K

Keep Climate On: [123](#)
key: [14](#), [264](#)
 FCC and IC certifications: [264](#)
 replacing battery: [14](#)
key card: [12](#)
keys: [12](#), [15](#)
 adding key cards and phone keys: [15](#)
 deleting key cards and phone keys: [15](#)
 displaying a list of: [15](#)
 overview: [12](#)

L

label: [188](#)
 Tire and Loading Information: [188](#)
 vehicle certification: [188](#)
lane assist: [111](#)
lane change, automatic: [90](#)
Lane Departure Avoidance: [111](#)
Lap Timer: [74](#)
LATCH child seats, installing: [37](#)
liftgate: [20](#)
 adjust opening height: [20](#)



- opening: [20](#)
- lifting: [184](#)
- lights, dome (map): [58](#)
- lights, exterior: [58](#)
- lights, fog: [58](#)
- lights, hazard warning: [60](#)
- lights, headlights after exit: [59](#)
- lights, interior: [58](#)
- load limits: [188](#)
- location tracking: [147](#)
- locking: [17](#)
- low voltage power socket: [27](#)

M

- maintenance: [171](#), [172](#), [173](#), [178](#), [182](#), [183](#)
 - cleaning: [178](#)
 - daily checks: [171](#)
 - fluid replacement intervals: [172](#)
 - monthly checks: [171](#)
 - replacing wiper blades: [182](#)
 - service intervals: [171](#)
 - tires: [173](#)
 - washer fluid, topping up: [182](#)
 - washer jets, cleaning: [183](#)
- map orientation: [147](#)
- map updates: [152](#)
- mats: [181](#)
- media: [153](#), [156](#)
 - settings: [153](#)
 - sources, show and hide: [153](#)
- microphones, noise reduction: [27](#)
- mileage upon delivery: [262](#)
- mirrors: [52](#)
- mobile app: [145](#)
- mobile app access: [145](#)
- Mobile Connector: [160](#), [163](#)
 - description: [160](#)
 - using: [163](#)
- modifications: [185](#)
- motor specifications: [192](#)
- My Apps: [10](#)
- my car does what?: [156](#)
- myQ: [139](#)
 - programming and using: [139](#)

N

- naming your vehicle: [11](#)
- Navigate on Autopilot: [93](#)
- NCC certifications: [264](#)
- Neutral: [57](#)

- NHTSA, contacting: [264](#)

O

- Obstacle-Aware Acceleration: [114](#)
- occupancy sensor: [43](#)
- occupant classification: [44](#)
- odometer: [76](#)
- Off-Peak Charging: [168](#)
- offset from speed limit: [117](#)
- Online Routing: [151](#)
- opening console: [25](#)
- opening hood without power: [205](#)
- overhang dimensions for your vehicle: [190](#)
- overtake acceleration: [84](#)
- Owner Information, about: [259](#)

P

- Park: [56](#)
- Park Assist: [70](#)
- parking brake: [68](#)
- parking, using Autopark: [103](#)
- parking, using Summon: [105](#)
- parts replacement: [185](#)
- passenger detection: [43](#)
- passenger front airbag: [43](#)
- pedestrian warning: [78](#)
- personal data, erasing: [11](#)
- phone: [12](#), [126](#)
 - authenticating as a key: [12](#)
 - using: [126](#)
- phone app: [127](#)
- phone charger, inductive: [26](#)
- phone charger, wireless: [26](#)
- phone key: [12](#), [15](#)
 - adding as a key: [15](#)
 - removing as a key: [15](#)
- PIN: [48](#)
- PIN to Drive: [133](#)
- Post-drive Cooling (Track Mode): [74](#)
- power: [67](#)
 - gained from regenerative braking: [67](#)
- power cycling: [53](#)
- power windows: [19](#), [186](#)
- powering on and off: [53](#)
- Preconditioning: [168](#)
- Proposition 65: [262](#)
- public charging stations: [160](#)

R

- radio: [153](#), [156](#)

- Radio Frequency information: [264](#)
- range: [61](#), [67](#), [169](#)
 - displayed on instrument panel: [61](#)
 - driving tips to maximize: [169](#)
 - regenerative braking: [67](#)
- range assurance: [169](#)
- re-naming your vehicle: [11](#)
- Re-route: [151](#)
- reading light, rear: [27](#)
- rear view camera: [77](#)
- rear window switches, disabling: [19](#)
- recent (Media Player): [154](#)
- Recents (navigation): [147](#)
- recording: [135](#), [136](#)
- recording videos (Track Mode): [74](#)
- regenerative braking: [67](#)
- regenerative braking, in Track Mode: [74](#)
- relative speed limit: [117](#)
- release notes: [144](#)
- restarting the touchscreen: [53](#)
- Reverse: [56](#)
- RFID transponders: [185](#)
- ride height, air suspension: [129](#)
- roadside assistance: [202](#)
- rotating tires: [174](#)
- Round Trip Energy (navigating): [151](#)
- run out of range: [206](#), [207](#)
- S**
- safety defects, reporting: [264](#)
- safety information: [34](#), [39](#), [45](#)
 - airbags: [45](#)
 - child seats: [39](#)
 - seat belts: [34](#)
- satellite radio: [154](#)
- Schedule: [168](#)
- schedule service: [145](#)
- scheduled charging: [168](#)
- scheduled departure: [168](#)
 - using: [168](#)
- seat adjustment: [29](#)
- seat adjustment (driver): [29](#)
- seat belts: [32](#), [33](#), [180](#)
 - cleaning: [180](#)
 - in a collision: [33](#)
 - overview of: [32](#)
 - pre-tensioners: [33](#)
 - wearing when pregnant: [32](#)
- seat heaters: [119](#)
- seating capacity: [188](#)
- seating position: [44](#)
- seating position for driving: [29](#)
- seats: [119](#)
 - heaters: [119](#)
- security settings: [133](#)
- self-leveling: [129](#)
- sensors: [81](#)
- Sentry Mode: [136](#)
- service data recording: [261](#)
- service intervals: [171](#)
- Settings, erasing: [11](#)
- shifting: [55](#)
- shortcuts: [8](#), [10](#)
 - adding to My Apps: [10](#)
 - restarting the touchscreen: [8](#)
- Show Calendar Upon Entry: [126](#), [128](#)
- side camera(s): [77](#)
- Side Clearance (Summon): [105](#)
- side collision warning: [111](#)
- SiriusXM: [154](#)
- slip start: [69](#)
- Smart Summon: [108](#)
- smartphone: [12](#)
 - authenticating as a key: [12](#)
- Software Reinstall: [143](#)
- software reset: [11](#)
- software update preferences: [143](#)
- software updates: [143](#)
- specifications: [192](#), [194](#)
 - brakes: [192](#)
 - High Voltage Battery: [194](#)
 - low voltage battery: [194](#)
 - motor: [192](#)
 - steering: [192](#)
 - subsystems: [192](#)
 - suspension: [194](#)
 - tires: [194](#)
 - transmission: [192](#)
 - wheels: [194](#)
- specifications (vehicle interior): [190](#)
- specifications and dimensions: [190](#)
- specifications, exterior: [190](#)
- speed assist: [117](#)
- speed limit warning: [117](#)
- Stability Assist (Track Mode): [74](#)
- stability control: [69](#)
- standby: [136](#)
- starting: [53](#)
- steering specifications: [192](#)
- steering, automatic: [88](#)



summer tires: [177](#)
Summon: [105](#)
Summon Distance: [105](#)
superchargers, displaying on map: [147](#)
supercharging: [166](#)
 described: [166](#)
 idle fees: [166](#)
 pay-per-use fees: [166](#)
suspension: [129](#)
suspension specifications: [194](#)
suspension, air: [129](#)
suspension, auto-raising: [129](#)
suspension, damping: [129](#)

T

telematics: [261](#)
temperature: [50](#), [61](#), [119](#), [161](#), [197](#)
 Battery (high voltage), limits: [161](#)
 cabin, controls for: [119](#)
 heated: [50](#)
 outside: [61](#)
 tires: [197](#)
tesla profiles: [47](#)
Teslacam: [135](#), [136](#)
tie-down straps: [205](#)
tilt/intrusion detection: [133](#)
Tire and Loading Information label: [188](#)
tire noise: [177](#)
Tire Pressure Monitoring System: [175](#)
 overview of: [175](#)
tire pressures, checking: [173](#)
tire pressures, displaying: [173](#)
tires: [173](#), [174](#), [176](#), [177](#), [194](#), [195](#), [197](#)
 all-season: [177](#)
 balancing: [174](#)
 chains: [177](#)
 inspecting and maintaining: [173](#)
 pressures, displaying: [173](#)
 pressures, how to check: [173](#)
 quality grading: [197](#)
 replacing: [174](#)
 replacing a tire sensor: [176](#)
 rotation: [174](#)
 specification: [194](#)
 summer: [177](#)
 temperature grades: [197](#)
 tire markings: [195](#)
 traction grade: [197](#)
 treadwear grade: [197](#)
 wheel configuration: [173](#)

winter: [177](#)
toll system transponders, attaching: [185](#)
torque specifications: [192](#)
touch up body: [180](#)
touchscreen: [6](#), [8](#), [10](#), [143](#), [180](#)
 adding shortcuts: [10](#)
 cleaning: [180](#)
 customizing My Apps: [10](#)
 display settings: [6](#)
 frozen: [8](#)
 main: [6](#)
 overview: [6](#)
 rear: [6](#)
 reboot: [8](#)
 software updates: [143](#)
 unresponsive: [8](#)
towing: [203](#), [206](#), [207](#)
towing, instructions: [202](#)
towing, transporting: [202](#)
Toybox: [156](#)
TPMS: [175](#)
 overview of: [175](#)
Track Mode: [74](#)
Tracking Disabled: [147](#)
traction control: [69](#)
trademarks: [259](#)
Traffic Light and Stop Sign Control: [96](#)
Traffic-Aware Cruise Control: [84](#)
transmission specifications: [192](#)
transponders, attaching: [185](#)
Transport Canada, contacting: [264](#)
Transport Mode: [203](#)
transporting: [203](#)
trip chart: [170](#)
trip meter: [76](#)
Trip Planner: [151](#)
trunk, front: [22](#)
trunk, rear: [20](#)
turn signals, lights: [60](#)

U

ultrasonic sensors: [81](#)
uniform tire quality grading: [197](#)
Unlock On Park: [18](#)
unlocking: [17](#)
USB devices, connecting: [25](#)
USB flash drive: [133](#), [135](#), [136](#)
USB ports, console: [25](#)

V

Valet mode: [48](#)
vehicle certification label: [188](#)
vehicle identification labels: [187](#)
Vehicle Identification Number (VIN) labels: [187](#)
vehicle lights: [58](#)
vehicle loading: [188](#)
ventilation: [122](#)
video call: [128](#)
video clips: [135](#)
videos and recording (Track Mode): [74](#)
View Live Camera: [136](#)
voice commands: [131](#)
volume control: [6](#)
volume control (media): [153](#)

W

Walk-Away Door Lock: [18](#)
Wall Connector: [160](#)
warning flashers: [60](#)
washer fluid, topping up: [182](#)
washer jets, cleaning: [183](#)
washers, using: [65](#)
web conferencing: [128](#)
wheel chocks: [205](#)
wheels: [174](#), [175](#), [194](#)

- aero covers, removing and installing: [175](#)
- alignment: [174](#)
- replacing: [174](#)
- specifications: [194](#)
- torque: [194](#)

Wi-Fi, connecting to: [142](#)
windshield washer fluid, topping up: [182](#)
winter tires: [177](#)
wiper blades, replacing: [182](#)
wipers, using: [65](#)
Work location: [149](#)

Z

Zoom: [128](#)

TESLA

Publication date: 2023/02/28