

# FORD **MUSTANG MACH-E** Owner's Manual 2022





The information contained in this publication was correct at the time of going to print. In the interest of continuous development, we reserve the right to change specifications, design or equipment at any time without notice or obligation. No part of this publication may be reproduced, transmitted, stored in a retrieval system or translated into any language in any form by any means without our written permission. Errors and omissions excepted.

© Ford Motor Company 2021

All rights reserved.

Part Number: 202109 20210913121328

## California Proposition 65



**WARNING:** Operating, servicing and maintaining a passenger vehicle or off-highway motor vehicle can expose you to chemicals including engine exhaust, carbon monoxide, phthalates, and lead, which are known to the State of California to cause cancer and birth defects or other reproductive harm. To minimize exposure, avoid breathing exhaust, do not idle the engine except as necessary, service your vehicle in a well-ventilated area and wear gloves or wash your hands frequently when servicing your vehicle. For more information go to [www.P65Warnings.ca.gov/passenger-vehicle](http://www.P65Warnings.ca.gov/passenger-vehicle).



**WARNING:** Battery posts, terminals and related accessories contain lead and lead compounds, chemicals known to the State of California to cause cancer and reproductive harm.  
**Wash your hands after handling.**



# Table of Contents

---

## Contacting Us

Contacting Us .....	15
---------------------	----

## Introduction

About This Publication .....	17
Using This Publication .....	18

## Symbols Glossary

Symbols Used on Your Vehicle .....	19
------------------------------------	----

## Data Privacy

Data Privacy .....	21
Service Data .....	22
Event Data .....	22
Settings Data .....	23
Connected Vehicle Data .....	23
Mobile Device Data .....	24
Emergency Call System Data .....	24

## Visual Search

Steering Wheel .....	25
Instrument Panel .....	26
Instrument Panel - GT .....	27
Vehicle Interior .....	28
Vehicle Interior - GT .....	29
Front Exterior .....	30
Front Exterior - GT .....	31
Rear Exterior .....	32
Rear Exterior - GT .....	33

## Child Safety

Child Safety Precautions .....	34
Child Restraint Anchor Points .....	35
Child Restraints .....	36
Installing Child Restraints .....	37
Booster Seats .....	42
Child Safety Locks .....	44

## Seatbelts

Seatbelt Precautions .....	45
Fastening and Unfastening the Seatbelts .....	46
Sensitive Locking Mode .....	47
Automatic Locking Mode .....	47
Adjusting the Seatbelts During Pregnancy .....	48
Adjusting the Seatbelt Height .....	48
Seatbelt Reminder .....	48
Checking the Seatbelts .....	50
Seatbelt Extensions .....	51

## Personal Safety System™

What Is the Personal Safety System .....	52
How Does the Personal Safety System Work .....	52
Personal Safety System Components .....	52

## Airbags

How Do the Front Airbags Work .....	53
How Do the Side Airbags Work .....	53
How Do the Knee Airbags Work .....	54
How Does the Safety Canopy™ Work .....	54
Airbag Precautions .....	55
Properly Adjusting the Driver and Front Passenger Seats .....	56
Children and Airbags .....	56
Front Passenger Sensing System .....	57
Crash Sensors and Airbag Indicator .....	60
Disposing of Airbags .....	61

## Pedestrian Alert System

What Is the Pedestrian Alert System .....	62
---	----

## 911 Assist

What Is 911 Assist .....	63
--------------------------	----

# Table of Contents

---

How Does 911 Assist Work .....	63
Emergency Call Requirements .....	63
Emergency Call Limitations .....	64

## Keys and Remote Controls

Remote Control Limitations .....	65
Using the Remote Control .....	65
Sounding the Panic Alarm .....	65
Locating Your Vehicle .....	66
Changing the Remote Control Battery .....	66
Replacing a Lost Key or Remote Control .....	68
Programming the Remote Control .....	68
Keys and Remote Controls – Troubleshooting .....	68

## Phone as a Key

What Is Phone As a Key .....	69
Phone as a Key Limitations .....	69
Programming Your Phone .....	69
Using the Valet Mode .....	70
Using the Backup Start Passcode .....	70
Phone as a Key – Troubleshooting .....	70

## MyKey™

What Is MyKey .....	72
MyKey Settings .....	72
Creating a MyKey .....	73
Programming a MyKey .....	73
Clearing All MyKeys .....	73
Checking MyKey System Status .....	74
Using MyKey With Remote Start Systems .....	74
MyKey – Troubleshooting .....	74

## Doors and Locks

Operating the Doors From Outside Your Vehicle .....	76
Operating the Doors From Inside Your Vehicle .....	76

Autounlock .....	77
Autolock .....	77
Mislock .....	77
Doors and Locks Audible Warnings .....	77
Doors and Locks – Troubleshooting .....	78

## Keyless Entry

Keyless Entry Limitations .....	80
Keyless Entry Settings .....	80
Using Keyless Entry .....	80
Keyless Entry – Troubleshooting .....	81

## Keyless Entry Keypad

What Is the Keyless Entry Keypad .....	82
Keyless Entry Keypad Limitations .....	82
Locating the Keyless Entry Keypad .....	82
Keyless Entry Keypad Master Access Code .....	82
Keyless Entry Keypad Personal Access Codes .....	82
Using the Keyless Entry Keypad .....	83
Keyless Entry Keypad – Troubleshooting .....	84

## Walk Away Lock

What is Walk Away Lock .....	85
How Does Walk Away Lock Work .....	85
Walk Away Lock Limitations .....	85
Switching Walk Away Lock On and Off .....	85
Switching Walk Away Lock Audible Feedback On and Off .....	85

## Easy Entry and Exit

How Does Easy Entry and Exit Work .....	86
Switching Easy Entry and Exit On and Off .....	86

# Table of Contents

---

## Liftgate - Vehicles With: Hands-Free Liftgate

Liftgate Precautions .....	87
Opening the Liftgate .....	87
Setting the Liftgate Opening Height .....	89
Closing the Liftgate .....	89
Stopping the Liftgate Movement .....	91
Liftgate Obstacle Detection .....	91
Liftgate – Troubleshooting .....	91

## Liftgate - Vehicles With: Manual Liftgate

Opening the Liftgate .....	94
Closing the Liftgate .....	94

## Security

Passive Anti-Theft System .....	96
Anti-Theft Alarm System .....	96
Anti-Theft Alarm System Settings .....	97
Security – Troubleshooting .....	98

## Steering Wheel

Adjusting the Steering Wheel .....	100
Horn .....	100
Switching the Heated Steering Wheel On and Off .....	100

## Wipers and Washers

Wipers .....	101
Autowipers .....	101
Switching the Rear Window Wiper On and Off .....	102
Reverse Wipe .....	102
Checking the Wiper Blades .....	103
Replacing the Front Wiper Blades .....	103
Replacing the Rear Wiper Blades .....	103
Washers .....	104
Wipers and Washers – Troubleshooting .....	105

## Exterior Lighting

Exterior Lighting Control .....	106
Headlamps .....	106
Headlamps – Troubleshooting .....	107
Autolamps .....	107
Exterior Lamps .....	108
Automatic High Beam Control .....	109
Automatic High Beam Control – Troubleshooting .....	111

## Interior Lighting

Switching All of the Interior Lamps On and Off .....	112
Switching the Front Interior Lamps On and Off .....	112
Switching the Rear Interior Lamps On and Off .....	112
Interior Lamp Function .....	112
Adjusting the Instrument Panel Lighting Brightness .....	113
Ambient Lighting .....	113
Interior Lighting – Troubleshooting .....	113

## Windows

Opening and Closing the Windows .....	114
Global Opening and Closing .....	114
Window Bounce-Back .....	115
Locking the Rear Window Controls .....	115

## Interior Mirror

Interior Mirror Precautions .....	116
Auto-Dimming Interior Mirror .....	116

## Exterior Mirrors

Adjusting the Exterior Mirrors .....	117
Folding the Exterior Mirrors - Vehicles With: Manual Folding Mirrors .....	117
Folding the Exterior Mirrors - Vehicles With: Power Folding Mirrors .....	118

# Table of Contents

---

## Instrument Cluster

Instrument Cluster Overview .....	119
Speedometer .....	119
Vehicle Range Display .....	119
High Voltage Battery Gauge .....	120
What Are the Instrument Cluster Warning Lamps .....	120
Instrument Cluster Warning Lamps .....	121
What Are the Instrument Cluster Indicators .....	122
Instrument Cluster Indicators .....	122

## Instrument Cluster Display

What Is Brake Coach .....	124
---------------------------	-----

## Trip Computer

Accessing the Trip Computer .....	125
Resetting the Trip Computer .....	125
Trip Data .....	125

## Remote Start

What Is Remote Start .....	126
Remote Start Limitations .....	126
Enabling Remote Start .....	126
Remotely Starting and Stopping the Vehicle .....	126
Extending the Remote Start Duration .....	126
Remote Start Settings .....	127

## Climate Control

Identifying the Climate Control Unit .....	128
Switching Climate Control On and Off .....	128
Switching Recirculated Air On and Off .....	128
Switching Air Conditioning On and Off .....	128
Switching Defrost On and Off .....	128
Switching Maximum Defrost On and Off .....	129

Switching Maximum Cooling On and Off .....	129
Switching the Heated Wiper Park On and Off .....	129
Switching the Heated Rear Window On and Off .....	129
Setting the Blower Motor Speed .....	129
Switching the Heated Mirrors On and Off .....	129
Setting the Temperature .....	129
Directing the Flow of Air .....	130
Auto Mode .....	130
Climate Control Hints .....	131

## Interior Air Quality

What Is the Cabin Air Filter .....	133
Replacing the Cabin Air Filter .....	133

## Front Seats

Front Seat Precautions .....	134
Sitting in the Correct Position .....	134
Manual Seats .....	135
Power Seats .....	137
Heated Seats .....	140

## Rear Seats

Manual Seats .....	141
--------------------	-----

## Rear Occupant Alert System

What is the Rear Occupant Alert System .....	143
How Does the Rear Occupant Alert System Work .....	143
Rear Occupant Alert System Precautions .....	143
Rear Occupant Alert System Limitations .....	143
Switching Rear Occupant Alert System On and Off .....	143
Rear Occupant Alert System Indicators .....	144



# Table of Contents

---

Rear Occupant Alert System Audible Warnings .....	144
---	-----

## Memory Function

What Is the Memory Function .....	145
Memory Function Precautions .....	145
Locating the Memory Function Buttons .....	145
Saving a Preset Position .....	145
Recalling a Preset Position .....	145

## Garage Door Opener

What Is the Garage Door Opener .....	146
How Does the Garage Door Opener Work .....	146
Garage Door Opener Precautions .....	146
Garage Door Opener Limitations .....	146
Programming the Garage Door Opener to Your Hand-Held Transmitter .....	147
Programming the Garage Door Opener to Your Garage Door Opener Motor .....	147
Programming the Garage Door Opener to Your Gate Opener Motor .....	148
Clearing the Garage Door Opener .....	148
Reprogramming the Garage Door Opener .....	149
Garage Door Opener Radio Frequencies .....	149

## USB Ports

Locating the USB Ports .....	150
Playing Media Using the USB Port .....	150
Charging a Device .....	151

## Power Outlet

What Is the Power Outlet .....	152
Power Outlet Precautions .....	152
Locating the Power Outlets .....	152

## Wireless Accessory Charger

What Is the Wireless Accessory Charger .....	153
Wireless Accessory Charger Precautions .....	153
Locating the Wireless Accessory Charger .....	153
Charging a Wireless Device .....	153

## Storage

Cup Holders .....	154
Glove Compartment .....	154
Glasses Holder .....	154

## Starting and Powering Off

Starting and Powering Off Precautions .....	155
Starting the Vehicle .....	155
Powering Off .....	155
Restarting the Vehicle After Powering Off .....	155
Accessing the Passive Key Backup Position .....	156
Starting and Powering Off – Troubleshooting .....	156

## High Voltage Battery

What Is the High Voltage Battery .....	157
High Voltage Battery Precautions .....	157
Preserving Your High Voltage Battery .....	157
Recycling and Disposing of the High Voltage Battery .....	158
High Voltage Battery – Troubleshooting .....	158

## Charging Your Vehicle

What is AC Charging .....	159
What is DC Charging .....	159
Charging Your Vehicle Precautions .....	159
Charging Equipment .....	159
Locating the Charge Port .....	168

# Table of Contents

---

Charge Port Indicators .....	168
AC Charging .....	169
DC Charging .....	172
Setting the Charging Schedule and Preferences .....	174
Using FordPass and Charging .....	179
Charging Your Vehicle Hints .....	180
Charging Your Vehicle – Troubleshooting .....	180

## Automatic Transmission

Automatic Transmission Precautions .....	182
Automatic Transmission Positions .....	182
Shifting Your Vehicle Into Gear .....	183
Temporary Neutral Mode .....	183
Automatic Return to Park (P) .....	184

## All-Wheel Drive

How Does All-Wheel Drive Work .....	185
All-Wheel Drive Precautions .....	185
All-Wheel Drive Limitations .....	185
All-Wheel Drive – Troubleshooting .....	185

## Brakes

Brake Precautions .....	186
Anti-Lock Braking System .....	186
Brake Over Accelerator .....	186
Locating the Brake Fluid Reservoir .....	186
Checking the Brake Fluid .....	186
Brake Fluid Specification .....	187
Brakes – Troubleshooting .....	187

## Electric Parking Brake

What Is the Electric Parking Brake .....	189
Applying the Electric Parking Brake .....	189
Applying the Electric Parking Brake in an Emergency .....	189
Manually Releasing the Electric Parking Brake .....	189

Automatically Releasing the Electric Parking Brake .....	189
Electric Parking Brake Audible Warning .....	190
Releasing the Electric Parking Brake if the Vehicle Battery Has Run Out of Charge .....	190
Electric Parking Brake – Troubleshooting .....	190

## Reverse Braking Assist

What Is Reverse Braking Assist .....	192
How Does Reverse Braking Assist Work .....	192
Reverse Braking Assist Precautions .....	192
Switching Reverse Braking Assist On and Off .....	193
Overriding Reverse Braking Assist .....	193
Reverse Braking Assist Indicators .....	193
Reverse Braking Assist – Troubleshooting .....	194

## Hill Start Assist

What Is Hill Start Assist .....	196
How Does Hill Start Assist Work .....	196
Hill Start Assist Precautions .....	196

## Auto Hold

How Does Auto Hold Work .....	197
Switching Auto Hold On and Off .....	197
Using Auto Hold .....	197
Auto Hold Indicators .....	197

## Traction Control

What Is Traction Control .....	198
How Does Traction Control Work .....	198
Switching Traction Control On and Off .....	198
Traction Control Indicator .....	198
Traction Control – Troubleshooting .....	199

# Table of Contents

---

## Stability Control

How Does Stability Control Work .....	200
Switching Stability Control On and Off .....	201
Stability Control Indicator .....	203

## Steering

Electric Power Steering .....	204
Steering – Troubleshooting .....	205

## Parking Aids

Parking Aid Precautions .....	206
Switching Parking Aid On and Off .....	206
Rear Parking Aid .....	207
Front Parking Aid .....	207
Side Parking Aid .....	208
Parking Aid Indicators .....	210
Parking Aids – Troubleshooting .....	210

## Rear View Camera

What Is the Rear View Camera .....	211
Rear View Camera Precautions .....	211
Locating the Rear View Camera .....	211
Rear View Camera Guide Lines .....	211
Rear View Camera Object Distance Indicators .....	212
Rear View Camera Settings .....	212

## 360 Degree Camera

What Is the 360 Degree Camera .....	214
How Does the 360 Degree Camera Work .....	214
360 Degree Camera Precautions .....	214
360 Degree Camera Limitations .....	214
Locating the 360 Degree Cameras .....	214
360 Degree Camera Guide Lines .....	215
360 Degree Camera Settings .....	216

## Active Park Assist

What Is Active Park Assist .....	217
----------------------------------	-----

How Does Active Park Assist Work .....	217
Active Park Assist Precautions .....	217
Switching Active Park Assist On and Off .....	217
Entering a Parallel Parking Space .....	217
Entering a Perpendicular Parking Space .....	218
Exiting a Parking Space .....	218
Active Park Assist – Troubleshooting .....	219

## Adaptive Cruise Control

How Does Adaptive Cruise Control With Stop and Go Work .....	221
Adaptive Cruise Control Precautions .....	221
Adaptive Cruise Control Limitations .....	221
Switching Adaptive Cruise Control On and Off .....	223
Adaptive Cruise Control Automatic Cancellation .....	224
Setting the Adaptive Cruise Control Speed .....	224
Setting the Adaptive Cruise Control Gap .....	225
Canceling the Set Speed .....	226
Resuming the Set Speed .....	226
Overriding the Set Speed .....	228
Adaptive Cruise Control Indicators .....	228
Switching From Adaptive Cruise Control to Cruise Control .....	228
Lane Centering .....	228
Intelligent Adaptive Cruise Control .....	231
Adaptive Cruise Control – Troubleshooting .....	232

## BlueCruise - Vehicles With: Hands Free Driving

What Is BlueCruise .....	235
How Does BlueCruise Work .....	235
BlueCruise Precautions .....	235

# Table of Contents

---

BlueCruise Requirements .....	236
BlueCruise Limitations .....	236
BlueCruise Settings .....	237
Switching BlueCruise On and Off .....	237
BlueCruise Alerts .....	238
BlueCruise Automatic Cancellation .....	238
BlueCruise Indicators .....	238
BlueCruise – Troubleshooting .....	239

## Drive Mode Control

What Is Drive Mode Control .....	241
Selecting a Drive Mode .....	241
Drive Modes .....	241

## One Pedal Drive

What is One Pedal Drive .....	243
One Pedal Drive Precautions .....	243
One Pedal Drive Limitations .....	243
Switching One Pedal Drive On and Off .....	243
One Pedal Drive Indicators .....	243

## Lane Keeping System

What Is the Lane Keeping System .....	244
How Does the Lane Keeping System Work .....	244
Lane Keeping System Precautions .....	244
Lane Keeping System Limitations .....	244
Switching the Lane Keeping System On and Off .....	245
Switching the Lane Keeping System Mode .....	245
Lane Keeping System Settings .....	245
Alert Mode .....	246
Aid Mode .....	246
Alert and Aid Mode .....	246
Lane Keeping System Indicators .....	247
Blind Spot Assist .....	247
Lane Keeping System – Troubleshooting .....	249

## Blind Spot Information System

What Is Blind Spot Information System .....	252
How Does Blind Spot Information System Work .....	252
Blind Spot Information System Precautions .....	252
Blind Spot Information System Limitations .....	252
Blind Spot Information System Requirements .....	252
Switching Blind Spot Information System On and Off .....	252
Locating the Blind Spot Information System Sensors .....	253
Blind Spot Information System Indicators .....	253
Blind Spot Information System – Troubleshooting .....	254

## Cross Traffic Alert

What Is Cross Traffic Alert .....	255
How Does Cross Traffic Alert Work .....	255
Cross Traffic Alert Precautions .....	255
Cross Traffic Alert Limitations .....	255
Switching Cross Traffic Alert On and Off .....	255
Locating the Cross Traffic Alert Sensors .....	256
Cross Traffic Alert Indicators .....	256
Cross Traffic Alert – Troubleshooting .....	257

## Pre-Collision Assist

What Is Pre-Collision Assist .....	258
How Does Pre-Collision Assist Work .....	258
Pre-Collision Assist Precautions .....	258
Pre-Collision Assist Limitations .....	259
Switching Pre-Collision Assist On and Off .....	260

# Table of Contents

---

Locating the Pre-Collision Assist Sensors .....	260	What Is the Maximum Loaded Trailer Weight .....	272
Distance Indication .....	261	What Is the Gross Combined Weight Rating .....	273
Distance Alert .....	262	Calculating Payload .....	273
Automatic Emergency Braking .....	263	Calculating the Load Limit .....	274
Evasive Steering Assist .....	263		
Pre-Collision Assist – Troubleshooting .....	264		
		<b>Luggage Compartment</b>	
<b>Driver Alert</b>		Luggage Compartment Precautions .....	276
What Is Driver Alert .....	266	Opening and Closing the Front Luggage Compartment .....	276
How Does Driver Alert Work .....	266	Using the Front Luggage Compartment Emergency Release .....	277
Driver Alert Precautions .....	266	Installing and Removing the Luggage Compartment Cover .....	278
Driver Alert Limitations .....	266	Adjusting the Luggage Compartment Load Floor .....	279
Switching Driver Alert On and Off .....	267	Luggage Compartment Anchor Points .....	279
Driver Alert Indicators .....	267		
Driver Alert – Troubleshooting .....	267		
		<b>Towing a Trailer</b>	
<b>Speed Sign Recognition</b>		Towing a Trailer Precautions .....	280
What Is Speed Sign Recognition .....	268		
How Does Speed Sign Recognition Work .....	268	<b>Driving Hints</b>	
Speed Sign Recognition Precautions .....	268	Cold Weather Precautions .....	281
Speed Sign Recognition Limitations .....	268	Driving on Snow and Ice .....	281
Speed Sign Recognition Indicators .....	268	Breaking-In .....	281
Setting the Speed Sign Recognition Speed Warning .....	269	Performance Vehicle Precautions .....	281
Setting the Speed Sign Recognition Speed Tolerance .....	269	Driving in Special Conditions .....	281
Speed Sign Recognition – Troubleshooting .....	269	Electric Vehicle .....	283
		Driving Through Shallow Water .....	284
		Floor Mats .....	284
		<b>Crash and Breakdown Information</b>	
<b>Load Carrying</b>		Roadside Assistance .....	286
Load Carrying Precautions .....	271	Switching the Hazard Flashers On and Off .....	286
Locating the Safety Compliance Certification Labels .....	272	Jump Starting the Vehicle .....	287
What Is the Gross Axle Weight Rating .....	272	Post-Crash Alert System .....	289
What Is the Gross Vehicle Weight Rating .....	272	Post Impact Braking .....	289

# Table of Contents

---

Automatic Crash Shutoff .....	290
Transporting the Vehicle .....	290

## Towing Your Vehicle

Towing Your Vehicle Precautions .....	292
Recreationally Towing Your Vehicle .....	292
Emergency Towing .....	292
Towing Your Vehicle – Troubleshooting .....	293

## Fuses

Fuse Precautions .....	294
Under Hood Fuse Box .....	294
Battery Fuse Box .....	299
Body Control Module Fuse Box .....	301
Identifying Fuse Types .....	304
Fuses – Troubleshooting .....	304

## Maintenance

Maintenance Precautions .....	305
Opening and Closing the Hood .....	305
Under Hood Overview .....	305
Checking the Coolant .....	306
Automatic Transmission Fluid Check .....	308
12V Battery .....	308
12V Battery – Troubleshooting .....	308
Adjusting the Headlamps .....	309
Exterior Bulbs .....	310
Interior Bulbs .....	310

## Vehicle Care

General Information .....	311
Cleaning Products .....	311
Cleaning the Exterior .....	312
Waxing .....	313
Cleaning the Interior .....	313
Repairing Minor Paint Damage .....	315

## Body Styling Kits

Body Styling Kit Precautions .....	316
------------------------------------	-----

## Storing Your Vehicle

Preparing Your Vehicle for Storage .....	317
Removing Your Vehicle From Storage .....	318

## Wheel and Tire Information

Locating the Tire label .....	319
Department of Transportation Uniform Tire Quality Grades .....	319
Information on the Tire Sidewall .....	320
Glossary of Tire Terminology .....	325
Tire Replacement Requirements .....	326
Using Summer Tires .....	328
Using Winter Tires .....	329
Using Snow Chains .....	329

## Tire Care

Checking the Tire Pressures .....	331
Inflating the Tires .....	331
Inspecting the Tire for Wear .....	332
Inspecting the Tire for Damage .....	332
Inspecting the Wheel Valve Stems .....	333
Tire Rotation .....	333

## Tire Sealant and Inflator Kit

What Is the Tire Sealant and Inflator Kit .....	335
Tire Sealant and Inflator Kit Precautions .....	335
Locating the Tire Sealant and Inflator Kit .....	335
Tire Sealant and Inflator Kit Components .....	335
Using the Tire Sealant and Inflator Kit .....	336

# Table of Contents

---

## **Tire Pressure Monitoring System**

What Is the Tire Pressure Monitoring System .....	341
Tire Pressure Monitoring System Overview .....	341
Tire Pressure Monitoring System Precautions .....	342
Tire Pressure Monitoring System Limitations .....	342
Viewing the Tire Pressures .....	343
Tire Pressure Monitoring System – Troubleshooting .....	343

## **Changing a Road Wheel**

Wheel Nuts .....	345
------------------	-----

## **Capacities and Specifications**

Motorcraft Parts .....	346
Cooling System Capacity and Specification .....	346
Air Conditioning System Capacity and Specification .....	347
Washer Fluid Specification .....	348
Brake Fluid Specification .....	348

## **Vehicle Identification**

Vehicle Identification Number .....	350
Installing the Vehicle Identification Card .....	350

## **Connected Vehicle**

What Is a Connected Vehicle .....	352
Connected Vehicle Requirements .....	352
Connected Vehicle Limitations .....	352
Connecting the Vehicle to a Mobile Network .....	352
Connecting the Vehicle to a Wi-Fi Network .....	352
Connected Vehicle – Troubleshooting .....	353

## **Vehicle Wi-Fi Hotspot**

Creating a Vehicle Wi-Fi Hotspot .....	356
Changing the Vehicle Wi-Fi Hotspot Name or Password .....	356

## **Audio System**

Audio System Precautions .....	358
Switching the Audio Unit On and Off .....	358
Selecting the Audio Source .....	358
Playing or Pausing the Audio Source .....	358
Adjusting the Volume .....	358
Switching Shuffle Mode On and Off .....	358
Switching Repeat Mode On and Off .....	358
Setting a Memory Preset .....	358
Muting the Audio .....	359
Adjusting the Sound Settings .....	359
Setting the Clock and Date .....	359
AM/FM Radio .....	360
Digital Radio .....	360
Satellite Radio .....	361
Audio System – Troubleshooting .....	364

## **Center Display Overview**

Center Display Precautions .....	368
Center Display Limitations .....	368
Status Bar .....	368
Accessing Feature Drawers .....	370
Center Display Settings .....	370

## **Voice Interaction**

What is Voice Interaction .....	371
Setting the Wake Word .....	371
Beginning a Voice Interaction .....	371
Voice Interaction Examples .....	371

# Table of Contents

---

## Phone

Phone Precautions .....	374
Connecting Your Phone .....	374
Phone Menu .....	374
Making and Receiving a Phone Call .....	375
Sending and Receiving a Text Message .....	376
Switching Text Message Notification On and Off .....	377

## Bluetooth®

Connecting a Bluetooth® Device .....	378
Playing Media Using Bluetooth® .....	378

## Apps

App Precautions .....	379
App Requirements .....	379
Accessing Apps .....	379
Enabling Apps on an iOS Device .....	380
Enabling Apps on an Android Device .....	380
Switching Apple CarPlay On and Off .....	380
Switching Android Auto On and Off .....	380

## Personal Profiles

How Do Personal Profiles Work .....	382
Enabling or Disabling Personal Profiles .....	382
Creating a Personal Profile .....	383
Linking or Unlinking a Personal Profile to a Remote Control .....	383
Linking or Unlinking a Personal Profile to a Device .....	383
Personal Profile Settings .....	383

## Navigation

Accessing Navigation .....	385
Navigation Map Updates .....	385
Adjusting the Map .....	385
Live Traffic .....	385

Setting a Destination .....	385
Waypoints .....	386
Route Guidance .....	386

## Vehicle System Updates

Updating the Vehicle Systems Wirelessly .....	387
Performing a Master Reset .....	388

## Accessories

Accessories .....	389
-------------------	-----

## Ford Protect

What Is Ford Protect .....	390
----------------------------	-----

## Scheduled Maintenance

General Maintenance Information .....	392
Normal Scheduled Maintenance .....	394

## Customer Information

Rollover Warning .....	396
The Better Business Bureau Auto Line Program .....	396
The Mediation and Arbitration Program .....	397
Ordering a Canadian French Owner's Manual .....	397
Reporting Safety Defects in the United States .....	398
Reporting Safety Defects in Canada .....	398
Declaration of Conformity .....	399
Radio Frequency Certification Labels .....	399
Perchlorate .....	423
Replacement Parts Recommendation .....	423
Mobile Communications Equipment .....	424
Federal Highway Administration Regulation .....	424
End User License Agreement .....	425



# Table of Contents

---

Export Unique Options .....450

## **Appendices**

Electromagnetic Compatibility .....451



# Contacting Us

---

If you require assistance or clarification on policies or procedures, please contact the customer relationship center.

## United States

Ford Motor Company  
Customer Relationship Center  
PO Box 6248  
Dearborn, MI 48126  
1-800-392-3673 (FORD)  
TDD for the hearing impaired:  
7-1-1 (where offered by your telephone  
service provider)  
[www.ford.com/help/contact/](http://www.ford.com/help/contact/)

## Ford Credit - US Only

Ford Credit offers a full range of financing and lease plans to help you acquire your vehicle. If you have financed or leased your vehicle through Ford Credit, thank you for your business.

For assistance call 1-800-727-7000, or for more information about Ford Credit and access to an account manager, visit [www.ford.com/finance](http://www.ford.com/finance).

## Canada

Customer Relationship Center  
Ford Motor Company of Canada Limited  
P.O. Box 2000  
Oakville, Ontario L6J 5E4  
1-800-565-3673 (FORD)  
TDD for the hearing impaired:  
7-1-1 (where offered by your telephone  
service provider)  
[www.ford.ca](http://www.ford.ca)  
Facebook: FordServiceCA (English),  
FordServiceQC (Français)

## Australia

Ford Motor Company  
Attention: Customer Relationship Centre  
Private Mail Bag 5  
Fairlane Business Park #3  
Campbellfield, Victoria, 3061  
Telephone: 13 3673 (FORD)  
E-mail: [foacust1@ford.com](mailto:foacust1@ford.com)

## New Zealand

Ford Motor Company  
Attention: Customer Relationship Centre  
Private Bag 76912  
Manukau City 2241  
Telephone: 0800 367 369 (FORDNZ)  
E-mail: [fnzcust@ford.com](mailto:fnzcust@ford.com)

## China - Imported Vehicle

Customer Relationship Center  
Telephone: 400-690-1886  
Website: <https://www.ford.com.cn/>

## China - Chang'An Ford

Customer Relationship Center  
Telephone: 800-810-8168  
Mobile: 400-887-7766  
Website: <https://www.ford.com.cn/>

## Asia Pacific

E-mail: [expcac@ford.com](mailto:expcac@ford.com)

## Caribbean, Central America and Israel

Ford Motor Company  
Ford Export Operations  
Attention: Owner Relations  
1555 Fairlane Drive  
Fairlane Business Park #3  
Allen Park, MI 48101  
Fax: (313) 390-0804  
Telephone: (313) 594-4857  
E-mail: [expcac@ford.com](mailto:expcac@ford.com)

# Contacting Us

---

## **U.S. Virgin Islands and Puerto Rico**

Ford Motor Company  
Ford Export Operations  
Attention: Owner Relations  
1555 Fairlane Drive  
Fairlane Business Park #3  
Allen Park, MI 48101  
Telephone: (800) 841-3673  
E-mail: prcac@ford.com

## **Argentina**

Telephone: 0800-888-3673

## **Brazil**

[www.ford.com.br](http://www.ford.com.br)

## **North Africa**

E-mail: nafcrc@ford.com

## **Sub-Saharan Africa**

E-mail: ssacrc@ford.com

## **Puerto Rico**

Ford International Business Development,  
Inc.  
P.O. Box 11957  
Caparra Heights Station  
San Juan, PR 00922-1957  
1-800-392-3673 (FORD)  
Fax: (313) 390-0804  
E-mail: prcac@ford.com  
[www.ford.com.pr](http://www.ford.com.pr)

## **Middle East**

Ford Middle East Customer Relationship  
Center  
P.O. Box 21740  
Dubai, United Arab Emirates  
Telephone: 80004441066  
Toll-free number for the Kingdom of Saudi  
Arabia: 8008443673  
Mobily and Zain cell phone users in Saudi  
Arabia: 800850078  
Kuwait: 22280384  
Local telephone number for Kuwait: +965  
1898900  
Fax: +971 4 3327266  
E-mail: menacac@ford.com  
[www.me.ford.com](http://www.me.ford.com)

## **South Korea**

Telephone: +82-02-1600-6003  
E-mail: infokr1@ford.com

# Introduction

## ABOUT THIS PUBLICATION



**WARNING:** Driving while distracted can result in loss of vehicle control, crash and injury. We strongly recommend that you use extreme caution when using any device that may take your focus off the road. Your primary responsibility is the safe operation of your vehicle. We recommend against the use of any hand-held device while driving and encourage the use of voice-operated systems when possible. Make sure you are aware of all applicable local laws that may affect the use of electronic devices while driving.



**WARNING:** You risk death, fire, or serious injury to yourself and others if you do not follow the instruction highlighted by the warning symbol.

Thank you for choosing Ford. We recommend that you take some time to get to know your vehicle in order to benefit from greater safety and pleasure from driving it. Use this publication to familiarize yourself with the basics and then read the digital version, that is available in your vehicle. You can also view the comprehensive manual through the FordPass app and through the local Ford website.

**Note:** To download the FordPass app, visit your device's app store.

**Note:** To find the local Ford website, visit <https://corporate.ford.com/operations/locations/global-links.html>.

**Note:** Use and operate your vehicle in line with all applicable laws and regulations.

**Note:** Pass on all printed owner's information when selling this vehicle.

Our digital resources include a comprehensive digital Owner's Manual dynamically created according to the features on your vehicle by using the vehicle identification number. See **Locating the Vehicle Identification Number** (page 350). The digital Owner's Manual includes visual and full text search functions so that you can quickly locate the information you are looking for. It also includes links to a number of how-to videos created to help you understand some of the advanced technologies on your vehicle.

## Features and Options

This publication describes product features and options available throughout the range of available models, sometimes even before they are generally available. It could describe options that are not available on the vehicle you have purchased.

## Illustrations

Some of the illustrations in this publication could show features as used in different models, so they could appear different to you on your vehicle.

## Location of Components

This manual may qualify the location of a component as left-hand side or right-hand side. The side is determined when facing forward in the seat.

# Introduction

---

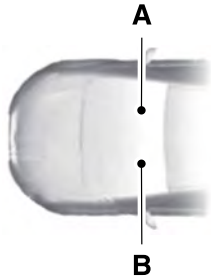

- A Right-hand side.
- B Left-hand side.

## USING THIS PUBLICATION

To quickly locate information about your vehicle, use the word search within the Owner's Manual application.

# Symbols Glossary

## SYMBOLS USED ON YOUR VEHICLE

These are some of the symbols you may see on your vehicle.



Safety alert.



See the Owner's Manual.



Air conditioning system.



Anti-lock braking system.



Avoid smoking, flames or sparks.



Battery.



Battery acid.



Brake fluid level.



Brake system



Brake system



Cabin air filter.



Child safety door lock.



Child safety door unlock.



Child seat lower anchor.



Child seat tether anchor.



Cruise control.



Do not open when hot.



Electronic power steering malfunction.



Fan warning.



Fasten seatbelt.



Front airbag.



Front fog lamps.



Fuse compartment.



Hazard warning flashers.



Heated rear window.



Heated windshield.



Interior luggage compartment release.



Jack.

# Symbols Glossary

---



Keep out of reach of children.



Lighting control.



Low tire pressure warning.



Maintain correct fluid level.



Panic alarm.



Parking aid.



Parking brake.



Power steering fluid.



Power windows.



Power window lockout.



Side airbag.



Shield the eyes.



Stability control.



Windshield wash and wipe.



# Data Privacy



**WARNING:** Do not connect wireless plug-in devices to the data link connector. Unauthorized third parties could gain access to vehicle data and impair the performance of safety related systems. Only allow repair facilities that follow our service and repair instructions to connect their equipment to the data link connector.

We respect your privacy and are committed to protecting it. The information contained in this publication was correct at the time of release but as technology rapidly changes, we recommend that you visit the local Ford website for the latest information.

Your vehicle has electronic control units that have data recording functionality and the ability to permanently or temporarily store data. This data could include information on the condition and status of your vehicle, vehicle maintenance requirements, events and malfunctions. The types of data that can be recorded are described in this section. Some of the data recorded is stored in event logs or error logs.

**Note:** *Error logs are reset following a service or repair.*

**Note:** *We may provide information in response to requests from law enforcement, other government authorities and third parties acting with lawful authority or through a legal process. Such information could be used by them in legal proceedings.*

Data recorded includes, for example:

- Operating states of system components, for example battery charge level and tire pressure.
- Vehicle and component status, for example wheel speed, deceleration, lateral acceleration and seatbelt status.

- Events or errors in essential systems, for example headlamps and brakes.
- System responses to driving situations, for example airbag deployment and stability control.
- Environmental conditions, for example temperature.

Some of this data, when used in combination with other information, for example an accident report, damage to a vehicle or eyewitness statements, could be associated with a specific person.

## Services That We Provide

If you use our services, we collect and use data, for example account information, vehicle location and driving characteristics, that could identify you. We transmit this data through a dedicated, protected connection. We only collect and use data to enable your use of our services to which you have subscribed, with your consent or where permitted by law. For additional information, see the terms and conditions of the services to which you have subscribed.

For additional information about our privacy policy, refer to the local Ford website.

## Services That Third Parties Provide

We recommend that you review the terms and conditions and data privacy information for any services equipped with your vehicle or to which you subscribe. We take no responsibility for services that third parties provide.

Where equipped, SiriusXM with 360L could use the modem. To disable, turn off the SiriusXM with 360L or Vehicle Connectivity setting. See **Enabling and Disabling the Modem** (page 352).

# Data Privacy

---

## SERVICE DATA

Service data recorders in your vehicle are capable of collecting and storing diagnostic information about your vehicle. This potentially includes information about the performance or status of various systems and modules in the vehicle, such as the high voltage battery, throttle, and steering or brake systems. In order to properly diagnose and service your vehicle, Ford Motor Company (Ford of Canada in Canada), and service and repair facilities may access or share among them vehicle diagnostic information received through a direct connection to your vehicle when diagnosing or servicing your vehicle. Additionally, Ford Motor Company (Ford of Canada, in Canada) may, where permitted by law, use vehicle diagnostic information for vehicle improvement or with other information we may have about you, for example, your contact information, to offer you products or services that may interest you. Data may be provided to our service providers such as part suppliers that may help diagnose malfunctions, and who are similarly obligated to protect data. We retain this data only as long as necessary to perform these functions or to comply with law. We may provide information where required in response to official requests to law enforcement or other government authorities or third parties acting with lawful authority or court order, and such information may be used in legal proceedings. For U.S. only (if equipped), if you choose to use connected apps and services, you consent that certain diagnostic information may also be accessed electronically by Ford Motor Company and Ford authorized service facilities, and that the diagnostic information may be used to provide services to you, personalizing your experience, troubleshoot, and to improve products and services and offer you products and services that may interest

you, where permitted by law. For Canada only, for more information, please review the Ford of Canada privacy policy at [www.ford.ca](http://www.ford.ca), including our U.S. data storage and use of service providers in other jurisdictions who may be subject to legal requirements in Canada, the United States and other countries applicable to them, for example, lawful requirements to disclose personal information to governmental authorities in those countries.

## EVENT DATA

This vehicle is equipped with an event data recorder. The main purpose of an event data recorder is to record, in certain crash or near crash-like situations, such as an airbag deployment or hitting a road obstacle; this data will assist in understanding how a vehicle's systems performed. The event data recorder is designed to record data related to vehicle dynamics and safety systems for a short period of time, typically 30 seconds or less.

The event data recorder in this vehicle is designed to record such data as:

- How various systems in your vehicle were operating.
- Whether or not the driver and passenger seatbelts were buckled/fastened.
- How far (if at all) the driver was depressing the accelerator and/or the brake pedal.
- How fast the vehicle was traveling.
- Where the driver was positioning the steering wheel.

This data can help provide a better understanding of the circumstances in which crashes and injuries occur.

# Data Privacy

**Note:** *Event data recorder data is recorded by your vehicle only if a non-trivial crash situation occurs; no data is recorded by the event data recorder under normal driving conditions and no personal data or information (for example name, gender, age, and crash location) is recorded.*

*However, parties, such as law enforcement, could combine the event data recorder data with the type of personally identifying data routinely acquired during a crash investigation.*

To read data recorded by an event data recorder, special equipment is required, and access to the vehicle or the event data recorder is needed. In addition to the vehicle manufacturer, other parties, such as law enforcement, that have such special equipment, can read the information if they have access to the vehicle or the event data recorder.

## BlueCruise Data (If Equipped)

If BlueCruise is active in certain crash or near crash-like situations, such as an airbag deployment or hitting a road obstacle, the system may record driver attentiveness, based on the direction of eyes and duration, and photographs of the driver seat area.

**Note:** *No data is recorded under normal driving conditions.*

## SETTINGS DATA

Your vehicle has electronic control units that have the ability to store data based on your personalized settings. The data is stored locally in the vehicle or on devices that you connect to it, for example, a USB drive or digital music player. You can delete some of this data and also choose whether to share it through the services to which you subscribe.

## Comfort and Convenience Data

Data recorded includes, for example:

- Seat and steering wheel positions.
- Climate control settings.
- Radio presets.

## Entertainment Data

Data recorded includes, for example:

- Music, videos or album art.
- Contacts and corresponding address book entries.
- Navigation destinations.

## CONNECTED VEHICLE DATA



The modem has a SIM. The modem was enabled when your vehicle was built and periodically sends messages to stay connected to the cell phone network, receive automatic software updates and send vehicle-related information to us, for example diagnostic information. These messages could include information that identifies your vehicle, the SIM and the electronic serial number of the modem. Cell phone network service providers could have access to additional information, for example, cell phone network tower identification. For additional information about our privacy policy, visit [www.FordConnected.com](http://www.FordConnected.com) or refer to your local Ford website.

**Note:** *The modem continues to send this information unless you disable the modem or stop the modem from sharing vehicle data by changing the modem settings. See **Connected Vehicle** (page 352).*

**Note:** *The service can be unavailable or interrupted for a number of reasons, for example, environmental or topographical conditions and data plan coverage.*

**Note:** *To find out if your vehicle has a modem, visit [www.FordConnected.com](http://www.FordConnected.com).*

# Data Privacy

---

## MOBILE DEVICE DATA

If you connect a mobile device to your vehicle, you can display data from your device on the touchscreen for example, music and album art. You can share your vehicle data with mobile apps on your device through the system. See **App Requirements** (page 379).

The mobile apps function operates by your connected device sending data to us in the United States. The data is encrypted and includes, for example, the vehicle identification number of your vehicle, the SYNC module serial number, odometer, enabled apps, usage statistics and debugging information. We retain it only as long as necessary to provide the service, to troubleshoot, for continuous improvement and to offer you products and services that may be of interest to you according to your preferences and where allowed by law.

If you connect a cell phone to the system, the system creates a profile that links to that cell phone. The cell phone profile enables more mobile features and efficient operation. The profile contains, for example data from your phonebook, read and unread text messages and call history, including history of calls when your cell phone was not connected to the system.

If you connect a media device, the system creates and retains a media device index of supported media content. The system also records a short diagnostic log of approximately 10 minutes of all recent system activity.

The cell phone profile, media device index and diagnostic log remain in your vehicle unless you delete them and are generally accessible only in your vehicle when you connect your cell phone or media device. If you no longer plan to use the system or your vehicle, we recommend you use the master reset function to erase the stored information. See **Performing a Master Reset** (page 388).

System data cannot be accessed without special equipment and access to your vehicle's module.

For additional information about our privacy policy, refer to the local Ford website.

**Note:** *To find out if your vehicle has connectivity technology, visit [www.FordConnected.com](http://www.FordConnected.com).*

## EMERGENCY CALL SYSTEM DATA

When the emergency call system is active, it may disclose to emergency services that your vehicle has been in a crash involving the deployment of an airbag or activation of the battery shut-off. Certain versions or updates to the emergency call system may also be capable of electronically or verbally disclosing to emergency services operators your vehicle location or other details about your vehicle or crash to assist emergency services operators to provide the most appropriate emergency services. If you do not want to disclose this information, do not activate the emergency call system.

**Note:** *You cannot deactivate emergency call systems that are required by law.*

# Visual Search

## STEERING WHEEL



- A See **Switching Adaptive Cruise Control On and Off** (page 223).
- B See **Setting the Adaptive Cruise Control Speed** (page 224).
- C See **Setting the Adaptive Cruise Control Gap** (page 225).
- D See **What is Voice Interaction** (page 371).
- E See **Adjusting the Volume** (page 358).
- F See **Selecting a Radio Station** (page 360).
- G See **Making and Receiving a Phone Call** (page 375).
- H See **Switching Lane Centering On and Off** (page 230).

# Visual Search

## INSTRUMENT PANEL

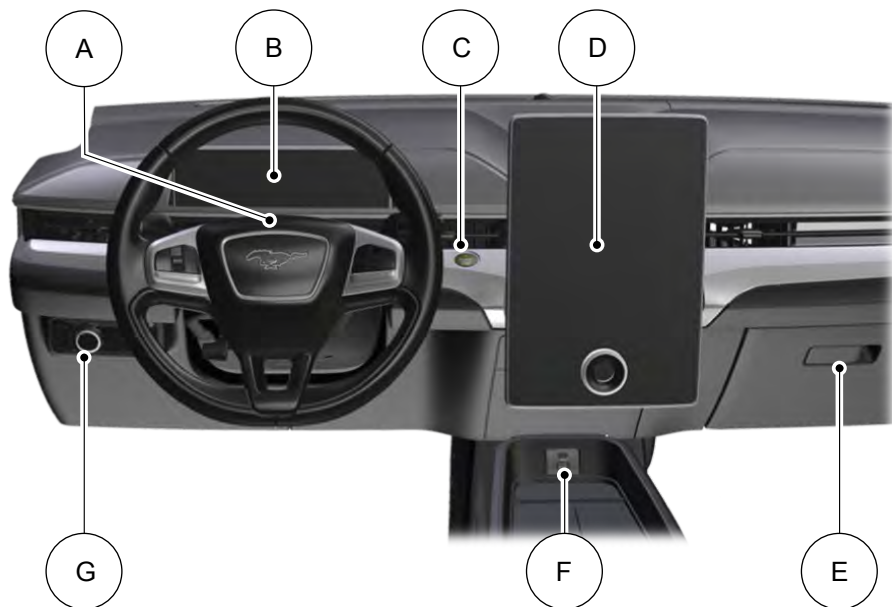

- A See **How Does BlueCruise Work** (page 235).
- B See **Instrument Cluster Overview** (page 119).
- C See **Starting the Vehicle** (page 155).
- D See **Status Bar** (page 368).
- E See **Opening the Glove Compartment** (page 154).
- F See **Locating the USB Ports** (page 150).
- G See **Exterior Lighting Control** (page 106).

# Visual Search

## INSTRUMENT PANEL - GT

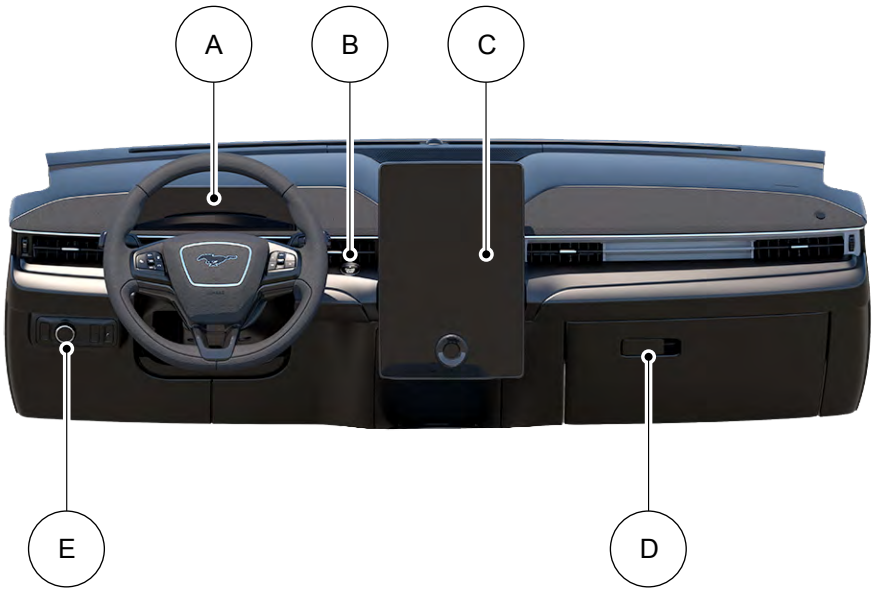

- A See **Instrument Cluster Overview** (page 119).
- B See **Starting the Vehicle** (page 155).
- C See **Status Bar** (page 368).
- D See **Opening the Glove Compartment** (page 154).
- E See **Exterior Lighting Control** (page 106).

# Visual Search

---

## VEHICLE INTERIOR

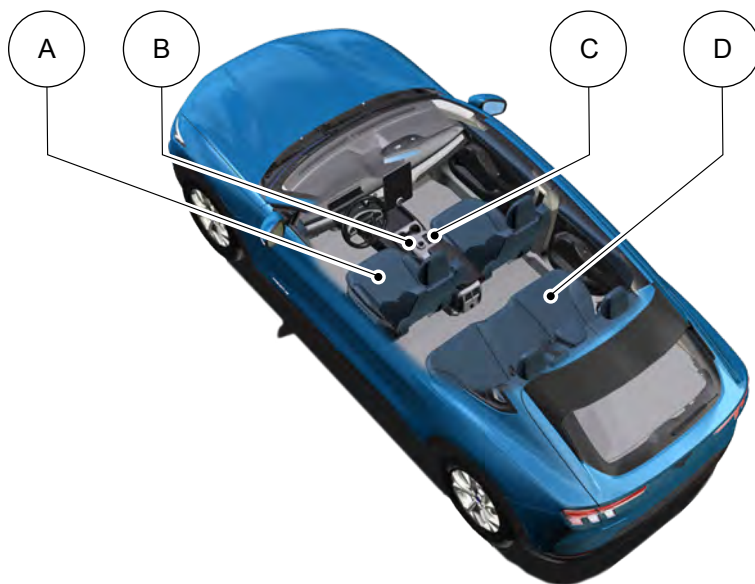

- A See **Sitting in the Correct Position** (page 134).
- B See **Shifting Your Vehicle Into Gear** (page 183).
- C See **Applying the Electric Parking Brake** (page 189).
- D See **Folding the Seat Backrest** (page 142).



# Visual Search

## VEHICLE INTERIOR - GT

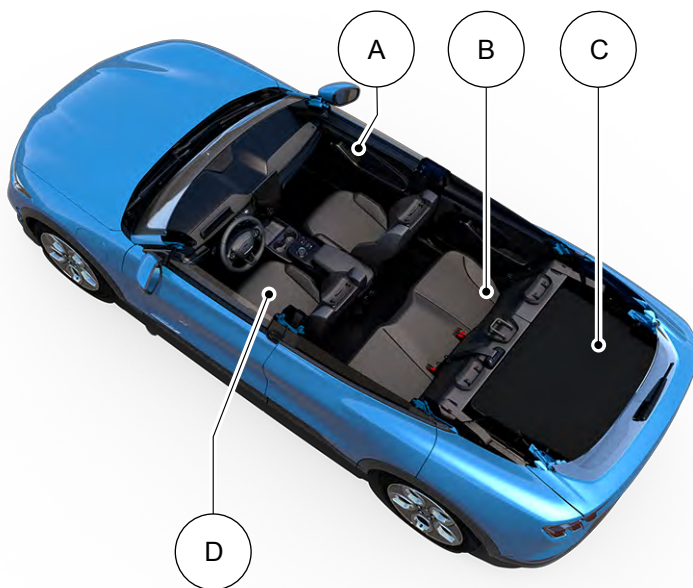

- A See **Opening and Closing the Windows** (page 114).
- B See **Folding the Seat Backrest** (page 142).
- C See **Installing and Removing the Luggage Compartment Cover** (page 278).
- D See **Sitting in the Correct Position** (page 134).

# Visual Search

## FRONT EXTERIOR

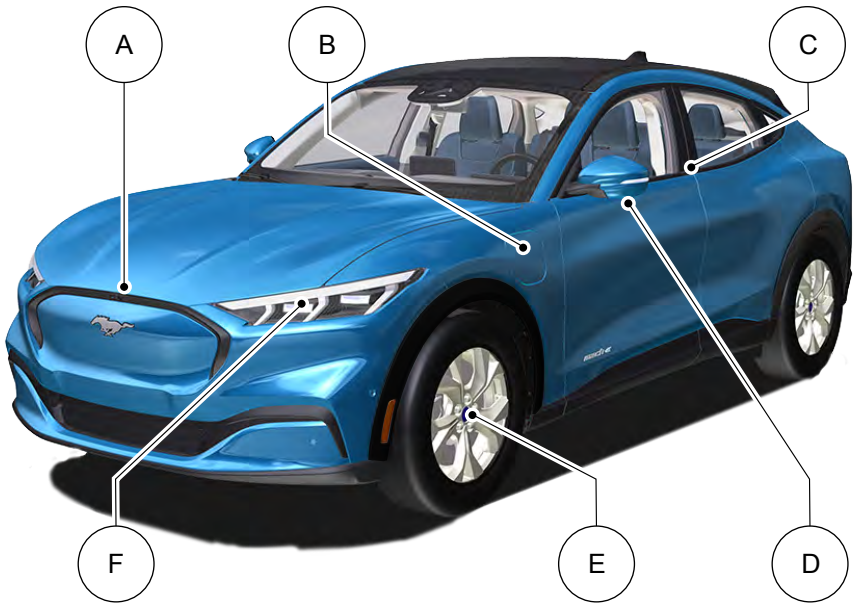

- A See **Opening and Closing the Front Luggage Compartment** (page 276).
- B See **Locating the Charge Port** (page 168).
- C See **Locating the Keyless Entry Keypad** (page 82).
- D See **Folding the Exterior Mirrors** (page 117).
- E See **What Is the Tire Pressure Monitoring System** (page 341).
- F See **Exterior Lighting Control** (page 106).

# Visual Search

## FRONT EXTERIOR - GT

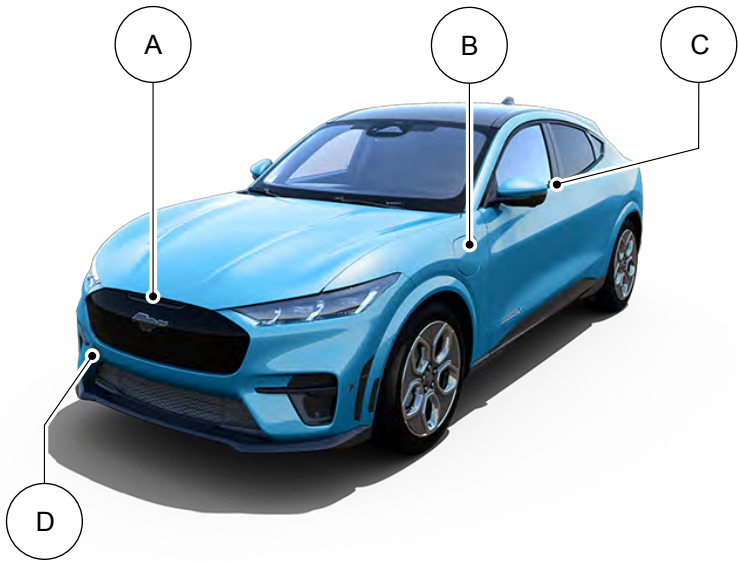

- A See **Opening and Closing the Front Luggage Compartment** (page 276).
- B See **Locating the Charge Port** (page 168).
- C See **Locating the Keyless Entry Keypad** (page 82).
- D See **Preparing the Vehicle** (page 287).

# Visual Search

## REAR EXTERIOR

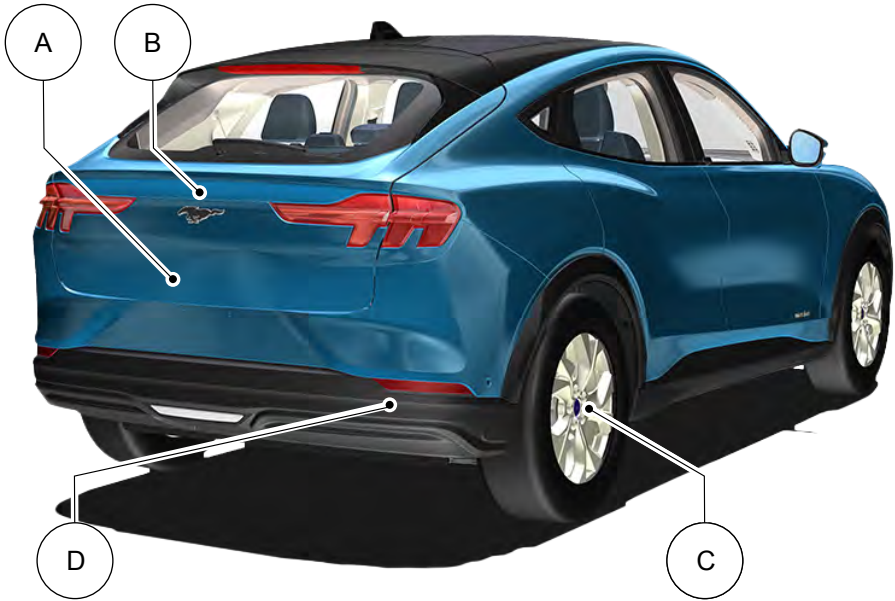

- A See **Opening the Liftgate From Outside Your Vehicle** (page 87).
- B See **Locating the Rear View Camera** (page 211).
- C See **What Is the Tire Pressure Monitoring System** (page 341).
- D See **Locating the Rear Parking Aid Sensors** (page 207).

# Visual Search

## REAR EXTERIOR - GT

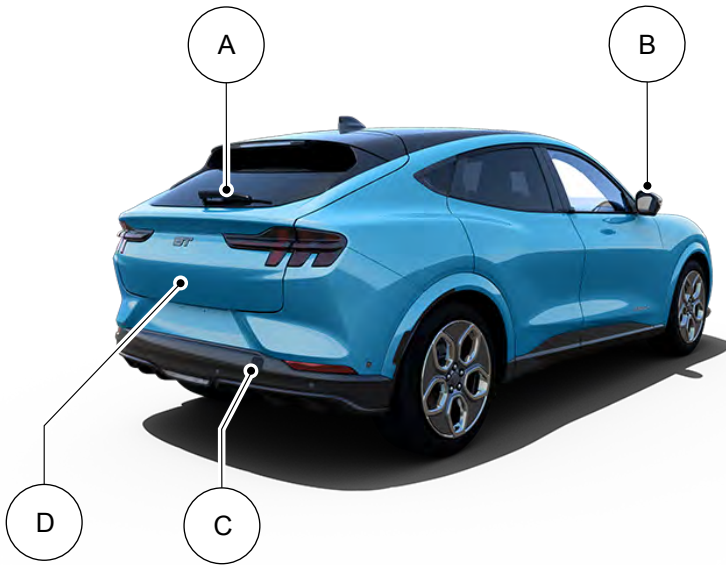

- A See **Switching the Rear Window Wiper On and Off** (page 102).
- B See **Folding the Exterior Mirrors** (page 117). See **Folding the Exterior Mirrors** (page 118).
- C See **Locating the Rear Parking Aid Sensors** (page 207).
- D See **Opening the Liftgate From Outside Your Vehicle** (page 87).

# Child Safety

## CHILD SAFETY PRECAUTIONS



**WARNING:** Always make sure your child is secured properly in a device that is appropriate for their height, age and weight. Child safety restraints must be bought separately from your vehicle. Failure to follow these instructions and guidelines may result in an increased risk of serious injury or death to your child.



**WARNING:** All children are shaped differently. The National Highway Traffic Safety Administration and other safety organizations, base their recommendations for child restraints on probable child height, age and weight thresholds, or on the minimum requirements of the law. We recommend that you check with a NHTSA Certified Child Passenger Safety Technician (CPST) to make sure that you properly install the child restraint in your vehicle and that you consult your pediatrician to make sure you have a child restraint appropriate for your child. To locate a child restraint fitting station and CPST, contact NHTSA toll free at 1-888-327-4236 or go to [www.nhtsa.dot.gov](http://www.nhtsa.dot.gov). In Canada, contact Transport Canada toll free at 1-800-333-0371 or go to [www.tc.gc.ca](http://www.tc.gc.ca) to find a Child Car Seat Clinic in your area. Failure to properly restrain children in child restraints made especially for their height, age and weight, may result in an increased risk of serious injury or death to your child.



**WARNING:** On hot days, the temperature inside the vehicle can rise very quickly. Exposure of people or animals to these high temperatures for even a short time can cause death or serious heat related injuries, including brain damage. Small children are particularly at risk.



**WARNING:** Do not place a rearward facing child restraint in front of an active airbag. Failure to follow this instruction could result in personal injury or death.



**WARNING:** Properly secure children 12 years old and under in a rear seating position whenever possible. If you are unable to properly secure all children in a rear seating position, properly secure the largest child on the front seat. If you must use a forward facing child restraint on the front seat, move the seat as far back as possible. Failure to follow these instructions could result in personal injury or death.



**WARNING:** Always carefully follow the instructions and warnings provided by the manufacturer of any child restraint to determine if the restraint device is appropriate for your child's size, height, weight, or age. Follow the child restraint manufacturer's instructions and warnings provided for installation and use in conjunction with the instructions and warnings provided by your vehicle manufacturer. A safety seat that is improperly installed or utilized, is inappropriate for your child's height, age, or weight or does not properly fit the child may increase the risk of serious injury or death.

# Child Safety

**WARNING:** Do not allow a passenger to hold a child on their lap when your vehicle is moving. Failure to follow this instruction could result in personal injury or death in the event of a sudden stop or crash.

**WARNING:** Do not use pillows, books or towels to boost your child's height. Failure to follow this instruction could result in personal injury or death.

**WARNING:** Properly secure child restraints or booster seats when they are not in use. They could become projectiles in a sudden stop or crash. Failure to follow this instruction could result in personal injury or death.

**WARNING:** Do not put the shoulder section of the seatbelt or allow the child to put the shoulder section of the seatbelt under their arm or behind their back. Failure to follow this instruction could reduce the effectiveness of the seatbelt and increase the risk of injury or death in a crash.

**WARNING:** Do not leave children or pets unattended in your vehicle. Failure to follow this instruction could result in personal injury or death.

When installing a child restraint with seatbelts:

- Place the vehicle seat in the upright position before you install the child restraint.
- Use the correct seatbelt buckle for that seating position.
- Insert the belt tongue into the buckle. Make sure the tongue is securely fastened in the buckle.

- Keep the buckle release button pointing up and away from the child restraint, with the tongue between the child restraint and the release button, to prevent accidental unbuckling.
- Put the seatbelt in the automatic locking mode.

## CHILD RESTRAINT ANCHOR POINTS

### WHAT ARE THE CHILD RESTRAINT ANCHOR POINTS

Anchor points allow you to quickly and safely install a child restraint.

### LOCATING THE CHILD RESTRAINT LOWER ANCHOR POINTS



# Child Safety

## LOCATING THE CHILD RESTRAINT TOP TETHER ANCHOR POINTS



## CHILD RESTRAINTS

### CHILD RESTRAINT POSITION INFORMATION

Install the child restraint tightly against the vehicle seat. It may be necessary to lift or remove the head restraint.

### Rear Facing Child Restraints

Combined Weight of Child and Child Restraint	LATCH (Lower Anchors Only)	Seatbelt Only
Up to 65 lb (29 kg)	<b>X</b>	<b>X</b>
Over 65 lb (29 kg)		<b>X</b>

### Forward Facing Child Restraints

Combined Weight of Child and Child Restraint	LATCH (Lower Anchors and Top Tether Anchor)	Seatbelt and Top Tether Anchor	Seatbelt and LATCH (Lower Anchors and Top Tether Anchor)
Up to 65 lb (29 kg)	<b>X</b>	<b>X</b>	<b>X</b>
Over 65 lb (29 kg)		<b>X</b>	<b>X</b>



# Child Safety

## CHILD RESTRAINTS RECOMMENDATION

Child Size, Height, Weight, or Age	Recommended Restraint Type
Children weighing 40 lb (18 kg) or less (generally age four or younger).	Use a child restraint (sometimes called an infant carrier, convertible seat, or toddler seat).
Children who have outgrown or no longer properly fit in a child restraint (generally children who are less than 57 in (1.45 m) tall, are greater than age four and less than age 12, and between 40 lb (18 kg) and 80 lb (36 kg) and upward to 100 lb (45 kg) if recommended by your child restraint manufacturer).	Use a belt-positioning booster seat.
Children who have outgrown or no longer properly fit in a belt-positioning booster seat (generally children who are at least 57 in (1.45 m) tall or greater than 80 lb (36 kg) or 100 lb (45 kg) if recommended by child restraint manufacturer).	Use a vehicle seatbelt having the lap belt snug and low across the hips, shoulder belt centered across the shoulder and chest, and seat backrest upright.

You are required by law to properly use child restraints for infants and toddlers in the United States, Canada and Mexico.

Many states and provinces require that small children use approved booster seats until they reach age eight, a height of 57 in (1.45 m) tall, or 80 lb (36 kg). Check your local and state or provincial laws for specific requirements about the safety of children in your vehicle.

When possible, properly restrain children 12 years of age and under in a rear seating position of your vehicle. Accident statistics suggest that children are safer when properly restrained in the rear seating positions than in a front seating position.

When installing a rear facing child restraint, adjust the vehicle seats to avoid interference between the child restraint and the vehicle seat in front of the child restraint.

## INSTALLING CHILD RESTRAINTS

### USING SEATBELTS

 **WARNING:** Depending on where you secure a child restraint, and depending on the child restraint design, you may block access to certain seatbelt buckle assemblies and LATCH lower anchors, rendering those features potentially unusable. To avoid risk of injury, make sure occupants only use seating positions where they are able to be properly restrained.

**Note:** *Although the child restraint illustrated is a forward facing child restraint, the steps are the same for installing a rear facing child restraint.*

Perform the following steps when installing a child restraint with seatbelts.

# Child Safety

1. Position the child restraint in a seat with a seatbelt.



2. Pull down on the shoulder belt and then grasp the shoulder belt and lap belt together.



3. While holding the shoulder and lap belt portions together, route the tongue through the child restraint according to the child restraint manufacturer's instructions. Make sure you did not twist the belt webbing.

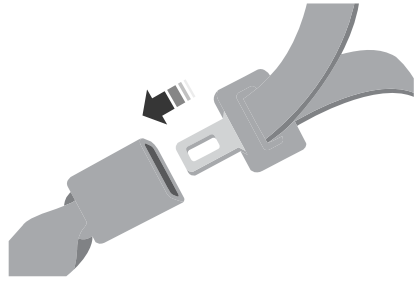

4. Insert the belt tongue into the proper buckle for that seating position until the latch engages. Make sure the tongue is latched securely by pulling on it.



5. To put the retractor in the automatic locking mode, grasp the shoulder portion of the belt and pull downward until you pull all of the seatbelt out.

**Note:** *The automatic locking mode is available on the front passenger and rear seats. This vehicle does not require the use of a locking clip.*

6. Allow the belt to retract to remove slack. The seatbelt clicks as it retracts to indicate it is in the automatic locking mode.

# Child Safety

- Pull the seatbelt out of the retractor to make sure the retractor is in the automatic locking mode. You should not be able to pull more belt out. If the retractor is not locked, unbuckle the belt and repeat Steps 5 and 6.



- Remove remaining slack from the belt. Force the seat down with extra weight, for example, by pressing down or kneeling on the child restraint while pulling up on the shoulder belt in order to force slack from the belt. This is necessary to remove the remaining slack that exists once you add the extra weight of the child to the child restraint. It also helps to achieve the proper snugness of the child restraint to your vehicle. Sometimes, a slight lean toward the buckle helps to remove remaining slack from the belt.
- If the child restraint has a tether strap, attach it.

- Before placing the child in the seat, forcibly move the seat forward and back to make sure the seat is securely held in place.

To check this, grab the seat at the belt path and attempt to move it side to side and forward and back. There should be no more than 1 in (2.5 cm) of movement.

We recommend checking with a NHTSA Certified Child Passenger Safety Technician to make certain the child restraint is properly installed. In Canada, check with Transport Canada for referral to a Child Car Seat Clinic.

## USING LOWER ANCHORS AND TETHERS FOR CHILDREN



**WARNING:** Do not attach two child safety restraints to the same anchor. In a crash, one anchor may not be strong enough to hold two child safety restraint attachments and may break, causing serious injury or death.

# Child Safety



**WARNING:** Depending on where you secure a child restraint, and depending on the child restraint design, you may block access to certain seatbelt buckle assemblies and LATCH lower anchors, rendering those features potentially unusable. To avoid risk of injury, make sure occupants only use seating positions where they are able to be properly restrained.

The Lower Anchors and Tethers for Children (LATCH) system has three vehicle anchor points:

- Two lower anchors where the vehicle seat backrest and seat cushion meet, called the seat bight.
- One top tether anchor behind that seating position.

LATCH compatible child restraints have two rigid or webbing mounted attachments. These attachments connect to the two lower anchors at the LATCH equipped seating positions in your vehicle. This type of attachment method eliminates the need to use seatbelts to attach the child restraint.

However, you can still use the seatbelt to attach the child restraint if the lower anchors are not used. For forward-facing child restraints, you must also attach the top tether strap to the proper top tether anchor if a top tether strap has been provided with your child restraint.

Follow the instructions later in this chapter on attaching child restraints with tether straps.

## INSTALLING A CHILD RESTRAINT IN A CENTER SEAT



**WARNING:** The standardized spacing for LATCH lower anchors is 11 in (280 mm) center to center. Do not use LATCH lower anchors for the center seating position unless the child restraint manufacturer's instructions permit and specify using anchors spaced at least as far apart as those in this vehicle.

The lower anchors at the center of the second row rear seat are spaced 20 in (51 cm) apart. You cannot install a child restraint with rigid LATCH attachments at the center seating position. You can only use LATCH compatible child restraints with attachments on belt webbing at this seating position provided that the child restraint manufacturer's instructions permit use with the anchor spacing stated. Do not attach a child restraint to any lower anchor if an adjacent child restraint is attached to that anchor.

Each time you use the child restraint, check that the seat is properly attached to the lower anchors and tether anchor, if applicable. Tug the child restraint from side to side and forward and back where it is secured to your vehicle. The seat should move less than 1 in (2.5 cm).

If you did not properly anchor the child restraint, the risk of a child being injured in a crash greatly increases.

# Child Safety

## COMBINING THE SEATBELT AND LOWER ANCHORS FOR ATTACHING CHILD RESTRAINTS

When used in combination, you may attach either the seatbelt or the LATCH lower anchors first, provided a proper installation is achieved. Attach the tether strap afterward, if it is included with the child restraint.

## USING TETHER STRAPS

Many forward-facing child restraints include a tether strap which extends from the back of the child restraint and hooks to an anchoring point called the top tether anchor. Tether straps are available as an accessory for many older child restraints.

Contact the manufacturer of your child restraint for information about ordering a tether strap, or to obtain a longer tether strap if the tether strap on your child restraint does not reach the appropriate top tether anchor in the vehicle.

Attach the tether strap only to the appropriate tether anchor. The tether strap may not work properly if attached somewhere other than the correct tether anchor.

If you install a child restraint with rigid LATCH attachments, do not tighten the tether strap enough to lift the child restraint off the vehicle seat cushion when the child is seated in it. Keep the tether strap just snug without lifting the front of the child restraint. Keeping the child restraint just touching the vehicle seat gives the best protection in a severe crash.

Once you have installed the child restraint using either the seatbelt, the lower anchors of the LATCH system, or both, you can attach the top tether strap.

1. Route the child restraint tether strap over the back of the seat. For the outermost seating positions, route the tether strap under the head restraint and between the head restraint posts. For the center seating position, route the tether strap over the top of the head restraint with the head restraint fully lowered. If needed, you can also remove the head restraints.

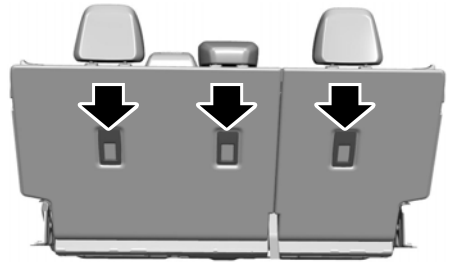

2. Locate the correct anchor on the back panel of the rear seat for the selected seating position. The anchors are labeled with the tether strap symbol.



3. Clip the tether strap to the anchor as shown.

# Child Safety

4. Tighten the child restraint tether strap according to the manufacturer's instructions. If your child restraint system has a tether strap, and the child restraint manufacturer recommends its use, we also recommend its use.

## BOOSTER SEATS

Use a belt-positioning booster seat for children who have outgrown or no longer properly fit in a child restraint and meet the following criteria.

- Generally children who are less than 57 in (1.45 m) tall.
- Are greater than age four (4) and less than age twelve (12).
- Are between 40 lb (18 kg) and 80 lb (36 kg) and upward to 100 lb (45 kg).

Many state and provincial laws require that children use approved booster seats until they reach age eight, a height of 57 in (1.45 m) tall, or 80 lb (36 kg).

Booster seats should be used until you can answer yes to all of these questions when seated without a booster seat:

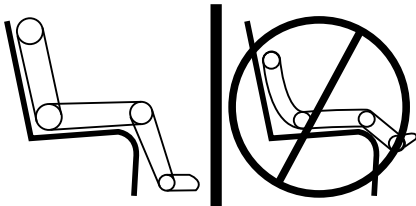

- Can the child sit all the way back against their vehicle seat backrest with knees bent comfortably at the edge of the seat cushion?
- Can the child sit without slouching?

- Does the lap belt rest low across the hips?
- Is the shoulder belt centered on the shoulder and chest?
- Can the child stay seated like this for the whole trip?

Always use booster seats in conjunction with your vehicle lap and shoulder belt.

## Types of Booster Seats



- Backless booster seats

If your backless booster seat has a removable shield, remove the shield.

If a vehicle seating position has a low seat backrest or no head restraint, a backless booster seat may place your child's head, as measured at the tops of the ears, above the top of the seat. In this case, move the backless booster to another seating position with a higher seat backrest or head restraint and lap and shoulder belts, or consider using a high-back booster seat.

# Child Safety



- High-back booster seats

If, with a backless booster seat, you cannot find a seating position that adequately supports your child's head, a high-back booster seat would be a better choice.

Children and booster seats vary in size and shape. Choose a booster that keeps the lap belt low and snug across the hips, never up across the stomach, and lets you adjust the shoulder belt to cross the chest and rest snugly near the center of the shoulder.

The following drawings compare the ideal fit to a shoulder belt uncomfortably close to the neck and a shoulder belt that could slip off the shoulder. The drawings also show how the lap belt should be low and snug across the child's hips.



# Child Safety

---

If the booster seat slides on the vehicle seat upon which it is being used, placing a rubberized mesh sold as shelf or carpet liner under the booster seat may improve this condition. Do not use any item thicker than this under the booster seat. Check with the booster seat manufacturer's instructions.

## CHILD SAFETY LOCKS

When you set the child safety locks, you cannot open the rear doors from the inside.



The control is on the driver door. It enables both the child safety locks and the rear window locks.

Press the control to switch the child safety locks and the rear window lock on. Press the control again to switch them off. A light on the control illuminates when you switch them on.

The child lock and rear window lock settings remain active when you switch your vehicle off.



# Seatbelts

## SEATBELT PRECAUTIONS



**WARNING:** Always drive and ride with your seatback upright and the lap belt snug and low across the hips.



**WARNING:** Children must always be properly restrained.



**WARNING:** Do not allow a passenger to hold a child on their lap when your vehicle is moving. Failure to follow this instruction could result in personal injury or death in the event of a sudden stop or crash.



**WARNING:** All occupants of your vehicle, including the driver, should always properly wear their seatbelts, even when an airbag supplemental restraint system is provided. Failure to properly wear your seatbelt could seriously increase the risk of injury or death.



**WARNING:** It is extremely dangerous to ride in a cargo area, inside or outside of a vehicle. In a crash, people riding in these areas are more likely to be seriously injured or killed. Do not allow people to ride in any area of your vehicle that is not equipped with seats and seatbelts. Make sure everyone in your vehicle is in a seat and properly using a seatbelt. Failure to follow this warning could result in serious personal injury or death.



**WARNING:** In a rollover crash, an unbelted person is significantly more likely to die than a person wearing a seatbelt.



**WARNING:** Each seating position in your vehicle has a specific seatbelt assembly made up of one buckle and one tongue designed to be used as a pair. Use the shoulder belt on the outside shoulder only. Never wear the shoulder belt under the arm. Never use a single seatbelt for more than one person.



**WARNING:** Even with advanced restraints systems, properly restrain children 12 and under in a rear seating position. Failure to follow this could seriously increase the risk of injury or death.



**WARNING:** Seatbelts and seats may be hot in a vehicle that is in the sunshine. The hot seatbelts or seats may burn a small child. Check seat covers and buckles before you place a child anywhere near them.



**WARNING:** If your vehicle is involved in a crash, have the seatbelts and associated components inspected as soon as possible. Failure to follow this instruction could result in personal injury or death.

All seating positions in this vehicle have lap and shoulder seatbelts. All occupants of the vehicle should properly wear their seatbelts, even when an airbag supplemental restraint system is provided.

The seatbelt system consists of:

- Lap and shoulder seatbelts.
- A shoulder seatbelt with automatic locking mode, except driver seatbelt.
- Height adjusters at the front outermost seating positions.
- Seatbelt pretensioners at the front outermost seating positions.

# Seatbelts



A seatbelt warning light and chime.



Crash sensors and monitoring system with readiness indicator.

The seatbelt pretensioners are designed to tighten the seatbelts when activated. In frontal and near-frontal crashes, the seatbelt pretensioners may be activated alone or, if the crash is of sufficient severity, together with the front airbags. In side crashes and rollovers, the pretensioners will be activated when the Safety Canopy is activated.

## FASTENING AND UNFASTENING THE SEATBELTS

All seatbelts in your vehicle are a three-point combination lap and shoulder seatbelt.

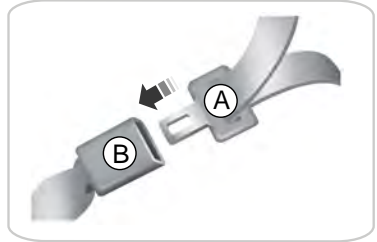

- A Seatbelt tongue.
- B Seatbelt buckle.

1. Pull the seatbelt out steadily.

**Note:** *It may lock if you pull it sharply or if the vehicle is on a slope.*

2. Insert the tongue into the buckle.
3. Pull the seatbelt tight to remove any slack.

### Unfastening the Seatbelts

1. Press the red button on the buckle to release the seatbelt.
2. Hold the seatbelt tongue and let it retract completely and smoothly to its stowed position.

# Seatbelts

## SENSITIVE LOCKING MODE

### WHAT IS SENSITIVE LOCKING MODE

Sensitive locking mode is a seatbelt retractor feature that allows shoulder belt length adjustment according to your movements and locking in response to vehicle movement.

### HOW DOES SENSITIVE LOCKING MODE WORK

If the driver suddenly brakes, turns a corner sharply, or the vehicle receives an impact of about 5 mph (8 km/h) or more, the seatbelts lock to help reduce forward movement of the driver and passengers.

In addition, the seatbelt retractor locks if you pull the seatbelt webbing out too quickly. If the retractor locks, slowly lower the height adjuster to allow the seatbelt to retract.

If the retractor does not unlock, pull the seatbelt out slowly then feed a small length of webbing back toward the stowed position.

## AUTOMATIC LOCKING MODE

### WHAT IS AUTOMATIC LOCKING MODE

This is a safety feature built into the seatbelt retractors that keeps the seatbelts pre-locked.

## WHEN TO USE AUTOMATIC LOCKING MODE

Use this mode any time you install a child restraint in a front outermost passenger seating position or any rear seating position. Properly restrain children 12 years old and under in a rear seat whenever possible.

**Note:** *Automatic locking mode is not available on the driver seatbelt.*

## ENGAGING AUTOMATIC LOCKING MODE



1. Fasten the combination lap and shoulder belt.
2. Grasp the shoulder portion and pull downward until you pull the entire belt out.
3. Allow the belt to retract. As the belt retracts, you will hear a clicking sound. This indicates the seatbelt is now in the automatic locking mode.

## DISENGAGING AUTOMATIC LOCKING MODE

Unbuckle the combination lap and shoulder belt and allow it to retract completely to disengage the automatic locking mode and activate the vehicle sensitive locking mode.

# Seatbelts

## ADJUSTING THE SEATBELTS DURING PREGNANCY



**WARNING:** Always ride and drive with your seatback upright and properly fasten your seatbelt. Fit the lap portion of the seatbelt snugly and low across the hips. Position the shoulder portion of the seatbelt across your chest. Pregnant women must follow this practice. See the following figure.

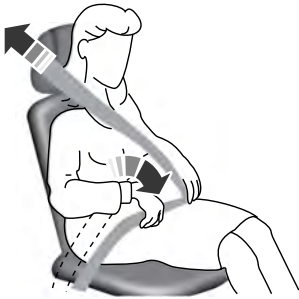

Pregnant women should always wear their seatbelt. Position the lap belt portion of a combination lap and shoulder belt low across the hips below the belly and worn as tight as comfort allows. Position the shoulder belt to cross the middle of the shoulder and the center of the chest.

## ADJUSTING THE SEATBELT HEIGHT



**WARNING:** Position the seatbelt height adjuster so that the seatbelt rests across the middle of your shoulder. Failure to adjust the seatbelt correctly could reduce its effectiveness and increase the risk of injury in a crash.

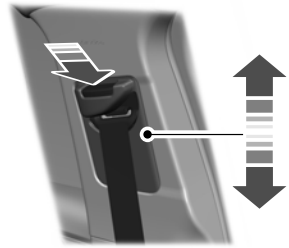

1. Press the button and slide the height adjuster up or down.
2. Release the button and pull down on the height adjuster to make sure it is locked in place.

## SEATBELT REMINDER

### HOW DOES THE SEATBELT REMINDER WORK



**WARNING:** The system will only provide protection when you use the seatbelt correctly.

This system monitors all seating positions and provides audio and graphic feedback.

### SEATBELT REMINDER INDICATORS



This lamp illuminates if you do not fasten your seatbelt when you switch the power on. The lamp switches off when you fasten your seatbelt or about one minute has elapsed.

# Seatbelts

When the initial warning expires for the driver, more warnings are provided for the driver and front passenger. This lamp illuminates if you or your front passenger do not fasten the seatbelt buckle and the vehicle speed exceeds 6 mph (9.7 km/h).

**Note:** To avoid inadvertent warnings, do not place large objects on the front passenger seat.



This lamp illuminates when you switch the power on, identifying the number of seating positions with fastened buckles. It illuminates again when a seating position changes from unfastened to fastened.

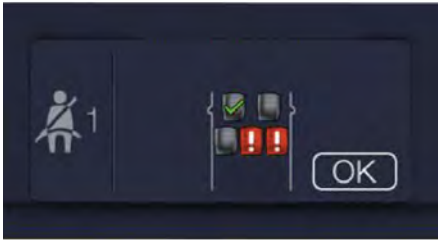

This warning displays if an occupant unfastens the rear seatbelt buckle or it becomes unfastened.

**Note:** If a rear seat is unoccupied, or an occupant never fastens the seatbelt buckle to begin with, the warning will not display.

**Note:** Front seating positions appear in this warning display. Warnings for unfastened front seatbelt buckles appear in the initial warning lamp.

## Seatbelt Status

To view the seatbelt status, use the touchscreen.



A



C



B



D

- A Seatbelt fastened.
- B Seatbelt not fastened.
- C Seatbelt recently unfastened.
- D Fault.

## SEATBELT REMINDER AUDIBLE WARNINGS

A warning tone sounds if you do not fasten your seatbelt when you switch the power on. The tone switches off when you fasten your seatbelt or about one minute elapses.

When the initial warning expires for the driver and front passenger. This warning tone sounds if you or your front passenger do not fasten the seatbelt buckle and the vehicle speed exceeds 6 mph (9.7 km/h).

This tone also sounds if an occupant unfastens the rear seatbelt buckle or it becomes unfastened.

# Seatbelts

## SWITCHING THE SEATBELT REMINDER ON AND OFF



**WARNING:** While the system allows you to deactivate it, this system is designed to improve your chances of being safely belted and surviving an accident. We recommend you leave the system activated for yourself and others who may use the vehicle.

**Note:** *The driver and front passenger warnings switch off independently. When you perform this procedure for one seating position, do not buckle the other position as this cancels the process.*

**Note:** *If you are using MyKey, you cannot disable the seatbelt reminder. Also, if the seatbelt reminder has been previously disabled, it will be re-enabled during the use of MyKey. See **MyKey™** (page 72).*

Read Steps 1 - 4 before proceeding with the programming procedure.

Make sure that:

- The parking brake is set.
  - The transmission is in park (P).
  - The power is off.
  - You close all vehicle doors.
  - The driver and front passenger seatbelts are unfastened.
1. Switch the power on. Do not start the vehicle.
  2. Wait about one minute until the seatbelt warning light switches off. After Step 2, wait an additional five seconds before proceeding with Step 3. Once you start Step 3, you must complete the procedure within 30 seconds.

3. For the seating position you are switching off, buckle then unbuckle the seatbelt three times at a moderate speed, ending in the unbuckled state. After Step 3, the seatbelt warning light switches on.
4. When the seatbelt warning light is on, buckle then unbuckle the seatbelt. After Step 4, the seatbelt warning light flashes for confirmation.

This switches the feature off for that seating position if it is currently on.

This switches the feature on for that seating position if it is currently off.

## CHECKING THE SEATBELTS

Check the seatbelts and child restraints periodically to make sure they work properly and are not damaged. Make sure there are no nicks, tears or cuts. Replace if necessary.

Check all of the following seatbelt assemblies after a crash.

- Retractors.
- Buckles.
- Front seatbelt buckle assemblies.
- Shoulder belt height adjusters.
- Shoulder belt guide on seat backrest.
- Child restraint LATCH and tether anchors.
- Attaching hardware.

Read the child restraint manufacturer's instructions for additional inspection and maintenance information specific to the child restraint.

# Seatbelts

We recommend that all seatbelt assemblies in use in vehicles involved in a crash be replaced. However, if the crash was minor and an authorized dealer finds that the belts do not show damage and continue to operate properly, they do not need to be replaced. Seatbelt assemblies not in use during a crash should also be checked and replaced if either damage or improper operation is noted.

Properly care for seatbelts. See **Vehicle Care** (page 311).

If, because of body size or driving position, it is not possible to properly fasten the seatbelt over your lap and shoulder, an extension that is compatible with the seatbelts is available free of charge from our dealers. Only use our seatbelt extensions made by the original equipment seatbelt manufacturer with our seatbelts. Ask your authorized dealer if your extension is compatible with your vehicle restraint system.

## SEATBELT EXTENSIONS



**WARNING:** Persons who fit into the vehicle's seatbelt should not use an extension. Unnecessary use could result in serious personal injury in the event of a crash.



**WARNING:** Only use extensions provided free of charge by our dealers. The dealer will provide an extension designed specifically for this vehicle, model year and seating position. The use of an extension intended for another vehicle, model year or seating position may not offer you the full protection of your vehicle's seatbelt restraint system.



**WARNING:** Never use seatbelt extensions to install child restraints.



**WARNING:** Do not use extensions to change the way the seatbelt fits across the torso, over the lap or to make the seatbelt buckle easier to reach.

# Personal Safety System™

---

## WHAT IS THE PERSONAL SAFETY SYSTEM

An advanced safety system that protects occupants in frontal crashes.

## HOW DOES THE PERSONAL SAFETY SYSTEM WORK

This system provides an improved level of frontal crash protection to front seat occupants and is designed to reduce the risk of airbag-related injuries. The system analyzes occupant conditions and crash severity before activating the appropriate safety devices. During a crash, the restraints control module may deploy the seatbelt pretensioners, and one or both stages of the dual-stage airbags based on crash severity and occupant conditions.

## PERSONAL SAFETY SYSTEM COMPONENTS

- Driver and passenger dual-stage airbag supplemental restraints.
- Front seat outermost seatbelts with pretensioners, energy management retractors and seatbelt usage sensors.
- Front passenger sensing system.
- Passenger airbag off and on indicators.
- Front crash severity sensors.
- Restraints control module with impact and safing sensors.
- Restraint system warning light and tone.
- The electrical wiring for the airbags, crash sensors, seatbelt pretensioners, front seatbelt usage sensors, front passenger sensing system and indicator lights.



# Airbags

## HOW DO THE FRONT AIRBAGS WORK

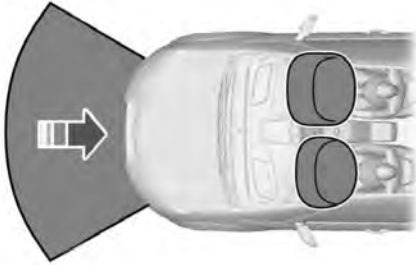

The driver and front passenger airbags deploy during significant frontal and near frontal crashes.

The driver and passenger front airbag system consists of:

- Driver and passenger airbag modules.
- Front passenger sensing system.
- Crash sensors and monitoring system with readiness indicator. See **Crash Sensors and Airbag Indicator** (page 60).

The airbags are a supplemental restraint system and are designed to work with the seatbelts to help protect the driver and right front passenger from certain upper body injuries. Airbags do not inflate slowly; there is a risk of injury from a deploying airbag.

**Note:** *You will hear a loud bang and see a cloud of harmless powdery residue if an airbag deploys. This is normal.*

The airbags inflate and deflate rapidly upon activation. After airbag deployment, it is normal to notice a smoke-like, powdery residue or smell the burnt propellant. This may consist of cornstarch, talcum powder (to lubricate the bag) or sodium

compounds (for example, baking soda) that result from the combustion process that inflates the airbag. Small amounts of sodium hydroxide may be present which may irritate the skin and eyes, but none of the residue is toxic.

Contact with a deploying airbag may cause abrasions or swelling. Temporary hearing loss is also a possibility as a result of the noise associated with a deploying airbag.

Because airbags must inflate rapidly and with considerable force, there is the risk of death or serious injuries such as fractures, facial and eye injuries or internal injuries, particularly to occupants who are not properly restrained or are otherwise out of position at the time of airbag deployment. Thus, it is extremely important that occupants be properly restrained as far away from the airbag module as possible while maintaining vehicle control.

Routine maintenance of the airbags is not required.

## HOW DO THE SIDE AIRBAGS WORK



**WARNING:** Do not place objects or mount equipment on or near the airbag cover, on the side of the front or rear seatbacks, or in areas that may come into contact with a deploying airbag. Failure to follow these instructions may increase the risk of personal injury in the event of a crash.



**WARNING:** Accessory seat covers not released by Ford could prevent the deployment of the airbags and increase the risk of injuries in a crash.

# Airbags



**WARNING:** Do not lean your head on the door. The side airbag could injure you as it deploys from the side of the seatback.

The side airbags are on the outermost side of each front and rear seat backrest. In certain sideways crashes or rollovers, the airbags will be inflated. The airbag was designed to inflate between the door panel and occupant to further enhance the protection provided occupants in side impact crashes.



Properly restrain children 12 years old and under in the rear seats. The rear side airbag will not interfere with children restrained using a properly installed child or booster seat.

The system consists of the following:

- A label or embossed side panel indicating that side airbags are fitted to your vehicle.
- Side airbags inside the driver and front passenger seat backrests, as well as side airbags inside of each outermost rear seat backrest.
- Crash sensors and monitoring system with readiness indicator. See **Crash Sensors and Airbag Indicator** (page 60).

## HOW DO THE KNEE AIRBAGS WORK

The driver knee airbag is under or within the instrument panel. During a crash, the restraints control module may activate the knee airbag based on crash severity and respective occupant conditions. Under certain crash and occupant conditions, the knee airbag may deploy but the corresponding front airbag may not activate. It is important to be properly seated and restrained to reduce the risk of death or serious injury.



Make sure the knee airbag is operating properly. See **Crash Sensors and Airbag Indicator** (page 60).

## HOW DOES THE SAFETY CANOPY™ WORK



**WARNING:** Do not place objects or mount equipment on or near the headliner at the siderail that may come into contact with a deploying curtain airbag. Failure to follow these instructions may increase the risk of personal injury in the event of a crash.



**WARNING:** Do not lean your head on the door. The curtain airbag could injure you as it deploys from the headliner.



**WARNING:** All occupants of your vehicle, including the driver, should always properly wear their seatbelts, even when an airbag supplemental restraint system is provided. Failure to properly wear your seatbelt could seriously increase the risk of injury or death.

# Airbags

The Safety Canopy deploys during significant side crashes or when a certain likelihood of a rollover event is detected by the rollover sensor. The Safety Canopy is mounted to the roof side rail sheet metal, behind the headliner, above each row of seats.

In certain sideways crashes or rollover events, the Safety Canopy will be activated, regardless of which seats are occupied. The Safety Canopy is designed to inflate between the side window area and occupants to further enhance protection provided in side impact crashes and rollover events.

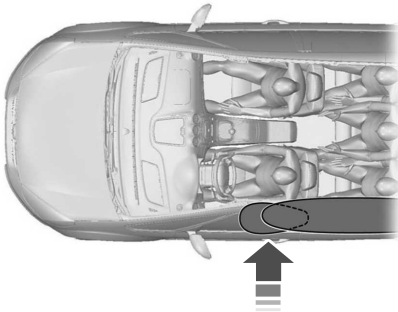

The system consists of the following:

- Safety Canopy curtain airbags above the trim panels over the front and rear side windows identified by a label or wording on the headliner or roof-pillar trim.
- A flexible headliner which opens above the side doors to allow air curtain deployment
- Crash sensors and monitoring system with a readiness indicator. See **Crash Sensors and Airbag Indicator** (page 60).

Properly restrain children 12 years old and under in the rear seats. The Safety Canopy airbags will not interfere with children restrained using a properly installed child or booster seat because it is designed to inflate downward from the headliner above the doors along the side window opening.

## AIRBAG PRECAUTIONS

**WARNING:** Airbags do not inflate slowly or gently, and the risk of injury from a deploying airbag is the greatest close to the trim covering the airbag module.

**WARNING:** All occupants of your vehicle, including the driver, should always properly wear their seatbelts, even when an airbag supplemental restraint system is provided. Failure to properly wear your seatbelt could seriously increase the risk of injury or death.

**WARNING:** Properly secure children 12 years old and under in a rear seating position whenever possible. If you are unable to properly secure all children in a rear seating position, properly secure the largest child on the front seat. If you must use a forward facing child restraint on the front seat, move the seat as far back as possible. Failure to follow these instructions could result in personal injury or death.

**WARNING:** Do not place your arms on the airbag cover or through the steering wheel. Failure to follow this instruction could result in personal injury.

# Airbags

 **WARNING:** Keep the areas in front of the airbags free from obstruction. Do not affix anything to or over the airbag covers. Objects could become projectiles during airbag deployment. Failure to follow this instruction could result in personal injury or death.

 **WARNING:** To reduce risk of injury, do not obstruct or place objects in the deployment path of the airbag.

 **WARNING:** Do not place a rearward facing child restraint in front of an active airbag. Failure to follow this instruction could result in personal injury or death.

 **WARNING:** Do not attempt to service, repair, or modify the supplementary restraint system or associated components. Failure to follow this instruction could result in personal injury or death.

 **WARNING:** Several airbag system components get hot after inflation. To reduce the risk of injury, do not touch them after inflation.

 **WARNING:** If a supplementary restraint system component has deployed, it will not function again. Have the system and associated components inspected as soon as possible. Failure to follow this instruction could result in personal injury or death.

## PROPERLY ADJUSTING THE DRIVER AND FRONT PASSENGER SEATS

 **WARNING:** National Highway Traffic Safety Administration (NHTSA) recommends a minimum distance of at least 10 in (25 cm) between an occupant's chest and the driver airbag module.

To properly position yourself away from the airbag:

- Move your seat to the rear as far as you can while still reaching the pedals comfortably.
- Recline the seat slightly one or two degrees from the upright position.

After all occupants have adjusted their seats and put on seatbelts, it is very important that they continue to sit properly. Properly seated occupants sit upright, lean against the seat backrest, and center themselves on the seat cushion, with their feet comfortably extended on the floor. Sitting improperly can increase the chance of injury in a crash event. For example, if an occupant slouches, lies down, turns sideways, sits forward, leans forward or sideways, or puts one or both feet up, the chance of injury during a crash greatly increases.

## CHILDREN AND AIRBAGS

 **WARNING:** Do not place a rearward facing child restraint in front of an active airbag. Failure to follow this instruction could result in personal injury or death.

# Airbags



Children must always be properly restrained. Accident statistics suggest that children are safer when properly restrained in the rear seating positions than in the front seating position. Failure to follow these instructions may increase the risk of injury in a crash.

## FRONT PASSENGER SENSING SYSTEM

### WHAT IS THE FRONT PASSENGER SENSING SYSTEM

This system detects a properly seated occupant and determines if the front passenger airbag should be enabled.

### HOW DOES THE FRONT PASSENGER SENSING SYSTEM WORK

The system uses a passenger airbag status indicator which illuminates indicating that the front passenger frontal airbag is either enabled or disabled.

**Note:** *When you first switch the power on, the passenger airbag status indicator off and on lamps illuminate for a short period to confirm they are functional.*



The indicators are in the overhead console.

The front passenger sensing system is designed to disable the front passenger frontal airbag under these conditions:

- The front passenger seat is unoccupied.
- The system determines an infant is present in a child restraint.
- A passenger takes their weight off of the seat for a period of time.
- If there is a problem with the airbag system or the passenger sensing system.

Even with this technology, parents are strongly encouraged to always properly restrain children in the rear seat.

- When the front passenger sensing system disables the front passenger frontal airbag, the passenger airbag status indicator illuminates the off lamp.
- If you have installed the child restraint and the passenger airbag status indicator illuminates the on lamp, switch your vehicle off, remove the child restraint from your vehicle and reinstall the restraint following the child restraint manufacturer's instructions.

The front passenger sensing system works with sensors that are part of the front passenger seat and seatbelt. The sensors are designed to detect the presence of a properly seated occupant and determine if the front passenger frontal airbag should be enabled.

# Airbags

- When the front passenger sensing system enables the front passenger frontal airbag, the passenger airbag status indicator illuminates the on lamp.

If a person of adult size is sitting in the front passenger seat, but the passenger airbag status indicator off lamp is illuminated, it is possible that the person is not sitting properly in the seat. If this happens:

- Switch your vehicle off and ask the person to place the seat backrest in an upright position.
- Have the person sit upright in the seat, centered on the seat cushion, with the person's legs comfortably extended.
- Restart your vehicle and have the person remain in this position for about two minutes. This allows the system to detect that person and enable the passenger frontal airbag.
- If the indicator off lamp remains illuminated even after this, you should advise the person to ride in the rear seat.

After all occupants have adjusted their seats and put on seatbelts, it is very important that they continue to sit upright, leaning against the seat backrest, and centered on the seat cushion, with their feet comfortably extended on the floor.

Sitting improperly can increase the chance of injury in a crash event. For example, if an occupant slouches, lies down, turns sideways, sits forward, leans forward or sideways, or puts one or both feet up, the chance of injury during a crash greatly increases.

If you think that the state of the passenger airbag status indicator lamp is incorrect, check for the following:

- Objects lodged underneath the seat.
- Objects between the seat cushion and the center console.

- Objects hanging off the seat backrest.
- Objects stowed in the seat backrest map pocket.
- Objects placed on the occupant's lap.
- Cargo interference with the seat
- Other passengers pushing or pulling on the seat.
- Rear passenger feet and knees resting or pushing on the seat.

The listed conditions could cause the weight of a properly seated occupant to be incorrectly interpreted by the front passenger sensing system. The person in the front passenger seat could appear heavier or lighter due to the conditions listed.



Make sure the front passenger sensing system is operating properly. See **Crash Sensors and Airbag Indicator** (page 60).

If the airbag readiness light is on, do the following:

- Pull your vehicle over.
- Switch your vehicle off.
- Check for any objects lodged underneath the front passenger seat or cargo interfering with the seat.
- Remove the obstruction if found.
- Restart your vehicle.
- Wait at least two minutes and verify that the airbag readiness light in the instrument cluster is no longer illuminated.
- If the airbag readiness light in the instrument cluster remains illuminated, there may be a problem due to the front passenger sensing system.

Do not attempt to repair or service the system. Take your vehicle in for service immediately.

# Airbags

If it is necessary to modify an advanced front airbag system to accommodate a person with disabilities, contact your Customer Relationship Center. See **Contacting Us** (page 15).

## FRONT PASSENGER SENSING SYSTEM PRECAUTIONS



**WARNING:** Sitting improperly, out of position or with the seatback reclined too far can take weight off the seat cushion and affect the decision of the passenger sensing system, resulting in serious injury or death in the event of a crash. Always sit upright against your seat back, with your feet on the floor.



**WARNING:** Any alteration or modification to the front passenger seat may affect the performance of the front passenger sensing system. This could seriously increase the risk of injury or death.

## FRONT PASSENGER SENSING SYSTEM INDICATORS

Occupant	Passenger Airbag Status Indicator	Passenger Airbag
Empty	OFF: Illuminated	Disabled
	ON: Not Illuminated	
Child	OFF: Illuminated	Disabled
	ON: Not Illuminated	
Adult	OFF: Not Illuminated	Enabled
	ON: Illuminated	

# Airbags

## CRASH SENSORS AND AIRBAG INDICATOR



**WARNING:** Modifying or adding equipment to the front of your vehicle could affect the performance of the airbag system, increasing the risk of injury. This includes the hood, bumper system, frame, front body structure, tow hooks, hood pins, push bar and snowplows.

Your vehicle has a collection of crash and occupant sensors. These sensors provide information to the restraints control module which activates the following:

- Front and rear seatbelt pretensioners.
- Driver airbag.
- Passenger airbag.
- Knee airbag(s).
- Front and rear seat mounted side airbags.
- Adaptive steering column.
- Side curtain airbags.

Based on the type of crash, the restraints control module deploys the appropriate safety devices.

The restraints control module also monitors the readiness of the above safety devices plus the crash and occupant sensors. The readiness of the safety system is indicated by a warning indicator light in the instrument cluster or by a backup tone if the warning light is not working. Routine maintenance of the airbag is not required.

A difficulty with the system is indicated by one or more of the following:



The readiness light will not illuminate immediately after you switch the power on.

- The readiness light either flashes or stays on.
- You hear a series of five tones. The tone pattern repeats periodically until the problem, the light or both are repaired.

If any of these things happen, even intermittently, have the supplemental restraint system serviced immediately. Unless serviced, the system may not function properly in the event of a crash.

The fact that the seatbelt pretensioners or front airbags did not activate for both front seat occupants in a crash does not mean that something is wrong with the system. Rather, it means the restraints control module determined the accident conditions (crash severity, seatbelt usage) were not appropriate to activate these safety devices.

- The front airbags activate only in frontal and near-frontal crashes. Front airbags may activate in rollovers, side impacts or rear impacts if the crash causes sufficient frontal deceleration.
- The seatbelt pretensioners activate in frontal, near-frontal and side crashes, and in rollovers.
- The knee airbag deploys based on crash severity and occupant conditions.
- The side airbags inflate in certain side impact crashes or rollover events. Side airbags may activate in other types of crashes if the vehicle experiences sufficient sideways motion or deformation.
- The Safety Canopy inflates in certain side impact crashes or rollover events. The Safety Canopy may activate in other types of crashes if the vehicle experiences sufficient sideways motion or deformation, or a certain likelihood of rollover.



# Airbags

---

## **DISPOSING OF AIRBAGS**

Contact your authorized dealer as soon as possible. Airbags must be disposed of by qualified personnel.

# Pedestrian Alert System

---

## **WHAT IS THE PEDESTRIAN ALERT SYSTEM**

Due to the quiet operation of hybrid and electric vehicles at low speeds, the system creates a subtle sound to alert pedestrians.

The system is on when your vehicle is running and not in park (P). Some sound may be audible in the passenger compartment.

# 911 Assist

## WHAT IS 911 ASSIST

911 Assist is a SYNC system feature that can call for help.

For more information, visit [www.owner.ford.com](http://www.owner.ford.com).

## HOW DOES 911 ASSIST WORK

If a crash deploys an airbag, excluding knee airbags and rear inflatable seatbelts, or activates the battery shut-off, your vehicle may be able to contact emergency services by dialing 911 through a paired and connected **Bluetooth**®-enabled phone.

Not all crashes will deploy an airbag or activate the battery shut-off. If a connected cell phone sustains damage or loses its connection to SYNC during a crash, SYNC will search for and try to connect to a previously paired cell phone. SYNC will then attempt to call the emergency services.

Before making the call:

- SYNC provides about 10 seconds to cancel the call. If you fail to cancel the call, SYNC attempts to dial 911.
- SYNC says the following, or a similar message: "SYNC will attempt to call 911, to cancel the call, press Cancel on your screen or press and hold the phone button on your steering wheel."

If you do not cancel the call and SYNC makes a successful call a pre-recorded message plays for the 911 operator. The occupants in your vehicle are able to talk with the operator. Be prepared to provide your name, phone number and location immediately because not all 911 systems are capable of receiving this information electronically.

During an emergency call the system transmits vehicle data to the emergency service.

## EMERGENCY CALL REQUIREMENTS



**WARNING:** Do not wait for 911 Assist to make an emergency call if you can do it yourself. Dial emergency services immediately to avoid delayed response time which could increase the risk of serious injury or death after a crash. If you do not hear 911 Assist within five seconds of the crash, the system or phone may be damaged or non-functional.



**WARNING:** Always place your phone in a secure location in your vehicle so it does not become a projectile or get damaged in a crash. Failure to do so may cause serious injury to someone or damage the phone which could prevent 911 Assist from working properly.



**WARNING:** Unless the 911 Assist setting is set on before a crash, the system will not dial for help which could delay response time, potentially increasing the risk of serious injury or death after a crash.

- SYNC is powered and working properly at the time of the incident and throughout feature activation and use.
- The 911 Assist feature must be set on before the incident.
- You must pair and connect a **Bluetooth**® enabled and compatible cell phone to SYNC.
- A connected **Bluetooth**® enabled phone must have the ability to make and maintain an outgoing call at the time of the incident.

# 911 Assist

---

- A connected **Bluetooth**® enabled phone must have adequate network coverage, battery power and signal strength.
- The vehicle must have battery power and be located in the U.S., Canada or in a territory in which 911 is the emergency number.

**Note:** *If any user sets 911 Assist to on or off, that setting applies for all paired phones. If 911 Assist is off and the phone connected to SYNC, an icon displays on the status bar.*

**Note:** *Every phone operates differently. While SYNC 911 Assist works with most cellular phones, some may have trouble using this feature.*

## EMERGENCY CALL LIMITATIONS

The SYNC 911 Assist feature only operates in the U.S., Canada or in a territory in which 911 is the emergency number. The following are limitations of this feature:

- Your cellular phone or 911 Assist hardware sustains damage in a crash.
- The vehicle's battery or the SYNC system has no power.
- The phone(s) thrown from your vehicle are the ones paired and connected to the system.

# Keys and Remote Controls

## REMOTE CONTROL LIMITATIONS



**WARNING:** Changes or modifications not expressly approved by the party responsible for compliance could void the user's authority to operate the equipment. The term "IC:" before the radio certification number only signifies that Industry Canada technical specifications were met.

This device complies with Part 15 of the FCC Rules and with Industry Canada license-exempt RSS standard(s). Operation is subject to the following two conditions: (1) This device may not cause harmful interference, and (2) This device must accept any interference received, including interference that may cause undesired operation.

Make sure a valid remote control is within 5 ft (1.5 m) from the front door handles and rear of vehicle.

The system may not function if:

- The remote control remains stationary for about a minute.
- The vehicle battery has no charge.
- The remote control battery has no charge.
- There is interference causing issues with the remote control frequencies.
- The remote control is too close to metal objects or electronic devices, for example keys or a cell phone.

## USING THE REMOTE CONTROL

Use your remote control to access various vehicle systems.

**Note:** *The buttons on your remote may vary depending on the vehicle region or options.*

## One-Stage Unlocking



Press the button to unlock all doors. See **Unlocking and Locking the Doors Using the Remote Control** (page 76).

## Two-Stage Unlocking (If Equipped)



Press the button to unlock the driver's door. Press the button again within three seconds to unlock all doors. See **Unlocking and Locking the Doors Using the Remote Control** (page 76).

## Lock



Press the button to lock all doors. See **Unlocking and Locking the Doors Using the Remote Control** (page 76).

## Panic Alarm



Press the button to sound the panic alarm. See **Sounding the Panic Alarm** (page 65).

## Liftgate



Press the button twice to open the liftgate.

## SOUNDING THE PANIC ALARM



Press the button to sound the panic alarm. Press the button again or switch the vehicle on to turn it off.

**Note:** *The panic alarm only operates when the vehicle is off.*

# Keys and Remote Controls

## LOCATING YOUR VEHICLE



Press the lock button twice within three seconds. The turn signal lamps flash. We recommend you use this method to locate your vehicle.

## CHANGING THE REMOTE CONTROL BATTERY



**WARNING:** Keep batteries away from children to prevent ingestion. Failure to follow this instruction could result in personal injury or death. If ingested, immediately seek medical attention.



**WARNING:** If the battery compartment does not securely close, stop using the remote control and replace it as soon as possible. In the meantime, keep the remote control away from children. Failure to follow this instruction could result in personal injury or death.

The remote control uses one coin-type 3-volt lithium battery, CR2450, or equivalent.



1. Push the release button and pull the key blade out.

## Keys and Remote Controls

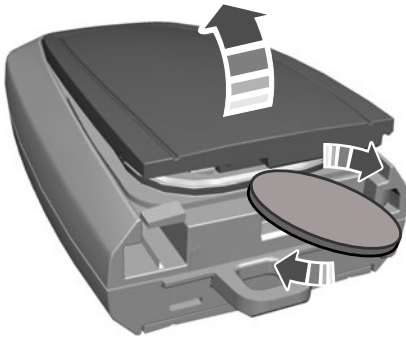
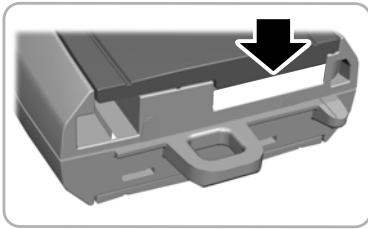

2. Twist a thin coin under the tab hidden behind the key blade head to remove the battery cover.

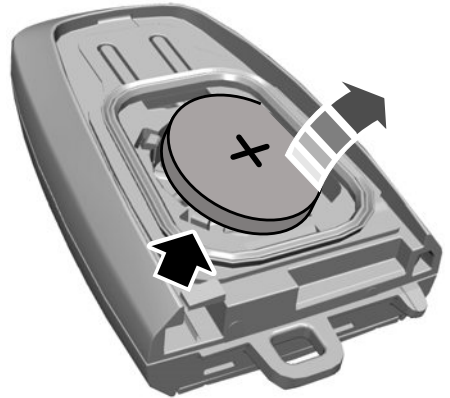

3. Insert a screwdriver in the position shown and carefully remove the battery.
4. Insert a new battery with the + facing upward.
5. Reinstall the battery cover onto the remote control and install the key blade.



**Note:** Refer to local regulations before you dispose of the remote control batteries.

**Note:** Do not wipe off any grease on the battery terminals or on the back surface of the circuit board.

**Note:** Replacing the remote control battery does not erase the programmed key from your vehicle. The remote control operates as normal.

**Note:** A message appears in the information display when the remote control battery is low.

# Keys and Remote Controls

---

## REPLACING A LOST KEY OR REMOTE CONTROL

You can purchase replacement keys or remote controls from an authorized dealer. Authorized dealers can program remote controls for your vehicle.

## PROGRAMMING THE REMOTE CONTROL

Contact an authorized dealer to program remote controls for your vehicle.

## KEYS AND REMOTE CONTROLS – TROUBLESHOOTING

### KEYS AND REMOTE CONTROLS – INFORMATION MESSAGES

<b>Message</b>	<b>Action</b>
Key Battery Low Replace Soon	Replace remote control battery.



# Phone as a Key

---

## WHAT IS PHONE AS A KEY

Phone as a Key allows you to use your phone in place of a passive key.

You can use your phone for the following functions:

- Remote locking and unlocking.
- Passive entry and exit.
- Passive start and drive the vehicle.
- Remote start.
- Memory function recall.

## PHONE AS A KEY LIMITATIONS

Limitations can vary based on the make and model of your phone, phone location and physical obstructions.

The following items could impact Phone as a Key performance or prevent functionality in some cases:

- The typical operating range for Phone as a Key is 131 ft (40 m).
- Your **Bluetooth®** connection is not enabled, is disrupted, or out of range.
- Your Phone as a Key is not active or enabled on at least one phone.
- Your vehicle battery has depleted.
- Your phone battery has depleted.
- Interference from other devices using radio frequencies or physical obstructions.
- Your phone is too close to metal objects or other electronic devices.

**Note:** Do not leave a duplicate coded key in the vehicle. Always take your keys and phone and lock all doors when leaving the vehicle.

## PROGRAMMING YOUR PHONE

To program your smartphone as Phone as a Key:

1. Visit your device's app store to download the FordPass app.
2. Create or sign-in to the FordPass app and add the vehicle identification number to your account.
3. Once you add the vehicle identification number, follow the prompts in the FordPass app to complete the Sync Connect Authorization process.
4. After the vehicle authorizes, you can setup Phone as a Key following the prompts in the FordPass app.
5. After Phone as a Key is setup, you can setup the Backup Start Passcode by following the prompts on your touchscreen.

**Note:** Keep your new Backup Start Passcode with you in case of an emergency.

## Resetting Phone as a Key

If the Phone as a Key belongs to your account, you can delete it from your phone. If not, reset Phone as a Key using the following steps:

1. Press **Settings** on the touchscreen.
2. Press **General**.
3. Press **Reset**.
4. Press the app connect reset option.
5. Press **Reset All**.
6. Confirm you would like to continue with erasing all Phone as a Key, Backup Start Passcodes.
7. Press **Continue**.
8. Confirm you are aware you are de-authorizing all authorized users and FordPass Connect settings.
9. Press **Continue**.

# Phone as a Key

---

**Note:** Please wait while the vehicle resets all the Phone as a Key, Backup Start Passcodes, FordPass Connect Settings and de-authorizes previously authorized users.

## USING THE VALET MODE

1. Press Settings on the touchscreen.
2. Press Valet Mode.

**Note:** Have your Backup Start Passcode completely setup before using Valet Mode.

**Note:** Once the system detects a valid Phone as a Key, the temporary passcode displays in both the touchscreen and mobile app. If the system does not detect a valid Phone as a Key, it prompts you to enter your Backup Start Passcode. Once validated, the temporary passcode displays on the touchscreen.

3. Enter the first five digits of the passcode on the keyless entry keypad to unlock your vehicle.
4. Enter the eight-digit passcode on the touchscreen to start and drive your vehicle.

To disable Valet Mode, press Exit Valet Mode on the touchscreen. Once the system detects an authorized Phone as a Key, it disables. If the system does not detect a valid Phone as a Key, it prompts you to enter your Backup Start Passcode. Once validated, Valet Mode disables.

## USING THE BACKUP START PASSCODE

If you are unable to start your vehicle with Phone as a Key, follow the steps below:

1. Press the brake pedal and the ignition button. If the system does not detect a valid Phone as a Key, a message appears and the system prompts you for your Backup Start Passcode.

**Note:** Make sure you have Phone as a Key active on at least one phone to use the previously created Backup Start Passcode.

**Note:** If the Backup Start Passcode screen does not appear, it is necessary to press the ignition button again.

2. Use the touchscreen to enter your Backup Start Passcode.
3. After entering your Backup Start Passcode, you must press Enter within 30 seconds.
4. Once the system validates the Backup Start Passcode, a message alerts you to start your vehicle.
5. Press the brake pedal and the ignition button within 20 seconds to start the vehicle.
6. If your vehicle does not start, repeat steps 1-5.

## System Lockout

The system locks after five attempts of trying to enter a Backup Start Passcode, resetting a current passcode or entering an incorrect Valet Mode passcode.

**Note:** The system remains locked for five minutes. After five minutes the system allows codes to be entered again.

## PHONE AS A KEY – TROUBLESHOOTING

### PHONE AS A KEY – FREQUENTLY ASKED QUESTIONS

#### How can I tell if my vehicle has Phone as a Key?

The touchscreen shows the Phone as a Key reset option if your vehicle has Phone as a Key. If you have registered your vehicle through the FordPass app, a control button appears on the home screen of the FordPass app.

# Phone as a Key

---

## What happens if I cannot unlock the vehicle with Phone as a Key?

Attempt to move your phone closer to the vehicle. Check that the FordPass app is still running and that the Phone as a Key control screen shows connected. If the phone is connected, attempt to press the remote unlock button in the FordPass app. If the phone is not connected or the remote unlock button does not work in the FordPass app, attempt to force close and restart the app.

## Why do I get a No Key Detected message in the instrument cluster display when I am using Phone as a Key and my phone is in the car?

Your phone's Bluetooth connection has been disrupted or is not connected. Try reconnecting your phone's Bluetooth connection. Move the phone closer to the center of the vehicle near the cup holder or center console. Verify your Phone as a Key is still active, enabled and has not been revoked.

## What do I do if my phone is lost, damaged, or the battery has depleted?

Use the Backup Start Passcode that you created to protect you in the event that you lose your phone, damage it, or the battery depletes. See **Using the Backup Start Passcode** (page 70).

## How many phones can I use for Phone as a Key?

You can program and activate up to four phones with Phone as a Key to your vehicle.

## How does a valet drive my car if I only use my Phone as a Key?

Have the valet use the temporary valet passcode that you created when using valet mode. See **Using the Valet Mode** (page 70).

## I uninstalled my FordPass app and reinstalled it. Why am I not able to get a new Phone as a Key?

Remove the Phone as a Key that was previously associated with your phone or reset Phone as a Key from your vehicle, and then request a new Phone as a Key. See **Programming Your Phone** (page 69).

## Why can I not remotely start the vehicle with my Phone as a Key?

Using the FordPass app, verify your Phone as a Key setup is complete and enabled via Bluetooth connection on at least one phone. If Bluetooth has connected but Phone as a Key setup is not complete, complete the setup of your Phone as a Key, as prompted from the FordPass app. See **Programming Your Phone** (page 69).

## WHAT IS MYKEY

MyKey allows you to program keys and mobile devices with restricted driving modes to promote good driving habits.

## MYKEY SETTINGS

### NON-CONFIGURABLE MYKEY SETTINGS

#### Seatbelt Reminder or Belt-Minder™

MyKey mutes the audio system until the front seat belts are buckled.

**Note:** *If your vehicle includes an AM/FM radio or a very basic audio system, then the radio may not mute.*

#### Satellite Radio (If Equipped)

Some Satellite radio channels have restricted access to adult radio content.

### Driving and Parking Aids

Settings for parking aids, blind spot information system, and cross traffic alert cannot be configured. These systems turn on when the vehicle turns on and cannot be switched off with a MyKey.

Settings for pre-collision assist and lane keeping cannot be configured. These systems turn on when the vehicle turns on but can be switched off with a MyKey.

A new destination in the navigation system can only be set using voice commands when using a MyKey, and with your vehicle moving.

**Note:** *MyKey drivers may be able to turn the lane departure warning feature off, but this feature turns back on automatically with every new key cycle.*

## CONFIGURABLE MYKEY SETTINGS

You can configure the following settings after creating a MyKey. See **Creating a MyKey** (page 73).

### Speed Limit



**WARNING:** Do not set MyKey maximum speed limit to a limit that will prevent the driver from maintaining a safe speed considering posted speed limits and prevailing road conditions. The driver is always responsible to drive in accordance with local laws and prevailing conditions. Failure to do so could result in accident or injury.

You can set a speed limit for your vehicle. Warning messages appear in the information display and a tone sounds if your vehicle reaches the set speed. You cannot override the set speed when using a MyKey.

### Speed Minder

You can set a speed reminder for your vehicle. Warning messages appear in the information display and a tone sounds if your vehicle exceeds the set speed.

### Audio System Volume Limit

The audio system maximum volume reduces. A message appears in the information display if you attempt to exceed the volume limit. Automatic volume control turns off.

### Emergency Assistance

If you set emergency assistance to always on, you cannot switch it off with a MyKey.

## Do Not Disturb

If you set do not disturb to always on, you cannot switch it off with a MyKey.

**Note:** If a phone is connected using Apple CarPlay or Android Auto while driving with a MyKey, the driver can receive phone calls and text messages even if the do not disturb restriction is on, and if the vehicle comes with satellite radio, there is no restriction on the adult content.

## Traction and Stability Control

If you set traction control or stability control to always on, you cannot switch it off with a MyKey.

## CREATING A MYKEY



**Note:** You can use these instructions to create a MyKey for either a passive key or a mobile device.

1. Remove the key blade from the remote control.
2. Place the passive key in the position shown, with the buttons facing upward.

3. Switch the vehicle on.
4. Access the vehicle drawer on the touchscreen.
5. Press **SETTINGS**.
6. Press **Vehicle**.
7. Press **MyKey**.
8. Press **Create MyKey** or **Create MyKey Mobile Device**.
9. Press **Yes**.

**Note:** After you confirm the creation of a MyKey, we recommend that you label this key.

**Note:** You can use both a passive key and a mobile device as a MyKey. You must purchase a second passive key and create it as a MyKey.

## PROGRAMMING A MYKEY

You can program any remote control to become MyKey restricted but you must leave one unmodified as an admin key.

1. Switch the vehicle on using an admin key.
2. Access the vehicle drawer on the touchscreen.
3. Press **Settings**.
4. Press **Vehicle**.
5. Press **MyKey**.
6. Select a setting and press the **OK** button.
7. Configure the setting.

## CLEARING ALL MYKEYS

When you clear all MyKeys, you remove all restrictions and return all MyKeys to their original admin key status.

1. Switch the vehicle on using an admin key.

2. Access the vehicle drawer on the touchscreen.
3. Press **Settings**.
4. Press **Vehicle**.
5. Press **MyKey**.
6. Press **Clear All MyKeys**.
7. Press **Yes**.

1. Switch the vehicle on.
2. Access the vehicle drawer on the touchscreen.
3. Press **Settings**.
4. Press **Vehicle**.
5. Press **MyKey**.
6. Press **MyKey Information**.

## CHECKING MYKEY SYSTEM STATUS

You can find information about the distance traveled using a MyKey, and the number of admin keys and MyKeys created for your vehicle.

## USING MYKEY WITH REMOTE START SYSTEMS

MyKey is not compatible with unapproved, aftermarket remote start systems. If you choose to install a remote start system, see an authorized dealer for an approved remote start system.

## MYKEY – TROUBLESHOOTING

### MYKEY – INFORMATION MESSAGES

Message	Description
Place Key in Backup Location	Displays when trying to create a MyKey and the admin key is not placed in the backup position. See <b>Creating a MyKey</b> (page 73).
Key is Already a MyKey	Displays when trying to create a MyKey with a key already designated as a MyKey.
This Key restricted at Next Key Cycle. Label Key as MyKey	Displays to confirm that the key is restricted after you switch the vehicle off.

## MYKEY – FREQUENTLY ASKED QUESTIONS

### What is an admin key?

An admin key is a key that you have not created as a MyKey. See **Creating a MyKey** (page 73).

### Why am I not able to create a MyKey?

The admin key is not placed in the backup position. See **Creating a MyKey** (page 73). The key used to switch the vehicle on is not an admin key. The key used to switch the vehicle on is the only admin key. There has to be at least one admin key. You did not switch the vehicle off after creating the last MyKey.

### Why am I not able to program a MyKey?

The admin key is not inside your vehicle. The key used to switch the vehicle on is not an admin key. No MyKeys are created. See **Creating a MyKey** (page 73).

### Why am I not able to clear the MyKeys?

The admin key is not inside your vehicle. The key used to switch the vehicle on is not an admin key. You have not created any MyKeys. See **Creating a MyKey** (page 73).

### Why is the MyKey distance not accumulating?

The key used to start the vehicle is an admin key. An admin key and a MyKey are inside your vehicle. No MyKeys are created. See **Creating a MyKey** (page 73). You have cleared the MyKeys.

### Why am I not able to start the vehicle with a MyKey?

An admin key and a MyKey are inside your vehicle. The system recognizes only the admin key when both are present.

# Doors and Locks

## OPERATING THE DOORS FROM OUTSIDE YOUR VEHICLE

### UNLOCKING AND LOCKING THE DOORS USING THE REMOTE CONTROL

You can only use the remote control when your vehicle is stationary.

#### Unlocking the Doors



Press the button to unlock all doors.

#### One-Stage Unlocking



Press the button to unlock all doors.

#### Two-Stage Unlocking (If Equipped)



Press the button to unlock the driver's door. Press the button again within three seconds to unlock all doors.

#### Locking the Doors



Press the button to lock all doors. One short flash of the turn signal lamps confirms your vehicle is locked.

**Note:** For more information on operating the doors from outside your vehicle See **Keyless Entry** (page 80).

## OPENING AND CLOSING THE DOORS

**Note:** For more information on operating the doors from outside your vehicle See **Keyless Entry** (page 80).

## OPERATING THE DOORS FROM INSIDE YOUR VEHICLE

### UNLOCKING AND LOCKING THE DOORS USING THE CENTRAL LOCKING

The power door lock control is on the driver door.



Press the button to unlock all doors.



Press the button to lock all doors.

**Note:** The central locking only operates if the front doors are fully closed.

### INDIVIDUALLY UNLOCKING AND LOCKING THE DOORS USING THE LOCKING BUTTON

The power door lock control is on the driver and front passenger door panels.

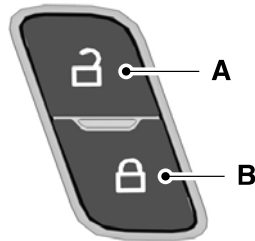

- A    Unlock.
- B    Lock.



# Doors and Locks

---

## OPENING THE DOORS FROM INSIDE YOUR VEHICLE

Pull the interior door handle twice to unlock and open a rear door. The first pull unlocks the door and the second pull opens the door.

## AUTOUNLOCK

### WHAT IS AUTOUNLOCK

Autounlock is an unlocking feature that unlocks the vehicle doors when your vehicle comes to a stop.

### AUTOUNLOCK REQUIREMENTS

Autounlock unlocks all the doors when all of the following occur:

- The vehicle is on, all the doors are closed and your vehicle is moving at a speed greater than 12 mph (20 km/h).
- Your vehicle comes to a stop.
- You open the driver door within 10 minutes of switching the vehicle off or to the accessory position.

## AUTOLOCK

### WHAT IS AUTOLOCK

Autolock is a locking feature that locks your vehicle doors when you start driving.

### AUTOLOCK REQUIREMENTS

Autolock locks all the doors when all of the following occur:

- All doors are closed.
- The vehicle is on.
- Your vehicle reaches a speed greater than 12 mph (20 km/h).

## MISLOCK

### WHAT IS MISLOCK

Mislock is a locking feature that warns you if your vehicle has not locked.

### MISLOCK LIMITATIONS

When you press the lock button once, the direction indicators do not flash if any door or the liftgate or hood is open.

1. If any door or the liftgate is open.
2. The hood is open.

### SWITCHING MISLOCK ON AND OFF

1. Access the vehicle drawer on the touchscreen.
2. Press **SETTINGS**.
3. Press **Vehicle**.
4. Press **Locks**.
5. Switch **Mislock** on or off.

## DOORS AND LOCKS AUDIBLE WARNINGS

### Door Ajar Audible Warning

Sounds when a door is not fully closed and your vehicle is moving.

# Doors and Locks

---

## DOORS AND LOCKS – TROUBLESHOOTING

## DOORS AND LOCKS – WARNING LAMPS

### Door Ajar Warning Lamp



It illuminates when you switch the vehicle on and remains on if any door is open.

## DOORS AND LOCKS – INFORMATION MESSAGES

Message	Action
Driver Door Ajar	Displays if a door is open. Fully close the door.
Passenger Door Ajar	
Rear Left Door Ajar	
Rear Right Door Ajar	

# Doors and Locks

---

## **DOORS AND LOCKS – FREQUENTLY ASKED QUESTIONS**

### **How to unlock my vehicle if the 12 volt battery is dead?**

You must apply 12 volt power to the 12 volt system. See **Jump Starting the Vehicle** (page 289).

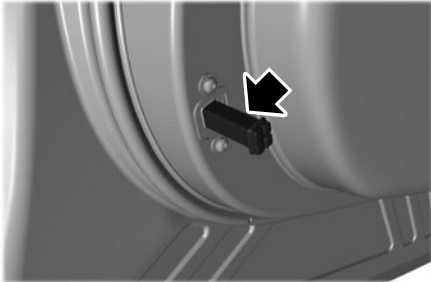

### **How to close my door if the actuator is extended?**

Apply pressure by pushing the outside of the door until the door closes.

# Keyless Entry

## KEYLESS ENTRY LIMITATIONS

Make sure your remote control is within 3 ft (1 m) from the front door handles and the tailgate.

The system could not function if:

- The remote control remains stationary for about a minute.
- The vehicle battery has no charge.
- The remote control battery has no charge.
- There is interference causing issues with the remote control frequencies.
- The remote control is too close to metal objects or electronic devices, for example keys or a cell phone.

## KEYLESS ENTRY SETTINGS

### Switching Keyless Entry On and Off

1. Switch the ignition on using an original key that has not been created as a MyKey.
2. Press **Settings** on the touchscreen.
3. Press **Vehicle Settings**.
4. Press **Locks**.

### Reprogramming the Unlocking Function

You can enable two-stage unlocking function allowing you to unlock only the driver door when you touch the unlock sensor.

Press and hold both the lock and unlock buttons on the remote control for four seconds to disable or enable two-stage unlocking.

If you program the unlocking function so that only the driver door unlocks, you can unlock all of the other doors from inside your vehicle using the power door lock control. You can unlock individual doors by pulling the interior door handles on those doors.

## USING KEYLESS ENTRY

### Unlocking the Doors

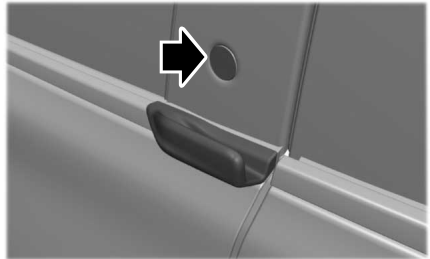

With your passive key or authorized phone within 3 ft (1 m) of your vehicle, gently press the touchpad on the door window trim to unlock and open the door.

# Keyless Entry

## Opening the Liftgate with Passive Key (If Equipped)



Press the exterior liftgate release button inside of the liftgate handle. The liftgate unlocks and opens. See **Opening the Liftgate From Outside Your Vehicle** (page 94).

## Locking the Doors

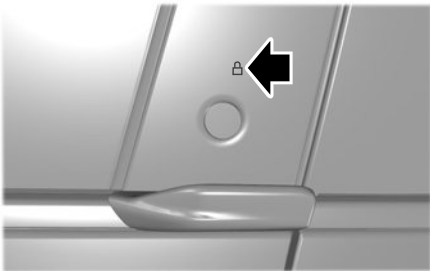

With your remote control or authorized phone within 3 ft (1 m) of your vehicle, touch the lock icon on the door window trim to lock the door. The keyless entry system requires a brief delay to authenticate your device.

**Note:** The door activation switch flashes one time to indicate the vehicle locks.

**Note:** Do not use the outside door handle as a roof cargo strap.

## Double Locking

With your remote control or authorized phone within 3 ft (1 m) of your vehicle, touch the lock icon twice within three seconds to double lock your vehicle.

## KEYLESS ENTRY – TROUBLESHOOTING

### KEYLESS ENTRY – FREQUENTLY ASKED QUESTIONS

#### Why does the passive key not work?

The system deactivates passive keys left inside your vehicle when you lock it. You cannot switch the ignition on using a deactivated passive key. Press the unlock button on the remote control to reactivate a passive key.

# Keyless Entry Keypad

## WHAT IS THE KEYLESS ENTRY KEYPAD

The keyless entry keypad allows you to lock and unlock your vehicle using the keypad on the window trim.

## KEYLESS ENTRY KEYPAD LIMITATIONS

The system may not function if:

- The vehicle battery has no charge.

## LOCATING THE KEYLESS ENTRY KEYPAD

The keypad is near the driver window and illuminates when you touch it.

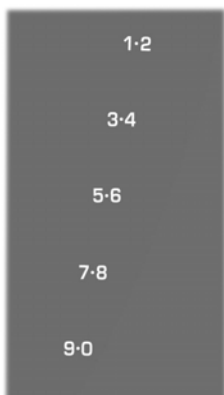

## KEYLESS ENTRY KEYPAD MASTER ACCESS CODE

### What Is the Master Access Code

The master access code is a factory-set five-digit entry code. You can operate the keypad with the master access code at any time. The master access code is on the owner's wallet card in the glove box and is available from an authorized dealer.

## KEYLESS ENTRY KEYPAD PERSONAL ACCESS CODES

### Programming a Personal Entry Code

1. Enter the five-digit master code.
2. Press **1-2** on the keypad within five seconds.
3. Enter your personal five-digit code. You must do this within five seconds of completing Step 2.
4. Press **1-2** on the keypad to save personal code 1.

The doors lock then unlock to confirm that programming was successful.

To program additional personal entry codes, repeat Steps 1 through 3, then for Step 4:

- Press **3-4** to save personal code 2.
- Press **5-6** to save personal code 3.
- Press **7-8** to save personal code 4.
- Press **9-0** to save personal code 5.

If your vehicle comes with SYNC, you can also program the system with a personal entry code.

# Keyless Entry Keypad

## Hints:

- Do not set a code that uses five of the same number.
- Do not use five numbers in sequential order.
- The five-digit master code works even if you have set your own personal code.

## Erasing a Personal Code

1. Enter the five-digit master code.
2. Press and release **1-2** on the keypad within five seconds.
3. Press and hold **1-2** for two seconds. You must do this within five seconds of completing Step 2.

All personal codes erase and only the five-digit master code works.

## Anti-Scan Feature

The keypad goes into an anti-scan mode if you enter the wrong code seven times. This mode turns off the keypad for one minute and the keypad lamp flashes.

The anti-scan feature turns off after:

- One minute of keypad inactivity.
- You press the unlock button on the remote control.
- You switch the ignition on.
- You unlock your vehicle using keyless entry.

## USING THE KEYLESS ENTRY KEYPAD

### Unlocking the Doors



Enter the factory-set five-digit code or your personal code. You must press each number within five seconds of each other.

- Press **3-4** within five seconds to unlock all doors.

# Keyless Entry Keypad

---

## Locking the Doors

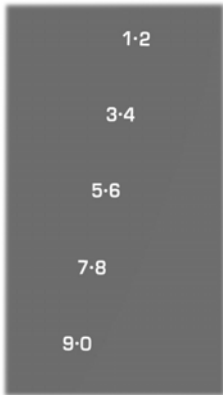

Press and hold **7-8** and **9-0** at the same time with the driver door closed.

**Note:** *You do not need to enter the code first.*

## KEYLESS ENTRY KEYPAD – TROUBLESHOOTING

### KEYLESS ENTRY KEYPAD – FREQUENTLY ASKED QUESTIONS

#### **Why does the keypad not accept the access code?**

If you enter the access code too fast on the keypad, the unlock function may not work. Slowly re-enter the access code.

#### **Why does the keypad not function?**

The keypad goes into an anti-scan mode if you enter a wrong code seven times. The anti-scan mode disables the keypad for one minute and the red light flashes.



# Walk Away Lock

---

## WHAT IS WALK AWAY LOCK

Walk away lock is a locking feature that locks the vehicle when you walk away from the vehicle with the passive key or authorized phone.

## HOW DOES WALK AWAY LOCK WORK

Walk Away Lock will lock all the doors when all of the following are met:

- The vehicle is off.
- All doors and luggage compartments have been closed and unlocked.
- A door or luggage compartment has been opened and closed without a lock or unlock occurring after all doors or luggage compartments have been closed.
- Any passive key or authorized phone is not inside the vehicle.
- More than 150 seconds has elapsed.

## WALK AWAY LOCK LIMITATIONS

Walk Away Lock does not lock all the doors when following occur:

- The vehicle is on.
- All doors are closed and locked.
- Any of the doors or luggage compartments are open.
- Any passive key or authorized phone is inside the vehicle.

## SWITCHING WALK AWAY LOCK ON AND OFF

1. Access the vehicle drawer on the touchscreen.

2. Press **SETTINGS**.
3. Press **Vehicle**.
4. Switch **Walk Away Lock** on or off.

## SWITCHING WALK AWAY LOCK AUDIBLE FEEDBACK ON AND OFF

1. Access the vehicle drawer on the touchscreen.
2. Press **SETTINGS**.
3. Press **Vehicle**.
4. Switch **Audible Feedback** on or off.

# Easy Entry and Exit

---

## HOW DOES EASY ENTRY AND EXIT WORK

This feature moves the driver seat rearward up to 2 in (5 cm) when you switch the ignition off. The driver seat returns to its previous position when you switch the ignition on.

## SWITCHING EASY ENTRY AND EXIT ON AND OFF

1. Press **Settings** on the touchscreen.
2. Press **Vehicle**.
3. Select **Easy Entry/Exit**.

If you press any adjustment or memory button when in easy exit mode, the system cancels the operation.

# Liftgate - Vehicles With: Hands-Free Liftgate

## LIFTGATE PRECAUTIONS



**WARNING:** It is extremely dangerous to ride in a cargo area, inside or outside of a vehicle. In a crash, people riding in these areas are more likely to be seriously injured or killed. Do not allow people to ride in any area of your vehicle that is not equipped with seats and seatbelts. Make sure everyone in your vehicle is in a seat and properly using a seatbelt. Failure to follow this warning could result in serious personal injury or death.



**WARNING:** Keep keys out of reach of children. Do not allow children to operate or play near an open or moving power liftgate. You should supervise the operation of the power liftgate at all times.

## OPENING THE LIFTGATE

### OPENING THE LIFTGATE FROM INSIDE YOUR VEHICLE



With the transmission in park (P), access the liftgate settings on the touchscreen.

1. Press the vehicle icon located in the top corner.
2. Press **CONTROLS**.
3. Press **Access**.
4. Press the liftgate icon.

**Note:** Be careful when opening or closing the liftgate in a garage or other enclosed area to avoid damaging the liftgate.

**Note:** Do not hang anything, for example a bike rack, from the glass or liftgate. This could damage the liftgate and its components.

**Note:** Do not leave the liftgate open while driving. This could damage the liftgate and its components.

### OPENING THE LIFTGATE FROM OUTSIDE YOUR VEHICLE

1. Unlock the liftgate using an authorized device.

**Note:** If an authorized device is within 3 ft (1 m) of the liftgate, the liftgate unlocks when you press the liftgate release button.



2. Press and release the liftgate control button.

**Note:** Allow the power system to open the liftgate. Manually pushing or pulling the liftgate may activate the system's obstacle detection feature and stop the power operation or reverse its direction, replicate a strut failure, or damage mechanical components.

**Note:** Be careful when opening or closing the liftgate in a garage or other enclosed area to avoid damaging the liftgate.

**Note:** Do not hang anything, for example a bike rack, from the glass or liftgate. This could damage the liftgate and its components.

## Liftgate - Vehicles With: Hands-Free Liftgate

**Note:** Do not leave the liftgate open while driving. This could damage the liftgate and its components.

### Switching the Power Liftgate On or Off

You can switch the power liftgate on or off through the vehicle settings on your touchscreen.

When switched off, the liftgate only unlatches and will not power open or close.

### OPENING THE LIFTGATE USING THE REMOTE CONTROL



Press the button twice within three seconds.

**Note:** Be careful when opening or closing the liftgate in a garage or other enclosed area to avoid damaging the liftgate.

**Note:** Do not hang anything, for example a bike rack, from the glass or liftgate. This could damage the liftgate and its components.

**Note:** Do not leave the liftgate open while driving. This could damage the liftgate and its components.

### OPENING THE HANDS-FREE LIFTGATE

Make sure you have the authorized device within 3 ft (1 m) of the liftgate.

1. Stand behind your vehicle, and face the liftgate.
2. Move your foot, in a single-kick motion, without pausing, under and away from the rear bumper detection area.

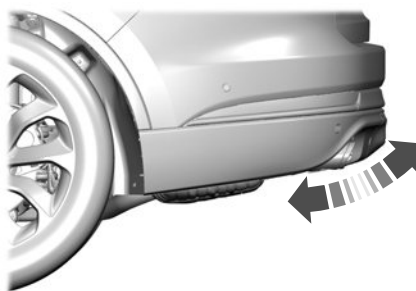

3. The liftgate opens.

Avoid the following actions when using the hands-free opening feature:

- Making physical contact with the bumper.
- Holding your foot under the bumper.
- Sweeping your foot from side to side, or kicking at an odd angle.

### Detection Zones



The detection area is in the center of the rear bumper.

**Note:** Allow the power system to open the liftgate. Manually pulling the liftgate may activate the system's obstacle detection feature and stop the power operation or reverse its direction, replicate a strut failure, or damage mechanical components.

# Liftgate - Vehicles With: Hands-Free Liftgate

**Note:** Any physical actions that mimic a kicking motion such as splashing water, trailer chains or vacuum hoses may cause the hands-free liftgate to activate. Switch the power liftgate off through your vehicle settings or keep the authorized device away from the rear bumper detection area.

## SETTING THE LIFTGATE OPENING HEIGHT

1. Open the liftgate.
2. Stop the liftgate movement by pressing the control button on the liftgate when it reaches the desired height.

**Note:** Once the liftgate stops moving, you can manually move it to the desired height.

3. Press and hold the control button on the liftgate until a tone sounds, indicating programming is complete.

**Note:** You can only use the liftgate control button to program the height.

**Note:** You cannot program the height if the liftgate position is too low.

4. The power liftgate now opens at the programmed height. To change the programmed height, repeat the steps.

**Note:** You can fully open the liftgate by manually pushing it upward to the maximum open position if it opens in a lower position.

**Note:** The system recalls the new programmed height until you reprogram it, even if you disconnect the battery.

## CLOSING THE LIFTGATE

### CLOSING THE LIFTGATE FROM INSIDE YOUR VEHICLE



**WARNING:** Make sure all persons are clear of the power liftgate area before using the power liftgate control.



With the transmission in park (P), access the liftgate settings on the touchscreen.

1. Select or pull down on the vehicle icon located in the top corner.
2. Press **CONTROLS**.
3. Press **Access**.
4. Select the liftgate icon.

**Note:** Make sure that you close the liftgate before operating or moving your vehicle, especially in an enclosure, like a garage or a parking structure. This could damage the liftgate and its components.

**Note:** Make sure the area behind your vehicle is free from obstruction and that there is enough room for you to operate the liftgate. Objects too close to your vehicle, for example a wall, garage door or another vehicle may come into contact with the moving liftgate. This could damage the liftgate and its components.

**Note:** Make sure that you fully close the liftgate to prevent cargo from falling out.

### CLOSING THE LIFTGATE FROM OUTSIDE YOUR VEHICLE



**WARNING:** Make sure all persons are clear of the power liftgate area before using the power liftgate control.

## Liftgate - Vehicles With: Hands-Free Liftgate

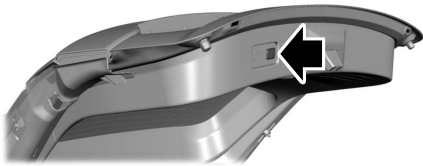

Press and release the liftgate button. A tone sounds when the liftgate begins to close.

**Note:** Make sure that you close the liftgate before operating or moving your vehicle, especially in an enclosure, like a garage or a parking structure. This could damage the liftgate and its components.

**Note:** Make sure the area behind your vehicle is free from obstruction and that there is enough room for you to operate the liftgate. Objects too close to your vehicle, for example a wall, garage door or another vehicle may come into contact with the moving liftgate. This could damage the liftgate and its components.

**Note:** Make sure you fully close the liftgate to prevent cargo from falling out.

### CLOSING THE LIFTGATE USING THE REMOTE CONTROL



**WARNING:** Make sure all persons are clear of the power liftgate area before using the power liftgate control.



Press the button twice within three seconds.

**Note:** Make sure that you close the liftgate before operating or moving your vehicle, especially in an enclosure, like a garage or a parking structure. This could damage the liftgate and its components.

**Note:** Make sure the area behind your vehicle is free from obstruction and that there is enough room for you to operate the liftgate. Objects too close to your vehicle, for example a wall, garage door or another vehicle may come into contact with the moving liftgate. This could damage the liftgate and its components.

**Note:** Make sure that you fully close the liftgate to prevent cargo from falling out.

### CLOSING THE HANDS-FREE LIFTGATE

Make sure you have the authorized device within 3 ft (1 m) of the liftgate.

1. Stand behind your vehicle, and face the liftgate.
2. Move your foot, in a single-kick motion, without pausing, under and away from the rear bumper detection area.

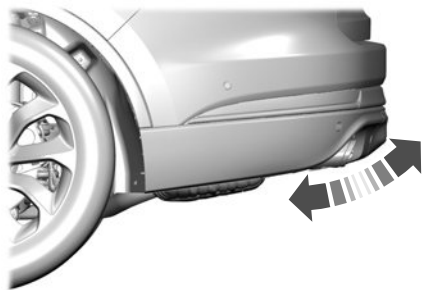

3. The liftgate closes.

**Note:** A tone sounds when the liftgate begins to close.

Avoid the following actions when using the hands-free feature:

# Liftgate - Vehicles With: Hands-Free Liftgate

- Making physical contact with the bumper.
- Holding your foot under the bumper.
- Sweeping your foot from side to side, or kicking at an odd angle.

## Detection Zones



The detection area is in the center of the rear bumper.

**Note:** Allow the power system to close the liftgate. Manually pushing the liftgate may activate the system's obstacle detection feature and stop the power operation or reverse its direction, replicate a strut failure, or damage mechanical components.

## STOPPING THE LIFTGATE MOVEMENT

**Note:** Do not apply sudden excessive force to the liftgate while it is in motion. This could damage the power liftgate and its components.

**Note:** Selections will vary depending on region or options.

You can stop the liftgate movement by doing any of the following:

- Pressing the liftgate control button on the liftgate.
- Pressing the liftgate control button inside the vehicle.
- Pressing the liftgate button on the remote control twice.
- Pressing the liftgate button on an authorized device.
- Moving your foot under and away from the center rear bumper in a single-kick motion.

## LIFTGATE OBSTACLE DETECTION

### Closing the Liftgate

The system stops when it detects an obstacle. A tone sounds and the system reverses to open. Once you remove the obstacle, you can power close the liftgate.

**Note:** To prevent accidental obstacle detection, let the power liftgate close completely before you enter your vehicle.

### Opening the Liftgate

The system stops when it detects an obstacle and a tone sounds. Once you remove the obstacle, you can continue to operate the liftgate.

## LIFTGATE – TROUBLESHOOTING

### LIFTGATE – WARNING LAMPS



Illuminates when the liftgate is not completely closed.

# Liftgate - Vehicles With: Hands-Free Liftgate

---

## LIFTGATE – INFORMATION MESSAGES

<b>Message</b>	<b>Action</b>
Liftgate Ajar	The liftgate is not completely closed. Close the liftgate.



# Liftgate - Vehicles With: Hands-Free Liftgate

---

## **LIFTGATE – FREQUENTLY ASKED QUESTIONS**

### **Why won't my power liftgate function?**

Make sure the transmission is in park (P), ensure nothing is obstructing the liftgate path and there is not excessive weight on the liftgate. If there are continued issues, the battery voltage may be low or other system issues. See an authorized dealer.

# Liftgate - Vehicles With: Manual Liftgate

## OPENING THE LIFTGATE

### OPENING THE LIFTGATE FROM OUTSIDE YOUR VEHICLE



Press the control button to unlatch the liftgate and then lift to open.

**Note:** Be careful when opening or closing the liftgate in a garage or other enclosed area to avoid damaging the liftgate.

**Note:** Do not hang anything, for example a bike rack, from the glass or liftgate. This could damage the liftgate and its components.

**Note:** Do not leave the liftgate open while driving. This could damage the liftgate and its components.

### OPENING THE LIFTGATE USING THE REMOTE CONTROL



Press the button twice within three seconds. The liftgate unlocks for 45 seconds, during which time you can open the liftgate using the outside control button.

**Note:** Be careful when opening or closing the liftgate in a garage or other enclosed area to avoid damaging the liftgate.

**Note:** Do not hang anything, for example a bike rack, from the glass or liftgate. This could damage the liftgate and its components.

**Note:** Do not leave the liftgate open while driving. This could damage the liftgate and its components.

## CLOSING THE LIFTGATE

### CLOSING THE LIFTGATE FROM OUTSIDE YOUR VEHICLE



**WARNING:** It is extremely dangerous to ride in a cargo area, inside or outside of a vehicle. In a crash, people riding in these areas are more likely to be seriously injured or killed. Do not allow people to ride in any area of your vehicle that is not equipped with seats and seatbelts. Make sure everyone in your vehicle is in a seat and properly using a seatbelt. Failure to follow this warning could result in serious personal injury or death.

## Liftgate - Vehicles With: Manual Liftgate

---



A handle is located inside the liftgate to help with closing.

**Note:** *Make sure that you fully close the liftgate to prevent cargo from falling out.*

# Security

---

## PASSIVE ANTI-THEFT SYSTEM

### WHAT IS THE PASSIVE ANTI-THEFT SYSTEM

The passive anti-theft system prevents someone from starting the vehicle with an incorrectly coded key.

**Note:** *Do not leave a duplicate coded key in your vehicle. Always take the keys and lock all the doors when leaving your vehicle.*

### HOW DOES THE PASSIVE ANTI-THEFT SYSTEM WORK

The passive anti-theft system arms when you switch the ignition off.

It disarms when the ignition is switched on with a correctly coded key.

**Note:** *The system is not compatible with non-Ford aftermarket remote start systems.*

**Note:** *Do not leave a duplicate coded key in your vehicle. Always take the keys and lock all doors when leaving your vehicle.*

## ANTI-THEFT ALARM SYSTEM

### WHAT IS THE ANTI-THEFT ALARM SYSTEM

The Anti-Theft Alarm System warns you of an unauthorized entry to your vehicle.

### HOW DOES THE ANTI-THEFT ALARM SYSTEM WORK

When armed, the anti-theft alarm is triggered in any of the following ways:

- If someone opens a door, the liftgate or the hood without a correctly coded key or remote control.
- If you turn the power on without a correctly coded key.
- If the interior sensors detect movement inside your vehicle.
- If the inclination sensors detect an attempt to raise your vehicle.
- If someone disconnects the vehicle battery or the battery backup alarm.

If the anti-theft alarm is triggered, the alarm horn sounds for 30 seconds and the direction indicators flash for 5 minutes.

Any further attempts to carry out one of the above sounds the alarm again.

### WHAT ARE THE INTERIOR SENSORS

The interior sensors are designed to detect any movement inside your vehicle.

The interior sensors are in the overhead console.

**Note:** *Do not cover the interior sensors.*

### WHAT ARE THE INCLINATION SENSORS

The inclination sensor is designed to detect an attempt to raise your vehicle, for example to remove a wheel or to tow it away.

### ARMING THE ANTI-THEFT ALARM SYSTEM

The alarm is ready to arm when your vehicle is switched off.

# Security

---

Lock your vehicle with your remote control to arm the alarm.

## DISARMING THE ANTI-THEFT ALARM SYSTEM

Disarm the alarm by performing any of the following actions:

- Unlock the doors or luggage compartment with the remote control.
- Switch your vehicle on or start your vehicle.

## ANTI-THEFT ALARM SYSTEM SETTINGS

### WHAT ARE THE ALARM SECURITY LEVELS

You can select two levels of alarm security, all sensors and perimeter sensing.

#### All Sensors

All sensors is the standard setting.

In all sensors, all equipped sensors are on when you arm the alarm.

**Note:** *Do not arm the alarm with all sensors if passengers, animals or other moving objects are inside your vehicle.*

#### Perimeter Sensing

In perimeter sensing, the interior sensors are off when you arm the alarm.

All the other equipped sensors activate when you arm the alarm in this mode.

## SETTING THE ALARM SECURITY LEVEL

Access the vehicle drawer on the touchscreen.

1. Press **SETTINGS**.
2. Press **Vehicle**.
3. Press **Alarm System**.
4. Press **Motion sensors**.
5. Press a setting.

## WHAT IS ASK ON EXIT

You can choose which level of security you require after you switch the ignition off.

**Note:** *If you do not choose a setting, the system defaults to all sensors.*

## SWITCHING ASK ON EXIT ON AND OFF

Access the vehicle drawer on the touchscreen.

1. Press **SETTINGS**.
2. Press **Vehicle**.
3. Press **Alarm System**.
4. Press **Ask on Exit**.
5. Press a setting.

# Security

---

## SECURITY – TROUBLESHOOTING

### SECURITY – INFORMATION MESSAGES

<b>Message</b>	<b>Action</b>
No Key Detected	The system has not detected a correctly coded key.
Starting System Fault	The system has malfunctioned. Have your vehicle checked as soon as possible.
Vehicle Alarm To Stop Alarm, Start Vehicle.	Displays when the alarm has been triggered due to unauthorized entry.
Alarm Announcement	

# Security

---

## **SECURITY – FREQUENTLY ASKED QUESTIONS**

### **What should I do if there is any potential alarm problem with my vehicle?**

Take all remote controls to an authorized dealer if there is any potential alarm problem with your vehicle.

### **What should I do if the vehicle is unable to start with a correctly coded key?**

Have your vehicle checked as soon as possible.

# Steering Wheel

## ADJUSTING THE STEERING WHEEL



**WARNING:** Do not adjust the steering wheel when your vehicle is moving.

**Note:** Make sure that you are sitting in the correct position.

## SWITCHING THE HEATED STEERING WHEEL ON AND OFF



To switch the heated steering wheel on or off, press the button on the touchscreen near the climate controls.

**Note:** A sensor regulates the temperature of the steering wheel.

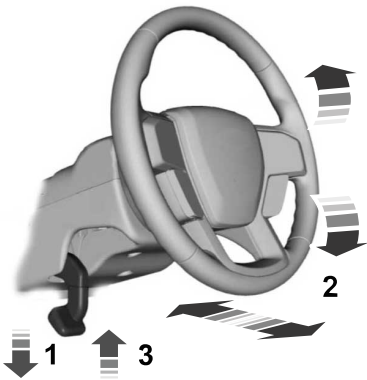

1. Unlock the steering column.
2. Adjust the steering wheel to the position you prefer.
3. Lock the steering column.

## HORN



Press on the center of the steering wheel near the horn icon to activate the horn.



# Wipers and Washers

## WIPERS

### WIPER PRECAUTIONS

Do not operate the wipers on a dry windshield. This could scratch the glass or damage the wiper blades. Use the windshield washers before wiping a dry windshield.

Fully defrost the windshield before you switch the windshield wipers on.

Switch the windshield wipers off before entering a car wash.

### SWITCHING WINDSHIELD WIPERS ON AND OFF

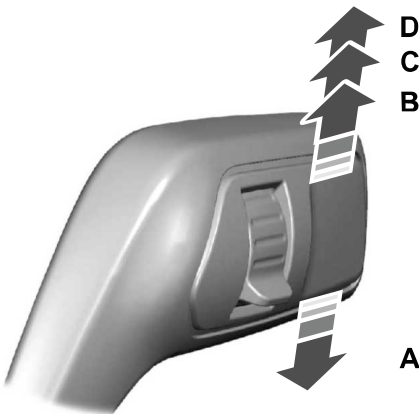

- A Single wipe.
- B Intermittent wipe/Auto wipe.
- C Normal wipe.
- D High-speed wipe.



Push the lever up or down to operate the windshield wipers.

## AUTOWIPERS

### WHAT ARE AUTOWIPERS

Autowipers turns on and controls the speed and frequency of the windshield wipers.

### AUTOWIPERS SETTINGS

1. Access the vehicle drawer on the touchscreen.
2. Press **SETTINGS**.
3. Press **Vehicle**.
4. Press **Wipers**.
5. Switch **Rain Sensing** on or off.

**Note:** When you switch the feature off, the wipers do not operate based on the rain sensor. When you switch on the windshield wipers to the intermittent wipe position with the feature off, the wipers use the wipe speed set by the rotary control.

# Wipers and Washers

## ADJUSTING THE SENSITIVITY OF THE RAIN SENSOR

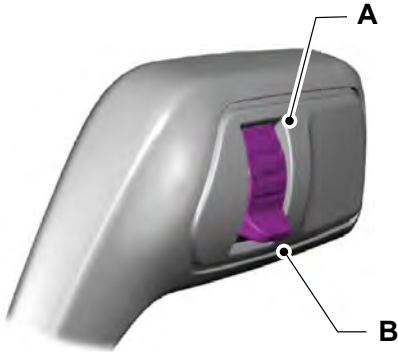

- A High sensitivity.
- B Low sensitivity.

Use the rotary control to set the sensitivity of the rain sensor.

When you select high sensitivity, the wipers operate when the sensor detects a small amount of water on the windshield.

When you select low sensitivity, the wipers operate when the sensor detects a large amount of water on the windshield.

## SWITCHING THE REAR WINDOW WIPER ON AND OFF

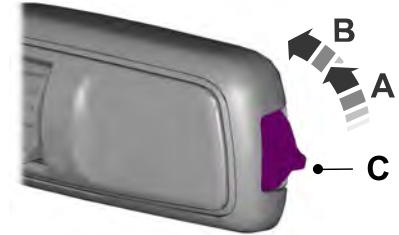

- A Intermittent wipe.
- B Continuous wipe.
- C Rear window wiper off.

## REVERSE WIPE

### WHAT IS REVERSE WIPE

Reverse wipe turns on the rear window wiper when you shift into reverse (R) and the windshield wipers are on.

### REVERSE WIPE SETTINGS

1. Access the vehicle drawer on the touchscreen.
2. Press **SETTINGS**.
3. Press **Vehicle**.
4. Press **Wipers**.
5. Switch **Reverse Wiper** on or off.

# Wipers and Washers

## CHECKING THE WIPER BLADES



Run the tip of your fingers over the edge of the blade to check for roughness.

## REPLACING THE FRONT WIPER BLADES

Make sure your vehicle is off before beginning this procedure.

**Note:** Do not manually move the wiper arms. To place the wiper arms in a service position, switch your vehicle on in accessory mode, switch on the wipers and switch your vehicle off when the wipers are at their highest position.

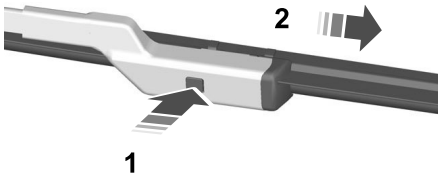

1. Lift the wiper arm and then press the wiper blade locking button.

**Note:** Do not hold the wiper blade to lift the wiper arm.

2. Remove the wiper blade.

**Note:** Make sure that the wiper arm does not spring back against the glass when the wiper blade is not attached.

3. To install, reverse the removal procedure.

**Note:** Make sure that the wiper blade locks into place.

## REPLACING THE REAR WIPER BLADES

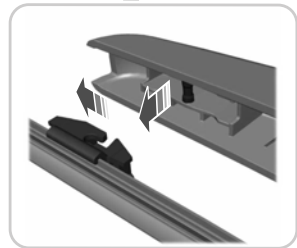
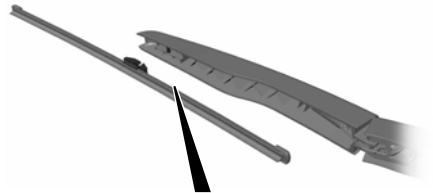

1. Lift the wiper arm.

**Note:** Do not hold the wiper blade to lift the wiper arm.

2. Remove the wiper blade.

**Note:** Make sure that the wiper arm does not spring back against the glass when the wiper blade is not attached.

3. To install, reverse the removal procedure.

**Note:** Make sure that the wiper blade locks into place.

# Wipers and Washers

## WASHERS

### WASHER PRECAUTIONS



**WARNING:** If you operate your vehicle in temperatures below 41°F (5°C), use washer fluid with antifreeze protection. Failure to use washer fluid with antifreeze protection in cold weather could result in impaired windshield vision and increase the risk of injury or accident.

Do not operate the washers when the washer reservoir is empty. This could cause the washer pump to overheat.

Keep the outside of the windshield clean. The rain sensor is very sensitive and the wipers may operate if dirt, mist or insects hit the windshield.

### USING THE WINDSHIELD WASHER



Pull the lever toward you to operate the windshield washer.

**Note:** A courtesy wipe occurs a short time after the wipers stop to clear any remaining washer fluid when switched on. See **Switching the Courtesy Wipe On and Off** (page 104).

### SWITCHING THE COURTESY WIPE ON AND OFF

1. Access the vehicle drawer on the touchscreen.
2. Press **SETTINGS**.
3. Press **Vehicle**.
4. Press **Wipers**.
5. Switch **Courtesy Wipe** on or off.

### USING THE REAR WINDOW WASHER



Push the lever away from you to operate the rear window washer.

**Note:** A courtesy wipe occurs a short time after the wipers stop to clear any remaining washer fluid when switched on. See **Switching the Courtesy Wipe On and Off** (page 104).

# Wipers and Washers

---

## ADDING WASHER FLUID



## WASHER FLUID SPECIFICATION

See **Washer Fluid Specification** (page 348).

## WIPERS AND WASHERS – TROUBLESHOOTING

### WIPERS AND WASHERS – WARNING LAMPS



Illuminates when the windshield washer fluid is low.

### WIPERS AND WASHERS – FREQUENTLY ASKED QUESTIONS

#### **Why are there streaks and smears on the windshield?**

The wiper blades could be dirty, worn or damaged. Check the wiper blades. See **Checking the Wiper Blades** (page 103). If the wiper blades are dirty, clean them with washer fluid or water applied with a soft sponge or cloth. If the wiper blades are worn or damaged, install new ones. See **Replacing the Front Wiper Blades** (page 103).

# Exterior Lighting

## EXTERIOR LIGHTING CONTROL

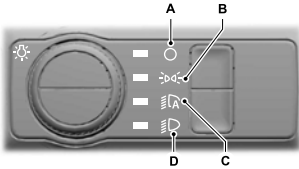

- A Lamps off.
- B Parking lamps on.
- C Autolamps on.
- D Headlamps on.

Rotate the control to make a selection.

**Note:** The lighting control defaults to autolamps every time you switch your vehicle on.

## HEADLAMPS

### USING THE HIGH BEAM HEADLAMPS



Push the lever away from you to switch the high beams on.

Push the lever forward again or pull the lever toward you to switch the high beams off.

Slightly pull the lever toward you and release it to flash the headlamps.

### SWITCHING HEADLAMP EXIT DELAY ON AND OFF

To switch headlamp exit delay on, pull the turn signal lever toward you after switching your vehicle off.

To switch headlamp exit delay off, pull the turn signal lever toward you again or switch your vehicle on.

**Note:** The headlamps turn off after three minutes with any door open or 30 seconds after the last door closes.

## HEADLAMP INDICATORS

### Lamps On



Illuminates when you switch the low beam headlamps or the parking lamps on.

### Headlamp High Beam



Illuminates when you switch the high beam headlamps on.

# Exterior Lighting

## HEADLAMPS – TROUBLESHOOTING

### HEADLAMPS – FREQUENTLY ASKED QUESTIONS

#### Why is there condensation in the headlamps?

Headlamps have vents to accommodate normal changes in air pressure. Condensation can be a natural by-product of this design. When moist air enters the lamp assembly through the vents, there is a possibility that condensation can occur when the temperature is cold. When normal condensation occurs, a fine mist can form on the interior of the lens. The fine mist eventually clears and exits through the vents during normal operation.

#### How much condensation is acceptable?

The presence of a fine mist, for example no streaks, drip marks or large droplets. A fine mist covers less than 50% of the lens.

#### How long may it take for the acceptable condensation to be cleared?

Clearing time may take as long as 48 hours under dry weather conditions.

#### How much condensation is unacceptable?

A water puddle inside the lamp. Streaks, drip marks or large droplets present on the interior of the lens.

#### What should I do if unacceptable condensation is present?

Have your vehicle checked as soon as possible.

#### Why do my headlamps turn off when I have them switched on when I switch my vehicle off?

The battery saver turns the headlamps off after a short period of time after you switch your vehicle off.

## AUTOLAMPS

### WHAT ARE AUTOLAMPS

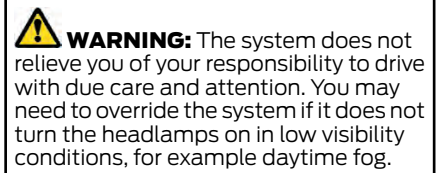

Autolamps turn the headlamps on in low light situations or when the windshield wipers operate.

### AUTOLAMP SETTINGS

1. Access the vehicle drawer on the touchscreen.
2. Press **SETTINGS**.
3. Press **Vehicle**.
4. Press **Lighting**.
5. Press **Autolamp Delay**.
6. Press a setting.

# Exterior Lighting

## EXTERIOR LAMPS

### SWITCHING THE TURN SIGNAL LAMPS ON AND OFF



Push the lever up or down to switch the turn signal lamps on.

Set the lever to the middle position to switch the turn signal lamps off.

**Note:** Tap the lever up or down to make the turn signal lamps flash three times.

### SWITCHING THE DAYTIME RUNNING LAMPS ON AND OFF - VEHICLES WITH CONFIGURABLE DAYTIME RUNNING LAMPS



**WARNING:** The daytime running lamps system does not activate the rear lamps and may not provide adequate lighting during low visibility driving conditions. Make sure you switch the headlamps on, as appropriate, during all low visibility conditions. Failure to do so may result in a crash.

1. Access the vehicle drawer on the touchscreen.
2. Press **SETTINGS**.

3. Press **Vehicle**.
4. Press **Lighting**.
5. Switch **Daytime Running Lights** on or off.

The daytime running lamps turn on when all of the following occur:

- You switch the system on.
- You switch the vehicle on.
- The transmission is not in park (P) for vehicles with automatic transmissions or you release the parking brake for vehicles with manual transmissions.
- The lighting control is in the autolamps position.
- The headlamps are off.

**Note:** Other lighting control positions do not turn on the daytime running lamps.

### SWITCHING THE DAYTIME RUNNING LAMPS ON AND OFF - VEHICLES WITH DAYTIME RUNNING LAMPS (DRL)



**WARNING:** The daytime running lamps system does not activate the rear lamps and may not provide adequate lighting during low visibility driving conditions. Make sure you switch the headlamps on, as appropriate, during all low visibility conditions. Failure to do so may result in a crash.

Daytime running lamps are always on unless you switch on the headlamps or your vehicle is in park (P).

### SWITCHING WELCOME LIGHTING ON AND OFF

Welcome lighting slowly turns on the exterior lamps when you approach your vehicle with an authenticated device or unlock the doors.



# Exterior Lighting

1. Access the vehicle drawer on the touchscreen.
2. Press **SETTINGS**.
3. Press **Vehicle**.
4. Press **Lighting**.
5. Switch **Welcome Lighting** on or off.

## EXTERIOR LAMP INDICATORS

### Turn Signal Lamp



It flashes when you switch the turn signal lamps on.

**Note:** An increase in the rate of flashing warns of a failed turn signal lamp.

## EXTERIOR LAMP AUDIBLE WARNING

### Exterior Lamps On

Sounds when you open the driver door and the exterior lamps are on.

## AUTOMATIC HIGH BEAM CONTROL

### HOW DOES AUTOMATIC HIGH BEAM CONTROL WORK

Automatic high beam control turns the high beams on if it is dark enough and no other traffic is present. If it detects an approaching vehicle's headlamps or tail lamps, or street lighting ahead, the system turns the high beams off.

A camera sensor, centrally mounted behind the windshield of your vehicle, continuously monitors conditions to turn the high beams on and off.

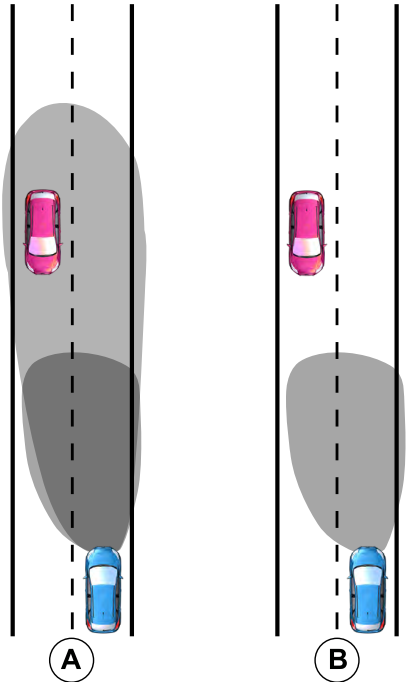

- A Without automatic high beam control.
- B With automatic high beam control.

## AUTOMATIC HIGH BEAM CONTROL PRECAUTIONS



**WARNING:** The system does not relieve you of your responsibility to drive with due care and attention. You may need to override the system if it does not turn the high beams on or off.

# Exterior Lighting



**WARNING:** The system may not switch the high beams off if the lights of oncoming vehicles are hidden by obstacles, for example guard rails.



**WARNING:** Do not use the system in poor visibility, for example fog, heavy rain, spray or snow.



**WARNING:** You may need to override the system when approaching other road users.



**WARNING:** You may need to override the system during inclement weather.

## AUTOMATIC HIGH BEAM CONTROL REQUIREMENTS

The system turns the high beams on if all of the following occur:

- You switch the system on.
- You set the lighting control to the autolamps position.
- The ambient light level is low enough that you require high beams.
- There is no traffic in front of your vehicle.
- The vehicle speed is greater than approximately 32 mph (52 km/h).

## AUTOMATIC HIGH BEAM CONTROL LIMITATIONS

The system turns the high beams off if any of the following occur:

- You switch the system off.
- You set the lighting control to any position except autolamps.
- The ambient light level is high enough that you do not require high beams.

- The system detects an approaching vehicle's headlamps or a leading vehicle's tail lamps.
- The system detects severe rain, snow or fog.
- The system detects street lighting.
- The camera has reduced visibility.
- The vehicle speed falls below approximately 19 mph (30 km/h).

## SWITCHING AUTOMATIC HIGH BEAM CONTROL ON AND OFF

1. Access the vehicle drawer on the touchscreen.
2. Press **SETTINGS**.
3. Press **Vehicle**.
4. Press **Lighting**.
5. Switch **Auto Highbeam** on or off.

## AUTOMATIC HIGH BEAM CONTROL INDICATORS



Illuminates to confirm when the system is ready to assist.

## OVERRIDING AUTOMATIC HIGH BEAM CONTROL



Push the lever away from you to switch the high beams on.

# Exterior Lighting

---

Push the lever away from you again to switch the high beams off.

Push the lever away from you for a third time to switch automatic high beam control back on.

## **AUTOMATIC HIGH BEAM CONTROL – TROUBLESHOOTING**

### **AUTOMATIC HIGH BEAM CONTROL – INFORMATION MESSAGES**

<b>Message</b>	<b>Description</b>
Front Camera Low Visibility Clean Screen	The camera has reduced visibility. Clean the windshield. If the message continues to appear, have your vehicle checked as soon as possible.
Front Camera Temporarily Not Available	The camera has malfunctioned. Wait a short period of time for the camera to cool down. If the message continues to appear, have your vehicle checked as soon as possible.
Front Camera Malfunction Service Required	The camera has malfunctioned. Have your vehicle checked as soon as possible.

# Interior Lighting

## SWITCHING ALL OF THE INTERIOR LAMPS ON AND OFF

The lamps turn on under the following conditions:

- You open any door.
- You press a button on the remote control.
- You press the all lamps on button on the overhead console.



Press to switch all interior lamps on or off.

## SWITCHING THE FRONT INTERIOR LAMPS ON AND OFF



The front interior lamp switches are on the overhead console.

**Note:** The position of each button on the overhead console depends on your vehicle.

### Individual Map Lamps



Press to switch the left-hand individual dome lamp on and off.



Press to switch the right-hand individual dome lamp on and off.

## SWITCHING THE REAR INTERIOR LAMPS ON AND OFF



The rear interior lamps may be above the rear seat or above the rear windows.



Press to switch the lamps on or off.

**Note:** If you switch the rear lamps on through the overhead console, you cannot switch them off with the rear lamp switch.

## INTERIOR LAMP FUNCTION

### WHAT IS THE INTERIOR LAMP FUNCTION

The interior lamp function switches the courtesy and door lamps on or off.

### SWITCHING THE INTERIOR LAMP FUNCTION ON AND OFF



Press to switch the interior lamp function on and off.

**Note:** The indicator lamp illuminates amber when the door function is off.

# Interior Lighting

---

## ADJUSTING THE INSTRUMENT PANEL LIGHTING BRIGHTNESS

The instrument lighting dimmer buttons are on the lighting control.



Repeatedly press one of the buttons to adjust the brightness.



## AMBIENT LIGHTING (IF EQUIPPED)

### SWITCHING AMBIENT LIGHTING ON AND OFF

1. Access the vehicle drawer on the touchscreen.
2. Press **SETTINGS**.
3. Press **Ambient Light**.
4. Press a color.

### ADJUSTING AMBIENT LIGHTING

Drag the selected color up or down.

## INTERIOR LIGHTING – TROUBLESHOOTING

### INTERIOR LIGHTING – FREQUENTLY ASKED QUESTIONS

#### **Why do my courtesy lamps or interior lamps turn off when I have them switched on when I switch my vehicle off?**

The battery saver turns the courtesy lamps and interior lamps off after a short period of time after you switch your vehicle off.

# Windows

## OPENING AND CLOSING THE WINDOWS



**WARNING:** Do not leave children unattended in your vehicle and do not let them play with the power windows. Failure to follow this instruction could result in personal injury.



**WARNING:** When closing the power windows, verify they are free of obstruction and make sure that children and pets are not in the proximity of the window openings.



Press the window control switch to open the window. Lift the window control switch to close the window.

**Note:** The power windows operate with the ignition on, and for several minutes after you switch the ignition off or until you open a front door.

To reduce wind noise or pulsing noise when one window is open, slightly open the opposite window.

### One-Touch Open

Fully press the window control switch and release it. Press again or lift it to stop the window.

### One-Touch Close

Fully lift the window control switch and release it. Press again or lift it to stop the window.

### Resetting One-Touch Close

Carry out all steps within 30 seconds of starting the sequence.

1. Close the window.

2. Press and hold the window control switch until the window is fully open. Keep the window control switch pressed for a few seconds.
3. Lift and hold the window control switch until the window is fully closed. Keep the window control switch held for a few seconds.
4. Press and hold the window control switch until the window is fully open. Keep the window control switch pressed for a few seconds.
5. Lift and hold the window control switch until the window is fully closed. Keep the window control switch held for a few seconds.

**Note:** Repeat the procedure if the window does not close when you use one-touch.

## GLOBAL OPENING AND CLOSING

### WHAT IS GLOBAL OPENING AND CLOSING

You can use the remote control to open the windows with the ignition off.

### USING GLOBAL OPENING

1. Press and release the unlock button on the remote control.
2. Press and hold the unlock button on the remote control.
3. Release the button when the windows start to open.

Press the lock or the unlock button on the remote control to stop global opening.

**Note:** You can use global opening for a short period of time when you unlock your vehicle using the remote control.

# Windows

## SWITCHING GLOBAL OPENING ON AND OFF

1. Access the vehicle drawer on the touchscreen.
2. Press **Settings**.
3. Press **Vehicle**.
4. Press **Windows**.
5. Switch **Remote Open** on or off.

## USING GLOBAL CLOSING



**WARNING:** When closing the power windows, verify they are free of obstruction and make sure that children and pets are not in the proximity of the window openings.

1. Press and hold the lock button on the remote control.
2. Release the button when the windows start to close.

Press the lock or the unlock button on the remote control to stop global closing.

**Note:** *Bounce-back is on during global closing. See **What Is Window Bounce-Back** (page 115).*

## SWITCHING GLOBAL CLOSING ON AND OFF

1. Access the vehicle drawer on the touchscreen.
2. Press **Settings**.
3. Press **Vehicle**.
4. Press **Windows**.
5. Switch **Remote Close** on or off.

## WINDOW BOUNCE-BACK

### WHAT IS WINDOW BOUNCE-BACK

The window stops and reverses if it detects an obstruction when closing.

### OVERRIDING WINDOW BOUNCE-BACK



**WARNING:** If you override bounce-back, the window does not reverse if it detects an obstacle. Take care when closing the windows to avoid personal injury or damage to your vehicle.

1. Close the window until it reaches the point of resistance and let it reverse.
2. Lift and hold the window control switch within two seconds to override bounce-back and close the window. Bounce-back is now disabled and you can close the window manually.

**Note:** *The window goes past the point of resistance and you can fully close it.*

**Note:** *If the window does not close, have your vehicle checked as soon as possible.*

## LOCKING THE REAR WINDOW CONTROLS



Press the window control switch to lock or unlock the rear window controls. It illuminates when you lock the rear window controls.

# Interior Mirror

---

## INTERIOR MIRROR PRECAUTIONS



**WARNING:** Do not adjust the mirrors when your vehicle is moving. This could result in the loss of control of your vehicle, serious personal injury or death.

**Note:** Do not clean the mirror housing or glass with harsh abrasives, fuel or other petroleum-based cleaning products.

## AUTO-DIMMING INTERIOR MIRROR

### WHAT IS THE AUTO-DIMMING INTERIOR MIRROR

The mirror dims to reduce the effect of bright light from behind. It returns to normal when the bright light from behind is no longer present or if you shift into reverse (R).

### AUTO-DIMMING INTERIOR MIRROR LIMITATIONS

Do not block the sensors on the front and back of the mirror.

**Note:** A rear center passenger or raised rear center head restraint could prevent light from reaching the sensor.



# Exterior Mirrors

## ADJUSTING THE EXTERIOR MIRRORS



**WARNING:** Do not adjust the mirrors when your vehicle is moving. This could result in the loss of control of your vehicle, serious personal injury or death.

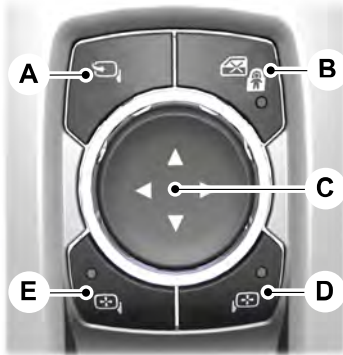

- A Power fold.
- B Window and child safety lock.
- C Adjustment control.
- D Right-hand mirror.
- E Left-hand mirror.

To adjust the mirrors, switch your vehicle on, with the push button start in accessory mode or your vehicle running.

1. Select the mirror you want to adjust. The control light turns on.
2. Use the adjustment control to adjust the position of the mirror.
3. Press the mirror control again. The control light turns off.

## FOLDING THE EXTERIOR MIRRORS - VEHICLES WITH: MANUAL FOLDING MIRRORS

Push the mirror toward the door window glass. Make sure that you fully engage the mirror in its support when returning it to its original position.

### Heated Exterior Mirrors

See **Switching the Heated Mirrors On and Off** (page 129).

### Memory Mirrors

You can save and recall the mirror positions through the memory function. See **Saving a Preset Position** (page 145).

### Directional Indicator Mirrors

When your vehicle is running, the forward-facing portion of the appropriate mirror housing blinks when you switch on the turn signal.

### Puddle Lamps

The puddle lamps turn on when you approach your vehicle with a remote control or phone. If your vehicle has auto-folding mirrors, the puddle lamps are only on if the mirrors are folded and turn off when the mirrors unfold.

### 360 Degree Camera (If Equipped)

See **Locating the 360 Degree Cameras** (page 214).

### Blind Spot Information System

See **What Is Blind Spot Information System** (page 252).

# Exterior Mirrors

## FOLDING THE EXTERIOR MIRRORS - VEHICLES WITH: POWER FOLDING MIRRORS

### Power-Folding Mirrors (If Equipped)

To fold both mirrors, switch your vehicle on, with the push button start in accessory mode or your vehicle running.



For tight parking conditions, press the control switch to fold the mirrors.

Press the control switch again to unfold the mirrors.

**Note:** Do not stop the mirrors midway through their movement. Wait until the mirrors stop moving and press the control again.

**Note:** The left-hand and right-hand mirrors move at different rates. For example, one mirror may stop when the other one continues to move. This is normal. Moving the mirrors 10 or more times within one minute, or repeated folding and unfolding of the mirrors when holding the control down during full travel, may disable the system to protect the motors from overheating. Wait approximately three minutes with your vehicle running, and up to 10 minutes with your vehicle off, for the system to reset and operate as normal.

### Loose Mirror

If the power-folding mirrors are manually folded, they may not properly work even after you re-position them. You need to reset them if:

- The mirrors vibrate when you drive.
- The mirrors feel loose.
- The mirrors do not stay in the folded or unfolded position.
- One of the mirrors is not in its normal driving position.

To reset the power-fold feature, use the power-folding mirror control to fold and unfold the mirrors. A loud noise could occur when you reset the power-folding mirrors, this sound is normal. Repeat this process as needed each time the mirrors are manually folded.

# Instrument Cluster

## INSTRUMENT CLUSTER OVERVIEW

**Note:** The instrument cluster display can be customized to display information in several different layouts. Maximum zone complexity shown.

**Note:** The instrument cluster display changes based on settings selected in the center display screen. See **Accessing Feature Drawers** (page 370).

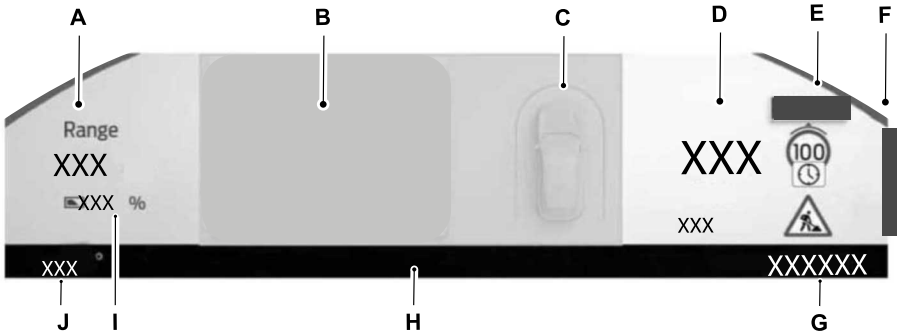

- A Range display area.
- B Pop-up message display area.
- C Driver assist area.
- D Vehicle speed display area.
- E Driver assist message display area.
- F Gear indicator.
- G Odometer.
- H Information bar.
- I High voltage battery gauge.
- J Compass or ambient temperature.

## SPEEDOMETER

Indicates the vehicle speed.

## VEHICLE RANGE DISPLAY

Displays the approximate range your vehicle can travel on the battery's current state of charge. Estimates vary based on the energy used when driving and the energy available in the high voltage battery.

# Instrument Cluster

---

The amount of energy being used when driving is affected by:

- Mild or aggressive acceleration or braking.
- Your vehicle's speed.
- Use of accessories, such as climate control.
- Ambient temperature and weather conditions.
- Driving in a city or on a highway.
- Driving on flat or hilly roads.
- Towing.

The available energy capacity in the high voltage battery is affected by cold temperatures and battery degradation. See **Preserving Your High Voltage Battery** (page 157).

When your navigation system has an active route the distance to your destination or next charging station is displayed.

**Note:** *It is normal for the vehicle range estimates to vary due to changes in average energy usage and battery temperature. This could cause different range estimates each time you fully charge your battery. See **Maximizing Your Driving Range** (page 283).*

**Note:** *When you leave your vehicle unplugged, it periodically uses energy from the high voltage battery to recharge the 12-volt accessory battery, resulting in a reduced driving range.*

## HIGH VOLTAGE BATTERY GAUGE

Displays the high voltage battery state of charge in the form of a gauge or a percentage. A full fill or 100% charge represents the total amount of energy you can get from plugging your vehicle in.

The gauge is normally blue. When a low battery condition is reached the gauge is amber. When the battery is depleted the gauge is red.

When the full battery gauge is displayed and your navigation system has an active route, a symbol is added that represents the battery charge level needed to reach your destination or next charging station.

## Charging Status

Additional charge information displays when you power on your vehicle without pressing the brake pedal and your vehicle is plugged in. Charging status includes the charge start or charge end time as appropriate. When DC charging, the time at 80% displays followed by the time at 100%. You can modify your vehicle charge settings on the information and entertainment display. See **Setting the Charging Schedule and Preferences** (page 174).

## Charge Required to Reach Destination

When the navigation system has an active route, the instrument cluster displays the charge level required in order to reach your destination and the time when that charge level is available.

## WHAT ARE THE INSTRUMENT CLUSTER WARNING LAMPS

Warning lamps alert you to a vehicle condition that could become serious. Some lamps illuminate when you start your vehicle to make sure they work. If any lamps remain on after starting your vehicle, refer to the respective system warning lamp for further information.

# Instrument Cluster

## INSTRUMENT CLUSTER WARNING LAMPS

### 12V Battery



It illuminates when your vehicle is first switched on to show it is properly functioning.

If it illuminates when the motor is running, this indicates your vehicle requires service. Have your vehicle checked as soon as possible.

Driving when this warning lamp is on drains the 12V battery. If you must drive with this light on, turn off all accessories.

### Anti-Lock Brake System



If it illuminates when you are driving, this indicates the system requires service. Your vehicle continues to have normal braking without the anti-lock brake system function. Have your vehicle checked as soon as possible.

### Brake System



It illuminates when you apply the parking brake and your vehicle is on. If it illuminates when your



vehicle is moving, make sure the parking brake is released. If the parking brake is released, this

indicates low brake fluid level or the brake system requires service. Have your vehicle checked as soon as possible.

**Note:** Lamps may vary depending on region.

### Door Ajar



It illuminates when your vehicle is on and remains on if any door is open.

### Electric Park Brake



It illuminates or flashes yellow when the electric parking brake requires service.



### Electric Motor Coolant Temperature



If it illuminates, safely stop your vehicle and switch your vehicle off.

### Fasten Seatbelt



It illuminates and a chime sounds until you fasten the seatbelts.

### High Voltage Battery



It illuminates blue under normal conditions. If it illuminates amber, then the battery is low on charge. If it illuminates red, then the battery is depleted.

### Hood Ajar



It illuminates when your vehicle is on and the hood is not completely closed.

### Liftgate Ajar



It illuminates when your vehicle is on and the trunk is not completely closed.

# Instrument Cluster

## Low Tire Pressure



It illuminates when your tire pressure is low. If illuminated, check your tire pressure as soon as possible. If it begins to flash at anytime, have the system checked as soon as possible.

## Low Washer Fluid Level



It illuminates when the washer fluid is low.

## Powertrain Malfunction



It illuminates when the powertrain requires service. Have the system checked as soon as possible.

## Stop Safely



It illuminates if an electrical component requires service or a failure that causes your vehicle to shutdown or enter into a limited operating mode.

## Vehicle Plugged In



It illuminates when your vehicle is plugged in.

## WHAT ARE THE INSTRUMENT CLUSTER INDICATORS

Indicators notify you of various features that are active on your vehicle.

## INSTRUMENT CLUSTER INDICATORS

### Adaptive Cruise Control



See **Adaptive Cruise Control** (page 221).

### Automatic Headlamp High Beam



See **Automatic High Beam Control Indicators** (page 110).

### Auto Hold Active



See **Auto Hold** (page 197).

### Auto Hold Unavailable



See **Auto Hold** (page 197).

### Blind Spot Information System



See **Blind Spot Information System** (page 252).

### BlueCruise



See **BlueCruise** (page 235).

### Cruise Control



See **Adaptive Cruise Control** (page 221).

### Headlamp High Beam



See **Using the High Beam Headlamps** (page 106).

# Instrument Cluster

---

## Parking Lamps



See **Headlamp Indicators** (page 106).

## Ready to Drive



See **Starting and Powering Off** (page 155).

## Stability Control and Traction Control



See **Traction Control** (page 198). See **Stability Control** (page 200).



## Turn Signal Lamps



See **Switching the Turn Signal Lamps On and Off** (page 108).

# Instrument Cluster Display

---

## WHAT IS BRAKE COACH

The brake coach appears after the vehicle has come to a stop. It coaches you to brake in a manner that maximizes the amount of energy returned through the regenerative braking system.

The percent displayed is an indication of the regenerative braking efficiency with 100% representing the maximum amount of energy recovery.

**Note:** *While regenerative braking works in all drive modes, brake coach display may not be available in all modes.*

You can switch brake coach on or off in the settings menu on your touchscreen.

1. Access the vehicle drawer on the touchscreen.
2. Press **SETTINGS**.
3. Press **Vehicle**.
4. Press **Show Brake Coach**.



# Trip Computer

## ACCESSING THE TRIP COMPUTER



Press the button to open the application drawer.

1. Select **Trips**.

## RESETTING THE TRIP COMPUTER



Press the button to open the application drawer.

1. Select **Trips**.
2. Select **Trip 1** or **Trip 2**.
3. Press **Reset**.

**Note:** *The current trip resets every time you start your vehicle.*

## TRIP DATA

Trip data includes distance, time and energy economy. Better energy economy, meaning greater efficiency or lower consumption, results in increased driving range.

### Where Did My Energy Go

Displays a breakdown of energy consumption for your trip.

- **Climate Use** – This includes energy used by your vehicle's high voltage climate control components such as the electric A/C compressor and the electric heater.
- **Driving and Route** – This includes energy used to propel your vehicle based on your driving style and route. Your driving style includes how fast you drive and whether your acceleration and braking is mild or aggressive. Your route includes factors such as the amount of city or highway driving and road grades.
- **Accessories** – This includes energy used for low voltage accessories such as climate system fans, heated seats and lighting.
- **Exterior Temperature** – This includes energy losses due to outside temperature and other conditions which reduce vehicle system efficiency.

## How Is My Driving

Display's scores for trip driving behavior. Higher scores result in better energy economy.

- **Acceleration** – Light to moderate acceleration improves your score.
- **Braking** – We recommend slow and steady braking.
- **Speed** – Maintain reasonable vehicle speeds for best scores.



You can view additional trip data by pressing the icon on your touchscreen.

# Remote Start

## WHAT IS REMOTE START

The system allows you to remotely start your vehicle and to adjust the interior temperature according to the settings that you chose.

**Note:** *If your vehicle is plugged in during the remote start operation, it will draw power from the power source and not the vehicle's battery.*

## REMOTE START LIMITATIONS

Remote start does not work under the following conditions:

- The alarm horn is sounding.
- The hood is open.
- The vehicle is not in park (P).
- The vehicle is on.
- Remote start has been disabled in the touchscreen.
- The high voltage or 12 volt battery is below the minimum operating voltage.

**Note:** *To use remote start with the Ford Pass, enable the modem. See **Enabling and Disabling the Modem** (page 352). To use remote start with Phone as a Key, enable the modem and set up Phone As A Key. See **Programming Your Phone** (page 69).*

## ENABLING REMOTE START

1. Access the vehicle drawer on the touchscreen.
2. Press **SETTINGS**.
3. Press **Vehicle**.
4. Press **Remote Start Setup**.
5. Switch **Remote Start** on or off.

**Note:** *To remote start with FordPass or Phone as a Key, make sure that the modem is enabled and Phone as a Key is setup. See **Enabling and Disabling the Modem** (page 352). See **Programming Your Phone** (page 69).*

## REMOTELY STARTING AND STOPPING THE VEHICLE

### Remotely Starting the Vehicle

Using your FordPass app, press and hold the start button within 131 ft (40 m) of the vehicle.

**Note:** *You can also use the phone as a key to start the vehicle.*

- The direction indicators flash twice.
- The parking lamps turn on when the vehicle is running.
- The horn sounds if the system fails to start.
- All other vehicle systems remain off when you have remotely started the vehicle.
- The vehicle remains secured when you have remotely started the vehicle. A valid key must be inside your vehicle to switch the vehicle on and drive your vehicle.

### Remotely Stopping the Vehicle

Using your FordPass app, press the remote stop button.

**Note:** *You can also use the phone as a key to stop the vehicle.*

## EXTENDING THE REMOTE START DURATION

Using your FordPass app, press the button showing addition time.

# Remote Start

**Note:** You can also use phone as a key to extend the remote start duration.

If the duration is set to 15 minutes, the duration extends by another 15 minutes. This provides a total of 30 minutes.

**Note:** Remote start can only be extended once.

**Note:** A maximum of two remote starts, or one remote start with an extension, are allowed. To reset the restart procedure switch the vehicle to on, then to off.

## REMOTE START SETTINGS

### SWITCHING CLIMATE CONTROL AUTO MODE ON AND OFF

1. Access the feature drawer on the touchscreen.
2. Press **SETTINGS**.
3. Press **Vehicle**.
4. Press **Remote Start Setup**.
5. Press **Climate Control**.
6. Switch **Auto** on or off.

**Note:** If you switch the auto mode on, the system attempts to heat or cool the interior to 72°F (22°C).

**Note:** When you switch the vehicle on, the climate control system returns to the last used settings.

### SWITCHING CLIMATE CONTROL LAST SETTINGS ON AND OFF

1. Access the vehicle drawer on the touchscreen.
2. Press **SETTINGS**.
3. Press **Vehicle**.
4. Press **Remote Start Setup**.
5. Switch **Last Settings** on or off.

**Note:** If you switch the last settings on, the system remembers the last used settings.

### SWITCHING THE HEATED SEAT SETTINGS ON AND OFF

1. Access the vehicle drawer on the touchscreen.
2. Press **SETTINGS**.
3. Press **Vehicle**.
4. Press **Remote Start Setup**.
5. Press **Seats**.
6. Switch **Auto** on or off.

**Note:** If you switch the heated seat settings on, the heated seats turn on during cold weather.

### SWITCHING THE HEATED STEERING WHEEL SETTINGS ON AND OFF

1. Access the vehicle drawer on the touchscreen.
2. Press **SETTINGS**.
3. Press **Vehicle**.
4. Press **Remote Start Setup**.
5. Press **Seats and Steering Wheel**.
6. Switch **Auto** on or off.

**Note:** If you switch the heated steering wheel settings on, the heated steering wheel turns on during cold weather.

### SETTING THE REMOTE START DURATION

1. Access the vehicle drawer on the touchscreen.
2. Press **SETTINGS**.
3. Press **Vehicle**.
4. Press **Remote Start Setup**.
5. Press **Duration**.

# Climate Control

## IDENTIFYING THE CLIMATE CONTROL UNIT



Use the controls in this area to change the climate inside of your vehicle.

## SWITCHING CLIMATE CONTROL ON AND OFF



Press the button to access the climate controls.



Press the button.

## SWITCHING RECIRCULATED AIR ON AND OFF



Press the button to access the climate controls.



Press the button to recirculate air currently in the passenger compartment.

**Note:** *Recirculated air may turn off automatically, or prevent you from switching on in all air flow modes except MAX A/C to reduce the risk of fogging. Recirculation may also turn on and off automatically in various air distribution control combinations to improve heating or cooling efficiency.*

## SWITCHING AIR CONDITIONING ON AND OFF



Press the button to access the climate controls.



Press the button.

**Note:** *Under certain conditions, the air conditioning compressor could continue to operate after you switch air conditioning off.*

## SWITCHING DEFROST ON AND OFF



Press the button to access the climate controls.



Press the button.

# Climate Control

## SWITCHING MAXIMUM DEFROST ON AND OFF



Press the button.

Air flows through the windshield air vents, and the blower motor adjusts to the highest speed.

You can also use this setting to defog and clear the windshield of a thin covering of ice.

**Note:** There is also a button on the lighting control.

**Note:** To prevent window fogging, you cannot select recirculated air when maximum defrost is on.

**Note:** The heated rear window also turns on when you select maximum defrost.

## SWITCHING MAXIMUM COOLING ON AND OFF



Press the button to access the climate controls.



Press the button.

**Note:** When you switch maximum cooling off, air conditioning remains on.

**Note:** In certain conditions, for example, cold weather, maximum cooling may not activate or could run slow when switched on. This helps reduce power consumption from the battery.

## SWITCHING THE HEATED WIPER PARK ON AND OFF



When you switch the heated rear window on, the heated wiper park also turns on.

## SWITCHING THE HEATED REAR WINDOW ON AND OFF



Press the button to clear the rear window of thin ice and fog. The heated rear window turns off after a short period of time.

**Note:** Do not use harsh chemicals, razor blades or other sharp objects to clean or remove decals from the inside of the heated rear window as this could cause damage to the heated rear window grid lines not covered by the vehicle Warranty.

## SETTING THE BLOWER MOTOR SPEED



Press the button to switch the blower motor on.



Slide the control to set the blower motor speed.

## SWITCHING THE HEATED MIRRORS ON AND OFF

When you switch the heated rear window on, the heated exterior mirrors turn on.

**Note:** Do not remove ice from the mirrors with a scraper or adjust the mirror glass when it is frozen in place.

**Note:** Do not clean the mirror housing or glass with harsh abrasives, fuel or other petroleum-based cleaning products. The vehicle warranty may not cover damage caused to the mirror housing or glass.

## SETTING THE TEMPERATURE

Press the temperature controls on either side of the climate control to set the temperature for that side.

# Climate Control



Slide the control to set the temperature.

## Switching Dual Mode On and Off



Press the button.

**Note:** When dual mode is off, setting the temperature using the driver side controls, sets the temperature for both sides.

**Note:** Setting the temperature using the passenger side controls, sets the passenger temperature and switches dual mode on.

## Switching the Electric Heater On and Off



Press the button to switch the heater on and off. The heater switches on by default.

**Note:** Disabling the heater extends the vehicle's range.

**Note:** This button does not work in some climate control modes.

**Note:** This button does not switch off the climate control system.

**Note:** In certain conditions, for example, warm weather, the electric heater may not activate or could run slow when switched on. This helps reduce power consumption from the battery.

## DIRECTING THE FLOW OF AIR

### Directing Air to the Windshield Air Vents



Press the button on the touchscreen to access the climate controls.



Press the button.

### Directing Air to the Instrument Panel Air Vents



Press the button on the touchscreen to access the climate controls.



Press the button.

### Directing Air to the Footwell Air Vents



Press the button on the touchscreen to access the climate controls.



Press the button.

## AUTO MODE

### SWITCHING AUTO MODE ON AND OFF



Press the button to switch auto mode on. Repeatedly press the button to adjust auto mode.

Adjust the blower motor control or air distribution control to switch auto mode off.

### AUTO MODE INDICATORS

The indicators are on the Auto Mode button.

# Climate Control

Auto Mode Indicator Status	Description
One indicator illuminated.	The blower motor speed is reduced. Use this setting to minimize the amount of noise from the blower motor. This setting increases the time taken to cool the interior.
Two indicators illuminated.	The blower motor speed is moderate.
Three indicators illuminated.	The blower motor speed is increased. Use this setting to reduce the time taken to cool the interior. This setting increases the amount of noise from the blower motor.

## CLIMATE CONTROL HINTS

### General Hints

- Use of the climate system will reduce your vehicles driving range. Conserve battery charge by using climate control features when necessary.
- Prolonged use of recirculated air may cause the windows to fog up.
- You may feel a small amount of air from the footwell air vents regardless of the air distribution setting.
- To reduce humidity build-up inside your vehicle, do not drive with the system switched off or with recirculated air always switched on.
- Remove any snow, ice or leaves from the air intake area at the base of the windshield.
- To improve the time to reach a comfortable temperature in hot weather, drive with the windows open until you feel cold air through the air vents.

### Automatic Climate Control

- Adjusting the settings when your vehicle interior is extremely hot or cold is not necessary. Automatic mode is best recommended to maintain set temperature.
- The system adjusts to heat or cool the interior to the temperature you select as quickly as possible.
- For the system to function efficiently, the instrument panel and side air vents should be fully open.
- If you press **AUTO** during cold outside temperatures, the system directs air flow to the windshield and side window air vents. The blower motor speed may reduce until the air warms.
- If you press **AUTO** during hot temperatures and the inside of the vehicle is hot, the system uses recirculated air to maximize interior cooling. Blower motor speed may also reduce until the air cools.

### Quickly Heating the Interior

1. Press **AUTO**.
2. Adjust the temperature function to the setting you prefer.

# Climate Control

---

## Recommended Settings for Heating

1. Press **AUTO**.
2. Adjust the temperature function to the setting you prefer. Use 72°F (22°C) as a starting point, then adjust the setting as necessary.

## Quickly Cooling the Interior

Press **MAX A/C**.

## Recommended Settings for Cooling

1. Press **AUTO**.
2. Adjust the temperature function to the setting you prefer. Use 72°F (22°C) as a starting point, then adjust the setting as necessary.

## Defogging the Side Windows in Cold Weather

1. Press and release defrost or maximum defrost.
2. Adjust the temperature control to the setting you prefer. Use 72°F (22°C) as a starting point, then adjust the setting as necessary.



# Interior Air Quality

## WHAT IS THE CABIN AIR FILTER

The cabin air filter improves the quality of air in your vehicle by trapping dust, pollen and other particles.

## REPLACING THE CABIN AIR FILTER

Replace the filter at regular intervals. See **Scheduled Maintenance** (page 392).

The cabin air filter is behind the glove compartment.

To remove the lower glove compartment and access the filter:

1. Open the glove compartment.
2. Detach the damper by depressing the tabs and pulling it away from the glove compartment.

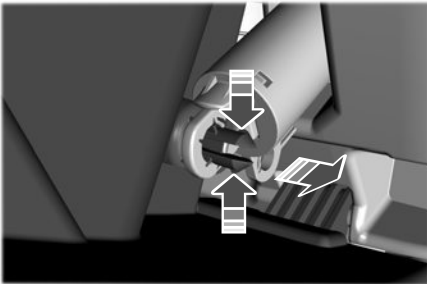

3. Press the tabs on each side to release the glove compartment.

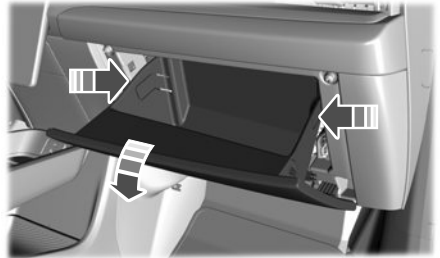

4. Fully lower the glove compartment.
5. Unclip both sides of the filter door and swing door down to access filter.

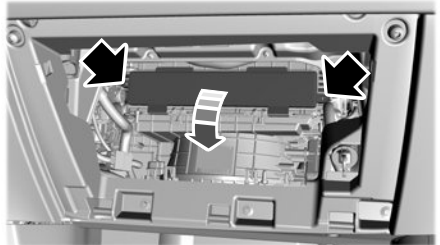

6. Remove the old filter and replace with a new filter.

# Front Seats

## FRONT SEAT PRECAUTIONS



**WARNING:** Sitting improperly, out of position or with the seatback reclined too far can take weight off the seat cushion and affect the decision of the passenger sensing system, resulting in serious injury or death in the event of a crash. Always sit upright against your seat back, with your feet on the floor.



**WARNING:** Do not recline the seat backrest too far as this can cause the occupant to slide under the seatbelt, resulting in personal injury in the event of a crash.



**WARNING:** Do not place objects higher than the top of the seat backrest. Failure to follow this instruction could result in personal injury or death in the event of a sudden stop or crash.



**WARNING:** Do not adjust the driver seat or seat backrest when your vehicle is moving. This may result in sudden seat movement, causing the loss of control of your vehicle.

## SITTING IN THE CORRECT POSITION

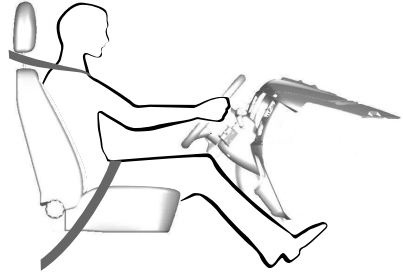

When you use them properly, the seat, head restraint, seatbelt and airbags will provide optimum protection in the event of a crash.

We recommend that you follow these guidelines:

- Sit in an upright position with the base of your spine as far back as possible.
- Do not recline the seat backrest so that your torso is more than 30 degrees from the upright position.
- Adjust the head restraint so that the top of it is level with the top of your head and as far forward as possible. Make sure that you remain comfortable.
- Keep sufficient distance between yourself and the steering wheel. We recommend a minimum of 10 in (25 cm) between your breastbone and the airbag cover.
- Hold the steering wheel with your arms slightly bent.

## Front Seats

- Bend your legs slightly so that you can press the pedals fully.
- Position the shoulder strap of the seatbelt over the center of your shoulder and position the lap strap tightly across your hips.

Make sure that your driving position is comfortable and that you can maintain full control of your vehicle.

### MANUAL SEATS

#### HEADRESTRAINT COMPONENTS

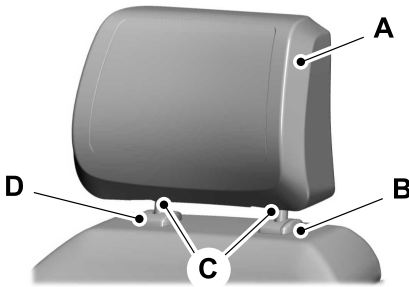

The head restraints consist of:

- A An energy absorbing head restraint.
- B Guide sleeve adjust and release button.
- C Two steel stems.
- D Guide sleeve unlock and remove button (If equipped).

#### ADJUSTING THE HEAD RESTRAINT

**WARNING:** Fully adjust the head restraint before you sit in or operate your vehicle. This will help minimize the risk of neck injury in the event of a crash. Do not adjust the head restraint when your vehicle is moving.

**WARNING:** The head restraint is a safety device. Whenever possible it should be installed and properly adjusted when the seat is occupied. Failure to adjust the head restraint properly could reduce its effectiveness during certain impacts.

**WARNING:** Adjust the head restraints for all passengers before you drive your vehicle. This will help minimize the risk of neck injury in the event of a crash. Do not adjust the head restraints when your vehicle is moving.

**Note:** Adjust the seat backrest to an upright driving position before adjusting the head restraint. Adjust the head restraint so that the top of it is level with the top of your head. Make sure that you remain comfortable. If you are tall, adjust the head restraint to its highest position.

Pull the head restraint up to raise it.

To lower the head restraint:

1. Press and hold the adjust and release button.
2. Push the head restraint down.

The head restraints may tilt for extra comfort. To tilt the head restraint:

## Front Seats



1. Adjust the seat backrest to an upright driving or riding position.
2. Pivot the head restraint forward toward your head to the preferred position.

After the head restraint reaches the forward-most tilt position, pivot it forward again to release it to the rearward, untilted position.

**Note:** Do not attempt to force the head restraint backward after it is tilted. Instead, continue tilting it forward until the head restraint releases to the upright position.

### REMOVING THE HEAD RESTRAINT

1. Pull up the head restraint until it reaches its highest position.
2. Press and hold the adjust and release button and the unlock and remove button.
3. Pull up the head restraint.

### INSTALLING THE HEAD RESTRAINT

Align the steel stems into the guide sleeves and push the head restraint down until it locks.

### MOVING THE SEAT BACKWARD AND FORWARD

**WARNING:** Do not adjust the driver seat or seat backrest when your vehicle is moving. This may result in sudden seat movement, causing the loss of control of your vehicle.

**WARNING:** Make sure the seat fully locks into place by rocking it backward and forward. Not securing the seat into the locked position can be dangerous in a crash and could cause serious personal injury or death.



### ADJUSTING THE SEAT BACKREST

**WARNING:** Reclining the seatback can cause an occupant to slide under the seat's seatbelt, resulting in severe personal injuries in the event of a crash.

# Front Seats



## ADJUSTING THE SEAT HEIGHT (if Equipped)



## POWER SEATS

### HEADRESTRAINT COMPONENTS

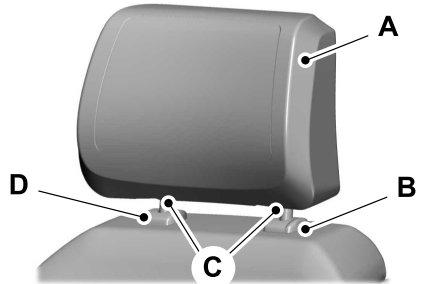

The head restraints consist of:

- A An energy absorbing head restraint.
- B Guide sleeve lock and release button.
- C Two steel stems.
- D Guide sleeve.

### ADJUSTING THE HEAD RESTRAINT -GT, VEHICLES WITH: FRONT FIXED HEADRESTRAINTS



# Front Seats

The non-adjustable head restraints consist of a trimmed foam pad and plastic finish panels covering the upper structure of the seat backrest.

Properly adjust the seat backrest to an upright driving or riding position, so that the head restraint is positioned as close as possible to the back of your head.

## ADJUSTING THE HEAD RESTRAINT - VEHICLES WITH: FRONT ADJUSTABLE HEAD RESTRAINTS



**WARNING:** Fully adjust the head restraint before you sit in or operate your vehicle. This will help minimize the risk of neck injury in the event of a crash. Do not adjust the head restraint when your vehicle is moving.



**WARNING:** The head restraint is a safety device. Whenever possible it should be installed and properly adjusted when the seat is occupied. Failure to adjust the head restraint properly could reduce its effectiveness during certain impacts.



**WARNING:** Adjust the head restraints for all passengers before you drive your vehicle. This will help minimize the risk of neck injury in the event of a crash. Do not adjust the head restraints when your vehicle is moving.

**Note:** *Adjust the seat backrest to an upright driving position before adjusting the head restraint. Adjust the head restraint so that the top of it is level with the top of your head. Make sure that you remain comfortable. If you are tall, adjust the head restraint to its highest position.*

Pull the head restraint up to raise it.

To lower the head restraint:

1. Press and hold the adjust and release button.
2. Push the head restraint down.

The head restraints may tilt for extra comfort. To tilt the head restraint:



1. Adjust the seat backrest to an upright driving or riding position.
2. Pivot the head restraint forward toward your head to the preferred position.

After the head restraint reaches the forward-most tilt position, pivot it forward again to release it to the rearward, untilted position.

**Note:** *Do not attempt to force the head restraint backward after it is tilted. Instead, continue tilting it forward until the head restraint releases to the upright position.*

## REMOVING THE HEAD RESTRAINT

1. Pull up the head restraint until it reaches its highest position.
2. Press and hold the adjust and release button.
3. Pull up the head restraint.

# Front Seats

## INSTALLING THE HEAD RESTRAINT

Align the steel stems into the guide sleeves and push the head restraint down until it locks.

## MOVING THE SEAT BACKWARD AND FORWARD

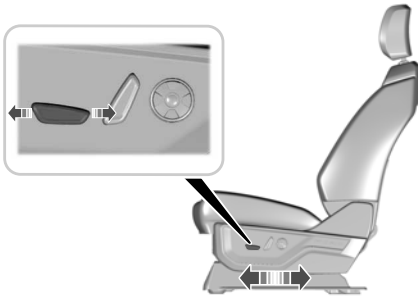

## ADJUSTING THE SEAT BACKREST



## ADJUSTING THE SEAT HEIGHT

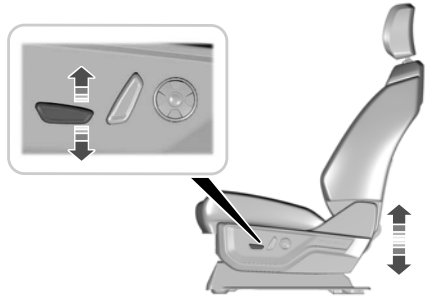

## ADJUSTING THE LUMBAR SUPPORT

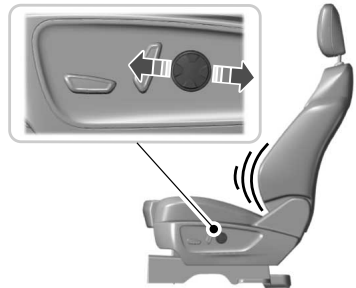

# Front Seats

## HEATED SEATS (IF EQUIPPED)

### HEATED SEAT PRECAUTIONS



**WARNING:** Use caution when using the heated seat if you are unable to feel pain to your skin because of advanced age, chronic illness, diabetes, spinal cord injury, medication, alcohol use, exhaustion or other physical conditions. The heated seat could cause burns even at low temperatures, especially if used for long periods of time. Failure to follow this instruction could result in personal injury.



**WARNING:** Do not poke sharp objects into the seat cushion or seat backrest. This could damage the heated seat element and cause it to overheat. Failure to follow this instruction could result in personal injury.



**WARNING:** Do not place anything on the seat that blocks the heat, for example a seat cover or a cushion. This could cause the seat to overheat. Failure to follow this instruction could result in personal injury.

Press the heated seat symbol, then select your preferred heat level or off. The more indicators that display, the warmer the temperature of the seat.

**Note:** Based on your remote start settings, the heated seats may remain on after you remote start your vehicle. The heated seats may also turn on when you start your vehicle if they were on when you switched your vehicle off.

### Automatic Heated Seats (If Equipped)

When you switch on the auto setting, the heated seats switch on to match your climate control setting.

Do not:

- Place heavy objects on the seat.
- Operate the heated seat if water or any other liquid spills on the seat. Allow the seat to dry.

## SWITCHING THE HEATED SEATS ON AND OFF

The vehicle must be on to use this feature.



# Rear Seats

## MANUAL SEATS

### HEADRESTRAINT COMPONENTS

#### Rear Seat Outermost Head Restraints

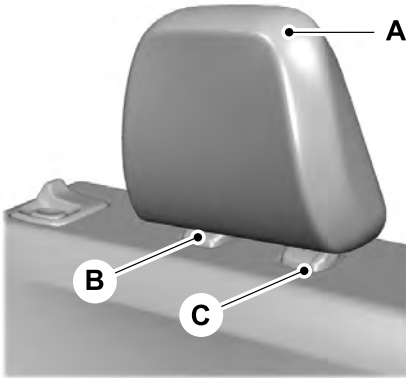

The head restraint consists of:

- A An energy absorbing head restraint.
- B Two steel stems.
- C Guide sleeve adjust and release button.
- D Guide sleeve unlock and remove button (if equipped).

### ADJUSTING THE HEAD RESTRAINT

The outermost head restraints are non-adjustable.

Pull the center head restraint up to raise it.

To lower the center head restraint:

1. Press and hold the unlock and remove button.
2. Push the head restraint down.

The head restraints consist of:

- A An energy absorbing head restraint.
- B Guide sleeve.
- C Locking guide sleeve.

#### Rear Seat Center Head Restraint

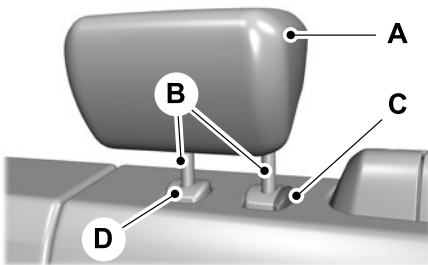

### REMOVING THE HEAD RESTRAINT

1. Fold the seat backrest forward before removing the head restraint.
2. Pull up the head restraint until it reaches its highest position.
3. Press and hold the adjust and release button and the unlock and remove button.
4. Pull up the head restraint.

### INSTALLING THE HEAD RESTRAINT

1. Fold the seat backrest forward before installing the head restraint.
2. Align the steel stems into the guide sleeves and push the head restraint down until it locks.

## Rear Seats

### FOLDING THE SEAT BACKREST



**WARNING:** To prevent possible damage to the seat or seatbelts, make sure that the seatbelts are not fastened before folding the seatback.



**WARNING:** When folding or unfolding the seats, take care not to get your fingers caught between the seat backrest and seat frame. Failure to follow this warning could result in serious personal injury.



Press the button and fold the seat backrest forward.

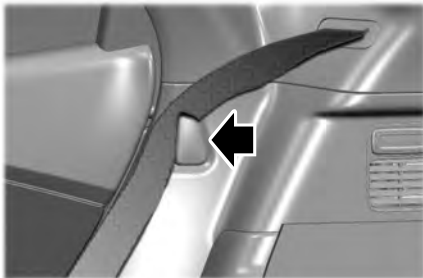

When the rear outermost seat backrests are folded, place the seatbelts in the stowage clip. This prevents the seatbelt from getting caught when the backrest is unfolded.

### UNFOLDING THE SEAT BACKREST



**WARNING:** When unfolding the seat backrests, make sure that the seatbelts are not trapped behind the seat.



**WARNING:** Make sure that the seats and the seat backrests are secure and fully locked in their catches.

Lift the seat backrest up to unfold it. Make sure the seat latch engages.

# Rear Occupant Alert System (If Equipped)

## WHAT IS THE REAR OCCUPANT ALERT SYSTEM

The rear occupant alert system monitors vehicle conditions and notifies you to check for rear seat occupants when you switch the ignition off.

## HOW DOES THE REAR OCCUPANT ALERT SYSTEM WORK

The system monitors when rear doors have been opened and closed to indicate the potential presence of an occupant in the rear seat.

A message displays in the information and entertainment display screen and an audible warning sounds when you switch the ignition off after any of the following conditions have been met:

- A rear door is opened or closed while the ignition is on.
- You switch the ignition on within 15 minutes of a rear door opening and closing.
- You switch the ignition on within 15 minutes of the alert having displayed or sounded.

## REAR OCCUPANT ALERT SYSTEM PRECAUTIONS



**WARNING:** On hot days, the temperature inside the vehicle can rise very quickly. Exposure of people or animals to these high temperatures for even a short time can cause death or serious heat related injuries, including brain damage. Small children are particularly at risk.



**WARNING:** Do not leave children or pets unattended in your vehicle. Failure to follow this instruction could result in personal injury or death.

## REAR OCCUPANT ALERT SYSTEM LIMITATIONS

The system does not detect the presence of objects or passengers in the rear seat. It monitors when rear doors are opened and closed.

**Note:** *It is possible to receive an alert when there is no rear seat occupant, but alert conditions are met.*

**Note:** *It is possible to receive no alert when there is an occupant in the rear seat, if alert conditions are not met. For example, if a rear seat occupant does not enter the vehicle through a rear door.*

**Note:** *The audible warning does not sound when the front door is opened before you switch the ignition off.*

## SWITCHING REAR OCCUPANT ALERT SYSTEM ON AND OFF

1. Access the vehicle drawer on the touchscreen.
2. Press **SETTINGS**.
3. Press **Vehicle**.
4. Switch **Rear Occupant Alert** on or off.

**Note:** *The default setting is on.*

**Note:** *Performing a master reset causes the system to switch on again.*

## Rear Occupant Alert System (If Equipped)

### Semiannual Reminder (If Equipped)

When you switch the system off, a message appears every six months as a reminder that the system is off. You can switch the system back on or leave it off.

The warning sounds for a short period of time.

## REAR OCCUPANT ALERT SYSTEM INDICATORS

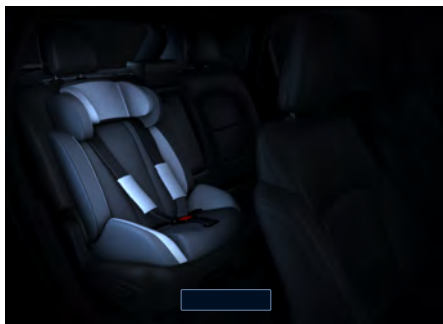

Message
Check rear seats for occupants.

Displays when you switch your vehicle off after the alert conditions are met.

The message displays for a short period of time. Press **Close** to acknowledge and remove the message.

**Note:** Depending on your SYNC version, the graphic may look different from what you see here.

## REAR OCCUPANT ALERT SYSTEM AUDIBLE WARNINGS

Sounds when you switch your vehicle off after the alert conditions are met.

# Memory Function (If Equipped)

## WHAT IS THE MEMORY FUNCTION

The memory function recalls the position of these features:

- Driver seat.
- Power mirrors.

## MEMORY FUNCTION PRECAUTIONS



**WARNING:** Before activating the memory seat, make sure that the area immediately surrounding the seat is clear of obstructions and that all occupants are clear of moving parts.



**WARNING:** Do not use the memory function when your vehicle is moving.

## LOCATING THE MEMORY FUNCTION BUTTONS



The memory function buttons are on the driver door.

## SAVING A PRESET POSITION

1. Switch the vehicle on.
2. Adjust the memory features to your preferred position.
3. Press and hold the preferred preset button until you hear a single tone.

A confirmation message appears in the information display.

You can save up to three preset memory positions at any time.

## RECALLING A PRESET POSITION

Press and release a preset button.

**Note:** You can recall a preset memory position when the vehicle is off, or when you place the transmission in park (P) or neutral (N) if the vehicle is on and it is not moving.

**Note:** Pressing any of the preset buttons during a memory recall cancels the operation.

You can also recall a preset memory position by:

- Pressing the unlock button on your remote control if you linked it to a preset position.
- Unlocking the intelligent driver door handle if a linked remote control is present.

Using a linked remote control to recall your memory position when the vehicle is off moves the seat and steering column to the easy entry position.

## Linking a Preset Position to your Remote Control or Passive Key

See **Linking or Unlinking a Personal Profile to a Remote Control** (page 383).

# Garage Door Opener

## WHAT IS THE GARAGE DOOR OPENER

### HomeLink Wireless Control System



The universal garage door opener replaces the common hand-held garage door opener with a three-button transmitter integrated into the driver's sun visor.

## HOW DOES THE GARAGE DOOR OPENER WORK

The system includes two primary features, a garage door opener and a platform for remote activation of devices within the home. You can program garage doors as well as entry gate operators, security systems, entry door locks and home or office lighting.

Additional system information can be found online at [www.homelink.com](http://www.homelink.com) or by calling the toll-free help line at 1-800-355-3515.

**Note:** *You can program a maximum of three devices. To change or replace any of the three devices after it has been initially programmed, you must first erase the current settings. See **Clearing the Garage Door Opener** (page 148).*

## GARAGE DOOR OPENER PRECAUTIONS



**WARNING:** Do not use the system with any garage door opener that does not have the safety stop and reverse feature as required by U.S. Federal Safety Standards (this includes any garage door opener manufactured before April 1, 1982). A garage door opener which cannot detect an object, signaling the door to stop and reverse, does not meet current federal safety standards. Using a garage door opener without these features increases the risk of serious injury or death.

**Note:** *Make sure that the garage door and security device are free from obstruction when you are programming. Do not program the system with your vehicle in the garage.*

**Note:** *Make sure you keep the original remote control transmitter for use in other vehicles as well as for future system programming.*

**Note:** *We recommend that upon the sale or lease termination of your vehicle, you erase the programmed function buttons for security reasons. See **Clearing the Garage Door Opener** (page 148).*

## GARAGE DOOR OPENER LIMITATIONS

Canadian radio-frequency laws require transmitter signals to time-out (or quit) after several seconds – which may not be long enough for HomeLink to pick up the signal.

U.S. gate operators time-out in the same manner.

# Garage Door Opener

**Note:** If programming a garage door opener or gate operator, it is advised to unplug the device during the “cycling” process to prevent possible overheating.

## PROGRAMMING THE GARAGE DOOR OPENER TO YOUR HAND-HELD TRANSMITTER

This process is to program your in-vehicle HomeLink function button with your hand-held transmitter.

**Note:** The programming steps below assume you will be programming HomeLink that was not previously programmed. If your HomeLink was previously programmed, you may need to erase your HomeLink buttons. See **Clearing the Garage Door Opener** (page 148).



1. With your vehicle parked outside of the garage, switch your vehicle on, but do not start your vehicle.
2. Press and release one of the three HomeLink function buttons that you would like to program.
3. Hold your hand-held garage door transmitter 1–3 in (2–8 cm) away from the HomeLink button you want to program.

4. Press and hold the hand-held transmitter button you want to program while watching the indicator light on HomeLink. Continue to hold the hand-held button until the HomeLink indicator light flashes rapidly or is continuously on.

**Note:** You may need to use a different method if you live in Canada or have difficulties programming your gate operator or garage door opener. See **Programming the Garage Door Opener to Your Gate Opener Motor** (page 148).

5. Press and hold the HomeLink button you programmed for two seconds, then release. You may need to do this twice to activate the door.

**Note:** If the indicator light stays on, the programming is complete.

**Note:** If the HomeLink indicator flashes rapidly, repeat Step 5.

**Note:** If your device still does not operate, you must program your garage door. See **Programming the Garage Door Opener to Your Garage Door Opener Motor** (page 147).

6. To program additional buttons, repeat Steps 1 – 4.

## PROGRAMMING THE GARAGE DOOR OPENER TO YOUR GARAGE DOOR OPENER MOTOR



# Garage Door Opener

1. Press the learn button on the garage door opener motor, you have 30 seconds to complete the next two steps.
2. Return to your vehicle.



3. Press and hold one of the three HomeLink function buttons you want to program for two seconds, then release. Repeat this step. Depending on your brand of garage door opener, you may need to repeat this sequence a third time.

## PROGRAMMING THE GARAGE DOOR OPENER TO YOUR GATE OPENER MOTOR

### Gate Operator / Canadian Programming

Canadian radio-frequency laws require transmitter signals to “time-out” (or quit) after several seconds of transmission – which may not be long enough for HomeLink to pick up the signal during programming. Similar to this Canadian law, some U.S. gate operators “time-out” in the same manner.

**Note:** *If programming a garage door opener or gate operator, it is advised to unplug the device during the “cycling” process to prevent possible overheating.*

1. Press and release, every two seconds, your hand-held transmitter until the HomeLink indicator light changes to a rapidly blinking or continuously on light.
2. Release the hand-held transmitter button.
3. Press and hold the HomeLink function button you want to program for two seconds, then release. You may need to do this twice to activate the door.

**Note:** *If the indicator light stays on, the programming is complete.*

**Note:** *If the HomeLink indicator flashes rapidly, repeat Step 3.*

**Note:** *If your device still does not operate, you must program your garage door. See **Programming the Garage Door Opener to Your Garage Door Opener Motor** (page 147).*

4. To program additional buttons, repeat Steps 1 – 4.

## CLEARING THE GARAGE DOOR OPENER

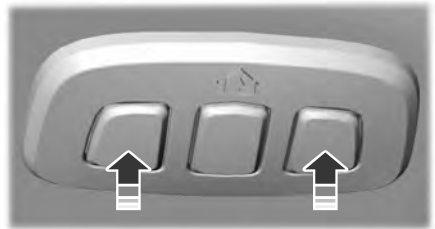

1. Press and hold the outer two function buttons simultaneously for approximately 10 seconds until the indicator light above the buttons flashes rapidly.



# Garage Door Opener

---

2. When the indicator light flashes, release the buttons.

**Note:** *You cannot erase individual buttons.*

## REPROGRAMMING THE GARAGE DOOR OPENER

To program a device to a previously trained button, follow these steps:

1. Press and hold the desired button. Do NOT release the button.
2. The indicator light begins to flash after 20 seconds. Without releasing the button, follow programming steps.

## GARAGE DOOR OPENER RADIO FREQUENCIES

### FCC and RSS-210 Industry Canada Compliance



**WARNING:** Changes or modifications not expressly approved by the party responsible for compliance could void the user's authority to operate the equipment. The term "IC:" before the radio certification number only signifies that Industry Canada technical specifications were met.

This device complies with Part 15 of the FCC Rules and with RSS-210 of Industry Canada. Operation is subject to the following two conditions: (1) this device may not cause harmful interference, and (2) this device must accept any interference received, including interference that could cause undesired operation.

This equipment complies with FCC radiation exposure limits set forth for an uncontrolled environment. End Users must follow the specific operating instructions for satisfying RF exposure compliance. This transmitter must be at least 8 in (20 cm) from the user and must not be co-located or operating in conjunction with any other antenna or transmitter.

# USB Ports

## LOCATING THE USB PORTS

### USB A



### USB C



### Data Transfer USB Ports



The USB ports are in the following locations:

- On the lower instrument panel.
- Inside the media bin.
- Inside the center console.

**Note:** *These USB ports can also charge devices.*

**Note:** *Not all USB ports in your vehicle have data transfer capabilities.*

**Note:** *We recommend using only USB-IF certified cables and adapters. Non-certified cables and adapters may not work.*

### Charge Only USB Ports



The USB ports are in the following locations:

- Inside the media bin below the instrument panel.
- Inside the center console.
- On the rear of the center console.
- In the cargo area.

## PLAYING MEDIA USING THE USB PORT



**WARNING:** Driving while distracted can result in loss of vehicle control, crash and injury. We strongly recommend that you use extreme caution when using any device that may take your focus off the road. Your primary responsibility is the safe operation of your vehicle. We recommend against the use of any hand-held device while driving and encourage the use of voice-operated systems when possible. Make sure you are aware of all applicable local laws that may affect the use of electronic devices while driving.

Connect your device to the USB port.



Press the audio button on the feature bar.

Select **Sources**.

# USB Ports

---



Select the USB option.



Press the button to play a track.  
Press the button again to pause the track.



Press the button to skip to the next track.

Press and hold the button to fast forward through the track.



Press the button once to return to the beginning of a track.  
Repeatedly press the button to return to previous tracks.

Press and hold the button to fast rewind.

## CHARGING A DEVICE

Connect your device to the USB port.

### Data Transfer USB Ports



You can charge your device through the data transfer USB port when SYNC is on.

### Charge Only USB Ports



You can charge your device through the charge only USB port when the vehicle is in accessory mode or when the vehicle is running.

# Power Outlet

---

## WHAT IS THE POWER OUTLET

The power outlet can power devices using a 12 V outlet adapter.

## POWER OUTLET PRECAUTIONS

When you switch the vehicle on, you can use the socket to power 12 V appliances with a maximum current rating of 20 A. Do not use the power point over the vehicle capacity of 12 V DC 240 W or a fuse could blow. Do not plug in any device that supplies power to the vehicle through the power points. This could result in damage to vehicle systems. Do not hang any accessory from the accessory plug. Always keep the power point caps closed when not in use. Do not insert objects other than an accessory plug into the power point.

To prevent the battery from running out of charge:

- Do not use the power point longer than necessary when the vehicle is off.
- Do not leave devices plugged in overnight or when you park your vehicle for extended periods.

## LOCATING THE POWER OUTLETS

Power outlets are in the following locations:

- In the media bin below the instrument panel.
- Inside the main center console bin.
- On the rear of the main center console bin.
- In the cargo area.

# Wireless Accessory Charger

## WHAT IS THE WIRELESS ACCESSORY CHARGER

The wireless accessory charger allows you to charge one compatible Qi wireless charging device on the charging area.

## WIRELESS ACCESSORY CHARGER PRECAUTIONS



**WARNING:** Wireless charging devices can affect the operation of implanted medical devices, including cardiac pacemakers. If you have any implanted medical devices, we recommend that you consult with your physician.

Keep the charging area clean and remove foreign objects prior to charging a device.

Do not place items with a magnetic strip or radio-frequency identification chip, for example passports, parking tickets, transportation passes or credit cards, near the charging area when charging a device. Damage could occur to the magnetic strip or radio-frequency identification chip.

Do not place metal objects, for example remote controls, coins and candy wrappers, on or near the charging area when charging a device. Metal objects may heat up and degrade the charging performance, in addition to causing interruptions in charging.

Charging could be interrupted, degraded, or could stop if any of the following occur:

- The system detects a foreign object.
- The device is misaligned on the charging area.
- The device moves on the active charging area when the vehicle is in motion.

- The vehicle ambient temperature is too high.
- You attempt to charge a non-Qi compatible device on the wireless charger.

**Note:** *During charging, the device and the charger could heat up, this is normal. If the battery gets hotter than usual, the device may stop charging.*

## LOCATING THE WIRELESS ACCESSORY CHARGER



The charging area is in the front console below the instrument panel.

## CHARGING A WIRELESS DEVICE

Place the device on the center of the charging surface with the charging side down. The charging stops after your device reaches a full charge.

You can use the charger when the vehicle is in accessory mode, when the vehicle is running, or when SYNC is on.



Displays on the status bar when wireless charging is in progress.

**Note:** *The charging performance may be affected if your device is in a case. It may be necessary to remove the case to wirelessly charge your device.*

**Note:** *Software and firmware updates may affect device compatibility, including the use of unofficial software or firmware. You should verify charging functionality with your specific devices in-vehicle.*

# Storage

## CUP HOLDERS

### CUP HOLDER PRECAUTIONS



**WARNING:** Use caution when stowing items or hot drinks in the cup holders. Items could become loose or spill during hard braking, acceleration or crashes. Failure to follow this instruction could result in personal injury.

## GLOVE COMPARTMENT

### OPENING THE GLOVE COMPARTMENT

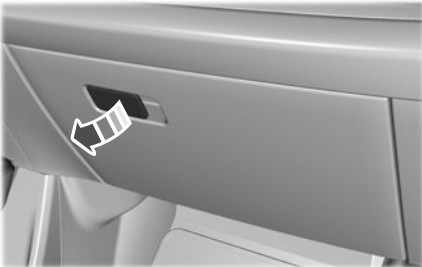

Pull the latch to the left to open the glove compartment.

## GLASSES HOLDER

### LOCATING THE GLASSES HOLDER

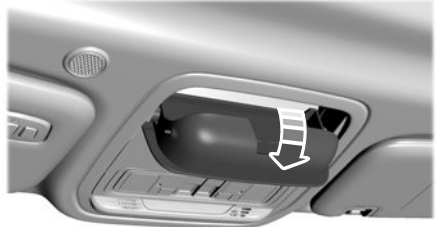

The glasses holder is in the overhead console.

Press near the rear edge of the door to open it.

# Starting and Powering Off

## STARTING AND POWERING OFF PRECAUTIONS

- The system may not function if the remote control is close to metal objects or electronic devices, for example, keys or a cell phone.
- A valid remote control must be inside your vehicle to switch the power on and start your vehicle.
- Remote controls left inside your vehicle when locked are disabled. A message may appear in the information display indicating that there is no key detected when you try to start your vehicle. Press the unlock button on the remote control to enable it, and then start your vehicle.
- Make sure all occupants fasten their seat belt.
- Make sure the headlamps and electrical accessories are off.
- Make sure the parking brake is on.
- Make sure the transmission is in park (P).

## STARTING THE VEHICLE

1. Fully press the brake pedal.

**Note:** Do not touch the accelerator pedal.



2. Press the push button start.

You can also start your vehicle using Valet Mode or a Backup Start Passcode. See **Phone as a Key** (page 69).

## POWERING OFF

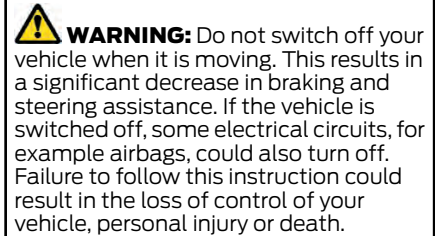

**Note:** If you unintentionally switch your vehicle off, shift into neutral (N) and restart your vehicle.

When your vehicle is not moving and is started, or the power is in accessory mode, press and release the push button start without pressing the brake pedal. This shuts off the vehicle and all electrical accessories.

When your vehicle is moving, press the push button start three times within two seconds, or press and hold for at least one second. Shift into neutral (N) and use the brakes to bring your vehicle to a safe stop. When your vehicle comes to a complete stop, shift into park (P).

## RESTARTING THE VEHICLE AFTER POWERING OFF

### Fast Restart

The fast restart feature allows you to restart your vehicle within 10 seconds of switching it off, even if it does not detect a valid remote control.

## Starting and Powering Off

Within 10 seconds of switching your vehicle off, press the brake pedal and press the push button start. After 10 seconds, you can no longer start your vehicle if it does not detect a valid remote control.

Once your vehicle starts, it remains on until you press the push button start, even if it does not detect a valid remote control.

If you open and close a door while your vehicle is on, the system searches for a valid remote control. You cannot start your vehicle if the system does not detect a valid remote control within 10 seconds.

### ACCESSING THE PASSIVE KEY BACKUP POSITION

If you are unable to start your vehicle, follow the steps below.

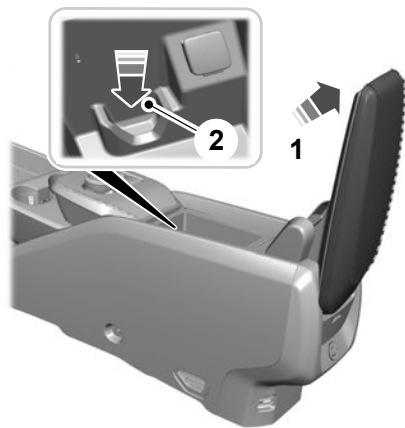

1. Open the floor console storage compartment lid.
2. Place the remote control in the slot as shown with the buttons facing upward.

3. With the remote control in this position, press the brake pedal, then press the push button start to switch the power on and start your vehicle.

### STARTING AND POWERING OFF – TROUBLESHOOTING

#### STARTING AND POWERING OFF – FREQUENTLY ASKED QUESTIONS

##### Why does the vehicle not start?

The system does not function if the remote control frequencies are jammed, or if the remote control battery has no charge. See **Accessing the Passive Key Backup Position** (page 156).



# High Voltage Battery

## WHAT IS THE HIGH VOLTAGE BATTERY

The high voltage battery is a highly sophisticated lithium ion battery system, used to store electrified energy to power the vehicle.

## HIGH VOLTAGE BATTERY PRECAUTIONS



**WARNING:** This battery pack should only be serviced by an authorized electric vehicle technician. Improper handling can result in personal injury or death.



**WARNING:** Keep your hands and clothing clear of the cooling fan.

Your vehicle consists of various high-voltage components and wiring. All of the high-voltage power flows through specific wiring assemblies labeled as such or covered with a solid orange convolute, or orange striped tape, or both. Do not come in contact with these components.

## PRESERVING YOUR HIGH VOLTAGE BATTERY

When using the battery at a low state of charge, your vehicle could start disabling accessory features to protect battery life.

If your vehicle reaches a 0% state of charge, recharge your vehicle as soon as possible.

In everyday use it is acceptable to use the full state of charge window, however there are a few best practices we recommend in order to maintain the health and life of your battery.

## Overnight Charging

You can increase the longevity and performance of your high voltage battery by using the charge scheduling and departure and comfort settings on your touchscreen or in the FordPass app.

With Charge Scheduling you can improve the high voltage battery's longevity by delaying the start of charging and setting a maximum charging limit. It is recommended to set your preferred charging times to be at least 2-3 hours after your typical plug in time. This allows the battery to cool before charging begins. Additionally, setting the maximum charge level to 90% for everyday usage reduces strain on the battery.

You can improve driving range and performance by scheduling departure times and cabin comfort level with the Departure and Comfort feature. This will not only warm or cool the cabin but also condition the battery to ensure best driving range and performance by the set departure time.

## DC Charging

Frequent use of DC charging could result in reducing your battery's efficiency and lifespan. This is more pronounced on the standard range battery pack versus the extended range battery pack. See **What is DC Charging** (page 159).

## Storage Temperature

Storing your vehicle in temperatures between 32°F (0°C) and 113°F (45°C) is the most beneficial for the high voltage battery.

At temperatures just above the freezing point or lower, your vehicle should be plugged in to maintain battery performance and maximize driving range.

# High Voltage Battery

---

## Storage State of Charge

You can increase the battery life by maintaining the state of charge below 100%. When you park your vehicle for an extended period of 30 days or more, we recommend the battery state of charge be at approximately 50%. Storing your vehicle's high voltage battery at higher states of charge is less favorable than storing at lower states of charge.

**Note:** *To achieve this state of charge for storage, you can drive your vehicle down to 50% and set a charge limit for your location. See **Setting the Charging Schedule and Preferences** (page 174).*

## RECYCLING AND DISPOSING OF THE HIGH VOLTAGE BATTERY

Please recycle in accordance with local regulations.

## HIGH VOLTAGE BATTERY – TROUBLESHOOTING

### HIGH VOLTAGE BATTERY – WARNING LAMPS



Illuminates when the powertrain requires service. Have the system checked as soon as possible.

# Charging Your Vehicle

## WHAT IS AC CHARGING

AC charging is the preferred method of charging. AC charging preserves the health of the high voltage battery for longer high voltage battery life.

## WHAT IS DC CHARGING

DC charging allows you to charge the vehicle's high voltage battery in significantly less time than the standard charge method. You can charge on the go before the battery has exhausted all of its power, or when traveling using the trip planner as part of your FordPass App.

For the convenience of DC charging and time, there is a different fee structure depending on the charging station and network you choose.

**Note:** *Charge times could vary depending on ambient air temperature, power level, charger type, and location in which you are charging.*

**Note:** *The DC charging rate could be reduced to maximize the life of the battery.*

## CHARGING YOUR VEHICLE PRECAUTIONS

 **WARNING:** Do not allow charging equipment to be immersed in water or liquids. Failure to follow this warning could result in fire, serious personal injury or death.

 **WARNING:** Do not attempt to open the charging equipment. Failure to follow this instruction could result in personal injury, death or property damage.

 **WARNING:** Do not use the charging equipment if it is faulty or has been damaged. Failure to follow this instruction could result in personal injury, death or property damage.

 **WARNING:** Install charging equipment in compliance with local regulations. Failure to follow this warning could result in fire, serious personal injury or death.

## CHARGING EQUIPMENT

 **WARNING:** Do not use an ungrounded wall outlet. The wall outlet must be in good condition and meet up-to-date local codes. Have a qualified electrician check the wall outlet, if you suspect that it is not properly grounded. Failure to follow this instruction could result in electric shock, personal injury, or death.

 **WARNING:** It is recommended that electrical outlets for use with your charging equipment be installed by a licensed, qualified electrician. Installations must comply with the provisions of all local codes. Failure to follow this warning could result in personal injury or death.

 **WARNING:** Do NOT DROP the control box or coupler.

 **WARNING:** Do NOT use if stored outside temperature range specified.

 **WARNING:** Do not attempt to repair the charging equipment. Contact your local dealer for assistance.

# Charging Your Vehicle

 **WARNING:** Read all warnings on the charging equipment before using for the first time.

 **WARNING:** Read all instructions in this publication before using the charging equipment.

 **WARNING:** To reduce the risk of fire, connect only to a circuit provided with 40 amps maximum branch circuit overcurrent protection installed in accordance with NEC and local electrical code.

 **WARNING:** Do not use the charging equipment with an extension cord, surge protector, timer or other adapter. Failure to follow this instruction could result in electric shock or fire.

 **WARNING:** The wall plug must fit firmly into the outlet. If the connection feels loose, worn or the outlet is damaged, have a qualified electrician replace the outlet. Using charging equipment with a worn outlet may cause burns, property damage and increase the risk of electric shock.

 **WARNING:** Fully insert the plug into the wall outlet. Failure to follow this instruction could result in electric shock.

 **WARNING:** Children should be supervised when in the vicinity of the charging equipment while plugged in.

 **WARNING:** Do not put fingers into the electric charge coupler. Failure to follow this instruction could result in electric shock.

 **WARNING:** This equipment has arcing or sparking parts. Do not expose to flammable vapors. Position this equipment at least 18 in (450 mm) above the floor.

 **WARNING:** Do not connect or disconnect any pluggable components of the charging equipment when in use or charging. Failure to follow this instruction can cause damage to the charging equipment.

 **WARNING:** Do not use the charging equipment in temperatures outside of the operation range of -22°F (-30°C) to 122°F (50°C).

 **WARNING:** Store the charging equipment in a clean dry place between the temperatures of -22°F (-30°C) to 185°F (85°C).

 **WARNING:** Do not plug the charging equipment into an electrical outlet that is submerged in water or covered in snow.

 **WARNING:** Do not use charging equipment in severe rain, snow or electrical storm.

 **WARNING:** Do not allow charging equipment to be immersed in water or liquids. Failure to follow this warning could result in fire, electric shock, or serious personal injury or death.

 **WARNING:** When using the charging equipment avoid moisture, water, snow and foreign objects at all times.

## Charging Your Vehicle



**WARNING:** Do not replace the plug on the connector. There are critical safety devices in the plug, and the charging equipment will not operate, if the plug is replaced. Failure to follow this instruction could result in electric shock, personal injury, death, or fire.



**WARNING:** Charging equipment contains no user modifiable or repairable parts. If the charging equipment plug does not properly fit into the wall outlet, have a qualified electrician install the correct wall outlet. Failure to follow this instruction could result in personal injury or death.



**WARNING:** High voltage is present in your electric meter housing and power distribution service panel. Contact with high voltage can cause death or serious personal injury.



**WARNING:** Visually inspect the charging equipment before each use. Do not use the charging equipment if it is damaged.



**WARNING:** Keep charging equipment inside when not in use. Stow the control box on the hanger or all the charging equipment in the bag after use to prevent damage to the charging equipment and personal injury.

Specification Type	Specification Value
Charger Model	SAE
Voltage	120-240 VAC
Maximum Current	32 amps max continuous
Frequency	60Hz
Power draw when idle	< 2 Watts
Power draw when charging	< 4 Watts
Cable length	Approximately 20 ft (6.1 m)
Weight	8.6 lb (3.9 kg)
Operating temperature	-22°F (-30°C) to 122°F (50°C)
Storage temperature	-22°F (-30°C) to 185°F (85°C)
CCID Environmental	IP67
Ventilation	Not required

Your vehicle comes with a mobile charger that has a low power connector to use with a 120V plug NEMA 5-15 and a high power connector to use with a 240V plug NEMA 14-50.

# Charging Your Vehicle

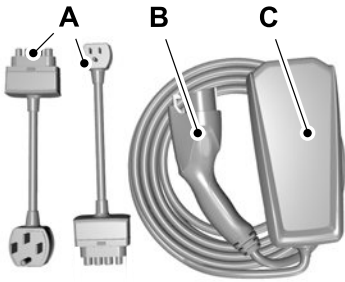

- A Connector.
- B Coupler.
- C Control Box.

The mobile charger is in the rear luggage compartment under the load floor and allows you to charge the vehicle's battery using a standard household outlet.

You must plug the connector into the control box first. Then plug the connector into the household outlet, and then plug the coupler into the vehicle charge port.

The power indicator illuminates blue when the connector is properly inserted into the control box and dedicated wall outlet.

**Note:** To insert the connector, firmly grasp the connector by the cable or plug and push into the control box until an audible click is heard. Make sure the connector is fully inserted and flush with the control box before inserting it into the outlet. Improper insertion will cause a longer charge session.

**Note:** Follow the installation instructions provided with the mobile charger.

**Note:** We recommend using the supplied plugs and connectors.

**Note:** If you do not use a dedicated circuit, the circuit breaker could trip or open. If a dedicated circuit is not available, contact a licensed professional electrician regarding the installation of a dedicated outlet.

**Note:** The mobile charger does not charge and gives a fault indication, if ground is not present.

**Note:** Plug the connector for the mobile charger directly into the wall plug receptacle. Do not plug the mobile charger into any form of extension cord.

**Note:** If the wall bracket is not used for mounting the charging equipment, plug the charging equipment into an outlet closer to ground.

## Mobile Charger Indicator Lights

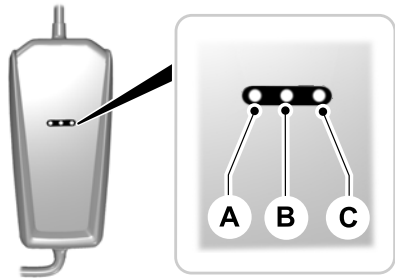

- A Amber Fault Indicator Light.
- B Blue Status Indicator Light.
- C Red Trouble Indicator Light.

## Charging Your Vehicle

Mobile Charger Fault Indicator Type	Indicator Description
AMBER	The amber fault indicator illuminates to communicate that the charger is rebooting after an error.
BLUE	When plugged into the wall outlet, the blue indicator illuminates to communicate that the charger is ready to use.
RED	The red indicator illuminates when the charger has

Mobile Charger Fault Indicator Type	Indicator Description
	detected an error. If the red indicator is illuminated, the charger will not deliver power to the vehicle. The error must be corrected before a charging cycle can begin or continue.

**Note:** When first plugged into a wall outlet the amber, blue and red indicators will blink once. Then the blue indicator turns on, followed by a blink of the red indicator. After, the blue indicator turns off then back on. This cycle will happen twice if a different connector is used from a previous charge.

AMBER	BLUE	RED	MODE	ACTION
OFF	OFF	OFF	UNPOWERED: The mobile charger is not powered.	Make sure the outlet is operational, and the circuit breaker is in the ON position or try using another outlet. Ensure the connector is fully inserted into mobile

## Charging Your Vehicle

AMBER	BLUE	RED	MODE	ACTION
				charger. Ensure the plug is not severely degraded. If the error persists, contact us.
OFF	PULSING	OFF	CHARGING; The mobile charger is charging.	No action required.
OFF	ON	OFF	STANDBY; The mobile charger is powered and ready to charge. At the current time the mobile charger is not charging the vehicle.	If you expect the mobile charger to be charging the vehicle, make sure the vehicle coupler is properly inserted into the vehicle. Check and adjust your charging time preferences in the on screen display. If your vehicle is still not charging, contact us.
ON	ON	ON	REBOOTING; The mobile charger is recovering after encountering an error.	Wait for the mobile charger to return to standby. If the mobile charger cycles for more than 2-3 minutes, unplug the vehicle coupler. Unplug and replug in the connector. If the issue persists, contact us.



## Charging Your Vehicle

AMBER	BLUE	RED	MODE	ACTION
ON	PULSING	OFF	CHARGING REDUCED; The mobile charger is charging at a reduced rate due to overheating.	Make sure the connector and the control box are properly connected. Unplug and replug in the connector. If the mobile charger is warm or in a hot environment, try charging in a cooler area. Try a different outlet. Try a different connector if you have one available. If the error persists, contact us.
1 FLASH	PULSING	OFF	CHARGING REDUCED, AC PLUG OR WALL OUTLET; The mobile charger is charging at a reduced rate due to overheating of the connector or the wall outlet.	Make sure the connector and control box are properly connected. Unplug and replug in the connector. If the mobile charger is warm or in a hot environment, try charging in a cooler area. Try a different outlet. Try a different connector if you have one available. If the error persists, contact us.

## Charging Your Vehicle

<b>AMBER</b>	<b>BLUE</b>	<b>RED</b>	<b>MODE</b>	<b>ACTION</b>
ON	OFF	OFF	<p>USER TROUBLESHOOTING; The mobile charger has encountered a fault that requires troubleshooting.</p>	<p>Make sure the connector and control box are properly connected. Unplug and replug in the connector. If the mobile charger is warm or in a hot environment, try charging in a cooler area. Try a different outlet. Try a different connector if you have one available. If the error persists, contact us.</p>
OFF	OFF	ON	<p>NON - RECOVERABLE FAULT; There is an internal fault in the mobile charger that cannot be recovered.</p>	<p>Try a different connector if you have one available. If error persists, contact us.</p>
OFF	OFF	1 FLASH	<p>NON - RECOVERABLE FAULT; There is an internal fault in the connector that cannot be recovered.</p>	<p>Try using another connector if you have one available. If not, contact us about obtaining a replacement.</p>

## Charging Your Vehicle

AMBER	BLUE	RED	MODE	ACTION
				If your warranty has expired, you can order a replacement from your Ford dealer.
OFF	OFF	PULSING	GROUND LEAKAGE FAULT; Electrical current is leaking through a potentially unsafe path.	Potential shock hazard - immediately turn off circuit breaker for the outlet within home. Discontinue use. Contact us about obtaining a replacement.

**Note:** When plugging into an unfamiliar wall outlet, let the vehicle charge for several minutes before leaving it unattended. The red indicator will illuminate if not charging. The unit will turn off if breaker or infrastructure ground fault circuit interrupter (GFCI) is tripped. You can view vehicle charging status remotely via the Ford Pass App.

### Mobile Charger Auto-Restart

Auto-restart helps to make sure that your vehicle will be charged and ready for use when needed. A charge could be interrupted if errors are detected. Charging resumes once the error is no longer detected. The red indicator illuminates during an error condition.

The exception to the immediate auto-restart is when the interruption is due to a charger ground fault circuit interrupter (GFCI) event. The charger attempts to restart 15 minutes after a ground fault circuit interrupter (GFCI) event. After the fourth attempt to restart, the charger shuts down and the red indicator stays on.

If the fault persists, do not continue to try to charge your vehicle. Contact your authorized dealer.

### MOVING AND STORAGE INSTRUCTIONS

Make sure you wrap the mobile charger after charging. Store the mobile charger in the storage bag supplied with the mobile charger.

When charging is complete, replace the mobile charger in the rear luggage compartment, under the load floor.

**Note:** Do not hold the mobile charger by the power cable. Hold the complete unit and carefully place back in the storage bag.

**Note:** To remove the connector, firmly grasp the connector by the cable or plug and pull away from the control box.

# Charging Your Vehicle

## CARE INSTRUCTIONS

Do not use cleaners or solvents as this could damage your mobile charger. Do not place stress on the charger cables. If unit overheats, remove the mobile charger from direct sunlight.

## SAFETY FEATURES

The charger includes the following safety features to protect against the risk of electric shock:

- **Service Ground Check:** The charger constantly checks for the presence of a service ground connection. If the service ground ever fails, the charger red indicator turns ON and shuts down power to the vehicle.
- **Thermal Event Sensor:** Charger module senses out-of-ordinary thermal events and decreases the charging current or shuts the unit down if required.
- **Ground fault circuit interrupter (GFCI) Protection:** The charger has a ground fault circuit interrupter (GFCI) reaction system to protect against electric shock. If the charger module detects an output ground fault, it shuts down power to the output cable and illuminates the red indicator.
- **Insulation:** The charger module, connector, cable assembly, and charge coupler are completely insulated. There are no exposed live parts, to protect against electric shock.
- **Unintentional Disconnection:** The charge coupler is designed to minimize unintentional disconnection. A pilot signal wire in the cable and charge coupler eliminates the possibility of electric shock when not connected to a vehicle or if an unintended disconnect occurs during a charge. Disconnection during charging is safe.

## LOCATING THE CHARGE PORT

The charge port is between the front left-hand side door and front left-hand wheel well. To open, press the center right-hand edge of the charge port door and then release.

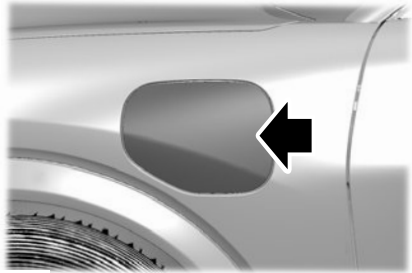

**Note:** Do not apply excessive force. Forcing the door open or closed damages the charge port.

## CHARGE PORT INDICATORS

The charge status indicator is next to the charging port behind the charge port door. It indicates the charge status of the high voltage battery in your vehicle.

Divided into five zones, the charge status indicator displays the state of charge in 20 percent increments.

The charge status indicator displays how far along the charge is:

- When zone A is pulsing, the charge is between 0-20 percent.
- When zone A illuminates, and zone B is pulsing, the charge is between 20-40 percent.
- When zones A and B illuminate and zone C is pulsing, the charge is between 40-60 percent.

# Charging Your Vehicle

- When zones A, B, and C illuminate, and zone D is pulsing, the charge is between 60–80 percent.
- When zones A, B, C, and D illuminate, and zone E is pulsing, the charge is between 80–100 percent.
- When all zones illuminate, the charge is 100 percent.

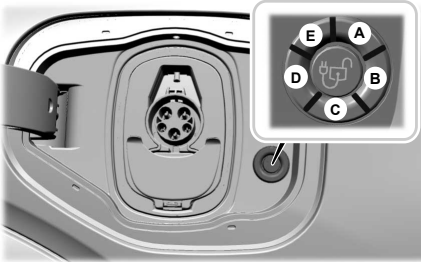

**Note:** When charging stops, the charge status indicator shows all the completed zones solidly illuminated up in a blue color for 30 seconds before turning off. For example, if charging stops at 70 percent, then A, B, and C light up solidly to indicate a battery charge level of at least 60 percent but less than 80 percent. Charging stops when complete or when paused due to charge settings or charge station actions.

**Note:** If the charge status indicator does not light up or pulse after plugging in, please verify that the charge port light setting is On. If you do not wish to have the charge status indicator light up at all while charging, then you can turn it Off. Locate the charge port light under the vehicle settings on your in-vehicle touchscreen.

There are three charge port indicator light colors, which indicate a specific action:

White is used as a courtesy light to help with plugging in and to acknowledge actions such as plugging in and unplugging.

Blue is used when the vehicle is plugged in and either charging or waiting to charge.

Amber is used to indicate charge faults.



**Note:** Charging faults are identified by the color amber on the charge status indicator. Faults can occur within the vehicle charging system or outside the vehicle, such as with the mobile charger, charge station or electrical supply.

**Note:** If the system detects a fault in the vehicle charging system at any point in a charge cycle, the entire charge status indicator illuminates solidly in an amber color for 30 seconds and then turns off. If this happens, unplug the charge coupler and then plug it back into the charge port receptacle. If the problem persists, have your vehicle serviced as soon as possible.

**Note:** If the system detects a fault outside the vehicle, such as with the charge station or mobile charger, the entire charge status indicator flashes amber continuously for 30 seconds and then turns off. If this happens check the mobile charger, charge station or electrical supply.

## AC CHARGING

### CONNECTING THE CHARGER



#### Charging Using the Mobile Charger

**CAUTION: TO REDUCE THE RISK OF FIRE-** The plug must be properly grounded. Use a dedicated circuit. If you do not use a dedicated circuit, the circuit breaker could trip or open. If you do not have a dedicated circuit, contact a licensed professional electrician for proper installation.

# Charging Your Vehicle

To charge the high voltage battery:

You must unwrap the mobile charger completely before charging.

1. Put the vehicle in park (P).

**Note:** Your vehicle must be in park (P) to charge and for the charge status indicator to illuminate.

2. Press the center right edge of the charge port door and then release to open the door.
3. Plug the connector into the control box.

**Note:** To insert the connector, firmly grasp the connector by the cable or plug and push into the control box until an audible click is heard. Make sure the connector is fully inserted and flush with the control box before inserting it into the outlet. Improper insertion will cause a longer charge session or faults.

4. Plug the connector into the wall outlet.
5. Confirm that the mobile charger's indicators illuminate.
6. Plug the charge coupler into the charge port receptacle on your vehicle.



**Note:** Make sure the button clicks confirming that you have completely engaged the coupler. When you plug in your vehicle, it starts charging to 100% by default unless scheduled charging has been set up for this location. See **Setting the Charging Schedule and Preferences** (page 174).

**Note:** Plug the connector into the wall outlet before connecting the charge coupler to your vehicle's charge port.

**Note:** When the handle is properly engaged the light ring illuminates. This indicates the beginning of a normal charge cycle.

**Note:** There could be a delay in light ring illumination due to vehicle internal communications.

**Note:** If charging for your vehicle fails, please contact the Customer Relationship Center, or click on Live chat. To ensure superior service, please take note of your serial number when contacting customer support.

For more information, visit [www.owner.ford.com](http://www.owner.ford.com).

## Charging At a Charge Station

1. Put your vehicle in park (P).

**Note:** Your vehicle must be in park (P) to charge.

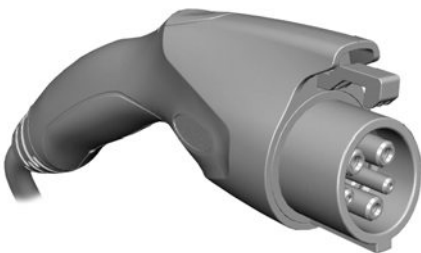

# Charging Your Vehicle

2. Press the center right hand edge of the charge port door and then release to open the door.
3. Select the appropriate charge station coupler.
4. Plug the charge coupler into the charge port receptacle on your vehicle.

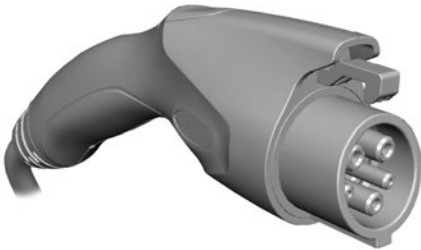

**Note:** Make sure the button clicks confirming that you have completely engaged the coupler. When you plug in your vehicle, it starts charging to 100% by default unless scheduled charging has been set up for this location. See **Setting the Charging Schedule and Preferences** (page 174).

**Note:** When the handle is properly engaged the light ring illuminates. This indicates the beginning of a normal charge cycle.

**Note:** There could be a delay in light ring illumination due to vehicle internal communications.

Information about public charge stations is available through the in-vehicle screen as well as the FordPass app with pricing, power levels, and real time availability. Rates for charging varies by power level, provider, location, and time of day.

When charging your vehicle at a FordPass Charging Network station, use the FordPass App to activate and pay for charging. You can also just plug in to activate charging at Plug & Charge capable stations. If the charging station is not in the FordPass Charging Network, use the directions on the charge station to activate the charger.

For more information, visit [www.owner.ford.com](http://www.owner.ford.com).

## STOPPING CHARGING

**⚠ WARNING:** To safely discontinue charging at any time, follow the disconnect instructions in stopping charging. Charging will automatically and safely come to a stop. The BLUE STATUS indicator remains ON solid when the coupler is removed.

Using the mobile charger:

1. Push the latch and remove the charge coupler from the vehicle.
2. Remove the connector plug from the wall outlet.

**Note:** Do not pull the wall plug from the wall or the connector from the mobile charger control box, while your vehicle is charging. Doing so could damage the outlet and the cord.

# Charging Your Vehicle

**Note:** You cannot shift your vehicle out of park (P) until you remove the charge coupler.

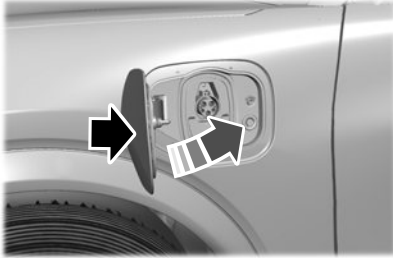

3. Press the center right-hand edge of the charge port door to close.



4. Plug the charge coupler into the charge port receptacle on your vehicle.

## DC CHARGING

### CONNECTING THE CHARGER



To charge the high voltage battery:

1. Put the vehicle in park (P).

**Note:** Your vehicle must be in park (P) to charge and for the charge status indicator to illuminate.

2. Press the center right-hand edge of the charge port door and then release to open the door.
3. Open the dust cap cover on the charge port to expose lower connectors.



**Note:** Make sure the button clicks confirming that you have completely engaged the coupler. Your vehicle locks to the charge coupler.

**Note:** When the handle is properly engaged, the light ring illuminates. This indicates the beginning of a normal charge cycle.

**Note:** The vehicle monitors battery health and may take actions including, but not limited to, reducing the DC fast charge rate to protect the battery hardware from damage, and to maintain battery health.



# Charging Your Vehicle

Information about public charge stations is available through the in-vehicle screen as well as the FordPass app with pricing, power levels, and real time availability. Rates for charging varies by power level, provider, location, and time of day.

**Note:** When charging your vehicle at a public charge station, follow the directions on the charge station.

## STOPPING CHARGING

1. Push the coupler unlock button on the light ring and remove the charge coupler handle from the vehicle.



2. Close the dust cap for the additional lower connectors.

**Note:** Do not attempt to remove the charge coupler before you unlock it. Do not use any kind of tool to try and remove a locked charge coupler. Doing so can lead to damage to your vehicle and the charge coupler.

**Note:** You cannot unlock the charge coupler handle unless the vehicle remote is near the vehicle.

**Note:** You can also unlock the cord through the vehicle touchscreen. If the cord still does not unlock, please contact roadside assistance.

**Note:** You cannot shift your vehicle out of park (P) until you remove the charge coupler handle.

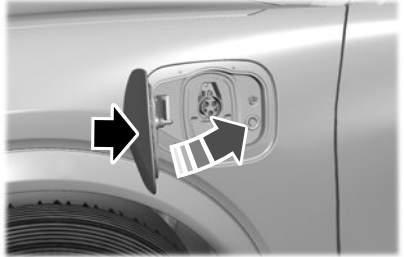

3. Press the center right-hand edge of the charge port door to close.

## Charge Coupler Manual Release

If your vehicle does not unlock the charge coupler, you can manually release it.

Releasing the charge coupler:

1. Switch off your vehicle.
2. Open the hood.
3. Remove the inner luggage compartment shields and locate the low voltage service disconnect. See **Installing and Removing the Luggage Compartment Cover** (page 278).

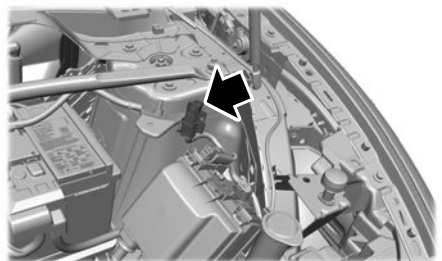

# Charging Your Vehicle

4. Move the low voltage service disconnect to the off position.

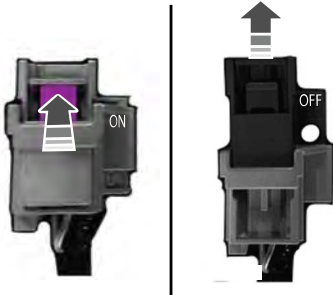

5. Locate the manual release mechanism.

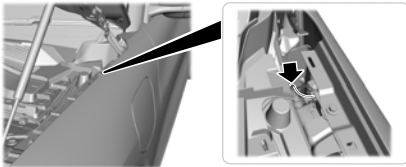

6. Between the gap of the hood and windshield, access the manual release mechanism and pull the pull ring firmly, perpendicularly towards the center of your vehicle. Once pulled, make sure you do not tangle the pull ring cord as it resets on the next charge session.

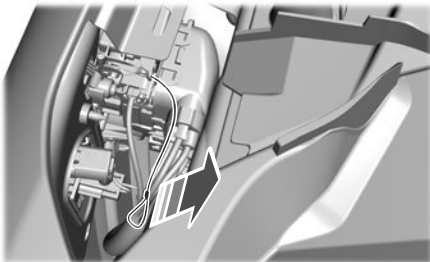

7. Remove the charge coupler from the charge port.

8. Close the low voltage service disconnect.
9. Reinstall the inner luggage compartment shields. See **Installing and Removing the Luggage Compartment Cover** (page 278).
10. Close the hood.

**Note:** The next time you plug in to charge your vehicle, the locking mechanism re-engages and the pull ring resets.

## SETTING THE CHARGING SCHEDULE AND PREFERENCES



You can schedule charging to take advantage of lower-cost electricity rates during off-peak hours if you have signed up for a time of use pricing plan with your utility provider. You can also set an upper charge limit for your battery and a departure time and cabin temperature so your vehicle is ready to go when you are.

Scheduled charging can be set up in the on vehicle display or in the FordPass app.

To view your charge settings:



Access the vehicle drawer on the touchscreen.

1. Press **Settings** on the touchscreen.
2. Press Charge.

# Charging Your Vehicle

## Charge Settings Screen

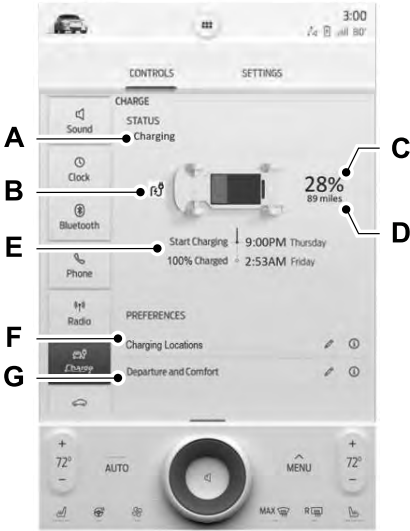

- A Charge status.
- B Charge status icon.
- C High voltage battery state of charge.
- D Estimated vehicle driving range.
- E Charging time information.
- F Charging location preferences.
- G Departure and comfort preferences.

## Charge Status

Shows the present state of charging system.

Charge Status	Action
Will charge when plugged in	The vehicle is unplugged and will start charging once plugged in.
Will wait for preferred charge time	The vehicle is unplugged at a location with charge times enabled. Charging is scheduled to start at the time displayed based on your settings. You must plug in prior to the start time shown for the vehicle to begin charging at that time.
Waiting for preferred charge time	The vehicle is plugged in at location with charge times enabled. Charging will start at the time displayed, which is based on your charge time settings.
Charging stopped	The vehicle is plugged in and charging has been stopped through the FordPass mobile app.
Charging	The vehicle is plugged in and charging.

# Charging Your Vehicle

Charge Status	Action
Fast charging	The vehicle is plugged into a DC Fast Charge station and charging.
Charging 12V battery	The vehicle is plugged in and charging the 12V battery.
Cabin conditioning	The vehicle is plugged in and the climate control system is operating according to the departure and comfort settings.
Vehicle charge fault	The vehicle is plugged in and there is a fault within the vehicle charging system. Unplug and plug back in. If the fault is still present, contact your authorized EV certified dealer.
Charge station fault	The vehicle is plugged in and a fault has been detected with the charge station or charging cord. Please check the charging cord and the charging station or electrical supply.
Charge station not detected	A charging coupler has been plugged into the vehicle but there is no connection with a charging power source.
Charge station paused	The vehicle is plugged in and charging has been paused at the charge station.

## Charging Time Information

When charging, the start and estimated end time displays. When fast charging, the end time is replaced with the estimated time at 80% charge until the charge reaches 80%, then the estimated time at 100% charge is displayed.

When your vehicle is at a stored charging location and not plugged in, the start and end times display based on known charging infrastructure.

**Note:** *Charging time information is estimated. Certain conditions could result in longer charging times. See **Charging Your Vehicle** (page 159).*

## High Voltage Battery State of Charge

Displays the remaining charge percentage with 100% representing the total amount of energy you can get from an external charge.

## Estimated Vehicle Driving Range

Displays the estimated distance the vehicle can travel with the present high voltage battery charge level. See **Vehicle Range Display** (page 119).

## Charge Status Icons

Displays when your vehicle is plugged in.



Not charging due to a fault.

# Charging Your Vehicle



Not currently charging.



Charging.



Waiting to charge based on charge time settings.

## Charging Locations



Press the edit button to set preferred charge times for a specific charging location.

Your vehicle prioritizes charging based on your preferred time settings. You can set two preferred charging time windows for weekdays and two for weekends. This feature allows you to take advantage of electric utility rate plans that offer lower pricing during certain times of day. Contact your utility company to see what plans are available.

**Note:** *Your vehicle will charge during your preferred time windows. Charging outside these windows only occurs when additional charging time is needed to reach the maximum charge level set for this location by your next departure time.*

**Note:** *You can also access this feature using the FordPass app.*

## Departure and Comfort



Press the edit button for departure and comfort settings.

Setting departure times allows you to control charging schedules and warm or cool your cabin and the high voltage battery when your vehicle is plugged in, so your vehicle is ready to drive when you are. By setting a departure time, your vehicle

can use your charge time settings to minimize your electricity costs but still prioritize finishing charging before your scheduled departure. The calendar view allows you to program two departure times per day for each day of the week.

**Note:** *By using energy from your charging source while plugged in, battery temperature can be managed for best driving performance and less energy will be needed for heating or cooling of the cabin at the start of your drive. This helps maximize your driving range.*

**Note:** *You can also access this feature using the FordPass app.*

Additional information and settings are displayed on the charge settings screen once charging locations and departure and comfort have been set up.

# Charging Your Vehicle

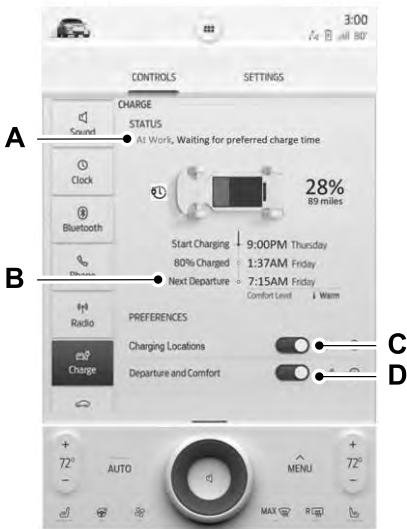

- A Charging location name.
- B Next departure time and cabin temperature.
- C On/Off switch for charging locations.
- D On/Off switch for departure and comfort.

## Charging Location Name

Displays when your vehicle is at a stored charging location.

## Next Departure Time and Cabin Comfort Level

Displays the next departure time and associated cabin comfort setting.

## On/Off Switch for Charging Locations

This switch is visible when your vehicle is at a saved charging location. Use this switch to turn your settings off and on for this location only. Switching off for this location does not delete your settings, however, you must switch back on to re-enable them.

## On/Off Switch for Departure and Comfort

This switch is visible when you have at least one departure time set. Use this switch to turn all departure times off and on. Switching off departure and comfort does not delete your settings, however, you must switch back on to re-enable them.

## Charging Location Setup

Follow these steps to set time and charge level preferences for a charging location.



Press the edit button for charging locations on the charge settings screen.

1. Select an address from the list of recent charge locations. If the previously saved charge locations are not listed, then you must first select add new location. You can also edit settings for previously saved locations.
2. Confirm that this is the location you want to save with the help of the map view. Edit the location name if desired and set a maximum charge level. Press next.

**Note:** *Charging will stop when your vehicle reaches the maximum charge level setting.*

# Charging Your Vehicle



3. Set preferred charging times for weekday and/or weekend by pressing and dragging along the 24 hour time wheel. You can set up to two blocks of time (charge windows). Press next once you have your desired time settings for weekday and weekend.

**Note:** Selecting all or none of the 24 hours results in any time of day given equal priority for charging.

4. The summary screen displays your settings for this location. Press save or press the left arrow to go back and change your settings. Whenever your vehicle is at a saved charging location, the charge settings screen displays the location name, and the charging times are based on your preferred time settings for that location plus the next departure time.

**Note:** Reaching your max charge level by your next departure time is always the priority. When charge times are set, charging outside your preferred charging time windows could be necessary in order to finish by your next departure time. In this case, the vehicle will typically begin charging right away after plugging in.

## Departure and Comfort Setup

Follow these steps to set departure times and cabin comfort level.

1. Press the edit button for departure and comfort on the charge settings screen.
2. Select a time for each day of the week you want your settings to apply. Select the hour and minutes as well as your desired comfort level. Your selected days/times now display your departure and comfort settings. Press Save to apply your settings. The next departure display on the charge settings screen will update appropriately.

**Note:** Save your departure settings before selecting additional days/times. The process must be repeated in order to add additional unique departure times and comfort levels.

**Note:** Cabin conditioning comfort level may vary depending on if you plug into a normal household outlet or a higher power outlet or charging station. The power available for conditioning is limited to the charging station power available. At low ambient temperatures and low charge power, a small amount of high voltage battery power in addition to the charging power could be used to heat the cabin.

**Note:** The departure and comfort settings can also be accessed through the separate vehicle settings departure and comfort button. Press the edit button from this screen to begin the settings process outlined above.

## USING FORDPASS AND CHARGING

The FordPass App allows you to do the following:

- Monitor and manage your vehicle's charging, including charge schedules and preferences.
- Locate a charger and activate a charger on the FordPass Charging Network.

# Charging Your Vehicle

- Plan a trip and charging options along your route.
- Check charging station plug availability.
- Initiate a charge session automatically at Plug and Charge capable charge stations.
- Control your Ford Connected Charge Station remotely.
- Override charge preferences and starting and stopping charging.

For more information, visit [www.owner.ford.com](http://www.owner.ford.com).

## CHARGING YOUR VEHICLE HINTS

We recommend limiting the amount of DC charges, and ending DC charges at 80% state of charge as charging between 80 and 100% can incur high charging costs due to the time to completion. Frequent use of DC charging could result in reducing your battery's efficiency and lifespan. This is more pronounced on the standard range battery pack versus the extended range battery pack.

## CHARGING YOUR VEHICLE – INFORMATION MESSAGES

Message	Action
Vehicle Plugged In ? Yes No	Your vehicle needs confirmation it is unplugged before allowing a start. You must make sure your vehicle is unplugged and you respond to the message promptly before starting your vehicle.
Plug in to Maintain 12V Battery	Indicates that HV battery can no longer support the 12V battery. Plug In your vehicle to charge the high voltage battery and maintain the 12V battery at a healthy state.
Charge Station Fault See Manual	The vehicle is plugged in and a fault has been detected with the charge station or charging cord. Please check the charging cord and the charging station or electrical supply.

In cold temperatures, you may notice that DC charging takes longer when the ambient temperature drops below 50°F (10°C). Shutting off climate control or reducing climate control temperature and fan settings for the first 10 to 15 minutes of DC charging will allow the battery to warm up and improve the charging rate.

**Note:** When the temperature is below freezing, fully turning off cabin heat for the first 10 to 15 minutes of DC charging could significantly improve the charging rate.

## CHARGING YOUR VEHICLE – TROUBLESHOOTING

### CHARGING YOUR VEHICLE – WARNING LAMPS



Plugged into charger.



# Charging Your Vehicle

---

## **CHARGING YOUR VEHICLE – FREQUENTLY ASKED QUESTIONS**

### **Why does my vehicle not charge with the mobile charger?**

Ensure you properly connect the connector and control box. Unplug the charge coupler from the vehicle and unplug the connector from the wall outlet. Then check the connector to be sure that the connector is connected properly into the mobile charger control box. If the mobile charger is warm or in a hot environment, try charging in a cooler area. Try a different outlet or a different connector if you have one available. If the problem persists, contact an authorized EV certified dealer.

### **Why does my vehicle have a hum or fan noise when charging?**

A hum or a fan noise could be present when charging the high voltage battery. This is a normal operation as your vehicle is keeping the battery cool while charging.

# Automatic Transmission

## AUTOMATIC TRANSMISSION PRECAUTIONS



**WARNING:** When your vehicle is stationary, keep the brake pedal fully pressed when shifting gears. Failure to follow this instruction could result in personal injury, death or property damage.



**WARNING:** Do not apply the brake pedal and accelerator pedal simultaneously. Applying both pedals simultaneously for more than a few seconds will limit power, which may result in difficulty maintaining speed in traffic and could lead to serious injury.



**WARNING:** Apply the parking brake, shift into park (P), switch the vehicle off and remove the key or remote control before you leave your vehicle. Failure to follow this instruction could result in personal injury or death.

**Note:** You may not be able to shift out of park (P) unless the intelligent access key is inside your vehicle.

## AUTOMATIC TRANSMISSION POSITIONS

### PARK (P)



**WARNING:** Move the transmission selector lever to park (P) only when your vehicle is stationary.

This position locks the driveline and prevents the wheels from turning. Come to a complete stop before putting your vehicle into and out of park (P). A tone sounds when you shift to park (P).

The electric parking brake could apply when you shift to park (P) without the brake pedal fully pressed. The electric parking brake applies when you shift to park (P) on large slopes. The electric parking brake releases with the drive away release function or manually. See **Electric Parking Brake** (page 189).

**Note:** A warning tone sounds if you open the driver door and you have not shifted the transmission selector to park (P).

### REVERSE (R)



**WARNING:** Move the transmission selector lever to reverse (R) only when your vehicle is stationary.

This position allows your vehicle to move backward. Come to a complete stop before shifting into and out of reverse (R).

### NEUTRAL (N)



**WARNING:** In neutral (N) your vehicle is free to roll.

In neutral (N) power is not transmitted to the driven wheels.

### DRIVE (D)

Drive (D) is the normal driving position, and allows your vehicle to move forward.

# Automatic Transmission

## LOW (L)

You can activate this position at any vehicle speed which provides an increased level of deceleration when you lift off the accelerator pedal. You can use low (L) at all times, if desired, but improving drivability while descending grades is the intent. Entering low (L) does not take any actions if one pedal drive is active

## SHIFTING YOUR VEHICLE INTO GEAR



Your vehicle has an electronic transmission selector. The transmission selector is on the center console. You can select positions by rotating the transmission selector to **PRNDL**.

- Park (P).
- Reverse (R).
- Neutral (N).
- Drive (D).
- Low (L).

Putting your vehicle in gear:

1. Fully press down the brake pedal.
2. Rotate the gear selector knob to the desired position mode you want to select.

3. The gear selector indicates the position selected.
4. Release the brake pedal and your transmission remains in the selected position.

**Note:** Your gear selector knob can rotate clockwise past drive (D), but the gear selection stays in drive (D). Your gear selector can rotate counterclockwise past park (P) with the brake pedal pressed, but the gear selector stays in park (P).

**Note:** If you attempt to leave your vehicle when it is in gear, your vehicle automatically shifts into park (P). See **How Does Automatic Return to Park (P) Work** (page 184).

## TEMPORARY NEUTRAL MODE

### WHAT IS TEMPORARY NEUTRAL MODE

This mode keeps your vehicle in neutral (N), for a limited time, when you exit your vehicle or switch your vehicle off.

**Note:** Do not tow your vehicle in this mode.

### TEMPORARY NEUTRAL MODE LIMITATIONS

Your vehicle could shift to park (P) after 30 minutes, or when the vehicle battery charge level is low. Prolonged use of this mode can cause the vehicle battery to run out of charge.

Do not tow your vehicle in this mode. Failure to follow these instructions could result in vehicle damage not covered by the vehicle warranty.

### ENTERING TEMPORARY NEUTRAL MODE

1. Power your vehicle on.

# Automatic Transmission

---

2. Bring your vehicle to a complete stop.
3. Press and hold the brake pedal.
4. Shift into neutral (N).

**Note:** *An instructional message appears.*

5. Press the low (L) button.

**Note:** *A confirmation message appears when your vehicle enters the mode.*

6. Release the brake pedal.

**Note:** *Your vehicle is free to roll.*

7. Switch your vehicle off.

**Note:** *Do not tow your vehicle in this mode.*

**Note:** *The neutral (N) indicator on the transmission selector may flash in this mode.*

## EXITING TEMPORARY NEUTRAL MODE

1. Press the brake pedal.
2. Shift into park (P), or power your vehicle on and shift into drive (D) or reverse (R).

## AUTOMATIC RETURN TO PARK (P)

### WHAT IS AUTOMATIC RETURN TO PARK (P)

Your vehicle shifts into park (P) if you attempt to exit your vehicle without the transmission in park (P).

### HOW DOES AUTOMATIC RETURN TO PARK (P) WORK

Your vehicle shifts to park (P) when your vehicle is stationary and any of the following occur:

- You switch the vehicle off.
- You open the driver door with the driver seatbelt unfastened.
- You unfasten the driver seatbelt with the driver door open.

**Note:** *Do not use Automatic Return to Park when your vehicle is moving, except in an emergency. See **Powering Off** (page 155).*

### AUTOMATIC RETURN TO PARK (P) LIMITATIONS

Automatic return to park may not work if the door ajar switch is malfunctioning.

See an authorized dealer if any of the following occur:

- Door ajar indicator does not illuminate with the driver door open.
- Door ajar indicator illuminates with the driver door closed.
- Transmission not in park message appears with the driver door closed, after you shift out of park (P).

# All-Wheel Drive (If Equipped)

## HOW DOES ALL-WHEEL DRIVE WORK

The all-wheel drive system is designed to continuously monitor and adjust power delivery to the front and rear wheels to optimize both traction and handling.

There is further information on driving in unique driving conditions. See **Driving Hints** (page 281).

## ALL-WHEEL DRIVE PRECAUTIONS



**WARNING:** Do not become overconfident in the ability of all-wheel drive vehicles. Although an all-wheel drive vehicle may accelerate better than a two-wheel drive vehicle in low traction situations, it won't stop any faster than two-wheel drive vehicles. Always drive at a safe speed.

## ALL-WHEEL DRIVE LIMITATIONS

The all-wheel drive system is not intended for use with mismatched tires.

Different tire sizes between the front and rear axles can cause system damage.

## ALL-WHEEL DRIVE – TROUBLESHOOTING

### ALL-WHEEL DRIVE – INFORMATION MESSAGES

Message	Action
AWD Temporarily Disabled	The all-wheel drive system temporarily turns off to protect itself from overheating.
AWD Off	The all-wheel drive system is not operating properly. If the warning stays on or continues to come on, contact an authorized dealer.
AWD Restored	The all-wheel drive system will resume normal function.

# Brakes

## BRAKE PRECAUTIONS



**WARNING:** Driving your vehicle with the warning lamp on is dangerous. A significant decrease in braking performance may occur. It may take you longer to stop your vehicle. Have your vehicle checked as soon as possible. Driving extended distances with the parking brake engaged can cause brake failure and the risk of personal injury.

Wet brakes result in reduced braking efficiency. Gently press the brake pedal a few times when leaving a car wash or driving from standing water to dry the brakes.

**Note:** Depending on applicable laws and regulations in the country for which your vehicle was originally built, the stoplamps could flash during heavy braking. Following this the hazard warning flashers could also turn on when your vehicle comes to a stop.

## ANTI-LOCK BRAKING SYSTEM

### ANTI-LOCK BRAKING SYSTEM LIMITATIONS

The anti-lock braking system does not eliminate the risk of a crash when:

- You drive too close to the vehicle in front of you.
- Your vehicle is hydroplaning.
- You take corners too fast.
- The road surface is poor.

## BRAKE OVER ACCELERATOR

In the event the accelerator pedal becomes stuck or entrapped, apply steady and firm pressure to the brake pedal to slow the vehicle and reduce power. If you experience this condition, apply the brakes and bring your vehicle to a safe stop. Move the transmission to park (P), switch the power off and apply the parking brake. Inspect the accelerator pedal for any interference. If none are found and the condition persists, have your vehicle towed to the nearest authorized dealer.

## LOCATING THE BRAKE FLUID RESERVOIR

See **Under Hood Overview** (page 305).

## CHECKING THE BRAKE FLUID



**WARNING:** Do not use any fluid other than the recommended brake fluid as this will reduce brake efficiency. Use of incorrect fluid could result in the loss of vehicle control, serious personal injury or death.



**WARNING:** Only use brake fluid from a sealed container. Contamination with dirt, water, petroleum products or other materials may result in brake system damage or failure. Failure to adhere to this warning could result in the loss of vehicle control, serious personal injury or death.



**WARNING:** Do not allow the fluid to touch your skin or eyes. If this happens, rinse the affected areas immediately with plenty of water and contact your physician.

# Brakes



**WARNING:** The brake system could be affected if the brake fluid level is below the **MIN** mark or above the **MAX** mark on the brake fluid reservoir.



1. Park your vehicle on a level surface.
2. Look at the brake fluid reservoir to see where the brake fluid level is relative to the **MIN** and the **MAX** marks on the reservoir.

**Note:** To avoid fluid contamination, the reservoir cap must remain in place and fully tight, unless you are adding fluid.

Only use fluid that meets our specifications. See **Capacities and Specifications** (page 346).

## BRAKE FLUID SPECIFICATION

See **Brake Fluid Specification** (page 348).

## BRAKES – TROUBLESHOOTING

### BRAKES – WARNING LAMPS



If the ABS indicator illuminates when you are driving, this indicates a malfunction. Your vehicle continues to have normal braking without the anti-lock braking system function. See an authorized dealer.

It also momentarily illuminates when you switch the ignition on to confirm the lamp is functional. If it does not illuminate when you switch the ignition on, or begins to flash at any time, have the system checked by an authorized dealer.



The brake indicator momentarily illuminates when you switch the ignition on to confirm the lamp is functional. It may also illuminate when you apply the parking brake and the ignition is on. If it illuminates when your vehicle is moving, make sure the parking brake is disengaged. If the parking brake is disengaged, this indicates low brake fluid level or a brake system fault. See an authorized dealer.

## BRAKES – FREQUENTLY ASKED QUESTIONS

### Is occasional brake noise normal

Occasional brake noise is normal. If a metal-to-metal, continuous grinding or continuous squeal sound is present, the brake linings could be worn-out. Have the system checked by an authorized dealer.

# Brakes

---

**Note:** *Brake dust could accumulate on the wheels, even under normal driving conditions. Some dust is inevitable as the brakes wear, and does not contribute to brake noise. See **Cleaning Wheels** (page 312).*



# Electric Parking Brake

## WHAT IS THE ELECTRIC PARKING BRAKE

The electric parking brake is used to hold your vehicle on slopes and flat roads.

## APPLYING THE ELECTRIC PARKING BRAKE



**WARNING:** Always fully apply the parking brake and make sure you shift into park (P). Failure to follow this instruction could result in personal injury or death.



**WARNING:** If you drive extended distances with the parking brake applied, you could cause damage to the brake system.



**WARNING:** The electric parking brake does not operate if the vehicle battery has run out of charge.



The electronic parking brake switch is on the center console.

1. Pull the switch up.

The red warning lamp flashes during operation and illuminates when the parking brake is applied.

**Note:** You can apply the electric parking brake when the power is off.

**Note:** The electric parking brake could apply when you shift into park (P). See **Park (P)** (page 182).

## APPLYING THE ELECTRIC PARKING BRAKE IN AN EMERGENCY

You can use the electric parking brake to slow or stop your vehicle in an emergency.

1. Pull the switch up and hold it.

The electric parking brake continues to slow your vehicle down unless you release the switch.

The red warning lamp illuminates, a tone sounds and the stoplamps turn on when you use the electric parking brake in an emergency.

**Note:** Do not apply the electric parking brake when your vehicle is moving, except in an emergency. If you repeatedly use the electric parking brake to slow or stop your vehicle, you could cause damage to the brake system.

## MANUALLY RELEASING THE ELECTRIC PARKING BRAKE

1. Switch the power on.
2. Press and hold the brake pedal.
3. Push the switch down.

The red warning lamp turns off.

## AUTOMATICALLY RELEASING THE ELECTRIC PARKING BRAKE

1. Close the driver door.
2. Shift into gear.
3. Press the accelerator pedal and pull away in a normal manner.

# Electric Parking Brake

## ELECTRIC PARKING BRAKE AUDIBLE WARNING

Sounds when the parking brake is on and your vehicle is moving. If the warning tone continues after you have released the parking brake, this indicates a malfunction. Have your vehicle checked as soon as possible.

## RELEASING THE ELECTRIC PARKING BRAKE IF THE VEHICLE BATTERY HAS RUN OUT OF CHARGE

See **Jump Starting the Vehicle** (page 289).

## ELECTRIC PARKING BRAKE – TROUBLESHOOTING

### ELECTRIC PARKING BRAKE – WARNING LAMPS

#### Brake System

 It illuminates red when you apply the parking brake and your vehicle is on. If the lamp flashes when the parking brake has been released, this indicates the parking brake system requires service. Have your vehicle checked as soon as possible.

**Note:** *Lamps may vary depending on region.*

#### Electric Parking Brake

 When the lamp illuminates yellow, it indicates a malfunction in the electric parking brake. Have your vehicle checked as soon as possible.

# Electric Parking Brake

## ELECTRIC PARKING BRAKE – INFORMATION MESSAGES

### Park Brake

<b>Message</b>	<b>Action</b>
Park Brake Engaged	The parking brake is set, if the vehicle is in gear and you drive your vehicle more than 3 mph (5 km/h). If the warning stays on after the parking brake is released, contact an authorized dealer as soon as possible.
To Release: Press Brake and Switch	The electric parking brake is set and a manual release is attempted without the brake pedal being pressed.
Park Brake Use Switch to Release	The electric parking brake is set and an automatic release is attempted but cannot be performed. Perform a manual release.
Release Park Brake	The electric parking brake is set and your vehicle speed exceeds 3 mph (5 km/h). Release park brake before continued driving.
Park Brake Not Applied	The electric parking brake is not fully applied.
Park Brake Not Released	The electric parking brake is not fully released.
Park Brake Maintenance Mode	The electric parking brake system has been put into a special mode that is used to allow service of the rear brakes. Contact an authorized dealer.
Park Brake Limited Function Service Required	The electric park brake system has detected a condition that requires service. Some functionality may still be available. Contact your authorized dealer.
Park Brake Malfunction Service Now	The electric parking brake system has detected a condition that requires service. Contact your authorized dealer.
Park Brake System Overheated	Numerous park brake applies have overheated the system. Wait 2 minutes before attempting to apply again.

# Reverse Braking Assist

## WHAT IS REVERSE BRAKING ASSIST

The system uses sensors on the rear of your vehicle to detect a possible collision and applies the brakes to either reduce the damage from impact, or to assist in avoiding the collision.

## HOW DOES REVERSE BRAKING ASSIST WORK

Reverse Braking Assist functions when in reverse (R) and traveling at a speed of 1–7 mph (1.5–12 km/h).

If the system detects an obstacle behind your vehicle, it provides a warning through the rear parking aid or cross traffic alert system.

## REVERSE BRAKING ASSIST PRECAUTIONS



**WARNING:** You are responsible for controlling your vehicle at all times. The system is designed to be an aid and does not relieve you of your responsibility to drive with due care and attention. Failure to follow this instruction could result in the loss of control of your vehicle, personal injury or death.



**WARNING:** To help avoid personal injury, always use caution when in reverse (R) and when using the sensing system.



**WARNING:** The system may not operate properly during severe weather conditions, for example snow, ice, heavy rain and spray. Always drive with due care and attention. Failure to take care may result in a crash.



**WARNING:** Traffic control systems, fluorescent lamps, inclement weather, air brakes, external motors and fans may affect the correct operation of the sensing system. This may cause reduced performance or false alerts.



**WARNING:** Some situations and objects prevent hazard detection. For example low or direct sunlight, inclement weather, unconventional vehicle types, and pedestrians. Apply the brakes when necessary. Failure to follow this instruction could result in the loss of control of your vehicle, personal injury or death.



**WARNING:** Do not use the system with accessories that extend beyond the front or rear of your vehicle, for example a trailer hitch or bike rack. The system is not able to make corrections for the additional length of the accessories.

The system only applies the brakes for a short period of time when an event occurs. Act as soon as you notice the brakes apply in order to remain in control of the vehicle. If you do not intervene the vehicle may start to move again.

**Note:** *Certain add-on devices around the bumper or fascia may create false alerts. For example, large trailer hitches, bicycle or surfboard racks, license plate brackets, bumper covers or any other device that may block the normal detection zone of the system. Remove the add-on device to prevent false alerts.*

**Note:** *The system does not react to small or moving objects, particularly those close to the ground.*

**Note:** *The system does not operate during hard acceleration or steering.*

# Reverse Braking Assist

**Note:** If your vehicle sustains damage to the bumper or fascia leaving it misaligned or bent, it could alter the sensing zone causing inaccurate measurement of obstacles or false alerts.

**Note:** Vehicle loading and suspension changes can impact the angle of the sensors and may change the normal detection zone of the system resulting in inaccurate measurement of obstacles or false alerts.

**Note:** When you connect a trailer, the system may detect the trailer and provide an alert, or the system turns off. If the system does not turn off, switch the system off manually after you connect the trailer.

**Note:** You may experience reduced system performance on road surfaces that limit deceleration. For example, roads with ice, loose gravel, mud or sand.

## SWITCHING REVERSE BRAKING ASSIST ON AND OFF

1. Access the vehicle drawer on the touchscreen.
2. Press **SETTINGS**.
3. Press **Driver Assistance**.
4. Switch **Reverse Brake Assist** on or off.

**Note:** The system is unavailable when the rear parking aid, cross traffic alert or traction control is off.

**Note:** If your vehicle is not equipped with cross traffic alert the reverse braking assist relies on input from the rear parking aid and rear camera sensors.

**Note:** The default setting is on in some regions.

## OVERRIDING REVERSE BRAKING ASSIST

There could be instances when unexpected or unwanted braking occurs. Firmly pressing the accelerator pedal or switching the feature off overrides the system.

## REVERSE BRAKING ASSIST INDICATORS

If the system determines that a collision with an obstacle may occur, full braking may apply. Bring your vehicle to a stop a safe distance away from the obstacle.



A message and warning indicator appear when the system applies the brakes.

# Reverse Braking Assist

---

## REVERSE BRAKING ASSIST – TROUBLESHOOTING

### REVERSE BRAKING ASSIST – INFORMATION MESSAGES

<b>Message</b>	<b>Action</b>
Reverse Brake Assist Not Available See Manual	Make sure that all doors, liftgate and hood are closed. Drive the vehicle on a straight road for a short period. Make sure the parking aids and cross traffic alert systems are on. If the message remains on, have the system checked as soon as possible.
Reverse Brake Assist Fault	Displays when a system error has occurred. Have your vehicle checked as soon as possible.
Reverse Brake Assist Off	Displays when reverse brake assist is off.

# Reverse Braking Assist

---

## REVERSE BRAKING ASSIST – FREQUENTLY ASKED QUESTIONS

Why is reverse braking assist unavailable?

- Make sure the reverse braking assist is on. See **Switching Reverse Braking Assist On and Off** (page 193).
- Make sure that all doors and the liftgate or tailgate are closed. Drive the vehicle on a straight road for a short period. If the message remains, contact an authorized dealer.
- Make sure the cross traffic alert system is on if equipped. See **Switching Cross Traffic Alert On and Off** (page 255).
- Make sure the rear parking aid system is on. See **Rear Parking Aid** (page 207).
- Make sure the traction control is on. See **Switching Traction Control On and Off** (page 198).

**Note:** *The traction control automatically turns off if four-wheel drive low and certain drive modes such as mud/ruts and snow/sand is activated.*

- The vehicle may have sustained a rear end impact. Contact an authorized dealer to have the sensors checked for proper coverage and operation.
- An anti-lock brake, traction control or stability control event may have occurred. Reverse braking assist resumes operation when the event is complete.
- Make sure the rear view camera and 360 degree camera are not dirty or obstructed. If dirty, clean the camera. If the message still appears after cleaning the camera, wait a short time for the message to clear. If the message does not clear, contact an authorized dealer.

- Make sure the cross traffic alert and rear parking aid sensors are not blocked or faulty. See **Locating the Cross Traffic Alert Sensors** (page 256). See **Locating the Rear Parking Aid Sensors** (page 207).
- You recently had your vehicle serviced, or the battery disconnected. Drive your vehicle a short distance to resume system operation.
- Reverse braking assist does not function when you connect a trailer. Operation resumes when you disconnect the trailer.

**Note:** *If the answers to why the system is unavailable do not assist in returning reverse braking assist to available, have the system checked as soon as possible.*

# Hill Start Assist

---

## WHAT IS HILL START ASSIST

Hill Start Assist makes it easier for you to pull away when your vehicle is on a slope without using the parking brake.

## HOW DOES HILL START ASSIST WORK

When the system activates, your vehicle remains stationary for a few seconds after you release the brake pedal. This gives you time to move your foot from the brake pedal to the accelerator pedal. The brakes release when the electric motors provide propulsion to prevent your vehicle from rolling down slope.

## HILL START ASSIST PRECAUTIONS



**WARNING:** The system does not replace the parking brake. When you leave your vehicle, always apply the parking brake.



**WARNING:** You must remain in your vehicle when the system turns on. At all times, you are responsible for controlling your vehicle, supervising the system and intervening, if required. Failure to take care may result in the loss of control of your vehicle, serious personal injury or death.



**WARNING:** The system turns off if there is a malfunction.



# Auto Hold

## HOW DOES AUTO HOLD WORK

Auto Hold applies the brakes to hold your vehicle after you stop it and release the brake pedal. This can help when waiting on a hill or in traffic.

## SWITCHING AUTO HOLD ON AND OFF



**WARNING:** The system does not replace the parking brake. When you leave your vehicle, always apply the parking brake.



**WARNING:** You must remain in your vehicle when the system turns on. At all times, you are responsible for controlling your vehicle, supervising the system and intervening, if required. Failure to take care may result in the loss of control of your vehicle, serious personal injury or death.

You can switch the system on or off by accessing the menu in the touchscreen.

1. Access the application drawer on the touchscreen.
2. Press **Settings** on the touchscreen.
3. Press **Driver Assistance**.

**Note:** You can only switch the system on after you close the driver door, and fasten your seatbelt.

**Note:** The system remembers the last setting when you start your vehicle.

**Note:** Make sure you switch the system off before using an automatic car wash.

## USING AUTO HOLD

1. Bring your vehicle to a complete stop. The auto hold active indicator illuminates in the information display.
2. Release the brake pedal. The system holds your vehicle at a standstill. The auto hold active indicator remains illuminated in the information display.
3. Pull away in the normal manner. The system releases the brakes and the auto hold active indicator switches off.

**Note:** The system only activates if you apply enough brake pressure on the brake pedal.

**Note:** Under certain conditions, the system could apply the electric parking brake. The brake system warning lamp illuminates. The electric parking brake releases when you press the accelerator pedal. See **Automatically Releasing the Electric Parking Brake** (page 189).

**Note:** The system switches off if you shift into reverse (R) and press the brake pedal.

There could be actions that can cause the auto hold system not to work when the following occur:

- When you use active park assist.
- Your vehicle is in stay in neutral mode.
- The driver door is open.
- You have not fastened your seatbelt.
- You shift into reverse (R) before the system is active.

## AUTO HOLD INDICATORS



Illuminates when the system is active.



Illuminates when the system is on but cannot hold your vehicle at a standstill at this particular time.

# Traction Control

## WHAT IS TRACTION CONTROL

The traction control system helps to avoid drive wheel spin and loss of traction.

## HOW DOES TRACTION CONTROL WORK

If your vehicle begins to slide, the system applies the brakes to individual wheels and, when needed, reduces power at the same time. If the wheels spin when accelerating on slippery or loose surfaces, the system reduces power in order to increase traction.

## SWITCHING TRACTION CONTROL ON AND OFF



**WARNING:** Operating your vehicle with the traction control disabled could lead to an increased risk of loss of vehicle control, vehicle rollover, personal injury and death.

The system turns traction control and stability control on each time you power on your vehicle.

The switch for the stability and traction control system is on the instrument panel.

If you press the switch, it will turn traction control off.



When you switch the system off, a message and an illuminated icon appear on the instrument cluster.

Use the switch again to return the traction control system to normal operation.

If your vehicle is stuck in mud or snow, switching traction control off may be beneficial as this allows the wheels to spin.

**Note:** When you switch traction control off, stability control remains fully active.

Your vehicle could have MyKey restrictions regarding this feature. See **What Is MyKey** (page 72).

## TRACTION CONTROL INDICATOR

### System Indicator Lights



# Traction Control

## TRACTION CONTROL – TROUBLESHOOTING

## TRACTION CONTROL – WARNING LAMPS

### System Messages



The traction control light temporarily illuminates on

start-up and flashes when activated by a driving condition.

The traction control off light temporarily illuminates on start-up and stays on:

- When you switch the traction control system off.
- When you select an alternative stability control mode.
- If a problem occurs in the system.

## TRACTION CONTROL – INFORMATION MESSAGES

Message	Action
Service AdvanceTrac	The system detects a condition that requires service. Contact an authorized dealer as soon as possible.

# Stability Control

## HOW DOES STABILITY CONTROL WORK



**WARNING:** Vehicle modifications involving braking system, aftermarket roof racks, suspension, steering system, tire construction and wheel and tire size may change the handling characteristics of your vehicle and may adversely affect the performance of the electronic stability control system. In addition, installing any stereo loudspeakers may interfere with and adversely affect the electronic stability control system. Install any aftermarket stereo loudspeaker as far as possible from the front center console, the tunnel, and the front seats in order to minimize the risk of interfering with the electronic stability control sensors. Reducing the effectiveness of the electronic stability control system could lead to an increased risk of loss of vehicle control, vehicle rollover, personal injury and death.



**WARNING:** Remember that even advanced technology cannot defy the laws of physics. It's always possible to lose control of a vehicle due to inappropriate driver input for the conditions. Aggressive driving on any road condition can cause you to lose control of your vehicle increasing the risk of personal injury or property damage. Activation of the electronic stability control system is an indication that at least some of the tires have exceeded their ability to grip the road; this could reduce the operator's ability to control the vehicle potentially resulting in a loss of vehicle control, vehicle rollover, personal injury and death. If your electronic stability control system activates, SLOW DOWN.

If a driving condition activates either the stability control or the traction control system you may experience the following conditions:

- The stability and traction control light flashes.
- Your vehicle slows down.
- Reduced power.

The stability control system has several features built into it to help you maintain control of your vehicle:

### Electronic Stability Control

Electronic stability control enhances your vehicle's ability to prevent skids or lateral slides by applying brakes to one or more of the wheels individually and, if necessary, reducing power.

### Curve Control

Curve control enhances your vehicle's ability to follow the road when cornering severely or avoiding objects in the roadway. Curve control operates by reducing power and, if necessary, applying brakes to one or more of the wheels individually.

### Traction Control

Traction control enhances your vehicle's ability to maintain traction of the wheels by detecting and controlling wheel spin. See **What Is Traction Control** (page 198).

# Stability Control

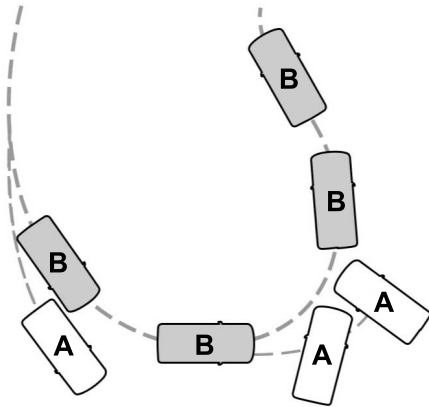

- A Vehicle without stability control skidding off its intended route.
- B Vehicle with stability control maintaining control on a slippery surface.

## SWITCHING STABILITY CONTROL ON AND OFF

The system turns traction control and stability control on each time you power on your vehicle.

You can switch these systems off by using the button to the left of the steering wheel.

If you press the button, it will turn traction control off. See **Switching Traction Control On and Off** (page 198).

If you press and hold for 5 seconds, it turns stability control off.



Shifting into reverse (R) disables the system.

**Note:** With electronic stability control off, E-AWD protection controls remain active and could be noticeable in slippery conditions.

**Note:** While stability control can be turned off in any drive mode, the acceleration response in engage mode provides the most refined longitudinal control of the vehicle.

**Note:** When you choose the drive mode **Unbridled** and electronic stability control is off, it reduces the level of deceleration.

# Stability Control

<b>ESC Features</b>				
<b>Button Functions</b>	<b>Mode</b>	<b>Stability Control Off Light</b>	<b>Electronic Stability Control</b>	<b>Traction Control System</b>
Default at start-up	-	On during bulb check	Enabled	Enabled
Button pressed momentarily	Traction control off	On	Enabled	Disabled
Button pressed and held more than five seconds	ESC disabled	On	Disabled	Disabled
Button pressed again after deactivation	ESC fully enabled	Off	Enabled	Enabled

# Stability Control

---

## STABILITY CONTROL INDICATOR



If it does not illuminate when you switch the power on, or remains on, this indicates a malfunction.

Have your vehicle checked by an authorized dealer as soon as possible.

# Steering

## ELECTRIC POWER STEERING

### ELECTRIC POWER STEERING PRECAUTIONS



**WARNING:** The electric power steering system has diagnostic checks that continuously monitor the system. If a fault is detected, a message displays in the information display. Stop your vehicle as soon as it is safe to do so. Switch the vehicle off. After at least 10 seconds, switch the vehicle on and watch the information display for a steering system warning message. If a steering system warning message returns, have the system checked as soon as possible.



**WARNING:** If the system detects an error, you may not feel a difference in the steering, however a serious condition may exist. Have your vehicle checked as soon as possible. Failure to do so may result in loss of steering control.

Adapt your speed and driving behavior according to reduced steering assist.

Extreme continuous steering may increase the effort to steer. This occurs to prevent internal overheating and damage to the steering system. If this occurs, you will not lose the ability to steer your vehicle manually nor will it cause damage to the system. Normal steering and driving allows the system to cool down and steering assist returns to normal.

**Note:** *There is no fluid reservoir to check or fill.*

### ELECTRIC POWER STEERING ADAPTIVE STEERING

#### Adaptive Learning (If Equipped)

Adaptive learning helps correct road irregularities and improves overall handling and steering. It communicates with the brake system to help operate advanced stability control and crash avoidance systems.

**Note:** *When the battery is disconnected or a new battery is installed, you must drive your vehicle a short distance before the system relearns the strategy and reactivates all systems.*

#### Steering Tips

If the steering wanders or pulls, check for:

- An improperly inflated tire.
- Uneven tire wear.
- Loose or worn suspension components.
- Improper vehicle alignment.

**Note:** *A high crown in the road or high crosswinds could also make the steering wander or pull.*



# Steering

---

## STEERING – TROUBLESHOOTING

### STEERING – INFORMATION MESSAGES

<b>Message</b>	<b>Action</b>
Steering Fault Service Now	The power steering system has detected a condition that requires service. Have your vehicle checked as soon as possible.
Steering Loss Stop Safely	The power steering system is not working. Stop your vehicle in a safe place. Have your vehicle checked as soon as possible.
Steering Assist Fault Service Required	The power steering system has detected a condition that requires service. Have your vehicle checked as soon as possible.
Steering Lock Malfunction Service Now	The steering system has detected a condition that requires service. Have your vehicle checked as soon as possible.

# Parking Aids

## PARKING AID PRECAUTIONS

 **WARNING:** To help avoid personal injury, always use caution when in reverse (R) and when using the sensing system.

 **WARNING:** The system may not detect objects with surfaces that absorb reflection. Always drive with due care and attention. Failure to take care may result in a crash.

 **WARNING:** Traffic control systems, fluorescent lamps, inclement weather, air brakes, external motors and fans may affect the correct operation of the sensing system. This may cause reduced performance or false alerts.

 **WARNING:** The system may not detect small or moving objects, particularly those close to the ground.

 **WARNING:** The parking aid system can only assist you to detect objects when your vehicle is moving at parking speeds. To help avoid personal injury you must take care when using the parking aid system.

 **WARNING:** The system may not function if the sensor is blocked.

 **WARNING:** In cold and severe weather conditions the system may not function. Rain, snow and spray can all limit sensor performance.

 **WARNING:** If damage occurs in the immediate area surrounding the sensor, have your vehicle checked as soon as possible.

**Note:** *If your vehicle sustains damage leaving the sensors misaligned, this will cause inaccurate measurements or false alerts.*

When you connect a trailer to your vehicle, the rear parking aid detects the trailer and provides an alert. Disable the parking aid when you connect a trailer to prevent the alert.

**Note:** *Certain add-on devices installed around the bumper or fascia may create false alerts, for example, large trailer hitches, bike or surfboard racks, license plate brackets, bumper covers or any other device that could block the normal detection zone of the parking aid system. Aftermarket spare tires or spare tire covers mounted to the rear tailgate could cause false alerts from the park aid system. Remove the add-on device to prevent false alerts.*

**Note:** *Keep the sensors free from snow, ice and large accumulations of dirt. If the sensors are covered, the system's accuracy can be affected.*

Do not clean the sensors with sharp objects.

**Note:** *When using a programmed MyKey, you cannot switch the parking aids off. See MyKey™ (page 72).*

## SWITCHING PARKING AID ON AND OFF



Press the parking aid button and use the menu to turn the system on and off.

The system can also be turned off using the pop-up message that appears when you are in reverse (R).

# Parking Aids

## REAR PARKING AID

### WHAT IS THE REAR PARKING AID

Rear parking sensors detect objects behind your vehicle when in reverse (R).

### REAR PARKING AID LIMITATIONS

There is a decreased coverage area at the outer corners.

When using a programmed MyKey, you cannot switch the rear parking aid off.

The rear parking aid sensors are active when your vehicle is in reverse (R) and the vehicle speed is less than 5 mph (8 km/h).

The sensor coverage area is up to 71 in (180 cm) from the rear bumper.

The rear parking aid detects large objects when you shift into reverse (R) and any of the following occur:

- Your vehicle is moving backward at a low speed.
- Your vehicle is stationary but an object is approaching the rear of your vehicle at a low speed.
- Your vehicle is moving backward at a low speed and an object is moving towards your vehicle, for example another vehicle at a low speed.

The system shall provide no audible warning for the object behind the vehicle when in neutral (N) gear.

## LOCATING THE REAR PARKING AID SENSORS



The rear parking aid sensors are in the rear bumper.

## REAR PARKING AID AUDIBLE WARNINGS

A warning tone sounds when your vehicle approaches an object. As your vehicle moves closer to an object, the rate of the tone increases. The warning tone continuously sounds when an object is 12 in (30 cm) or less from the rear bumper.

If your vehicle remains stationary for a few seconds, the audible warning turns off. If your vehicle moves backward the tone sounds again.

**Note:** When the parking aid system sounds a tone, the audio system could reduce the set volume.

## FRONT PARKING AID

### WHAT IS THE FRONT PARKING AID

Front parking sensors detect objects in front of your vehicle.

# Parking Aids

## FRONT PARKING AID LIMITATIONS

The front parking aid sensors are active when your vehicle is in any position other than park (P) and the vehicle speed is less than 5 mph (8 km/h).

The sensor coverage area is up to 28 in (70 cm) from the bumper.

If your vehicle is in reverse (R), the front parking aid detects objects when your vehicle is moving at a low speed or an object is moving toward your vehicle and provides an audible warning, for example another vehicle at a low speed. If your vehicle remains stationary for a few seconds, the audible warning turns off. Visual indication is always active in reverse (R).

If your vehicle is in any forward gear, the front parking aid provides audible warnings and visual indication when your vehicle is moving at a speed of 5 mph (8 km/h) or below and the system detects an object within the detection zone. If your vehicle remains stationary for a few seconds, the visual indication and audible warning turns off.

If your vehicle is in neutral (N), the front and rear sensors provide visual indication only when your vehicle is moving below a speed of 5 mph (8 km/h) and obstacles are detected inside the detection areas. Once your vehicle stops, the visual indication and audible warning stops after a few seconds.

## LOCATING THE FRONT PARKING AID SENSORS



The front parking aid sensors are in the front bumper.

## FRONT PARKING AID AUDIBLE WARNINGS

A warning tone sounds when there is an object within 28 in (70 cm) from the front bumper. As your vehicle moves closer to an object, the rate of the tone increases.

The warning tone continuously sounds when an object is 12 in (30 cm) or less from the front bumper.

**Note:** *If the detected object is 12 in (30 cm) or less from your vehicle, visual indication remains on.*

## SIDE PARKING AID

### WHAT IS THE SIDE PARKING AID

The front and rear outermost parking aid sensors map objects that are near to the sides of your vehicle.

### SIDE PARKING AID LIMITATIONS

The sensor coverage is up to 24 in (60 cm) from the sides of your vehicle.

# Parking Aids

The side parking aid may not function if:

- Your vehicle remains stationary for over two minutes.
- The anti-lock brake system activates.
- The traction control system activates.
- Your vehicle is in park (P).
- The steering wheel angle information is not available. You must drive at least 492 ft (150 m) above 19 mph (30 km/h) to reset the steering wheel angle information.

**Note:** *If you switch traction control off, the side sensing system also turns off.*

To reinitialize the system, drive the length of your vehicle.

The side parking aid does not detect an object that is moving toward the side of your vehicle, for example another vehicle moving at a low speed, if it does not pass a front or rear parking aid sensor.

If the transmission is in reverse (R), the side sensing system provides audible warnings. When your vehicle is moving slowly, obstacles are detected within 24 in (60 cm) and are inside the driving path of your vehicle. If your vehicle remains stationary for a few seconds, the audible warning turns off. Visual indication is always present in reverse (R).

If your vehicle is in neutral (N), the side sensing system provides visual indication only when your vehicle is moving slowly and there is a front or rear parking aid obstacle detected, and the side obstacle is within 24 in (60 cm) from the side of your vehicle. If your vehicle remains stationary for a few seconds, the visual indication turns off.

If the transmission is in drive (D) or any other forward gear, the side sensing system provides audible and visual warnings. When your vehicle is moving slowly, obstacles are detected within 24 in (60 cm) and are inside the driving path of your vehicle. If your vehicle remains stationary for a few seconds, the visual indication and audible warning turns off.

## LOCATING THE SIDE PARKING AID SENSORS



The side parking sensors are in the front and rear bumpers on both sides of the vehicle.

## SIDE PARKING AID AUDIBLE WARNINGS

When the side parking aid detects an object within the coverage area and the driving path of your vehicle, an audible warning sounds. As your vehicle moves closer to the object, the rate of the tone increases.

# Parking Aids

## PARKING AID INDICATORS

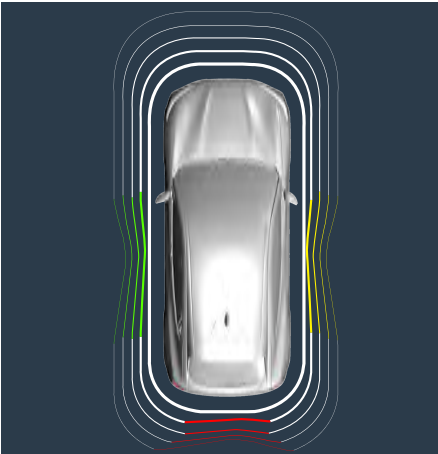

The system provides object distance indication through the information and entertainment display.

- As the distance to the object decreases, the indicator waves and the lines move toward the vehicle icon.
- If there is no object detected, the distance indicator lines are grey.

Visual indication remains on when your vehicle is in reverse (R). In any other gear, when you stop your vehicle, visual indication turns off after four seconds.

If the parking aids are not available, the side distance indicator lines do not display.

## PARKING AIDS – TROUBLESHOOTING

### PARKING AIDS – INFORMATION MESSAGES

If a fault is present in the parking aids, a warning message appears in the instrument cluster or the information and entertainment display.

Message	Action
Check Front Park Aid	The system detects a condition that requires service. Have your vehicle checked as soon as possible.
Check Rear Park Aid	The system detects a condition that requires service. Have your vehicle checked as soon as possible.
Front Park Aid On Off	Displays the park aid status.
Rear Park Aid On Off	Displays the park aid status.

# Rear View Camera

## WHAT IS THE REAR VIEW CAMERA

The rear view camera provides a video image of the area behind your vehicle when the transmission is in reverse (R).

## REAR VIEW CAMERA PRECAUTIONS



**WARNING:** The rear view camera system is a reverse aid supplement device that still requires the driver to use it in conjunction with the interior and exterior mirrors for maximum coverage.



**WARNING:** Objects that are close to either corner of the bumper or under the bumper, might not be seen on the screen due to the limited coverage of the camera system.



**WARNING:** Reverse your vehicle slowly. Failure to follow this instruction could result in the loss of control of your vehicle, personal injury or death.



**WARNING:** Use caution when the rear cargo door is ajar. If the rear cargo door is ajar, the camera will be out of position and the video image could be incorrect. All guide lines disappear when the rear cargo door is ajar. Failure to follow this instruction could result in personal injury.



**WARNING:** Use caution when turning camera features on or off when the transmission is not in park (P). Make sure your vehicle is not moving.

**Note:** If the image comes on while the transmission is not in reverse (R), have the system inspected by your authorized dealer.

## LOCATING THE REAR VIEW CAMERA

The rear view camera is on the luggage compartment door. It provides a video image of the area behind your vehicle.

## REAR VIEW CAMERA GUIDE LINES

**Note:** Active guide lines and fixed guide lines are only available when the transmission is in reverse (R).

**Note:** The centerline is only available if the active or fixed guide lines are on.

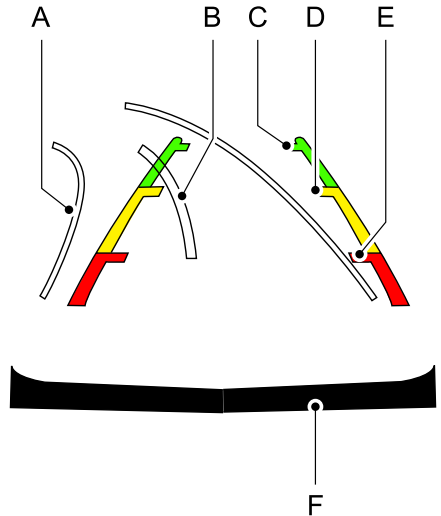

- A. Active guide lines.
- B. Centerline.
- C. Fixed guide line: Green zone.

# Rear View Camera

- D. Fixed guide line: Yellow zone.
- E. Fixed guide line: Red zone.
- F. Rear bumper.

Active guide lines only show with fixed guide lines. To use active guide lines, turn the steering wheel to point the guide lines toward an intended path. If the steering wheel position changes while reversing, your vehicle might deviate from the intended path.

The fixed and active guide lines fade in and out depending on the steering wheel position. The active guide lines do not display when the steering wheel position is straight.

Use caution while reversing. Objects in the red zone are closest to your vehicle and objects in the green zone are farther away. Objects get closer to your vehicle as they move from the green zone to the yellow or red zones. Use the side view mirrors and rear view mirror to get better coverage on both sides and rear of your vehicle.

## REAR VIEW CAMERA OBJECT DISTANCE INDICATORS

The system provides an image of your vehicle and the sensor zones. The zones highlight green, yellow, and red when the parking aid sensors detect an object in the coverage area.

## REAR VIEW CAMERA SETTINGS

### ZOOMING THE REAR VIEW CAMERA IN AND OUT



**WARNING:** When manual zoom is on, the full area behind your vehicle may not show. Be aware of your surroundings when using the manual zoom feature.

Selectable settings for this feature are zoom in (+) and zoom out (-). Press the symbol on the camera screen to change the view. The default setting is zoom off.

This allows you to get a closer view of an object behind your vehicle. The zoomed image keeps the bumper in the image to provide a reference. The zoom is only active while the transmission is in reverse (R).

**Note:** *Manual zoom is only available when the transmission is in reverse (R).*

**Note:** *Only the centerline shows when you enable manual zoom.*

### SWITCHING REAR VIEW CAMERA DELAY ON AND OFF

Access the vehicle drawer on the touchscreen.

1. Press **SETTINGS**.
2. Press **Driver Assistance**.
3. Switch **Rear View Camera Delay** on or off.

When shifting the transmission out of reverse (R) and into any gear other than park (P), the camera image remains in the display until:



## Rear View Camera

---

- Your vehicle speed reaches approximately 5 mph (8 km/h).
- You shift your vehicle into park (P).

# 360 Degree Camera

## WHAT IS THE 360 DEGREE CAMERA

The 360 degree camera system provides visibility around your vehicle in parking maneuvers such as:

- Centering in a parking space.
- Obstacles near your vehicle.
- Parallel parking.

The 360 degree camera system consists of front, side and rear cameras.

## HOW DOES THE 360 DEGREE CAMERA WORK

The 360 Degree Camera system:

- Allows you to see what is directly in front of or behind your vehicle.
- Provides a cross traffic view in front of and behind your vehicle.
- Allows you to see a top-down view of the area outside your vehicle, including the blind spots and obstacles near your vehicle.

## 360 DEGREE CAMERA PRECAUTIONS



**WARNING:** The 360 degree camera system still requires the driver to use it in conjunction with looking out of the windows, and checking the interior and exterior mirrors for maximum coverage.



**WARNING:** Objects that are close to either corner of the bumper or under the bumper, might not be seen on the screen due to the limited coverage of the camera system.



**WARNING:** Use caution when turning camera features on or off when the transmission is not in park (P). Make sure your vehicle is not moving.



**WARNING:** Do not switch the camera features on or off when your vehicle is moving.



**WARNING:** You are responsible for controlling your vehicle at all times. The system is designed to be an aid and does not relieve you of your responsibility to drive with due care and attention. Failure to follow this instruction could result in the loss of control of your vehicle, personal injury or death.

## 360 DEGREE CAMERA LIMITATIONS

**Note:** Use caution if a door is ajar. The 360 degree camera could be out of position and the image could be incorrect.

## LOCATING THE 360 DEGREE CAMERAS

### Rear View Camera

The rear view camera is on the liftgate. It provides a video image of the area behind your vehicle.

### Front View Camera

The front view camera is in the grille. It provides a video image of the area in front of your vehicle.

# 360 Degree Camera

## Side View Camera

The side view camera is on the outside mirror. It provides a video image of the area on the sides of your vehicle to aid you when parking.

## 360 DEGREE CAMERA GUIDE LINES

**Note:** Active guide lines are only available when the transmission is in reverse (R).

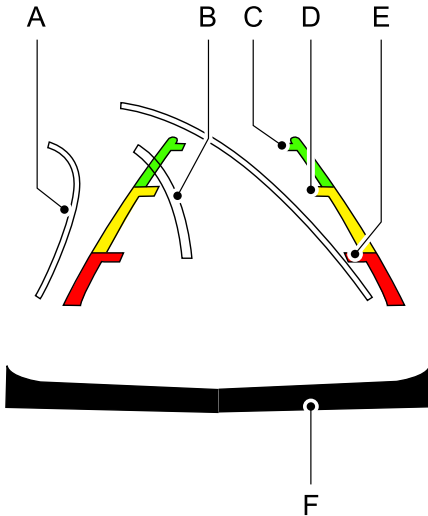

- A Active guide lines.
- B Centerline.
- C Fixed guide line: Green zone.
- D Fixed guide line: Yellow zone.

- E Fixed guide line: Red zone.
- F Rear bumper.

Active guide lines only show with fixed guide lines. Turn the steering wheel to point the guide lines toward an intended path. If the steering wheel position changes when reversing, your vehicle could deviate from the intended path.

The fixed and active guide lines fade in and out depending on the steering wheel position. The active guide lines do not display when the steering wheel position is straight.

Objects in the red zone are closest to your vehicle and objects in the green zone are farther away. Objects get closer to your vehicle as they move from the green zone to the yellow or red zones. Use the side view mirrors and rear view mirror to get better coverage on both sides and rear of your vehicle.

## Keep Out Zone

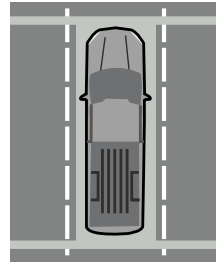

The keep out zone is represented by the yellow dotted lines running parallel to your vehicle.

# 360 Degree Camera

## 360 DEGREE CAMERA SETTINGS

### SWITCHING THE 360 DEGREE CAMERA ON AND OFF

1. Access the vehicle drawer on the touchscreen.
2. Press **CONTROLS**.
3. Press camera.

**Note:** When the camera button is pressed, the front 360 camera view is shown as default and other front camera views are accessed from the screen.

**Note:** The rear view camera activates when you switch into reverse (R).

The following camera views can be changed on the touchscreen:

- Normal view.
- Normal view with 360.
- Split view.

When in park (P), neutral (N) or drive (D), only the front images display when the button is pressed.

**Note:** The 360 degree camera system turns off when your vehicle is traveling at low speed, except when in reverse (R).

### SWITCHING THE 360 DEGREE CAMERA VIEW



Press to access the different camera views.



**Normal + 360 view:** Contains the normal camera view next to a 360 degree camera view.



**Normal view:** Provides an image of what is directly in front of or behind your vehicle.



**Split view:** Provides an extended view of what is in front of or behind your vehicle.



Zooms in on the image.

# Active Park Assist (If Equipped)

## WHAT IS ACTIVE PARK ASSIST

Assists you with parking in and out of parking spaces.

## HOW DOES ACTIVE PARK ASSIST WORK

Active park assist uses sensors to detect parking spaces. Active park assist controls steering, acceleration, braking and shifting as required to maneuver into or out of a parking space when activate.

## ACTIVE PARK ASSIST PRECAUTIONS



**WARNING:** You must remain in your vehicle when the system turns on. At all times, you are responsible for controlling your vehicle, supervising the system and intervening, if required. Failure to take care may result in the loss of control of your vehicle, serious personal injury or death.



**WARNING:** The sensors may not detect objects in heavy rain or other conditions that cause interference.



**WARNING:** You are responsible for controlling your vehicle at all times. The system is designed to be an aid and does not relieve you of your responsibility to drive with due care and attention. Failure to follow this instruction could result in the loss of control of your vehicle, personal injury or death.



**WARNING:** Do not use the system with accessories that extend beyond the front or rear of your vehicle, for example a trailer hitch or bike rack. The system is not able to make corrections for the additional length of the accessories.

## SWITCHING ACTIVE PARK ASSIST ON AND OFF



Press the parking aid button, then press the active park assist icon on the touchscreen to bring up full screen notifications.

Press the soft keys on the touchscreen to switch between the parallel park in, perpendicular park in, or parallel park out parking modes.

## Cancelling Active Park Assist

To cancel parking assistance at any time, shift out of neutral (N).

## Pausing Active Park Assist

To pause parking assistance at any time, release the parking aid button.

If you open the passenger or rear doors, active park assist pauses.

To resume parking, press and hold the parking aid button again.

## ENTERING A PARALLEL PARKING SPACE

1. Press the parking aid button.

**Note:** *The system detects other vehicles and curbs to find a parking space.*

2. Press the active park assist icon on the touchscreen.
3. Select parallel parking.

## Active Park Assist (If Equipped)

4. Use the turn signal lever to search for a parking space on the driver or passenger side of your vehicle.

**Note:** *If you do not use the turn signal lever, the system searches for a parking space on the passenger side of your vehicle.*

5. Drive your vehicle approximately 3 ft (1 m) away from and parallel to the other parked vehicles when searching for a parking space.

**Note:** *A tone sounds and a message appears in the information and entertainment display when active park assist finds a suitable parking space.*

6. Press and hold the brake pedal.
7. Release the steering wheel and shift into neutral (N).
8. Press and hold the active park assist button.
9. Release the brake pedal to allow your vehicle to park.

**Note:** *You can slow down your vehicle at any time by pressing the brake pedal.*

**Note:** *When parallel parking between objects, the system parks closer to the object in front of your vehicle to allow easier access to the luggage compartment.*

**Note:** *When parking is complete, your vehicle shifts into park (P).*

### ENTERING A PERPENDICULAR PARKING SPACE

1. Press the parking aid button.

**Note:** *Active park assist does not recognize parking space lines and centers your vehicle between objects.*

2. Press the active park assist icon on the touchscreen.
3. Select perpendicular parking.

4. Use the turn signal lever to search for a parking space on the driver or passenger side of your vehicle.

**Note:** *If you do not use the turn signal lever, the system searches for a parking space on the passenger side of your vehicle.*

5. Drive your vehicle approximately 3 ft (1 m) away from and perpendicular to the other parked vehicles when searching for a parking space.

**Note:** *A tone sounds and a message appears in the information and entertainment display when active park assist finds a parking space.*

6. Press and hold the brake pedal.
7. Release the steering wheel and shift into neutral (N).
8. Press and hold the active park assist button.
9. Release the brake pedal to allow the vehicle to park.

**Note:** *Active park assist backs your vehicle into parking spaces.*

**Note:** *Active park assist aligns the front end of your vehicle with the lane side of the object next to it.*

**Note:** *When the system detects only one object, it allows enough distance to open the door on either side.*

**Note:** *You can slow down your vehicle at any time by pressing the brake pedal.*

**Note:** *When parking is complete, your vehicle shifts into park (P).*

### EXITING A PARKING SPACE

Active park assist only assists leaving parallel parking spaces.

1. Press the parking aid button.
2. Press the active park assist icon on the touchscreen.

## Active Park Assist (If Equipped)

3. Select parallel park exit.
4. Use the turn signal to choose the direction to exit the parking space.
5. Press and hold the brake pedal.
6. Release the steering wheel and shift into neutral (N).
7. Release the parking brake.
8. Press and hold the active park assist button.
9. Release the brake pedal to allow your vehicle to move.

**Note:** After active park assist drives your vehicle to a position where you can exit the parking space in a forward movement, a message appears instructing you to take full control of your vehicle.

10. Take control of your vehicle.

**Note:** You can slow down your vehicle at any time by pressing the brake pedal.

### ACTIVE PARK ASSIST – TROUBLESHOOTING

#### ACTIVE PARK ASSIST – INFORMATION MESSAGES

Message	Action
Active Park Fault	The system requires service. Have your vehicle checked as soon as possible.

#### ACTIVE PARK ASSIST – FREQUENTLY ASKED QUESTIONS

##### Why does active park assist not operate correctly?

The system is unable to detect a vehicle, curb or object to park next to or in between. The system needs boundary objects to operate correctly.

##### Why does active park assist not search for a parking space?

You have switched traction control off.

##### Why does active park assist not search for a parking space?

The transmission is in reverse (R). Your vehicle must be moving forward to be able to detect a parking space.

##### Why does active park assist not offer a parking space?

The sensors could be blocked. For example, snow, ice or large accumulations of dirt. Blocked sensors can affect how the system functions.

##### Why does active park assist not offer a parking space?

The sensors in the front or rear bumper could be damaged.

## Active Park Assist (If Equipped)

---

### **Why does active park assist not offer a parking space?**

There is not enough room in the parking space for your vehicle to safely park.

### **Why does active park assist not offer a parking space?**

There is not enough space for the parking maneuver on the opposite side of the parking space.

### **Why does active park assist not offer a parking space?**

The parking space is more than 5 ft (1.5 m) or less than 2 ft (0.5 m) away from your vehicle.

### **Why does active park assist not offer a parking space?**

Your vehicle's speed is greater than 22 mph (35 km/h) for parallel parking or greater than 19 mph (30 km/h) for perpendicular parking.

### **Why does active park assist not offer a parking space?**

You recently disconnected or replaced the battery. After you reconnect the battery you must drive your vehicle on a straight road for a short period of time.

### **Why does active park assist not correctly position the vehicle into a parking space?**

An irregular curb along the parking space prevents the system from correctly aligning your vehicle.

### **Why does active park assist not correctly position the vehicle into a parking space?**

Vehicles or objects bordering the space could not be correctly parked.

### **Why does active park assist not correctly position the vehicle into a parking space?**

Your vehicle stopped too far past the parking space.

### **Why does active park assist not correctly position the vehicle into a parking space?**

The tires are not correctly installed or maintained. For example, using a spare tire, not inflated correctly, improper size, or of different sizes.

### **Why does active park assist not correctly position the vehicle into a parking space?**

A repair or alteration changed the detection capabilities.

### **Why does active park assist not correctly position the vehicle into a parking space?**

A parked vehicle has a high attachment. For example, a salt sprayer, snowplow or moving truck bed.

### **Why does active park assist not correctly position the vehicle into a parking space?**

The parking space length, or position of parked objects, changes after your vehicle passes the space.

### **Why does active park assist not correctly position the vehicle into a parking space?**

The temperature around your vehicle quickly changes. For example, driving from a heated garage into a cold outside temperature, or after leaving a car wash.





# Adaptive Cruise Control

## HOW DOES ADAPTIVE CRUISE CONTROL WITH STOP AND GO WORK

Adaptive cruise control with stop and go uses radar and camera sensors to maintain a set gap between your vehicle and the vehicle in front of you while following it to a complete stop. Stop and go can also be set to follow a vehicle directly in front of you and adjust the set speed, while you are at a complete stop.

## ADAPTIVE CRUISE CONTROL PRECAUTIONS

 **WARNING:** You are responsible for controlling your vehicle at all times. The system is designed to be an aid and does not relieve you of your responsibility to drive with due care and attention. Failure to follow this instruction could result in the loss of control of your vehicle, personal injury or death.

 **WARNING:** Pay close attention to changing road conditions such as entering or leaving a highway, on roads with intersections or roundabouts, roads without visible lanes of travel, roads that are winding, slippery, unpaved, or steep slopes.

 **WARNING:** The system is not a crash warning or avoidance system.

 **WARNING:** Do not use tire sizes other than those recommended because this can affect the normal operation of the system. Failure to do so may result in a loss of vehicle control, which could result in serious injury.

 **WARNING:** Do not use the system in poor visibility, for example fog, heavy rain, spray or snow.

## When Following a Vehicle

 **WARNING:** When following a vehicle that is braking, your vehicle does not always decelerate quickly enough to avoid a crash without driver intervention. Apply the brakes when necessary. Failure to follow this instruction could result in personal injury or death.

## Hilly Condition Usage

You should select a lower gear when the system is active in situations such as prolonged downhill driving on steep slopes, for example in mountainous areas.

## ADAPTIVE CRUISE CONTROL LIMITATIONS

### Sensor Limitations

 **WARNING:** On rare occasions, detection issues can occur due to the road infrastructures, for example bridges, tunnels and safety barriers. In these cases, the system may brake late or unexpectedly. At all times, you are responsible for controlling your vehicle, supervising the system and intervening, if required.

 **WARNING:** If the system malfunctions, have your vehicle checked as soon as possible.

 **WARNING:** Large contrasts in outside lighting can limit sensor performance.

# Adaptive Cruise Control

**WARNING:** The system only warns of vehicles detected by the radar sensor. In some cases there may be no warning or a delayed warning. Apply the brakes when necessary. Failure to follow this instruction could result in personal injury or death.

**WARNING:** The system may not detect stationary or slow moving vehicles below 6 mph (10 km/h).

**WARNING:** The system does not detect pedestrians or objects in the road.

**WARNING:** The system does not detect oncoming vehicles in the same lane.

**WARNING:** The system may not operate properly if the sensor is blocked. Keep the windshield free from obstruction.

**WARNING:** The sensor may incorrectly track lane markings as other structures or objects. This can result in a false or missed warning.

The camera is mounted on the windshield behind the interior mirror. The radar sensor is in the lower grille.

**Note:** You cannot see the sensor. It is behind a fascia panel.

**Note:** Keep the front of your vehicle free of dirt, metal badges or objects. Vehicle front protectors, aftermarket lights, additional paint or plastic coatings could also degrade sensor performance.

A message displays if something obstructs the camera or the sensor. When something blocks the sensor, the system cannot detect a vehicle ahead and does not function. See **Adaptive Cruise Control – Information Messages** (page 232).

The radar sensor has a limited field of view. It may not detect vehicles at all or detect a vehicle later than expected in some situations. The lead vehicle image does not illuminate if the system does not detect a vehicle in front of you.



- 1 Camera.
- 2 Radar sensor.

# Adaptive Cruise Control

## Detection Issues Can Occur:

A

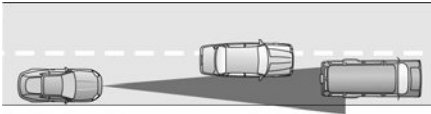

B



C

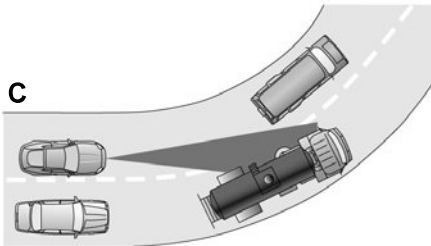

- A When driving on a different line than the vehicle in front.
- B With vehicles that edge into your lane. The system can only detect these vehicles once they move fully into your lane.
- C There may be issues with the detection of vehicles in front when driving into and coming out of a bend or curve in the road.

In these cases, the system may brake late or unexpectedly.

If something hits the front end of your vehicle or damage occurs, the radar-sensing zone could change. This could cause missed or false vehicle detection.

Optimal system performance requires a clear view of the road by the windshield-mounted camera.

Optimal performance may not occur if:

- The camera is blocked.
- There is poor visibility or lighting conditions.
- There are bad weather conditions.

## SWITCHING ADAPTIVE CRUISE CONTROL ON AND OFF

The cruise controls are on the steering wheel. See **Visual Search** (page 25).

### Switching Adaptive Cruise Control On



Press the button to activate the system. When the system activates, the set speed is equal to whichever is greater, the current vehicle speed, or 15 mph when in imperial units or 20 km/h when in metric units. If the speed is too low, or other conditions are not correct for adaptive cruise control activation, the system enters standby mode. When you are below 15 mph when in imperial units or 20 km/h when in metric units, adaptive cruise control does not activate unless you are following another vehicle.

The indicator, current gap setting and set speed appear in the instrument cluster display.

### Switching Adaptive Cruise Control Off



Press the button when the system is in standby mode or switch the ignition off.

**Note:** When you switch the system off, the set speed clears.

# Adaptive Cruise Control

## ADAPTIVE CRUISE CONTROL AUTOMATIC CANCELLATION

The system may cancel if:

- The tires lose traction.
- You apply the parking brake.

The system may cancel and set the parking brake if:

- You unbuckle the seatbelt and open the driver door after you stop your vehicle.
- Your vehicle is at a stop continuously for more than three minutes.

The system may deactivate or prevent activating when requested if:

- The vehicle has a blocked sensor.
- The brake temperature is too high.
- There is a failure in the system or a related system.

## SETTING THE ADAPTIVE CRUISE CONTROL SPEED

Drive to the speed you prefer.

**SET+**

Press the toggle button upward or downward to set the current speed.

**SET-**

Take your foot off the accelerator pedal.

The indicator, current gap setting and set speed appear in the instrument cluster display when you initially activate adaptive cruise control.

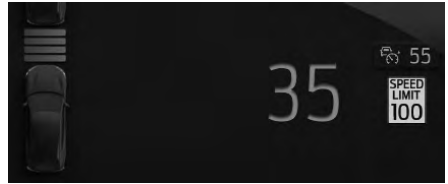

After a few seconds, the graphic in the instrument cluster display changes to show that adaptive cruise control is active.

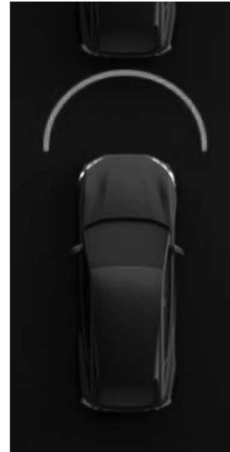

A vehicle image illuminates if there is a vehicle detected in front of you.

**Note:** When adaptive cruise control is active, the speedometer may vary slightly from the set speed displayed in the instrument cluster display.

# Adaptive Cruise Control

## Setting the Adaptive Cruise Speed from a Complete Stop

SET+

Press the toggle button upward or downward while keeping the brake pedal fully pressed.

SET-

The set speed adjusts to 15 mph when in imperial units or 20 km/h when in metric units.

The indicator, current gap setting and set speed appear in the instrument cluster display.

**Note:** *The system activates from a complete stop only when it detects a lead vehicle in close proximity.*

## Manually Changing the Set Speed

SET+

Press and release the toggle button upward to increase the set speed in small increments.

Press and hold the toggle button upward to increase the set speed in large increments. Release the button when the set speed is equal to the preferred speed.

SET-

Press and release the toggle button downward to decrease the set speed in small increments.

Press and hold the toggle button downward to decrease the set speed in large increments. Release the button when the set speed is equal to the preferred speed.

You can also press the accelerator or brake pedal until you reach the speed you prefer. Press the toggle button upward or downward to select the current speed as the set speed.

The system may apply the brakes to slow the vehicle to the new set speed. The set speed continuously displays in the instrument cluster display when the system is active.

## SETTING THE ADAPTIVE CRUISE CONTROL GAP



Press the button to cycle through the four gap settings.



The selected gap appears in the instrument cluster display as shown by the bars in the image.

**Note:** *The gap setting is time dependent and therefore, the distance adjusts with your vehicle speed.*

**Note:** *It is your responsibility to select a gap appropriate to the driving conditions.*

# Adaptive Cruise Control

## Adaptive Cruise Control Gap Settings

Graphic Display, Bars Indicated Between Vehicles	Gap Distance	Dynamic Behavior
1	Closest.	Sport.
2	Close.	Normal.
3	Medium.	Normal.
4	Far.	Comfort.

Each time you switch the system on, it selects the last chosen gap setting.

### Following a Vehicle

When a vehicle ahead of you enters the same lane or a slower vehicle is ahead in the same lane, the vehicle speed adjusts to maintain the gap setting.

**Note:** *When you are following a vehicle and you switch on a turn signal lamp, adaptive cruise control may provide a small, temporary acceleration to help you pass.*

Your vehicle maintains a consistent gap from the vehicle ahead until:

- The vehicle in front of you accelerates to a speed above the set speed.
- The vehicle in front of you moves out of the lane you are in.
- You set a new gap distance.

The system applies the brakes to slow down your vehicle to maintain a safe gap distance from the vehicle in front of you. The system only applies limited braking. You can override the system by applying the brakes.

**Note:** *The brakes may emit noise when applied by the system.*

If the system determines that its maximum braking level is not sufficient, an audible warning sounds, a message appears in the instrument cluster display and an indicator flashes when the system continues to brake. Take immediate action.

## CANCELING THE SET SPEED



Press the button or tap the brake pedal.

The set speed does not erase.

## RESUMING THE SET SPEED



Press the button.

Your vehicle speed returns to the previously set speed and gap setting. The set speed displays continuously in the instrument cluster display when the system is active.

**Note:** *Only use resume if you are aware of the set speed and intend to return to it.*

### Resuming the Set Speed from a Complete Stop

If your vehicle follows a vehicle to a complete stop and remains stationary for less than a few seconds, your vehicle accelerates from a stationary position to follow the vehicle ahead.

If your vehicle follows a vehicle to a complete stop and remains stationary for more than a few seconds, an indicator and message displays.

# Adaptive Cruise Control



<b>Message</b>	<b>Action</b>
Stopped	Cruise control does not resume automatically when this display is active.
Press Resume Button	If the lead vehicle begins to move, you are prompted to press the resume button. Press and release the button or use the accelerator pedal to resume following the lead vehicle.
Auto-Resume	Displays when on a limited access highway after following a vehicle to a complete stop. In this situation, the vehicle resumes following the lead vehicle without a button press or pressing the accelerator pedal. The system can remain in auto-resume state for approximately 30 seconds, after which it no longer automatically resumes.

# Adaptive Cruise Control

## OVERRIDING THE SET SPEED



**WARNING:** If you override the system by pressing the accelerator pedal, it does not automatically apply the brakes to maintain a gap from any vehicle ahead.

When you press the accelerator pedal, you override the set speed and gap distance.

Use the accelerator pedal to intentionally exceed the set speed limit.

When you override the system, the green indicator illuminates and the vehicle icon does not appear in the instrument cluster display.

The system resumes operation when you release the accelerator pedal. The vehicle speed decreases to the set speed, or a lower speed if following a slower vehicle.

## ADAPTIVE CRUISE CONTROL INDICATORS



Illuminates when you switch adaptive cruise control on. The color of the indicator changes to indicate the system status.

White indicates the system is on but inactive.

Green indicates that you set the speed and the system is active.

## SWITCHING FROM ADAPTIVE CRUISE CONTROL TO CRUISE CONTROL



**WARNING:** Normal cruise control will not brake when your vehicle is approaching slower vehicles. Always be aware of which mode you have selected and apply the brakes when necessary.

1. Access the vehicle drawer on the touchscreen.
2. Press **SETTINGS**.
3. Press **Driver Assistance**.
4. Press **Cruise Control**.
5. Press **Normal Cruise Control**.



The cruise control indicator replaces the adaptive cruise control indicator if you select normal cruise control. The gap setting does not display, and the system does not respond to lead vehicles. Automatic emergency braking remains active to maintain set speed. The system remembers the last setting when you start your vehicle.

## LANE CENTERING

### HOW DOES LANE CENTERING WORK

Adaptive cruise control with lane centering uses radar and camera sensors to help keep your vehicle in the middle of the lane by applying continuous assistance steering torque input toward the lane center on highways.

**Note:** *The adaptive cruise control gap setting operates normally.*



# Adaptive Cruise Control

If you drive off-center within the lane, the system sets and maintains that preferred lane position. The system provides continuous assistance steering torque input toward the preferred position.

**Note:** *The system can only set preferred lane positions within the lane.*

**Note:** *If the system cancels, the preferred position erases. On the next activation, the system provides continuous assistance steering torque input toward the lane center.*

## LANE CENTERING PRECAUTIONS



**WARNING:** Do not use the system when towing a trailer. Failure to follow this instruction could result in the loss of control of your vehicle, personal injury or death.



**WARNING:** Do not use the system if any changes or modifications to the steering wheel have been made. Any changes or modifications to the steering wheel could affect the functionality or performance of the system. Failure to follow this instruction could result in the loss of control of your vehicle, personal injury or death.

Adaptive cruise control precautions apply to lane centering unless stated otherwise or contradicted by a lane centering precaution. See **Adaptive Cruise Control Precautions** (page 221).

## LANE CENTERING REQUIREMENTS

You must keep your hands on the steering wheel at all times.

The system only activates when all of the following occur:

- You have adaptive cruise control with stop and go on.
- Lane centering assist is enabled in your information and entertainment screen. See **Switching Lane Centering On and Off** (page 230).
- You have your hands on the steering wheel.
- The system detects both lane markings.

**Note:** *If it does not detect valid lane markings, the system stays inactive until valid markings are available.*

## LANE CENTERING LIMITATIONS

Adaptive cruise control limitations apply to lane centering unless stated otherwise or contradicted by a lane centering limitation. See **Adaptive Cruise Control Limitations** (page 221).

Lane Centering may not correctly operate in any of the following conditions:

- The lane is too narrow or wide.
- The system does not detect at least one lane marking or when lanes merge or split.
- Limited steering torque input is applied.
- Areas under construction or new infrastructure.
- When modifications to the steering system have been made.
- When using a spare tire.
- In high wind conditions.

**Note:** *The driving assistance torque is limited and may not be sufficient for all driving situations such as driving through tight curves or driving through curves at high speeds.*

# Adaptive Cruise Control

**Note:** In exceptional conditions, such as inclement weather or direct sunlight, the system could deviate from the center line or could cancel.

## SWITCHING LANE CENTERING ON AND OFF

You must keep your hands on the steering wheel at all times.

The controls are on the steering wheel.



Press the button.

The indicator appears in the instrument cluster display. When the system is on, the color of the indicator changes to indicate the system status.

You can override the system at any time by steering your vehicle.

**Note:** The correct requirements must be met before you can switch the system on. See **Lane Centering Requirements** (page 229).

## Enabling and Disabling Lane Centering

1. Access the vehicle drawer on the touchscreen.
2. Press **SETTINGS**.
3. Press **Driver Assistance**.
4. Press **Cruise Control**.
5. Press **Adaptive Cruise Control**.
6. Press **Lane Centering Assist**.

## LANE CENTERING ALERTS

You must keep your hands on the steering wheel at all times.

When the system is active and detects no steering activity for a period of time, the system alerts you to put your hands on the steering wheel. If you do not react to the warnings the system cancels and slows your vehicle down to idle speeds while maintaining steering control. See **Lane Centering Automatic Cancellation** (page 230).

The system also alerts you if your vehicle crosses lane markings without detected steering activity.

**Note:** The system could detect a light grip or touch on the steering wheel as hands-off driving.

## LANE CENTERING AUTOMATIC CANCELLATION

When an external condition cancels the system, for example, no lane markings available, a tone sounds and a message appears in the instrument cluster display.

If your vehicle starts to slow down, you must provide steering input to the wheel and press the accelerator pedal to regain full system performance.

Automatic cancellation can also occur if:

- The lane becomes too wide or too narrow.
- The system cannot detect valid lane markings.
- Lane markings cross over one another.

**Note:** The system disables until the next key cycle if your vehicle slows down due to driver inactivity twice within a key cycle.

## LANE CENTERING INDICATORS



Illuminates when you switch lane centering on. The color of the indicator changes to indicate the system status.

# Adaptive Cruise Control

Gray indicates the system is on but inactive.

Green indicates the system is active and applying steering torque assistance input to keep your vehicle in the center of the lane.

Amber with an audible tone and then gray indicates a system automatic cancellation.

## INTELLIGENT ADAPTIVE CRUISE CONTROL

### HOW DOES INTELLIGENT ADAPTIVE CRUISE CONTROL WORK

Intelligent adaptive cruise control combines speed sign recognition and navigation map data with adaptive cruise control to adjust the cruise set speed to the speed limit detected by the speed sign recognition system. As the system detects new speed signs, the set speed updates.

There are limitations that affect the accuracy of the speed sign recognition system and its ability to determine the current speed limit. The intelligent adaptive cruise control system and its ability to determine the current speed limit shares these limitations. See **Speed Sign Recognition** (page 268).

**Note:** *The adaptive cruise control gap setting operates normally when the feature is enabled.*

## INTELLIGENT ADAPTIVE CRUISE CONTROL PRECAUTIONS



**WARNING:** You are responsible for controlling your vehicle at all times. The system is designed to be an aid and does not relieve you of your responsibility to drive with due care and attention. Failure to follow this instruction could result in the loss of control of your vehicle, personal injury or death.

## INTELLIGENT ADAPTIVE CRUISE CONTROL REQUIREMENTS

Traffic sign recognition must be enabled for intelligent adaptive cruise control to be active.

## INTELLIGENT ADAPTIVE CRUISE CONTROL LIMITATIONS

The speed limit information provided by the navigation map data could be inaccurate or out of date.

The system may not detect and read speed limit signs with conditional information, for example, when a sign is flashing, during specific time ranges, or when children are present.

**Note:** *The system does not set the vehicle speed to speed limits shown with a supplementary traffic sign.*

Under certain conditions, the system may not adjust the vehicle speed until after your vehicle passes the speed limit.

## SWITCHING INTELLIGENT MODE ON AND OFF

1. Access the vehicle drawer on the touchscreen.
2. Press **SETTINGS**.

# Adaptive Cruise Control

3. Press **Driver Assistance**.
4. Press **Cruise Control**.
5. Press **Adaptive Cruise Control**.
6. Press **Speed Sign Recognition**.

## ADJUSTING THE SET SPEED TOLERANCE

1. Access the vehicle drawer on the touchscreen.
2. Press **SETTINGS**.
3. Press **Driver Assistance**.
4. Press **Cruise Control**.
5. Press **Adaptive Cruise Control**.
6. Press **Speed Sign Recognition**.
7. Press **Tolerance**.
8. Use the slider bar to adjust the allowable tolerance for the system.

**Note:** You cannot set the tolerance more than 20 mph (30 km/h) above or below the recognized speed.

## INTELLIGENT ADAPTIVE CRUISE CONTROL ALERTS

If you increase the set speed beyond the speed limit or speed limit plus a positive tolerance value, the set speed indicator flashes.

The warning does not occur if:

- You override the set speed using the accelerator pedal.
- The vehicle speed exceeds the set speed due to being on a downhill slope.

## INTELLIGENT ADAPTIVE CRUISE CONTROL INDICATORS



A bracket appears around the set speed and the detected speed limit in the instrument cluster.

## ADAPTIVE CRUISE CONTROL – TROUBLESHOOTING

### ADAPTIVE CRUISE CONTROL – INFORMATION MESSAGES - VEHICLES WITH: LANE CENTERING

**Note:** Depending on your vehicle options and instrument cluster type, not all messages display or are available.

**Note:** The system could abbreviate or shorten certain messages depending upon which cluster type you have.

# Adaptive Cruise Control

---

<b>Message</b>	<b>Action</b>
Keep Hands on Steering Wheel	Return your hands to the steering wheel and provide steering input to cancel the message.
Lane Centering Assist Not Available	To reset the feature when the vehicle is stationary, return the gear selector to park and turn the engine off. Restart the engine with your foot on the brake pedal.
Resume Control	You must immediately take full control of the vehicle.
Press Accelerator Pedal to Resume	Resume adaptive cruise control with lane centering by applying foot pressure on the accelerator pedal. You can also resume the feature by pressing the resume button on the steering wheel.

# Adaptive Cruise Control

## ADAPTIVE CRUISE CONTROL – INFORMATION MESSAGES - VEHICLES WITH: STOP AND GO

**Note:** Depending on your vehicle options and instrument cluster type, not all messages display or are available.

**Note:** The system could abbreviate or shorten certain messages depending upon which cluster type you have.

Message	Action
Adaptive Cruise Malfunction	A malfunction is preventing the adaptive cruise from engaging.
Front Sensor Not Aligned	Contact an authorized dealer to have the radar checked for proper coverage and operation.
Adaptive Cruise Not Available	Conditions exist preventing the system from being available.
Adaptive Cruise Not Available Sensor Blocked See Manual	You have a blocked radar because of poor radar visibility due to inclement weather or ice, mud, or water in front of the radar. You can typically clean the sensor to resolve this. Due to the nature of radar technology, it is possible to get a blockage warning with no actual block. This happens, for example, when driving in sparse rural or desert environments. A false blocked condition either self clears, or clears after you restart your vehicle.
Normal Cruise Active Adaptive Braking Off	You have selected normal cruise control. The system does not brake or react to traffic.
Adaptive Cruise - Driver Resume Control	Displays when the adaptive cruise control is going to cancel and you must take control.
Adaptive Cruise Speed Too Low to Activate	Displays when the vehicle speed is too slow to activate the adaptive cruise control and there is no lead vehicle in range.

# BlueCruise - Vehicles With: Hands Free Driving

## WHAT IS BLUECRUISE

BlueCruise keeps your vehicle centered in the lane and offers a hands-free driving mode in certain situations when using adaptive cruise control.

## HOW DOES BLUECRUISE WORK

BlueCruise uses cameras to monitor your vehicle position within a lane and applies steering support to keep your vehicle centered in the lane.

Using the cameras and location information, BlueCruise allows you to remove your hands from the steering wheel and offers a hands-free driving mode in certain areas.

When active, BlueCruise uses a driver facing camera and infrared lighting to monitor your eyes and head position to detect if you are distracted. If the system determines you are distracted, it alerts you to return your eyes back to the road.

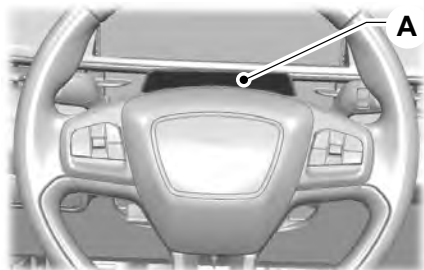



A Camera and lighting areas.

**Note:** When BlueCruise is active, in certain crash or near crash-like situations, such as an air bag deployment or hitting a road obstacle, camera data may record through the vehicle event data recorder. See **Event Data** (page 22).

**Note:** No data records under normal driving conditions.

## BLUECRUISE PRECAUTIONS

 **WARNING:** You are responsible for keeping your eyes on the road at all times. The system is designed to be an aid and does not relieve you of your responsibility to drive with due care and attention. Failure to follow this instruction could result in the loss of control of your vehicle, personal injury or death.

 **WARNING:** You are responsible for controlling your vehicle at all times. The system is designed to be an aid and does not relieve you of your responsibility to drive with due care and attention. Failure to follow this instruction could result in the loss of control of your vehicle, personal injury or death.

 **WARNING:** Obstructions to the driver facing camera or infrared lighting could prevent the system from properly operating. Keep the camera and lighting areas free from obstruction. Failure to follow this instruction could result in the loss of control of your vehicle, personal injury or death.

# BlueCruise - Vehicles With: Hands Free Driving



**WARNING:** Do not use the system if any changes or modifications to the steering wheel have been made. Any changes or modifications to the steering wheel could affect the functionality or performance of the system. Failure to follow this instruction could result in the loss of control of your vehicle, personal injury or death.



**WARNING:** The system may not function if the sensor is blocked.



**WARNING:** Pay close attention to changing road conditions such as entering or leaving a highway, on roads with intersections or roundabouts, roads without visible lanes of travel, roads that are winding, slippery, unpaved, or steep slopes.



**WARNING:** The system is not a crash warning or avoidance system.



**WARNING:** Large contrasts in outside lighting can limit sensor performance.



**WARNING:** The system attempts to keep your vehicle in the center of the lane as well as maintain speed and gap control. The system may not be able to perform these tasks in all situations. Do not use the system in complex or uncertain driving conditions. Failure to follow this instruction could result in the loss of control of your vehicle, personal injury or death.



**WARNING:** Your vehicle could drift out of the lane of travel. Always be prepared to manually steer your vehicle. Failure to follow this instruction could result in the loss of control of your vehicle, personal injury or death.



**WARNING:** The system will not operate if the sensor cannot track the road lane markings.

## BLUECRUISE REQUIREMENTS

BlueCruise only activates when all of the following occur:

- BlueCruise is enabled in your information and entertainment screen. See **BlueCruise Settings** (page 237).
- Adaptive cruise control is on.
- The system detects both lane markings.
- Your hands are on the steering wheel.
- Your eyes are on the road.

**Note:** *For hands-free mode to work, your vehicle must be on certain limited access divided freeways.*

**Note:** *The system may require updated software for hands-free mode. See **Vehicle System Updates** (page 387).*

## BLUECRUISE LIMITATIONS

Any of the following conditions could result in BlueCruise not correctly operating:

- You do not have your vehicle centered in the lane.
- The lane is too narrow or too wide.
- The system does not detect at least one lane marking or when lanes merge or split.
- You are applying a low amount of steering input.
- You are using the system in areas under construction.
- If you make any aftermarket modifications to the steering system.
- You are using a spare tire.



# BlueCruise - Vehicles With: Hands Free Driving

The driver-facing camera may not operate correctly due to any of the following:

- You have a pre-existing eye condition, such as an eye misalignment, or have had eye surgery.
- You cover your facial features by a mask, hat or other items.
- The lighting conditions change significantly.
- You are not in the field of view of the camera.
- You position or tilt yourself to one side.
- You are moving around extensively.
- You are wearing glasses or sunglasses that are too dark or reflective.

**Note:** *The system has limited steering assistance and may not be sufficient for all driving situations.*

**Note:** *In exceptional conditions, such as inclement weather or direct sunlight, the system could deviate from the center line.*

**Note:** *The information provided by the navigation map data could be inaccurate or out of date.*

## BLUECRUISE SETTINGS

### Enabling BlueCruise

1. Access the vehicle drawer on the touchscreen.
2. Press **SETTINGS**.
3. Press **Driver Assistance**.
4. Press **Cruise Control**.
5. Press **Lane Centering with Hands-Free**.

### Enabling Activation Prompts

1. Access the vehicle drawer on the touchscreen.
2. Press **SETTINGS**.

3. Press **Driver Assistance**.
4. Press **Cruise Control**.
5. Press **Activation Prompts**.

## SWITCHING BLUECRUISE ON AND OFF

### Switching BlueCruise On

The controls are on the steering wheel.

### Using Activation Prompts



When the prompt appears, press the button to switch BlueCruise on.

The indicator appears in the instrument cluster. When the system is on, the color of the indicator changes to indicate the system status.

**Note:** *You must enable activation prompts in the touchscreen.*

### Using Steering Wheel Controls



Using the adaptive cruise control and lateral support buttons, ensure both systems are active. BlueCruise activates.



### Switching BlueCruise Off



Press either the lateral support or adaptive cruise control button when system is active or in standby mode.



BlueCruise turns off through each ignition cycle.

# BlueCruise - Vehicles With: Hands Free Driving

## BLUECRUISE ALERTS

When BlueCruise is providing hands-on driving or transitioning to hands-on driving from hands-free driving and detects no steering activity for a certain period of time, the system alerts you with a message in the instrument cluster to put your hands on the steering wheel. After the first alert, the system alerts you with a message in the instrument cluster and an audible warning.

When BlueCruise is providing hands-on or hands-free driving and detects you are not looking at the road for a certain period of time, the system alerts you to return your eyes to the road. Depending on where you are looking, the alert can be a message in the instrument cluster and an audible warning.

If you do not react to the warnings, BlueCruise cancels, quickly activates and releases the brakes, and slows your vehicle down to low speeds while maintaining steering control.

If your vehicle slows down and you resume control, a message appears to prompt you to press the accelerator pedal to allow the system to resume.

**Note:** *If the system detects repeated inactivity, it disables until the next key cycle.*

## BLUECRUISE AUTOMATIC CANCELLATION

When an external condition cancels BlueCruise, for example, no lane markings available, a tone sounds and a message appears in the instrument cluster.



If your vehicle starts to slow down, you must take control of steering and press and release the button to reactivate BlueCruise.

System cancellation can also occur if:

- The lane becomes too narrow.
- The system cannot detect valid lane markings.
- Lane markings cross.
- Your eyes are not on the road or your hands are not the steering wheel.

If you have your hands on the steering wheel and your eyes are on the road when the feature is active and a cancellation occurs, the system sounds a tone and displays a cancelled graphic in the instrument cluster.

If you are not paying attention to the road or your hands are not on the steering wheel and a cancellation occurs, the system displays a message and a tone sounds until you resume control. If you do not resume control in time, BlueCruise quickly activates and releases the brakes, and slows your vehicle down to low speeds while maintaining steering control. If your vehicle slows down and you resume control, a message appears to prompt you to press the accelerator pedal to allow the system to resume.

**Note:** *The system disables until the next key cycle if it detects repeated inactivity.*

## BLUECRUISE INDICATORS



When on, the color of the indicator changes to indicate the status.

Gray indicates BlueCruise is on but inactive.

Green indicates BlueCruise is active and applying continuous steering support.

Blue indicates BlueCruise is active and hands-free driving mode is available.

# BlueCruise - Vehicles With: Hands Free Driving

## Hands-On Driving Support Available



When this indicator is present, you must keep your hands on the steering wheel.

## Hands-Free Driving Support Available



A graphic in the instrument cluster of a steering wheel without hands indicates the hands-free driving mode is available.

When this indicator is present, you can remove your hands from the steering wheel.

## BLUECRUISE – TROUBLESHOOTING

### BLUECRUISE – INFORMATION MESSAGES

Depending on your vehicle options and instrument cluster type, not all messages display or are available.

Message	Details
Keep Hands on Steering Wheel	Make sure you return your hands to the steering wheel and provide steering input.
Resume Control	The system is going to cancel and you must take control.
Watch the Road	Return your attention to the road.

## BlueCruise - Vehicles With: Hands Free Driving

Message	Details
BlueCruise not available	Conditions exist preventing the system from being available. If the message continues to display, have the system checked as soon as possible.
Press Accelerator Pedal to Resume	Press the accelerator pedal and follow the prompts.
Driver monitor camera cannot detect face See manual	Make sure your facial features are visible and in the field of view of the driver facing camera. It is possible that the steering column is positioned too high or low for the driver facing camera to see you, adjust the steering column or seat so your face is in the field of view.
Driver monitor camera is blocked See manual	Make sure your hands, arms or other objects are not obscuring the camera.
Driver monitor camera fault See manual	Conditions exist preventing the system from being available. If the message continues to display, have the system checked as soon as possible.
BlueCruise On Watch the road Be prepared to resume control	BlueCruise is active, keep your attention on the road.
BlueCruise available Press {ICON} to activate	The system is in standby mode, press the button on the steering wheel to activate.

**Note:** *The instrument cluster display may abbreviate or shorten certain messages depending on which cluster type you have.*

# Drive Mode Control

---

## WHAT IS DRIVE MODE CONTROL

Your vehicle has various drive modes that you can select for different driving conditions. Depending on the drive mode that you select, the system adjusts various vehicle settings, for example steering, instrument cluster graphics, ambient lighting, interior sound, handling and powertrain response.

## SELECTING A DRIVE MODE

1. Access the vehicle drawer on the touchscreen.
2. Press **CONTROLS**.
3. Press **Drive Modes**.
4. Press **Engage, Unbridled** or **Whisper**.

**Note:** *Drive mode changes may not be available when your vehicle is off.*

## DRIVE MODES

### ENGAGE - GT

For everyday driving. This mode is the perfect balance of excitement, comfort and convenience. Steering and active damping are tuned for normal driving. The interior lights and cluster graphics are set to soft blue and the battery state of charge gauge displays.

### ENGAGE

For everyday driving. This mode is the perfect balance of excitement, comfort and convenience. Steering is tuned for normal driving. The interior lights and cluster graphics are set to soft blue and the battery state of charge gauge displays.

### UNBRIDLED - GT

Unbridled mode is for sporty driving with improved performance handling and response. This mode increases acceleration response and provides a strong deceleration rate when you lift off the accelerator pedal. Unbridled mode makes your vehicle accelerate faster. Steering and active damping tunes for performance. The interior sound increases, and the ambient lights and cluster graphics are set to orange with a graphic that grows based on your acceleration and steering inputs.

### Unbridled Extend

This feature adjusts unbridled mode to provide high-performance driving and is for track and closed course use only. When activated, this mode provides balanced power output for lap time consistency. The accelerator pedal calibrates for improved propulsion control. The system provides more performance orientated traction and stability control. In this mode, traction and stability control intervention reduces and tunes specifically for track usage only. The interior sound has increased presence and the ambient lights and cluster graphics are set to orange with a graphic related to your acceleration and steering inputs.

To use this feature, you must be in unbridled mode with the unbridled extend slider selected with the battery at operating temperature. When using this mode, one pedal drive is not available and other driver assistance features disable.

**Note:** *This feature may not be available in temperatures below 32°F (0°C), or 59°F (15°C) for the battery.*

**Note:** *If the feature is not available, charge your vehicle until the battery has sufficient charge, and meets temperature conditions.*

# Drive Mode Control

---

## UNBRIDLED

This mode is for sporty driving with improved performance handling and response. This mode increases acceleration response and provides a strong deceleration rate when you lift off the accelerator pedal. Unbridled mode makes your vehicle accelerate faster. Steering tunes for performance. The interior sound increases, and the ambient lights and cluster graphics are set to orange with a graphic that grows based on your acceleration and steering inputs.

## WHISPER

Whisper mode is for relaxed driving and adverse weather conditions. This is the best mode for driving in slippery conditions. This mode decreases accelerator response at partial inputs. Steering tunes for comfort. When you release the accelerator pedal, your vehicle slowly decelerates allowing for a more comfortable ride. The interior sound turns off and the ambient lights and cluster graphics are set to blue with a graphic that starts to illuminate blue as you drive efficiently at consistent speeds.

## WHISPER - GT

Whisper mode is for relaxed driving and adverse weather conditions. This is the best mode for driving in slippery conditions. This mode decreases accelerator response at partial inputs. Steering and active damping tunes for comfort. When you release the accelerator pedal, your vehicle slowly decelerates allowing for a more comfortable ride. The interior sound turns off and the ambient lights and cluster graphics are set to blue with a graphic that starts to illuminate blue as you drive efficiently at consistent speeds.

# One Pedal Drive

## WHAT IS ONE PEDAL DRIVE

One pedal drive allows you to accelerate and brake using only the accelerator pedal. Pressing the accelerator down accelerates your vehicle, releasing pressure on the accelerator with your foot still on the pedal slows down your vehicle and releasing the pedal completely allows your vehicle to come to a complete stop.

## ONE PEDAL DRIVE PRECAUTIONS



**WARNING:** This system is an extra driving aid. It does not replace your attention and judgment, or the need to apply the brakes. This system does NOT automatically brake your vehicle. If you fail to press the brake pedal when necessary, you may collide with another vehicle.

Shifting into neutral (N) does not hold your vehicle at a standstill.

Shifting into drive (D) or reverse (R) does not cause the vehicle to move.

**Note:** *Always check the transmission selection before accelerating.*

## ONE PEDAL DRIVE LIMITATIONS

One pedal drive is unavailable when any of the following occur:

- Shifting into an incorrect transmission position, such as park (P) when driving.
- Using active park assist.
- Using cruise control.

Releasing the accelerator pedal may not bring your vehicle to a complete stop at high speeds and steep grades.

## SWITCHING ONE PEDAL DRIVE ON AND OFF

1. Access the vehicle drawer on the touchscreen.
2. Press **CONTROLS**.
3. Press **Drive Modes**.
4. Switch **1-Pedal Drive** on or off.

## ONE PEDAL DRIVE INDICATORS



When one pedal drive is active, the indicator displays in the instrument cluster.

# Lane Keeping System

## WHAT IS THE LANE KEEPING SYSTEM

The lane keeping system alerts you by providing temporary steering assistance or steering wheel vibration when it detects an unintended lane departure.

## HOW DOES THE LANE KEEPING SYSTEM WORK

The lane keeping system uses a forward looking camera mounted on the windshield to monitor vehicle movement within the travel lane.

When the camera detects a drift out of the travel lane, the lane keeping system alerts the driver by vibrating the steering wheel, or aids the driver by providing a small steering input to move the vehicle back into the travel lane.

The driver can select one of three modes:

- Alert (If Equipped)
- Aid
- Alert + Aid

## LANE KEEPING SYSTEM PRECAUTIONS



**WARNING:** You are responsible for controlling your vehicle at all times. The system is designed to be an aid and does not relieve you of your responsibility to drive with due care and attention. Failure to follow this instruction could result in the loss of control of your vehicle, personal injury or death.



**WARNING:** The system will not operate if the sensor cannot track the road lane markings.



**WARNING:** The sensor may incorrectly track lane markings as other structures or objects. This can result in a false or missed warning.



**WARNING:** In cold and severe weather conditions the system may not function. Rain, snow and spray can all limit sensor performance.



**WARNING:** The system may not operate properly if the sensor is blocked. Keep the windshield free from obstruction.



**WARNING:** If damage occurs in the immediate area surrounding the sensor, have your vehicle checked as soon as possible.



**WARNING:** The system may not correctly operate if your vehicle is fitted with a suspension kit not approved by us.



**WARNING:** Large contrasts in outside lighting can limit sensor performance.

## LANE KEEPING SYSTEM LIMITATIONS

The lane keeping system only operates when the vehicle speed is greater than 40 mph (64 km/h).

The system works when the camera can detect at least one lane marking.

The lane keeping system may not correctly operate in any of the following conditions:

- The lane keeping system does not detect at least one lane marking.
- You switch the turn signal on.



# Lane Keeping System

- You apply direct steering, accelerate fast or brake hard.
- The vehicle speed is less than 40 mph (64 km/h).
- The anti-lock brake, stability control or traction control system activates.
- The lane is too narrow.
- Something is obscuring the camera or it is unable to detect the lane markings due to environment, traffic or vehicle conditions.

The lane keeping system may not correct lane positioning in any of the following conditions:

- High winds.
- Uneven road surfaces.
- Heavy or uneven loads.
- Incorrect tire pressure.

## SWITCHING THE LANE KEEPING SYSTEM ON AND OFF



To activate the lane keeping system, press the button on the steering wheel.

To deactivate the lane keeping system, press the button again.

**Note:** When switching the system on or off a message appears in the information and entertainment display to show the status.

**Note:** The system stores the on or off setting until manually changed, unless it detects a MyKey™. If the system detects a MyKey™, it defaults to the last setting for that MyKey™.

**Note:** If the system detects a MyKey™, pressing the button does not affect the on or off status of the system. You can only change the mode and intensity settings.

## SWITCHING THE LANE KEEPING SYSTEM MODE

The lane keeping system has different settings that you can view or adjust using the information display.

- Alert (If Equipped)
- Aid
- Alert and Aid

The system permanently stores the last known selection for each setting.

To change the lane keeping system mode, access the vehicle drawer on the touchscreen:

1. Press **SETTINGS**.
2. Press **Driver Assistance**.
3. Press **Lane-Keeping System**.
4. Press **Lane-Keeping Mode**.
5. Select a setting.

**Note:** The system remembers the last setting when you start your vehicle.

## LANE KEEPING SYSTEM SETTINGS

### Adjusting the Steering Wheel Vibration Intensity

1. Access the vehicle drawer on the touchscreen.
2. Press **SETTINGS**.
3. Press **Driver Assistance**.
4. Press **Lane-Keeping System**.
5. Press **Lane-Keeping Intensity**.
6. Select a setting.

**Note:** This setting is not available in all modes.

# Lane Keeping System

## ALERT MODE

### WHAT IS ALERT MODE

Alert mode vibrates the steering wheel when it detects an unintended lane departure.

### HOW DOES ALERT MODE WORK

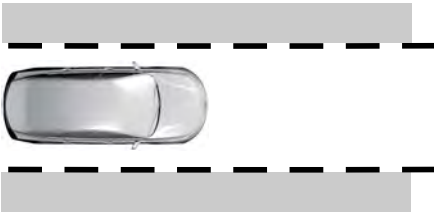

When in alert mode, the lane keeping system alerts you by vibrating the steering wheel. The intensity of the vibration is set through the lane keeping system menu.

## AID MODE

### WHAT IS AID MODE

Aid mode provides temporary steering assistance toward the center of the lane.

## HOW DOES AID MODE WORK

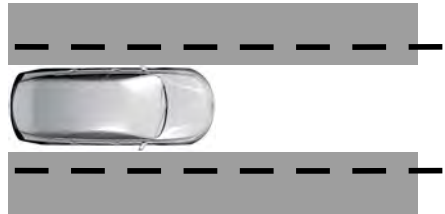

The lane keeping system aids you when an unintentional lane departure occurs. The system provides a small steering input to move the vehicle towards the center of the lane.

## ALERT AND AID MODE

### WHAT IS ALERT AND AID MODE

Alert and aid mode uses multiple features to keep you in your lane. The system first provides a small steering input to bring your vehicle back towards the center of the lane. If your vehicle moves too far out of the center of the lane the system alerts you with vibration in the steering wheel.

# Lane Keeping System

## HOW DOES ALERT AND AID MODE WORK

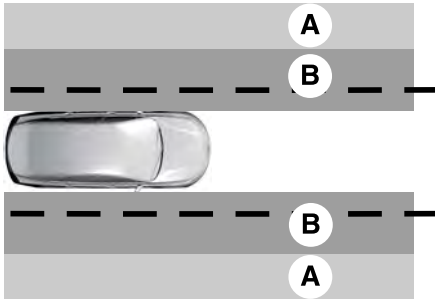

- A Alert.
- B Aid.

The lane keeping system detects a lane departure and provides aid when the vehicles enters **B** and applies the additional alert warning if **A** is entered.

## LANE KEEPING SYSTEM INDICATORS

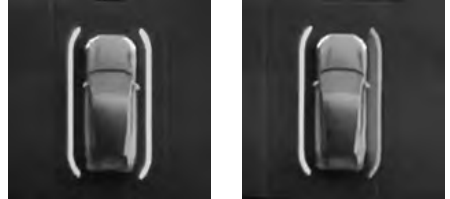

If you switch the lane keeping system on, a graphic with lane markings appears in the information display.

When you switch the system off, the lane marking graphics do not display.

**Note:** *The overhead vehicle graphic may still display if adaptive cruise control is enabled.*

While the lane keeping system is on, the color of the lane markings change to indicate the system status.

Gray	Green	Yellow	Red
Indicates that the system is temporarily unavailable to provide a warning or intervention on the indicated side.	Indicates that the system is available or ready to provide a warning or intervention on the indicated side.	Indicates that the system is providing or has just provided a lane keeping aid intervention.	Indicates that the system is providing or has just provided a lane keeping alert warning.

## BLIND SPOT ASSIST

### WHAT IS BLIND SPOT ASSIST

Blind spot assist is an extension of the lane keeping system.

It may help you identify adjacent vehicles during a lane change.

Blind spot assist provides a blind spot warning and steering assistance to help during lane changes.

# Lane Keeping System

## HOW DOES BLIND SPOT ASSIST WORK



Activate and deactivate the system using the lane keeping system button on the steering wheel.

During lane changes, the design of the blind spot assist feature detects vehicles in, or approaching, your blind spot and provides a warning, plus steering assistance to direct your vehicle back into your lane.

When active, this system functions with or without the use of direction indicators and hazard flashers.

You must keep your hands on the steering wheel at all times.

## BLIND SPOT ASSIST LIMITATIONS

All system limitations present in the basic lane keeping system also apply to blind spot assist.

## BLIND SPOT ASSIST INDICATORS

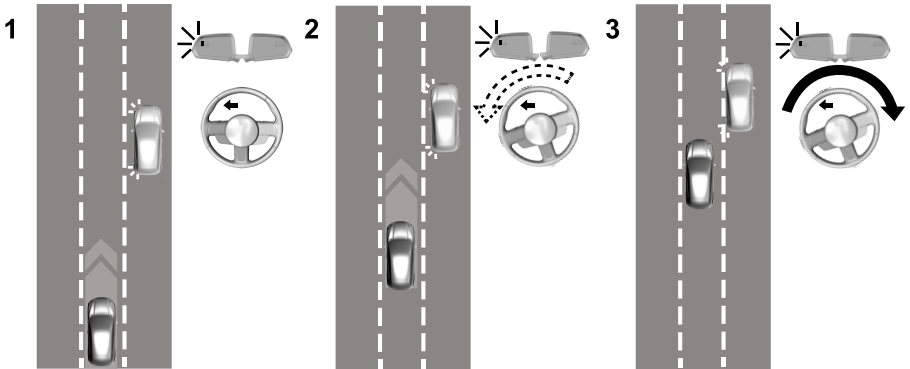

Blind spot assist does not function under the following conditions:

- The system does not detect lane markings.
- One or both rear radar sensors become blocked or faulty.
- You attach a trailer with a wiring connection to your vehicle.

**Note:** *Blind spot assist may have reduced performance if you attach a trailer to your vehicle without a wiring connection.*

Blind spot assist may have difficulty detecting hazards under the following conditions:

- If a vehicle is approaching in an adjacent lane at a relative speed much higher than your vehicle.
- Bad weather conditions are present that obstruct the sensors.
- You attach a bicycle rack to your vehicle.

# Lane Keeping System

The lane keeping aid warning lamp or yellow lane marking in your instrument cluster indicate blind spot assist activation. In addition, the blind spot information

system alert indicator flashes on the exterior mirror on the same side as the detection. For more information See **Blind Spot Information System** (page 252).

## Blind Spot Assist Information Messages

Message	Details
Blind Spot Assist Not Available Trailer Attached	Displays if you attach a trailer to your vehicle.
Blind Spot Assist Not Available Side Sensor Blocked	Displays if the blind spot information system sensors are blocked.
Blind Spot Assist System fault	The system has detected a fault that requires service. Have your vehicle checked as soon as possible.

For more information See **Blind Spot Information System** (page 252).

## LANE KEEPING SYSTEM – TROUBLESHOOTING

### LANE KEEPING SYSTEM – INFORMATION MESSAGES

Message	Action
Lane Keeping Sys. Malfunction Service Required	The system has malfunctioned. Have your vehicle checked as soon as possible.
Front Camera Temporarily Not Available	The system has detected a condition that has caused the system to be temporarily unavailable.
Front Camera Low Visibility Clean Screen	The system has detected a condition that requires you to clean the windshield in order for it to operate properly.
Front Camera Malfunction Service Required	The system has malfunctioned. Have your vehicle checked as soon as possible.
Keep Hands on Steering Wheel	The system requests that you keep your hands on the steering wheel.

# Lane Keeping System

## LANE KEEPING SYSTEM – FREQUENTLY ASKED QUESTIONS

<b>Why is the feature not available (lane markings are gray) when I can see the lane markings on the road?</b>
Your vehicle speed is less than 40 mph (65 km/h).
The sun is shining directly into the camera lens.
A quick intentional lane change has occurred.
Your vehicle stays too close to the lane markings for an extended interval of time.
Driving at high speeds in curves.
The last alert warning or aid intervention occurred a short time ago.
Ambiguous lane markings, for example, in construction zones.
Rapid transition from light to dark, or from dark to light.
Sudden offset in lane markings.
ABS or AdvanceTrac™ is active.
There is a camera blockage due to dirt, grime, fog, frost or water on the windshield.
You are driving too close to the vehicle in front of you.
Transitioning between no lane markings to lane markings, or vice versa.
There is standing water on the road.
Faint lane markings, for example, partial yellow lane markings on concrete roads.
Lane width is too narrow or too wide.
You have not calibrated the camera after a windshield replacement.
Driving on tight or on uneven roads.

# Lane Keeping System

---

**Why does the vehicle not come back toward the middle of the lane, as expected, in the Aid, or Aid + Alert mode?**

High cross winds are present.

There is a large road crown.

Rough roads, grooves or shoulder drop-offs.

Heavy, uneven loading of the vehicle or improper tire inflation pressure.

You changed the tires or modified the suspension.

# Blind Spot Information System

## WHAT IS BLIND SPOT INFORMATION SYSTEM

Blind spot information system detects vehicles that may have entered the blind spot zone.

## HOW DOES BLIND SPOT INFORMATION SYSTEM WORK

Blind spot information system uses sensors on both sides of your vehicle, detecting rearward from the exterior mirrors to approximately 13 ft (4 m) beyond the rear bumper. The detection area extends to approximately 59 ft (18 m) beyond the rear bumper when the vehicle speed is greater than 30 mph (48 km/h) to alert you of faster approaching vehicles.

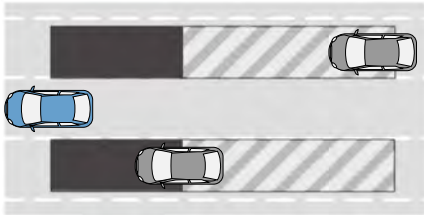

## BLIND SPOT INFORMATION SYSTEM PRECAUTIONS



**WARNING:** Do not use the blind spot information system as a replacement for using the interior and exterior mirrors or looking over your shoulder before changing lanes. The blind spot information system is not a replacement for careful driving.



**WARNING:** The system may not operate properly during severe weather conditions, for example snow, ice, heavy rain and spray. Always drive with due care and attention. Failure to take care may result in a crash.

**Note:** *Blind spot information system does not prevent contact with other vehicles. It does not detect parked vehicles, pedestrians, animals or other infrastructure.*

## BLIND SPOT INFORMATION SYSTEM LIMITATIONS

Blind spot information system does not operate in park (P) or reverse (R).

The system may not alert you if a vehicle quickly passes through the detection zone.

## BLIND SPOT INFORMATION SYSTEM REQUIREMENTS

Blind spot information system turns on when all the following occur:

- You start your vehicle.
- You shift into drive (D).
- The vehicle speed is greater than 6 mph (10 km/h).

## SWITCHING BLIND SPOT INFORMATION SYSTEM ON AND OFF

To switch blind spot information system on or off, use the touchscreen:

1. Access the vehicle drawer.
2. Press **SETTINGS**.
3. Press **Driver Assistance**.



# Blind Spot Information System

## 4. Switch **Blind Spot Information System** on or off.

When you switch blind spot information system off, a warning lamp illuminates and a message displays. When you switch the system on or off, the alert indicators flash twice.

**Note:** The system remembers the last setting when you start your vehicle.

To permanently switch the system off, contact an authorized dealer.

## LOCATING THE BLIND SPOT INFORMATION SYSTEM SENSORS

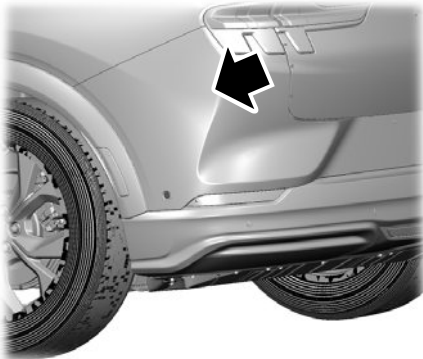

The sensors are behind the rear bumper on both sides of your vehicle.

**Note:** Keep the sensors free from snow, ice and large accumulations of dirt.

**Note:** Do not cover the sensors with bumper stickers, repair compound or other objects.

**Note:** Bike and cargo racks could cause false alerts due to obstruction of the sensor. We recommend switching the feature off when using a bike or cargo rack.

**Note:** Blocked sensors may affect system accuracy.

If the sensors become blocked, a message may appear in the information display. See **Blind Spot Information System – Information Messages** (page 254). The alert indicators remain illuminated but the system does not alert you.

## BLIND SPOT INFORMATION SYSTEM INDICATORS



When blind spot information system detects a vehicle, an alert indicator illuminates in the exterior mirror on the side the approaching vehicle is coming from. If you turn the turn signal on for that side of your vehicle, the alert indicator flashes.

# Blind Spot Information System

---

## BLIND SPOT INFORMATION SYSTEM – TROUBLESHOOTING

### BLIND SPOT INFORMATION SYSTEM – INFORMATION MESSAGES

<b>Message</b>	<b>Action</b>
Blind Spot System Fault	A fault with the system has occurred. Have your vehicle checked as soon as possible.
Blind Spot Not Available Sensor Blocked See Manual	Something is blocking the sensors. Clean the sensors.

# Cross Traffic Alert

## WHAT IS CROSS TRAFFIC ALERT

The system alerts you of vehicles approaching from the sides behind your vehicle when you shift into reverse (R).

## HOW DOES CROSS TRAFFIC ALERT WORK

Cross traffic alert detects vehicles that approach at a speed between 4–37 mph (6–60 km/h). Coverage decreases when the sensors are partially, mostly or fully obstructed.

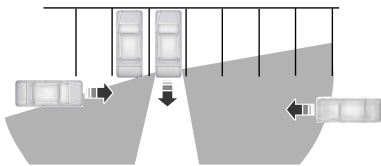

The sensor on the left-hand side is only partially obstructed and zone coverage on the right-hand side is maximized.

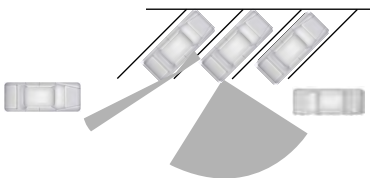

Zone coverage also decreases when parking at narrow angles. The sensor on the left-hand side is mostly obstructed and zone coverage on that side is severely reduced.

**Note:** *Slowly reversing helps increase the coverage area and effectiveness.*

## CROSS TRAFFIC ALERT PRECAUTIONS

**⚠️ WARNING:** Do not use the cross traffic alert system as a replacement for using the interior and exterior mirrors or looking over your shoulder before reversing out of a parking space. The cross traffic alert system is not a replacement for careful driving.

**⚠️ WARNING:** The system may not operate properly during severe weather conditions, for example snow, ice, heavy rain and spray. Always drive with due care and attention. Failure to take care may result in a crash.

## CROSS TRAFFIC ALERT LIMITATIONS

Cross traffic alert may not correctly operate when any of the following occur:

- Something is blocking the sensors.
- Adjacently parked vehicles or objects are obstructing the sensors.
- Vehicles approach at speeds less than 4 mph (6 km/h) or greater than 37 mph (60 km/h).
- Your vehicle speed is greater than 7 mph (12 km/h).
- You reverse out of an angled parking space.

## SWITCHING CROSS TRAFFIC ALERT ON AND OFF

To switch cross traffic alert on or off use the touchscreen:

1. Access the vehicle drawer.
2. Press **SETTINGS**.

## Cross Traffic Alert

3. Press **Driver Assistance**.
4. Switch **Cross Traffic Alert** on or off.

When you switch the system on or off, the alert indicators flash twice.

**Note:** The system turns on every time you start your vehicle. To permanently switch the system off, contact an authorized dealer.

### LOCATING THE CROSS TRAFFIC ALERT SENSORS

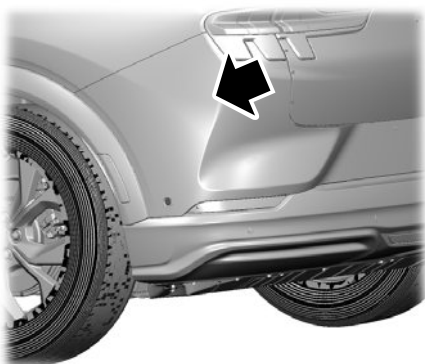

The sensors are behind the rear bumper on both sides of your vehicle.

**Note:** Keep the sensors free from snow, ice and large accumulations of dirt.

**Note:** Do not cover the sensors with bumper stickers, repair compound or other objects.

**Note:** Blocked sensors may affect system accuracy.

**Note:** Bike and cargo racks could cause false alerts due to obstruction of the sensor. We recommend switching the feature off when using a bike or cargo rack.

If something is blocking the sensors, a message may appear in the information display when you shift into reverse (R).

### CROSS TRAFFIC ALERT INDICATORS



When the cross traffic alert detects an approaching vehicle, a tone sounds, a warning lamp illuminates in the relevant exterior mirror and arrows appear in the information display to show which side the vehicle is approaching from.

If the system malfunctions, a warning lamp illuminates in the instrument cluster and a message appears in the information display. Have your vehicle checked as soon as possible.

**Note:** If arrows do not display, a message appears in the information display.

**Note:** In some conditions, the system could alert you, even when there is nothing in the detection zone, for example a vehicle passing further away from your vehicle.

# Cross Traffic Alert

---

## CROSS TRAFFIC ALERT – TROUBLESHOOTING

### CROSS TRAFFIC ALERT – INFORMATION MESSAGES

<b>Message</b>	<b>Action</b>
Cross Traffic Alert	Displays instead of indication arrows when the system detects a vehicle. Check for approaching traffic.
Cross Traffic Not Available Sensor Blocked See Manual	Indicates blocked cross traffic alert system sensors. Clean the sensors. If the message continues to appear, have your vehicle checked as soon as possible.
Cross Traffic System Fault	The system has malfunctioned. Have your vehicle checked as soon as possible.

# Pre-Collision Assist

## WHAT IS PRE-COLLISION ASSIST

Pre-collision assist detects and warns of approaching hazards in the roadway. If your vehicle is rapidly approaching another stationary vehicle, a vehicle traveling in the same direction as yours, or a pedestrian within your driving path, the system provides multiple levels of assistance to help avoid a collision.

## HOW DOES PRE-COLLISION ASSIST WORK

The system warns the driver of potential hazards by providing three levels of assistance.



If your vehicle is rapidly approaching potential hazards the system provides the following levels of functionality:

1. Alert.
2. Brake Support.
3. Automatic Emergency Braking.



**Alert:** When active, a flashing visual warning appears and an audible warning tone sounds.

**Brake Support:** The system is designed to help reduce the impact speed by preparing the brakes for rapid braking. The system does not automatically apply the brakes. If you press the brake pedal, the system could apply additional braking up to maximum braking force, even if you lightly press the brake pedal.

**Automatic Emergency Braking:** Automatic emergency braking may activate if the system determines that a collision is imminent.

**Note:** If you perceive pre-collision assist alerts as being too frequent or disturbing, then you can reduce the alert sensitivity, although the manufacturer recommends using the highest sensitivity setting where possible. Setting lower sensitivity would lead to fewer and later system warnings.

Each system has various levels of detection capabilities. See **Pre-Collision Assist Limitations** (page 259).

## PRE-COLLISION ASSIST PRECAUTIONS



**WARNING:** You are responsible for controlling your vehicle at all times. The system is designed to be an aid and does not relieve you of your responsibility to drive with due care and attention. Failure to follow this instruction could result in the loss of control of your vehicle, personal injury or death.



**WARNING:** The system does not detect vehicles moving in a different direction or animals. Apply the brakes when necessary. Failure to follow this instruction could result in the loss of control of your vehicle, personal injury or death.



**WARNING:** The system does not operate during hard acceleration or steering. Failure to take care may lead to a crash or personal injury.



**WARNING:** The system may fail or operate with reduced function during cold and severe weather conditions. Snow, ice, rain, spray and fog can adversely affect the system. Keep the front camera and radar free of snow and ice. Failure to take care may result in the loss of control of your vehicle, serious personal injury or death.

# Pre-Collision Assist



**WARNING:** Take additional care if your vehicle is heavily loaded or you are towing a trailer. These conditions could result in reduced performance of this system. Failure to follow this instruction could result in the loss of control of your vehicle, personal injury or death.



**WARNING:** The system cannot help prevent all crashes. Do not rely on this system to replace driver judgment and the need to maintain a safe distance and speed.



**WARNING:** In situations where the vehicle camera has limited detection capability, this may reduce system performance. These situations include but are not limited to direct or low sunlight, vehicles at night without tail lights, unconventional vehicle types, pedestrians with complex backgrounds, running pedestrians, partly obscured pedestrians, or pedestrians that the system cannot distinguish from a group. Failure to take care may result in the loss of control of your vehicle, serious personal injury or death.

## PRE-COLLISION ASSIST LIMITATIONS

Pre-collision assist depends on the detection ability of its camera and sensors. Any obstructions or damage to these areas can limit detection or prevent the system from functioning. See **Locating the Pre-Collision Assist Sensors** (page 260).

The system is active at speeds above 3 mph (5 km/h)

**Note:** *Brake support and automatic emergency braking are active up to the maximum speed of the vehicle.*

## Pedestrian Detection Limitations

Pedestrian detection is active at speeds up to 50 mph (80 km/h).

Pedestrian detection functions optimally when detected hazards are clearly identifiable. System performance may reduce in situations where pedestrians are running, partly obscured, have a complex background, or cannot be distinguished from a group.

## Cyclist Detection Limitations

Cyclist detection is active at speeds up to 50 mph (80 km/h).

Cyclist detection functions optimally when detected hazards are clearly identifiable. System performance may reduce in situations where cyclists are fast-moving, partly obscured, have a complex background, or cannot be distinguished from a group.

## Intersection Assist

The pre-collision assist system may operate in a scenario where you are turning across an oncoming vehicle's path. Detection of vehicles driving in an oncoming direction is active if your vehicle is driving at speeds up to 19 mph (30 km/h).

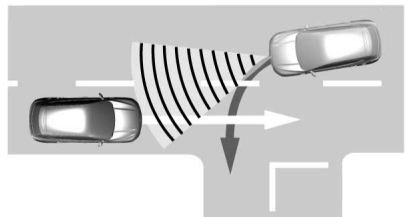

# Pre-Collision Assist

## SWITCHING PRE-COLLISION ASSIST ON AND OFF

You cannot switch the system off.

### Adjusting the Pre-Collision Assist Settings

You can adjust the following settings by using the touchscreen controls in the pre-collision assist menu:

- Change alert and distance alert sensitivity to one of three possible settings.
- Switch distance indication and alert on or off.
- If required, switch automatic emergency braking on or off.
- If required, switch evasive steering assist on or off.

**Note:** *Automatic emergency braking and evasive steering automatically turns on every time you switch the ignition on.*

**Note:** *If you switch automatic emergency braking off, evasive steering assist switches off.*

## LOCATING THE PRE-COLLISION ASSIST SENSORS



1. Camera.
2. Radar sensor.

If a message regarding a blocked sensor or camera appears in the information display, something is obstructing the radar signals or camera images. The radar sensor is behind the fascia cover in the center of the lower grille. With a blocked sensor or camera, the system may not function, or performance may reduce. See **Pre-Collision Assist – Information Messages** (page 264).

**Note:** *Proper system operation requires a clear view of the road by the camera. Repair any windshield damage in the area of the camera's field of view.*

**Note:** *If something hits the front end of your vehicle or damage occurs and your vehicle has a radar sensor, the radar sensing zone could change. This could cause missed or false vehicle detections. Have your vehicle serviced to have the radar checked for proper coverage and operation.*



# Pre-Collision Assist

**Note:** If your vehicle detects excessive heat at the camera or a potential misalignment condition, a message could display in the information display indicating temporary sensor unavailability. When operational conditions are correct, the message deactivates. For example, when the ambient temperature around the sensor decreases or the sensor recalibrates successfully.

## DISTANCE INDICATION

### WHAT IS DISTANCE INDICATION

Distance indication displays the gap between your vehicle and the vehicle ahead of you.

**Note:** The graphic does not display if you switch on cruise control or adaptive cruise control.

Vehicle Speed	System Sensitivity	Distance Indicator Color	Distance Gap	Time Gap
62 mph (100 km/h).	Normal.	Blue.	Greater than 82 ft (25 m).	Greater than 0.9 seconds.
		Yellow.	56–82 ft (17–25 m).	0.6–0.9 seconds.
		Red.	Less than 56 ft (17 m).	Less than 0.6 seconds.

# Pre-Collision Assist

## SWITCHING DISTANCE INDICATION ON AND OFF

To switch the system on or off:

1. Access the vehicle drawer.
2. Press **SETTINGS**.
3. Press **Driver Assistance**.
4. Press **Pre-Collision Assist**.
5. Switch **Distance Indication** on or off.

## DISTANCE INDICATION INDICATOR

The indicator displays the time gap between your vehicle and vehicles traveling in the same direction ahead of you.



## DISTANCE ALERT

### WHAT IS DISTANCE ALERT

The system alerts you with a warning lamp if the distance to the vehicle ahead is small.

**Note:** *The warning lamp does not illuminate if cruise control or adaptive cruise control is active.*

### ADJUSTING THE SENSITIVITY OF DISTANCE ALERT

To adjust the sensitivity of the system:

# Pre-Collision Assist

---

1. Access the vehicle drawer.
2. Press **SETTINGS**.
3. Press **Driver Assistance**.
4. Press **Pre-Collision Assist**.
5. Press **Alert Sensitivity**.
6. Select a setting.

## AUTOMATIC EMERGENCY BRAKING

### WHAT IS AUTOMATIC EMERGENCY BRAKING

Automatic emergency braking may activate if the system determines that a collision is imminent. The system may help reduce impact damage to avoid the crash completely.

Automatic emergency braking is only available up to certain speeds. See **Pre-Collision Assist Limitations** (page 259).

### SWITCHING AUTOMATIC EMERGENCY BRAKING ON AND OFF

To switch the system on or off:

1. Access the vehicle drawer.
2. Press **SETTINGS**.
3. Press **Driver Assistance**.
4. Press **Pre-Collision Assist**.
5. Press **Automatic Emergency Braking**.
6. Switch the feature on or off.

## EVASIVE STEERING ASSIST

### WHAT IS EVASIVE STEERING ASSIST

If your vehicle is rapidly approaching a road user, evasive steering assist helps you steer around the road user.

After you turn the steering wheel in an attempt to avoid a crash with the road user, the system applies additional steering torque to help you steer around the road user. After you pass the road user, the system applies steering torque when you turn the steering wheel to steer back into the lane. The system deactivates after you fully pass the road user.

**Note:** *Road users are defined as pedestrians or bicyclists in your vehicle's path or another stationary vehicle in the same lane or a vehicle traveling in the same lane in the same direction as you. See **Pre-Collision Assist Precautions** (page 258).*

### EVASIVE STEERING ASSIST LIMITATIONS

Evasive steering assist only activates when all the following occur:

- Automatic emergency braking and evasive steering assist are on.
- The system detects a road user ahead and starts to apply the brakes.
- You significantly turn the steering wheel to steer around a road user.

**Note:** *Evasive steering assist does not automatically steer around a road user. If you do not turn the steering wheel, evasive steering assist does not activate.*

**Note:** *Evasive steering assist does not activate if the distance to the road user ahead is too small and the system cannot avoid a crash.*

# Pre-Collision Assist

## SWITCHING EVASIVE STEERING ASSIST ON AND OFF

To switch the system on or off:

1. Access the vehicle drawer on your vehicle's touchscreen.
2. Press **SETTINGS**.
3. Press **Driver Assistance**.
4. Press **Pre-Collision Assist**.
5. Switch **Evasive Steering** on or off.

**Note:** *If you switch automatic emergency braking off, evasive steering assist turns off.*

**Note:** *Automatic emergency braking and evasive steering assist turn on every time you switch the power on.*

## PRE-COLLISION ASSIST – TROUBLESHOOTING

### PRE-COLLISION ASSIST – WARNING LAMPS



A telltale illuminates in the cluster to indicate if the system is disabled or unavailable.

## PRE-COLLISION ASSIST – INFORMATION MESSAGES

Message	Action
Pre-Collision Assist Not Available Sensor Blocked	You have a blocked sensor due to bad weather, ice, mud or water in front of the radar sensor. You can typically clean the sensor to resolve.
Pre-Collision Assist Not Available	A fault with the system has occurred. Have your vehicle checked as soon as possible.

# Pre-Collision Assist

---

## **PRE-COLLISION ASSIST – FREQUENTLY ASKED QUESTIONS**

### **Camera Troubleshooting**

#### **The windshield in front of the camera is dirty or obstructed.**

Clean the outside of the windshield in front of the camera.

#### **The windshield in front of the camera is clean, but the message remains in the instrument cluster display.**

Wait a short time. It could take several minutes for the camera to detect that there is no obstruction.

### **Radar Troubleshooting**

#### **The surface of the radar in the grille is dirty or obstructed.**

Clean the grille surface in front of the radar or remove the object causing the obstruction.

#### **The surface of the radar in the grille is clean, but the message remains in the instrument cluster display.**

Wait a short time. It could take several minutes for the radar to detect that there is no obstruction.

#### **Heavy rain, spray or fog is interfering with the radar signals.**

The pre-collision assist system is temporarily disabled. Pre-collision assist reactivates a short time after the weather conditions improve.

#### **Swirling water or snow or ice on the surface of the road is interfering with the radar signals.**

The pre-collision assist system is temporarily disabled. Pre-collision assist reactivates a short time after the weather conditions improve.

#### **Radar is out of alignment due to a front end impact.**

Have your vehicle serviced to have the radar checked for proper coverage and operation.

# Driver Alert

## WHAT IS DRIVER ALERT

Driver alert alerts you if it determines that you are becoming drowsy or if your driving deteriorates.

## HOW DOES DRIVER ALERT WORK

Driver Alert calculates your alertness level based on your driving behavior in relation to the lane markings and other factors through use of the front camera sensor behind the interior mirror.

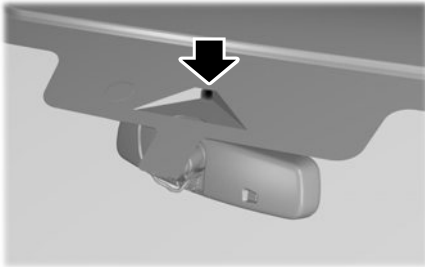

## DRIVER ALERT PRECAUTIONS

**WARNING:** You are responsible for controlling your vehicle at all times. The system is designed to be an aid and does not relieve you of your responsibility to drive with due care and attention. Failure to follow this instruction could result in the loss of control of your vehicle, personal injury or death.

**WARNING:** Take regular rest breaks if you feel tired. Do not wait for the system to warn you.

**WARNING:** Certain driving styles may result in the system warning you even if you are not feeling tired.

**WARNING:** In cold and severe weather conditions the system may not function. Rain, snow and spray can all limit sensor performance.

**WARNING:** The system will not operate if the sensor cannot track the road lane markings.

**WARNING:** If damage occurs in the immediate area surrounding the sensor, have your vehicle checked as soon as possible.

**WARNING:** The system may not correctly operate if your vehicle is fitted with a suspension kit not approved by us.

**WARNING:** The system may not operate properly if the sensor is blocked. Keep the windshield free from obstruction.

**Note:** If something is blocking the camera or damaged the windshield, Driver Alert may not function.

## DRIVER ALERT LIMITATIONS

Driver alert may not function correctly if:

- The sensor cannot track the road lane markings.
- Your vehicle's speed is less than approximately 40 mph (65 km/h).

# Driver Alert

## SWITCHING DRIVER ALERT ON AND OFF

To switch the system on or off, use the touchscreen:

1. Access the vehicle drawer.
2. Press **SETTINGS**.
3. Press **Driver Assistance**.
4. Switch **Driver Alert** on or off.

**Note:** *The system remains on or off depending on how it was last set.*

### Resetting Driver Alert

You can reset the system by either:

- Switching the ignition off and on.
- Stopping the vehicle and then opening and closing the driver door.

## DRIVER ALERT – TROUBLESHOOTING

### DRIVER ALERT – INFORMATION MESSAGES

Message	Action
Driver Alert Warning Rest Now	Stop and rest as soon as it is safe to do so.
Driver Alert Warning Rest Suggested	Take a rest soon.

## DRIVER ALERT INDICATORS

### System Warnings

The warning system has two stages:

1. A temporary warning is issued to advise you to take a rest. This message only appears for a short time.
2. If you do not rest and the system continues to detect that your driving deteriorates, it issues a further warning. This remains in the instrument cluster display until you cancel it.

**Note:** *The system does not warn you if the vehicle speed falls below approximately 40 mph (65 km/h).*

# Speed Sign Recognition

## WHAT IS SPEED SIGN RECOGNITION

Speed sign recognition detects speed limit signs to inform you of the current speed limit. Detected speed signs appear in the information display.

## HOW DOES SPEED SIGN RECOGNITION WORK

Speed sign recognition uses a sensor behind the interior mirror to detect speed signs.

If your vehicle has speed sign recognition with navigation, stored speed sign data may influence the indicated speed limit value.

## SPEED SIGN RECOGNITION PRECAUTIONS



**WARNING:** You are responsible for controlling your vehicle at all times. The system is designed to be an aid and does not relieve you of your responsibility to drive with due care and attention. Failure to follow this instruction could result in the loss of control of your vehicle, personal injury or death.



**WARNING:** In cold and severe weather conditions the system may not function. Rain, snow and spray can all limit sensor performance.



**WARNING:** The system may not operate properly if the sensor is blocked. Keep the windshield free from obstruction.

**Note:** Do not carry out windshield repairs in the immediate area surrounding the sensor.

**Note:** If your vehicle has a suspension kit not approved by us, the system may not correctly function.

**Note:** The system may not detect all speed signs and may incorrectly read signs.

**Note:** Always fit our original parts when replacing headlamp bulbs. Other bulbs may reduce system performance.

## SPEED SIGN RECOGNITION LIMITATIONS

Speed sign recognition may not operate correctly due to:

- Outdated map data.
- Incorrect recognition of speed limits by the sensor of signs on parallel roads or exit ramps.
- Missed recognition of faded, dirty, or distorted signs.

## SPEED SIGN RECOGNITION INDICATORS



When the system detects a speed limit sign, it appears in the information display.



# Speed Sign Recognition

## SETTING THE SPEED SIGN RECOGNITION SPEED WARNING

To set the speed warning, use the touchscreen.

1. Access the vehicle drawer.
2. Press **SETTINGS**.
3. Press **Driver Assistance**.
4. Press **Speed Limit Assist**.
5. Select to switch the feature on or off.

## SETTING THE SPEED SIGN RECOGNITION SPEED TOLERANCE

To set the tolerance of the speed warning, use the touchscreen.

1. Access the vehicle drawer.
2. Press **SETTINGS**.
3. Press **Driver Assistance**.
4. Press **Speed Limit Assist**.
5. Press **Tolerance**.
6. Use the slider bar to select the required level.

## SPEED SIGN RECOGNITION – TROUBLESHOOTING

### SPEED SIGN RECOGNITION – INFORMATION MESSAGES

Message	Action
Traffic Sign Reduced Performance See Manual	The traffic sign data provided by the navigation system is unavailable due to weak or no signal. Wait for a short period of time for the signal to improve. If the message continues to appear, have the system checked as soon as possible.

# Speed Sign Recognition

---

## **SPEED SIGN RECOGNITION – FREQUENTLY ASKED QUESTIONS**

### **Why does the speed limit change without any sign on the road?**

The speed limit changes due to the speed limit data stored in the map data.

### **Why does speed sign recognition show a wrong speed limit?**

The system shows a wrong speed limit due to incorrect and outdated map data or due to incorrect recognition of the speed limits by the camera.

# Load Carrying

## LOAD CARRYING PRECAUTIONS

Keep your loaded vehicle weight within its design rating capability, with or without a trailer. Properly loading your vehicle provides maximum return of vehicle design performance. Before you load your vehicle, become familiar with the following terms for determining your vehicle's weight rating, with or without a trailer, from the vehicle's Tire and Loading Information label or Safety Compliance Certification label.



**WARNING:** The appropriate loading capacity of your vehicle can be limited either by volume capacity (how much space is available) or by payload capacity (how much weight the vehicle should carry). Once you have reached the maximum payload of your vehicle, do not add more cargo, even if there is space available. Overloading or improperly loading your vehicle can contribute to loss of vehicle control and vehicle rollover.



**WARNING:** Exceeding the Safety Compliance Certification label vehicle weight limits can adversely affect the performance and handling of your vehicle, cause vehicle damage and can result in the loss of control of your vehicle, serious personal injury or death.



**WARNING:** Do not use replacement tires with lower load carrying capacities than the original tires because they may lower your vehicle's GVWR and GAWR limitations. Replacement tires with a higher limit than the original tires do not increase the GVWR and GAWR limitations.



**WARNING:** Do not exceed the GVWR or the GAWR specified on the certification label.



**WARNING:** Exceeding any vehicle weight rating can adversely affect the performance and handling of your vehicle, cause vehicle damage and can result in the loss of control of your vehicle, serious personal injury or death.



**WARNING:** When loading the roof racks, we recommend you evenly distribute the load, as well as maintain a low center of gravity. Loaded vehicles, with higher centers of gravity, may

# Load Carrying

handle differently than unloaded vehicles. Take extra precautions, such as slower speeds and increased stopping distance, when driving a heavily loaded vehicle.

The gross combined weight must never exceed the Gross Combined Weight Rating.

## LOCATING THE SAFETY COMPLIANCE CERTIFICATION LABELS

### Safety Compliance Certification Label Example:

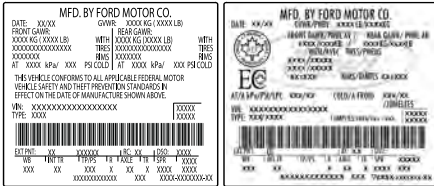

The Safety Compliance Certification label is located on the door hinge pillar, door-latch post, or the door edge that meets the door-latch post, next to the driver seating position.

## WHAT IS THE GROSS AXLE WEIGHT RATING

### GAWR (Gross Axle Weight Rating)

GAWR is the maximum allowable weight that a single axle (front or rear) can carry. These numbers are on the Safety Compliance Certification label.

## WHAT IS THE GROSS VEHICLE WEIGHT RATING

GVWR is the maximum allowable weight of the fully loaded vehicle. This includes all options, equipment, passengers and cargo. It appears on the Safety Compliance Certification label.

## WHAT IS THE MAXIMUM LOADED TRAILER WEIGHT

Maximum loaded trailer weight is the highest possible weight of a fully loaded trailer the vehicle can tow.

**Note:** *Your vehicle is not designed for trailer towing. Never tow a trailer with your vehicle.*

# Load Carrying

## WHAT IS THE GROSS COMBINED WEIGHT RATING

Gross Combined Weight Rating (GCWR) is the maximum allowable weight of the vehicle and the loaded trailer, including all cargo and passengers, that the vehicle can handle without risking damage. (Important: The towing vehicle's braking system is rated for operation at Gross Vehicle Weight Rating, not at Gross Combined Weight Rating.)

**Note:** *Your vehicle is not designed for trailer towing. Never tow a trailer with your vehicle.*

## CALCULATING PAYLOAD

### Tire and Loading Label Information

**Example:**



**TIRE AND LOADING INFORMATION**

SEATING CAPACITY	TOTAL : 5	FRONT: 2	REAR: 3
------------------	-----------	----------	---------

The combined weight of occupants and cargo should never exceed: **385 kg or 850 lbs.**

TIRE	SIZE	COLD TIRE PRESSURE	SEE OWNERS MANUAL FOR ADDITIONAL INFORMATION
FRONT	235/45R18 94V	235 KPA, 34 PSI	
REAR	235/45R18 94V	235 KPA, 34 PSI	
SPARE	NONE	NONE	



**TIRE AND LOADING INFORMATION**  
**RENSEIGNEMENTS SUR LES PNEUS ET LE CHARGEMENT**

SEATING CAPACITY NOMBRE DE PLACES	TOTAL 5	FRONT AVANT 2	REAR ARRIERE 3
--------------------------------------	---------	------------------	-------------------

The combined weight of occupants and cargo should never exceed 396 kg or 875 lbs.  
Le poids total des occupants et du chargement ne doit jamais dépasser 396 kg ou 875 lb.

TIRE PNEU	SIZE DIMENSIONS	COLD TIRE PRESSURE PRESSION DES PNEUS A FROID	SEE OWNER'S MANUAL FOR ADDITIONAL INFORMATION VOIR LE MANUEL DE L'USAGER POUR PLUS DE RENSEIGNEMENTS
FRONT AVANT	235/40R19 96V	255 KPA, 37 PSI	
REAR ARRIERE	235/40R19 96V	255 KPA, 37 PSI	
SPARE DE SECOURS	T125/80R16 97M	415 KPA, 60 PSI	

Payload is the combined weight of cargo and passengers that your vehicle is carrying. The maximum payload for your vehicle appears on the Tire and Loading label. The label is either on the B-pillar or the edge of the driver door. Vehicles exported outside the US and Canada may not have a tire and loading label. Look for "The combined weight of occupants and cargo should never exceed XXX kg OR XXX lb" for maximum payload. The payload listed on the Tire and Loading Information label

## Load Carrying

is the maximum payload for your vehicle as built by the assembly plant. If you install any additional equipment on your vehicle, you must determine the new payload. Subtract the weight of the equipment from the payload listed on the Tire and Loading label.

**Note:** *Your vehicle is not designed for trailer towing. Never tow a trailer with your vehicle.*

### CALCULATING THE LOAD LIMIT

Steps for determining the correct load limit:

1. Locate the statement "The combined weight of occupants and cargo should never exceed XXX kg or XXX lb." on your vehicle's placard.
2. Determine the combined weight of the driver and passengers that will be riding in your vehicle.
3. Subtract the combined weight of the driver and passengers from XXX kg or XXX lb.
4. The resulting figure equals the available amount of cargo and luggage load capacity. For example, if the "XXX" amount equals 1,400 lb. and there will be five 150 lb. passengers in your vehicle, the amount of available cargo and luggage load capacity is 650 lb. (1400-750 (5 x 150) = 650 lb.)

5. Determine the combined weight of luggage and cargo being loaded on the vehicle. That weight may not safely exceed the available cargo and luggage load capacity calculated in Step 4.
6. If your vehicle will be towing a trailer, load from your trailer will be transferred to your vehicle. Consult this manual to determine how this reduces the available cargo and luggage load capacity of your vehicle.

### Helpful examples for calculating the available amount of cargo and luggage load capacity

Suppose your vehicle has a 1400-pound (635-kilogram) cargo and luggage capacity. You decide to go golfing. Is there enough load capacity to carry you, four of your friends and all the golf bags? You and four friends average 220 pounds (99 kilograms) each and the golf bags weigh approximately 30 pounds (13.5 kilograms) each. The calculation would be:  $1400 - (5 \times 220) - (5 \times 30) = 1400 - 1100 - 150 = 150$  pounds. Yes, you have enough load capacity in your vehicle to transport four friends and your golf bags. In metric units, the calculation would be:  $635 \text{ kilograms} - (5 \times 99 \text{ kilograms}) - (5 \times 13.5 \text{ kilograms}) = 635 - 495 - 67.5 = 72.5$  kilograms.

## Load Carrying

---

Suppose your vehicle has a 1400-pound (635-kilogram) cargo and luggage capacity. You and one of your friends decide to pick up cement from the local home improvement store to finish that patio you have been planning for the past two years. Measuring the inside of the vehicle with the rear seat folded down, you have room for twelve 100-pound (45-kilogram) bags of cement. Do you have enough load capacity to transport the cement to your home? If you and your friend each weigh 220 pounds (99 kilograms), the calculation would be:  $1400 - (2 \times 220) - (12 \times 100) = 1400 - 440 - 1200 = -240$  pounds. No, you do not have enough cargo capacity to carry that much weight. In metric units, the calculation would be:  $635 \text{ kilograms} - (2 \times 99 \text{ kilograms}) - (12 \times 45 \text{ kilograms}) = 635 - 198 - 540 = -103$  kilograms. You will need to reduce the load weight by at least 240 pounds (104 kilograms). If you remove three 100-pound (45-kilogram) cement bags, then the load calculation would be:  $1400 - (2 \times 220) - (9 \times 100) = 1400 - 440 - 900 = 60$  pounds. Now you have the load capacity to transport the cement and your friend home. In metric units, the calculation would be:  $635 \text{ kilograms} - (2 \times 99 \text{ kilograms}) - (9 \times 45 \text{ kilograms}) = 635 - 198 - 405 = 32$  kilograms.

The above calculations also assume that the loads are positioned in your vehicle in a manner that does not overload the front or the rear gross axle weight rating specified for your vehicle on the Safety Compliance Certification label.

# Luggage Compartment

## LUGGAGE COMPARTMENT PRECAUTIONS



**WARNING:** Keep vehicle doors and luggage compartment locked and keep keys and remote transmitters out of a child's reach. Unsupervised children could lock themselves in the luggage compartment and risk injury. Children should be taught not to play in vehicles.

**Note:** The front luggage compartment hood only operates with the transmission in park (P). If there is a problem with open or close request, a tone sounds and a warning message appears in the instrument cluster.

**Note:** Do not hang any weight from the front luggage compartment hood. This could damage the hood and its components. Remove any excessive weight from the hood prior to use. If the hood starts to close after it has fully opened, this indicates there may be excessive weight on the hood or a possible strut failure. A repetitive tone sounds and the hood closes under control. If the hood continues to close after opening, have the system checked by an authorized dealer.

**Note:** Do not leave the front luggage compartment open while driving. This could damage the front luggage compartment and its components.

## OPENING AND CLOSING THE FRONT LUGGAGE COMPARTMENT



**WARNING:** People should never climb inside the luggage compartment. Never shut the luggage compartment when a person is inside.

## Opening the Front Luggage Compartment Using the handle

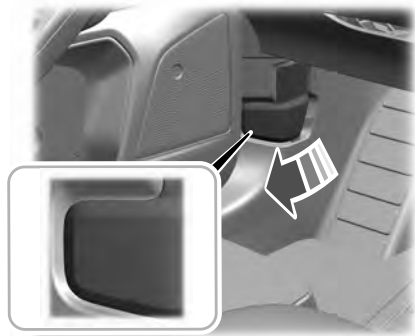

E263274

1. Open the left-hand front door.
2. Pull the release lever and let it retract. This action releases the primary latch.
3. Pull the release lever a second time. This action fully releases the front luggage compartment hood.
4. Open the luggage compartment hood. The struts support the hood.

## Opening the Front Luggage Compartment Using the Touchscreen

1. Access the vehicle drawer on the touchscreen.
2. Press **CONTROLS**.
3. Press **Access**.
4. Press the front luggage compartment icon.





# Luggage Compartment

## Opening the Front Luggage Compartment Using the Keypad

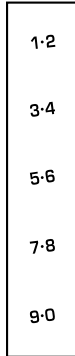

Enter the factory-set code or your personal code, then press **7-8** on the keypad within five seconds.

## Opening the Front Luggage Compartment Using Phone as a key

Press the button to release the front luggage compartment hood.

## Closing the Front Luggage Compartment

Lower the front luggage compartment hood and apply closing force as it drops.

**Note:** Make sure that the front luggage compartment hood is fully closed.

## USING THE FRONT LUGGAGE COMPARTMENT EMERGENCY RELEASE

### Front Luggage Compartment

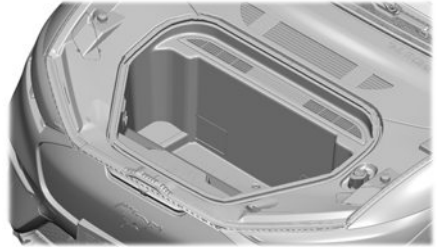

If you are stuck inside the front luggage compartment, you can press the interior release button to get out. The material around the switch glows after a brief exposure to ambient light.

# Luggage Compartment

## INSTALLING AND REMOVING THE LUGGAGE COMPARTMENT COVER

Remove the luggage compartment covers in the following order:

1. The rear luggage compartment cover.
2. The left-hand luggage compartment cover.
3. The right-hand luggage compartment cover.

### Removing the Rear Luggage Compartment Cover

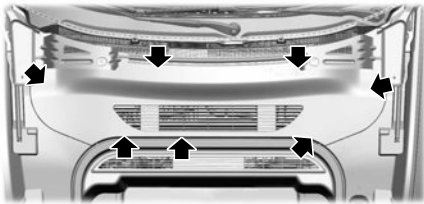

1. Start at the rear edge of the left-hand side.
2. Pull upward at the clip locations shown to release the clips.
3. Remove the cover.
4. To install, reverse the removal procedure.

### Removing the Left-Hand Luggage Compartment Cover

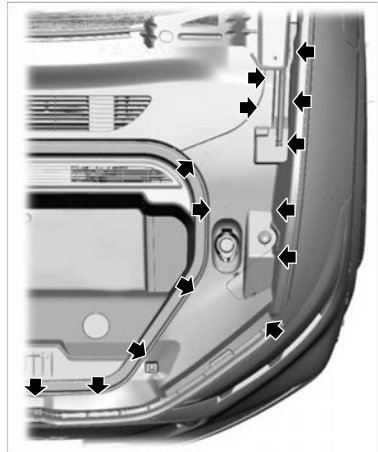

1. Start at the rear edge of the left-hand side and work toward the front of the cover.
2. Pull upward at the clip locations shown to release the clips.
3. Remove the cover.
4. To install, reverse the removal procedure.

# Luggage Compartment

## Removing the Right-Hand Luggage Compartment Cover



1. Start at the rear edge of the right hand-side and work toward the front of the cover.
2. Pull upward at the clip locations shown to release the clips.
3. Remove the cover.
4. To install, reverse the removal procedure.

## ADJUSTING THE LUGGAGE COMPARTMENT LOAD FLOOR

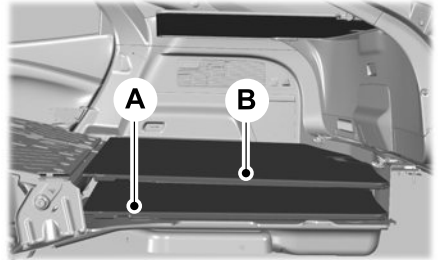

- A Low load floor position.
- B High load floor position.

The load floor can be adjusted to a higher position to provide a flat load area when the rear seats are folded.

## LUGGAGE COMPARTMENT ANCHOR POINTS

## LOCATING THE LUGGAGE COMPARTMENT ANCHOR POINTS

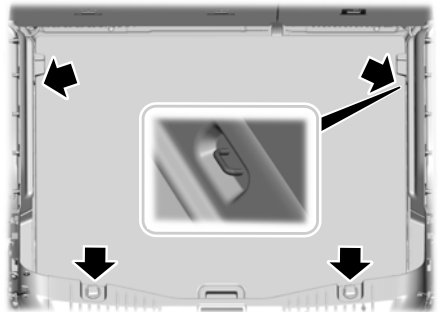

# Towing a Trailer

---

## TOWING A TRAILER PRECAUTIONS



**WARNING:** Your vehicle is not approved for trailer towing. Never tow a trailer with your vehicle.

# Driving Hints

## COLD WEATHER PRECAUTIONS

The functional operation of some components and systems can be affected at temperatures below approximately -13°F (-25°C).

## DRIVING ON SNOW AND ICE



**WARNING:** If you are driving in slippery conditions that require tire chains or cables, then it is critical that you drive cautiously. Keep speeds down, allow for longer stopping distances and avoid aggressive steering to reduce the chances of a loss of vehicle control which can lead to serious injury or death. If the rear end of your vehicle slides while cornering, steer in the direction of the slide until you regain control of your vehicle.

On ice and snow, you should drive more slowly than usual. Your vehicle has a four wheel anti-lock brake system, do not pump the brake pedal. See **Anti-Lock Braking System Limitations** (page 186).

## BREAKING-IN

You need to break in new tires for approximately 300 mi (480 km). During this time, your vehicle may exhibit some unusual driving characteristics.

## PERFORMANCE VEHICLE PRECAUTIONS

- Verify correct tire pressures.
- Inspect wheels and tires for wear and damage. Replace any damaged wheels or tires.

- Do not operate your vehicle at high speeds with more than two passengers or while carrying cargo.
- It is recommended to cross speed bumps or driveway inclines slowly and at a 45° angle to reduce the risk of vehicle damage.
- Do not drive through car washes with the vehicle heavily loaded with passengers or luggage.
- Use only commercial car washes without mechanical tracks or hand wash to avoid potential damage.
- Put your vehicle in stay in neutral mode when entering an automatic car wash. See **What Is Temporary Neutral Mode** (page 183).

## DRIVING IN SPECIAL CONDITIONS

### EMERGENCY MANEUVERS

In an unavoidable emergency where you must make a sudden sharp maneuver, turn the steering wheel only as rapidly and as far as required to avoid the emergency. Apply smooth pressure to the accelerator pedal or brake pedal as needed. Avoid abrupt steering, acceleration and braking changes. Abrupt changes could increase the risk of vehicle roll over, loss of vehicle control and personal injury. If possible, use any available road surfaces to bring your vehicle under control.

# Driving Hints

---

## DRIVING THROUGH MUD AND WATER

### Mud

Be cautious of sudden changes in vehicle speed or direction when you are driving in mud. Even all-wheel drive and four-wheel drive vehicles can lose traction in mud. If your vehicle slides, steer in the direction of the slide until you regain control of your vehicle. After driving through mud, clean off residue stuck to rotating driveshafts and tires. Excess residue can cause an imbalance that could damage drive components.

**Note:** *If your vehicle gets stuck in mud, it could be rocked out by shifting between forward and reverse gears, stopping between shifts in a steady pattern. Press lightly on the accelerator in each gear.*

### Water

If you must drive through water approach it cautiously. See **Driving Through Shallow Water** (page 284).

## DRIVING ON HILLY OR SLOPING TERRAIN

Although natural obstacles could make it necessary to travel diagonally up or down a hill or steep incline, you should try to drive straight up or straight down.

**Note:** *Avoid turning on steep slopes or hills. A danger lies in losing traction, slipping sideways and possible vehicle roll over. Whenever driving on a hill, determine beforehand the route you can use. Do not drive over the crest of a hill without seeing what conditions are on the other side. Do not drive in reverse over a hill without the aid of an observer.*

Apply just enough power to the wheels to climb the hill. Too much power causes the tires to slip, spin or lose traction, and you could lose control of your vehicle. When descending a steep hill, do not descend the hill in neutral. Avoid sudden hard braking to keep the front wheels rolling and to maintain your vehicle's steering.

**Note:** *Your vehicle has anti-lock brakes, apply the brakes steadily. Do not pump the brakes.*

**Note:** *If your vehicle gets stuck driving on hilly or sloping terrain, it could be rocked out by shifting between forward and reverse gears, stopping between shifts in a steady pattern. Press lightly on the accelerator in each gear.*

## DRIVING IN SAND

When driving over sand, try to keep all four wheels on the most solid area of the trail. Shift to a lower gear and drive steadily through the terrain. Apply the accelerator slowly and avoid excessive wheel slip. Do not drive your vehicle in deep sand for an extended period of time. This could overheat the system. A message appears in the information display. See **All-Wheel Drive – Information Messages** (page 185).

**Note:** *If your vehicle gets stuck driving on hilly or sloping terrain, it could be rocked out by shifting between forward and reverse gears, stopping between shifts in a steady pattern. Press lightly on the accelerator in each gear.*

# Driving Hints

---

## ELECTRIC VEHICLE

### MAXIMIZING YOUR DRIVING RANGE

#### Driving in Cold Weather

Keep your vehicle charged before heading out into cold weather.

Use the heated seats and steering wheel for comfort along with moderate cabin temperature and fan settings to reduce energy needed for climate control.

#### Preconditioning Your Vehicle

You can precondition your vehicle by using departure and comfort settings to warm or cool your cabin and the high voltage battery when your vehicle is plugged in. By using energy from your charging source prior to your departure, battery temperature can be managed for best driving performance and less energy will be needed for heating or cooling of the cabin at the start of your drive. This helps maximize your driving range. See **Setting the Charging Schedule and Preferences** (page 174).

**Note:** You can also access departure and comfort settings using the FordPass App.

**Note:** Lower cabin temperature settings on the climate control system results in better trip range.

#### Parking Your Vehicle

At temperatures just above the freezing point and lower, plug your vehicle in when not in use to maintain high voltage battery performance.

When possible park your vehicle under a covered area or in a garage. This will help to moderate temperatures which affect performance of the high voltage battery and require energy to heat or cool the cabin.

## Driving Style

Range is reduced when driving aggressively or at consistently high speeds. Aggressive driving for extended periods could also result in reducing your battery's efficiency and lifespan. Use the trip application on your touchscreen to see your driving scores. See **Trip Data** (page 125).

## DRIVING IN COLD WEATHER

Pack a small supply kit with a 12 V jump box, blanket, snow scraper and gloves during winter.

We recommend winter tires with sufficient tread depth for traction.

Clear snow and ice from the roof, hood, all windows and mirrors. Remove piled up snow or ice from the wipers and washer nozzles. Allow time for windows to defrost and interior controls to warm up before driving.

### Preconditioning Your Vehicle

You can precondition your vehicle to warm or cool your cabin and the high voltage battery when your vehicle is plugged in. You can charge your vehicle to the targeted level and also make sure your vehicle is at a comfortable temperature for the occupants.

**Note:** You can precondition your vehicle prior to your departure using the FordPass App.

Keep your vehicle fully charged before heading out into cold weather.

**Note:** In extreme climates you could experience reduced drive ranges or performance due to heating of the battery and cabin to the preferred temperature.

**Note:** Using seat heaters is more efficient for warming occupants than using the heat from the climate control.

## Driving Hints

**Note:** Lower cabin temperature settings on the climate control system results in better trip range.

- Horn
- Exterior lights

### DRIVING THROUGH SHALLOW WATER

**WARNING:** Do not attempt to cross a deep or flowing body of water. Failure to follow this instruction could result in the loss of control of your vehicle, personal injury or death.

**Note:** Driving through standing water can cause vehicle damage.

Before driving through standing water, check the depth. Never drive through water that is higher than the bottom of the front rocker area of your vehicle.



When driving through standing water, drive very slowly and do not stop your vehicle. Your brake performance and traction could be limited. After driving through water and as soon as it is safe to do so:

- Lightly press the brake pedal to dry the brakes and to check that they work.
- Turn the steering wheel to check that the steering power assist works.

Check the function of the following:

### FLOOR MATS

**WARNING:** Use a floor mat designed to fit the footwell of your vehicle that does not obstruct the pedal area. Failure to follow this instruction could result in the loss of control of your vehicle, personal injury or death.

**WARNING:** Pedals that cannot move freely can cause loss of vehicle control and increase the risk of serious personal injury.

**WARNING:** Secure the floor mat to both retention devices so that it cannot slip out of position and interfere with the pedals. Failure to follow this instruction could result in the loss of control of your vehicle, personal injury or death.

**WARNING:** Do not place additional floor mats or any other covering on top of the original floor mats. This could result in the floor mat interfering with the operation of the pedals. Failure to follow this instruction could result in the loss of control of your vehicle, personal injury or death.

**WARNING:** Always make sure that objects cannot fall into the driver foot well while your vehicle is moving. Objects that are loose can become trapped under the pedals causing a loss of vehicle control.



## Driving Hints

---



To install the floor mats, position the floor mat eyelet over the retention post and press down to lock in position.

To remove the floor mat, reverse the installation procedure.

**Note:** *Regularly check the floor mats to make sure they are secure.*

# Crash and Breakdown Information

## ROADSIDE ASSISTANCE

### Vehicles Sold in the United States: Getting Roadside Assistance

To fully assist you should you have a vehicle concern, Ford Motor Company offers a complimentary roadside assistance program. This program is separate from the New Vehicle Limited Warranty.

The service is available:

- 24 hours a day, seven days a week.
- For the coverage period supplied with your vehicle.

Roadside Assistance covers:

- A flat tire change with a good spare. For vehicles with an unusable tire inflation kit, we provide towing service.
- 12 V battery jump start.
- Lock-out assistance (key replacement cost is the customer's responsibility).
- Winch out — available within 100 ft (30 m) of a paved or county maintained road, no recoveries.
- In the event your vehicle's high-voltage battery does not have enough power to move, you can choose where you would like your vehicle towed (within a 35 mi (56 km) radius):
  - Nearest public charger.
  - EV Certified Ford or Lincoln Dealer.
  - Your home residence.

### Vehicles Sold in the United States: Using Roadside Assistance

Complete the roadside assistance identification card and place it in your wallet for quick reference. This card is in the Owner's Manual kit.

United States vehicle customers who require Roadside Assistance, call 1-800-241-3673.

If you need to arrange roadside assistance for yourself, Ford Motor Company reimburses a reasonable amount for towing to the nearest dealership within 35 mi (56 km). To obtain reimbursement information, United States vehicle customers call 1-800-241-3673. Customers need to submit their original receipts.

### Vehicles Sold in Canada: Getting Roadside Assistance

To fully assist you should you have a vehicle concern, Ford Motor Company of Canada, Limited offers a complimentary roadside assistance program. This program is eligible within Canada or the continental United States.

The service is available 24 hours a day, seven days a week.

This program is separate from the New Vehicle Limited Warranty, but the coverage is concurrent with the powertrain coverage period of your vehicle. Canadian roadside coverage and benefits may differ from the U.S. coverage.

If you require more information, please call us in Canada at 1-800-665-2006, or visit our website at [www.ford.ca](http://www.ford.ca).

## SWITCHING THE HAZARD FLASHERS ON AND OFF

The hazard flashers operate with the power on or off. The battery loses charge and may have insufficient power to restart your vehicle.



The hazard flasher button is on the center console. Press the button to turn on the hazard flashers if your vehicle is creating a safety hazard for other road users.

When you switch the hazard flashers on, all front and rear direction indicators flash.

# Crash and Breakdown Information

Press the button again to switch them off.

## JUMP STARTING THE VEHICLE

### JUMP STARTING PRECAUTIONS

**WARNING:** Connect batteries with only the same nominal voltage.

**WARNING:** Use only adequately sized cables with insulated clamps.

**Note:** This procedure is only for the 12 volt under hood battery.

**Note:** Your vehicle has a 12 volt battery that is easily accessible under the hood. The 12 volt battery controls the switches and contacts that engage the high voltage battery. Do not jump start the high voltage battery using a standard 12 volt battery. Tow your vehicle to an authorized dealer if the high voltage battery does not accept a regular charge.

**Note:** Do not attempt to push start your vehicle. You could cause transmission damage.

**Note:** Do not disconnect the 12 volt battery from your vehicle electrical system.

### PREPARING THE VEHICLE

#### Opening the Front Luggage Compartment With No Vehicle Power

If the vehicle has no power, you will be unable to open the front luggage compartment. To open the front luggage compartment follow the steps below:

1. Use an external power supply such as a 12 volt jump box.

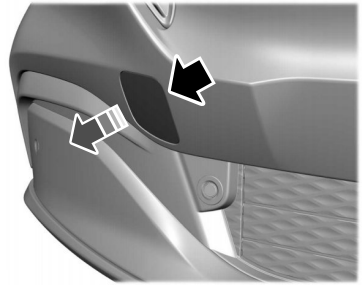

2. Remove the cover at the front of your vehicle below the headlight. Press firmly on the top right of the covers edge, then pull the raised section on the bottom left toward you.

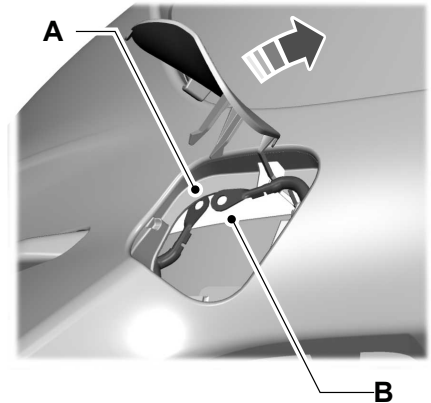

3. Pull both wires out of the opening to reveal both terminals.
4. Connect the external power supply to the terminals

**Note:** Be sure to match the red positive cable (A) to the red positive terminal and the black negative cable (B) to the black negative terminal.

# Crash and Breakdown Information

5. Turn on the external power supply.

**Note:** Refer to the manufacturer's instructions for external power supply use.

**Note:** If performed correctly, the front luggage compartment latches immediately release, and you have access to the front luggage compartment.

6. Disconnect the external power supply when it is no longer required.

7. To reinstall the cover, reverse the removal procedure.

## To Connect the Booster Cables



**WARNING:** Do not connect the negative jumper cable to any other part of your vehicle. Use the ground point.

To access the booster cable connection points, remove the rear and left side front luggage compartment covers. See **Installing and Removing the Luggage Compartment Cover** (page 278).

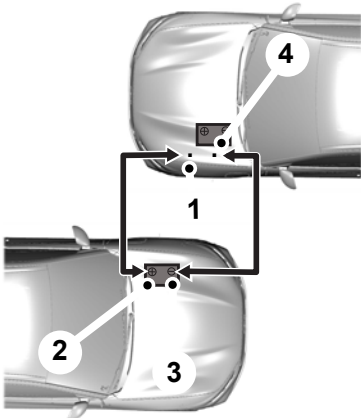

**Note:** Make sure that the cables are clear of any moving parts.

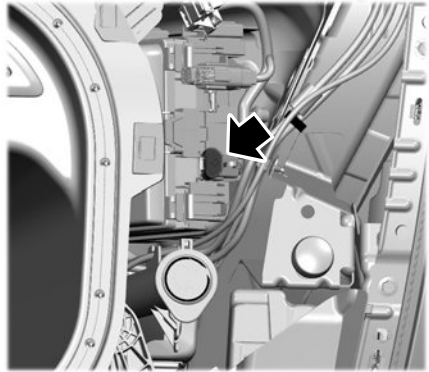

1. Connect the positive (+) jumper cable to the positive (+) jump point of the discharged battery vehicle.
2. Connect the other end of the positive (+) jumper cable to the positive (+) terminal of the booster vehicle battery.
3. Connect the negative (-) jumper cable to the negative (-) terminal of the booster vehicle battery.

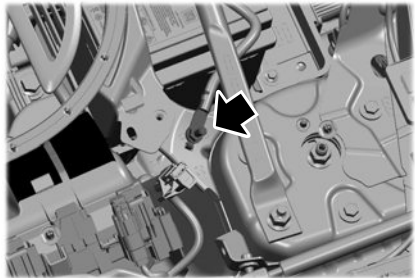

4. Make the final connection of the negative (-) jumper cable to the negative (-) ground point of the discharged battery vehicle.

# Crash and Breakdown Information

---

5. Unlock the driver door. See **Unlocking and Locking the Doors Using the Remote Control** (page 76).

## JUMP STARTING THE VEHICLE

### To Start Your Vehicle

1. Run the engine of the booster vehicle at a moderately high speed.
2. Move the transmission selector lever of the low charge vehicle to park (P).
3. Switch on the ready to drive mode. See **Starting the Vehicle** (page 155).
4. Run both vehicles for a minimum of three minutes before disconnecting the cables.

**Note:** Do not switch the headlamps on when disconnecting the cables. The peak voltage could damage the bulbs.

Disconnect the cables in the reverse order.

## POST-CRASH ALERT SYSTEM

### WHAT IS THE POST-CRASH ALERT SYSTEM

The system helps draw attention to your vehicle in the event of a serious impact.

### HOW DOES THE POST-CRASH ALERT SYSTEM WORK

The system is designed to turn the hazard flashers on and to intermittently sound the horn in the event of a serious impact that deploys an airbag or the seatbelt pretensioners.

### POST-CRASH ALERT SYSTEM LIMITATIONS

Depending on applicable laws in the country your vehicle was built for, the horn does not sound in the event of a serious impact.

### SWITCHING THE POST-CRASH ALERT SYSTEM OFF

Press the hazard flasher switch or the unlock button on the remote control to switch the system off.

**Note:** The alert turns off when the vehicle battery runs out of charge.

## POST IMPACT BRAKING

### HOW DOES POST IMPACT BRAKING WORK

In the event of a moderate to severe crash, the braking system reduces the vehicle's speed in order to prevent or reduce the impact of a potential secondary crash.

### POST IMPACT BRAKING LIMITATIONS

Post impact braking does not activate if any of the following occur:

- The anti-lock braking system is damaged during the collision.
- Electronic stability control is disabled.

### OVERRIDING POST IMPACT BRAKING

You can override post impact braking by pressing the brake or accelerator pedal.

# Crash and Breakdown Information

## POST IMPACT BRAKING INDICATORS



It flashes when a post impact braking event is occurring.

## AUTOMATIC CRASH SHUTOFF

### WHAT IS AUTOMATIC CRASH SHUTOFF

The system deactivates the high voltage system if it is a battery or hybrid-electric vehicle, in the event of a moderate or severe crash.

### RE-ENABLING YOUR VEHICLE

1. Switch your vehicle off.
2. Attempt to start your vehicle.
3. Switch your vehicle off.
4. Attempt to start your vehicle.

**Note:** *If your vehicle does not start after the third attempt, have your vehicle checked as soon as possible.*

## TRANSPORTING THE VEHICLE

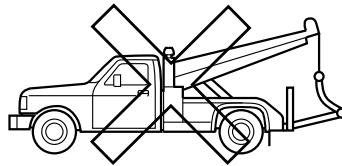
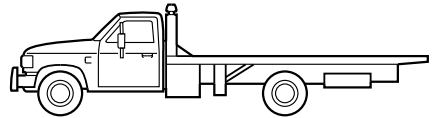
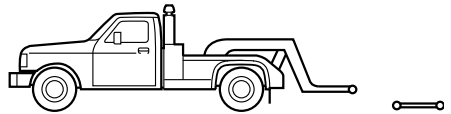

If you need to have your vehicle towed, contact a professional towing service or your roadside assistance service provider.

We recommend the use of a wheel lift and dollies or flatbed equipment to tow your vehicle. Do not tow with a slingbelt. We do not approve a slingbelt towing procedure. Vehicle damage may occur if towed incorrectly, or by any other means.

Your manufacturer produces a towing manual for all authorized tow truck operators. Have your tow truck operator refer to this manual for proper hook-up and towing procedures.

Towing your vehicle requires that all wheels be off the ground. This prevents damage to the mechanical systems and vehicle.

## **Crash and Breakdown Information**

---

When using wheel lift equipment to tow the vehicle from the front, place the rear wheels on a tow dolly.

When using wheel lift equipment to tow the vehicle from the rear, place the front wheels on a tow dolly.

# Towing Your Vehicle

---

## TOWING YOUR VEHICLE PRECAUTIONS

Use the following guidelines when towing your vehicle. Failure to follow this instruction could result in vehicle damage not covered by the vehicle warranty.

**Note:** Make sure you properly secure your vehicle to the tow vehicle.

**Note:** If you are unsure of the vehicle's configuration, contact an authorized dealer.

## RECREATIONALLY TOWING YOUR VEHICLE

You cannot recreational tow your vehicle with all wheels on the ground because vehicle or electric drive motor damage could occur. You must recreational tow your vehicle with all four wheels off the ground, such as when using a car-hauling trailer. Otherwise, you cannot recreational tow your vehicle.

## EMERGENCY TOWING

If your vehicle becomes inoperable without access to wheel dollies or a vehicle transport trailer, it can be flat-towed with all wheels on the ground, regardless of the drivetrain, under the following conditions:

- Your vehicle is facing forward for towing in a forward direction.
- You switch Emergency Tow on.

- Maximum speed is 35 mph (55 km/h).
- Maximum distance is 50 mi (80 km).

## Switching Emergency Tow On

1. Properly secure your vehicle to the tow vehicle.
  2. Switch your vehicle on to accessory mode. See **Starting and Powering Off** (page 155).
  3. Apply the parking brake.
  4. Access the vehicle drawer on the touchscreen.
  5. Press **SETTINGS**.
  6. Press **Vehicle**.
  7. Press and hold Emergency Tow until a confirmation message appears on the touchscreen.
  8. Press and hold the brake pedal.
  9. Shift into neutral (N).
- Note:** A confirmation message appears in the instrument cluster display.
10. Release the parking brake.
  11. Switch your vehicle off.

## Switching Emergency Tow Off

1. Switch your vehicle on.
2. Press and hold the brake pedal.
3. Shift into park (P). A message displays in the instrument cluster display and park (P) displays in the instrument cluster display and on the shifter.



# Towing Your Vehicle

---

## TOWING YOUR VEHICLE – TROUBLESHOOTING

### TOWING YOUR VEHICLE – INFORMATION MESSAGES

Message	Description
Neutral Tow Remove Park Brake for Towing	Displays to remind you to release the parking brake to emergency tow your vehicle.
Neutral Tow Disengaged	Displays when emergency tow is off.
Neutral Tow Engaged Turn Ignition Off for Towing	Displays to remind you to switch off the vehicle to emergency tow your vehicle.
Neutral tow engaged Depress Brake and Select Park to Exit Neutral Tow	Displays to remind you that emergency towing is active. To exit emergency towing, shift to park (P).

**Note:** *You cannot recreationally tow your vehicle. You can only emergency tow your vehicle.*

# Fuses

## FUSE PRECAUTIONS



**WARNING:** Always disconnect the battery before servicing high current fuses.



**WARNING:** To reduce risk of electrical shock, always replace the cover to the power distribution box before reconnecting the battery or refilling fluid reservoirs.



**WARNING:** Always replace a fuse with one that has the specified amperage rating. Using a fuse with a higher amperage rating can cause severe wire damage and could start a fire.

## UNDER HOOD FUSE BOX

### LOCATING THE UNDER HOOD FUSE BOX

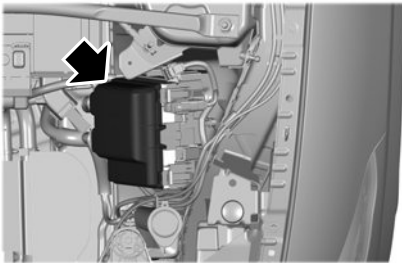

### ACCESSING THE UNDER HOOD FUSE BOX

1. Remove the luggage compartment cover. See **Installing and Removing the Luggage Compartment Cover** (page 278).



2. Pull the latch toward you and remove the top cover.

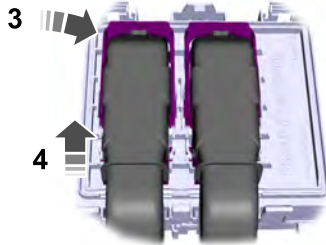

3. Pull the connector lever upward.
4. Pull the connector upward to remove it.



5. Pull both latches toward you and remove the fuse box.

# Fuses

6. Turn the fuse box over and open the lid.

## IDENTIFYING THE FUSES IN THE UNDER HOOD FUSE BOX

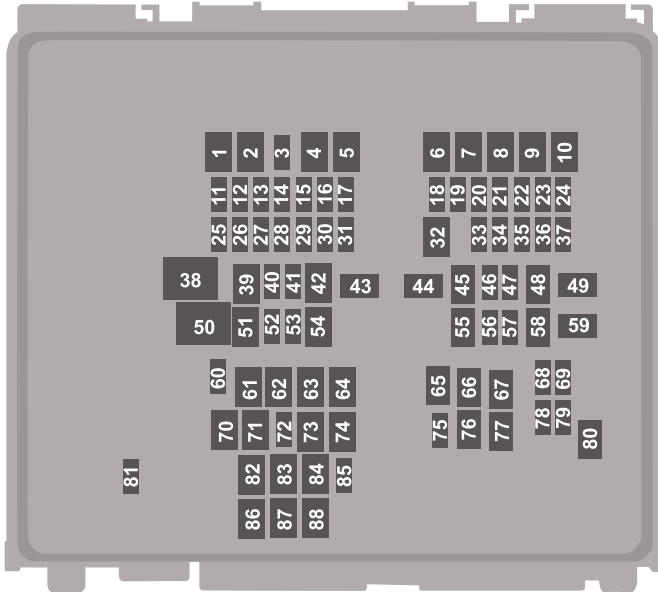

Fuse Location	Fuse Rating	Protected Component
1	—	Not used.
2	40 A	Not used (spare).
3	15 A	Windshield wiper heater.
4	40 A	Not used (spare).
5	—	Not used.
6	—	Not used.
7	—	Not used.
8	—	Not used.

# Fuses

<b>Fuse Location</b>	<b>Fuse Rating</b>	<b>Protected Component</b>
9	—	Not used.
10	—	Not used.
11	15 A	Powertrain control module.
12	—	Not used.
13	15 A	AC electric compressor. Active grille shutter. Powertrain control module heater cooling pump. Powertrain control module heater shut off valve.
14	15 A	Secondary drive unit transmission oil pump (GT).
15	—	Not used.
16	10 A	Battery charge control module.
17	—	Not used.
18	10 A	Powertrain control module.
19	10 A	Brake system control module.
20	5 A	Charge port status indicator.
21	5 A	Front luggage compartment actuator relay coil.
22	20 A	Amplifier.
23	20 A	Rear driver side electronic door.
24	—	Not used.
25	25 A	Left-hand enhanced headlamps.
26	25 A	Right-hand enhanced headlamps.
27	5 A	Keep alive power.
28	5 A	Front luggage compartment actuator relay coil.
29	5 A	DC/DC converter.
30	—	Not used.
31	5 A	Electronic power assist steering.
32	30 A	Body control module.

# Fuses

<b>Fuse Location</b>	<b>Fuse Rating</b>	<b>Protected Component</b>
33	20 A	Advanced driver assistance system.
34	10 A	Headlamp control module.
35	15 A	Heated steering wheel.
36	10 A	Primary hybrid powertrain control module. Auxiliary power distribution box. Secondary hybrid powertrain control module.
37	20 A	Horn.
38	40 A	Blower motor.
39	—	Not used.
40	—	Not used.
41	20 A	Amplifier.
42	30 A	Driver power seat.
43	40 A	Anti-lock brake system valves.
44	60 A	Auxiliary power distribution box.
45	30 A	Passenger power seat.
46	—	Not used.
47	—	Not used.
48	—	Not used.
49	60 A	Anti-lock brake system pump.
50	60 A	Cooling fan.
51	—	Not used.
52	5 A	USB port.
53	—	Not used.
54	—	Not used.
55	30 A	Heated seats.
56	20 A	Front luggage compartment module.
57	10 A	Data link connector.

# Fuses

<b>Fuse Location</b>	<b>Fuse Rating</b>	<b>Protected Component</b>
58	—	Not used.
59	40 A	Body control module.
60	—	Not used.
61	20 A	Auxiliary power point.
62	—	Not used.
63	—	Not used.
64	30 A	Power liftgate.
65	30 A	Vehicle dynamics module.
66	—	Not used.
67	—	Not used.
68	5 A	Battery electronic control module.
69	20 A	Rear passenger side electronic door.
70	—	Not used.
71	20 A	Auxiliary power point.
72	20 A	Rear window wiper.
73	—	Not used.
74	30 A	Windshield wiper motor.
75	—	Not used.
76	30 A	Heated rear window.
77	—	Not used.
78	20 A	Front driver side electronic door.
79	20 A	Front passenger side electronic door.
80	—	Not used.
81	10 A	Rear window washer pump.
82	—	Not used.
83	—	Not used.

# Fuses

Fuse Location	Fuse Rating	Protected Component
84	40 A	Not used (spare).
85	5 A	Rain sensor.
86	—	Not used.
87	—	Not used.
88	—	Not used.

## BATTERY FUSE BOX

### LOCATING THE BATTERY FUSE BOX

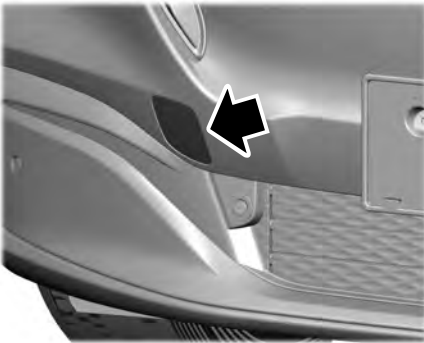

### ACCESSING THE BATTERY FUSE BOX



1. Press the top right-hand side of the cover, then pull the raised section on the bottom left-hand side toward you.

# Fuses

## IDENTIFYING THE FUSES IN THE BATTERY FUSE BOX

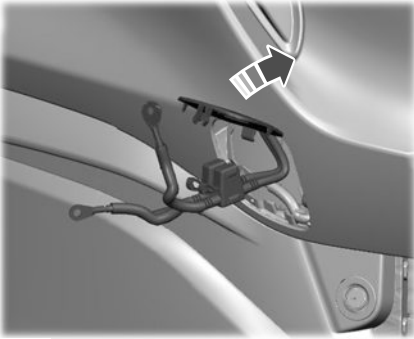

2. Pull both wires out of the opening to reveal the inline fuses.

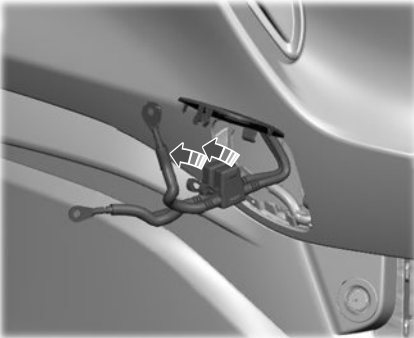
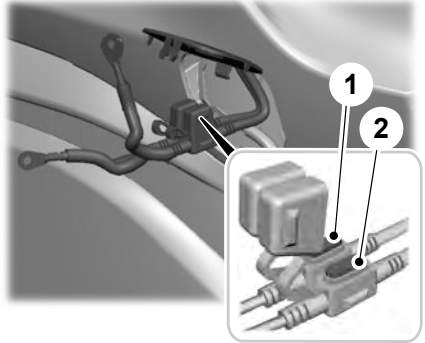

3. Remove the caps that cover the inline fuses.



# Fuses

Item	Rating	Protected Component
1	20 A	Front luggage compartment.
2	20 A	Front luggage compartment.



## BODY CONTROL MODULE FUSE BOX

### LOCATING THE BODY CONTROL MODULE FUSE BOX

## ACCESSING THE BODY CONTROL MODULE FUSE BOX

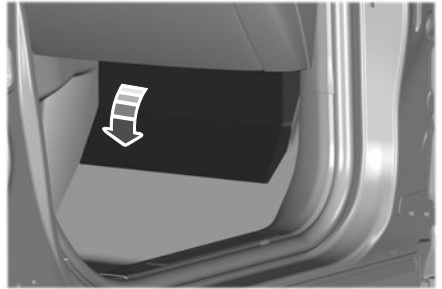

# Fuses

## IDENTIFYING THE FUSES IN THE BODY CONTROL MODULE FUSE BOX

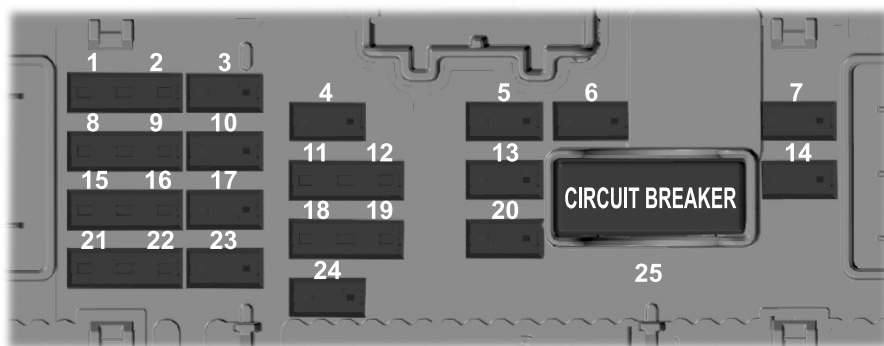

Fuse Location	Fuse Rating	Protected Component
1	5 A	Not used.
2	5 A	Not used.
3	10 A	Extended power module.
4	10 A	Multi-function display.
5	20 A	Not used.
6	10 A	Not used.
7	30 A	Passenger door module.
8	5 A	Not used.
9	5 A	Auto-dimming exterior mirror.
10	10 A	Extended power module.
11	5 A	Power liftgate. Hands-free liftgate actuation module. Telematics control unit module.
12	5 A	Anti-theft alarm. Keyless keypad switch. Front driver door activation switch. Rear driver door activation switch.

# Fuses

<b>Fuse Location</b>	<b>Fuse Rating</b>	<b>Protected Component</b>
13	15 A	Not used.
14	30 A	Driver door module.
15	15 A	Not used.
16	15 A	Active suspension (GT).
17	15 A	SYNC.
18	7.5 A	Wireless accessory charging module. Driver status monitor. Front passenger door activation switch. Rear passenger door activation switch.
19	7.5 A	Headlamp switch pack. Bluetooth low energy module. Push button start.
20	10 A	Anti-theft alarm horn.
21	7.5 A	Gateway module. Climate control. Gear shift module.
22	7.5 A	Instrument cluster. Steering column control module.
23	20 A	Audio unit.
24	20 A	Not used.
25	30 A Circuit Breaker	Not used.

# Fuses

## IDENTIFYING FUSE TYPES

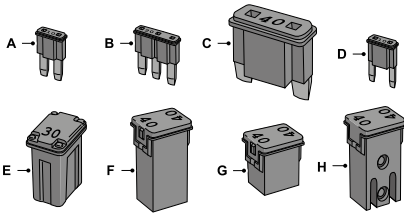

- A Micro 2.
- B Micro 3.
- C Maxi.
- D Mini.
- E M Case.
- F J Case.
- G J Case Low Profile.
- H Slotted M Case.

## FUSES – TROUBLESHOOTING

### FUSES – FREQUENTLY ASKED QUESTIONS

#### When do I need to check a fuse?

If electrical components in the vehicle are not working.

#### When do I need to replace a fuse?

If a fuse has blown.

#### How do I identify a blown fuse?

You can identify a blown fuse by a broken wire within the fuse.

# Maintenance

## MAINTENANCE PRECAUTIONS

Have your vehicle serviced regularly to help maintain its roadworthiness and resale value. There is a large network of authorized dealers that are there to help you with their professional servicing expertise. We believe that their specially trained technicians are best qualified to service your vehicle properly and expertly. They are supported by a wide range of highly specialized tools developed specifically for servicing your vehicle.

If your vehicle requires professional service, an authorized dealer can provide the necessary parts and service. Check your warranty information to find out which parts and services are covered.

Use only recommended fluids and service parts conforming to specifications. See **Capacities and Specifications** (page 346).

## OPENING AND CLOSING THE HOOD

See **Opening and Closing the Front Luggage Compartment** (page 276).

## UNDER HOOD OVERVIEW

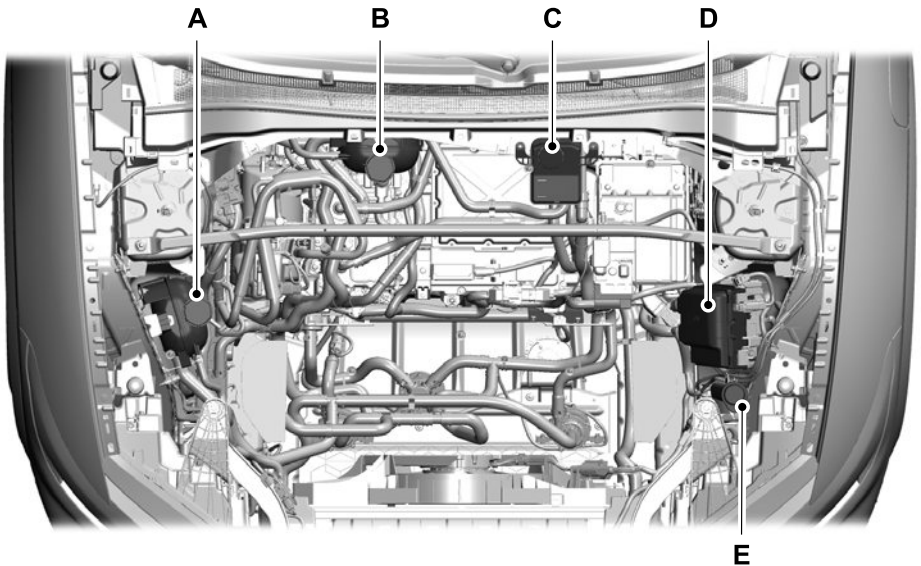

# Maintenance

- A Motor electronic coolant reservoir. See **Checking the Coolant** (page 306).
- B Battery coolant reservoir. See **Checking the Coolant** (page 306).
- C Brake fluid reservoir. See **Checking the Brake Fluid** (page 186).
- D Under hood fuse box. See **Under Hood Fuse Box** (page 294).
- E Windshield washer fluid reservoir. See **Adding Washer Fluid** (page 105).

**Note:** *Some of these components are underneath the luggage compartment cover and cannot be seen unless the cover is removed. See **Installing and Removing the Luggage Compartment Cover** (page 278).*

## CHECKING THE COOLANT



**WARNING:** Do not remove the coolant reservoir cap when the vehicle is on or the cooling system is hot. Wait 10 minutes for the cooling system to cool down. Cover the coolant reservoir cap with a thick cloth to prevent the possibility of scalding and slowly remove the cap. Failure to follow this instruction could result in personal injury.



**WARNING:** Do not put coolant in the windshield washer reservoir. If sprayed on the windshield, coolant could make it difficult to see through the windshield.



**WARNING:** Do not add coolant further than the **MAX** mark.

**Note:** *Coolant expands when it is hot. The level may extend beyond the **MAX** mark.*

Your vehicle has a battery cooling system and a motor electrical cooling system. See **Under Hood Overview** (page 305). The luggage compartment covers need to be removed in order to access the reservoirs. See **Installing and Removing the Luggage Compartment Cover** (page 278).

When the electric motor is cold, check the concentration and level of the coolant at the intervals listed in the scheduled maintenance information. See **Scheduled Maintenance** (page 392).

Maintain coolant concentration within 48% to 50%, which equates to a freeze point between -29--35°F (-34--37°C). Check coolant concentration using a refractometer. We do not recommend the use of hydrometers or coolant test strips for measuring coolant concentration.

## Adding Coolant

It is very important to use prediluted coolant approved to the correct specification in order to avoid plugging the small passageways in the electric motor cooling system. See **Cooling System Capacity and Specification** (page 346).

Do not mix different colors or types of coolant in your vehicle. Mixing of coolants or using an incorrect coolant may harm the electric motor or cooling system components and may cause damage that the vehicle warranty may not cover.

**Note:** *Automotive fluids are not interchangeable.*

**Note:** *Do not use stop leak pellets, cooling system sealants, or non-specified additives as they can cause damage to the electric motor cooling or heating systems.*

# Maintenance

---

**Note:** *If prediluted coolant is not available, use the approved concentrated coolant diluting it to 50/50 with distilled water. See*

**Cooling System Capacity and Specification** (page 346). *Using water that has not been deionized could contribute to deposit formation, corrosion and plugging of the small cooling system passageways.*

**Note:** *Coolants marketed for all makes and models might not meet our specifications and could cause damage to the cooling system. Resulting component damage could void the vehicle warranty.*

If the coolant level is at or below the minimum mark, add prediluted coolant immediately.

To top up the coolant level do the following:

1. Unscrew the cap slowly. Any pressure escapes as you unscrew the cap.
2. Add prediluted coolant approved to the correct specification. See **Cooling System Capacity and Specification** (page 346).
3. Add enough prediluted coolant to reach the correct level.
4. Replace the coolant reservoir cap. Turn the cap clockwise until it contacts the hard stop.
5. Check the coolant level in the coolant reservoir the next few times you drive your vehicle. If necessary, add enough prediluted coolant to bring the coolant level to the correct level.

If you have to add more than 1.1 qt (1 L) of coolant per month, have your vehicle checked as soon as possible. Operating your vehicle with a low level of coolant can result in overheating and possible electric motor damage.

In case of emergency, you can add a large amount of water without coolant in order to reach a vehicle service location. In this instance, have qualified personnel do the following as soon as possible:

1. Drain the cooling system.
2. Chemically clean the coolant system.
3. Refill with coolant.

Water alone, without coolant, can cause damage from corrosion, overheating or freezing.

Do not use the following as a coolant substitute:

- Alcohol.
- Methanol.
- Brine.
- Any coolant mixed with alcohol or methanol antifreeze.

Alcohol and other liquids can cause damage from overheating or freezing.

Do not add extra inhibitors or additives to the coolant. These can be harmful and compromise the corrosion protection of the coolant.

## Recycled Coolant

We do not recommend the use of recycled coolant, as an approved recycling process is not yet available.

Dispose of used coolant in an appropriate manner. Follow your community's regulations and standards for recycling and disposing of automotive fluids.

# Maintenance

## Severe Climates

If you drive in extremely cold climates:

- It may be necessary to increase the coolant concentration above 50%.
- A coolant concentration of 60% provides improved freeze point protection.
- Coolant concentrations above 60% decrease the overheat protection characteristics of the coolant and may cause damage to the electric motor.

If you drive in extremely hot climates:

- You can decrease the coolant concentration to 40%.
- A coolant concentration of 40% provides improved overheat protection.
- Coolant concentrations below 40% decrease the overheat and corrosion protection characteristics of the coolant and may cause damage to the electric motor.

## Coolant Change

Change the coolant at specific mileage intervals listed in the scheduled maintenance information. Add prediluted coolant approved to the correct specification. See **Cooling System Capacity and Specification** (page 346).

## AUTOMATIC TRANSMISSION FLUID CHECK

If required, have an authorized dealer check and change the transmission fluid at the correct service interval. See **Scheduled Maintenance** (page 392).

The automatic transmission does not have a transmission fluid dipstick.

Refer to your scheduled maintenance information for scheduled intervals for fluid checks and changes. Your transmission does not consume fluid. However, if you notice a sign of leaking fluid, contact an authorized dealer.

Do not use supplemental transmission fluid additives, treatments or cleaning agents. The use of these materials may affect transmission operation and result in damage to internal transmission components.

## 12V BATTERY

### CHANGING THE 12V BATTERY

If the 12 volt battery needs servicing, see your authorized dealer.

### CHARGING THE 12V BATTERY

Your vehicle has a high voltage to low voltage energy transfer feature that keeps the 12 volt battery charged by the high voltage battery. If the 12 volt battery level is low, the high voltage battery transfers energy to the 12 volt battery when the vehicle is off.

## 12V BATTERY – TROUBLESHOOTING

### 12V BATTERY – WARNING LAMPS



If it illuminates when the green ready to drive indicator is activated, this indicates your vehicle requires service. Have your vehicle checked as soon as possible.



# Maintenance

## 12V BATTERY – INFORMATION MESSAGES

Message	Action
12V Battery Fault Service Soon	Your vehicle has a 12 volt battery problem. We recommend having the battery system checked by an authorized EV dealer.
Electric Range Reduced due to Park/Hazard Lamps On While Vehicle Off	The electric vehicle range is reduced due to the park and/or hazard lamps on while your vehicle was off.
Electrical System Drain Service Required	Your vehicle has an electrical drain within the vehicle. Please check for any after-market devices that could be draining the battery. If none are found, please have your vehicle serviced by an authorized EV dealer.

## ADJUSTING THE HEADLAMPS

### Vertical Aim Adjustment

The headlamps on your vehicle are properly aimed at the assembly plant. If your vehicle has been in an accident, have the alignment of your headlamps checked by an authorized dealer.

### Headlamp Aiming Target

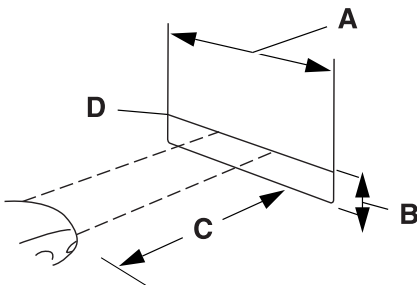

- A 8 feet (2.4 meters)
- B Center height of lamp to ground

- C 25 feet (7.6 meters)
- D Horizontal reference line

### Vertical Aim Adjustment

1. Park your vehicle on a level surface approximately 25 ft (7.6 m) away from a vertical wall or screen.
2. Apply the parking brake.
3. Measure the height from the center of your headlamp to the ground.

**Note:** *There may be an identifying mark on the lens to help you locate the center of the headlamp low beam light.*

4. Mark a horizontal reference line on the wall or screen that is a minimum of 8 ft (2.4 m) long.
5. Switch the low beam headlamps on and open the hood.

# Maintenance

---



## EXTERIOR BULBS

### EXTERIOR BULB SPECIFICATION CHART

Your vehicle has LED lamps. These are not serviceable items. See an authorized dealer if they fail.

## INTERIOR BULBS

### INTERIOR BULB SPECIFICATION CHART

Your vehicle has LED lamps. These are not serviceable items. See an authorized dealer if they fail.

6. On the wall or screen you will observe a flat zone of high intensity light located at the top of the right hand portion of the beam pattern. If the top edge of the high intensity light zone is not at the horizontal reference line, the headlamp will need to be adjusted.

**Note:** To see a clearer light pattern while adjusting one headlamp, block the light from the other headlamp.

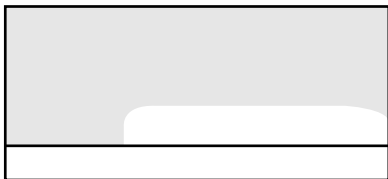

7. Locate the vertical adjuster on each headlamp. Use a Phillips #2 screwdriver to turn the adjuster either clockwise or counterclockwise to adjust the vertical aim of the headlamp.
8. Repeat Steps 3 through 7 to adjust the other headlamp.
9. Close the hood and turn off the lamps.

# Vehicle Care

## GENERAL INFORMATION

Your dealer has many quality products available to clean your vehicle and protect its finishes.

## CLEANING PRODUCTS

### Materials

For best results, use the following products or products of equivalent quality:

Name	Specification
Motorcraft® Bug and Tar Remover, ZC-42 (U.S. & Canada)	-
Motorcraft® Custom Bright Metal Cleaner, ZC-15 (U.S. & Canada)	ESR-M5B194-B
Motorcraft® Detail Wash, ZC-3-A (U.S. & Canada)	ESR-M14P4-A
Motorcraft® Engine Shampoo and Degreaser, ZC-20 (U.S.)	ESR-M14P3-A
Motorcraft® Engine Shampoo, CXC-66-A (Canada)	-
Motorcraft® Premium Leather and Vinyl Cleaner, ZC-56 (U.S. & Canada)	-
Motorcraft® Multi-Purpose Cleaner, CXC-101 (Canada)	-
Motorcraft® Premium Windshield Wash Concentrate with Bitterant, ZC-32-B2 (U.S.)	WSS-M14P19-A
Motorcraft® Premium Quality Windshield Washer Fluid, CXC-37-F/M (Canada)	WSS-M14P19-A
Motorcraft® Professional Strength Carpet & Upholstery Cleaner, ZC-54 (U.S. & Canada)	-
Motorcraft® Premium Glass Cleaner, CXC-100 (Canada)	ESR-M14P5-A
Motorcraft® Spot and Stain Remover, ZC-14 (U.S.)	-
Motorcraft® Ultra-Clear Spray Glass Cleaner, ZC-23 (U.S.)	ESR-M14P5-A
Motorcraft® Wheel and Tire Cleaner, ZC-37-A (U.S. & Canada)	-

# Vehicle Care

---

## CLEANING THE EXTERIOR

### CLEANING THE EXTERIOR PRECAUTIONS

Immediately remove fuel spillages, additive residuals, bird droppings, insect deposits and road tar. These may cause damage to your vehicle's paintwork or trim over time.

Remove any exterior accessories, for example antennas, before entering a car wash.

### CLEANING HEADLAMPS AND REAR LAMPS

We recommend that you only use cold or lukewarm water containing car shampoo to clean the headlamps and the rear lamps.

Do not scrape the lamps.

Do not wipe lamps when they are dry.

### CLEANING WINDOWS AND WIPER BLADES

To clean the windshield and wiper blades:

- Clean the windshield with a non-abrasive glass cleaner.

**Note:** *When cleaning the interior of the windshield, avoid getting any glass cleaner on the instrument panel or door panels. Wipe any glass cleaner off these surfaces immediately.*

- Clean the wiper blades with washer fluid or water applied with a soft sponge or cloth.

**Note:** *Do not use razor blades or other sharp objects to clean or remove decals from the inside of the heated rear window. This can cause damage not covered by the vehicle Warranty.*

## CLEANING CHROME, ALUMINIUM OR STAINLESS STEEL

We recommend that you only use a car shampoo, a soft cloth and water on bumpers and other chrome, aluminium or stainless steel parts.

**Note:** *For additional information and assistance, we recommend that you contact an authorized dealer.*

**Note:** *Rinse the area well after cleaning.*

**Note:** *Do not use abrasive materials, for example steel wool or plastic pads, as they can scratch these surfaces.*

**Note:** *Do not use chrome cleaner, metal cleaner or polish on wheels or wheel covers.*

## CLEANING WHEELS

Only use a recommended wheel and tire cleaner to clean the wheels weekly. For additional information and assistance, we recommend that you contact an authorized dealer.

1. Use a sponge to remove heavy deposits of dirt and brake dust.
2. Rinse well after cleaning.

**Note:** *Do not apply a cleaning chemical to warm or hot wheel rims and covers.*

If you intend on parking your vehicle for an extended period after cleaning the wheels with a wheel cleaner, drive your vehicle for a few minutes before parking your vehicle. This reduces the risk of corrosion of the brake discs, brake pads and linings.

Do not clean the wheels when they are hot.

**Note:** *Some car washes could damage wheel rims and covers.*

**Note:** *Using non-recommended cleaners, harsh cleaning products, chrome wheel cleaners or abrasive materials could damage wheel rims and covers.*

# Vehicle Care

## CLEANING STRIPES OR GRAPHICS

It is recommended to wash your vehicle by hand however, pressure washing may be used under the following conditions:

- Use a spray with a 40° wide spray angle pattern.
- Keep the nozzle at a 12 in (305 mm) distance and 90° angle to your vehicle's surface.
- Do not use water pressure higher than 2,000 psi (14,000 kPa).
- Do not use water hotter than 179°F (82°C).

**Note:** *Holding the pressure washer nozzle at an angle to the vehicle's surface may damage graphics and cause the edges to peel away from the vehicle's surface.*

## CLEANING CAMERA LENSES AND SENSORS

We recommend that you only use lukewarm or cold water and a soft cloth to clean the camera lens and sensors.

**Note:** *Do not pressure wash camera lens and sensors.*

## CLEANING THE UNDERBODY

Flush the complete underside of your vehicle frequently. Keep body and door drain holes free from packed dirt.

Rear suspension components may require regular cleaning with a power washer or a thorough rinse with a strong stream of water if the vehicle is operated in dusty or muddy environments. Rear leaf springs or other suspension components may emit squeaking or popping noises while operating the vehicle if particles, such as dirt, rocks, or other debris, are present in the components.

## WAXING

Wax the high-gloss painted surface of your prewashed vehicle once or twice a year.

We recommend that you only use an approved quality wax that does not contain abrasives. For additional information and assistance, we recommend that you contact an authorized dealer.

When washing and waxing, park your vehicle in a shaded area out of direct sunlight.

**Note:** *Avoid waxing unpainted or low-gloss black colored parts, they discolor over time.*

## CLEANING THE INTERIOR

### CLEANING THE INSTRUMENT PANEL



**WARNING:** Do not use chemical solvents or strong detergents when cleaning the steering wheel or instrument panel to avoid contamination of the airbag system.

We recommend that you only clean the instrument panel and cluster lens with a damp soft cloth. Dry the area with a clean, soft cloth.

For additional information and assistance, we recommend that you contact an authorized dealer.

**Note:** *Avoid cleaners or polishes that increase the gloss of the upper portion of the instrument panel. The dull finish in this area helps protect you from undesirable windshield reflection.*

# Vehicle Care

## CLEANING PLASTIC

We recommend that you only use a mild soap and water solution on a soft cloth. Dry the area with a clean, soft cloth.

## CLEANING DISPLAYS AND SCREENS

We recommend that you only use a microfiber cloth in a circular motion to clean off the fingerprint or dust.

If dirt or fingerprints are still on the screen, apply a small amount of alcohol to the cloth and try to clean it again.

**Note:** Do not pour or spray alcohol onto the touchscreen.

**Note:** Do not use detergent or any type of solvent to clean the touchscreen.

## CLEANING SEATS AND THE HEADLINER



**WARNING:** On vehicles equipped with seat-mounted airbags, do not use chemical solvents or strong detergents. Such products could contaminate the side airbag system and affect performance of the side airbag in a crash.

### Cleaning Fabric Seats and the Headliner

We recommend that you only clean the fabric seats and headliners in the following way:

1. Remove dust and loose dirt with a vacuum cleaner.
2. Wipe the surface with a soft, damp cloth and a mild soap and water solution. Dry the area with a clean, soft cloth.

3. For additional information and assistance, we recommend that you contact an authorized dealer.

For heavy stains, spot clean the area. If a ring forms on the fabric, immediately clean the entire area, but do not oversaturate or the ring could set.

### Cleaning Vinyl

We recommend that you only clean the vinyl surfaces in the following way:

1. Remove dust and loose dirt with a vacuum cleaner.
2. Wipe the surface with a soft, damp cloth and a mild soap and water solution. Dry the area with a clean, soft cloth.
3. For additional information and assistance, we recommend that you contact an authorized dealer.

## CLEANING CARPETS AND FLOOR MATS

We recommend that you only clean your carpets in the following way:

1. Remove dust and loose dirt with a vacuum cleaner.
2. Wipe the surface with a soft, damp cloth and a mild soap and water solution. Dry the area with a clean, soft cloth.
3. For additional information and assistance, we recommend that you contact an authorized dealer.

For heavy stains, spot clean the area. If a ring forms on the fabric, clean the entire area immediately, but do not oversaturate or the ring could set.

We recommend that you only clean your floor mats in the following way:

1. Remove dust and loose dirt with a vacuum cleaner.

# Vehicle Care

---

2. Wash rubber floor mats using mild soap and lukewarm or cold water.
3. Completely dry the floor mat before placing them back in your vehicle.

## CLEANING SEATBELTS



**WARNING:** Do not use cleaning solvents, bleach or dye on the vehicle's seatbelts, as these actions may weaken the belt webbing.

1. Wipe the surface with a soft, damp cloth and a mild soap and water solution. Dry the area with a clean, soft cloth.

## CLEANING STORAGE COMPARTMENTS

1. Remove dust and loose dirt with a vacuum cleaner.
2. Wipe the surface with a soft, damp cloth and a mild soap and water solution. Dry the area with a clean, soft cloth.

## REPAIRING MINOR PAINT DAMAGE

Authorized dealers have touch-up paint to match your vehicle's color. Your vehicle color code is printed on a sticker on the front, left-hand side door jamb. Take the color code to an authorized dealer to make sure you get the correct color.

Before repairing minor paint damage, use a cleaner such as Motorcraft Bug and Tar Remover to remove particles such as bird droppings, tree sap, insect deposits, tar spots, road salt and industrial fallout.

Make sure to read the instructions before using cleaning products.

# Body Styling Kits

---

## **BODY STYLING KIT PRECAUTIONS**

The distance between the underside of your vehicle and the ground is less than that of other models. Drive with extreme care to avoid damage to your vehicle.



# Storing Your Vehicle

---

## PREPARING YOUR VEHICLE FOR STORAGE

If you plan on storing your vehicle for 30 days or more, read the following maintenance recommendations to make sure your vehicle stays in good operating condition.

We engineer and test all vehicles and their components for reliable, regular driving. Under various conditions, long-term storage may lead to degraded performance or failure unless you use specific precautions to preserve vehicle components.

### General

- Store all vehicles in a dry, ventilated place.
- Protect from sunlight, if possible.
- If vehicles are stored outside, they require regular maintenance to protect against rust and damage.

### Body

- Wash your vehicle thoroughly to remove dirt, grease, oil, tar or mud from exterior surfaces, rear-wheel housing and the underside of front fenders.
- Periodically wash your vehicle if it is stored in exposed locations.
- Touch-up exposed or primed metal to prevent rust.
- Cover chrome and stainless steel parts with a thick coat of auto wax to prevent discoloration. Re-wax as necessary when you wash your vehicle.
- Lubricate all hood, door and luggage compartment hinges and latches with a light grade oil.
- Cover interior trim to prevent fading.
- Keep all rubber parts free from oil and solvents.

### Cooling system

- Protect against freezing temperatures.
- When removing your vehicle from storage, check coolant fluid level. Confirm that there are no cooling system leaks and that fluid is at the recommended level.

### Battery Systems

We recommend the following actions for your vehicle:

- When storing your vehicle for greater than 30 days the state of charge should be approximately 50%. Additionally, we recommend disconnecting the 12v battery which will reduce system loads on the HV battery.

**Note:** *Make sure the vehicle has been switched off and doors closed for at least five minutes before disconnecting the 12 volt battery.*

### Brakes

- Make sure the brakes and parking brake release fully.

### Tires

- Maintain recommended air pressure.

### Miscellaneous

- Make sure all linkages, cables, levers and pins under your vehicle are covered with grease to prevent rust.
- Move vehicles at least 25 ft (7.5 m) every 15 days to lubricate working parts and prevent corrosion.

# Storing Your Vehicle

---

## REMOVING YOUR VEHICLE FROM STORAGE

When your vehicle is ready to come out of storage, do the following:

- Wash your vehicle to remove any dirt or grease film build-up on window surfaces.
- Check windshield wipers for any deterioration.
- Check tire pressures and set tire inflation per the Tire Label.
- Check brake pedal operation. Drive your vehicle 15 ft (4.5 m) back and forth to remove rust build-up.
- Check coolant levels to make sure there are no leaks, and fluids are at recommended levels.
- If you removed the 12 volt battery, clean the 12 volt battery cable ends and check for damage.

Contact an authorized dealer if you have any concerns or issues.

# Wheel and Tire Information

## LOCATING THE TIRE LABEL

The tire label or safety certification label is on the driver side B-pillar or the edge of the driver door. It contains information on the recommended front and rear tire inflation pressures. See **Locating the Safety Compliance Certification Labels** (page 272).

## DEPARTMENT OF TRANSPORTATION UNIFORM TIRE QUALITY GRADES



Tire Quality Grades apply to new pneumatic passenger car tires. The Quality grades can be found where applicable on the tire sidewall between tread shoulder and maximum section width. For example: **Treadwear 200 Traction AA Temperature A.**

These Tire Quality Grades are determined by standards that the United States Department of Transportation has set.

Tire Quality Grades apply to new pneumatic passenger car tires. They do not apply to deep tread, winter-type snow tires, space-saver or temporary use spare tires, light truck or LT type tires, tires with nominal rim diameters of 10 to 12 inches or limited production tires as defined in Title 49 Code of Federal Regulations Part 575.104 (c)(2).

**U.S. Department of Transportation Tire quality grades:** The U.S. Department of Transportation requires us to give you the following information about tire grades exactly as the government has written it.

### Treadwear

The treadwear grade is a comparative rating based on the wear rate of the tire when tested under controlled conditions on a specified government test course. For example, a tire graded 150 would wear 1½ times as well on the government course as a tire graded 100. The relative performance of tires depends upon the actual conditions of their use, however, and may depart significantly from the norm due to variations in driving habits, service practices, and differences in road characteristics and climate.

# Wheel and Tire Information

## Traction AA A B C



**WARNING:** The traction grade assigned to this tire is based on straight-ahead braking traction tests, and does not include acceleration, cornering, hydroplaning or peak traction characteristics.

The traction grades, from highest to lowest are AA, A, B, and C. The grades represent the tire's ability to stop on wet pavement as measured under controlled conditions on specified government test surfaces of asphalt and concrete. A tire marked C may have poor traction performance.

## Temperature A B C



**WARNING:** The temperature grade for this tire is established for a tire that is properly inflated and not overloaded. Excessive speed, underinflation, or excessive loading, either separately or in combination, can cause heat buildup and possible tire failure.

The temperature grades are A (the highest), B and C, representing the tire's resistance to the generation of heat and its ability to dissipate heat when tested under controlled conditions on a specified indoor laboratory

test wheel. Sustained high temperature can cause the material of the tire to degenerate and reduce tire life, and excessive temperature can lead to sudden tire failure. The grade C corresponds to a level of performance which all passenger car tires must meet under the Federal Motor Vehicle Safety Standard No. 139. Grades B and A represent higher levels of performance on the laboratory test wheel than the minimum required by law.

## INFORMATION ON THE TIRE SIDEWALL

Both United States and Canada Federal regulations require tire manufacturers to place standardized information on the sidewall of all tires. This information identifies and describes the fundamental characteristics of the tire and also provides a U.S. DOT Tire Identification Number for safety standard certification and in case of a recall.

# Wheel and Tire Information

## Information on P Type Tires

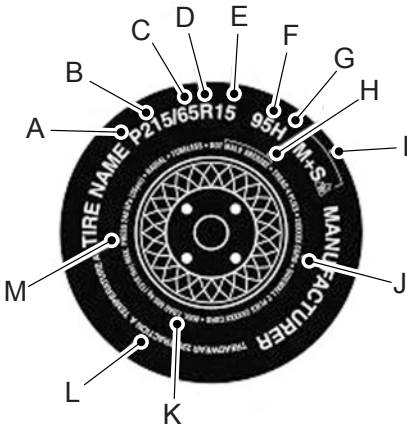

P215/65R15 95H is an example of a tire size, load index and speed rating. The definitions of these items are listed below. (Note that the tire size, load index and speed rating for your vehicle may be different from this example.)

**A. P:** Indicates a tire, designated by the Tire and Rim Association, that may be used for service on cars, sport utility vehicles, minivans and light trucks. **Note:** If your tire size does not begin with a letter this may mean it is designated by either the European Tire and Rim Technical Organization or the Japan Tire Manufacturing Association.

**B. 215:** Indicates the nominal width of the tire in millimeters from sidewall edge to sidewall edge. In general, the larger the number, the wider the tire.

**C. 65:** Indicates the aspect ratio which gives the tire's ratio of height to width.

**D. R:** Indicates a radial type tire.

**E. 15:** Indicates the wheel or rim diameter in inches. If you change your wheel size, you will have to purchase new tires to match the new wheel diameter.

**F. 95:** Indicates the tire's load index. It is an index that relates to how much weight a tire can carry. You may find this information in your owner's manual. If not, contact a local tire dealer.

**Note:** *You may not find this information on all tires because it is not required by federal law.*

**G. H:** Indicates the tire's speed rating. The speed rating denotes the speed at which a tire is designed to be driven for extended periods of time under a standard condition of load and inflation pressure. The tires on your vehicle may operate at different conditions for load and inflation pressure. These speed ratings may need to be adjusted for the difference in conditions. The ratings range from 81 mph (130 km/h) to 186 mph (299 km/h). These ratings are listed in the following chart.

## Wheel and Tire Information

**Note:** You may not find this information on all tires because it is not required by federal law.

Letter rating	Speed rating
M	81 mph (130 km/h)
N	87 mph (140 km/h)
Q	99 mph (159 km/h)
R	106 mph (171 km/h)
S	112 mph (180 km/h)
T	118 mph (190 km/h)
U	124 mph (200 km/h)
H	130 mph (210 km/h)
V	149 mph (240 km/h)
W	168 mph (270 km/h)
Y	186 mph (299 km/h)

**Note:** For tires with a maximum speed capability over 149 mph (240 km/h), tire manufacturers sometimes use the letters ZR. For those with a maximum speed capability over 186 mph (299 km/h), tire manufacturers always use the letters ZR.

**H. U.S. DOT Tire Identification Number (TIN):** This begins with the letters DOT and indicates that the tire meets all federal standards. The next two numbers or letters are the plant code designating where it was manufactured, the next two are

the tire size code and the last four numbers represent the week and year the tire was built. For example, the numbers 317 mean the 31st week of 1997. After 2000, the numbers go to four digits. For example, 2501 means the 25th week of 2001. The numbers in between are identification codes used for traceability. This information is used to contact customers if a tire defect requires a recall.

**I. M+S or M/S:** Mud and Snow, or

**AT:** All Terrain, or

**AS:** All Season.

**J. Tire Ply Composition and Material Used:** Indicates the number of plies or the number of layers of rubber-coated fabric in the tire tread and sidewall. Tire manufacturers also must indicate the ply materials in the tire and the sidewall, which include steel, nylon, polyester, and others.

**K. Maximum Load:** Indicates the maximum load in kilograms and pounds that can be carried by the tire. See the Safety Compliance Certification Label (affixed to either the door hinge pillar, door-latch post, or the door edge that meets the door-latch post, next to the driver's seating position), for the correct tire pressure for your vehicle.

**L. Treadwear, Traction and Temperature Grades:**

## Wheel and Tire Information

**\*Treadwear** The treadwear grade is a comparative rating based on the wear rate of the tire when tested under controlled conditions on a specified government test course. For example, a tire graded 150 would wear one and one-half times as well on the government course as a tire graded 100.

**\*Traction:** The traction grades, from highest to lowest are AA, A, B, and C. The grades represent the tire's ability to stop on wet pavement as measured under controlled conditions on specified government test surfaces of asphalt and concrete. A tire marked C may have poor traction performance.

**\*Temperature:** The temperature grades are A (the highest), B and C, representing the tire's resistance to the generation of heat and its ability to dissipate heat when tested under controlled conditions on a specified indoor laboratory test wheel.

### M. Maximum Inflation

**Pressure:** Indicates the tire manufacturers' maximum permissible pressure or the pressure at which the maximum load can be carried by the tire. This pressure is normally higher than the vehicle manufacturer's recommended cold inflation pressure which can be found on the Safety Compliance Certification Label (affixed to either the door hinge pillar, door-latch post, or the door edge

that meets the door-latch post, next to the driver's seating position), or Tire Label which is located on the B-Pillar or the edge of the driver's door. The cold inflation pressure should never be set lower than the recommended pressure on the vehicle label.

The tire suppliers may have additional markings, notes or warnings such as standard load or radial tubeless.

### Additional Information Contained on the Tire Sidewall for LT Type Tires

**Note:** *Tire Quality Grades do not apply to this type of tire.*

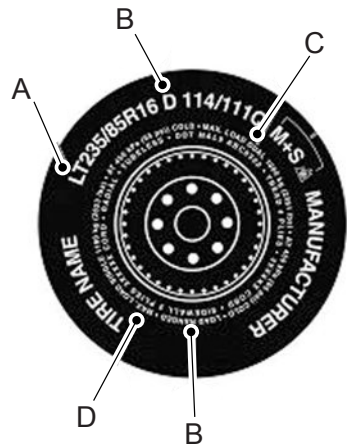

LT type tires have some additional information beyond those of P type tires; these differences are described below.

# Wheel and Tire Information

A. **LT:** Indicates a tire, designated by the Tire and Rim Association, that is intended for service on light trucks.

B. **Load Range and Load Inflation Limits:** Indicates the tire's load-carrying capabilities and its inflation limits.

C. **Maximum Load Dual lb (kg) at psi (kPa) cold:** Indicates the maximum load and tire pressure when the tire is used as a dual, defined as four tires on the rear axle (a total of six or more tires on the vehicle).

D. **Maximum Load Single lb (kg) at psi (kPa) cold:** Indicates the maximum load and tire pressure when the tire is used as a single, defined as two tires (total) on the rear axle.

## Information on T Type Tires

T145/80D16 is an example of a tire size.

**Note:** *The temporary tire size for your vehicle may be different from this example. Tire Quality Grades do not apply to this type of tire.*



T type tires have some additional information beyond those of P type tires; these differences are described below:

A. **T:** Indicates a type of tire, designated by the Tire and Rim Association, that is intended for temporary service on cars, sport utility vehicles, minivans and light trucks.

B. **145:** Indicates the nominal width of the tire in millimeters from sidewall edge to sidewall edge. In general, the larger the number, the wider the tire.



# Wheel and Tire Information

---

C. **80:** Indicates the aspect ratio which gives the tire's ratio of height to width. Numbers of 70 or lower indicate a short sidewall.

D. **D:** Indicates a diagonal type tire.

**R:** Indicates a radial type tire.

E. **16:** Indicates the wheel or rim diameter in inches. If you change your wheel size, you will have to purchase new tires to match the new wheel diameter.

## GLOSSARY OF TIRE TERMINOLOGY

\***Tire label:** A label showing the original equipment tire sizes, recommended inflation pressure and the maximum weight the vehicle can carry.

\***Tire Identification Number (TIN):** A number on the sidewall of each tire providing information about the tire brand and manufacturing plant, tire size and date of manufacture. Also referred to as DOT code.

\***Inflation pressure:** A measure of the amount of air in a tire.

\***Standard load:** A class of P-metric or Metric tires designed to carry a maximum load at set pressure. For example: For P-metric tires 35 psi (2.4 bar) and for Metric tires 36 psi (2.5 bar). Increasing the inflation pressure beyond this pressure will not increase the tire's load carrying capability.

\***Extra load:** A class of P-metric or Metric tires designed to carry a heavier maximum load at 42 psi (2.9 bar). Increasing the inflation pressure beyond this pressure will not increase the tire's load carrying capability.

\***kPa:** Kilopascal, a metric unit of air pressure.

\***PSI:** Pounds per square inch, a standard unit of air pressure.

\***Cold tire pressure:** The tire pressure when the vehicle has been stationary and out of direct sunlight for an hour or more and prior to the vehicle being driven for 1 mi (1.6 km).

\***Recommended inflation pressure:** The cold inflation pressure found on the Safety Compliance Certification Label (affixed to either the door hinge pillar, door-latch post, or the door edge that meets the door-latch post, next to the driver's seating position), or Tire Label located on the B-Pillar or the edge of the driver door.

\* **B-pillar:** The structural member at the side of the vehicle behind the front door.

\***Bead area of the tire:** Area of the tire next to the rim.

\* **Sidewall of the tire:** Area between the bead area and the tread.

# Wheel and Tire Information

**\*Tread area of the tire:** Area of the perimeter of the tire that contacts the road when mounted on the vehicle.

**\*Rim:** The metal support (wheel) for a tire or a tire and tube assembly upon which the tire beads are seated.

## TIRE REPLACEMENT REQUIREMENTS

Your vehicle comes with tires designed to provide a safe ride and handling capability.



**WARNING:** Only use replacement tires and wheels that are the same size, load index, speed rating and type (such as P-metric versus LT-metric or all-season versus all-terrain) as those originally provided by Ford. The recommended tire and wheel size may be found on either the Safety Compliance Certification Label (affixed to either the door hinge pillar, door-latch post, or the door edge that meets the door-latch post, next to the driver's seating position), or the Tire Label which is located on the B-Pillar or edge of the driver's door. If this information is not found on these labels, then you should contact your authorized dealer as soon as possible. Use of any tire or wheel not recommended by Ford can

affect the safety and performance of your vehicle, which could result in an increased risk of loss of vehicle control, vehicle rollover, personal injury and death.



**WARNING:** To reduce the risk of serious injury, when mounting replacement tires and wheels, you should not exceed the maximum pressure indicated on the sidewall of the tire to set the beads without additional precautions listed below. If the beads do not seat at the maximum pressure indicated, re-lubricate and try again.



**WARNING:** For a mounting pressure more than 20 psi (1.38 bar) greater than the maximum pressure, a Ford dealer or other tire service professional should do the mounting.



**WARNING:** Always inflate steel carcass tires with a remote air fill with the person inflating standing at a minimum of 12 ft (3.66 m) away from the wheel and tire assembly.

## Wheel and Tire Information



**WARNING:** When inflating the tire for mounting pressures up to 20 psi (1.38 bar) greater than the maximum pressure on the tire sidewall, the following precautions must be taken to protect the person mounting the tire:

- Make sure that you have the correct tire and wheel size.
- Lubricate the tire bead and wheel bead seat area again.
- Stand at a minimum of 12 ft (3.66 m) away from the wheel and tire assembly.
- Use both eye and ear protection.

**Important:** Remember to replace the wheel valve stems when you replace the road tires on your vehicle.

It is recommended that you generally replace the two front tires or two rear tires as a pair if the worn tires still have usable depth.

To avoid potential All-Wheel Drive (AWD) malfunction or (AWD) system damage, we recommend you replace all four tires rather than mixing significantly worn tires with new tires.

The tire pressure sensors mounted in the wheels (originally installed on your vehicle) are not designed to be used in aftermarket wheels.

The use of wheels or tires not recommended may affect the operation of your tire pressure monitoring system.

If the tire pressure monitoring system indicator is flashing, your system is malfunctioning. Your replacement tire might be incompatible with your tire pressure monitoring system, or some component of the system may be damaged.

### Age



**WARNING:** Tires degrade over time depending on many factors such as weather, storage conditions, and conditions of use (load, speed, inflation pressure) the tires experience throughout their lives.

In general, tires should be replaced after six years regardless of tread wear. However, heat caused by hot climates or frequent high loading conditions can accelerate the aging process and may require tires to be replaced more frequently.

You should replace your spare tire when you replace the road tires or after six years due to aging even if it has not been used.

# Wheel and Tire Information

---

## U.S. DOT Tire Identification Number

Both United States and Canada Federal regulations require tire manufacturers to place standardized information on the sidewall of all tires. This information identifies and describes the fundamental characteristics of the tire and also provides a U.S. DOT Tire Identification Number for safety standard certification and in case of a recall.

This begins with the letters DOT and indicates that the tire meets all federal standards. The next two numbers or letters are the plant code designating where it was manufactured, the next two are the tire size code and the last four numbers represent the week and year the tire was built. For example, the numbers 317 mean the 31st week of 1997. After 2000, the numbers go to four digits. For example, 2501 means the 25th week of 2001. The numbers in between are identification codes used for traceability. This information is used to contact customers if a tire defect requires a recall.

## USING SUMMER TIRES

Summer tires provide superior performance on wet and dry roads. Summer tires do not have the Mud and Snow (M+S or M/S) tire traction rating on the tire side wall. Since summer tires do not have the same traction performance as All-season or Snow tires, we do not recommend using summer tires when temperatures drop to about 45°F (7°C) or below, depending on tire wear and environmental conditions, or in snow and ice conditions. Like any tire, summer tire performance is affected by tire wear and environmental conditions. If you must drive in those conditions, we recommend using Mud and Snow (M+S, M/S), All-season or Snow tires.

Always store your summer tires indoors at temperatures above 19°F (-7°C). The rubber compounds used in these tires lose flexibility and may develop surface cracks in the tread area at temperatures below 19°F (-7°C). If the tires have been subjected to 19°F (-7°C) or less, warm them in a heated space to at least 41°F (5°C) for at least 24 hours before installing them on a vehicle, or moving the vehicle with the tires installed, or checking tire inflation. Always inspect the tires after storage periods and before use.

# Wheel and Tire Information

## USING WINTER TIRES



We recommend that you use winter or all-season tires carrying this symbol when the temperature is 45°F (7°C) or lower, or in snow and ice conditions.

When using winter tires, install them on all wheels and inflate them to the recommended tire pressures listed on the tire label. See **Locating the Safety Compliance Certification Labels** (page 272).



**WARNING:** Wheels and tires must be the same size, load index and speed rating as those originally fitted on the vehicle. Use of any other tire or wheel can affect the safety and performance of your vehicle. Additionally, the use of non-recommended tires and wheels can cause steering, suspension, axle, transfer case or power transfer unit failure. Follow the recommended tire inflation pressures found on the Safety Compliance Certification label, or the Tire Label on the B-Pillar or the edge of the driver door. Failure to follow this instruction could result in loss of vehicle control, vehicle rollover, or personal injury or death.

## USING SNOW CHAINS



**WARNING:** Do not exceed 30 mph (50 km/h). Failure to follow this instruction could result in the loss of control of your vehicle, personal injury or death.



**WARNING:** Do not use snow chains on snow-free roads.



**WARNING:** Only fit snow chains to specified tires.



**WARNING:** If your vehicle is fitted with wheel trims, remove them before fitting snow chains.



**WARNING:** Remember that even advanced technology cannot defy the laws of physics. It's always possible to lose control of a vehicle due to inappropriate driver input for the conditions. Aggressive driving on any road condition can cause you to lose control of your vehicle increasing the risk of personal injury or property damage. Activation of the electronic stability control system is an indication that at least some of the tires have exceeded their ability to grip the road; this could reduce the operator's ability to control the vehicle potentially resulting in a loss of vehicle control, vehicle rollover, personal injury and death. If your electronic stability control system activates, SLOW DOWN.



**WARNING:** Wheels and tires must be the same size, load index and speed rating as those originally fitted on the vehicle. Use of any other tire or wheel can affect the safety and performance of your vehicle. Additionally, the use of non-recommended tires and wheels can cause steering, suspension, axle, transfer

# Wheel and Tire Information

---

case or power transfer unit failure. Follow the recommended tire inflation pressures found on the Safety Compliance Certification label, or the Tire Label on the B-Pillar or the edge of the driver door. Failure to follow this instruction could result in loss of vehicle control, vehicle rollover, or personal injury or death.

The tires on your vehicle could have all-weather treads to provide traction in rain and snow. In some climates you will need to use snow tires and chains on your vehicle in emergency situations or if required by law.

**Note:** *The suspension insulation and bumpers will help prevent vehicle damage. Do not remove these components from your vehicle when using snow tires and chains.*

**Note:** *Driving too fast for road conditions creates the possibility of loss of vehicle control. Driving at very high speeds for extended periods of time may result in damage to vehicle components.*

**Note:** *Snow chains could damage aluminum wheels.*

Follow these guidelines when using snow tires and chains:

- Use ultra low profile cables, 10 mm or less in dimension as measured on the sidewall of your tire, only with 225/60R18 all season tires.
- Do not use snow chains or cables with 225/55R19 or 245/45R20.
- Not all S-class snow chains or cables meet the same restrictions. Chains of this size restriction will include a tensioning device.
- Purchase chains or cables from a manufacturer that clearly labels body to tire dimension restrictions. The snow chains or cables must be mounted in pairs on the rear tires only.

- When driving with snow chains do not exceed 30 mph (50 km/h) or the maximum speed recommended by the chain manufacturer, whichever is less.
- Install cables securely, verifying that the cables do not touch any wiring or brake lines.
- Drive cautiously. If you hear the cables rub or bang against the vehicle, stop and retighten them. If this does not work, remove the cables to prevent vehicle damage.
- Remove the tire chains when they are no longer needed. Do not use tire chains on dry roads.

If you have any questions regarding snow chains or cables, please contact your authorized dealer.

# Tire Care

## CHECKING THE TIRE PRESSURES

Safe operation of your vehicle requires that your tires are properly inflated. Every day before you drive, check your tires.

At least once a month and before long trips, inspect each tire and check the tire pressure with a tire gauge. Inflate all tires to the recommended inflation pressure. See **Inflating the Tires** (page 331).

## INFLATING THE TIRES



**WARNING:** Under-inflation is the most common cause of tire failures and may result in severe tire cracking, tread separation or blowout, with unexpected loss of vehicle control and increased risk of injury. Under-inflation increases sidewall flexing and rolling resistance, resulting in heat buildup and internal damage to the tire. It also may result in unnecessary tire stress, irregular wear, loss of vehicle control and accidents. A tire can lose up to half of its air pressure and not appear to be flat!



**WARNING:** Do not use the tire pressure displayed in the information display as a tire pressure gauge. Failure to follow this instruction could result in personal injury or death.

Use the recommended cold inflation pressure for optimum tire performance and wear. Under-inflation or over-inflation may cause uneven treadwear patterns.

Inflate your tires to the recommended inflation pressure even if it is less than the maximum inflation pressure information found on the tire. You can find the tire label with the recommended tire inflation pressure next to the tire size on the B-Pillar or the edge of the driver door.

The recommended tire inflation pressure is also found on the Safety Compliance Certification Label, affixed to either the door hinge pillar, door-latch post, or the door edge that meets the door-latch on the B-pillar, or on the edge of the driver door.

Failure to follow the tire pressure recommendations can cause uneven treadwear patterns and adversely affect the way your vehicle handles.

# Tire Care

## INSPECTING THE TIRE FOR WEAR



When the tread is worn down to one sixteenth of an inch (2 mm), tires must be replaced to help prevent your vehicle from skidding and hydroplaning. Built-in treadwear indicators, or wear bars, which look like narrow strips of smooth rubber across the tread will appear on the tire when the tread is worn down to one sixteenth of an inch (2 mm).

When the tire tread wears down to the same height as these wear bars, the tire is worn out and must be replaced.

The tires should also be balanced periodically. An unbalanced tire and wheel assembly may result in irregular tire wear.

Periodically inspect the tire treads for uneven or excessive wear and remove objects such as stones, nails or glass that may be wedged in the tread grooves.

## INSPECTING THE TIRE FOR DAMAGE

Inspect the tire sidewalls for cracking, cuts, bruises and other signs of damage or excessive wear. If internal damage to the tire is suspected, have the tire dismantled and inspected in case it needs to be repaired or replaced. For your safety, tires that are damaged or show signs of excessive wear should not be used because they are more likely to blow out or fail.

Periodically inspect the tire treads and sidewalls for damage, such as bulges in the tread or sidewalls, cracks in the tread groove and separation in the tread or sidewall. If damage is observed or suspected, have the tire inspected by a tire professional.

## Safety Practices



**WARNING:** If your vehicle is stuck in snow, mud or sand, do not rapidly spin the tires; spinning the tires can tear the tire and cause an explosion. A tire can explode in as little as three to five seconds.



**WARNING:** Do not spin the wheels at over 34 mph (55 km/h). The tires may fail and injure a passenger or bystander.



# Tire Care

## Highway Hazards

No matter how carefully you drive, there is always the possibility that you could eventually have a flat tire on the highway. Drive slowly to the closest safe area out of traffic. This could further damage the flat tire, but your safety is more important.

If you feel a sudden vibration or ride disturbance while driving, or you suspect your tire or vehicle has been damaged, immediately reduce your speed. Drive with caution until you can safely pull off the road. Stop and inspect the tires for damage. If a tire is under-inflated or damaged, deflate it, remove the wheel and replace it with your spare tire and wheel. If you cannot detect a cause, have the vehicle towed to the nearest repair facility or tire dealer to have the vehicle inspected.

## Tire and Wheel Alignment

A bad jolt from hitting a curb or pothole can cause the front end of your vehicle to become misaligned or cause damage to your tires. If your vehicle seems to pull to one side when you are driving, the wheels could be out of alignment. Have an authorized dealer check the wheel alignment periodically.

Wheel misalignment in the front or the rear can cause uneven and rapid treadwear of your tires and should be corrected by an authorized dealer.

## INSPECTING THE WHEEL VALVE STEMS

Check the valve stems for holes, cracks, or cuts that could permit air leakage.

## TIRE ROTATION



**WARNING:** If the tire label shows different tire pressures for the front and rear tires and the vehicle has a tire pressure monitoring system, then you need to update the settings for the system sensors. Always perform the system reset procedure after tire rotation. If you do not reset the system, it may not provide a low tire pressure warning when necessary.

Rotating your tires at the recommended interval will help your tires wear more evenly, providing better tire performance and longer tire life.

**Note:** *If your tires show any uneven wear have the alignment checked by an authorized dealer before rotating tires.*

# Tire Care

---

**Note:** *If you have a dissimilar spare wheel and tire assembly, it is intended for temporary use only and should not be used in a tire rotation.*

**Note:** *After having your tires rotated, inflation pressure must be checked and adjusted to the vehicle requirements.*

## Tire Rotation Diagram

Follow the diagram indicating the correct tire locations for rotating the tires.

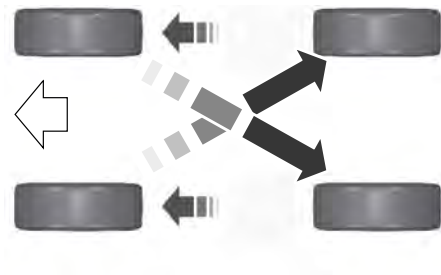

# Tire Sealant and Inflator Kit

## WHAT IS THE TIRE SEALANT AND INFLATOR KIT

The kit consists of an air compressor to re-inflate the tire and a canister of sealing compound that effectively seals most punctures. This kit provides a temporary tire repair allowing you to drive your vehicle up to 120 mi (200 km) at a maximum speed of 50 mph (80 km/h) to reach a tire service location.

## TIRE SEALANT AND INFLATOR KIT PRECAUTIONS



**WARNING:** Depending on the type and extent of tire damage, some tires can only be partially sealed or not sealed at all. Loss of tire pressure can affect vehicle handling, leading to loss of vehicle control.



**WARNING:** Do not use the kit on a previously damaged tire, for example when it has been driven under inflated. This could cause loss of vehicle control, personal injury or death.

Do not attempt to repair punctures larger than 0.24 in (6 mm) or damage to the tire's sidewall.

Only punctures located within the tire tread can be sealed with the kit.

Only use the kit supplied with your vehicle.

The temporary mobility kit contains enough sealant compound in the canister for one tire repair only.

After using the sealant, an authorized dealer needs to replace the tire pressure monitoring system sensor and valve stem on the wheel.

## LOCATING THE TIRE SEALANT AND INFLATOR KIT

The kit is located under the load floor in the rear of the vehicle.

## TIRE SEALANT AND INFLATOR KIT COMPONENTS

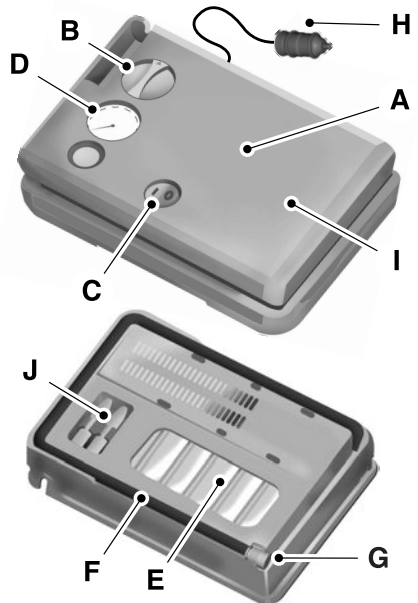

- A Air compressor (inside)
- B Selector switch
- C On and Off button
- D Air pressure gauge
- E Sealant bottle and canister
- F Dual purpose hose: air and repair
- G Tire valve connector

# Tire Sealant and Inflator Kit

- H Accessory power plug
- I Casing/housing
- J Bike/raft/sports ball adapters

## USING THE TIRE SEALANT AND INFLATOR KIT

### Tips for use of the kit

To ensure safe operation of the kit:

- Before operating the kit, make sure your vehicle is safely off the road and away from moving traffic.
- Do not remove any foreign objects, such as nails or screws, from the tire.
- Do not allow the compressor to operate continuously for more than 15 minutes. This will help prevent the compressor from overheating.
- Only use the kit when the ambient temperature is between -22°F (-30°C) and 158°F (70°C).
- Only use the sealing compound before the use-by date. The use-by date is on a label on the sealant canister and can be seen through the rectangular viewing window on the bottom of the compressor. Check the use-by date regularly and replace the canister when the sealant expires.

**Note:** Sealant compound contains latex. Use appropriate precautions to avoid any allergic reactions.



When inflation only is required for a tire or other objects, the selector must be in the Air position.

### What to do when a tire is punctured

A tire puncture within the tire's tread area can be repaired in two stages with the kit.

- In the first stage, the tire will be reinflated with a sealing compound and air. After the tire has been inflated, you will need to drive the vehicle a short distance approximately 4 mi (6 km) to distribute the sealant in the tire.
- In the second stage, you will need to check the tire pressure and adjust, if necessary, to the vehicle's specified tire inflation pressure.

### First Stage: Reinflating the Tire with sealing compound and air



**WARNING:** Do not stand directly over the kit while inflating the tire. If you notice any unusual bulges or deformations in the tire's sidewall during inflation, stop and call roadside assistance.



**WARNING:** If the tire does not inflate to the recommended tire pressure within 15 minutes, stop and call roadside assistance.

Park the vehicle in a safe, level and secure area, away from moving traffic.

Turn the hazard lights on. Apply the parking brake and power off the vehicle. Inspect the flat tire for visible damage.

If a puncture is located in the tire sidewall, stop and call roadside assistance.

1. Remove the valve cap from the tire valve.
2. Unwrap the dual purpose hose (black tube) from the back of the compressor housing.
3. Fasten the hose to the tire valve by turning the connector clockwise. Tighten the connection securely.

## Tire Sealant and Inflator Kit

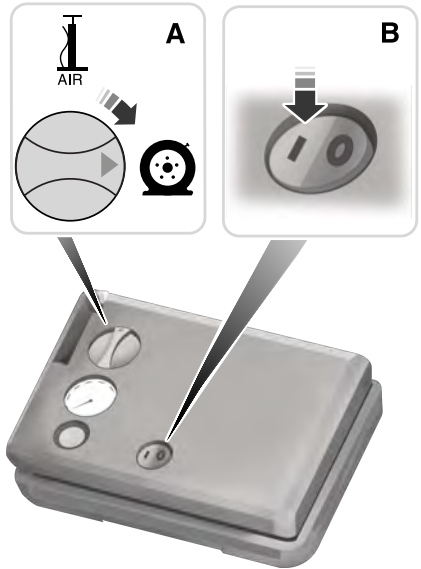
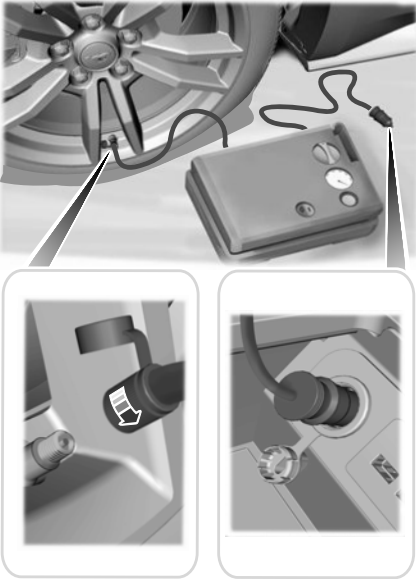

4. Plug the power cable into the 12-volt power point in the vehicle.
5. Remove the warning sticker found on the casing/housing and place it on the top of the instrument panel or the center of the dash.
6. Turn dial (A) clockwise to the sealant position. Turn the kit on by pressing the on/off button (B).
7. Inflate the tire to the pressure listed on the tire label located on the driver door or the door jamb area. The final tire pressure should be checked with the compressor turned off in order to get an accurate pressure reading.

# Tire Sealant and Inflator Kit

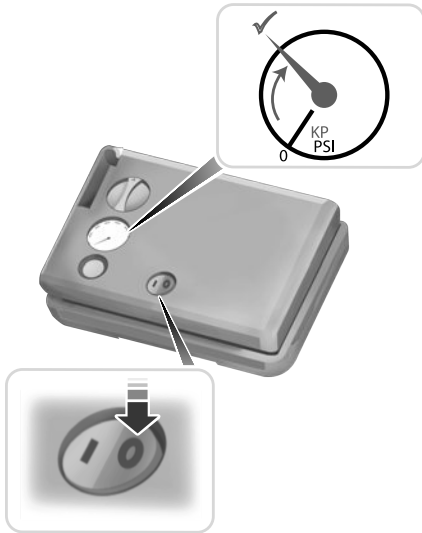

## Second Stage: Checking the tire pressure with the inflator kit

**WARNING:** If the tire does not inflate to the recommended tire pressure within 15 minutes, stop and call roadside assistance.

**WARNING:** The power plug may get hot after use and should be handled carefully when unplugging.

Check the air pressure of your tires as follows:



8. When the recommended tire pressure is reached, turn off the kit, unplug the power cable, and disconnect the hose from the tire valve. Re-install the valve cap on the tire valve and return the kit to the rear of the vehicle.
9. Drive the vehicle 4 mi (6 km) to distribute the sealant evenly inside the tire.

**Note:** *If you experience any unusual vibration, ride disturbance or noise while driving, reduce your speed until you can safely pull off to the side of the road to call for roadside assistance. Do not proceed to the second stage of this operation.*

1. Remove the valve cap from the tire valve.
2. Firmly screw the air compressor hose onto the valve stem by turning clockwise.
3. Push and turn the dial clockwise to the air position.
4. If required, turn on the compressor and adjust the tire to the recommended inflation pressure.
5. Unplug the hoses, re-install the valve cap on the tire and return the kit to the rear of the vehicle.

# Tire Sealant and Inflator Kit

## What to do after the tire has been sealed

After using the kit to seal your tire, you will need to replace the sealant canister. Sealant canisters and spare parts can be obtained at an authorized dealer. Empty sealant canisters may be disposed of at home. However, canisters still containing liquid sealant should be disposed of in accordance with local waste disposal regulation.

## Removal of the sealant canister from the kit

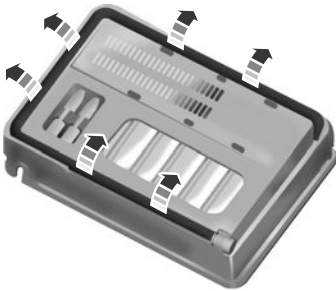

1. Unwrap the dual purpose hose (black tube) from the compressor housing.



2. Unwrap the power cord.



3. Remove the back cover.



4. Rotate the sealant canister up 90 degrees and pull away from casing/housing to remove.

## Installation of the sealant canister to the kit

1. With the canister held perpendicular to the housing, insert the canister nozzle into the connector and push until seated.
2. Rotate the canister 90 degrees down into the housing/casing.

# Tire Sealant and Inflator Kit

---



3. Snap the back cover back into place.



4. Wrap the dual purpose hose (black tube) around the channel on the bottom of the housing/casing.

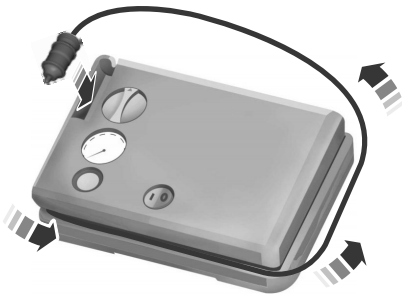

5. Wrap the power cord around the housing and stow the accessory power plug.



# Tire Pressure Monitoring System

## WHAT IS THE TIRE PRESSURE MONITORING SYSTEM



The tire pressure monitoring system measures the vehicle's tire pressures. A warning lamp illuminates if one or more tires are significantly underinflated or if there is a system malfunction.

## TIRE PRESSURE MONITORING SYSTEM OVERVIEW



**WARNING:** If the tire pressure monitor sensor becomes damaged it may not function.



**WARNING:** Under-inflation is the most common cause of tire failures and may result in severe tire cracking, tread separation or blowout, with unexpected loss of vehicle control and increased risk of injury. Under-inflation increases sidewall flexing and rolling resistance, resulting in heat buildup and internal damage to the tire. It also may result in unnecessary tire stress, irregular wear, loss of vehicle control and accidents. A tire can lose up to half of its air pressure and not appear to be flat!



**WARNING:** To determine the required pressure(s) for your vehicle, see the Safety Compliance Certification Label (on the door hinge pillar, door-latch post or the door edge that meets the door-latch post, next to the driver seat) or the Tire Label on the B-Pillar or the edge of the driver door.

Each tire, including the spare (if provided), should be checked monthly when cold and inflated to the inflation pressure recommended by the vehicle manufacturer on the vehicle placard or tire inflation pressure label. (If your vehicle has tires of a different size than the size indicated on the vehicle placard or tire inflation pressure label, you should determine the proper tire inflation pressure for those tires).

As an added safety feature, your vehicle has been equipped with a Tire Pressure Monitoring System (TPMS) that illuminates a low tire pressure telltale when one or more of your tires is significantly under-inflated. Accordingly, when the low tire pressure telltale illuminates, you should stop and check your tires as soon as possible, and inflate them to the proper pressure. Driving on a significantly under-inflated tire causes the tire to overheat and can lead to tire failure. Under-inflation also reduces fuel efficiency and tire tread life, and may affect the vehicle's handling and stopping ability.

Please note that the TPMS is not a substitute for proper tire maintenance, and it is the driver's responsibility to maintain correct tire pressure, even if under-inflation has not reached the level to trigger illumination of the TPMS low tire pressure telltale.

Your vehicle has also been equipped with a TPMS malfunction indicator to indicate when the system is not operating properly. The TPMS malfunction indicator is combined with the low tire pressure telltale. When the system detects a malfunction, the telltale will flash for approximately one minute and then remain continuously illuminated. This sequence will continue upon subsequent vehicle start-ups as long as the malfunction exists.

# Tire Pressure Monitoring System

When the malfunction indicator is illuminated, the system may not be able to detect or signal low tire pressure as intended. TPMS malfunctions may occur for a variety of reasons, including the installation of replacement or alternate tires or wheels on the vehicle that prevent the TPMS from functioning properly. Always check the TPMS malfunction telltale after replacing one or more tires or wheels on your vehicle to ensure that the replacement or alternate tires and wheels allow the TPMS to continue to function properly.



**WARNING:** Changes or modifications not expressly approved by the party responsible for compliance could void the user's authority to operate the equipment. The term "IC:" before the radio certification number only signifies that Industry Canada technical specifications were met.

This device complies with Part 15 of the FCC Rules and with License exempt RSS Standards of Industry Canada. Operation is subject to the following two conditions:

1. This device may not cause harmful interference, and
2. This device must accept any interference received, including interference that may cause undesired operation.

## TIRE PRESSURE MONITORING SYSTEM PRECAUTIONS



**WARNING:** The tire pressure monitoring system is not a substitute for manually checking tire pressures. You should periodically check tire pressures using a pressure gauge. Failure to correctly maintain tire pressures could increase the risk of tire failure, loss of control, vehicle rollover and personal injury.



**WARNING:** Do not use the tire pressure displayed in the information display as a tire pressure gauge. Failure to follow this instruction could result in personal injury or death.

**Note:** *The use of tire sealants can damage the tire pressure monitoring system.*

## TIRE PRESSURE MONITORING SYSTEM LIMITATIONS

When the outside temperature drops significantly, the tire pressure could decrease and activate the low tire pressure warning lamp.

The warning lamp could also illuminate when you use a spare wheel, or tire sealant from the inflator kit.

**Note:** *Regularly checking the vehicle tire pressures can reduce the possibility for the warning lamp to illuminate due to outside air temperature changes.*

**Note:** *After you inflate the tires to the recommended pressure it could take up to two minutes of driving over 20 mph (32 km/h) for the warning indicator to turn off.*

# Tire Pressure Monitoring System

## VIEWING THE TIRE PRESSURES



To view the current tire pressures, use the information display or touchscreen.

## TIRE PRESSURE MONITORING SYSTEM – TROUBLESHOOTING

### TIRE PRESSURE MONITORING SYSTEM – WARNING LAMPS



The low tire pressure warning lamp has combined functions, as it warns you when your tires need air, and when the system is no longer capable of functioning as intended.

Warning Lamp	Possible Cause	Action Required
Solid warning lamp	One or more tires are significantly under inflated	After inflating your tires to the manufacturer's recommended pressure as shown on the tire label, on the edge of driver door or the B-pillar, drive your vehicle for at least two minutes over 20 mph (32 km/h) before the light turns off.
Solid warning lamp or flashing warning lamp	Temporary spare wheel in use	Repair the damaged road wheel and tire and refit it to your vehicle to restore operation of the system.
	Tire pressure monitoring system malfunction	If the tires are inflated to the recommended tire pressures and the temporary spare wheel is not in use, the system detected a fault that requires service. Have your vehicle checked as soon as possible.

# Tire Pressure Monitoring System

## TIRE PRESSURE MONITORING SYSTEM – INFORMATION MESSAGES

<b>Message</b>	<b>Action</b>
Tire Pressure Low	After inflating your tires to the manufacturer's recommended pressure as shown on the tire label, on the edge of the driver door or the B-pillar, drive your vehicle for at least two minutes over 20 mph (32 km/h) before the light turns off.
Tire Pressure Monitor Fault	The system has detected a fault that requires service. Have your vehicle checked as soon as possible.
Tire Pressure Sensor Fault	The system has detected a fault that requires service or a spare tire is in use. Have your vehicle checked as soon as possible.

# Changing a Road Wheel

## WHEEL NUTS



**WARNING:** When you install a wheel, always remove any corrosion, dirt or foreign materials present on the mounting surfaces of the wheel or the surface of the wheel hub, brake drum or brake disc that contacts the wheel. Make

sure to secure any fasteners that attach the rotor to the hub so they do not interfere with the mounting surfaces of the wheel. Installing wheels without correct metal-to-metal contact at the wheel mounting surfaces can cause the wheel nuts to loosen and the wheel to come off while your vehicle is in motion, resulting in loss of vehicle control, personal injury or death.

Bolt Size	lb.ft (Nm) <sup>1</sup>
M14 x 1.5	150 lb.ft (204 Nm)

<sup>1</sup> Torque specifications are for nut and bolt threads free of dirt and rust. Use only our recommended replacement fasteners.

Retighten the lug nuts to the specified torque within 100 mi (160 km) after any wheel disturbance, such as tire rotation, changing a flat tire or wheel removal.



A Hub pilot bore.

Inspect the wheel pilot hole and mounting surface prior to installation. Remove any visible corrosion or loose particles.

# Capacities and Specifications

## MOTORCRAFT PARTS

Component	Motorcraft Part Number
12 volt battery.	BHAGM-H3
Cabin air filter.	FP-89
Windshield wiper blade.	WW-2432 (driver side) WW-2052 (passenger side) WW-1207 (rear window)

We recommend Motorcraft parts that are available at your authorized dealer or at [www.fordparts.com](http://www.fordparts.com). We engineer these parts for your vehicle to meet or exceed our specifications. Use of other parts could impact vehicle performance and durability. Your warranty could be void for any damage related to use of other parts.

## COOLING SYSTEM CAPACITY AND SPECIFICATION

Use coolant that meets the defined specification.

If you do not use coolant that meets the defined specification, it could result in:

- Component damage that your vehicle warranty does not cover.
- Reduced vehicle performance.
- Reduced range.

## HV Battery Cooling Loop

### Capacities

Variant	Quantity
4P battery.	9.54 qt (9.03 L)
3P battery.	8.57 qt (8.11 L)

### Materials

Name	Specification
Motorcraft® Yellow Prediluted Antifreeze/ Coolant(U.S.) Motorcraft® Yellow Prediluted Antifreeze/Coolant / Antigel/liquide de refroidissement prédilué jaune Motorcraft®(Canada) VC-13DL-G(U.S.) CVC-13DL-G(Canada)	WSS-M97B57-A2

# Capacities and Specifications

## Motor and Electronics Cooling Loop

### Capacities

Variant	Quantity
Rear-Wheel drive.	6.07 qt (5.74 L)
All-Wheel drive.	7.00 qt (6.62 L)

### Materials

Name	Specification
Motorcraft® Yellow Prediluted Antifreeze/ Coolant (U.S.) Motorcraft® Yellow Prediluted Antifreeze/Coolant / Antigel/liquide de refroidissement prédilué jaune Motorcraft® (Canada) VC-13DL-G (U.S.) CVC-13DL-G (Canada)	WSS-M97B57-A2

## AIR CONDITIONING SYSTEM CAPACITY AND SPECIFICATION



**WARNING:** The air conditioning refrigerant system contains refrigerant under high pressure. Only qualified personnel should service the air conditioning refrigerant system. Opening the air conditioning refrigerant system can cause personal injury.

Use refrigerant and oil that meets the defined specifications.

If you do not use refrigerant and oil that meets the defined specifications, it could result in:

- Component damage that your vehicle warranty does not cover.
- Reduced vehicle performance.
- Reduced range.

### Capacities

Variant	Refrigerant	Refrigerant Oil
All.	21 oz (0.6 kg)	4.7 fl oz (140 ml)

# Capacities and Specifications

## Materials

Name	Specification
R-1234yf Refrigerant(U.S.) R-1234yf Refrigerant / Frigorigène R-1234yf(Canada) YN-33-A(U.S.) HS7Z-19B519-BA(Canada)	WSS-M17B21-A
Motorcraft® R-1234yf Refrigerant POE Oil(U.S.) Motorcraft® R-1234yf Refrigerant POE Oil / Huile POE pour frigorigène R-1234yf Motorcraft®(Canada) YN-34(U.S. & Canada)	WSS-M2C31-B2

## WASHER FLUID SPECIFICATION

### Capacities

Variant	Quantity
All.	Fill as required.

## Materials

Name	Specification
Motorcraft® Premium Windshield Wash Concentrate with Bitterant(U.S.) Motorcraft® Premium Quality Windshield Washer Fluid / Liquide lave-glacé de haute qualité Motorcraft®(Canada) ZC-32-B2(U.S.) CXC-37-F/M(Canada)	WSS-M14P19-A

## BRAKE FLUID SPECIFICATION

Use fluid that meets the defined specification and viscosity grade.

If you do not use fluid that meets the defined specification and viscosity grade, it could result in:

- Component damage that your vehicle warranty does not cover.
- Reduced brake performance.



# Capacities and Specifications

---

**Note:** We recommend you use Dot 4 Low Viscosity (LV) High Performance Brake Fluid meeting WSS-M6C65-A2 specifications or ISO 4925 Class 6 standards. If you use any fluid other than the recommended fluid, it could cause reduced brake performance and not meet our performance standards. Keep brake fluid clean and dry. Contamination with dirt, water, petroleum products or other materials could result in brake system damage and possible failure.

## Capacities

Variant	Quantity
All.	Fill as required.

## Materials

Name	Specification
Motorcraft® DOT 4 LV High Performance Motor Vehicle Brake Fluid(U.S.) Motorcraft® DOT 4 LV High Performance Motor Vehicle Brake Fluid / Liquide de frein automobile haute performance DOT 4 LV Motorcraft®(Canada) PM-20(U.S. & Canada)	WSS-M6C65-A2

# Vehicle Identification

## VEHICLE IDENTIFICATION NUMBER

### LOCATING THE VEHICLE IDENTIFICATION NUMBER

The vehicle identification number is on the left-hand side of the instrument panel.

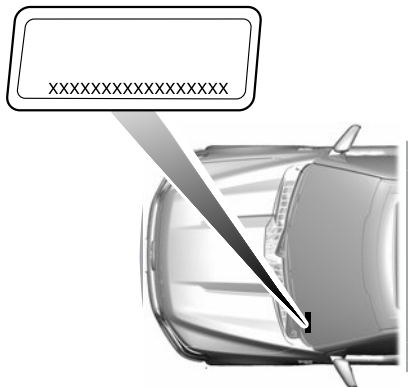

**Note:** In the illustration, XXXX is representative of your vehicle identification number.

### VEHICLE IDENTIFICATION NUMBER OVERVIEW

The vehicle identification number contains the following information:

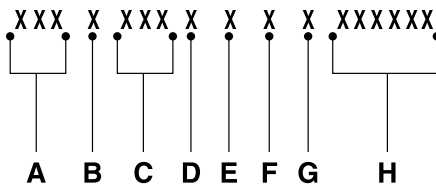

- A World manufacturer identifier.
- B Brake system, gross vehicle weight rating, restraint devices and their locations.
- C Make, vehicle line, series, body type.
- D Engine or motor type.
- E Check digit.
- F Model year.
- G Assembly plant.
- H Production sequence number.

### INSTALLING THE VEHICLE IDENTIFICATION CARD

Install any devices that use radio frequency identification, for example, toll readers or vehicle identification cards, to the specified area on the windshield.

**Note:** Follow the vehicle identification card provider's installation instructions.

**Note:** When installing the radio frequency identification device, do not block objects such as the rain sensor and the auto-dimming sensor.

## Vehicle Identification

---

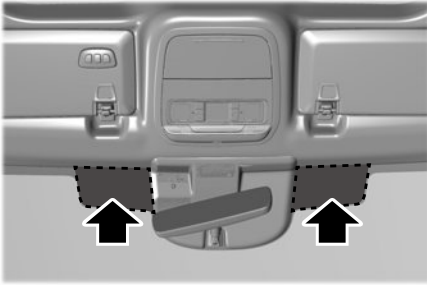

1. Place the device on the windshield, within one of the shaded areas at either side of the mirror.

**Note:** *The device must be placed in the defined areas shown. The remainder of the windshield has a coating that prevents the device from working properly.*

# Connected Vehicle

## WHAT IS A CONNECTED VEHICLE

A connected vehicle has technology that allows your vehicle to connect to a mobile network and for you to access a range of features. When used in conjunction with the FordPass app, it could allow you to monitor and control your vehicle further, for example checking the tire pressures, and the vehicle location. For additional information, refer to the local Ford website.

## CONNECTED VEHICLE REQUIREMENTS

Connected service and related feature functionality requires a compatible vehicle network.

Some remote features require additional service activation. Log in to your Ford account for details. Some restrictions, third party terms and message or data rates may apply.

## CONNECTED VEHICLE LIMITATIONS

Evolving technology, cellular networks, or regulations could affect functionality and availability, or continued provision of some features. These changes could even stop some features from functioning.

## CONNECTING THE VEHICLE TO A MOBILE NETWORK

### WHAT IS THE MODEM



The modem allows access to a range of features built into your vehicle.

## ENABLING AND DISABLING THE MODEM

Tap the vehicle drawer on the top left of the screen.

1. Press **Connectivity**.
2. Press **Connected Vehicle Features**.
3. Switch vehicle connectivity on or off.

## CONNECTING FORDPASS TO THE MODEM

1. Make sure that the modem is enabled using the vehicle settings menu.
2. Open the FordPass app on your device and log in.
3. Add your vehicle or select your vehicle if already added.
4. Select the option to activate your vehicle.
5. Make sure that the name on the screen matches the name shown in your FordPass account.
6. Confirm that FordPass account is connected to the modem.

## CONNECTING THE VEHICLE TO A WI-FI NETWORK

Access the application drawer on the touchscreen.

1. Press **Connectivity**.
2. Press **Manage Wi-Fi Networks**.
3. Switch **Wi-Fi** on.
4. Press **View Available Networks**.
5. Select an available Wi-Fi network.

**Note:** Enter the network password to connect to a secure network.

# Connected Vehicle

---

## CONNECTED VEHICLE – TROUBLESHOOTING

### CONNECTED VEHICLE – FREQUENTLY ASKED QUESTIONS

<b>Symptom</b>	<b>Possible Cause and Resolution</b>
I cannot confirm the connection of my FordPass account to the modem.	<ul style="list-style-type: none"><li>- Modem is not enabled.<ul style="list-style-type: none"><li>• Switch vehicle connectivity on.</li></ul></li><li>- Weak network signal.<ul style="list-style-type: none"><li>• Move your vehicle closer to a place where the network signal is not obstructed.</li></ul></li></ul>

# Connected Vehicle

---

## **CONNECTED VEHICLE – FREQUENTLY ASKED QUESTIONS**

### **Why can I not confirm the connection of my FordPass account to the modem?**

- The modem is not enabled. Switch vehicle connectivity on.
- The network signal is weak. Move your vehicle closer to a place where the network signal is not obstructed.

### **Why can I not connect to a Wi-Fi network?**

- You entered the wrong network password. Enter the correct password.
- The network signal is weak. Move your vehicle closer to the Wi-Fi router or to a place where the network signal is not obstructed.
- There are multiple access points in range with the same network name. Choose a unique name for your network. Do not use the default name unless it contains a unique identifier, for example as part of the MAC address.

### **Why does the Wi-Fi connection disconnect after successful connection?**

- The network signal is weak. Move your vehicle closer to the Wi-Fi router or to a place where the network signal is not obstructed.

### **What can I do if I am close to a Wi-Fi router but the network signal strength is weak?**

- If your vehicle has a heated windshield, position your vehicle so that the windshield is not facing the Wi-Fi router.

- If your vehicle has metallic tinting on the windows but not on the windshield, position your vehicle so that the windshield is facing the Wi-Fi router or open the windows that are facing the router.
- If your vehicle has metallic tinting on the windows and the windshield, open the windows that are facing the router.
- If your vehicle is in a garage and you have the garage door closed, open the garage door as it could block the signal.

### **Why can I not see a network I expect to see in the list of available networks?**

- The network is hidden. Make the network visible and try again, or manually add a network in the Wi-Fi settings menu.
- Some network security types are not supported, for example WEP.

### **Why do software downloads take too long?**

- The network signal is weak. Move your vehicle closer to the Wi-Fi router or to a place where the network signal is not obstructed.
- Wi-Fi network is in high demand or has a slow Internet connection. Use a more reliable Wi-Fi network.

## Connected Vehicle

---

### **Why does the software not update when the system seems to connect to a Wi-Fi network and the signal strength is excellent?**

- No software update is available at this time.
- Select automatic updates option in the settings menu to enable automatic software update or contact an authorized dealer.
- There could be a connection problem. Test the network using another device.

# Vehicle Wi-Fi Hotspot

---

## CREATING A VEHICLE WI-FI HOTSPOT

You can create a Wi-Fi hotspot in your vehicle and allow devices to connect to it for access to the Internet.

Tap the vehicle drawer on the top left of the screen.

1. Press **Vehicle Hotspot**.

**Note:** The vehicle hotspot default setting is on.

2. Press Settings under the Vehicle Hotspot menu.
3. Press **Edit**.
4. Switch the Wi-Fi Visibility option on or off.

**Note:** The Wi-Fi visibility default setting is on.

## Finding the Wi-Fi Hotspot Name and Password

Tap the vehicle drawer on the top left of the screen.

1. Press **Vehicle Hotspot**.
2. Press Settings under the Vehicle Hotspot menu.

**Note:** The network name is the hotspot name.

3. Switch the Show Password option on or off.

## Connecting a Device to the Wi-Fi Hotspot

1. On your device, switch Wi-Fi on and select the hotspot from the list of available Wi-Fi networks.
2. When prompted, enter the password.

## Purchasing a Data Plan

1. Connect a device to the hotspot.

**Note:** The vehicle network carrier's portal opens on your device.

2. If the portal does not open on your device, open a website and it redirects to the vehicle network carrier's portal.

**Note:** Secure websites do not redirect.

3. Follow the instructions on the carrier portal to purchase a plan.

**Note:** If you have an active plan, the system does not redirect to the vehicle network carrier's portal when you connect a device. Visit the vehicle network carrier's website to purchase more data.

**Note:** If data usage information is available in the vehicle hotspot menu, it is approximate.

**Note:** If you carry out a master reset, the system does not remove your vehicle from your vehicle network carrier's account. To remove your vehicle from the account, contact your vehicle network carrier.

**Note:** The vehicle network carrier provides Vehicle Hotspot services, subject to your vehicle network carrier agreement, coverage and availability.

## CHANGING THE VEHICLE WI-FI HOTSPOT NAME OR PASSWORD

Tap the vehicle drawer on the top left of the screen.

1. Press **Vehicle Hotspot**.
2. Press Settings under the Vehicle Hotspot menu.
3. Press **Edit**.
4. Press **Change Network Name**.
5. Enter your required network name.
6. Press enter to save the network name.
7. Press **Change Password**.
8. Enter your required password.



# Vehicle Wi-Fi Hotspot

---

9. Press enter to save the password.

## Changing the Wi-Fi Hotspot Frequency

**Note:** *The vehicle hotspot frequency band is selectable depending upon your device capabilities. You will not be able to connect your device to the vehicle hotspot if it does not support the selected frequency band.*

Tap the vehicle drawer on the top left of the screen.

1. Press **Vehicle Hotspot**.
2. Press Settings under the Vehicle Hotspot menu.
3. Press **Edit**.
4. Select a frequency.

# Audio System

## AUDIO SYSTEM PRECAUTIONS



**WARNING:** Driving while distracted can result in loss of vehicle control, crash and injury. We strongly recommend that you use extreme caution when using any device that may take your focus off the road. Your primary responsibility is the safe operation of your vehicle. We recommend against the use of any hand-held device while driving and encourage the use of voice-operated systems when possible. Make sure you are aware of all applicable local laws that may affect the use of electronic devices while driving.

Listening to loud audio for long periods of time could damage your hearing.

## SWITCHING THE AUDIO UNIT ON AND OFF



Press the button on the volume control.

## SELECTING THE AUDIO SOURCE

1. Press your preferred audio source.

**Note:** Available audio sources are listed along the top of the radio screen.

## PLAYING OR PAUSING THE AUDIO SOURCE



Press to pause playback. Press again to resume playback.

**Note:** Not all sources can be paused.

## ADJUSTING THE VOLUME

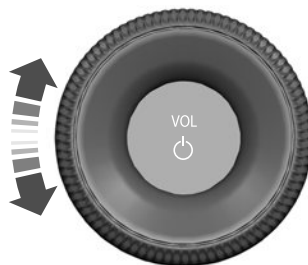

Turn to adjust the volume.

You can also press the mute button on the map screen.

Some vehicles may be able to adjust the volume using buttons on the steering wheel.

## SWITCHING SHUFFLE MODE ON AND OFF



Press the button on the touchscreen to switch shuffle mode on or off.

**Note:** Not all sources have shuffle mode.

## SWITCHING REPEAT MODE ON AND OFF



Press the button on the touchscreen to switch repeat mode on or off.

**Note:** Not all sources have repeat mode.

## SETTING A MEMORY PRESET

1. Select a station or channel.
2. Press and hold a memory preset button on the touchscreen.

# Audio System

**Note:** The audio mutes briefly while the system saves the preset and returns once it is stored.

**Note:** You can save presets from multiple sources to the memory preset bar.

## MUTING THE AUDIO



Press to mute the signal. Press again to restore the signal.

## ADJUSTING THE SOUND SETTINGS

### Balance and Fade (If Equipped)

1. Access the vehicle drawer on the touchscreen.
2. Press **SETTINGS**.
3. Press **Sound**.
4. Press **Balance / Fade**.
5. Press the arrows to adjust the settings.

### Tone Settings

1. Access the vehicle drawer on the touchscreen.
2. Press **SETTINGS**.
3. Press **Sound**.
4. Press **Tone Settings**.
5. Use the slider bar to adjust the settings.

### Speed Compensated Volume

1. Access the vehicle drawer on the touchscreen.
2. Press **SETTINGS**.
3. Press **Sound**.
4. Press **Speed Compensated Volume**.
5. Press a setting.

### Occupancy Mode (If Equipped)

1. Access the vehicle drawer on the touchscreen.
2. Press **SETTINGS**.
3. Press **Sound**.
4. Press **Occupancy Mode**.
5. Press a setting.

### Sound Mode (If Equipped)

1. Access the vehicle drawer on the touchscreen.
2. Press **SETTINGS**.
3. Press **Sound**.
4. Press **Sound Mode**.
5. Press a setting.

## SETTING THE CLOCK AND DATE

1. Access the vehicle drawer on the touchscreen.
2. Press **SETTINGS**.
3. Press **Clock**.
4. Set the time.

**Note:** The **AM** and **PM** options are not available if **24-hour mode** is on.

5. Press the arrows to adjust the settings.

### Switching Automatic Time Updates On and Off

1. Access the vehicle drawer on the touchscreen.
2. Press **SETTINGS**.
3. Press **Clock**.
4. Switch **Automatic time zone update** on or off.

# Audio System

## AM/FM RADIO

### AM/FM RADIO LIMITATIONS

The further you travel from an AM or FM station, the weaker the signal and the weaker the reception.

Hills, mountains, tall buildings, bridges, tunnels, freeway overpasses, parking garages, dense tree foliage and thunderstorms can interfere with the reception.

When you pass a ground-based broadcast repeating tower, a stronger signal may overtake a weaker one and result in the audio system muting.

### SELECTING A RADIO STATION

#### Manually Selecting a Radio Station



Press the button to activate the tuner, and then slide or tap your finger anywhere on the scale to select a radio station. Press - or + to fine tune.

#### Using Direct Tune

1. Press **Direct Tune** to open the number pad.
2. Enter the station you prefer.

**Note:** You can only enter a valid station for the audio source you are currently listening to.

#### Using Seek



Press either button. The system stops at the first station it finds in that direction.



#### Using the Station List

1. Press **Browse**.

**Note:** Available on FM radio only.

2. Select a station.

## DIGITAL RADIO

### WHAT IS DIGITAL RADIO

HD Radio™ technology is the digital evolution of analog AM/FM radio.

For additional information, visit [www.HDRadio.com](http://www.HDRadio.com).

HD Radio Technology is manufactured under license from iBiquity Digital Corporation and foreign patents. HD Radio and the HD and HD Radio logos are proprietary trademarks of DTS. The vehicle manufacturer and DTS are not responsible for the content sent using HD Radio technology. Content may be changed, added or deleted at any time at the station owner's discretion.

### HOW DOES DIGITAL RADIO WORK

Your system has a special receiver that allows it to receive digital broadcasts in addition to analog broadcasts.

HD1 signifies the main programming status and is available in both analog and digital broadcasts. Other multicast stations are only available digitally and could contain new or different content.

**Note:** When the system first receives an HD1 station, it plays the station in the analog version until it verifies the station is an HD Radio station. Then it shifts to the digital version.

**Note:** There is an audio mute delay when switching to an HD2 or HD3 station because the system has to reacquire and decode the digital signal.

# Audio System

## DIGITAL RADIO LIMITATIONS

If you are outside the reception area, the system could not work.

If you are on the fringe of the reception area, the station could mute due to weak signal strength.

**Note:** *If you are listening to HD1, the system changes back to the analog broadcast until the digital broadcast is available again. If you are listening to any other multicast channels, the station mutes and stays muted unless it is able to connect to the digital signal again.*

Depending on the station quality, you could hear a slight sound change when the station changes between analog and digital audio.

You cannot access a saved HD station if your vehicle is outside the station's reception area.

## SWITCHING DIGITAL RADIO RECEPTION ON AND OFF

1. Access the vehicle drawer on the touchscreen.
2. Press **SETTINGS**.
3. Press **Radio**.
4. Switch **HD Radio** on or off.

## DIGITAL RADIO INDICATORS

### HD Radio Indicator

The indicator appears when HD Radio is on and you tune to a station broadcasting HD Radio technology.



The color of the indicator changes to indicate the system status.

Gray indicates the system is acquiring a digital station.

Orange indicates digital audio is playing.

### Multicast Indicator

The multicast indicator appears if the current station is broadcasting multiple digital broadcasts. The highlighted numbers indicate additional digital channels available.

**Note:** *For stations that have more than one HD multicast, the HD indicator and radio text appears as a button. Press the button to cycle through all of the HD stations on that specific frequency.*

## SATELLITE RADIO

### WHAT IS SATELLITE RADIO

Your factory-installed SiriusXM radio system includes a limited subscription term, which begins on the date of sale or lease of your vehicle. See an authorized dealer for availability.

For additional information about extended subscription terms, visit [www.SiriusXM.com](http://www.SiriusXM.com) in the United States, [www.SiriusXM.ca](http://www.SiriusXM.ca) in Canada, or call SiriusXM at 1-888-539-7474.

# Audio System

**Note:** SiriusXM reserves the unrestricted right to change, rearrange, add or delete programming including canceling, moving or adding particular channels, and its prices, at any time, with or without notice to you. Neither SiriusXM and its affiliates nor Ford Motor Company and its affiliates will be liable to you or any third party for any such modification, suspension or termination.

## SATELLITE RADIO LIMITATIONS

For optimal reception performance, keep the antenna clear of snow and ice build-up and keep luggage and other material as far away from the antenna as possible. Placing luggage over the antenna may reduce performance. Factory-installed and aftermarket vehicle structures including, but not limited to, roof racks and soft top roofs in a partially open position could reduce reception performance.

Hills, mountains, tall buildings, bridges, tunnels, freeway overpasses, parking garages, dense tree foliage and thunderstorms can interfere with your reception.

When you pass a ground-based broadcast-repeating tower, a stronger signal may overtake a weaker one and could result in the audio system muting. Your display could show an error message to indicate the interference.

## LOCATING THE SATELLITE RADIO IDENTIFICATION NUMBER

1. Select SiriusXM as the audio source.
2. Tune to channel 0.

## SELECTING A CHANNEL

### Manually Selecting a Channel

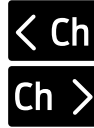

Press the button to find the previous or next available radio channel.

### Linear Tuner

The linear tuner is displayed when manually selecting a channel. You can swipe left or right on the linear tuner carousel to navigate through the channel list. Tap on a channel title to listen to it.

### Using Direct Tune

1. Press the channel up or down button to open the linear tuner screen.
2. Press **Direct Tune** to open the number pad.
3. Enter the channel you prefer.

### Using Browse

1. Press **Browse**.
2. Select a channel.

## SATELLITE RADIO SETTINGS

### Subscription

Your subscription status is displayed. You can subscribe or manage your subscription directly from the touchscreen.

### Listener Add/Switch

You can create up to five listener profiles per SiriusXM account. Each listener profile can be personalized with a name and profile image.

**Note:** Requires a trial or active subscription to use.

# Audio System

---

**Note:** A default profile is available when no listener profiles are created.

## SiriusXM Favorites

SiriusXM Favorites are shown for the active listener profile. While you are listening to SiriusXM, you can save favorites by:

- Tapping the currently tuned channel or show logo on the SiriusXM audio screen. A favorite icon appears next to the logo when it is saved as a favorite.
- Tuning to a channel or show you want to save as a favorite. Navigate to the SiriusXM Favorites screen and press the Add Current button. The currently tuned channel or show is saved as a favorite.
- Saving a radio preset. This saves the currently tuned SiriusXM channel or show as a favorite.

**Note:** Requires a trial or active subscription to use.

## Listening History

Listening history is a list of recently listened to SiriusXM content and is shown for the active listener profile. You can view, manage and reset the listening history using the controls on the touchscreen.

**Note:** Requires a trial or active subscription to use.

## Listener Settings

Listener settings apply to the active listener profile.

**Note:** Requires a trial or active subscription to use.

**Note:** A default profile is available when no listener profiles are created.

## Help and Support

You can contact SiriusXM Customer Care directly from SYNC and view information required to manage your SiriusXM account.

# Audio System

## AUDIO SYSTEM – TROUBLESHOOTING

### AUDIO SYSTEM – INFORMATION MESSAGES

#### Satellite Radio Troubleshooting

Error Message	Potential Effects	Recommended Action
Connectivity Disabled	Internet streaming and On Demand shows are unavailable and some SiriusXM features are disabled.	Internet connectivity is turned off. See <b>Connected Vehicle</b> (page 352).
No Internet	Audio system may mute. "Switch to Satellite" button may be displayed on the SiriusXM audio screen if the channel is also available via satellite.	SYNC will attempt to connect. See <b>Satellite Radio Limitations</b> (page 362). Switch to a satellite connection for the current channel if the option is available.
No Satellite Signal	Audio system may mute. "Switch to Internet" button may be displayed on the SiriusXM audio screen if the channel is also available via streaming.	Antenna may be obstructed or satellite reception is weak in your location. See <b>Satellite Radio Limitations</b> (page 362). Switch to an internet connection for the current channel if the option is available.
Slow Network Connection	Audio system may mute while audio attempts to load.	Allow some time for audio to load or tune to a different channel.
Channel Unavailable	Audio system may mute. Radio may tune to a different channel.	A temporary update may be in progress. Allow some time before retrying to tune to the channel. If issue persists, the channel may no longer be available.
Episode Unavailable	Audio system may mute. Radio may tune to a different channel.	A temporary update may be in progress. Allow some time before retrying to play the episode. If issue persists, the episode may no longer be available.



# Audio System

Something went wrong	Audio system may mute. Radio may tune to a different channel.	Retry action after some time or tune to a different channel.
Subscribe to Listen	Cannot listen to selected content. Content may appear grayed out and some features may be disabled.	<p>Your subscription has expired or you have not yet subscribed for access to the listed content. Navigate to Subscription under the Satellite Radio Settings menu. If you have an active subscription which includes the listed channel or content and you see this error, you may need to refresh your radio. To refresh your SiriusXM radio, visit <a href="http://www.siriusxm.com/refresh">www.siriusxm.com/refresh</a> in the US, or <a href="http://www.siriusxm.ca/refresh">www.siriusxm.ca/refresh</a> in Canada.</p> <p>You may need to provide your SiriusXM Radio identification number. See <b>Locating the Satellite Radio Identification Number</b> (page 362).</p>

## Audio System

Upgrade to Listen	Cannot listen to selected content. Content may appear grayed out and some features may be disabled.	Your subscription does not include access to the listed content. You may need to upgrade your subscription. Navigate to Subscription under the Satellite Radio Settings menu. If you have an active subscription which includes the listed channel or content and you see this error, you may need to refresh your radio. To refresh your SiriusXM radio, visit <a href="http://www.siriusxm.com/refresh">www.siriusxm.com/refresh</a> in the US, or <a href="http://www.siri-usxm.ca/refresh">www.siri-usxm.ca/refresh</a> in Canada. You may need to provide your SiriusXM Radio identification number. See <b>Locating the Satellite Radio Identification Number</b> (page 362).
Location Restricted Content	Audio may mute. “Not available in your location” or “Unable to determine your location” may be displayed.	Content is not available in your location or SiriusXM is unable to determine your location. Tuning to a different channel may resolve the issue.
Channel Blocked	Audio may mute. Radio may tune to a different channel.	The Block Explicit Content filter is turned on. Navigate to Listener Settings under the Satellite Radio Settings menu to access the Block Explicit Content filter. Navigate to Listener Settings. See <b>Satellite Radio Settings</b> (page 362).
Antenna Problem or Hardware Problem	Audio may mute. Access to SiriusXM features may be unavailable.	If issue persists, you may need to visit an authorized dealer for service.

# Audio System

---

SiriusXM Updating...	Audio may mute.	Allow SiriusXM some time to complete updating.
Loading...	Audio may mute. Content may be temporarily unavailable while loading.	No action necessary. If loading time is longer than usual, See <b>Satellite Radio Limitations</b> (page 362).
SiriusXM Loading...	Audio may mute. Content and controls may be temporarily unavailable.	No action necessary. Allow SiriusXM some time to finish loading.

# Center Display Overview

## CENTER DISPLAY PRECAUTIONS



**WARNING:** Driving while distracted can result in loss of vehicle control, crash and injury. We strongly recommend that you use extreme caution when using any device that may take your focus off the road. Your primary responsibility is the safe operation of your vehicle. We recommend against the use of any hand-held device while driving and encourage the use of voice-operated systems when possible. Make sure you are aware of all applicable local laws that may affect the use of electronic devices while driving.

## CENTER DISPLAY LIMITATIONS

### Speed-restricted Features

For your safety, some features are not available while the vehicle is in motion at or above 6 mph (10 km/h). Settings that are not critical while driving your vehicle will be shown as restricted on your display. See below for examples:

- System Updates.
- Personal Profiles Setup.
- Valet Mode Setup.
- Driver Assistance Settings.

### Vehicle Settings

- MyKey Setup.
- Door Keypad Code Setup.
- Backup Start Passcode Setup.

These restricted features will become available when your vehicle is no longer in motion.

## STATUS BAR



The bar is on top of the display and indicates the status of your vehicle's features. It also contains the Vehicle and Application drawers. See **Accessing Feature Drawers** (page 370).

### Status Area

The status area is on the right side of the status bar and provides information about vehicle features.

### Audio System



Audio system muted.

# Center Display Overview

## Connected Device



Cell phone microphone muted.



Phone call in progress.



Media player connected.



Cell phone network signal strength.



Cell phone roaming.



Text message received.



Unread email message.



Automatic crash notification system off.



Cell phone battery status.

## Vehicle Data



Wi-Fi available.



Wi-Fi connected.



Vehicle data sharing on.



Vehicle data sharing off.



Vehicle location sharing on.



Vehicle data and vehicle location sharing on.

## Wireless Accessory Charger



Wireless accessory charger active.

## Action Area

The action area is on the left side of the display and contains status updates that require your action. Tap the icons in the action area to learn more about them.

## Vehicle System Update



Vehicle system update available.



Vehicle system update requires schedule.



Vehicle system update requires consent.



Vehicle system update requires Wi-Fi.



Vehicle system update schedule reminder.



Vehicle system update not successful.



Vehicle system update successful.

# Center Display Overview

---

## ACCESSING FEATURE DRAWERS

### Application Drawer

 Press the button to open and close the application drawer. It contains system and connected device applications.

**Note:** *The icon may change depending on your personalization settings.*

### Vehicle Drawer



Press the button to open and close the vehicle drawer. It contains vehicle feature settings.

## CENTER DISPLAY SETTINGS

### Valet Mode

Valet mode allows you to lock the system. No information is accessible until the system is unlocked with the correct PIN.

When you select valet mode, a pop up appears informing you that a four digit code must be entered to enable and disable valet mode. You can use any PIN you choose, but you must use the same PIN to disable valet mode. The system asks you to input the code.

**Note:** *If the system is locked and you cannot remember the PIN, please contact the customer relationship center.*

To enable valet mode, enter your chosen PIN. The system then asks to confirm your PIN by reentering it. The system then locks.

To unlock the system, enter the same PIN number. The system reconnects to your phone and all of your options are available again.

# Voice Interaction

## WHAT IS VOICE INTERACTION

Voice Interaction allows you to control vehicle features using conversational requests.

## SETTING THE WAKE WORD

1. Access the feature drawer on the touchscreen.
2. Press Settings.
3. Press the Voice button.
4. Select a wake word.

## BEGINNING A VOICE INTERACTION

Say the selected wake word.



Press the voice interaction button on the steering wheel.

## VOICE INTERACTION EXAMPLES

**Note:** You may need to enable your vehicle's modem to use certain voice commands. See **Enabling and Disabling the Modem** (page 352).

### General Examples

Command	Result
Start Over.	The system resets the current voice interaction.
Cancel.	The system ends the current voice interaction.
Next Page.	The system goes to the next page.
Previous Page.	The system goes to the previous page.
Help.	The system displays a list of available commands you can use on the current screen.

### Entertainment Examples

Command	Result
Play The Beatles.	The system plays the selected music.
Show music by The Beatles.	The system shows the selected music.
Tune to FM 101.9.	The system tunes the radio to 101.9 FM.
Set the station to Sirius Channel 2.	The system tunes the radio to Sirius Channel 2.

# Voice Interaction

## Climate Examples

Command	Result
Set the temperature to low.	The system sets the temperature to the minimum.
Set the temperature to 72°F (22°C).	The system sets the temperature to 72°F (22°C).

## Phone Examples

Command	Result
Call Henry.	The system calls Henry using your connected device.
Dial (phone number).	The system dials the selected phone number.
Send a text message to Henry.	The system begins a dictated text message.
Read my message from Henry.	The system reads you the most recent message from Henry.

## Apps Examples

Command	Result
Mobile Apps.	The system prompts you to say the name of an app to start it on the system.
List Mobile Apps.	The system will list all of the currently available Mobile Apps.
Find Mobile Apps	The system will search and connect to compatible app running on your mobile device.

## Navigation Examples

Command	Result
Drive to 125 Main Street, New York.	The system begins guided navigation to the address.
Where is ___	The system searches for the requested point of interest.
Show me directions to Oakwood Boulevard and Pelham Road.	The system shows directions to the selected intersection.
Cancel route.	The system ends guided navigation to the destination.

## Ford Assistant Examples

**Note:** When you are not driving, additional commands are available by using popular chat applications. Use FordPass to setup a conversation with your Ford assistant.



# Voice Interaction

## Maintenance and Roadside Assistance Examples

Command	Result
Call roadside assistance.	Your vehicle calls the roadside assistance phone number.

## Vehicle Information Examples

Command	Result
How does cruise control work?	Information about the feature appears on the center display or FordPass app.
What does the warning light mean?	Information about the warning light appears on the center display or FordPass app.
Am I affected by any recalls?	Information about open recalls appears on the center display or FordPass app.

## Charging Examples

Command	Result
When is my next scheduled charge?	Information about the time and location of the next charge appears on the center display or FordPass app.
Show me the charging schedule.	Shows the charging display in the vehicle.
Change my charge schedule.	Shows the charging display in the vehicle.

# Phone

## PHONE PRECAUTIONS



**WARNING:** Driving while distracted can result in loss of vehicle control, crash and injury. We strongly recommend that you use extreme caution when using any device that may take your focus off the road. Your primary responsibility is the safe operation of your vehicle. We recommend against the use of any hand-held device while driving and encourage the use of voice-operated systems when possible. Make sure you are aware of all applicable local laws that may affect the use of electronic devices while driving.

## CONNECTING YOUR PHONE

Connecting your phone stores contact and call data on your vehicle. This data is used to provide intelligent suggestions. You can switch this off in the touchscreen settings menu. See **Personal Profile Settings** (page 383).

**Note:** *Unpairing your phone will remove the contact and call data from your vehicle and stop intelligent call suggestions.*

Go to the settings menu on your device and switch **Bluetooth®** on.



Select the phone option in the feature drawer.

1. Select **Add Phone**.
2. Follow the instructions on the screen to pair your device.

## PHONE MENU



Press to view your favorite contacts.



Press to view your recent calls.



Press to view your contacts



Press to use the phone keypad.



Press to display recent text messages.



Press to view recent emails.

Press the down arrow to view additional items for a connected device.



Press to begin a voice interaction.



Press to switch to a different connected device.



Press to mute notifications.



Press to access phone settings.

# Phone

## MAKING AND RECEIVING A PHONE CALL

### Making Calls

**To call a number in your contacts, select:**

Menu Item	Action and Description
Contacts	You can then select the name of the contact you want to call. Any numbers stored for that contact display along with any stored contact photos. You can then select the number that you want to call. The system begins the call.

**To call a number from your recent calls, select:**

Menu Item	Action and Description
Recent Call List	You can then select an entry that you want to call. The system begins the call.

**To call a number from your favorites, select:**

Menu Item	Action and Description
Favorites	You can then select an entry that you want to call. The system begins the call.

**To call a number that is not stored in your phone, select:**

Menu Item	Action and Description
Phone Keypad	Select the digits of the number you wish to call.
Call	The system begins the call.

Pressing the backspace button deletes the last digit you typed.

### Receiving Calls

During an incoming call, an audible tone sounds. Caller information appears in the display if it is available.

**To accept the call, select:**

Menu Item
Accept

**Note:** You can also accept the call by pressing the phone button on the steering wheel.

**To reject the call, select:**

Menu Item
Reject

Ignore the call by doing nothing. The system logs it as a missed call.

### During a Phone Call

During a phone call, the contacts name and number display on the screen along with the call duration.

The phone status items are also visible:

- Signal Strength.
- Battery.

You can select any of the following during an active phone call:

# Phone

Item	
End Call	Immediately end a phone call. You can also press the button on the steering wheel.
Keypad	Press this to access the phone keypad.

Item	
Mute	You can switch the microphone off so the caller does not hear you.
Privacy	Transfer the call to the cell phone or back to the touch-screen.

## SENDING AND RECEIVING A TEXT MESSAGE

Menu Item	Description
Hear It	Hear the text message.
View	View the text message.
Call	Call the sender.
Reply	Reply to the text message with a standard text message.

# Phone

---

## **SWITCHING TEXT MESSAGE NOTIFICATION ON AND OFF**

### **IOS**

1. Go to the settings menu on your cell phone.
2. Select **Bluetooth®**.
3. Select the information icon to the right of your vehicle.
4. Switch text message notification on or off.

### **Android**

1. Go to the settings menu on your cell phone.
2. Select **Bluetooth®**.
3. Select the profiles option.
4. Select the phone profile.
5. Switch text message notification on or off.

## CONNECTING A BLUETOOTH® DEVICE



Press the button on the status bar to open the vehicle drawer.

1. Make sure **Bluetooth®** is enabled on your device.
2. Press **Connectivity**.
3. Press **Bluetooth**.
4. Switch Bluetooth on.
5. Press **Add a Bluetooth Device**.

**Note:** A prompt alerts you to search for your vehicle on your device.

6. Select your vehicle on your device.

**Note:** A number appears on your device and on the touchscreen.

7. Confirm that the PIN (personal identification number) on your device matches the number on the touchscreen.

**Note:** The touchscreen indicates that you have successfully paired your device.

The **Bluetooth®** word mark and logos are registered trademarks owned by **Bluetooth SIG, Inc.** and any use of such marks by Ford Motor Company is under license. Other trademarks and trade names are those of their respective owners.

## PLAYING MEDIA USING BLUETOOTH®



**WARNING:** Driving while distracted can result in loss of vehicle control, crash and injury. We strongly recommend that you use extreme caution when using any device that may take your focus off the road. Your primary responsibility is the safe operation of your vehicle. We

recommend against the use of any hand-held device while driving and encourage the use of voice-operated systems when possible. Make sure you are aware of all applicable local laws that may affect the use of electronic devices while driving.

Connect your device.



Press the button on the status bar to open the application drawer.



Press the **Bluetooth®** option.



Press to play a track. Press again to pause the track.



Press to skip to the next track. Press and hold to fast forward through the track.



Press once to return to the beginning of a track. Repeatedly press to return to previous tracks.

Press and hold to fast rewind through the track.

## Browsing your Media Library

When a compatible mobile device is connected to the vehicle, your media library will be accessible through the touchscreen. From the touchscreen, you can browse through songs, albums, artists, and playlists on your mobile device.

**Note:** This feature is dependent on the connected mobile device and the media application used.

**Note:** Browse feature functionality may be limited while driving.

# Apps

## APP PRECAUTIONS

**WARNING:** Driving while distracted can result in loss of vehicle control, crash and injury. We strongly recommend that you use extreme caution when using any device that may take your focus off the road. Your primary responsibility is the safe operation of your vehicle. We recommend against the use of any hand-held device while driving and encourage the use of voice-operated systems when possible. Make sure you are aware of all applicable local laws that may affect the use of electronic devices while driving.

## APP REQUIREMENTS

When you start an app through the system for the first time, you could be asked to grant certain permissions. You can review and change the permissions that you have granted at any time when your vehicle is not moving. We recommend that you check your data plan before using your apps through the system. Using them could result in additional charges. We also recommend that you check the app provider's terms and conditions and privacy policy before using their app. Make sure that you have an active account for apps that you want to use through the system. Some apps will work with no setup. Others require you to configure some personal settings before you can use them.

## ACCESSING APPS

- ● ● Press the button to open the application drawer.

## Application Area



This is the main app area where apps are launched and you can utilize the full functionality of the chosen app.

# Apps

## Card Area



Here you can see recently used applications with limited content. When you select one of these cards, the app will display in the application area with full functionality.

## ENABLING APPS ON AN IOS DEVICE

1. Follow the instructions to pair and connect your device via **Bluetooth**® or with a USB cable.

**Note:** Some apps may run through CarPlay if it is enabled.

2. Start a compatible app on your device.

**Note:** The app must be open on your device to use it through the touchscreen.

3. Access the system applications.
4. Select the app you wish to use on the touchscreen.

## ENABLING APPS ON AN ANDROID DEVICE

1. Pair your device to **Bluetooth**®.

**Note:** Some apps may run through Android Auto if it is enabled.

2. Start a compatible app on your device.

**Note:** The app must be open on your device to use it through the touchscreen.

3. Access the system applications.
4. Select the app you wish to use on the touchscreen.

## SWITCHING APPLE CARPLAY ON AND OFF

1. Pair your device.
2. Select the vehicle drawer on the status bar.
3. Select the phone list.
4. Select your device.
5. Select the connect option.
6. Switch Apple Car Play on or off.

## SWITCHING ANDROID AUTO ON AND OFF

1. Pair your device.
2. Select the vehicle drawer on the status bar.
3. Select the phone list.
4. Select your device.



# Apps

---

5. Select the connect option.
6. Switch Android Auto on or off.

# Personal Profiles

---

## HOW DO PERSONAL PROFILES WORK

This feature allows you to create multiple personal profiles enabling users to personalize vehicle's settings such as seats and mirrors, as well as non-positional settings like radio, navigation, driver assist system settings. Positional settings are saved by holding a memory seat button. Non-positional settings are saved you change a setting while a profile is active. You can create one profile for each preset memory seat button along with a guest profile.

### Recalling and Changing a Profile

You can recall a profile using the touchscreen or the preset button you selected when you created your profile. You can also link a remote control and a mobile device to your profile, which are used to recall it.

## ENABLING OR DISABLING PERSONAL PROFILES

1. Access the application drawer on the touchscreen.
2. Press Settings.
3. Press the Profiles button.
4. Switch Enable Profiles on or off.

When you switch on the Personal Profiles feature:

- Unlocking a door with a remote control or mobile device that is not linked to a driver profile does not change active profile, but remains in the last known profile. It does not change the positional settings.
- Pressing a memory seat button that is not linked to a driver profile or saved to a preset setting does not change active profile, but remains in the last known profile. It does not change the positional settings.
- Pressing a memory seat button that is not linked to a driver profile but is saved to a preset setting does not change active profile, but remains in the last known profile. It recalls the positional settings that you saved to that memory seat button.

When you switch off a Personal Profiles feature:

- Unlocking a door with a remote control or mobile device does not recall any non-positional settings but still recalls positional settings from the driver profile which the remote control or mobile device is linked to.
- Pressing a memory seat button that is not linked to a driver profile or saved to a preset setting recalls non-positional settings from the guest profile. It does not change the positional settings.
- Pressing a memory seat button that is linked to a driver profile or has saved to a preset setting recalls non-positional settings from the guest profile. It recalls the positional settings that you saved to that memory seat button.

# Personal Profiles

---

## CREATING A PERSONAL PROFILE

Use the touchscreen to create a personal profile.

1. Switch the vehicle on and leave the vehicle in park (P).
2. Select the Personal Profiles button under Settings.
3. Follow the instructions on the display.

## LINKING OR UNLINKING A PERSONAL PROFILE TO A REMOTE CONTROL

You can save preset memory positions for up to three remote controls by assigning a remote control to a personal profile using the touchscreen.

Use the touchscreen to link a remote control to a personal profile.

1. Switch the vehicle on and leave the vehicle in park (P).
2. Select the Personal Profiles button under Settings.
3. Touch the arrow for the profile you wish to link to a remote control.
4. Select remote control.
5. Follow the instructions on the display.

**Note:** *If more than one linked remote control is in range, the memory function moves to the settings of the first key to initiate a memory recall.*

**Note:** *The guest profile consists of existing settings when there is no driver profile created. After you create a driver profile, the guest profile serves as an additional driver profile.*

**Note:** *You cannot link a remote control to a guest profile.*

## LINKING OR UNLINKING A PERSONAL PROFILE TO A DEVICE

Use the touchscreen to link a mobile device to a personal profile.

1. Switch the vehicle on and leave the vehicle in park (P).
2. Select the Personal Profiles button under Settings.
3. Touch the arrow for the profile you wish to link to a mobile device.
4. Select mobile device.
5. Follow the instructions on the display.

**Note:** *To successfully link a mobile device, the mobile device must be in your vehicle, and must have previously been setup as a remote control for your vehicle.*

**Note:** *The guest profile consists of existing settings when there is no driver profile created. After you create a driver profile, the guest profile serves as an additional driver profile.*

**Note:** *You cannot link a personalized name to a guest profile.*

## PERSONAL PROFILE SETTINGS

### Switching Intelligent Suggestions On and Off

Based on your usage patterns stored on your vehicle, Intelligent Suggestions is a feature that allows your vehicle to assist in your daily drive by providing phone calls, radio stations, navigation destinations, and charging stations as suggestions. These suggestions appear in the form of actionable buttons in the application drawer that can be pressed to complete that action.

# Personal Profiles

---



Press the button to open the vehicle drawer.

1. Press **General**.
2. Switch **Intelligent Suggestions** on or off.

# Navigation

---

## ACCESSING NAVIGATION

1. Access the application drawer on the touchscreen.
2. Press the navigation button.

**Note:** *As the driver, be aware of all local traffic regulations and road attributes, and operate your vehicle in a safe and legal manner.*

## NAVIGATION MAP UPDATES

To update your Map data over Wi-Fi, your vehicle must be connected to a Wi-Fi access point. For USB updates and other details, contact dealers at 1-866-462-8837 in the United States and Canada, or 01-800-557-5539 in Mexico.

**Note:** *If you find map data errors, you may report them by going to [www.here.com/mapcreator](http://www.here.com/mapcreator).*

## ADJUSTING THE MAP

### ZOOMING THE MAP IN AND OUT

You can use pinch gestures to zoom in and out. Place two fingers on the screen and move them apart to zoom in. Place two fingers on the screen and bring them together to zoom out.

### CHANGING THE FORMAT OF THE MAP



Press the map format button on the left side of the map screen to toggle between the available formats.

## LIVE TRAFFIC

### WHAT IS LIVE TRAFFIC

You can observe real-time road congestion when live traffic is on.

### SWITCHING LIVE TRAFFIC ON AND OFF

1. Press the tools button on the map screen.
2. Press Navigation Settings.
3. Press the Traffic button.
4. Switch Traffic on or off.

## SETTING A DESTINATION

### SETTING A DESTINATION USING THE TEXT ENTRY SCREEN

1. Press the search bar at the top of the screen.
2. Enter your destination using the keyboard.
3. Select a destination from the list.
4. Press Go! to begin navigation.

### SETTING A DESTINATION USING THE MAP SCREEN

Press on the map to trigger the roaming and viewing screen. Press on the map again to place a pin at that location. Information about the location of the pin appears on the screen. Press the Go! button to begin navigation to the pin.

# Navigation

---

## SETTING A DESTINATION USING A PREDICTIVE DESTINATION

### Switching Predictive Destinations On and Off

You can switch Destination Suggestions on and off under the User Data section in the navigation settings menu.

### Setting a Destination

Access the feature bar using the touchscreen and select the predicted destination at the top of the screen. You can access additional predictive destinations by pressing the search bar on the map screen and then pressing the myTrends button.

## SETTING A DESTINATION USING A RECENT DESTINATION

1. Press the search bar on the map screen.
2. Press Recents.
3. Select a destination from the list.

## SETTING A DESTINATION USING A SAVED DESTINATION

1. Press the search bar at the top of the screen.
2. Press Saved Places.
3. Select a saved destination.

**Note:** Press the star icon next when viewing location details to save the location.

## SETTING A DESTINATION USING A POINT OF INTEREST

Press on a point of interest icon on the map. Information about the location of the point of interest appears on the screen. Press the Go! button to begin navigation to the point of interest.

## WAYPOINTS

### ADDING A WAYPOINT

1. Begin navigation to a destination.
2. Search for your waypoint using the search bar.
3. Press Go!
4. Press Add to add the waypoint to your trip.

### EDITING WAYPOINTS

1. Press the search bar on the map screen.
2. Press myTrips.
3. Press Current Trip.
4. Use the menu to add destinations, remove destinations, or rearrange destinations.

## ROUTE GUIDANCE

### ADJUSTING THE GUIDANCE PROMPT VOLUME

Turn the volume control when a guidance prompt plays to adjust the volume.

### REPEATING AN INSTRUCTION

Press the turn indicator to hear the last voice instruction.

### CANCELING ROUTE GUIDANCE



Press the button to cancel route guidance to the selected location.

# Vehicle System Updates

## UPDATING THE VEHICLE SYSTEMS WIRELESSLY



Over the air system updates allow you to update your vehicle system software wirelessly. To make sure you receive all updates, set a recurring schedule and connect to Wi-Fi. Updates may take longer if not connected to Wi-Fi, or may not download at all. See **Connected Vehicle** (page 352).

**Note:** *Additional over the air update icons may appear in the status bar. See **Status Bar** (page 368).*

### Over the Air System Update Requirements

Before updating, reference this list to make sure your vehicle is ready to be updated. If these requirements are not met during a scheduled update, the update will be canceled and you can reschedule.

- Your vehicle is not running.
- Your vehicle is stopped.
- Your vehicle is parked.
- The hazard indicators are switched off.
- The alarm is not sounding.
- The doors are closed.
- The parking lights are switched off.
- You are not pressing the brake pedal.
- An emergency call is not in progress.
- Your vehicle is not in limp mode.

### Scheduling an Over the Air System Update

Make sure Vehicle Connectivity and Automatic Updates are switched on.

#### Using the Settings Menu

1. Access the vehicle drawer on the touchscreen.
2. Press **SETTINGS**.

3. Press **Software Update**.
4. Press **Schedule Updates**.
5. Use the controls to set the time and day of the update.
6. Save the schedule.

**Note:** *You can set the updates to occur every seven days.*

#### Using the Status Bar Icon



When an update is available, tap the notification icon and follow the prompts on the screen.

### Applying an Over the Air System Update

You can schedule a convenient time for the update to complete. During scheduled updates you may not be able to use your vehicle.

**Note:** *Updates may take up to 30 minutes to complete.*

You can see the progress of the update on the touchscreen. An update cannot be canceled once it has been started.

During an update you will not be able to drive your vehicle, start the vehicle, use remote controls to lock and unlock the vehicle. The alarm, central locks, and door tones are disabled. The electronic door lock will not function during an update. You can open the doors using the mechanical latch if child locks are not on. Pull the handle until it stops to use the mechanical latch.

**Note:** *Double locking is switched off and central locking is switched on during and after an update.*

**Note:** *If your vehicle is plugged in, charging will stop during an update and resume when the update is complete.*

# Vehicle System Updates

---

## Viewing Update Details

If an update is successful, the touchscreen will provide additional details about the update. You can also access this information under the System Update tile.

If an update is not successful, follow the prompt that appears on the touchscreen.

## PERFORMING A MASTER RESET



Press the button to open the vehicle drawer.

1. Press **Reset**.
2. Press **Master Reset**.
3. Follow the prompts on the screen to complete the reset.



# Accessories

For a complete listing of the accessories that are available for your vehicle, please contact your authorized dealer or visit the online store web site:

<b>Web Address (United States)</b>
<a href="http://www.Accessories.Ford.com">www.Accessories.Ford.com</a>

<b>Web Address (Canada)</b>
<a href="http://www.Accessories.Ford.ca">www.Accessories.Ford.ca</a>

We will repair or replace any properly authorized dealer-installed Ford Original Accessory found to be defective in factory-supplied materials or workmanship during the warranty period, as well as any component damaged by the defective accessories.

We will warrant your Ford Original Accessory through the warranty that provides the greatest benefit:

- 24 months, unlimited mileage.
- The remainder of your new vehicle limited warranty.

Contact an authorized dealer for details and a copy of the warranty.

Ford Licensed Accessories are the accessory manufacturer's designs. The manufacturer develops and therefore warrants Ford Licensed Accessories, and does not design or test these accessories to Ford Motor Company engineering requirements. Contact an authorized Ford dealer for the manufacturer's limited warranty details, and request a copy of the Ford Licensed Accessories product limited warranty from the accessory manufacturer.

For maximum vehicle performance, keep the following information in mind when adding accessories or equipment to your vehicle:

- When adding accessories, equipment, passengers and luggage to your vehicle, do not exceed the total weight capacity of the vehicle or of the front or rear axle (GVWR or GAWR as indicated on the Safety Compliance Certification label). Ask an authorized dealer for specific weight information.
- The Federal Communications Commission (FCC) and Canadian Radio Telecommunications Commission (CRTC) regulate the use of mobile communications systems that are equipped with radio transmitters, for example two-way radios, telephones and theft alarms. Any such equipment installed in your vehicle should comply with Federal Communications Commission (FCC) and Canadian Radio Telecommunications Commission (CRTC) regulations and should be installed only by an authorized dealer.
- An authorized dealer needs to install mobile communications systems. Improper installation may harm the operation of your vehicle, particularly if the manufacturer did not design the mobile communication system specifically for automotive use.
- If you or an authorized Ford dealer add any non-Ford electrical or electronic accessories or components to your vehicle, you may adversely affect battery performance and durability. In addition, you may also adversely affect the performance of other electrical systems in the vehicle.

# Ford Protect

---

## WHAT IS FORD PROTECT

Protect yourself from the rising cost of vehicle repairs with a Ford Protect extended service plan.

### **Ford Protect Extended Service Plans - United States Only**

Ford Protect extended service plans mean peace of mind. Extended service plans are backed by Ford Motor Company, and provide more protection beyond the New Vehicle Limited Warranty coverage. When you visit your Ford Dealer, insist on the Ford Protect extended service plan.

### **Ford Protect Can Quickly Pay for Itself**

One trip to the service center could easily exceed the price of your Ford Protect extended service plan. With the Ford Protect extended service plan, you minimize your risk for unexpected repair bills and rising repair costs.

### **Up to 1,000+ Covered Vehicle Components**

There are four mechanical Ford Protect extended service plans with different levels of coverage. Ask your authorized dealer for details.

1. PremiumCARE - Our most comprehensive coverage. With over 1,000 covered components, this plan is so complete it is probably easier to list what is not covered.
2. ExtraCARE - Covers 113 components, and includes many high-tech items.
3. BaseCARE - Covers 84 components.
4. PowertrainCARE - Covers 29 critical components.

Ford Protect extended service plans are honored by all authorized Ford dealers in the United States, Canada and Mexico.

That means you get:

- Reliable, quality service at any Ford or Lincoln dealership.
- Repairs performed by factory trained technicians, using genuine parts.

### **Rental Car Reimbursement**

#### ***First Day Rental Benefit***

If you bring your car into your dealer for service, we will give you a rental vehicle to use for the day.

#### ***Extended Rental Benefits***

If your vehicle is kept overnight for covered repairs, you are eligible for rental car coverage, warranty repairs, and field service actions.

### **Roadside Assistance**

Exclusive 24/7 roadside assistance, including:

- Towing, flat-tire change and battery jump starts.
- Lock-out assistance.
- Travel expense reimbursement for lodging, meals and rental car.
- Assistance for taxi, shuttle, rental car coverage or other transportation.

### **Transferable Coverage**

If you sell your vehicle before your Ford Protect extended service plan coverage expires, you can transfer any remaining coverage to the new owner. This should give you and your potential buyer peace of mind.

# Ford Protect

---

## Less Cost to Properly Maintain Your Vehicle

The Ford Protect extended service plan also offers a Premium Maintenance Plan that covers all scheduled maintenance, and selected wear items. The coverage is prepaid, so you never have to worry about the cost of your vehicle's maintenance.

Covered maintenance includes:

- Windshield wiper blades.
- The clutch disc (if equipped).
- Brake pads and linings.
- Shock absorbers.
- Struts.
- Cabin air filter replacement every 20,000 mi (32,000 km).

## Interest Free Finance Options

Just a 5% down payment provides you with an affordable, no interest, no fee payment program allowing you all the security and benefits Ford Protect extended service plan has to offer while paying over time. You are pre-approved with no credit check or hassles. To learn more, call our Ford Protect extended service plan specialists at 800-367-3377.

Ford Protect Extended Service Plan  
P.O. Box 321067  
Detroit, MI 48232

## Ford Protect Extended Service Plan (Canada Only)

You can get more protection for your vehicle by purchasing a Ford Protect extended service plan. Ford Protect extended service plan is the only service contract backed by Ford Motor Company of Canada, Limited. Depending on the plan you purchase, Ford Protect extended service plan provides benefits such as:

- Rental reimbursement.
- Coverage for certain maintenance and wear items.
- Protection against repair costs after your New Vehicle Limited Warranty Coverage expires.
- Roadside Assistance benefits.

There are several Ford Protect extended service plans available in various time, distance and deductible combinations. Each plan is tailored to fit your own driving needs, including reimbursement for towing and rental. When you purchase Ford Protect extended service plan, you receive added peace-of-mind protection throughout Canada, the United States and Mexico, provided by a network of participating authorized Ford Motor Company dealers.

**Note:** *Repairs performed outside of Canada and the United States are not eligible for Ford Protect extended service plan coverage.*

This information is subject to change. Visit your local Ford of Canada dealer or [www.ford.ca](http://www.ford.ca) to find the Ford Protect extended service plan that is right for you.

# Scheduled Maintenance

---

## GENERAL MAINTENANCE INFORMATION

### Why Maintain Your Vehicle?

Carefully following the maintenance schedule helps protect against major repair expenses resulting from neglect or inadequate maintenance and may help to increase the value of your vehicle when you sell or trade it. Keep all receipts for completed maintenance with your vehicle.

It is important that you have your vehicle serviced at the proper times. These intervals serve two purposes; first is to maintain the reliability of your vehicle and the second is to keep the cost of owning your vehicle down.

It is your responsibility to have all scheduled maintenance performed and to make sure that the materials used meet the specifications identified in this owner's manual.

Failure to perform scheduled maintenance and regularly inspect your vehicle may result in vehicle damage not covered by the vehicle Warranty.

### Why Maintain Your Vehicle at Your Dealership?

#### Our Genuine Replacement Parts

Dealerships stock our parts and our authorized branded re-manufactured replacement parts. These parts meet or exceed our specifications. Parts installed at your dealership carry a nationwide 24-month or unlimited mile (kilometer) parts and labor limited warranty.

If you do not use our authorized parts they may not meet our specifications.

### Protecting Your Investment

Maintenance is an investment that pays dividends in the form of improved reliability, durability and resale value. To maintain the proper performance of your vehicle, make sure you have scheduled maintenance performed at the designated intervals.

It is important to rely upon your dealership to properly diagnose and repair your vehicle.

We have recommended maintenance intervals for various parts and component systems based upon engineering testing. We rely upon this testing to determine the most appropriate mileage for replacement of fluids to protect your vehicle at the lowest overall cost to you and recommends against maintenance schedules that deviate from the scheduled maintenance information.

We strongly recommend the use of only our genuine manufactured or our authorized re-manufactured replacement parts engineered for your vehicle.

#### Additives and Chemicals

We do not recommend using chemicals or additives not approved by us as part of your vehicle's normal maintenance. Please consult your warranty information.

#### Fluids and Flushing

In many cases, fluid discoloration is a normal operating characteristic and, by itself, does not necessarily indicate a concern or that the fluid needs to be changed. However, a qualified expert, such as the factory-trained technicians at your dealership, should inspect discolored fluids that also show signs of overheating or foreign material contamination immediately.

# Scheduled Maintenance

Make sure to change your vehicle's fluids at the specified intervals or in conjunction with a repair. Flushing is a viable way to change fluid for many vehicle sub-systems during scheduled maintenance. It is critical that systems are flushed only with new fluid that is the same as that required to

fill and operate the system or using our approved flushing chemical.

## Owner Checks and Services

Make sure you perform the following basic maintenance checks and inspections every month or at six-month intervals.

<b>Check Every Month</b>
Function of all interior and exterior lights.
Tires (including spare) for wear and proper pressure.
Windshield washer fluid level.

<b>Check Every Six Months</b>
12V Battery connections. Clean if necessary.
Body and door drain holes for obstructions. Clean if necessary.
Cooling system fluid level and coolant strength.
Door weatherstrips for wear. Lubricate if necessary.
Hinges, latches and outside locks for proper operation. Lubricate if necessary.
Parking brake for proper operation.
Safety belts and seat latches for wear and function.
Safety warning lamps (brake, ABS, airbag and safety belt) for operation.
Washer spray and wiper operation. Clean or replace blades as necessary.

## Multi-point Inspection

In order to keep your vehicle running right, it is important to have the systems on your vehicle checked regularly. This can help identify potential issues and prevent major problems. We recommend having the following multi-point inspection performed at every scheduled maintenance interval to help make sure your vehicle keeps running great.

# Scheduled Maintenance

<b>Multi-Point Inspection</b>	
12V Battery performance	Radiator, cooler, heater and air conditioning hoses
Exterior lamps and hazard warning system operation	Suspension components for leaks or damage
Fluid levels; fill if necessary <sup>1</sup>	Steering and linkage
For fluid leaks	Tires for wear and proper pressure <sup>2</sup>
Half-shaft dust boots	Windshield for cracks, chips or pits
Horn operation	Washer spray and wiper operation

<sup>1</sup> Brake, coolant recovery reservoir and window washer.

<sup>2</sup> Your vehicle is equipped with a temporary mobility kit; check the tire sealant expiration Use By date on the canister. Replace as needed.

Be sure to ask your dealership service advisor or technician about the multi-point vehicle inspection. It is a comprehensive way to perform a thorough inspection of your vehicle. Your checklist gives you immediate feedback on the overall condition of your vehicle.

## NORMAL SCHEDULED MAINTENANCE

<b>Normal Scheduled Maintenance<sup>1</sup></b>	
Every 12 months or 10,000 mi (16,000 km).	Rotate tires, inspect tire wear and measure tread depth.
	Perform multi-point inspection (recommended).
	Inspect brake pads, shoes, rotors, drums, brake linings, hoses and parking brake.
	Inspect cooling system level, strength and hoses.
	Inspect half-shaft boots.

# Scheduled Maintenance

<b>Normal Scheduled Maintenance</b> <sup>1</sup>	
	Inspect steering linkage, ball joints, suspension and tie-rod ends.
	Inspect wheels and related components for abnormal noise, wear, looseness or drag.

<sup>1</sup> Do not exceed one year or 10,000 mi (16,000 km) between service intervals.

<b>Brake Fluid Maintenance</b> <sup>1</sup>	
Every 3 Years	Change brake fluid. <sup>2</sup>

<sup>1</sup> Perform this maintenance item every 3 years. Do not exceed the designated time for the interval.

<sup>2</sup> Brake fluid servicing requires special equipment available at your authorized dealer.

<b>Other Maintenance Items</b>	
Every 20,000 mi (32,000 km)	Replace cabin air filter. <sup>1</sup>
At 10 years or 150,000 mi (240,000 km)	Change the transmission fluid.
At 200,000 mi (322,000 km)	Change the coolant. <sup>2</sup>

<sup>1</sup> Cabin air filter life is dependent on exposure to dusty and dirty conditions. Vehicles operated in these conditions require frequent inspection and replacement of the cabin air filter.

<sup>2</sup> Initial replacement at 10 years or 200,000 mi (322,000 km), then every 5 years or 100,000 mi (160,000 km).

# Customer Information

## ROLLOVER WARNING



**WARNING:** Utility vehicles have a significantly higher rollover rate than other types of vehicles.



**WARNING:** Vehicles with a higher center of gravity (utility and four-wheel drive vehicles) handle differently than vehicles with a lower center of gravity (passenger cars). Avoid sharp turns, excessive speed and abrupt steering in these vehicles. Failure to drive cautiously increases the risk of losing control of your vehicle, vehicle rollover, personal injury and death.



**WARNING:** In a rollover crash, an unbelted person is significantly more likely to die than a person wearing a seatbelt.



**WARNING:** Do not become overconfident in the ability of four-wheel drive vehicles. Although a four-wheel drive vehicle may accelerate better than a two-wheel drive vehicle in low traction situations, it won't stop any faster than two-wheel drive vehicles. Always drive at a safe speed.

Utility vehicles and trucks handle differently than passenger cars in the various driving conditions that are encountered on streets, highways and off-road. Utility vehicles and trucks are not designed for cornering at speeds as high as passenger cars any more than low-slung sports cars are designed to perform satisfactorily under off-road conditions.

## THE BETTER BUSINESS BUREAU AUTO LINE PROGRAM

Your satisfaction is important to Ford Motor Company and to your dealer. If a warranty concern has not been resolved using the three-step procedure outlined earlier in this chapter in the Getting the Services you need section, you may be eligible to participate in the BBB AUTO LINE program.

The BBB AUTO LINE program consists of two parts – mediation and arbitration. During mediation, a representative of the BBB will contact both you and Ford Motor Company to explore options for settlement of the claim. If an agreement is not reached during mediation or you do not want to participate in mediation, and if your claim is eligible, you may participate in the arbitration process. An arbitration hearing will be scheduled so that you can present your case in an informal setting before an impartial person. The arbitrator considers the testimony provided and makes a decision after the hearing.

Disputes submitted to the BBB AUTO LINE program are usually decided within 40 days after you file your claim with the BBB. You are not bound by the decision, and may reject the decision and proceed to court where all findings of the BBB Auto Line dispute, and decision, are admissible in the court action. Should you choose to accept the BBB AUTO LINE decision, Ford is then bound by the decision, and must comply with the decision within 30 days of receipt of your acceptance letter.

**BBB AUTO LINE Application:** Using the information that follows, please call or write to request a program application. You will be asked for your name and address, general information about your new vehicle, information about your warranty concerns, and any steps you have



## Customer Information

---

already taken to try to resolve them. A Customer Claim Form will be mailed that needs to be completed, signed and returned to the BBB along with proof of ownership. Upon receipt, the BBB reviews the claim for eligibility under the Program Summary Guidelines.

**You can get more information by calling BBB AUTO LINE at 1-800-955-5100, or writing to:**

**BBB AUTO LINE a Division of BBB National Programs, Inc.  
1676 International Drive, Suite 550  
McLean, VA 22102**

BBB AUTO LINE applications can also be requested by calling the Ford Motor Company Customer Relationship Center at 1-800-392-3673.

For additional information, refer to the Better Business Bureau website.

**Note:** *Ford Motor Company reserves the right to change eligibility limitations, modify procedures, or to discontinue this process at any time without notice and without obligation.*

### **THE MEDIATION AND ARBITRATION PROGRAM**

For vehicles delivered to authorized Canadian dealers. In those cases where you continue to feel that the efforts by Ford of Canada and the authorized dealer to resolve a factory-related vehicle service concern have been unsatisfactory, Ford of Canada participates in an impartial third party mediation/arbitration program administered by the Canadian Motor Vehicle Arbitration Plan (CAMVAP).

The CAMVAP program is a straightforward and relatively speedy alternative to resolve a disagreement when all other efforts to produce a settlement have failed. This procedure is without cost to you and is designed to eliminate the need for lengthy and expensive legal proceedings.

In the CAMVAP program, impartial third-party arbitrators conduct hearings at mutually convenient times and places in an informal environment. These impartial arbitrators review the positions of the parties, make decisions and, when appropriate, render awards to resolve disputes. CAMVAP decisions are fast, fair, and final as the arbitrator's award is binding on both you and Ford of Canada.

CAMVAP services are available in all Canadian territories and provinces. For more information, without charge or obligation, call your CAMVAP Provincial Administrator directly at 1-800-207-0685 or visit [www.camvap.ca](http://www.camvap.ca).

### **ORDERING A CANADIAN FRENCH OWNER'S MANUAL**

You can obtain a French owner's manual from an authorized dealer or by contacting Helm, LLC at:

HELM, LLC  
47911 Halyard Drive, Suite 200  
Plymouth, Michigan 48170  
Attention: Customer Service

Call toll free: 1-800-782-4356

Monday-Friday 8:00 a.m. - 6:00 p.m. EST

For additional information, visit [www.helminc.com](http://www.helminc.com).

## Customer Information

### REPORTING SAFETY DEFECTS IN THE UNITED STATES

If you believe that your vehicle has a defect which could cause a crash or could cause injury or death, you should immediately inform the National Highway Traffic Safety Administration (NHTSA) in addition to notifying Ford Motor Company.

If NHTSA receives similar complaints, it may open an investigation, and if it finds that a safety defect exists in a group of vehicles, it may order a recall and remedy campaign. However, NHTSA cannot become involved in individual problems between you, your dealer, or Ford Motor Company.

To contact NHTSA, you may call the Vehicle Safety Hotline toll-free at 1-888-327-4236 (TTY: 1-800-424-9153); go to [www.safercar.gov](http://www.safercar.gov); or write to:

Administrator

1200 New Jersey Avenue,  
Southeast

Washington, D.C. 20590

You can also obtain other information about motor vehicle safety from [www.safercar.gov](http://www.safercar.gov).

### REPORTING SAFETY DEFECTS IN CANADA

If you believe that your vehicle has a defect which could cause a crash or could cause injury or death, you should immediately inform Transport Canada and Ford of Canada.

#### Transport Canada Contact Information

Website (English)	<a href="http://tc.canada.ca/recalls">http://tc.canada.ca/recalls</a>
Website (French)	<a href="http://tc.canada.ca/rappels">http://tc.canada.ca/rappels</a>
Phone	1-800-333-0510

#### Ford of Canada Contact Information

Website	<a href="http://www.ford.ca">www.ford.ca</a>
Phone	1-800-565-3673

# Customer Information

---

## DECLARATION OF CONFORMITY

Your vehicle could have components that transmit and receive radio waves and are therefore subject to government regulation.

These components must accept any interference received, including interference that could cause undesired operation. For certification labels and declarations of conformity, visit [www.wirelessconformity.ford.com](http://www.wirelessconformity.ford.com).

## RADIO FREQUENCY CERTIFICATION LABELS

## BLIND SPOT INFORMATION SYSTEM SENSORS

### Argentina



### Belarus



### Brazil



### Canada

Short Range Radar Sensor SRR3-B  
IC ID: 4135A-SRR3B

# Customer Information

---

This device contains licence-exempt transmitter(s)/receiver(s) that comply with Innovation, Science and Economic Development Canada's licence-exempt RSS(s). Operation is subject to the following two conditions:

1. This device may not cause interference.
2. This device must accept any interference, including interference that may cause undesired operation of the device.

Radiofrequency radiation exposure information:

This equipment complies with radiation exposure limits set forth for an uncontrolled environment. This equipment should be installed and operated with minimum distance of 8 in (20 cm) between the radiator and the body of any persons, user or bystander.

L'émetteur/récepteur exempt de licence contenu dans le présent appareil est conforme aux CNR d'Innovation, Sciences et Développement économique Canada applicables aux appareils radio exempts de licence. L'exploitation est autorisée aux deux conditions suivantes:

1. L'appareil ne doit pas produire de brouillage;
2. L'appareil doit accepter tout brouillage radioélectrique subi, même si le brouillage est susceptible d'en compromettre le fonctionnement.

Cet équipement est conforme aux limites d'exposition aux rayonnements établies pour un environnement non contrôlé. Cet équipement doit être installé et utilisé avec un minimum de 8 in (20 cm) de distance entre la source de rayonnement et votre corps.

## Djibouti

AGREE PAR LE MCPT (REPUBLIQUE DE DJIBOUTI)  
Numéro d'agrément : 240/MCPT/SG/16  
Date d'agrément : 23/05/2016

## European Union EU

CE

# Customer Information

---

## Ghana

NCA PRODUCT IDENTIFIER: 3R8-8M-7DF-231

## Mauritania

AGREE PAR L'ANE MAURITANIE  
Numéro d'agrément : 0727/ARE/2018  
Date d'agrément : 10/12/2019

## Jamaica

This product has been Type Approved  
by Jamaica: SMA - SRR3-B.

## Malaysia



RALM/24A/0715/S(15-2272)

## Mexico

IFETEL: RLVCSR15-0904

La operación de este equipo está sujeta a las siguientes dos condiciones:

- (1) es posible que este equipo o dispositivo no cause interferencia perjudicial y
- (2) este equipo o dispositivo debe aceptar cualquier interferencia, incluyendo la que pueda causar su operación no deseada.

## Moldova



# Customer Information

---

## Pakistan



## Serbia



## Paraguay



## Singapore

Complies with IMDA Standards

DA 00461

## Russia



## South Africa



# Customer Information

---

## South Korea



MSIP-CRM-8DC-SRR3B

## Taiwan, China

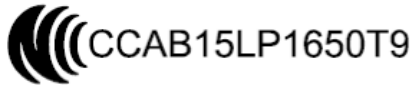

### 警語

經型式認證合格之低功率射頻電機，非經許可，公司、商號或使用者均不得擅自變更頻率、加大功率或變更原設計之特性及功能。

低功率射頻電機之使用不得影響飛航安全及干擾合法通信；經發現有干擾現象時，應立即停用，並改善至無干擾時方得繼續使用。

前項合法通信，指依電信法規定作業之無線電通信。低功率射頻電機須忍受合法通信或工業、科學及醫療用電波輻射性電機設備之干擾。

# Customer Information

---

## Ukraine



справжнім FDC. Automotive Distance Control Systems GmbH заявляє, що тип радіообладнання SRR3 - В відповідає технічному регламенту радіообладнання ;

повний текст декларації про відповідність доступний на веб-сайті за такою адресою :

<http://continental.automotive-approvals.com/>

## United Arab Emirates (U.A.E.)

TRA  
REGISTERED No:  
ER62934

DEALER No:  
DA40068

## United Kingdom



## United States of America

FCC ID: OAYSRR3B

This device complies with Part 15 of the FCC Rules. Operation is subject to the following two conditions:

1. This device may not cause harmful interference, and
2. This device must accept any interference received, including interference that may cause undesired operation.

## CAUTION TO USERS



# Customer Information

Changes or modifications not expressly approved by the party responsible for compliance could void the user's authority to operate the equipment.

## Vietnam



## Zambia



## REMOTE FUNCTION ACTUATOR

### China

CMIIT ID: 2018DJ4563

## United States and Canada

**WARNING:** Changes or modifications not expressly approved by the party responsible for compliance could void the user's authority to operate the equipment. The term "IC:" before the radio certification number only signifies that Industry Canada technical specifications were met.

FCC ID: HYQS2NA0

IC: 1551A-S2NA0

This device complies with Part 15 of the FCC Rules and with Innovation, Science and Economic Development Canada's licence-exempt RSS(s). Operation is subject to the following two conditions:

1. This device may not cause harmful interference, and
2. This device must accept any interference received, including interference that may cause undesired operation.

## CRUISE CONTROL MODULE

### Argentina



# Customer Information

---

## Djibouti

AGREE PAR LE MCPT (REPUBLIQUE DE DJIBOUTI)  
Numéro d'agrément : 059/DDTIC/2020  
Date d'agrément : 01/10/2020

## Jamaica

This product has been Type Approved by Jamaica: SMA – F3TR.

## Europe Union EU



## Mauritania

AGREE PAR L'ANE MAURITANIE  
Numéro d'agrément : 0835/ARE/2020  
Date d'agrément : 31/08/2020

## Ghana

NCA APPROVED: SRO-1M-7E4-X13

## Paraguay



2020-10-I-0752

# Customer Information

## South Korea



R-C-1Ap-F3TR

## Taiwan

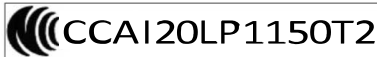

## Unites Arab Emirates (U.A.E.)

TRA  
REGISTERED NO: ER80143/20  
DEALER NO: DA83047/19

## United States and Canada

 **WARNING:** Changes or modifications not expressly approved by the party responsible for compliance could void the user's authority to operate the equipment. The term "IC:" before the radio certification number only signifies that Industry Canada technical specifications were met.

FCC ID: L2CF3TR

IC: 3432A-F3TR

This device complies with Part 15 of the FCC Rules and with Innovation, Science and Economic Development Canada's licence-exempt RSS(s). Operation is subject to the following two conditions:

1. This device may not cause harmful interference, and
2. This device must accept any interference received, including interference that may cause undesired operation.

## Zambia



# Customer Information

## GARAGE DOOR OPENER

### United States and Canada



**WARNING:** Changes or modifications not expressly approved by the party responsible for compliance could void the user's authority to operate the equipment. The term "IC:" before the radio certification number only signifies that Industry Canada technical specifications were met.

FCC ID: NZLSAHL5E

IC: 4112A-SAHL5E

This device complies with Part 15 of the FCC Rules and with Innovation, Science and Economic Development Canada's licence-exempt RSS(s). Operation is subject to the following two conditions:

1. This device may not cause harmful interference, and
2. This device must accept any interference received, including interference that may cause undesired operation.

## SYNC

### Argentina

**CNC** COMISIÓN NACIONAL  
DE COMUNICACIONES

**CNC ID: C-24008**

**CNC** COMISIÓN NACIONAL  
DE COMUNICACIONES

**CNC ID: C-24009**

## Brazil



08657-19-01505

**Este equipamento não tem direito à proteção contra interferência prejudicial e não pode causar interferência em sistemas devidamente autorizados.**



08658-19-01505

**Este equipamento não tem direito à proteção contra interferência prejudicial e não pode causar interferência em sistemas devidamente autorizados.**

# Customer Information

---

## Djibouti

AGREE PAR LE MCPT (REPUBLIQUE DE DJIBOUTI)  
Numéro d'agrément : 124/DDTIC/2019  
Date d'agrément : 07/08/2019

NCA APPROVED: ZRO-1H-7E3-180

## Jamaica

This product has been Type Approved by  
Jamaica: SMA – SYNC-G4.

AGREE PAR LE MCPT (REPUBLIQUE DE DJIBOUTI)  
Numéro d'agrément : 125/DDTIC/2019  
Date d'agrément : 07/08/2019

This product has been Type Approved by Jamaica: SMA – SYNC-G4L

## European Union EU



## Malaysia



## Ghana

NCA APPROVED: ZRO-1H-7E3-182

SQASI/TA/19/4047  
SQASI/TA/19/4046

# Customer Information

## Mauritania

**AGREE PAR L'ANE MAURITANIE**  
**Numéro d'agrément : 0692/ARE/2018**  
**Date d'agrément : 08/08/2019**

AGREE PAR L'ANE MAURITANIE  
Numéro d'agrément : 0691/ARE/2018  
Date d'agrément : 08/08/2019

## Morocco

AGREE PAR L'ANRT MAROC  
N° D'AGRÉMENT: MR 20608 ANRT 2019  
07 AOUT 2019

AGREE PAR L'ANRT MAROC  
N° D'AGRÉMENT: MR 20606 ANRT 2019  
07 AOUT 2019

## Moldova



## Pakistan



# Customer Information

## Paraguay



2020-03-I-00192

2020-03-I-00193

## Serbia



## Singapore

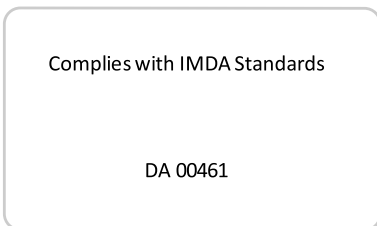

## South Africa





## South Korea



# Customer Information

## Taiwan

 CCAB20LP0290T8

 CCAB20LP0300T1

## United Arab Emirates (U.A.E.)

UAE - TRA  
REGISTERED No:  
ER74902/19  
DEALER No:  
DA37380/15

TRA  
REGISTERED No: ER74903/19  
DEALER No: DA37380/15

## Ukraine

  
UA.TR.028

## United States and Canada

 **WARNING:** Changes or modifications not expressly approved by the party responsible for compliance could void the user's authority to operate the equipment. The term "IC:" before the radio certification number only signifies that Industry Canada technical specifications were met.

FCC ID: KMH-SYNCG4

FCC ID: KMH-SYNCG4L

IC: 1422A-SYNCG4

IC: 1422A-SYNCG4L



## Customer Information

This device complies with Part 15 of the FCC Rules and with Innovation, Science and Economic Development Canada's licence-exempt RSS(s). Operation is subject to the following two conditions:

1. This device may not cause harmful interference, and
2. This device must accept any interference received, including interference that may cause undesired operation.

### Zambia



### TELEMATICS CONTROL UNIT

#### Brazil



#### Mexico



#### United Arab Emirates (U.A.E.)

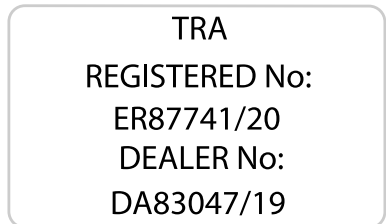

# Customer Information

## United Kingdom



## South Africa



## United States and Canada



**WARNING:** Changes or modifications not expressly approved by the party responsible for compliance could void the user's authority to operate the equipment. The term "IC:" before the radio certification number only signifies that Industry Canada technical specifications were met.

FCC ID: KMH-14H074-NA1

IC: 1422A-14H074NA1

This device complies with Part 15 of the FCC Rules and with Innovation, Science and Economic Development Canada's licence-exempt RSS(s). Operation is subject to the following two conditions:

1. This device may not cause harmful interference, and
2. This device must accept any interference received, including interference that may cause undesired operation.

## TIRE PRESSURE MONITORING SYSTEM SENSORS - VEHICLES WITH: 315 MHZ SENSORS

### Brazil



### Jamaica

This product has been Type Approved by Jamaica: SMA – AG2SZ3

# Customer Information

## Mexico

IFT: RLVSCFP15-1249

"La operación de este equipo está sujeta a las siguientes dos condiciones: (1) es posible que este equipo o dispositivo no cause interferencia perjudicial y (2) este equipo o dispositivo debe aceptar cualquier interferencia, incluyendo la que pueda causar su operación no deseada."

## Paraguay



NR: 2014-07-1-000191

## Taiwan



CCAM14LP0460T0

本產品符合低功率電波輻射性電機管理辦法 第十二條、第十四條等條之規定  
1. 經型式認證合格之低功率射頻電機，非經許可，公司、商號或使用者均不得擅自變更頻率、加大功率或變更原設計之特性及功能。

2. 低功率射頻電機之使用不得影響飛航安全及干擾合法通信；經發現有干擾現象時，應立即停用，並改善至無干擾時方得繼續使用。  
前項合法通信，指依電信法規定作業之無線電通信。  
低功率射頻電機須忍受合法通信或工業、科學及醫療用電波輻射性電機設備之干擾。

## United States and Canada



**WARNING:** Changes or modifications not expressly approved by the party responsible for compliance could void the user's authority to operate the equipment. The term "IC:" before the radio certification number only signifies that Industry Canada technical specifications were met.

FCC ID: MRXAG2SZ3

IC: 2546A-AG2SZ3

This device complies with Part 15 of the FCC rules and with Innovation, Science and Economic Development Canada's licence-exempt RSS(s). Operation is subject to the following two conditions:

1. This device may not cause harmful interference, and
2. This device must accept any interference received, including interference that may cause undesired operation.

# Customer Information

## TIRE PRESSURE MONITORING SYSTEM SENSORS - VEHICLES WITH: 433 MHZ SENSORS

### Argentina



### China

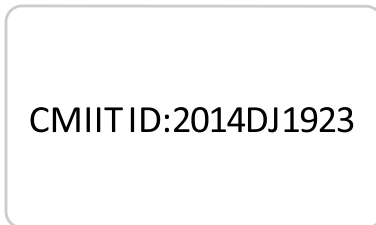

### European Union (EU)

Hereby, Schrader Electronics Ltd. declares that the radio equipment type AG25Z4 is in compliance with Directive 2014/53/EU.  
The full text of the EU declaration of conformity is available at the following internet address:  
[http://www.transuroshop.com/documents/declaration\\_conformiteis](http://www.transuroshop.com/documents/declaration_conformiteis)  
E-433 92MHzP < 10mW (e.i.r.p)  
Schrader Electronics Ltd. 11 Technology Park, Belfast Road, Antrim BT41 1QS, Northern Ireland United Kingdom

### Ghana



### Jordan

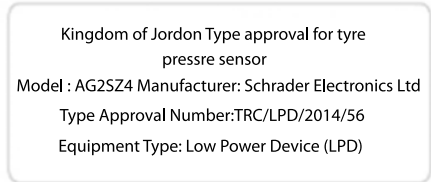

### Malaysia



CIDF15000486

# Customer Information

## Mauritania

AGREE PAR L'ANE MAURITANIE  
Numéro d'agrément : 0611/ARE/2019  
Date d'agrément : 11/01/2019

## Morocco

AGREE PAR L'ANRT MAROC  
Numéro d'agrément: MR9098  
ANRT 2014  
Date d'agrément: 14/03/2014

## Mexico

IFT: RLVSCMR15-1238  
"La operación de este equipo está sujeta a las siguientes dos condiciones:  
(1) es posible que este  
equipo o dispositivo no cause interferencia perjudicial y  
(2) este equipo o dispositivo debe aceptar  
cualquier interferencia, incluyendo la que pueda causar  
su operación no deseada."

## Nigeria

Connection and use of this  
communications  
equipment is permitted by the Nigerian  
Communications Commission

## Moldova



## Oman

OMAN TRA  
TA-R/1752/14  
D090258

## Philippines



Type Approved

**NTC**

No:ESD-1408639C

# Customer Information

---

## Russia



## South Korea



## Serbia



MSIP-CRM-SRD-AG2SZ4

## Taiwan

## Singapore

Complies with  
IDA Standards  
DA 105282



CCAM14LP0090T3

## South Africa



TA-2014/064

Approved

## Ukraine



# Customer Information

## United Arab Emirates

TRA  
REGISTERED NO: ER0130238/14  
DEALER NO: DA0047074/10

## WIRELESS ACCESSORY CHARGING MODULE

### Argentina

**CNC** COMISIÓN NACIONAL  
DE COMUNICACIONES

CNC ID: H-21576

## United States and Canada



**WARNING:** Changes or modifications not expressly approved by the party responsible for compliance could void the user's authority to operate the equipment. The term "IC:" before the radio certification number only signifies that Industry Canada technical specifications were met.

FCC ID: MRXAG2SZ4

IC: 2546A-AG2SZ4

This device complies with Part 15 of the FCC Rules and with Innovation, Science and Economic Development Canada's licence-exempt RSS(s). Operation is subject to the following two conditions:

1. This device may not cause harmful interference, and
2. This device must accept any interference received, including interference that may cause undesired operation.

### Brazil



**ANATEL**

Agência Nacional de Telecomunicações

04021-18-06661

### Djibouti

AGREE PAR LE MCPT (REPUBLIQUE DE DJIBOUTI)  
Numéro d'agrément : 004/DDTIC/2019  
Date d'agrément : 10/01/2019

# Customer Information

---

## European Union EU



## Malaysia



SQASI/TA/19/4129

## Ghana

NCA APPROVED: 1R3-1M-7E1-174

## Jamaica

This product has been Type Approved  
by Jamaica: SMA - WACM.

## Mauritania

AGREE PAR L'ANE MAURITANIE  
Numéro d'agrément : 0474/ARE/2018  
Date d'agrément : 05/03/2018

## Jordan

Type Approval No: TRC/LPD/2017/418  
Equipment Type: Low Power Device (LPD)

## Moldova





# Customer Information

---

## Morocco

AGREE PAR L'ANRT MAROC  
Numéro d'agrément : MR 15474 ANRT 2017  
Date d'agrément : 25/12/2017

## Singapore

Complies with IMDA Standards

DA 00461

## Paraguay



2017-10-I-0000333

## Serbia



## South Africa



## South Korea

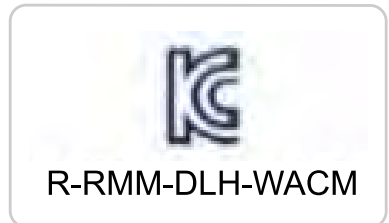

# Customer Information

## Taiwan, China



CCAH17LP1930T0

## United States and Canada

 **WARNING:** Changes or modifications not expressly approved by the party responsible for compliance could void the user's authority to operate the equipment. The term "IC:" before the radio certification number only signifies that Industry Canada technical specifications were met.

FCC ID: L2C0066T

This device complies with Part 15 of the FCC Rules and with Innovation, Science and Economic Development Canada's licence-exempt RSS(s). Operation is subject to the following two conditions:

1. This device may not cause harmful interference, and
2. This device must accept any interference received, including interference that may cause undesired operation.

## Ukraine



## Vietnam

## United Arab Emirates (U.A.E.)

TRA  
REGISTERED No:  
ER57347/17

DEALER No:  
DA37380/15



# Customer Information

---

## Zambia



## PERCHLORATE

Certain components in your vehicle such as airbag modules, seatbelt pretensioners and remote control batteries may contain perchlorate material. Special handling may apply for service or vehicle end of life disposal.

For more information visit:  
[www.dtsc.ca.gov/hazardouswaste/perchlorate](http://www.dtsc.ca.gov/hazardouswaste/perchlorate).

## REPLACEMENT PARTS RECOMMENDATION

We have built your vehicle to the highest standards using quality parts. We recommend that you demand the use of genuine Ford and Motorcraft parts whenever your vehicle requires scheduled maintenance or repair. You can clearly identify genuine Ford and Motorcraft parts by looking for the Ford, FoMoCo or Motorcraft branding on the parts or their packaging.

## Scheduled Maintenance and Mechanical Repairs

One of the best ways for you to make sure that your vehicle provides years of service is to have it maintained in line with our recommendations using parts that conform to the specifications detailed in this Owner's Manual.

Genuine Ford and Motorcraft parts meet or exceed these specifications.

## Collision Repairs

We hope that you never experience a collision, but accidents happen sometimes.

Genuine Ford replacement collision parts meet our stringent requirements for fit, finish, structural integrity, corrosion protection and dent resistance. During vehicle development we validate that these parts deliver the intended level of protection as a whole system. A great way to know for sure you are getting this level of protection is to use genuine Ford replacement collision parts.

## Warranty on Replacement Parts

Genuine Ford and Motorcraft replacement parts are the only replacement parts that benefit from a Ford Warranty.

The Ford Warranty may not cover damage caused to your vehicle as a result of failed non-Ford parts.

For additional information, refer to the terms and conditions of the Ford Warranty.

# Customer Information

---

## MOBILE COMMUNICATIONS EQUIPMENT



**WARNING:** Driving while distracted can result in loss of vehicle control, crash and injury. We strongly recommend that you use extreme caution when using any device that may take your focus off the road. Your primary responsibility is the safe operation of your vehicle. We recommend against the use of any hand-held device while driving and encourage the use of voice-operated systems when possible. Make sure you are aware of all applicable local laws that may affect the use of electronic devices while driving.

Using mobile communications equipment is becoming increasingly important in the conduct of business and personal affairs. However, you must not compromise your own or others' safety when using such equipment. Mobile communications can enhance personal safety and security when appropriately used, particularly in emergency situations. Safety must be paramount when using mobile communications equipment to avoid negating these benefits. Mobile communication equipment includes, but is not limited to, cellular phones, pagers, portable email devices, text messaging devices and portable two-way radios.

## FEDERAL HIGHWAY ADMINISTRATION REGULATION

Regulations such as those issued by the Federal Highway Administration or issued pursuant to the Occupational Safety and Health Act (OSHA), and state and local laws and regulations may require additional equipment for the way you intend to use your vehicle. It is the responsibility of the registered owner to determine the applicability of such laws and regulations to your intended use for the vehicle, and to arrange for the installation of required equipment. The dealer has information about the availability of equipment which can be ordered for your vehicle.

# Customer Information

## END USER LICENSE AGREEMENT

### VEHICLE SOFTWARE END USER LICENSE AGREEMENT (EULA)

- You ("You" or "Your" as applicable) have acquired a vehicle having several devices, including SYNC ® and various control modules, ("DEVICES") that include software licensed or owned by Ford Motor Company and its affiliates ("FORD MOTOR COMPANY"). Those software products of FORD MOTOR COMPANY origin, as well as associated media, printed materials, and "online" or electronic documentation ("SOFTWARE") are protected by international intellectual property laws and treaties. The SOFTWARE is licensed, not sold. All rights reserved.
- The SOFTWARE may interface with and/or communicate with, or may be later upgraded to interface with and/or communicate with additional software and/or systems provided by FORD MOTOR COMPANY.

**IF YOU DO NOT AGREE TO THIS END USER LICENSE AGREEMENT ("EULA") DO NOT USE THE DEVICES OR COPY THE SOFTWARE. ANY USE OF THE SOFTWARE, INCLUDING BUT NOT LIMITED TO USE ON THE DEVICES, WILL CONSTITUTE YOUR AGREEMENT TO THIS EULA (OR RATIFICATION OF ANY PREVIOUS CONSENT).**

**GRANT OF SOFTWARE LICENSE:** This EULA grants you the following license:

- You may use the SOFTWARE as installed on the DEVICES and as otherwise interfacing with systems and/or services provide by or through FORD MOTOR COMPANY or its third party software and service providers.

## Description of Other Rights and Limitations.

- **Speech Recognition:** If the SOFTWARE includes speech recognition component(s), you should understand that speech recognition is an inherently statistical process and that recognition errors are inherent in the process. Neither FORD MOTOR COMPANY nor its suppliers shall be liable for any damages arising out of errors in the speech recognition process. It is your responsibility to monitor any speech recognition functions included in the system.
- **Limitations on Reverse Engineering, Decompilation and Disassembly:** You may not reverse engineer, decompile, translate, disassemble or attempt to discover any source code or underlying ideas or algorithms of the SOFTWARE nor permit others to reverse engineer, decompile or disassemble the SOFTWARE, except and only to the extent that such activity is expressly permitted by applicable law notwithstanding this limitation or to the extent as may be permitted by the licensing terms governing use of any open source components included with the SOFTWARE.
- **Limitations on Distributing, Copying, Modifying and Creating Derivative Works:** You may not distribute, copy, make modifications to or create derivative works based on the SOFTWARE, except and only to the extent that such activity is expressly permitted by applicable law notwithstanding this limitation or to the extent as may be permitted by the licensing terms governing use of any open source components included with the SOFTWARE.

# Customer Information

---

- **Single EULA:** The end user documentation for the DEVICES and related systems and services may contain multiple EULAs, such as multiple translations and/or multiple media versions (e.g., in the user documentation and in the software). Even if you receive multiple EULAs, you are licensed to use only one (1) copy of the SOFTWARE.
- **SOFTWARE Transfer:** You may permanently transfer your rights under this EULA only as part of a sale or transfer of the DEVICES, provided you retain no copies, you transfer all of the SOFTWARE (including all component parts, the media and printed materials, any upgrades, and, if applicable, the Certificate(s) of Authenticity), and the recipient agrees to the terms of this EULA. If the SOFTWARE is an upgrade, any transfer must include all prior versions of the SOFTWARE.
- **Termination:** Without prejudice to any other rights, FORD MOTOR COMPANY may terminate this EULA if you fail to comply with the terms and conditions of this EULA.
- **Internet-Based Services Components:** The SOFTWARE may contain components that enable and facilitate the use of certain Internet-based services. You acknowledge and agree that FORD MOTOR COMPANY, third party software and service suppliers, its affiliates and/or its designated agent may automatically check the version of the SOFTWARE and/or its components that you are utilizing and may provide upgrades or supplements to the SOFTWARE that may be automatically downloaded to your DEVICES.
- **Additional Software/Services:** The SOFTWARE may permit FORD MOTOR COMPANY, third party software and service suppliers, its affiliates and/or its designated agent to provide or make available to you SOFTWARE updates, supplements, add-on components, or Internet-based services components of the SOFTWARE after the date you obtain your initial copy of the SOFTWARE ("Supplemental Components".) SOFTWARE updates may cause you to incur additional charges from your wireless service provider. If FORD MOTOR COMPANY or third party software and services suppliers provide or make available to you Supplemental Components and no other EULA terms are provided along with the Supplemental Components, then the terms of this EULA shall apply. FORD MOTOR COMPANY, its affiliates and/or its designated agent reserve the right to discontinue without liability any Internet-based services provided to you or made available to you through the use of the SOFTWARE.

# Customer Information

---

- **Links to Third Party Sites:** The SOFTWARE may provide you with the ability to link to third party sites. The third party sites are not under the control of FORD MOTOR COMPANY, its affiliates and/or its designated agent. Neither FORD MOTOR COMPANY nor its affiliates nor its designated agent are responsible for (i) the contents of any third party sites, any links contained in third party sites, or any changes or updates to third party sites, or (ii) webcasting or any other form of transmission received from any third party sites. If the SOFTWARE provides links to third party sites, those links are provided to you only as a convenience, and the inclusion of any link does not imply an endorsement of the third party site by FORD MOTOR COMPANY, its affiliates and/or its designated agent.
- **Obligation to Drive Responsibly:** You recognize your obligation to drive responsibly and keep attention on the road. You will read and abide with the DEVICES operating instructions particularly as they pertain to safety and you agree to assume any risk associated with the use of the DEVICES.

## **UPGRADES AND RECOVERY MEDIA:**

If the SOFTWARE is provided by FORD MOTOR COMPANY separate from the DEVICES on media such as a ROM chip, CD ROM disk(s) or via web download or other means, and is labeled "For Upgrade Purposes Only" or "For Recovery Purposes Only" you may install one (1) copy of such SOFTWARE onto the DEVICES as a replacement copy for the existing SOFTWARE, and use it in accordance with this EULA, including any additional EULA terms accompanying the upgrade SOFTWARE.

## **INTELLECTUAL PROPERTY RIGHTS:**

All title and intellectual property rights in and to the SOFTWARE (including but not limited to any images, photographs, animations, video, audio, music, text and "applets" incorporated into the SOFTWARE), the accompanying printed materials, and any copies of the SOFTWARE, are owned by FORD MOTOR COMPANY, or its affiliates or suppliers. The SOFTWARE is licensed, not sold. You may not copy the printed materials accompanying the SOFTWARE. All title and intellectual property rights in and to the content which may be accessed through use of the SOFTWARE is the property of the respective content owner and may be protected by applicable copyright or other intellectual property laws and treaties. This EULA grants you no rights to use such content outside its intended use. All rights not specifically granted under this EULA are reserved by FORD MOTOR COMPANY, its affiliates, and third party software and service providers and suppliers. Use of any on-line services which may be accessed through the SOFTWARE may be governed by the respective terms of use relating to such services. If this SOFTWARE contains documentation that is provided only in electronic form, you may print one copy of such electronic documentation.

**EXPORT RESTRICTIONS:** You acknowledge that the SOFTWARE is subject to U.S. and European Union export jurisdiction. You agree to comply with all applicable international and national laws that apply to the SOFTWARE, including the U.S. Export Administration Regulations, as well as end-user, end-use and destination restrictions issued by U.S. and other governments.

# Customer Information

---

**TRADEMARKS:** This EULA does not grant you any rights in connection with any trademarks or service marks of FORD MOTOR COMPANY, its affiliates, and third party software and service providers.

**PRODUCT SUPPORT:** Please refer to FORD MOTOR COMPANY instructions provided in the documentation for the DEVICES product support, such as the vehicle owner guide.

Should you have any questions concerning this EULA, or if you desire to contact FORD MOTOR COMPANY for any other reason, please refer to the address provided in the documentation for the DEVICES.

**No Liability for Certain Damages:** EXCEPT AS PROHIBITED BY LAW, FORD MOTOR COMPANY, ANY THIRD PARTY SOFTWARE OR SERVICES SUPPLIERS, AND THEIR AFFILIATES SHALL HAVE NO LIABILITY FOR ANY INDIRECT, SPECIAL, CONSEQUENTIAL OR INCIDENTAL DAMAGES ARISING FROM OR IN CONNECTION WITH THE USE OR PERFORMANCE OF THE SOFTWARE. THIS LIMITATION SHALL APPLY EVEN IF ANY REMEDY FAILS OF ITS ESSENTIAL PURPOSE. THERE ARE NO WARRANTIES OTHER THAN THOSE THAT MAY BE EXPRESSLY PROVIDED FOR YOUR NEW VEHICLE.

## **SYNC® Automotive Important Safety Information Read and follow instructions:**

- Before using your SYNC® system, read and follow all instructions and safety information provided in this end user manual ("Owner Guide".) Not following precautions found in the Owner Guide can lead to an accident or other serious injuries.

## General Operation

- **Voice Command Control:** Certain functions within the SYNC® system may be accomplished using voice commands. Using voice commands while driving helps you to operate the system without removing your hands from the wheel or eyes from the road.
- **Prolonged Views of Screen:** Do not access any function requiring a prolonged view of the screen while you are driving. Pull over in a safe and legal manner before attempting to access a function of the system requiring prolonged attention.
- **Volume Setting:** Do not raise the volume excessively. Keep the volume at a level where you can still hear outside traffic and emergency signals while driving. Driving while unable to hear these sounds could cause an accident.
- **Navigation Features:** Any navigation features included in the system are intended to provide turn by turn instructions to get you to a desired destination. Please make certain all persons using this system carefully read and follow instructions and safety information fully.
- **Distraction Hazard:** Any navigation features may require manual (non-verbal) setup. Attempting to perform such set-up or insert data while driving can distract your attention and could cause an accident or other serious injury. Stop the vehicle in a safe and legal manner before attempting these operations.
- **Let Your Judgment Prevail:** Any navigation features are provided only as an aid. Make your driving decisions based on your observations of local conditions and existing traffic regulations. Any such feature is not a



## Customer Information

---

substitute for your personal judgment. Any route suggestions made by this system should never replace any local traffic regulations or your personal judgment or knowledge of safe driving practices.

- **Route Safety:** Do not follow the route suggestions if doing so would result in an unsafe or illegal maneuver, if you would be placed in an unsafe situation, or if you would be directed into an area that you consider unsafe. The driver is ultimately responsible for the safe operation of the vehicle and therefore, must evaluate whether it is safe to follow the suggested directions.
- **Potential Map Inaccuracy:** Maps used by this system may be inaccurate because of changes in roads, traffic controls or driving conditions. Always use good judgment and common sense when following the suggested routes.
- **Emergency Services:** Do not rely on any navigation features included in the system to route you to emergency services. Ask local authorities or an emergency services operator for these locations. Not all emergency services such as police, fire stations, hospitals and clinics are likely to be contained in the map database for such navigation features.

Your Responsibilities and Assumptions of Risk

- You agree to each of the following:(a) Any use of the SOFTWARE while driving an automobile or other vehicle in violation of applicable law or otherwise driving in an unsafe manner presents a significant risk of distracted driving and should not be attempted under any circumstances;(b) Use of the SOFTWARE at excessive volume poses a significant risk of hearing damage and should not be attempted under any circumstances;(c) The SOFTWARE may not be compatible with new or different versions of an operating system, third party software, or third party services, and the SOFTWARE may potentially cause a critical failure of an operating system, third party software, or third party service.(d) Any third party service accessed by or third party software used with the SOFTWARE (i) may charge an additional fee for access, (ii) may not work correctly, on an uninterrupted basis, or error free, (iii) may change streaming formats or discontinue operation, (iv) may contain adult, profane or offensive content; and (v) may contain inaccurate, false or misleading traffic, weather, financial or safety information or other content; and (e) Use of the SOFTWARE may cause you to incur additional charges from your wireless service provider (WSP) and any data or minute calculators that may be included in the software program are for reference only, are not warranted in any way and should not be relied upon in anyway.
- When using the SOFTWARE, you agree to be responsible for and assume the entire risk to the items set forth in Section (a) – (e) above.

# Customer Information

---

## Disclaimer of Warranty

YOU EXPRESSLY ACKNOWLEDGE AND AGREE THAT USE OF THE DEVICES AND SOFTWARE IS AT YOUR SOLE RISK AND THAT THE ENTIRE RISK AS TO SATISFACTORY QUALITY, PERFORMANCE, COMPATIBILITY, ACCURACY AND EFFORT IS WITH YOU. TO THE MAXIMUM EXTENT PERMITTED BY APPLICABLE LAW, THE SOFTWARE AND ANY THIRD PARTY SOFTWARE OR THIRD-PARTY SERVICES ARE PROVIDED "AS IS" AND "AS AVAILABLE", WITH ALL FAULTS AND WITHOUT WARRANTY OF ANY KIND, AND FORD MOTOR COMPANY HEREBY DISCLAIMS ALL WARRANTIES AND CONDITIONS WITH RESPECT TO THE SOFTWARE, THIRD PARTY SOFTWARE, AND THIRD-PARTY SERVICES, EITHER EXPRESS, IMPLIED OR STATUTORY, INCLUDING, BUT NOT LIMITED TO, THE IMPLIED WARRANTIES AND/OR CONDITIONS OF MERCHANTABILITY, OF SATISFACTORY QUALITY, OF FITNESS FOR AN PARTICULAR PURPOSE, OF ACCURACY, OF QUIET ENJOYMENT, AND NON-INFRINGEMENT OF THIRD-PARTY RIGHTS. FORD MOTOR COMPANY DOES NOT WARRANT (a) AGAINST INTERFERENCE WITH YOUR ENJOYMENT OF THE SOFTWARE, THIRD PARTY SOFTWARE, OR THIRD-PARTY SERVICES, (b) THAT THE SOFTWARE, THIRD PARTY SOFTWARE, OR THIRD-PARTY SERVICES WILL MEET YOUR REQUIREMENTS, (c) THAT THE OPERATION OF THE SOFTWARE, THIRD PARTY SOFTWARE, OR THIRD-PARTY SERVICES WILL BE UNINTERRUPTED OR ERROR-FREE, (d) OR THAT DEFECTS IN THE SOFTWARE, THIRD PARTY SOFTWARE, OR THIRD-PARTY SERVICES WILL BE CORRECTED. NO ORAL OR WRITTEN INFORMATION OR ADVICE GIVEN BY FORD MOTOR COMPANY OR ITS AUTHORIZED REPRESENTATIVE SHALL

CREATE A WARRANTY. SHOULD THE SOFTWARE, THIRD PARTY SOFTWARE, OR THIRD-PARTY SERVICES PROVE DEFECTIVE, YOU ASSUME THE ENTIRE COST OF ALL NECESSARY SERVICING, REPAIR OR CORRECTION. SOME JURISDICTIONS DO NOT ALLOW THE DISCLAIMER OF IMPLIED WARRANTIES OR LIMITATIONS ON APPLICABLE STATUTORY RIGHTS OF A CONSUMER, SO THE ABOVE DISCLAIMER MAY NOT FULLY APPLY TO YOU. THE SOLE WARRANTY PROVIDED BY FORD MOTOR COMPANY SHALL BE FOUND IN THE WARRANTY INFORMATION INCLUDING WITH YOUR OWNER GUIDE. TO THE EXTENT THAT THERE IS ANY CONFLICT BETWEEN THE TERMS OF THIS SECTION AND THE WARRANTY BOOKLET, THE WARRANTY BOOKLET SHALL CONTROL.

## Applicable Law, Venue, Jurisdiction

- The laws of the State of Michigan govern this EULA and Your use of the SOFTWARE. Your use of the SOFTWARE may also be subject to other local, state, national, or international laws. Any litigation arising out of or related to this EULA shall be brought and maintained exclusively in a court of the State of Michigan located in Wayne County or in the United States District Court for the Eastern District of Michigan. You hereby consent to submit to the personal jurisdiction of a court in the State of Michigan located in Wayne County and the United States District Court for the Eastern District of Michigan for any dispute arising out of or relating to this EULA.

# Customer Information

---

## **Binding Arbitration and Class Action Waiver**

**(a) Application.** This Section applies to any dispute EXCEPT IT DOES NOT INCLUDE A DISPUTE RELATING TO COPYRIGHT INFRINGEMENT, OR TO THE ENFORCEMENT OR VALIDITY OF YOUR, FORD MOTOR COMPANY, OR ANY OF FORD MOTOR COMPANY'S LICENSORS' INTELLECTUAL PROPERTY RIGHTS. Dispute means any dispute, action, or other controversy between You and FORD MOTOR COMPANY, other than the exceptions listed above, concerning the SOFTWARE (including its price) or this EULA, whether in contract, warranty, tort, statute, regulation, ordinance, or any other legal or equitable basis.

**(b) Notice of Dispute.** In the event of a Dispute, You or FORD MOTOR COMPANY must give the other a "Notice of Dispute", which is a written statement of the name, address, and contact information of the party giving it, the facts giving rise to the dispute, and the relief requested. You and FORD MOTOR COMPANY will attempt to resolve any dispute through informal negotiation within 60 days from the date the Notice of Dispute is sent. After 60 days, You or FORD MOTOR COMPANY may commence arbitration.

**(c) Small claims court.** You may also litigate any dispute in small claims court in your county of residence or FORD MOTOR COMPANY'S principal place of business, if the dispute meets all requirements to be heard in the small claims court. You may litigate in small claims court whether or not You negotiated informally first.

**(d) Binding arbitration.** If You and FORD MOTOR COMPANY, do not resolve any dispute by informal negotiation or in small claims court, any other effort to resolve the dispute will be conducted exclusively by binding arbitration. You are giving up

the right to litigate (or participate in as a party or class member) all disputes in court before a judge or jury. Instead, all disputes will be resolved before a neutral arbitrator, whose decision will be final except for a limited right of appeal under the Federal Arbitration Act. Any court with jurisdiction over the parties may enforce the arbitrator's award.

**(e) Class action waiver.** Any proceedings to resolve or litigate any dispute in any forum will be conducted solely on an individual basis. Neither you nor FORD MOTOR COMPANY, will seek to have any dispute heard as a class action, as a private attorney general action, or in any other proceeding in which any party acts or proposes to act in a representative capacity. No arbitration or proceeding will be combined with another without the prior written consent of all parties to all affected arbitrations or proceedings.

**(f) Arbitration procedure.** Any arbitration will be conducted by the American Arbitration Association (the "AAA"), under its Commercial Arbitration Rules. If You are an individual and use the SOFTWARE for personal or vehicle use, or if the value of the dispute is \$75,000 or less whether or not You are an individual or how You use the SOFTWARE, the AAA Supplementary Procedures for Consumer-Related Disputes will also apply. To commence arbitration, submit a Commercial Arbitration Rules Demand for Arbitration form to the AAA. You may request a telephonic or in-person hearing by following the AAA rules. In a dispute involving \$10,000 or less, any hearing will be telephonic unless the arbitrator finds good cause to hold an in-person hearing instead. For more information, see [adr.org](http://adr.org) or call 1-800-778-7879. You agree to commence arbitration only in your county of residence or FORD MOTOR COMPANY'S principal place of business. The arbitrator

# Customer Information

---

may award the same damages to you individually as a court could. The arbitrator may award declaratory or injunctive relief only to you individually, and only to the extent required to satisfy your individual claim.

## **(g) Arbitration fees and incentives.**

- i. Disputes involving \$75,000 or less. FORD MOTOR COMPANY will promptly reimburse your filing fees and pay the AAA's and arbitrator's fees and expenses. If you reject FORD MOTOR COMPANY'S last written settlement offer made before the arbitrator was appointed ("last written offer"), your dispute goes all the way to an arbitrator's decision (called an "award"), and the arbitrator awards you more than the last written offer, FORD MOTOR COMPANY will give you three incentives: (1) pay the greater of the award or \$1,000; (2) pay twice your reasonable attorney's fees, if any; and (3) reimburse any expenses (including expert witness fees and costs) that your attorney reasonably accrues for investigating, preparing, and pursuing your claim in arbitration. The arbitrator will determine the amounts.
- ii. Disputes involving more than \$75,000. The AAA rules will govern payment of filing fees and the AAA's and arbitrator's fees and expenses.
- iii. Disputes involving any amount. In any arbitration you commence, FORD MOTOR COMPANY will seek its AAA or arbitrator's fees and expenses, or Your filing fees it reimbursed, only if the arbitrator finds the arbitration frivolous or brought for an improper purpose. In any arbitration FORD MOTOR COMPANY commences, it will pay all

filing, AAA, and arbitrator's fees and expenses. It will not seek its attorney's fees or expenses from you in any arbitration. Fees and expenses are not counted in determining how much a dispute involves.

**(h) Claims or disputes must be filed within one year.** To the extent permitted by law, any claim or dispute under this EULA to which this Section applies must be filed within one year in small claims court (Section c) or in arbitration (Section d). The one-year period begins when the claim or dispute first could be filed. If such a claim or dispute is not filed within one year, it is permanently barred.

**(i) Severability.** If the class action waiver (Section e) is found to be illegal or unenforceable as to all or some parts of a dispute, then that portion of Section e will not apply to those parts. Instead, those parts will be severed and proceed in a court of law, with the remaining parts proceeding in arbitration. If any other provision of that portion Section e is found to be illegal or unenforceable, that provision will be severed with the remainder of Section e remaining in full force and effect.

## **Telenav Software End User License Agreement**

Please read these terms and conditions carefully before you use the TeleNav Software. Your use of the TeleNav Software indicates that you accept these terms and conditions. If you do not accept these terms and conditions, do not break the seal of the package, launch, or otherwise use the TeleNav Software. TeleNav may revise this Agreement and the privacy policy at any time, with or without notice to you. You agree to visit <http://www.telenav.com> from time to time to review the then current version of this Agreement and of the privacy policy.

# Customer Information

---

## 1. Safe and Lawful Use

You acknowledge that devoting attention to the TeleNav Software may pose a risk of injury or death to you and others in situations that otherwise require your undivided attention, and you therefore agree to comply with the following when using the TeleNav Software:

- (a) observe all traffic laws and otherwise drive safely;
- (b) use your own personal judgment while driving. If you feel that a route suggested by the TeleNav Software instructs you to perform an unsafe or illegal maneuver, places you in an unsafe situation, or directs you into an area that you consider to be unsafe, do not follow such instructions;
- (c) do not input destinations, or otherwise manipulate the TeleNav Software, unless your vehicle is stationary and parked;
- (d) do not use the TeleNav Software for any illegal, unauthorized, unintended, unsafe, hazardous, or unlawful purposes, or in any manner inconsistent with this Agreement;
- (e) arrange all GPS and wireless devices and cables necessary for use of the TeleNav Software in a secure manner in your vehicle so that they will not interfere with your driving and will not prevent the operation of any safety device (such as an airbag).

You agree to indemnify and hold TeleNav harmless against all claims resulting from any dangerous or otherwise inappropriate use of the TeleNav Software in any moving vehicle, including as a result of your failure to comply with the directions above.

## 2. Account Information

You agree: (a) when registering the TeleNav Software, to provide TeleNav with true, accurate, current, and complete information about yourself, and (b) to inform TeleNav promptly of any changes to such information, and to keep it true, accurate, current and complete.

## 3. Software License

- Subject to your compliance with the terms of this Agreement, TeleNav hereby grants to you a personal, non-exclusive, non-transferable license (except as expressly permitted below in connection with your permanent transfer of the TeleNav Software license), without the right to sublicense, to use the TeleNav Software (in object code form only) in order to access and use the TeleNav Software. This license shall terminate upon any termination or expiration of this Agreement. You agree that you will use the TeleNav Software only for your personal business or leisure purposes, and not to provide commercial navigation services to other parties.

### 3.1 License Limitations

- **(a)** reverse engineer, decompile, disassemble, translate, modify, alter or otherwise change the TeleNav Software or any part thereof; **(b)** attempt to derive the source code, audio library or structure of the TeleNav Software without the prior express written consent of TeleNav; **(c)** remove from the TeleNav Software, or alter, any of TeleNav's or its suppliers' trademarks, trade names, logos, patent or copyright notices, or other notices or markings; **(d)**

# Customer Information

---

distribute, sublicense or otherwise transfer the TeleNav Software to others, except as part of your permanent transfer of the TeleNav Software; or **(e)** use the TeleNav Software in any manner that

- i. infringes the intellectual property or proprietary rights, rights of publicity or privacy or other rights of any party,
- ii. violates any law, statute, ordinance or regulation, including but not limited to laws and regulations related to spamming, privacy, consumer and child protection, obscenity or defamation, or
- iii. is harmful, threatening, abusive, harassing, tortuous, defamatory, vulgar, obscene, libelous, or otherwise objectionable; and (f) lease, rent out, or otherwise permit unauthorized access by third parties to the TeleNav Software without advanced written permission of TeleNav.

## 4. Disclaimers

- To the fullest extent permissible pursuant to applicable law, in no event will TeleNav, its licensors and suppliers, or agents or employees of any of the foregoing, be liable for any decision made or action taken by you or anyone else in reliance on the information provided by the TeleNav Software. TeleNav also does not warrant the accuracy of the map or other data used for the TeleNav Software. Such data may not always reflect reality due to, among other things, road closures, construction, weather, new roads and other changing conditions. You are responsible for the entire risk arising out of your use of the TeleNav Software. For example but without limitation, you agree not to rely on the TeleNav Software for critical navigation in areas where the well-being or survival of you or others

is dependent on the accuracy of navigation, as the maps or functionality of the TeleNav Software are not intended to support such high risk applications, especially in more remote geographical areas.

- TELENAV EXPRESSLY DISCLAIMS AND EXCLUDES ALL WARRANTIES IN CONNECTION WITH THE TELENAV SOFTWARE, WHETHER STATUTORY, EXPRESS OR IMPLIED, INCLUDING ALL WARRANTIES WHICH MAY ARISE FROM COURSE OF DEALING, CUSTOM OR TRADE AND INCLUDING, BUT NOT LIMITED TO, THE IMPLIED WARRANTIES OF MERCHANTABILITY, FITNESS FOR A PARTICULAR PURPOSE AND NON-INFRINGEMENT OF THIRD PARTY RIGHTS WITH RESPECT TO THE TELENAV SOFTWARE.
- Certain jurisdictions do not permit the disclaimer of certain warranties, so this limitation may not apply to you.

## 5. Limitation of Liability

- TO THE EXTENT PERMITTED UNDER APPLICABLE LAW, UNDER NO CIRCUMSTANCES SHALL TELENAV OR ITS LICENSORS AND SUPPLIERS BE LIABLE TO YOU OR TO ANY THIRD PARTY FOR ANY INDIRECT, INCIDENTAL, CONSEQUENTIAL, SPECIAL OR EXEMPLARY DAMAGES (INCLUDING IN EACH CASE, BUT NOT LIMITED TO, DAMAGES FOR THE INABILITY TO USE THE EQUIPMENT OR ACCESS DATA, LOSS OF DATA, LOSS OF BUSINESS, LOSS OF PROFITS, BUSINESS INTERRUPTION OR THE LIKE) ARISING OUT OF THE USE OF OR INABILITY TO USE THE TELENAV SOFTWARE, EVEN IF TELENAV HAS BEEN ADVISED OF THE POSSIBILITY OF SUCH DAMAGES. NOTWITHSTANDING ANY DAMAGES THAT YOU MIGHT INCUR FOR ANY

# Customer Information

---

REASON WHATSOEVER (INCLUDING, WITHOUT LIMITATION, ALL DAMAGES REFERENCED HEREIN AND ALL DIRECT OR GENERAL DAMAGES IN CONTRACT, TORT (INCLUDING NEGLIGENCE) OR OTHERWISE), THE ENTIRE LIABILITY OF TELENAV AND OF ALL OF TELENAV'S SUPPLIERS SHALL BE LIMITED TO THE AMOUNT ACTUALLY PAID BY YOU FOR THE TELENAV SOFTWARE. SOME STATES AND/OR JURISDICTIONS DO NOT ALLOW THE EXCLUSION OR LIMITATION OF INCIDENTAL OR CONSEQUENTIAL DAMAGES, SO THE ABOVE LIMITATIONS OR EXCLUSIONS MAY NOT APPLY TO YOU.

## **6. Arbitration and Governing Law**

- You agree that any dispute, claim or controversy arising out of or relating to this Agreement or the TeleNav Software shall be settled by independent arbitration involving a neutral arbitrator and administered by the American Arbitration Association in the County of Santa Clara, California. The arbitrator shall apply the Commercial Arbitration Rules of the American Arbitration Association, and the judgment upon the award rendered by the arbitrator may be entered by any court having jurisdiction. Note that there is no judge or jury in an arbitration proceeding and the decision of the arbitrator shall be binding upon both parties. You expressly agree to waive your right to a jury trial. This Agreement and performance hereunder will be governed by and construed in accordance with the laws of the State of California, without giving effect to its conflict of law provisions. To the extent judicial action is necessary in connection with the binding arbitration, both TeleNav and you agree to submit

to the exclusive jurisdiction of the courts of the County of Santa Clara, California. The United Nations Convention on Contracts for the International Sale of Goods shall not apply.

## **7. Assignment**

- You may not resell, assign, or transfer this Agreement or any of your rights or obligations, except in totality, in connection with your permanent transfer of the TeleNav Software, and expressly conditioned upon the new user of the TeleNav Software agreeing to be bound by the terms and conditions of this Agreement. Any such sale, assignment or transfer that is not expressly permitted under this paragraph will result in immediate termination of this Agreement, without liability to TeleNav, in which case you and all other parties shall immediately cease all use of the TeleNav Software. Notwithstanding the foregoing, TeleNav may assign this Agreement to any other party at any time without notice, provided the assignee remains bound by this Agreement.

## **8. Miscellaneous**

### **8.1**

This Agreement constitutes the entire agreement between TeleNav and you with respect to the subject matter hereof.

### **8.2**

Except for the limited licenses expressly granted in this Agreement, TeleNav retains all right, title and interest in and to the TeleNav Software, including without limitation all related intellectual property rights. No licenses or other rights which are not expressly granted in this Agreement are intended to, or shall be, granted or

# Customer Information

---

conferred by implication, statute, inducement, estoppel or otherwise, and TeleNav and its suppliers and licensors hereby reserve all of their respective rights other than the licenses explicitly granted in this Agreement.

## 8.3

By using the TeleNav Software, you consent to receive from TeleNav all communications, including notices, agreements, legally required disclosures or other information in connection with the TeleNav Software (collectively, "Notices") electronically. TeleNav may provide such Notices by posting them on TeleNav's Website or by downloading such Notices to your wireless device. If you desire to withdraw your consent to receive Notices electronically, you must discontinue your use of the TeleNav Software.

## 8.4

TeleNav's or your failure to require performance of any provision shall not affect that party's right to require performance at any time thereafter, nor shall a waiver of any breach or default of this Agreement constitute a waiver of any subsequent breach or default or a waiver of the provision itself.

## 8.5

If any provision herein is held unenforceable, then such provision will be modified to reflect the intention of the parties, and the remaining provisions of this Agreement will remain in full force and effect.

## 8.6

The headings in this Agreement are for convenience of reference only, will not be deemed to be a part of this Agreement, and will not be referred to in connection with the construction or interpretation of this Agreement. As used in this Agreement, the words "include" and "including" and variations thereof, will not be deemed to be terms of limitation, but rather will be deemed to be followed by the words "without limitation".

## 9. Other Vendors Terms and Conditions

- The Telenav Software utilizes map and other data licensed to Telenav by third party vendors for the benefit of you and other end users. This Agreement includes end-user terms applicable to these companies (included at the end of this Agreement), and thus your use of the Telenav Software is also subject to such terms. You agree to comply with the following additional terms and conditions, which are applicable to Telenav's third party vendor licensors.

## 9.1 End User Terms Required by HERE North America, LLC

The data ("Data") is provided for your personal, internal use only and not for resale. It is protected by copyright, and is subject to the following terms and conditions which are agreed to by you, on the one hand, and Telenav ("Telenav") and its licensors (including their licensors and suppliers) on the other hand.

© 2013 HERE. All rights reserved.

The Data for areas of Canada includes information taken with permission from Canadian authorities, including: © Her Majesty the Queen in Right of Canada, © Queen's Printer for Ontario, © Canada Post Corporation, GeoBase®, © Department of Natural Resources Canada.



# Customer Information

---

HERE holds a non-exclusive license from the United States Postal Service® to publish and sell ZIP+4® information.

©United States Postal Service® 2014. Prices are not established, controlled or approved by the United States Postal Service®. The following trademarks and registrations are owned by the USPS: United States Postal Service, USPS, and ZIP+4

The Data for Mexico includes certain data from Instituto Nacional de Estadística y Geografía.

## **9.2 End User Terms Required by NAV2 (Shanghai) Co., Ltd**

The data (“Data”) is provided for your personal, internal use only and not for resale. It is protected by copyright, and is subject to the following terms and conditions which are agreed to by you, on the one hand, and NAV2 (Shanghai) Co., Ltd (“NAV2”) and its licensors (including their licensors and suppliers) on the other hand. 20xx. All rights reserved

### **Terms and Conditions**

**Permitted Use.** You agree to use this Data together with the Telenav Software solely for the internal business and personal purposes for which you were licensed, and not for service bureau, time-sharing or other similar purposes. Accordingly, but subject to the restrictions set forth in the following paragraphs, you agree not to otherwise reproduce, copy, modify, decompile, disassemble, create any derivative works of, or reverse engineer any portion of this Data, and may not transfer or distribute it in any form, for any purpose, except to the extent permitted by mandatory laws.

**Restrictions.** Except where you have been specifically licensed to do so by Telenav, and without limiting the preceding paragraph, you may not use this Data (a) with any products, systems, or applications installed or otherwise connected to or in communication with vehicles, capable of vehicle navigation, positioning, dispatch, real time route guidance, fleet management or similar applications; or (b) with or in communication with any positioning devices or any mobile or wireless-connected electronic or computer devices, including without limitation cellular phones, palmtop and handheld computers, pagers, and personal digital assistants or PDAs.

**Warning.** The Data may contain inaccurate or incomplete information due to the passage of time, changing circumstances, sources used and the nature of collecting comprehensive geographic data, any of which may lead to incorrect results.

**No Warranty.** This Data is provided to you “as is,” and you agree to use it at your own risk. Telenav and its licensors (and their licensors and suppliers) make no guarantees, representations or warranties of any kind, express or implied, arising by law or otherwise, including but not limited to, content, quality, accuracy, completeness, effectiveness, reliability, fitness for a particular purpose, usefulness, use or results to be obtained from this Data, or that the Data or server will be uninterrupted or error-free.

**Disclaimer of Warranty:** TELENAV AND ITS LICENSORS (INCLUDING THEIR LICENSORS AND SUPPLIERS) DISCLAIM ANY WARRANTIES, EXPRESS OR IMPLIED, OF QUALITY, PERFORMANCE, MERCHANTABILITY, FITNESS FOR A

## Customer Information

---

PARTICULAR PURPOSE OR NON-INFRINGEMENT. Some States, Territories and Countries do not allow certain warranty exclusions, so to that extent the above exclusion may not apply to you.

**Disclaimer of Liability:** TELENAV AND ITS LICENSORS (INCLUDING THEIR LICENSORS AND SUPPLIERS) SHALL NOT BE LIABLE TO YOU: IN RESPECT OF ANY CLAIM, DEMAND OR ACTION, IRRESPECTIVE OF THE NATURE OF THE CAUSE OF THE CLAIM, DEMAND OR ACTION ALLEGING ANY LOSS, INJURY OR DAMAGES, DIRECT OR INDIRECT, WHICH MAY RESULT FROM THE USE OR POSSESSION OF THE INFORMATION; OR FOR ANY LOSS OF PROFIT, REVENUE, CONTRACTS OR SAVINGS, OR ANY OTHER DIRECT, INDIRECT, INCIDENTAL, SPECIAL OR CONSEQUENTIAL DAMAGES ARISING OUT OF YOUR USE OF OR INABILITY TO USE THIS INFORMATION, ANY DEFECT IN THE INFORMATION, OR THE BREACH OF THESE TERMS OR CONDITIONS, WHETHER IN AN ACTION IN CONTRACT OR TORT OR BASED ON A WARRANTY, EVEN IF TELENAV OR ITS LICENSORS HAVE BEEN ADVISED OF THE POSSIBILITY OF SUCH DAMAGES. Some States, Territories and Countries do not allow certain liability exclusions or damages limitations, so to that extent the above may not apply to you.

**Export Control.** You shall not export from anywhere any part of the Data or any direct product thereof except in compliance with, and with all licenses and approvals required under, applicable export laws, rules and regulations, including but not limited to the laws, rules and regulations administered by the Office of Foreign Assets Control of the U.S. Department of Commerce and the Bureau of Industry and Security of the U.S. Department of Commerce. To the extent that any such

export laws, rules or regulations prohibit HERE from complying with any of its obligations hereunder to deliver or distribute Data, such failure shall be excused and shall not constitute a breach of this Agreement.

**Entire Agreement.** These terms and conditions constitute the entire agreement between Telenav (and its licensors, including their licensors and suppliers) and you pertaining to the subject matter hereof, and supersedes in their entirety any and all written or oral agreements previously existing between us with respect to such subject matter.

**Governing Law.** The above terms and conditions shall be governed by the laws of the State of Illinois [insert "Netherlands" where European HERE Data is used], without giving effect to (i) its conflict of laws provisions, or (ii) the United Nations Convention for Contracts for the International Sale of Goods, which is explicitly excluded. You agree to submit to the jurisdiction of the State of Illinois [insert "The Netherlands" where European HERE Data is used] for any and all disputes, claims and actions arising from or in connection with the Data provided to you hereunder.

**Government End Users.** If the Data is being acquired by or on behalf of the United States government or any other entity seeking or applying rights similar to those customarily claimed by the United States government, this Data is a "commercial item" as that term is defined at 48 C.F.R. ("FAR") 2.101, is licensed in accordance with these End-User Terms, and each copy of Data delivered or otherwise furnished shall be marked and embedded as appropriate with the following "Notice of Use," and shall be treated in accordance with such Notice:

# Customer Information

## NOTICE OF USE

CONTRACTOR (MANUFACTURER/  
SUPPLIER) NAME: HERE

CONTRACTOR (MANUFACTURER/  
SUPPLIER) ADDRESS: c/o Nokia, 425  
West Randolph Street, Chicago, Illinois  
60606

This Data is a commercial item as  
defined in FAR 2.101 and is subject to  
these End-User Terms under which this  
Data was provided.

© 1987 – 2014 HERE – All rights reserved.

If the Contracting Officer, federal government agency, or any federal official refuses to use the legend provided herein, the Contracting Officer, federal government agency, or any federal official must notify HERE prior to seeking additional or alternative rights in the Data.

### I. US/Canada Territory

A. United States Data. The End-User Terms for any Application containing Data for the United States shall contain the following notices:

“HERE holds a non-exclusive license from the United States Postal Service® to publish and sell ZIP+4® information.”

“©United States Postal Service® 20XX. Prices are not established, controlled or approved by the United States Postal Service®. The following trademarks and registrations are owned by the USPS: United States Postal Service, USPS, and ZIP+4.”

B. Canada Data. The following provisions apply to the Data for Canada, which may include or reflect data from third party licensors (“Third Party Data”), including Her Majesty the Queen in Right of Canada (“Her Majesty”), Canada Post Corporation (“Canada Post”) and the Department of Natural Resources of Canada (“NRCan”):

1. Disclaimer and Limitation: Client agrees that its use of the Third Party Data is subject to the following provisions:

a. Disclaimer: The Third Party Data is licensed on an “as is” basis. The licensors of such data, including Her Majesty, Canada Post and NRCan, make no guarantees, representations or warranties respecting such data, either express or implied, arising by law or otherwise, including but not limited to, effectiveness, completeness, accuracy or fitness for a particular purpose.

b. Limitation on Liability: The Third Party Data licensors, including Her Majesty, Canada Post and NRCan, shall not be liable: (i) in respect of any claim, demand or action, irrespective of the nature of the cause of the claim, demand or action alleging any loss, injury or damages, direct or indirect, which may result from the use or possession of such Data; or (ii) in any way for loss of revenues or contracts, or any other consequential loss of any kind resulting from any defect in the Data.

# Customer Information

---

2. Copyright Notice: In connection with each copy of all or any portion of the Data for the Territory of Canada, Client shall affix in a conspicuous manner the following copyright notice on at least one of: (i) the label for the storage media of the copy; (ii) the packaging for the copy; or (iii) other materials packaged with the copy, such as user manuals or end user license agreements: "This data includes information taken with permission from Canadian authorities, including © Her Majesty the Queen in Right of Canada, © Queen's Printer for Ontario, © Canada Post Corporation, GeoBase®, © The Department of Natural Resources Canada. All rights reserved."

3. End-User Terms: Except as otherwise agreed by the parties, in connection with the provision of any portion of the Data for the Territory of Canada to End-Users as may be authorized under the Agreement, Client shall provide such End-Users, in a reasonably conspicuous manner, with terms (set forth with other end user terms required to be provided under the Agreement, or as otherwise may be provided, by Client) which shall include the following provisions on behalf of the Third Party Data licensors, including Her Majesty, Canada Post and NRCan:

The Data may include or reflect data of licensors, including Her Majesty the Queen in the Right of Canada ("Her Majesty"), Canada Post Corporation ("Canada Post") and the Department of Natural Resources Canada ("NRCan"). Such data is licensed on an "as is" basis. The licensors, including Her Majesty, Canada Post and NRCan, make no guarantees, representations or warranties respecting such data,

either express or implied, arising by law or otherwise, including but not limited to, effectiveness, completeness, accuracy or fitness for a particular purpose. The licensors, including Her Majesty, Canada Post and NRCan, shall not be liable in respect of any claim, demand or action, irrespective of the nature of the cause of the claim, demand or action alleging any loss, injury or damages, direct or indirect, which may result from the use or possession of the data or the Data. The licensors, including Her Majesty, Canada Post and NRCan, shall not be liable in any way for loss of revenues or contracts, or any other consequential loss of any kind resulting from any defect in the data or the Data.

End User shall indemnify and save harmless the licensors, including Her Majesty, Canada Post and NRCan, and their officers, employees and agents from and against any claim, demand or action, irrespective of the nature of the cause of the claim, demand or action, alleging loss, costs, expenses, damages or injuries (including injuries resulting in death) arising out of the use or possession of the data or the Data.

4. Additional Provisions: The terms contained in this Section are in addition to all of the rights and obligations of the parties under the Agreement. To the extent that any of the provisions of this Section are inconsistent with, or conflict with, any other provisions of the Agreement, the provisions of this Section shall prevail.

# Customer Information

II. Mexico. The following provision applies to the Data for Mexico, which includes certain data from the Instituto Nacional de Estadística y Geografía (“INEGI”):

A. Any and all copies of the Data and/or packaging containing Data for Mexico shall contain the following notice: “Fuente: INEGI (Instituto Nacional de Estadística y Geografía)”

### III. Latin America Territory

A. Third Party Notices. Any and all copies of the Data and/or packaging relating thereto shall include the respective Third Party Notices set forth below and used as described below corresponding to the Territory (or portion thereof) included in such copy:

Territory Notice

Argentina	IGN “INSTITUTO GEOGRAFICO NACIONAL ARGENTINO”
Ecuador	“INSTITUTO GEOGRAFICO MILITAR DEL ECUADOR AUTORIZACION N° IGM-2011-01- PCO-01 DEL 25 DE ENERO DE 2011” “source: © IGN 2009 - BD TOPO ®”
Guadeloupe, French Guiana and Martinique Mexico	“Fuente: INEGI (Instituto Nacional de Estadística y Geografía)”

### IV. Middle East Territory

A. Third Party Notices. Any and all copies of the Data and/or packaging relating thereto shall include the respective Third Party Notices set forth below and used as described below corresponding to the Territory (or portion thereof) included in such copy:

Country Notice

Jordan	“© Royal Jordanian Geographic Centre”. The foregoing notice requirement for Jordan Data is a material term of the Agreement. If Client or any of its permitted sublicensees (if any) fail to meet such requirement, HERE shall have the right to terminate Client’s license with respect to the Jordan Data.
--------	--

B. Jordan Data. Client and its permitted sublicensees (if any) are restricted from licensing and/or otherwise distributing HERE’s database for the country of Jordan (“Jordan Data”) for use in Enterprise Applications to (i) non-Jordanian entities for use of the Jordan Data solely in Jordan or (ii) Jordan-based customers. In addition, Client, its permitted sublicensees (if any) and End-Users are restricted from using the Jordan Data in Enterprise Applications if such party is (i) a non-Jordanian entity using the Jordan Data solely in Jordan or (ii) a Jordan-based customer. For purposes of the foregoing, “Enterprise Applications” shall mean Geomarketing applications, GIS applications, mobile business asset management applications, call center applications, telematics applications, public organization Internet applications or for providing geocoding services.

# Customer Information

---

## V. Europe Territory

### A. Use of Certain Traffic Codes in Europe

1. General Restrictions Applicable to Traffic Codes. Client acknowledges and agrees that in certain countries of the Europe Territory, Client will need to obtain rights directly from third party RDS-TMC code providers to receive and use the Traffic Codes in the Data and to deliver to End-Users Transactions in any way derived from or based on such Traffic Codes. For such countries, HERE shall deliver the Data incorporating Traffic Codes to Client only after receiving certification from Client of its having obtained such rights.

2. Display of Third Party Rights Legends for Belgium. Client shall, for each Transaction that uses Traffic Codes for Belgium, provide the following notice to the End-User: "Traffic Codes for Belgium are provided by the Ministerie van de Vlaamse Gemeenschap and the Ministère de l'Équipement et des Transports."

B. Paper Maps. With respect to any license granted to Client relating to making, selling or distributing paper maps (i.e., a map fixed on a paper or paper-like medium): (a) such license with respect to Data for the Territory of Great Britain is conditioned on Client's entering into and complying with a separate written agreement with the Ordnance Survey ("OS") to create and sell paper maps, Client's paying to the OS any and all applicable paper map royalties, and Client's complying with the OS copyright notice requirements; (b) such license for selling or otherwise distributing for charge with respect to Data for the Territory of Czech Republic

is conditioned on Client's obtaining prior written consent from Kartografie a.s.; (c) such license for selling or distributing with respect to Data for the Territory of Switzerland is conditioned on Client's obtaining a permit from Bundesamt für Landestopografie of Switzerland; (d) Client is restricted from using Data for the Territory of France to create paper maps with a scale between 1:5,000 and 1:250,000; and (e) Client is restricted from using any Data to create, sell or distribute paper maps that are the same or substantially similar, in terms of data content and specific use of color, symbols and scale, to paper maps published by the European national mapping agencies, including without limitation, Landvermessungämter of Germany, Topografische Dienst of the Netherlands, Nationaal Geografisch Instituut of Belgium, Bundesamt für Landestopografie of Switzerland, Bundesamt für Eich-und Vermessungswesen of Austria, and the National Land Survey of Sweden.

C. OS Enforcement. Without limiting Section IV(B) above, with respect to Data for the Territory of Great Britain, Client acknowledges and agrees that the Ordnance Survey ("OS") may bring a direct action against Client to enforce compliance with the OS copyright notice (see Section IV(D) below) and paper map requirements (see Section IV(B) above) contained in this Agreement.

D. Third Party Notices. Any and all copies of the Data and/or packaging relating thereto shall include the respective Third Party Notices set forth below and used as described below corresponding to the Territory (or portion thereof) included in such copy:

Country(ies) Notice

## Customer Information

Austria	“© Bundesamt für Eich- und Vermessungswesen”	Spain	“Información geográfica propiedad del CNIG”
Croatia Cyprus, Estonia, Latvia, Lithuania, Moldova, Poland, Slovenia and/or Ukraine	“© EuroGeographics”	Sweden	“Based upon electronic data © National Land Survey Sweden.”
France	“source: © IGN 2009 – BD TOPO ®”	Switzerland	“Topografische Grundlage: © Bundesamt für Landestopographie.
Germany	“Die Grundlagendaten wurden mit Genehmigung der zuständigen Behörden entnommen”	E. Respective Country Distribution. Client acknowledges that HERE has not received approvals to distribute map data for the following countries in such respective countries: Albania, Belarus, Kyrgyzstan, Moldova and Uzbekistan. HERE may update such list from time to time. The license rights granted to Client under this TL with respect to the Data for such countries are contingent upon Client’s compliance with all applicable laws and regulations, including, without limitation, any required licenses or approvals to distribute the Application incorporating such Data in such respective countries.	
Great Britain	“Contains Ordnance Survey data © Crown copyright and database right 2010 Contains Royal Mail data © Royal Mail copyright and database right 2010”	VI. Australia Territory	A. Third Party Notices. Any and all copies of the Data and/or packaging relating thereto shall include the respective Third Party Notices set forth below and used as described below corresponding to the Territory (or portion thereof) included in such copy:  Copyright. Based on data provided under license from PSMA Australia Limited (www.pasma.com.au).
Greece	“Copyright Geomatics Ltd.”		
Hungary	“Copyright © 2003; Top-Map Ltd.”		
Italy	“La Banca Dati Italiana è stata prodotta usando quale riferimento anche cartografia numerica ed al tratto prodotta e fornita dalla Regione Toscana.”		
Norway	“Copyright © 2000; Norwegian Mapping Authority”		
Portugal	“Source: IgeoE – Portugal”		

# Customer Information

---

Product incorporates data which is © 20XX Telstra Corporation Limited, GM Holden Limited, Intelomatics Australia Pty Ltd and Continental Pty Ltd.

B. Third Party Notices for Australia. In addition to the foregoing, the End-User Terms for any Application containing RDS-TMC Traffic Codes for Australia shall contain the following notice: “Product incorporates traffic location codes which is © 20XX Telstra Corporation Limited and its licensors.”

## **AT&T Vehicle Network Carrier Telematics Disclosure**

END USER FOR PURPOSES OF THIS SECTION MEANS YOU AND YOUR HEIRS, EXECUTORS, LEGAL PERSONAL REPRESENTATIVES AND PERMITTED ASSIGNS. FOR PURPOSES OF THIS SECTION “UNDERLYING WIRELESS SERVICE CARRIER” INCLUDES ITS AFFILIATES AND CONTRACTORS AND THEIR RESPECTIVE OFFICERS, DIRECTORS, EMPLOYEES, SUCCESSORS AND ASSIGNS. END USER HAS NO CONTRACTUAL RELATIONSHIP WITH THE UNDERLYING WIRELESS SERVICE CARRIER AND END USER IS NOT A THIRD PARTY BENEFICIARY OF ANY AGREEMENT BETWEEN FORD AND UNDERLYING CARRIER. END USER UNDERSTANDS AND AGREES THAT THE UNDERLYING CARRIER HAS NO LEGAL, EQUITABLE, OR OTHER LIABILITY OF ANY KIND TO END USER. IN ANY EVENT, REGARDLESS OF THE FORM OF THE ACTION, WHETHER FOR BREACH OF CONTRACT, WARRANTY, NEGLIGENCE, STRICT LIABILITY IN TORT OR OTHERWISE, END USER’S EXCLUSIVE REMEDY FOR CLAIMS ARISING IN ANY WAY IN CONNECTION WITH THIS AGREEMENT, FOR ANY CAUSE WHATSOEVER, INCLUDING BUT NOT LIMITED TO ANY FAILURE OR

DISRUPTION OF SERVICE PROVIDED HEREUNDER, IS LIMITED TO PAYMENT OF DAMAGES IN AN AMOUNT NOT TO EXCEED THE AMOUNT PAID BY END USER FOR THE SERVICES DURING THE TWO-MONTH PERIOD PRECEDING THE DATE THE CLAIM AROSE.

(ii) END USER AGREES TO INDEMNIFY AND HOLD HARMLESS THE UNDERLYING WIRELESS SERVICE CARRIER AND ITS OFFICERS, EMPLOYEES, AND AGENTS AGAINST ANY AND ALL CLAIMS, INCLUDING WITHOUT LIMITATION CLAIMS FOR LIBEL, SLANDER, OR ANY PROPERTY DAMAGE, PERSONAL INJURY OR DEATH, ARISING IN ANY WAY, DIRECTLY OR INDIRECTLY, IN CONNECTION WITH THIS AGREEMENT OR THE USE, FAILURE TO USE, OR INABILITY TO USE THE DEVICE EXCEPT WHERE THE CLAIMS RESULT FROM THE UNDERLYING CARRIER’S GROSS NEGLIGENCE OR WILLFUL MISCONDUCT. THIS INDEMNITY WILL SURVIVE THE TERMINATION OF THE AGREEMENT.

(iii) END USER HAS NO PROPERTY RIGHT IN ANY NUMBER ASSIGNED TO THE DEVICE.

(iv) END USER UNDERSTANDS THAT FORD AND THE UNDERLYING CARRIER CANNOT GUARANTY THE SECURITY OF WIRELESS TRANSMISSIONS, AND WILL NOT BE LIABLE FOR ANY LACK OF SECURITY RELATING TO THE USE OF THE SERVICES

THE SERVICE IS FOR [END USER’S] USE ONLY AND END USER MAY NOT RESELL THE SERVICE TO ANY OTHER PARTY END USER UNDERSTANDS THAT THE UNDERLYING CARRIER DOES NOT GUARANTEE ANY END USER UNINTERRUPTED SERVICE OR COVERAGE. THE UNDERLYING CARRIER DOES NOT WARRANT THAT END USERS CAN OR WILL BE LOCATED USING THE SERVICE. THE UNDERLYING CARRIER



# Customer Information

---

MAKES NO WARRANTY, EXPRESS OR IMPLIED, OF MERCHANTABILITY OR FITNESS FOR A PARTICULAR PURPOSE, SUITABILITY, OR PERFORMANCE REGARDING ANY SERVICES OR GOODS, AND IN NO EVENT SHALL AT&T BE LIABLE, WHETHER OR NOT DUE TO ITS OWN NEGLIGENCE, FOR ANY: (A) ACT OR OMISSION OF A THIRD PARTY; (B) MISTAKES, OMISSIONS, INTERRUPTIONS, ERRORS, FAILURES TO TRANSMIT, DELAYS, OR DEFECTS IN THE SERVICE PROVIDED BY OR THROUGH THE UNDERLYING CARRIER; (C) DAMAGE OR INJURY CAUSED BY SUSPENSION OR TERMINATION BY THE UNDERLYING CARRIER; OR (D) DAMAGE OR INJURY CAUSED BY A FAILURE OR DELAY IN CONNECTING A CALL TO ANY ENTITY, INCLUDING 911 OR ANY OTHER EMERGENCY SERVICE. TO THE FULL EXTENT ALLOWED BY LAW, THE END USER RELEASES, INDEMNIFIES AND HOLDS THE UNDERLYING CARRIER HARMLESS FROM AND AGAINST ANY AND ALL CLAIMS OF ANY PERSON OR ENTITY FOR DAMAGES OF ANY NATURE ARISING IN ANY WAY FROM OR RELATING TO, DIRECTLY OR INDIRECTLY, SERVICES PROVIDED BY THE UNDERLYING CARRIER OR ANY PERSON'S USE THEREOF, INCLUDING CLAIMS ARISING IN WHOLE OR IN PART FROM THE ALLEGED NEGLIGENCE OF THE UNDERLYING CARRIER.

## **VII. China Territory**

### ***Personal Use Only***

You agree to use this Data together with [insert name of Client Application] for the solely personal, non-commercial purposes for which you were licensed, and not for service bureau, time-sharing or other similar purposes. Accordingly, but subject to the restrictions set forth in the following paragraphs, you may copy this Data only as necessary for your personal use to (i)

view it, and (ii) save it, provided that you do not remove any copyright notices that appear and do not modify the Data in any way. You agree not to otherwise reproduce, copy, modify, decompile, disassemble or reverse engineer any portion of this Data, and may not transfer or distribute it in any form, for any purpose, except to the extent permitted by mandatory laws.

### ***Restrictions***

Except where you have been specifically licensed to do so by NAV2, and without limiting the preceding paragraph, you may not (a) use this Data with any products, systems, or applications installed or otherwise connected to or in communication with vehicles, capable of vehicle navigation, positioning, dispatch, real time route guidance, fleet management or similar applications; or (b) with or in communication with any positioning devices or any mobile or wireless-connected electronic or computer devices, including without limitation cellular phones, palmtop and handheld computers, pagers, and personal digital assistants or PDAs. You agree to cease using this Data if you fail to comply with these terms and conditions.

### ***Limited Warranty***

NAV2 warrants that (a) the Data will perform substantially in accordance with the accompanying written materials for a period of ninety (90) days from the date of receipt, and (b) any support services provided by NAV2 shall be substantially as described in applicable written materials provided to you by NAV2, and NAV2's support engineers will make commercially reasonable efforts to solve any problem issues.

# Customer Information

---

## **Customer Remedies**

NAV2 and its suppliers' entire liability and your exclusive remedy shall be, at NAV2's sole discretion, either (a) return of the price paid, if any, or (b) repair or replacement of the Data that do not meet NAV2's Limited Warranty and that are returned to NAV2 with a copy of your receipt. This Limited Warranty is void if failure of the Data has resulted from accident, abuse, or misapplication. Any replacement Data will be warranted for the remainder of the original warranty period or thirty (30) days, whichever is longer. Neither these remedies nor any product support services offered by NAV2 are available without proof of purchase from an authorized international source.

## **No Other Warranty:**

EXCEPT FOR THE LIMITED WARRANTY SET FORTH ABOVE AND TO THE EXTENT PERMITTED BY APPLICABLE LAW, NAV2 AND ITS LICENSORS (INCLUDING THEIR LICENSORS AND SUPPLIERS) DISCLAIM ANY WARRANTIES, EXPRESS OR IMPLIED, OF QUALITY, PERFORMANCE, MERCHANTABILITY, FITNESS FOR A PARTICULAR PURPOSE, OWNERSHIP OR NON-INFRINGEMENT. Certain warranty exclusions may not be permitted under applicable law, so to that extent the above exclusion may not apply to you.

## **Limited Liability:**

TO THE EXTENT PERMITTED BY APPLICABLE LAW, NAV2 AND ITS LICENSORS (INCLUDING THEIR LICENSORS AND SUPPLIERS) SHALL NOT BE LIABLE TO YOU: IN RESPECT OF ANY CLAIM, DEMAND OR ACTION, IRRESPECTIVE OF THE NATURE OF THE CAUSE OF THE CLAIM, DEMAND OR ACTION ALLEGING ANY LOSS, INJURY OR DAMAGES, DIRECT OR INDIRECT, WHICH MAY RESULT FROM THE USE OR POSSESSION OF THE INFORMATION; OR

FOR ANY LOSS OF PROFIT, REVENUE, CONTRACTS OR SAVINGS, OR ANY OTHER DIRECT, INDIRECT, INCIDENTAL, SPECIAL OR CONSEQUENTIAL DAMAGES ARISING OUT OF YOUR USE OF OR INABILITY TO USE THIS INFORMATION, ANY DEFECT IN THE INFORMATION, OR THE BREACH OF THESE TERMS OR CONDITIONS, WHETHER IN AN ACTION IN CONTRACT OR TORT OR BASED ON A WARRANTY, EVEN IF NAV2 OR ITS LICENSORS HAVE BEEN ADVISED OF THE POSSIBILITY OF SUCH DAMAGES. UNDER NO CIRCUMSTANCES SHALL NAV2'S OR ITS SUPPLIERS' LIABILITY HEREUNDER EXCEED THE PRICE PAID. Certain liability exclusions may not be permitted under applicable law, so to that extent the above exclusion may not apply to you.

## **Export Control**

You agree not to export to anywhere any part of the Data provided to you or any direct product thereof except in compliance with, and with all licenses and approvals required under, applicable export laws, rules and regulations.

## **IP Protection**

The Data are owned by NAV2 or its suppliers and are protected by applicable copyright and other intellectual property law and treaties. The Data are provided solely on the basis of a license to use, not sale.

## **Entire Agreement**

These terms and conditions constitute the entire agreement between NAV2 (and its licensors, including their licensors and suppliers) and you pertaining to the subject matter hereof, and supersedes in their entirety any and all written or oral agreements previously existing between us with respect to such subject matter.

# Customer Information

---

## **Governing Law.**

The above terms and conditions shall be governed by the laws of the People's Republic of China, without giving effect to (i) its conflict of laws provisions, or (ii) the United Nations Convention for Contracts for the International Sale of Goods, which is explicitly excluded. Any dispute arising from or in connection with the Data provided to you hereunder shall be submitted to the Shanghai International Economic and Trade Arbitration Commission for arbitration.

## **Gracenote® Copyright**

CD and music-related data from Gracenote, Inc., copyright©

2000-2007 Gracenote. Gracenote Software, copyright © 2000-2007 Gracenote. This product and service may practice one or more of the following U.S. Patents 5,987,525; 6,061,680; 6,154,773; 6,161,132; 6,230,192; 6,230,207; 6,240,459; 6,330,593 and other patents issued or pending. Some services supplied under license from Open Globe, Inc. for U.S. Patent 6,304,523.

Gracenote and CDDDB are registered trademarks of Gracenote. The Gracenote logo and logotype, and the "Powered by Gracenote™" logo are trademarks of Gracenote.

## **Gracenote® End User License Agreement (EULA)**

This device contains software from Gracenote, Inc. of 2000 Powell Street Emeryville, California 94608 ("Gracenote").

The software from Gracenote (the "Gracenote Software") enables this device to do disc and music file identification and obtain music-related information, including name, artist, track, and title information ("Gracenote Data") from online servers

("Gracenote Servers"), and to perform other functions. You may use Gracenote Data only by means of the intended End User functions of this device. This device may contain content belonging to Gracenote's providers. If so, all of the restrictions set forth herein with respect to Gracenote Data shall also apply to such content and such content providers shall be entitled to all of the benefits and protections set forth herein that are available to Gracenote. You agree that you will use the content from Gracenote ("Gracenote Content"), Gracenote Data, the Gracenote Software, and Gracenote Servers for your own personal, non-commercial use only. You agree not to assign, copy, transfer or transmit the Gracenote Content, Gracenote Software or any Gracenote Data (except in a Tag associated with a music file) to any third party. YOU AGREE NOT TO USE OR EXPLOIT GRACENOTE CONTENT, GRACENOTE DATA, THE GRACENOTE SOFTWARE, OR GRACENOTE SERVERS, EXCEPT AS EXPRESSLY PERMITTED HEREIN.

You agree that your non-exclusive licenses to use the Gracenote Content, Gracenote Data, the Gracenote Software, and Gracenote Servers will terminate if you violate these restrictions. If your licenses terminate, you agree to cease any and all use of the Gracenote Content, Gracenote Data, the Gracenote Software, and Gracenote Servers.

Gracenote, respectively, reserve all rights in Gracenote Data, the Gracenote Software, and the Gracenote Servers and Gracenote Content, including all ownership rights. Under no circumstances will either Gracenote become liable for any payment to you for any information that you provide,

## Customer Information

---

including any copyrighted material or music file information. You agree that Gracenote may enforce its respective rights, collectively or separately, under this agreement against you, directly in each company's own name.

Gracenote uses a unique identifier to track queries for statistical purposes. The purpose of a randomly assigned numeric identifier is to allow Gracenote to count queries without knowing anything about who you are. For more information, see the web page at [www.gracenote.com](http://www.gracenote.com) for the Gracenote Privacy Policy.

THE GRACENOTE SOFTWARE, EACH ITEM OF GRACENOTE DATA AND THE GRACENOTE CONTENT ARE LICENSED TO YOU "AS IS". NEITHER GRACENOTE MAKES ANY REPRESENTATIONS OR WARRANTIES, EXPRESS OR IMPLIED, REGARDING THE ACCURACY OF ANY GRACENOTE DATA FROM THE GRACENOTE SERVERS OR GRACENOTE CONTENT. GRACENOTE COLLECTIVELY AND SEPARATELY RESERVE THE RIGHT TO DELETE DATA AND/OR CONTENT FROM THE COMPANIES' RESPECTIVE SERVERS OR, IN THE CASE OF GRACENOTE, CHANGE DATA CATEGORIES FOR ANY CAUSE THAT GRACENOTE DEEMS SUFFICIENT. NO WARRANTY IS MADE THAT EITHER GRACENOTE CONTENT OR THE GRACENOTE SOFTWARE OR GRACENOTE SERVERS ARE ERROR-FREE OR THAT THE FUNCTIONING OF THE GRACENOTE SOFTWARE OR GRACENOTE SERVERS WILL BE UNINTERRUPTED. GRACENOTE IS NOT OBLIGATED TO PROVIDE YOU WITH ANY ENHANCED OR ADDITIONAL DATA TYPES THAT GRACENOTE MAY CHOOSE TO PROVIDE IN THE FUTURE AND IS FREE TO DISCONTINUE ITS ONLINE SERVICES AT ANY TIME. GRACENOTE DISCLAIMS ALL WARRANTIES EXPRESS OR IMPLIED, INCLUDING, BUT NOT LIMITED TO,

IMPLIED WARRANTIES OF MERCHANTABILITY, FITNESS FOR A PARTICULAR PURPOSE, TITLE, AND NON-INFRINGEMENT. NEITHER GRACENOTE WARRANTS THE RESULTS THAT WILL BE OBTAINED BY YOUR USE OF THE GRACENOTE SOFTWARE OR ANY GRACENOTE SERVER. IN NO CASE WILL GRACENOTE BE LIABLE FOR ANY CONSEQUENTIAL OR INCIDENTAL DAMAGES OR FOR ANY LOST PROFITS OR LOST REVENUES FOR ANY REASON WHATSOEVER. © Gracenote 2007.

### ***Taiwan Territory***

Note: In accordance with the management approach of low-power radio wave radiation motors:

Article 12: For approved and certified low-power radiation motor models, companies, firms or users must not alter the frequency, increase the power or change the characteristics and functions of the original design without authorization.

Article 14: The usage of low-power radio-frequency motors must not affect aviation safety and interfere with legal telecommunications. Should interference be detected, immediately stop using the device and only resume usage after ensuring that there is no longer any interference. For the legal telecommunication and wireless telecommunication of the telco, the low-power radio frequency motor must be able to tolerate legal limits of interference from telecommunication, industrial, scientific and radio wave equipment.

# Customer Information

## SUNA TRAFFIC CHANNEL – TERMS AND CONDITIONS

By activating, using and/or accessing the SUNA Traffic Channel, SUNA Predictive or other content or material provided by Intelematics (together, **SUNA Products and/or Services**), you must accept certain terms and conditions. The following is a brief summary of the terms and conditions that apply to you. To view the full terms and conditions relevant to your use of the SUNA Products and/or Services, please consult:

Website
<a href="http://www.sunattraffic.com.au/termsandconditions/">www.sunattraffic.com.au/termsandconditions/</a>

### 1. Acceptance

By using SUNA Products and/or Services, you will be deemed to have accepted and agreed to be bound by the terms and conditions fully detailed at:

Website
<a href="http://www.sunattraffic.com.au/termsandconditions/">www.sunattraffic.com.au/termsandconditions/</a>

### 2. Intellectual Property

SUNA Products and/or Services are for your personal use. You may not record, or retransmit the content, nor use the content in association with any other traffic information or route guidance service or device not approved by Intelematics. You obtain no right of ownership in any Intellectual Property Rights (including copyright) in the data that is used to provide SUNA Products and/or Services.

### 3. Appropriate Use

SUNA Products and/or Services are intended as an aid to personal motoring and travel planning, and do not provide comprehensive or accurate information on all occasions. On occasions, you may experience additional delay as a result of using SUNA Products and/or Services. You acknowledge that it is not intended, or suitable, for use in applications where time of arrival or driving directions may impact the safety of the public or yourself.

### 4. Use of SUNA Products and Services while driving

You, and other authorized drivers of the vehicle in which SUNA Products and/or Services are available or installed and active, remain at all times responsible for observing all relevant laws and codes of safe driving. In particular, you agree to only actively operate SUNA Products and/or Services when the Vehicle is at a complete stop and it is safe to do so.

### 5. Service Continuity and Reception of the SUNA Traffic Channel

We will use reasonable endeavors to provide the SUNA Traffic Channel 24 hours a day, 365 days a year. The SUNA Traffic Channel may occasionally be unavailable for technical reasons or for planned maintenance. We will try to perform maintenance at times when congestion is light. We reserve the right to withdraw SUNA Products and/or Services at any time.

Also, we cannot assure the uninterrupted reception of the SUNA Traffic Channel RDS-TMC signal at any particular location.

### 6. Limitation of Liability

Neither Intelematics (nor its suppliers or the manufacturer of your device (the **"Suppliers"**)) shall be liable to you or to any third party for any damages either direct, indirect, incidental, consequential or otherwise arising out of the use of or inability to use SUNA Products and/or

# Customer Information

---

Services even if Intelematics or a Supplier has been advised of the possibility of such damages. You also acknowledge that the neither Intelematics nor any Supplier guarantees nor make any warranties that relate to the availability, accuracy or completeness of SUNA Products and/or Services, and to the extent which it is lawful to do so, both Intelematics and each Supplier excludes any warranties which might otherwise be implied by any State or Federal legislation in relation to SUNA Products and/or Services.

## 7. Please Note

Great care has been taken in preparing this manual. Constant product development may mean that some information is not entirely up-to-date. The information in this document is subject to change without notice.

## EXPORT UNIQUE OPTIONS

For your particular global region, your vehicle may be equipped with features and options that are different from the features and options that are described in this Owner's Manual. A market unique supplement may be supplied that complements this book. By referring to the market unique supplement, if provided, you can properly identify those features, recommendations and specifications that are unique to your vehicle. This Owner's Manual is written primarily for the U.S. and Canadian markets. Features or equipment listed as standard may be different on units built for export. **Refer to this Owner's Manual for all other required information and warnings.**

# Appendices

## ELECTROMAGNETIC COMPATIBILITY



**WARNING:** Do not place objects or mount equipment on or near the airbag cover, on the side of the front or rear seatbacks, or in areas that may come into contact with a deploying airbag. Failure to follow these instructions may increase the risk of personal injury in the event of a crash.



**WARNING:** Do not fasten antenna cables to vehicle wiring, fuel pipes and brake pipes.



**WARNING:** Keep antenna and power cables at least 4 in (10 cm) from any electronic modules and airbags.

**Note:** We test and certify your vehicle to meet electromagnetic compatibility legislation. It is your responsibility to make sure that any equipment an authorized dealer installs on your vehicle complies with applicable local legislation and other requirements. Installation of some aftermarket electronic devices could degrade the performance of vehicle functions, which use radio frequency signals such as broadcast radio receiver, tire pressure monitoring system, push button start, **Bluetooth®** connectivity or satellite navigation.

**Note:** Any radio frequency transmitter equipment in your vehicle (such as cellular telephones and amateur radio transmitters) must keep to the parameters in the following illustrations and table. We do not provide any other special provisions or conditions for installations or use.

### Car

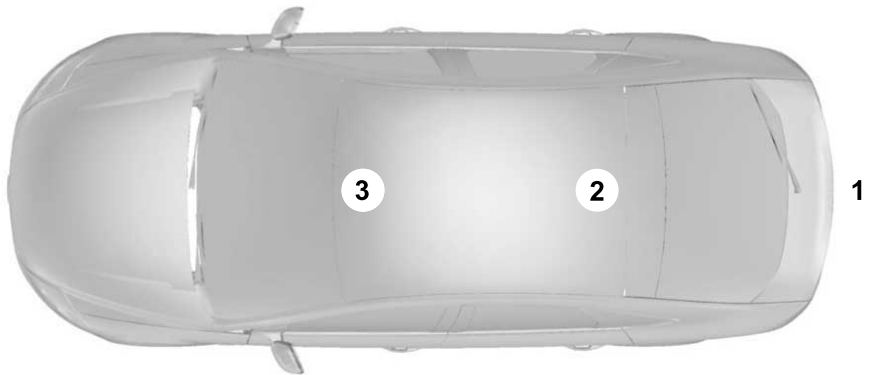

# Appendices

---

## Van

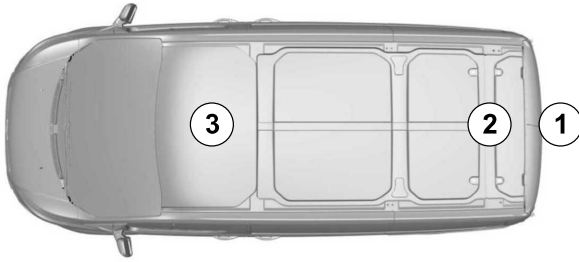

## Truck

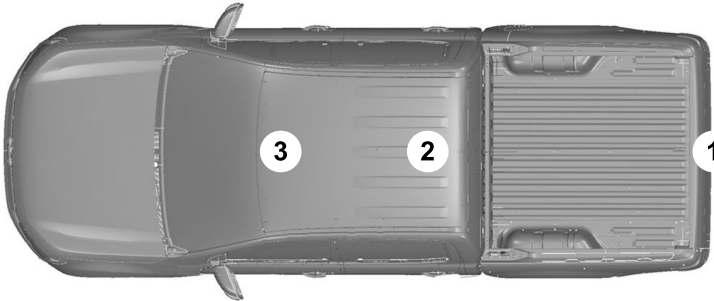



# Appendices

---

Frequency Band MHz	Maximum Output Power Watt (Peak RMS)	Antenna Positions
1-30	50	1
50-54	50	2, 3
68-88	50	2, 3
142-176	50	2, 3
380-512	50	2, 3
806-870	10	2, 3

**Note:** After the installation of radio frequency transmitters, check for disturbances from and to all electrical equipment in your vehicle, both in the standby and transmit modes.

Check all electrical equipment:

- With the ignition ON.
- With the vehicle running.
- During a road test at various speeds.

Check that electromagnetic fields generated inside your vehicle cabin by the transmitter installed do not exceed applicable human exposure requirements.



# Index

## 1

12V Battery.....	308
Changing the 12V Battery.....	308
Charging the 12V Battery.....	308
12V Battery – Troubleshooting.....	308
12V Battery – Information Messages.....	309
12V Battery – Warning Lamps.....	308

## 3

360 Degree Camera.....	214
360 Degree Camera Settings.....	216
360 Degree Camera Guide Lines.....	215
360 Degree Camera Limitations.....	214
360 Degree Camera Precautions.....	214
360 Degree Camera Settings.....	216
Switching the 360 Degree Camera On and Off.....	216
Switching the 360 Degree Camera View.....	216

## 9

911 Assist.....	63
-----------------	----

## A

### A/C

See: Climate Control.....	128
---------------------------	-----

About This Publication.....	17
-----------------------------	----

### ABS

See: Brakes.....	186
------------------	-----

Accessing Apps.....	379
---------------------	-----

Accessing Feature Drawers.....	370
--------------------------------	-----

Accessing Navigation.....	385
---------------------------	-----

Accessing the Passive Key Backup Position.....	156
--	-----

Accessing the Trip Computer.....	125
----------------------------------	-----

Accessories.....	389
------------------	-----

AC Charging.....	169
------------------	-----

Connecting the Charger.....	169
-----------------------------	-----

Stopping Charging.....	171
------------------------	-----

Active Park Assist.....	217
-------------------------	-----

Active Park Assist – Troubleshooting.....	219
---	-----

Active Park Assist Precautions.....	217
-------------------------------------	-----

Active Park Assist – Troubleshooting.....	219
---	-----

Active Park Assist – Frequently Asked Questions.....	219
--	-----

Active Park Assist – Information Messages.....	219
--	-----

Adaptive Cruise Control.....	221
------------------------------	-----

Adaptive Cruise Control – Troubleshooting.....	232
--	-----

Intelligent Adaptive Cruise Control.....	231
--	-----

Lane Centering.....	228
---------------------	-----

Adaptive Cruise Control Automatic Cancellation.....	224
---	-----

Adaptive Cruise Control Indicators.....	228
---	-----

Adaptive Cruise Control Limitations.....	221
--	-----

Adaptive Cruise Control Precautions.....	221
--	-----

Adaptive Cruise Control – Troubleshooting.....	232
--	-----

Adaptive Cruise Control – Information Messages.....	232
---	-----

Adjusting the Exterior Mirrors.....	117
-------------------------------------	-----

Adjusting the Headlamps.....	309
------------------------------	-----

Adjusting the Instrument Panel Lighting Brightness.....	113
---	-----

Adjusting the Luggage Compartment Load Floor.....	279
---	-----

Adjusting the Map.....	385
------------------------	-----

Changing the Format of the Map.....	385
-------------------------------------	-----

Zooming the Map In and Out.....	385
---------------------------------	-----

Adjusting the Seatbelt Height.....	48
------------------------------------	----

Adjusting the Seatbelts During Pregnancy.....	48
---	----

Adjusting the Sound Settings.....	359
-----------------------------------	-----

Adjusting the Steering Wheel.....	100
-----------------------------------	-----

Adjusting the Volume.....	358
---------------------------	-----

Aid Mode.....	246
---------------	-----

How Does Aid Mode Work.....	246
-----------------------------	-----

What Is Aid Mode.....	246
-----------------------	-----

Airbag Precautions.....	55
-------------------------	----

Airbags.....	53
--------------	----

Front Passenger Sensing System.....	57
-------------------------------------	----

Air Conditioning	
------------------	--

See: Climate Control.....	128
---------------------------	-----

Air Conditioning System Capacity and Specification.....	347
---	-----

# Index

Alert and Aid Mode.....	246	Digital Radio.....	360
How Does Alert and Aid Mode Work.....	247	Satellite Radio.....	361
What Is Alert and Aid Mode.....	246	Audio System Precautions.....	358
Alert Mode.....	246	Audio System – Troubleshooting.....	364
How Does Alert Mode Work.....	246	Audio System – Information	
What Is Alert Mode.....	246	Messages.....	364
All-Wheel Drive.....	185	Auto-Dimming Interior Mirror.....	116
All-Wheel Drive – Troubleshooting.....	185	Auto-Dimming Interior Mirror	
All-Wheel Drive Limitations.....	185	Limitations.....	116
All-Wheel Drive Precautions.....	185	What Is the Auto-Dimming Interior	
All-Wheel Drive – Troubleshooting.....	185	Mirror.....	116
All-Wheel Drive – Information		Auto Hold.....	197
Messages.....	185	Auto Hold Indicators.....	197
AM/FM Radio.....	360	Autolamps.....	107
AM/FM Radio Limitations.....	360	Autolamp Settings.....	107
Selecting a Radio Station.....	360	What Are Autolamps.....	107
Ambient Lighting.....	113	Autolock.....	77
Adjusting Ambient Lighting.....	113	Autolock Requirements.....	77
Switching Ambient Lighting On and		What Is Autolock.....	77
Off.....	113	Automatically Releasing the Electric	
Anti-Lock Braking System.....	186	Parking Brake.....	189
Anti-Lock Braking System		Automatic Crash Shutoff.....	290
Limitations.....	186	Re-Enabling Your Vehicle.....	290
Anti-Theft Alarm System.....	96	What Is Automatic Crash Shutoff.....	290
Arming the Anti-Theft Alarm System.....	96	Automatic Emergency Braking.....	263
Disarming the Anti-Theft Alarm		Switching Automatic Emergency Braking	
System.....	97	On and Off.....	263
How Does the Anti-Theft Alarm System		What Is Automatic Emergency	
Work.....	96	Braking.....	263
What Are the Inclination Sensors.....	96	Automatic High Beam Control.....	109
What Are the Interior Sensors.....	96	Automatic High Beam Control	
What Is the Anti-Theft Alarm System.....	96	Indicators.....	110
Anti-Theft Alarm System Settings.....	97	Automatic High Beam Control	
Setting the Alarm Security Level.....	97	Limitations.....	110
Switching Ask on Exit On and Off.....	97	Automatic High Beam Control	
What Are the Alarm Security Levels.....	97	Precautions.....	109
What Is Ask on Exit.....	97	Automatic High Beam Control	
Appendices.....	451	Requirements.....	110
Applying the Electric Parking		How Does Automatic High Beam Control	
Brake.....	189	Work.....	109
Applying the Electric Parking Brake in an		Overriding Automatic High Beam	
Emergency.....	189	Control.....	110
App Precautions.....	379	Switching Automatic High Beam Control	
App Requirements.....	379	On and Off.....	110
Apps.....	379	Automatic High Beam Control –	
Audio System.....	358	Troubleshooting.....	111
AM/FM Radio.....	360	Automatic High Beam Control –	
Audio System – Troubleshooting.....	364	Information Messages.....	111

# Index

Automatic Locking Mode.....	47	Beginning a Voice Interaction.....	371
Disengaging Automatic Locking Mode.....	47	Blind Spot Assist.....	247
Engaging Automatic Locking Mode.....	47	Blind Spot Assist Indicators.....	248
What Is Automatic Locking Mode.....	47	Blind Spot Assist Limitations.....	248
When to Use Automatic Locking Mode.....	47	How Does Blind Spot Assist Work.....	248
Automatic Return to Park (P).....	184	What Is Blind Spot Assist.....	247
Automatic Return to Park (P) Limitations.....	184	Blind Spot Information System.....	252
How Does Automatic Return to Park (P) Work.....	184	Blind Spot Information System – Troubleshooting.....	254
What Is Automatic Return to Park (P).....	184	Blind Spot Information System Indicators.....	253
Automatic Transmission.....	182	Blind Spot Information System Limitations.....	252
Automatic Return to Park (P).....	184	Blind Spot Information System Precautions.....	252
Automatic Transmission Positions.....	182	Blind Spot Information System Requirements.....	252
Temporary Neutral Mode.....	183	Blind Spot Information System – Troubleshooting.....	254
Automatic Transmission Fluid Check.....	308	Blind Spot Information System – Information Messages.....	254
Automatic Transmission Positions.....	182	BlueCruise Alerts.....	238
Drive (D).....	182	BlueCruise Automatic Cancellation.....	238
Low (L).....	183	BlueCruise.....	235
Neutral (N).....	182	BlueCruise – Troubleshooting.....	239
Park (P).....	182	BlueCruise Indicators.....	238
Reverse (R).....	182	BlueCruise Limitations.....	236
Automatic Transmission Precautions.....	182	BlueCruise Precautions.....	235
Auto Mode.....	130	BlueCruise Requirements.....	236
Auto Mode Indicators.....	130	BlueCruise Settings.....	237
Switching Auto Mode On and Off.....	130	BlueCruise – Troubleshooting.....	239
Autounlock.....	77	BlueCruise – Information Messages.....	239
Autounlock Requirements.....	77	Bluetooth®.....	378
What Is Autounlock.....	77	Body Control Module Fuse Box.....	301
Autowipers.....	101	Accessing the Body Control Module Fuse Box.....	301
Adjusting the Sensitivity of the Rain Sensor.....	102	Identifying the Fuses in the Body Control Module Fuse Box.....	302
Autowipers Settings.....	101	Locating the Body Control Module Fuse Box.....	301
What Are Autowipers.....	101	Body Styling Kit Precautions.....	316
AWD		Body Styling Kits.....	316
See: All-Wheel Drive.....	185	Bonnet Lock See: Opening and Closing the Hood.....	305
<b>B</b>		Booster Seats.....	42
Battery Fuse Box.....	299	Brake Fluid Specification.....	187
Accessing the Battery Fuse Box.....	299	Brake Over Accelerator.....	186
Identifying the Fuses in the Battery Fuse Box.....	300		
Locating the Battery Fuse Box.....	299		

# Index

Brake Precautions.....	186	Checking the Tire Pressures.....	331
Brakes.....	186	Checking the Wiper Blades.....	103
Anti-Lock Braking System.....	186	Children and Airbags.....	56
Brakes – Troubleshooting.....	187	Child Restraint Anchor Points.....	35
Brakes – Troubleshooting.....	187	Locating the Child Restraint Lower Anchor Points.....	35
Brakes – Frequently Asked Questions.....	187	Locating the Child Restraint Top Tether Anchor Points.....	36
Brakes – Warning Lamps.....	187	What Are the Child Restraint Anchor Points.....	35
Breaking-In.....	281	Child Restraints.....	36
<b>C</b>		Child Restraint Position Information.....	36
Calculating Payload.....	273	Child Restraints Recommendation.....	37
Calculating the Load Limit.....	274	Child Safety.....	34
Canceling the Set Speed.....	226	Child Restraint Anchor Points.....	35
Capacities and Specifications.....	346	Child Restraints.....	36
Center Display Limitations.....	368	Installing Child Restraints.....	37
Center Display Overview.....	368	Child Safety Locks.....	44
Center Display Precautions.....	368	Child Safety Precautions.....	34
Center Display Settings.....	370	Cleaning Products.....	311
Changing a Road Wheel.....	345	Cleaning the Exterior.....	312
Changing the Remote Control Battery.....	66	Cleaning Camera Lenses and Sensors.....	313
Changing the Vehicle Wi-Fi Hotspot Name or Password.....	356	Cleaning Chrome, Aluminium or Stainless Steel.....	312
Charge Port Indicators.....	168	Cleaning Headlamps and Rear Lamps.....	312
Charging a Device.....	151	Cleaning Stripes or Graphics.....	313
Charging a Wireless Device.....	153	Cleaning the Exterior Precautions.....	312
Charging Equipment.....	159	Cleaning the Underbody.....	313
Charging Your Vehicle.....	159	Cleaning Wheels.....	312
AC Charging.....	169	Cleaning Windows and Wiper Blades.....	312
Charging Your Vehicle – Troubleshooting.....	180	Cleaning the Interior.....	313
DC Charging.....	172	Cleaning Carpets and Floor Mats.....	314
Charging Your Vehicle Hints.....	180	Cleaning Displays and Screens.....	314
Charging Your Vehicle Precautions.....	159	Cleaning Plastic.....	314
Charging Your Vehicle – Troubleshooting.....	180	Cleaning Seatbelts.....	315
Charging Your Vehicle – Frequently Asked Questions.....	181	Cleaning Seats and the Headliner.....	314
Charging Your Vehicle – Information Messages.....	180	Cleaning Storage Compartments.....	315
Charging Your Vehicle – Warning Lamps.....	180	Cleaning the Instrument Panel.....	313
Checking MyKey System Status.....	74	Clearing All MyKeys.....	73
Checking the Brake Fluid.....	186	Clearing the Garage Door Opener.....	148
Checking the Coolant.....	306	Climate Control.....	128
Checking the Seatbelts.....	50	Auto Mode.....	130
		Climate Control Hints.....	131
		Closing the Liftgate.....	89
		Closing the Hands-Free Liftgate.....	90

# Index

Closing the Liftgate From Inside Your Vehicle.....	89
Closing the Liftgate From Outside Your Vehicle.....	89
Closing the Liftgate Using the Remote Control.....	90
Cold Weather Precautions.....	281
Connected Vehicle.....	352
Connected Vehicle – Troubleshooting.....	353
Connecting the Vehicle to a Mobile Network.....	352
Connected Vehicle Data.....	23
Connected Vehicle Limitations.....	352
Connected Vehicle Requirements.....	352
Connected Vehicle – Troubleshooting.....	353
Connected Vehicle – Frequently Asked Questions.....	353
Connecting a Bluetooth® Device.....	378
Connecting the Vehicle to a Mobile Network.....	352
Connecting FordPass to the Modem.....	352
Enabling and Disabling the Modem.....	352
What Is the Modem.....	352
Connecting the Vehicle to a Wi-Fi Network.....	352
Connecting Your Phone.....	374
Contacting Us.....	15
Cooling System Capacity and Specification.....	346
Crash and Breakdown Information.....	286
Automatic Crash Shutoff.....	290
Jump Starting the Vehicle.....	287
Post-Crash Alert System.....	289
Post Impact Braking.....	289
Crash Sensors and Airbag Indicator.....	60
Creating a MyKey.....	73
Creating a Personal Profile.....	383
Creating a Vehicle Wi-Fi Hotspot.....	356
Cross Traffic Alert.....	255
Cross Traffic Alert – Troubleshooting.....	257
Cross Traffic Alert Indicators.....	256
Cross Traffic Alert Limitations.....	255
Cross Traffic Alert Precautions.....	255
Cross Traffic Alert – Troubleshooting.....	257
Cross Traffic Alert – Information Messages.....	257
Cup Holders.....	154
Cup Holder Precautions.....	154
Customer Information.....	396
Radio Frequency Certification Labels.....	399
<b>D</b>	
Data Privacy.....	21
DC Charging.....	172
Connecting the Charger.....	172
Stopping Charging.....	173
Declaration of Conformity.....	399
Department of Transportation Uniform Tire Quality Grades.....	319
Digital Radio.....	360
Digital Radio Indicators.....	361
Digital Radio Limitations.....	361
How Does Digital Radio Work.....	360
Switching Digital Radio Reception On and Off.....	361
What Is Digital Radio.....	360
Directing the Flow of Air.....	130
Disposing of Airbags.....	61
Distance Alert.....	262
Adjusting the Sensitivity of Distance Alert.....	262
What Is Distance Alert.....	262
Distance Indication.....	261
Distance Indication Indicator.....	262
Switching Distance Indication On and Off.....	262
What Is Distance Indication.....	261
Doors and Locks Audible Warnings.....	77
Doors and Locks.....	76
Autolock.....	77
Autounlock.....	77
Doors and Locks – Troubleshooting.....	78
Mislock.....	77
Operating the Doors From Inside Your Vehicle.....	76
Operating the Doors From Outside Your Vehicle.....	76

# Index

Doors and Locks – Troubleshooting.....	78
Doors and Locks – Frequently Asked Questions.....	79
Doors and Locks – Information Messages.....	78
Doors and Locks – Warning Lamps.....	78
Drive Mode Control.....	241
Drive Modes.....	241
Drive Modes.....	241
Engage.....	241
Unbridled.....	241
Whisper.....	242
Driver Alert.....	266
Driver Alert – Troubleshooting.....	267
Driver Alert Indicators.....	267
Driver Alert Limitations.....	266
Driver Alert Precautions.....	266
Driver Alert – Troubleshooting.....	267
Driver Alert – Information Messages.....	267
Driving Hints.....	281
Driving in Special Conditions.....	281
Electric Vehicle.....	283
Driving in Special Conditions.....	281
Driving In Sand.....	282
Driving on Hilly or Sloping Terrain.....	282
Driving Through Mud and Water.....	282
Emergency Maneuvers.....	281
Driving on Snow and Ice.....	281
Driving Through Shallow Water.....	284
<b>E</b>	
Easy Entry and Exit.....	86
Electric Parking Brake Audible Warning.....	190
Electric Parking Brake.....	189
Electric Parking Brake – Troubleshooting.....	190
Electric Parking Brake – Troubleshooting.....	190
Electric Parking Brake – Information Messages.....	191
Electric Parking Brake – Warning Lamps.....	190
Electric Power Steering.....	204
Electric Power Steering Adaptive Steering.....	204
Electric Power Steering Precautions.....	204
Electric Vehicle.....	283
Driving in Cold Weather.....	283
Maximizing Your Driving Range.....	283
Electromagnetic Compatibility.....	451
Emergency Call Limitations.....	64
Emergency Call Requirements.....	63
Emergency Call System Data.....	24
Emergency Towing.....	292
Enabling Apps on an Android Device.....	380
Enabling Apps on an iOS Device.....	380
Enabling or Disabling Personal Profiles.....	382
Enabling Remote Start.....	126
End User License Agreement.....	425
Entering a Parallel Parking Space.....	217
Entering a Perpendicular Parking Space.....	218
Evasive Steering Assist.....	263
Evasive Steering Assist Limitations.....	263
Switching Evasive Steering Assist On and Off.....	264
What Is Evasive Steering Assist.....	263
Event Data.....	22
Exiting a Parking Space.....	218
Export Unique Options.....	450
Extending the Remote Start Duration.....	126
Exterior Bulbs.....	310
Exterior Bulb Specification Chart.....	310
Exterior Lamps.....	108
Exterior Lamp Audible Warning.....	109
Exterior Lamp Indicators.....	109
Switching the Daytime Running Lamps On and Off.....	108
Switching the Turn Signal Lamps On and Off.....	108
Switching Welcome Lighting On and Off.....	108
Exterior Lighting Control.....	106
Exterior Lighting.....	106
Autolamps.....	107
Automatic High Beam Control.....	109
Automatic High Beam Control – Troubleshooting.....	111
Exterior Lamps.....	108
Headlamps.....	106
Headlamps – Troubleshooting.....	107



# Index

Exterior Mirrors.....	117	Garage Door Opener Limitations.....	146
<b>F</b>		Garage Door Opener Precautions.....	146
Fastening and Unfastening the Seatbelts.....	46	Garage Door Opener Radio Frequencies.....	149
Federal Highway Administration Regulation.....	424	General Maintenance Information.....	392
Floor Mats.....	284	Glasses Holder.....	154
Folding the Exterior Mirrors - Vehicles With: Manual Folding Mirrors.....	117	Locating the Glasses Holder.....	154
Folding the Exterior Mirrors - Vehicles With: Power Folding Mirrors.....	118	Global Opening and Closing.....	114
Ford Protect.....	390	Switching Global Closing On and Off.....	115
Front Exterior.....	30	Switching Global Opening On and Off.....	115
Front Exterior - GT.....	31	Using Global Closing.....	115
Front Parking Aid.....	207	Using Global Opening.....	114
Front Parking Aid Audible Warnings.....	208	What Is Global Opening and Closing.....	114
Front Parking Aid Limitations.....	208	Glossary of Tire Terminology.....	325
Locating the Front Parking Aid Sensors.....	208	Glove Compartment.....	154
What is the Front Parking Aid.....	207	Opening the Glove Compartment.....	154
Front Passenger Sensing System.....	57	<b>H</b>	
Front Passenger Sensing System Indicators.....	59	Headlamp Adjusting See: Adjusting the Headlamps.....	309
Front Passenger Sensing System Precautions.....	59	Headlamps.....	106
How Does the Front Passenger Sensing System Work.....	57	Headlamp Indicators.....	106
What Is the Front Passenger Sensing System.....	57	Switching Headlamp Exit Delay On and Off.....	106
Front Seat Precautions.....	134	Using the High Beam Headlamps.....	106
Front Seats.....	134	Headlamps – Troubleshooting.....	107
Heated Seats.....	140	Headlamps – Frequently Asked Questions.....	107
Manual Seats.....	135	Heated Seats.....	140
Power Seats.....	137	Heated Seat Precautions.....	140
Fuse Precautions.....	294	Switching the Heated Seats On and Off.....	140
Fuses.....	294	Heating See: Climate Control.....	128
Battery Fuse Box.....	299	High Voltage Battery Gauge.....	120
Body Control Module Fuse Box.....	301	High Voltage Battery.....	157
Fuses – Troubleshooting.....	304	High Voltage Battery – Troubleshooting.....	158
Under Hood Fuse Box.....	294	High Voltage Battery Precautions.....	157
Fuses – Troubleshooting.....	304	High Voltage Battery – Troubleshooting.....	158
Fuses – Frequently Asked Questions.....	304	High Voltage Battery – Warning Lamps.....	158
<b>G</b>		Hill Start Assist.....	196
Garage Door Opener.....	146	Hill Start Assist Precautions.....	196
		Hood Lock See: Opening and Closing the Hood.....	305

# Index

Horn.....	100	Information on the Tire Sidewall.....	320
How Does 911 Assist Work.....	63	Inspecting the Tire for Damage.....	332
How Does Active Park Assist Work.....	217	Inspecting the Tire for Wear.....	332
How Does Adaptive Cruise Control With Stop and Go Work.....	221	Inspecting the Wheel Valve Stems.....	333
How Does All-Wheel Drive Work.....	185	Installing and Removing the Luggage Compartment Cover.....	278
How Does Auto Hold Work.....	197	Installing Child Restraints.....	37
How Does Blind Spot Information System Work.....	252	Combining the Seatbelt and Lower Anchors for Attaching Child Restraints.....	41
How Does BlueCruise Work.....	235	Installing a Child Restraint in a Center Seat.....	40
How Does Cross Traffic Alert Work.....	255	Using Lower Anchors and Tethers for Children.....	39
How Does Driver Alert Work.....	266	Using Seatbelts.....	37
How Does Easy Entry and Exit Work.....	86	Using Tether Straps.....	41
How Does Hill Start Assist Work.....	196	Installing the Vehicle Identification Card.....	350
How Does Pre-Collision Assist Work.....	258	Instrument Cluster Display.....	124
How Does Reverse Braking Assist Work.....	192	Instrument Cluster Indicators.....	122
How Does Speed Sign Recognition Work.....	268	Instrument Cluster.....	119
How Does Stability Control Work.....	200	Instrument Cluster Overview.....	119
How Does the 360 Degree Camera Work.....	214	Instrument Cluster Warning Lamps.....	121
How Does the Garage Door Opener Work.....	146	Instrument Panel - GT.....	27
How Does the Lane Keeping System Work.....	244	Instrument Panel.....	26
How Does the Personal Safety System Work.....	52	Intelligent Adaptive Cruise Control.....	231
How Does the Rear Occupant Alert System Work.....	143	Adjusting the Set Speed Tolerance.....	232
How Does the Safety Canopy™ Work.....	54	How Does Intelligent Adaptive Cruise Control Work.....	231
How Does Traction Control Work.....	198	Intelligent Adaptive Cruise Control Alerts.....	232
How Does Walk Away Lock Work.....	85	Intelligent Adaptive Cruise Control Indicators.....	232
How Do Personal Profiles Work.....	382	Intelligent Adaptive Cruise Control Limitations.....	231
How Do the Front Airbags Work.....	53	Intelligent Adaptive Cruise Control Precautions.....	231
How Do the Knee Airbags Work.....	54	Intelligent Adaptive Cruise Control Requirements.....	231
How Do the Side Airbags Work.....	53	Switching Intelligent Mode On and Off.....	231
Identifying Fuse Types.....	304	Interior Air Quality.....	133
Identifying the Climate Control Unit.....	128	Interior Bulbs.....	310
Inflating the Tires.....	331	Interior Bulb Specification Chart.....	310
		Interior Lamp Function.....	112
		Switching the Interior Lamp Function On and Off.....	112
		What Is the Interior Lamp Function.....	112

# Index

Interior Lighting.....	112
Ambient Lighting.....	113
Interior Lamp Function.....	112
Interior Lighting – Troubleshooting.....	113
Interior Lighting – Troubleshooting.....	113
Interior Lighting – Frequently Asked Questions.....	113
Interior Mirror.....	116
Auto-Dimming Interior Mirror.....	116
Interior Mirror Precautions.....	116
Introduction.....	17

## J

Jump Starting the Vehicle.....	287
Jump Starting Precautions.....	287
Jump Starting the Vehicle.....	289
Preparing the Vehicle.....	287

## K

Keyless Entry.....	80
Keyless Entry – Troubleshooting.....	81
Keyless Entry Keypad.....	82
Keyless Entry Keypad – Troubleshooting.....	84
Keyless Entry Keypad Limitations.....	82
Keyless Entry Keypad Master Access Code.....	82
Keyless Entry Keypad Personal Access Codes.....	82
Keyless Entry Keypad – Troubleshooting.....	84
Keyless Entry Keypad – Frequently Asked Questions.....	84
Keyless Entry Limitations.....	80
Keyless Entry Settings.....	80
Keyless Entry – Troubleshooting.....	81
Keyless Entry – Frequently Asked Questions.....	81
Keys and Remote Controls.....	65
Keys and Remote Controls – Troubleshooting.....	68
Keys and Remote Controls – Troubleshooting.....	68
Keys and Remote Controls – Information Messages.....	68

## L

Lane Centering.....	228
How Does Lane Centering Work.....	228
Lane Centering Alerts.....	230
Lane Centering Automatic Cancellation.....	230
Lane Centering Indicators.....	230
Lane Centering Limitations.....	229
Lane Centering Precautions.....	229
Lane Centering Requirements.....	229
Switching Lane Centering On and Off.....	230
Lane Keeping System Indicators.....	247
Lane Keeping System.....	244
Aid Mode.....	246
Alert and Aid Mode.....	246
Alert Mode.....	246
Blind Spot Assist.....	247
Lane Keeping System – Troubleshooting.....	249
Lane Keeping System Limitations.....	244
Lane Keeping System Precautions.....	244
Lane Keeping System Settings.....	245
Lane Keeping System – Troubleshooting.....	249
Lane Keeping System – Frequently Asked Questions.....	250
Lane Keeping System – Information Messages.....	249
Liftgate.....	87
Closing the Liftgate.....	89
Liftgate – Troubleshooting.....	91
Opening the Liftgate.....	87
Liftgate Obstacle Detection.....	91
Liftgate Precautions.....	87
Liftgate – Troubleshooting.....	91
Liftgate – Frequently Asked Questions.....	93
Liftgate – Information Messages.....	92
Liftgate – Warning Lamps.....	91
Linking or Unlinking a Personal Profile to a Device.....	383
Linking or Unlinking a Personal Profile to a Remote Control.....	383
Live Traffic.....	385
Switching Live Traffic On and Off.....	385

# Index

What Is Live Traffic.....	385
Load Carrying.....	271
Load Carrying Precautions.....	271
Locating the 360 Degree Cameras.....	214
Locating the Blind Spot Information System Sensors.....	253
Locating the Brake Fluid Reservoir.....	186
Locating the Charge Port.....	168
Locating the Cross Traffic Alert Sensors.....	256
Locating the Keyless Entry Keypad.....	82
Locating the Memory Function Buttons.....	145
Locating the Power Outlets.....	152
Locating the Pre-Collision Assist Sensors.....	260
Locating the Rear View Camera.....	211
Locating the Safety Compliance Certification Labels.....	272
Locating the Tire label.....	319
Locating the Tire Sealant and Inflator Kit.....	335
Locating the USB Ports.....	150
Locating the Wireless Accessory Charger.....	153
Locating Your Vehicle.....	66
Locking the Rear Window Controls.....	115
Luggage Compartment Anchor Points.....	279
Locating the Luggage Compartment Anchor Points.....	279
Luggage Compartment.....	276
Luggage Compartment Anchor Points.....	279
Luggage Compartment Precautions.....	276

## M

Maintenance.....	305
12V Battery.....	308
12V Battery – Troubleshooting.....	308
Exterior Bulbs.....	310
Interior Bulbs.....	310
Maintenance Precautions.....	305
Making and Receiving a Phone Call.....	375

Manually Releasing the Electric Parking Brake.....	189
Manual Seats.....	135
Adjusting the Head Restraint.....	135
Adjusting the Seat Backrest.....	136
Adjusting the Seat Height.....	137
Folding the Seat Backrest.....	142
Head Restraint Components.....	135
Installing the Head Restraint.....	136
Moving the Seat Backward and Forward.....	136
Removing the Head Restraint.....	136
Unfolding the Seat Backrest.....	142
Memory Function.....	145
Memory Function Precautions.....	145
Mislock.....	77
Mislock Limitations.....	77
Switching Mislock On and Off.....	77
What Is Mislock.....	77
Mobile Communications Equipment.....	424
Mobile Device Data.....	24
Motorcraft Parts.....	346
Muting the Audio.....	359
MyKey Settings.....	72
Configurable MyKey Settings.....	72
Non-Configurable MyKey Settings.....	72
MyKey – Troubleshooting.....	74
MyKey – Frequently Asked Questions.....	75
MyKey – Information Messages.....	74
MyKey™.....	72
MyKey Settings.....	72
MyKey – Troubleshooting.....	74

## N

Navigation Map Updates.....	385
Navigation.....	385
Adjusting the Map.....	385
Live Traffic.....	385
Route Guidance.....	386
Setting a Destination.....	385
Waypoints.....	386
Normal Scheduled Maintenance.....	394

## O

One Pedal Drive Indicators.....	243
---------------------------------	-----

# Index

One Pedal Drive Limitations.....	243
One Pedal Drive.....	243
One Pedal Drive Precautions.....	243
Opening and Closing the Front Luggage Compartment.....	276
Opening and Closing the Hood.....	305
Opening and Closing the Windows.....	114
Opening the Liftgate.....	87
Opening the Hands-Free Liftgate.....	88
Opening the Liftgate From Inside Your Vehicle.....	87
Opening the Liftgate From Outside Your Vehicle.....	87
Opening the Liftgate Using the Remote Control.....	88
Operating the Doors From Inside Your Vehicle.....	76
Individually Unlocking and Locking the Doors Using the Locking Button.....	76
Opening the Doors From Inside Your Vehicle.....	77
Unlocking and Locking the Doors Using the Central Locking.....	76
Operating the Doors From Outside Your Vehicle.....	76
Opening and Closing the Doors.....	76
Unlocking and Locking the Doors Using the Remote Control.....	76
Ordering a Canadian French Owner's Manual.....	397
Overriding Reverse Braking Assist.....	193
Overriding the Set Speed.....	228
<b>P</b>	
Parking Aid Indicators.....	210
Parking Aid Precautions.....	206
Parking Aids.....	206
Front Parking Aid.....	207
Parking Aids – Troubleshooting.....	210
Rear Parking Aid.....	207
Side Parking Aid.....	208
Parking Aids – Troubleshooting.....	210
Parking Aids – Information Messages.....	210
Passive Anti-Theft System.....	96
How Does the Passive Anti-Theft System Work.....	96
What Is the Passive Anti-Theft System.....	96
Pedestrian Alert System.....	62
Perchlorate.....	423
Performance Vehicle Precautions.....	281
Performing a Master Reset.....	388
Personal Profile Settings.....	383
Personal Profiles.....	382
Personal Safety System Components.....	52
Personal Safety System™.....	52
Phone as a Key Limitations.....	69
Phone as a Key.....	69
Phone as a Key – Troubleshooting.....	70
Phone as a Key – Troubleshooting.....	70
Phone as a Key – Frequently Asked Questions.....	70
Phone Menu.....	374
Phone.....	374
Phone Precautions.....	374
Playing Media Using Bluetooth®.....	378
Playing Media Using the USB Port.....	150
Playing or Pausing the Audio Source.....	358
Post-Crash Alert System.....	289
How Does the Post-Crash Alert System Work.....	289
Post-Crash Alert System Limitations.....	289
Switching the Post-Crash Alert System Off.....	289
What Is the Post-Crash Alert System.....	289
Post Impact Braking.....	289
How Does Post Impact Braking Work.....	289
Overriding Post Impact Braking.....	289
Post Impact Braking Indicators.....	290
Post Impact Braking Limitations.....	289
Powering Off.....	155
Power Outlet.....	152
Power Outlet Precautions.....	152
Power Seats.....	137
Adjusting the Head Restraint.....	137
Adjusting the Lumbar Support.....	139
Adjusting the Seat Backrest.....	139
Adjusting the Seat Height.....	139
Head Restraint Components.....	137

# Index

Installing the Head Restraint.....	139
Moving the Seat Backward and Forward.....	139
Removing the Head Restraint.....	138
Pre-Collision Assist Limitations.....	259
Pre-Collision Assist Precautions.....	258
Pre-Collision Assist.....	258
Automatic Emergency Braking.....	263
Distance Alert.....	262
Distance Indication.....	261
Evasive Steering Assist.....	263
Pre-Collision Assist – Troubleshooting.....	264
Pre-Collision Assist – Troubleshooting.....	264
Pre-Collision Assist – Frequently Asked Questions.....	265
Pre-Collision Assist – Information Messages.....	264
Pre-Collision Assist – Warning Lamps.....	264
Preparing Your Vehicle for Storage.....	317
Preserving Your High Voltage Battery.....	157
Programming a MyKey.....	73
Programming the Garage Door Opener to Your Garage Door Opener Motor.....	147
Programming the Garage Door Opener to Your Gate Opener Motor.....	148
Programming the Garage Door Opener to Your Hand-Held Transmitter.....	147
Programming the Remote Control.....	68
Programming Your Phone.....	69
Properly Adjusting the Driver and Front Passenger Seats.....	56
<b>R</b>	
Radio Frequency Certification Labels.....	399
Blind Spot Information System Sensors.....	399
Cruise Control Module.....	405
Garage Door Opener.....	408
Remote Function Actuator.....	405
SYNC.....	408
Telematics Control Unit.....	413
Tire Pressure Monitoring System Sensors.....	414
Wireless Accessory Charging Module.....	419
Rear Exterior - GT.....	33
Rear Exterior.....	32
Rear Occupant Alert System Audible Warnings.....	144
Rear Occupant Alert System Indicators.....	144
Rear Occupant Alert System Limitations.....	143
Rear Occupant Alert System Precautions.....	143
Rear Occupant Alert System.....	143
Rear Parking Aid.....	207
Locating the Rear Parking Aid Sensors.....	207
Rear Parking Aid Audible Warnings.....	207
Rear Parking Aid Limitations.....	207
What is the Rear Parking Aid.....	207
Rear Seats.....	141
Manual Seats.....	141
Rear View Camera Guide Lines.....	211
Rear View Camera Object Distance Indicators.....	212
Rear View Camera Precautions.....	211
Rear View Camera.....	211
Rear View Camera Settings.....	212
Rear View Camera Settings.....	212
Switching Rear View Camera Delay On and Off.....	212
Zooming the Rear View Camera In and Out.....	212
Recalling a Preset Position.....	145
Recreationally Towing Your Vehicle.....	292
Recycling and Disposing of the High Voltage Battery.....	158
Releasing the Electric Parking Brake if the Vehicle Battery Has Run Out of Charge.....	190
Remote Control Limitations.....	65
Remotely Starting and Stopping the Vehicle.....	126
Remote Start Limitations.....	126
Remote Start.....	126
Remote Start Settings.....	127

# Index

Remote Start Settings.....	127
Setting the Remote Start Duration.....	127
Switching Climate Control Auto Mode On and Off.....	127
Switching Climate Control Last Settings On and Off.....	127
Switching the Heated Seat Settings On and Off.....	127
Switching the Heated Steering Wheel Settings On and Off.....	127
Removing Your Vehicle From Storage.....	318
Repairing Minor Paint Damage.....	315
Replacement Parts Recommendation.....	423
Replacing a Lost Key or Remote Control.....	68
Replacing the Cabin Air Filter.....	133
Replacing the Front Wiper Blades.....	103
Replacing the Rear Wiper Blades.....	103
Reporting Safety Defects in Canada.....	398
Reporting Safety Defects in the United States.....	398
Reprogramming the Garage Door Opener.....	149
Resetting the Trip Computer.....	125
Restarting the Vehicle After Powering Off.....	155
Resuming the Set Speed.....	226
Reverse Braking Assist Indicators.....	193
Reverse Braking Assist Precautions.....	192
Reverse Braking Assist.....	192
Reverse Braking Assist – Troubleshooting.....	194
Reverse Braking Assist – Troubleshooting.....	194
Reverse Braking Assist – Frequently Asked Questions.....	195
Reverse Braking Assist – Information Messages.....	194
Reverse Wipe.....	102
Reverse Wipe Settings.....	102
What Is Reverse Wipe.....	102
Roadside Assistance.....	286
Rollover Warning.....	396
Route Guidance.....	386
Adjusting the Guidance Prompt Volume.....	386
Canceling Route Guidance.....	386
Repeating an Instruction.....	386
Running-In See: Breaking-In.....	281
<b>S</b>	
Satellite Radio.....	361
Locating the Satellite Radio Identification Number.....	362
Satellite Radio Limitations.....	362
Satellite Radio Settings.....	362
Selecting a Channel.....	362
What Is Satellite Radio.....	361
Saving a Preset Position.....	145
Scheduled Maintenance.....	392
Seatbelt Extensions.....	51
Seatbelt Precautions.....	45
Seatbelt Reminder.....	48
How Does the Seatbelt Reminder Work.....	48
Seatbelt Reminder Audible Warnings.....	49
Seatbelt Reminder Indicators.....	48
Switching the Seatbelt Reminder On and Off.....	50
Seatbelts.....	45
Automatic Locking Mode.....	47
Seatbelt Reminder.....	48
Sensitive Locking Mode.....	47
Security.....	96
Anti-Theft Alarm System.....	96
Anti-Theft Alarm System Settings.....	97
Passive Anti-Theft System.....	96
Security – Troubleshooting.....	98
Security – Troubleshooting.....	98
Security – Frequently Asked Questions.....	99
Security – Information Messages.....	98
Selecting a Drive Mode.....	241
Selecting the Audio Source.....	358
Sending and Receiving a Text Message.....	376
Sensitive Locking Mode.....	47
How Does Sensitive Locking Mode Work.....	47

# Index

What is Sensitive Locking Mode.....	47
Service Data.....	22
Setting a Destination.....	385
Setting a Destination Using a Point of Interest.....	386
Setting a Destination Using a Predictive Destination.....	386
Setting a Destination Using a Recent Destination.....	386
Setting a Destination Using a Saved Destination.....	386
Setting a Destination Using the Map Screen.....	385
Setting a Destination Using the Text Entry Screen.....	385
Setting a Memory Preset.....	358
Settings Data.....	23
Setting the Adaptive Cruise Control Gap.....	225
Setting the Adaptive Cruise Control Speed.....	224
Setting the Blower Motor Speed.....	129
Setting the Charging Schedule and Preferences.....	174
Setting the Clock and Date.....	359
Setting the Liftgate Opening Height.....	89
Setting the Speed Sign Recognition Speed Tolerance.....	269
Setting the Speed Sign Recognition Speed Warning.....	269
Setting the Temperature.....	129
Setting the Wake Word.....	371
Shifting Your Vehicle Into Gear.....	183
Side Parking Aid.....	208
Locating the Side Parking Aid Sensors.....	209
Side Parking Aid Audible Warnings.....	209
Side Parking Aid Limitations.....	208
What is the Side Parking Aid.....	208
Sitting in the Correct Position.....	134
Sounding the Panic Alarm.....	65
Speedometer.....	119
Speed Sign Recognition Indicators.....	268
Speed Sign Recognition Limitations.....	268
Speed Sign Recognition Precautions.....	268
Speed Sign Recognition – Frequently Asked Questions.....	270
Speed Sign Recognition – Information Messages.....	269
Speed Sign Recognition – Troubleshooting.....	269
Stability Control Indicator.....	203
Stability Control.....	200
Starting and Powering Off Precautions.....	155
Starting and Powering Off.....	155
Starting and Powering Off – Troubleshooting.....	156
Starting and Powering Off – Frequently Asked Questions.....	156
Starting the Vehicle.....	155
Status Bar.....	368
Steering.....	204
Electric Power Steering.....	204
Steering – Troubleshooting.....	205
Steering – Troubleshooting.....	205
Steering – Information Messages.....	205
Steering Wheel.....	25
Stopping the Liftgate Movement.....	91
Storage.....	154
Cup Holders.....	154
Glasses Holder.....	154
Glove Compartment.....	154
Storing Your Vehicle.....	317
Switching Active Park Assist On and Off.....	217
Switching Adaptive Cruise Control On and Off.....	223
Switching Air Conditioning On and Off.....	128
Switching All of the Interior Lamps On and Off.....	112
Switching Android Auto On and Off.....	380
Switching Apple CarPlay On and Off.....	380



# Index

Switching Auto Hold On and Off.....	197
Switching Blind Spot Information System On and Off.....	252
Switching BlueCruise On and Off.....	237
Switching Climate Control On and Off.....	128
Switching Cross Traffic Alert On and Off.....	255
Switching Defrost On and Off.....	128
Switching Driver Alert On and Off.....	267
Switching Easy Entry and Exit On and Off.....	86
Switching From Adaptive Cruise Control to Cruise Control.....	228
Switching Maximum Cooling On and Off.....	129
Switching Maximum Defrost On and Off.....	129
Switching One Pedal Drive On and Off.....	243
Switching Parking Aid On and Off.....	206
Switching Pre-Collision Assist On and Off.....	260
Switching Rear Occupant Alert System On and Off.....	143
Switching Recirculated Air On and Off.....	128
Switching Repeat Mode On and Off.....	358
Switching Reverse Braking Assist On and Off.....	193
Switching Shuffle Mode On and Off.....	358
Switching Stability Control On and Off.....	201
Switching Text Message Notification On and Off.....	377
Switching the Audio Unit On and Off.....	358
Switching the Front Interior Lamps On and Off.....	112
Switching the Hazard Flashers On and Off.....	286
Switching the Heated Mirrors On and Off.....	129
Switching the Heated Rear Window On and Off.....	129
Switching the Heated Steering Wheel On and Off.....	100
Switching the Heated Wiper Park On and Off.....	129
Switching the Lane Keeping System Mode.....	245
Switching the Lane Keeping System On and Off.....	245
Switching the Rear Interior Lamps On and Off.....	112
Switching the Rear Window Wiper On and Off.....	102
Switching Traction Control On and Off.....	198
Switching Walk Away Lock Audible Feedback On and Off.....	85
Switching Walk Away Lock On and Off.....	85
Symbols Glossary.....	19
Symbols Used on Your Vehicle.....	19
<b>T</b>	
Technical Specifications	
See: Capacities and Specifications.....	346
Temporary Neutral Mode.....	183
Entering Temporary Neutral Mode.....	183
Exiting Temporary Neutral Mode.....	184
Temporary Neutral Mode Limitations.....	183
What Is Temporary Neutral Mode.....	183
The Better Business Bureau Auto Line Program.....	396
The Mediation and Arbitration Program.....	397
Tire Care.....	331
Tire Pressure Monitoring System Limitations.....	342
Tire Pressure Monitoring System Overview.....	341
Tire Pressure Monitoring System Precautions.....	342
Tire Pressure Monitoring System.....	341
Tire Pressure Monitoring System – Troubleshooting.....	343
Tire Pressure Monitoring System – Troubleshooting.....	343
Tire Pressure Monitoring System – Information Messages.....	344

# Index

Tire Pressure Monitoring System – Warning Lamps.....	343
Tire Replacement Requirements.....	326
Tire Rotation.....	333
Tire Sealant and Inflator Kit Components.....	335
Tire Sealant and Inflator Kit Precautions.....	335
Tire Sealant and Inflator Kit.....	335
Towing a Trailer Precautions.....	280
Towing a Trailer.....	280
Towing Your Vehicle Precautions.....	292
Towing Your Vehicle.....	292
Towing Your Vehicle – Troubleshooting.....	293
Towing Your Vehicle – Troubleshooting.....	293
Towing Your Vehicle – Information Messages.....	293
Traction Control Indicator.....	198
Traction Control.....	198
Traction Control – Troubleshooting.....	199
Traction Control – Troubleshooting.....	199
Traction Control – Information Messages.....	199
Traction Control – Warning Lamps.....	199
Transporting the Vehicle.....	290
Trip Computer.....	125
Trip Data.....	125
<b>U</b>	
Under Hood Fuse Box.....	294
Accessing the Under Hood Fuse Box.....	294
Identifying the Fuses in the Under Hood Fuse Box.....	295
Locating the Under Hood Fuse Box.....	294
Under Hood Overview.....	305
Updating the Vehicle Systems Wirelessly.....	387
USB Ports.....	150
Using Auto Hold.....	197
Using FordPass and Charging.....	179
Using Keyless Entry.....	80
Using MyKey With Remote Start Systems.....	74
Using Snow Chains.....	329
Using Summer Tires.....	328
Using the Backup Start Passcode.....	70
Using the Front Luggage Compartment Emergency Release.....	277
Using the Keyless Entry Keypad.....	83
Using the Remote Control.....	65
Using the Tire Sealant and Inflator Kit.....	336
Using the Valet Mode.....	70
Using This Publication.....	18
Using Winter Tires.....	329
<b>V</b>	
Vehicle Care.....	311
Cleaning the Exterior.....	312
Cleaning the Interior.....	313
General Information.....	311
Vehicle Identification Number.....	350
Locating the Vehicle Identification Number.....	350
Vehicle Identification Number Overview.....	350
Vehicle Identification.....	350
Vehicle Identification Number.....	350
Vehicle Interior - GT.....	29
Vehicle Interior.....	28
Vehicle Range Display.....	119
Vehicle System Updates.....	387
Vehicle Wi-Fi Hotspot.....	356
Ventilation See: Climate Control.....	128
Viewing the Tire Pressures.....	343
Visual Search.....	25
Voice Interaction Examples.....	371
Voice Interaction.....	371
<b>W</b>	
Walk Away Lock Limitations.....	85
Walk Away Lock.....	85
Washer Fluid Specification.....	348
Washers.....	104
Adding Washer Fluid.....	105
Switching the Courtesy Wipe On and Off.....	104
Using the Rear Window Washer.....	104
Using the Windshield Washer.....	104

# Index

Washer Fluid Specification.....	105
Washer Precautions.....	104
Washers	
See: Wipers and Washers.....	101
Waxing.....	313
Waypoints.....	386
Adding a Waypoint.....	386
Editing Waypoints.....	386
What Are the Instrument Cluster Indicators.....	122
What Are the Instrument Cluster Warning Lamps.....	120
What Is 911 Assist.....	63
What Is AC Charging.....	159
What Is a Connected Vehicle.....	352
What Is Active Park Assist.....	217
What Is Blind Spot Information System.....	252
What Is BlueCruise.....	235
What Is Brake Coach.....	124
What Is Cross Traffic Alert.....	255
What Is DC Charging.....	159
What Is Drive Mode Control.....	241
What Is Driver Alert.....	266
What Is Ford Protect.....	390
What Is Hill Start Assist.....	196
What Is MyKey.....	72
What Is One Pedal Drive.....	243
What Is Phone As a Key.....	69
What Is Pre-Collision Assist.....	258
What Is Remote Start.....	126
What Is Reverse Braking Assist.....	192
What Is Speed Sign Recognition.....	268
What Is the 360 Degree Camera.....	214
What Is the Cabin Air Filter.....	133
What Is the Electric Parking Brake.....	189
What Is the Garage Door Opener.....	146
What Is the Gross Axle Weight Rating.....	272
What Is the Gross Combined Weight Rating.....	273
What Is the Gross Vehicle Weight Rating.....	272
What Is the High Voltage Battery.....	157
What Is the Keyless Entry Keypad.....	82
What Is the Lane Keeping System.....	244
What Is the Maximum Loaded Trailer Weight.....	272
What Is the Memory Function.....	145
What Is the Pedestrian Alert System.....	62
What Is the Personal Safety System.....	52
What Is the Power Outlet.....	152
What Is the Rear Occupant Alert System.....	143
What Is the Rear View Camera.....	211
What Is the Tire Pressure Monitoring System.....	341
What Is the Tire Sealant and Inflator Kit.....	335
What Is the Wireless Accessory Charger.....	153
What Is Traction Control.....	198
What Is Voice Interaction.....	371
What Is Walk Away Lock.....	85
Wheel and Tire Information.....	319
Wheel Nuts.....	345
Wi-Fi	
See: Changing the Vehicle Wi-Fi Hotspot Name or Password.....	356
See: Connecting the Vehicle to a Wi-Fi Network.....	352
See: Creating a Vehicle Wi-Fi Hotspot.....	356
See: Vehicle Wi-Fi Hotspot.....	356
Window Bounce-Back.....	115
Overriding Window Bounce-Back.....	115
What Is Window Bounce-Back.....	115
Windows.....	114
Global Opening and Closing.....	114
Window Bounce-Back.....	115
Wipers and Washers – Troubleshooting.....	105
Wipers and Washers – Frequently Asked Questions.....	105
Wipers and Washers – Warning Lamps.....	105
Wipers and Washers.....	101
Autowipers.....	101
Reverse Wipe.....	102
Washers.....	104
Wipers.....	101
Wipers and Washers – Troubleshooting.....	105

# Index

---

Wipers.....	101
Switching Windshield Wipers On and Off.....	101
Wiper Precautions.....	101
Wireless Accessory Charger Precautions.....	153
Wireless Accessory Charger.....	153